



No.I22Z70098-SEM01



SAR TEST REPORT

No. I22Z70098-SEM01

For

Samsung Electronics Co., Ltd

Multi-band GSM/WCDMA/LTE phone with Bluetooth, WLAN

Model Name: SM-A045M/DS , SM-A045M

with

Hardware Version: REV1.0

Software Version: A045M.001

FCC ID: ZCASMA045M

Issued Date: 2022-06-30

Note:

The test results in this test report relate only to the devices specified in this report. This report shall not be reproduced except in full without the written approval of CTTL.

The report must not be used by the client to claim product certification, approval, or endorsement by NVLAP, NIST, or any agency of the U.S.Government.

Test Laboratory:

CTTL, Telecommunication Technology Labs, CAICT

No. 52, Huayuan North Road, Haidian District, Beijing, P. R. China 100191.

Tel:+86(0)10-62304633-2512, Fax:+86(0)10-62304633-2504

Email: ctl_terminals@caict.ac.cn, website: www.caict.ac.cn



REPORT HISTORY

Report Number	Revision	Issue Date	Description
I22Z70098-SEM01	Rev.0	2022-06-30	Initial creation of test report

TABLE OF CONTENT

1 TEST LABORATORY	5
1.1 TESTING LOCATION	5
1.2 TESTING ENVIRONMENT.....	5
1.3 PROJECT DATA	5
1.4 SIGNATURE.....	5
2 STATEMENT OF COMPLIANCE	6
3 CLIENT INFORMATION.....	8
3.1 APPLICANT INFORMATION	8
3.2 MANUFACTURER INFORMATION	8
4 EQUIPMENT UNDER TEST (EUT) AND ANCILLARY EQUIPMENT (AE)	9
4.1 ABOUT EUT.....	9
4.2 INTERNAL IDENTIFICATION OF EUT USED DURING THE TEST	10
4.3 INTERNAL IDENTIFICATION OF AE USED DURING THE TEST	10
5 TEST METHODOLOGY	11
5.1 APPLICABLE LIMIT REGULATIONS.....	11
5.2 APPLICABLE MEASUREMENT STANDARDS	11
6 SPECIFIC ABSORPTION RATE (SAR).....	12
6.1 INTRODUCTION.....	12
6.2 SAR DEFINITION.....	12
7 TISSUE SIMULATING LIQUIDS.....	13
7.1 TARGETS FOR TISSUE SIMULATING LIQUID.....	13
7.2 DIELECTRIC PERFORMANCE	13
8 SYSTEM VERIFICATION.....	17
8.1 SYSTEM SETUP.....	17
8.2 SYSTEM VERIFICATION.....	18
9 MEASUREMENT PROCEDURES	19
9.1 TESTS TO BE PERFORMED	19
9.2 GENERAL MEASUREMENT PROCEDURE.....	21
9.3 WCDMA MEASUREMENT PROCEDURES FOR SAR	22
9.4 SAR MEASUREMENT FOR LTE.....	23
9.5 BLUETOOTH & WI-FI MEASUREMENT PROCEDURES FOR SAR	25
9.6 POWER DRIFT.....	25
10 AREA SCAN BASED 1-G SAR	26
10.1 REQUIREMENT OF KDB.....	26
10.2 FAST SAR ALGORITHMS	26

11 CONDUCTED OUTPUT POWER.....	27
11.1 GSM MEASUREMENT RESULT	27
11.2 WCDMA MEASUREMENT RESULT	29
11.3 LTE MEASUREMENT RESULT	31
11.4 WI-FI AND BT MEASUREMENT RESULT	49
12 SIMULTANEOUS TX SAR CONSIDERATIONS	51
12.1 INTRODUCTION.....	51
12.2 TRANSMIT ANTENNA SEPARATION DISTANCES.....	51
12.3 SAR MEASUREMENT POSITIONS	51
13 EVALUATION OF SIMULTANEOUS.....	51
14 SAR TEST RESULT	52
14.1 SAR RESULTS FOR CELLULAR	54
14.2 SAR EVALUATION FOR 2.4GWIFI/BT.....	57
14.3 SAR EVALUATION FOR WIFI 5G.....	59
15 SAR MEASUREMENT VARIABILITY.....	61
16 MEASUREMENT UNCERTAINTY	62
16.1 MEASUREMENT UNCERTAINTY FOR NORMAL SAR TESTS (300MHZ~3GHZ).....	62
16.2 MEASUREMENT UNCERTAINTY FOR NORMAL SAR TESTS (3~6GHZ)	63
16.3 MEASUREMENT UNCERTAINTY FOR FAST SAR TESTS (300MHZ~3GHZ).....	64
16.4 MEASUREMENT UNCERTAINTY FOR FAST SAR TESTS (3~6GHZ)	65
17 MAIN TEST INSTRUMENTS	67
APPENDIXES	68

1 Test Laboratory

1.1 Testing Location

Company Name:	CTTL(Shouxiang)
Address:	No. 52, Huayuan North Road, Haidian District, Beijing, P. R. China 100191.

1.2 Testing Environment

Temperature:	18°C~25°C,
Relative humidity:	30%~ 70%
Ground system resistance:	< 0.5 Ω
Ambient noise & Reflection:	< 0.012 W/kg

1.3 Project Data

Project Leader:	Qi Dianyuan
Test Engineer:	Yao Juming
Testing Start Date:	June 2, 2022
Testing End Date:	June 21, 2022

1.4 Signature



Lin Xiaojun
(Prepared this test report)

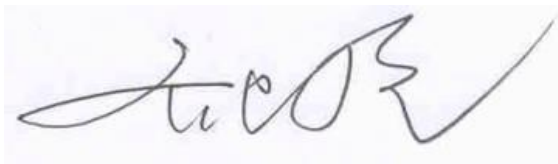

Qi Dianyuan
(Reviewed this test report)

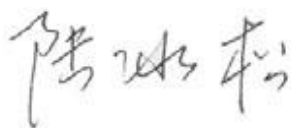

Lu Bingsong
Deputy Director of the laboratory
(Approved this test report)

2 Statement of Compliance

The maximum results of Specific Absorption Rate (SAR) found during testing for Samsung Electronics Co., Ltd Multi-band GSM/WCDMA/LTE phone with Bluetooth, WLAN SM-A045M/DS, SM-A045M is as follows:

Table 2.1: Highest Reported SAR (1g)

Technology Band	Head (Separation Distance 0mm)	Hotspot (Separation Distance 10mm)	Equipment Class
GSM850	0.30	0.47	PCE
GSM1900	0.10	0.79	
WCDMA1900	0.14	0.68	
WCDMA1700	0.19	1.08	
WCDMA 850	0.29	0.49	
LTE Band2	0.10	0.59	
LTE Band7	0.28	0.49	
LTE Band12	0.09	0.26	
LTE Band13	0.14	0.39	
LTE Band26	0.18	0.16	
LTE Band41	0.14	0.27	
LTE Band66	0.12	0.60	
WLAN 2.4GHz	1.01	0.50	DTS
WLAN 5GHz	0.35	0.76	NII
BT	0.04	0.03	DSS

The SAR values found for the Mobile Phone are below the maximum recommended levels of 1.6 W/kg as averaged over any 1g tissue according to the ANSI C95.1-1992.

For body operation, this device has been tested and meets FCC RF exposure guidelines when used with any accessory that contains no metal and which provides a minimum separation distance of 10 mm between this device and the body of the user. Use of other accessories may not ensure compliance with FCC RF exposure guidelines.

The EUT battery must be fully charged and checked periodically during the test to ascertain uniform power output.

The measurement together with the test system set-up is described in annex C of this test report. A detailed description of the equipment under test can be found in chapter 4 of this test report. The highest reported SAR value is obtained at the case of **(Table 2.1)**, and the values are:

Head: 1.01 W/kg(1g)

Body: 1.08 W/kg(1g)

Remark:

This device supports both LTE B4/B5/B17/B38 and LTE B66/B26/B12/B41. Since the supported frequency span for LTE B4/B5/B17/B38 falls completely within the supports frequency span for LTE B66/B26/B12/B41, both LTE bands have the same target power, and both LTE bands share the same transmission path; therefore, SAR was only assessed for LTE B66/B26/B12/B41.

Table 2.2: The sum of SAR values for Main antenna + WiFi-2.4G

	Position	Main antenna	WiFi-2.4G	Sum
Highest SAR value for Head	Left head, Tilt (LTE B7)	0.20	1.01	1.21
Highest SAR value for Body	Rear 10mm (GSM1900)	0.79	0.5	1.29

Table 2.5: The sum of SAR values for Main antenna + WiFi-5G + BT

	Position	Main antenna	WiFi-5G	BT	Sum
Highest SAR value for Head	Left head, Tilt (LTE B7)	0.20	0.35	0.04	0.59
Highest SAR value for Body	Rear 10mm (GSM1900)	0.79	0.76	0.03	1.58

According to the above tables, the highest sum of reported SAR values is **1.58 W/kg (1g)**. The detail for simultaneous transmission consideration is described in chapter 13.

Conclusion:

According to the above tables, the sum of reported SAR values is <1.6W/kg. So the simultaneous transmission SAR with volume scans is not required.

3 Client Information

3.1 Applicant Information

Company Name:	Samsung Electronics Co., Ltd.
Address/Post:	19 Chapin Rd., Building D Pine Brook, NJ 07058
Contact Person:	Jenni Chun
Contact Email:	j1.chun@samsung.com
Telephone:	+1-201-937-4203

3.2 Manufacturer Information

Company Name:	Samsung Electronics Co., Ltd
Address/Post:	Samsung R5, Maetan dong 129, Samsung ro Youngtong gu, Suwon city 443 742, Korea
Contact Person:	조성훈 (Sunghoon Cho)
Contact Email:	ggobi.cho@samsung.com
Telephone:	+82-10-2722-4159
Fax:	/

4 Equipment Under Test (EUT) and Ancillary Equipment (AE)

4.1 About EUT

Description:	Multi-band GSM/WCDMA/LTE phone with Bluetooth, WLAN
Model name:	SM-A045M/DS, SM-A045M
Operating mode(s):	GSM850/900/1800/1900, WCDMA B1/B2/B4/B5/B8 LTE Band 1/2/3/4/5/7/8/12/13/17/26/28/38/40/41/66 BT, Wi-Fi(2.4G), Wi-Fi(5G)
Tested Tx Frequency:	824 – 849 MHz (GSM 850)
	1850 – 1910 MHz (GSM 1900)
	824 – 849 MHz (WCDMA 850 Band V)
	1850 – 1910 MHz (WCDMA1900 Band IV)
	1710-1755 MHz (WCDMA1700 Band II)
	1850.7 – 1909.3 MHz (LTE Band 2)
	2500 – 2570 MHz (LTE Band 7)
	699.7 – 715.3 MHz (LTE Band 12)
	779.5 – 784.5 MHz (LTE Band 13)
	814.7 – 848.3 MHz (LTE Band 26)
	2498.5 – 2687.5 MHz (LTE Band41)
	1710.7 –1779.3 MHz (LTE Band 66)
	2412 – 2462 MHz (Wi-Fi 2.4G)
	2400 – 2483.5 MHz (Bluetooth)
	5180 – 5240 MHz (Wi-Fi 5.2G)
5260 – 5320 MHz (Wi-Fi 5.3G)	
5500 – 5720 MHz (Wi-Fi 5.5G)	
5745 – 5825 MHz (Wi-Fi 5.8G)	
GPRS/EGPRS Multislot Class:	12
Test device production information:	Production unit
Device type:	Portable device
Antenna type:	Integrated antenna
Hotspot mode:	Support

4.2 Internal Identification of EUT used during the test

EUT ID*	IMEI	HW Version	SW Version
EUT1	I22Z70098-26a	REV1.0	A045M.001
EUT2	I22Z70098-27a	REV1.0	A045M.001
EUT3	I22Z70098-21a	REV1.0	A045M.001
EUT4	I22Z70098-24a	REV1.0	A045M.001

*EUT ID: is used to identify the test sample in the lab internally.

Note: It is performed to test SAR with the EUT1~2 and conducted power with the EUT3~4.

4.3 Internal Identification of AE used during the test

AE ID*	Description	Model	SN	Manufacturer
AE1	Battery	SCUD-WT-W1	/	SCUD (FUJIAN) Electronics Co., Ltd.

*AE ID: is used to identify the test sample in the lab internally.

5 TEST METHODOLOGY

5.1 Applicable Limit Regulations

ANSI C95.1–1992:IEEE Standard for Safety Levels with Respect to Human Exposure to Radio Frequency Electromagnetic Fields, 3 kHz to 300 GHz.

It specifies the maximum exposure limit of **1.6 W/kg** as averaged over any 1 gram of tissue for portable devices being used within 20 cm of the user in the uncontrolled environment.

5.2 Applicable Measurement Standards

IEEE 1528–2013: Recommended Practice for Determining the Peak Spatial-Average Specific Absorption Rate (SAR) in the Human Head from Wireless Communications Devices: Measurement Techniques.

KDB447498 D01: General RF Exposure Guidance v06: Mobile and Portable Devices RF Exposure Procedures and Equipment Authorization Policies.

KDB648474 D04 Handset SAR v01r03: SAR Evaluation Considerations for Wireless Handsets.

KDB941225 D01 SAR test for 3G devices v03r01: SAR Measurement Procedures for 3G Devices

KDB941225 D05 SAR for LTE Devices v02r05: SAR Evaluation Considerations for LTE Devices

KDB941225 D06 Hotspot Mode SAR v02r01: SAR Evaluation Procedures for Portable Devices with Wireless Router Capabilities

KDB248227 D01 802.11 Wi-Fi SAR v02r02: SAR GUIDANCE FOR IEEE 802.11 (Wi-Fi) TRANSMITTERS

KDB865664 D01 SAR measurement 100 MHz to 6 GHz v01r04: SAR Measurement Requirements for 100 MHz to 6 GHz.

KDB865664 D02 RF Exposure Reporting v01r02: RF Exposure Compliance Reporting and Documentation Considerations

6 Specific Absorption Rate (SAR)

6.1 Introduction

SAR is related to the rate at which energy is absorbed per unit mass in an object exposed to a radio field. The SAR distribution in a biological body is complicated and is usually carried out by experimental techniques or numerical modeling. The standard recommends limits for two tiers of groups, occupational/controlled and general population/uncontrolled, based on a person's awareness and ability to exercise control over his or her exposure. In general, occupational/controlled exposure limits are higher than the limits for general population/uncontrolled.

6.2 SAR Definition

The SAR definition is the time derivative (rate) of the incremental energy (dW) absorbed by (dissipated in) an incremental mass (dm) contained in a volume element (dv) of a given density (ρ). The equation description is as below:

$$SAR = \frac{d}{dt} \left(\frac{dW}{dm} \right) = \frac{d}{dt} \left(\frac{dW}{\rho dv} \right)$$

SAR is expressed in units of Watts per kilogram (W/kg)

SAR measurement can be either related to the temperature elevation in tissue by

$$SAR = c \left(\frac{\delta T}{\delta t} \right)$$

Where: C is the specific heat capacity, δT is the temperature rise and δt is the exposure duration, or related to the electrical field in the tissue by

$$SAR = \frac{\sigma |E|^2}{\rho}$$

Where: σ is the conductivity of the tissue, ρ is the mass density of tissue and E is the RMS electrical field strength.

However for evaluating SAR of low power transmitter, electrical field measurement is typically applied.

7 Tissue Simulating Liquids

7.1 Targets for tissue simulating liquid

Table 7.1: Targets for tissue simulating liquid

Frequency(MHz)	Liquid Type	Conductivity(σ)	$\pm 5\%$ Range	Permittivity(ϵ)	$\pm 5\%$ Range
750	Head	0.89	0.85~0.93	41.94	39.8~44.0
835	Head	0.90	0.86~0.95	41.5	39.4~43.6
1750	Head	1.37	1.30~1.44	40.08	38.1~42.1
1900	Head	1.40	1.33~1.47	40.0	38.0~42.0
2450	Head	1.67	1.59~1.75	39.47	37.5~41.4
2600	Head	1.96	1.86~2.06	39.01	37.1~41.0
5250	Head	4.71	4.47~4.95	35.93	34.13~37.73
5600	Head	5.07	4.82~5.32	35.53	33.8~37.3
5750	Head	5.22	4.96~5.48	35.36	33.59~37.13

7.2 Dielectric Performance

Table 7.2: Dielectric Performance of Tissue Simulating Liquid

Measurement Date (yyyy-mm-dd)	Type	Frequency	Permittivity ϵ	Drift (%)	Conductivity σ (S/m)	Drift (%)
2022/6/2	Head	750 MHz	44.23	5.46%	0.9087	2.10%
2022/6/4	Head	835 MHz	44.04	6.12%	0.9329	3.66%
2022/6/6	Head	1750 MHz	41.9	4.54%	1.415	3.28%
2022/6/8	Head	1900 MHz	41.69	4.22%	1.494	6.71%
2022/6/10	Head	2450 MHz	41.04	4.69%	1.882	4.56%
2022/6/12	Head	2600 MHz	40.58	4.02%	1.988	1.43%
2022/6/15	Head	5250 MHz	36.07	0.39%	4.656	-1.15%
2022/6/19	Head	5600 MHz	35.42	-0.31%	5.071	0.02%
2022/6/21	Head	5750 MHz	34.97	-1.10%	5.265	0.86%

Note: The liquid temperature is 22.0°C

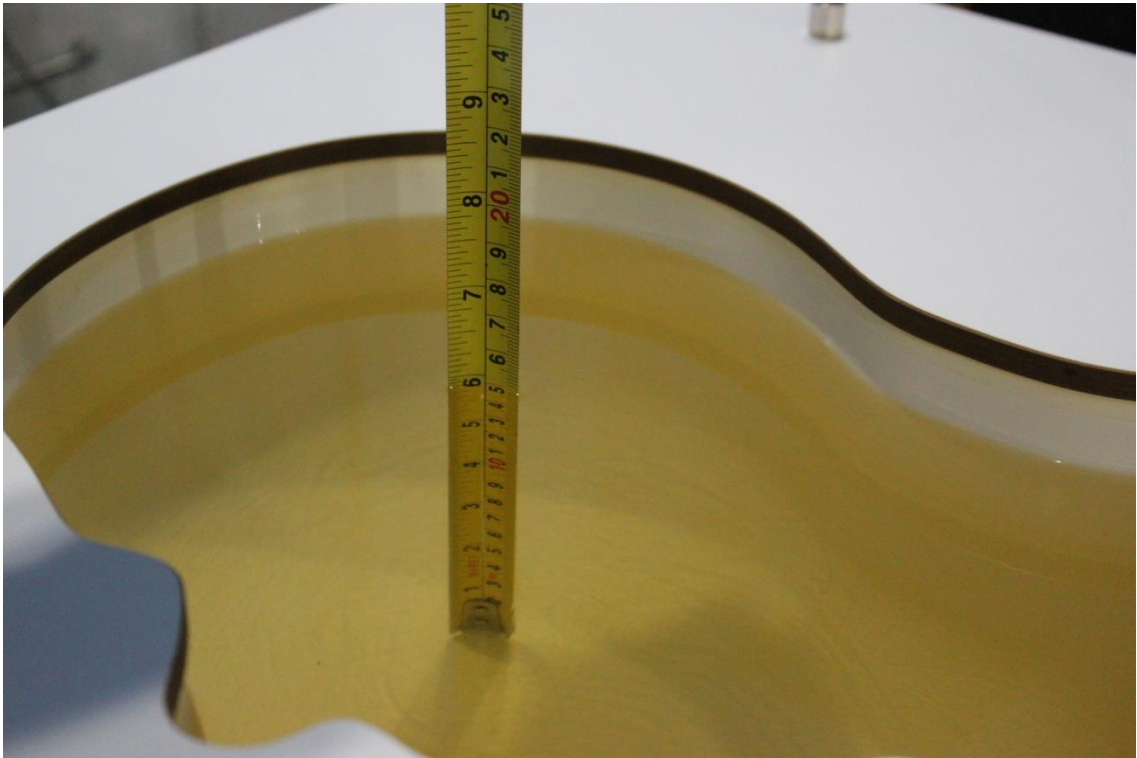

Picture 7-1 Liquid depth in the Head Phantom (750MHz)

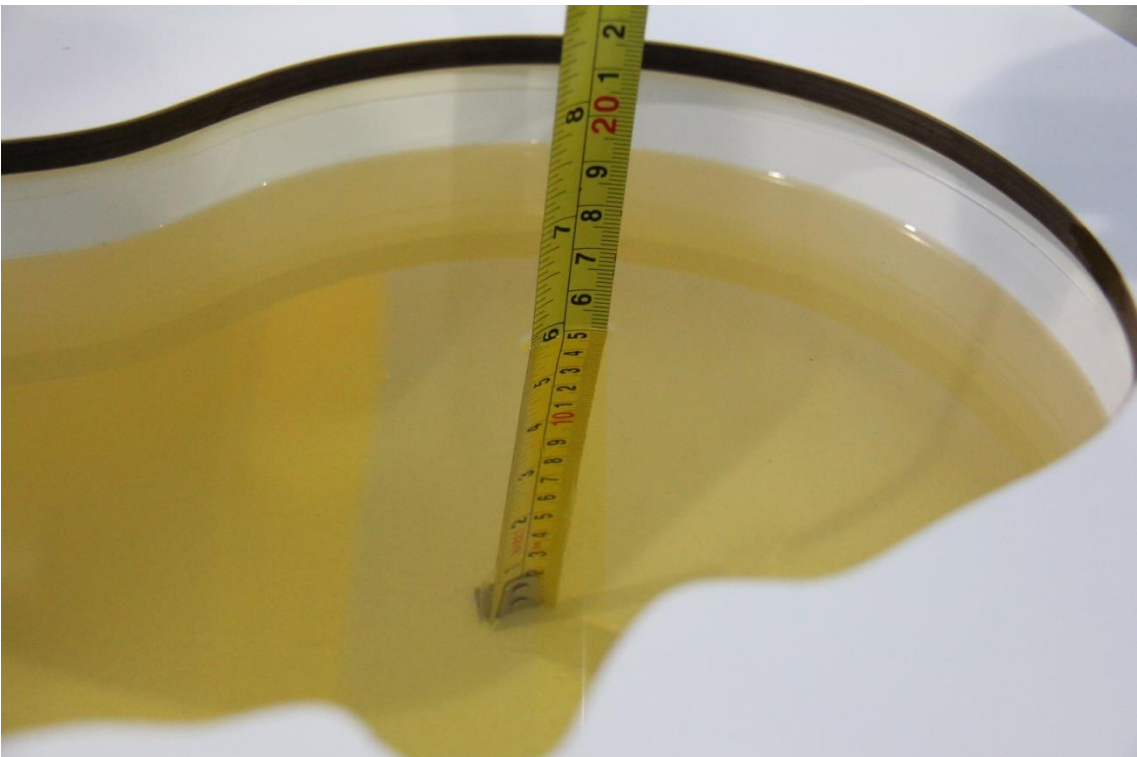

Picture 7-2 Liquid depth in the Head Phantom (835 MHz)

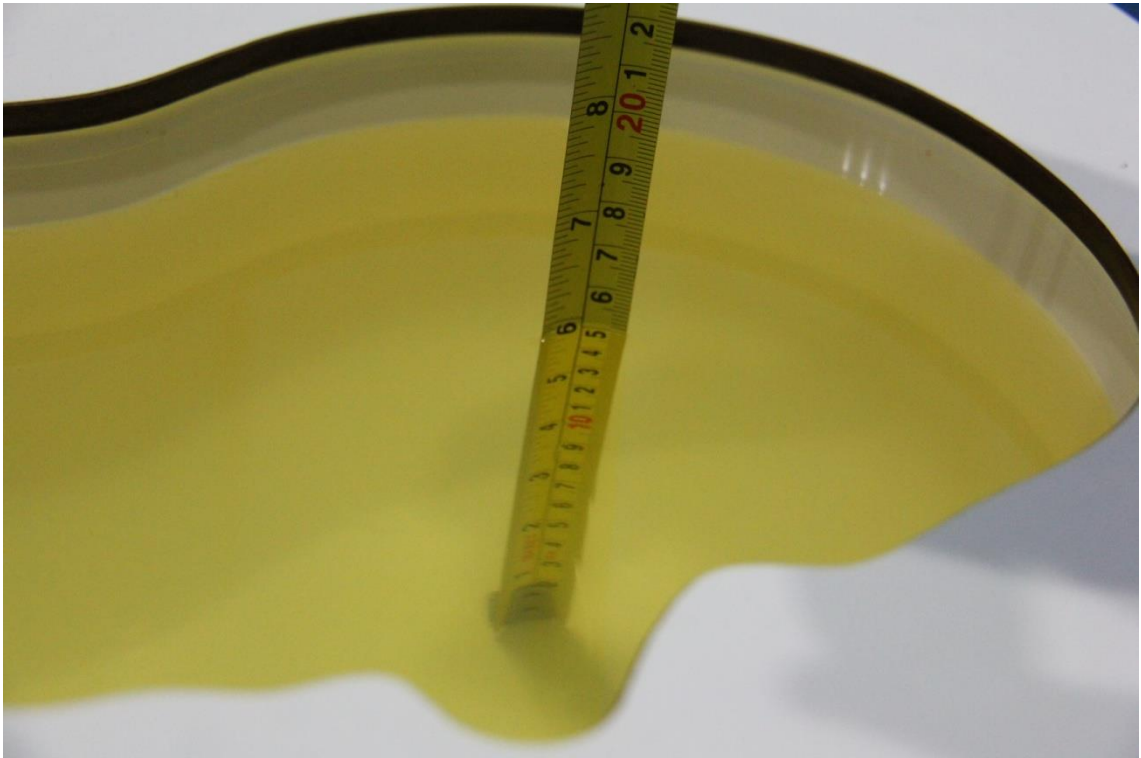

Picture 7-3 Liquid depth in the Head Phantom (1900 MHz)



Picture 7-4 Liquid depth in the Head Phantom (2450MHz)

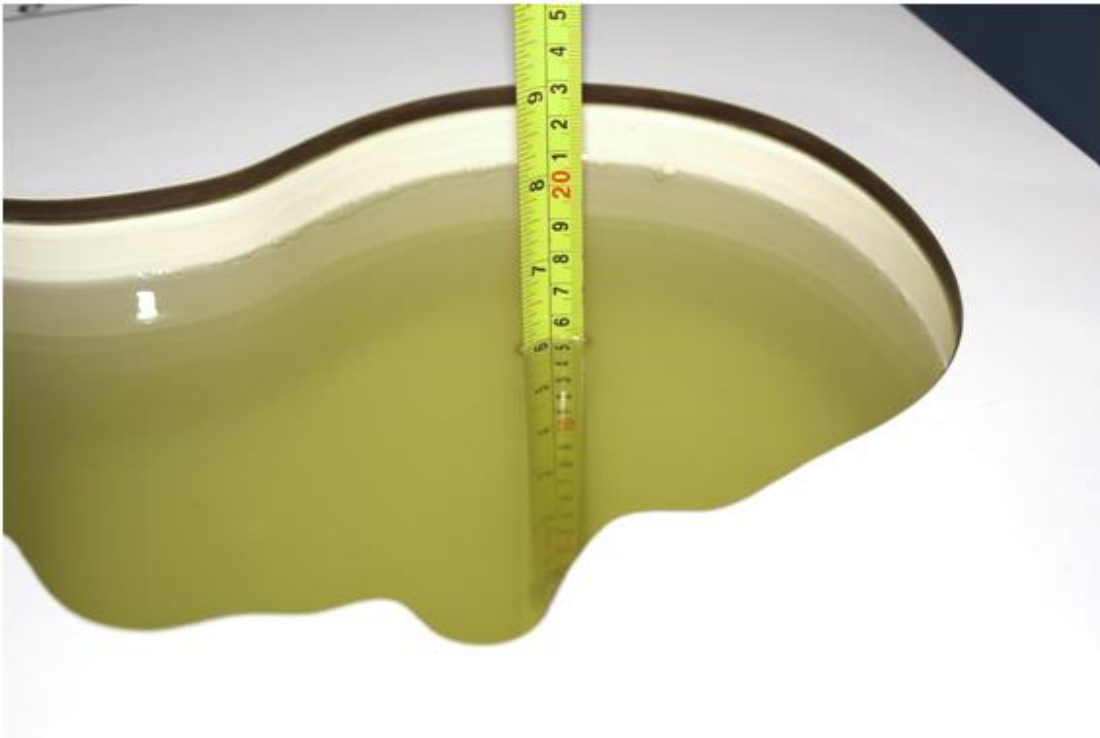

Picture 7-5 Liquid depth in the Head Phantom (2600 MHz)



Picture 7-6 Liquid depth in the Head Phantom (5GHz)

8 System verification

8.1 System Setup

In the simplified setup for system evaluation, the DUT is replaced by a calibrated dipole and the power source is replaced by a continuous wave that comes from a signal generator. The calibrated dipole must be placed beneath the flat phantom section of the SAM twin phantom with the correct distance holder. The distance holder should touch the phantom surface with a light pressure at the reference marking and be oriented parallel to the long side of the phantom. The equipment setup is shown below:

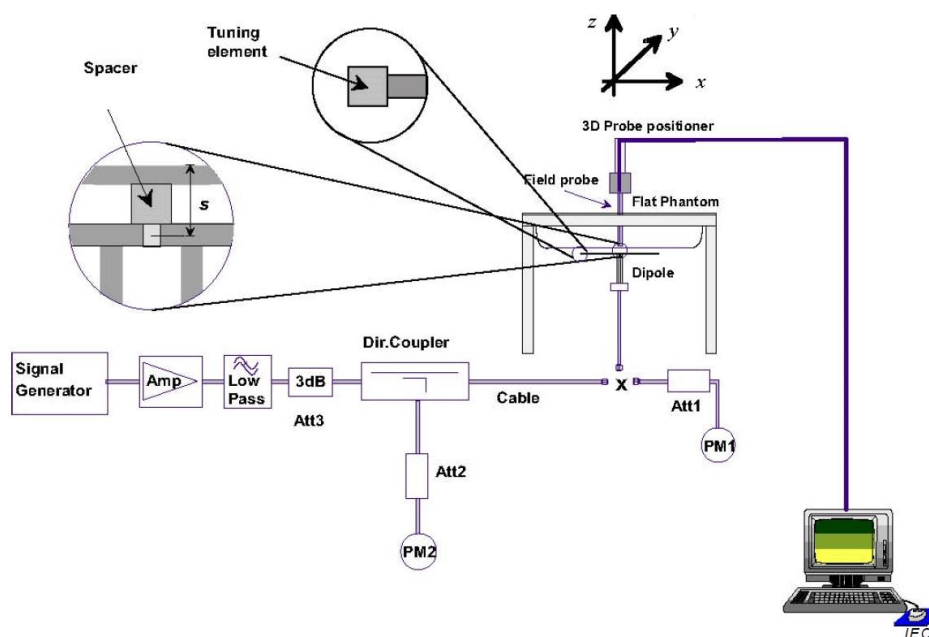

Picture 8.1 System Setup for System Evaluation



Picture 8.2 Photo of Dipole Setup

8.2 System Verification

SAR system verification is required to confirm measurement accuracy, according to the tissue dielectric media, probe calibration points and other system operating parameters required for measuring the SAR of a test device. The system verification must be performed for each frequency band and within the valid range of each probe calibration point required for testing the device.

The system verification results are required that the area scan estimated 1-g SAR is within 3% of the zoom scan 1-g SAR. The details are presented in annex B.

Table 8.1: System Verification of Head

Measurement Date (yyyy-mm-dd)	Frequency	Target value (W/kg)		Measured value(W/kg)		Deviation	
		10 g Average	1 g Average	10 g Average	1 g Average	10 g Average	1 g Average
2022/6/2	750 MHz	5.65	8.68	5.72	8.80	1.24%	1.38%
2022/6/4	835 MHz	6.24	9.63	6.40	9.92	2.56%	3.01%
2022/6/6	1750 MHz	19.4	36.9	19.3	36.7	-0.62%	-0.60%
2022/6/8	1900 MHz	20.9	40.1	20.9	40.0	-0.10%	-0.25%
2022/6/10	2450 MHz	24.9	53.3	25.3	54.8	1.69%	2.81%
2022/6/12	2600 MHz	25.5	57.1	25.9	58.8	1.65%	2.98%
2022/6/15	5250 MHz	22.7	79.5	22.9	80.1	0.88%	0.75%
2022/6/19	5600 MHz	23.7	83.8	24.0	84.5	1.27%	0.84%
2022/6/21	5750 MHz	22.7	81.0	23.0	81.8	1.32%	0.99%

9 Measurement Procedures

9.1 Tests to be performed

In order to determine the highest value of the peak spatial-average SAR of a handset, all device positions, configurations and operational modes shall be tested for each frequency band according to steps 1 to 3 below. A flowchart of the test process is shown in picture 9.1.

Step 1: The tests described in 9.2 shall be performed at the channel that is closest to the centre of the transmit frequency band (f_c) for:

- a) all device positions (cheek and tilt, for both left and right sides of the SAM phantom, as described in annex D),
- b) all configurations for each device position in a), e.g., antenna extended and retracted, and
- c) all operational modes, e.g., analogue and digital, for each device position in a) and configuration in b) in each frequency band.

If more than three frequencies need to be tested according to 11.1 (i.e., $N_c > 3$), then all frequencies, configurations and modes shall be tested for all of the above test conditions.

Step 2: For the condition providing highest peak spatial-average SAR determined in Step 1, perform all tests described in 9.2 at all other test frequencies, i.e., lowest and highest frequencies. In addition, for all other conditions (device position, configuration and operational mode) where the peak spatial-average SAR value determined in Step 1 is within 3 dB of the applicable SAR limit, it is recommended that all other test frequencies shall be tested as well.

Step 3: Examine all data to determine the highest value of the peak spatial-average SAR found in Steps 1 to 2.

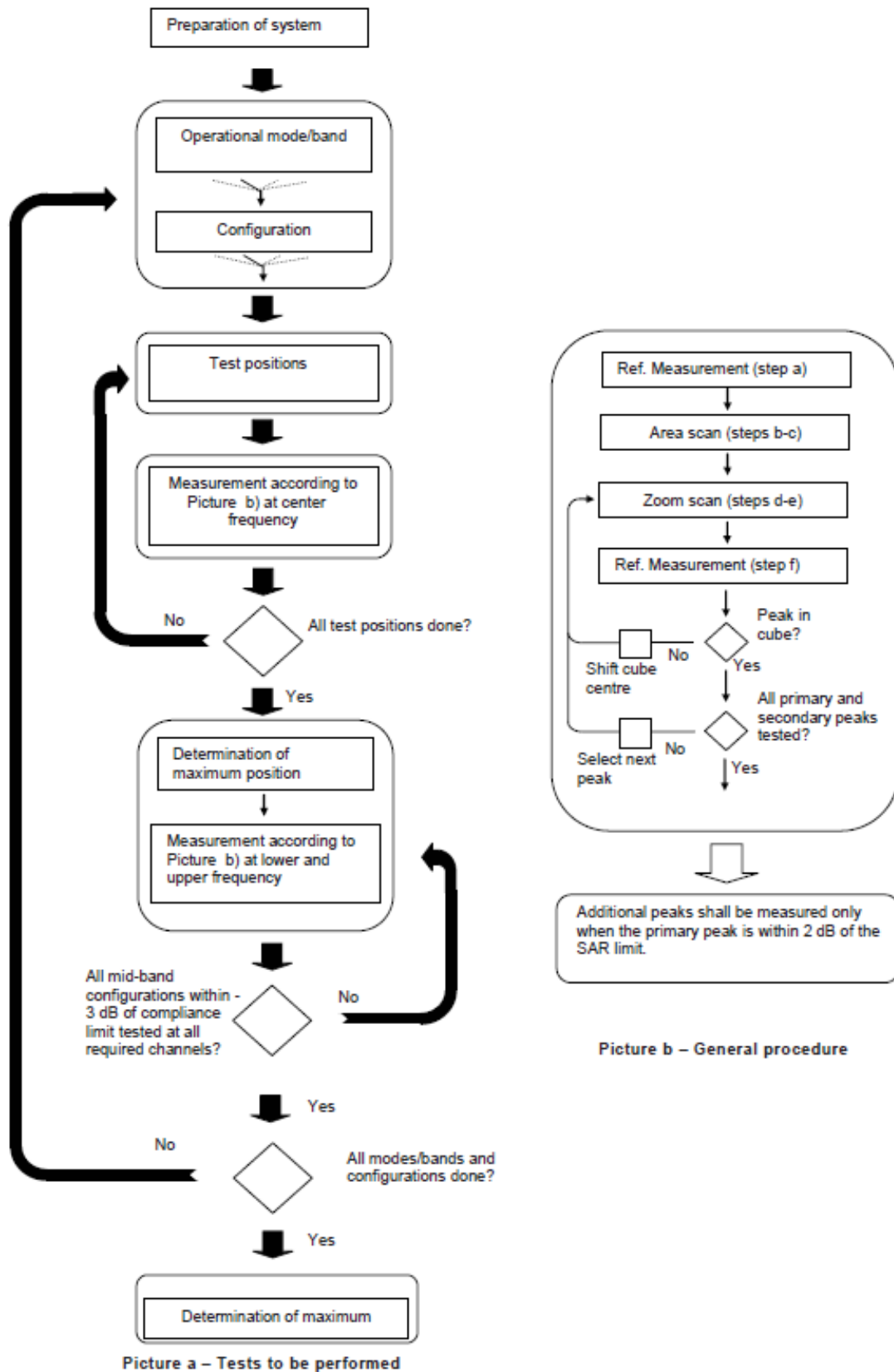

Picture 9.1 Block diagram of the tests to be performed

9.2 General Measurement Procedure

The area and zoom scan resolutions specified in the table below must be applied to the SAR measurements and fully documented in SAR reports to qualify for TCB approval. Probe boundary effect error compensation is required for measurements with the probe tip closer than half a probe tip diameter to the phantom surface. Both the probe tip diameter and sensor offset distance must satisfy measurement protocols; to ensure probe boundary effect errors are minimized and the higher fields closest to the phantom surface can be correctly measured and extrapolated to the phantom surface for computing 1-g SAR. Tolerances of the post-processing algorithms must be verified by the test laboratory for the scan resolutions used in the SAR measurements, according to the reference distribution functions specified in IEEE Std 1528-2003. The results should be documented as part of the system validation records and may be requested to support test results when all the measurement parameters in the following table are not satisfied.

		≤ 3 GHz	> 3 GHz
Maximum distance from closest measurement point (geometric center of probe sensors) to phantom surface		5 ± 1 mm	$\frac{1}{2} \cdot \delta \cdot \ln(2) \pm 0.5$ mm
Maximum probe angle from probe axis to phantom surface normal at the measurement location		$30^\circ \pm 1^\circ$	$20^\circ \pm 1^\circ$
Maximum area scan spatial resolution: Δx_{Area} , Δy_{Area}		≤ 2 GHz: ≤ 15 mm 2 – 3 GHz: ≤ 12 mm	3 – 4 GHz: ≤ 12 mm 4 – 6 GHz: ≤ 10 mm
		When the x or y dimension of the test device, in the measurement plane orientation, is smaller than the above, the measurement resolution must be \leq the corresponding x or y dimension of the test device with at least one measurement point on the test device.	
Maximum zoom scan spatial resolution: Δx_{Zoom} , Δy_{Zoom}		≤ 2 GHz: ≤ 8 mm 2 – 3 GHz: ≤ 5 mm*	3 – 4 GHz: ≤ 5 mm* 4 – 6 GHz: ≤ 4 mm*
Maximum zoom scan spatial resolution, normal to phantom surface	uniform grid: $\Delta z_{Zoom}(n)$	≤ 5 mm	3 – 4 GHz: ≤ 4 mm 4 – 5 GHz: ≤ 3 mm 5 – 6 GHz: ≤ 2 mm
	graded grid	$\Delta z_{Zoom}(1)$: between 1 st two points closest to phantom surface	≤ 4 mm
		$\Delta z_{Zoom}(n>1)$: between subsequent points	$\leq 1.5 \cdot \Delta z_{Zoom}(n-1)$
Minimum zoom scan volume	x, y, z	≥ 30 mm	3 – 4 GHz: ≥ 28 mm 4 – 5 GHz: ≥ 25 mm 5 – 6 GHz: ≥ 22 mm
Note: δ is the penetration depth of a plane-wave at normal incidence to the tissue medium; see draft standard IEEE P1528-2011 for details. * When zoom scan is required and the <i>reported</i> SAR from the area scan based 1-g SAR estimation procedures of KDB 447498 is ≤ 1.4 W/kg, ≤ 8 mm, ≤ 7 mm and ≤ 5 mm zoom scan resolution may be applied, respectively, for 2 GHz to 3 GHz, 3 GHz to 4 GHz and 4 GHz to 6 GHz.			

9.3 WCDMA Measurement Procedures for SAR

The following procedures are applicable to WCDMA handsets operating under 3GPP Release99, Release 5 and Release 6. The default test configuration is to measure SAR with an established radio link between the DUT and a communication test set using a 12.2kbps RMC (reference measurement channel) configured in Test Loop Mode 1. SAR is selectively confirmed for other physical channel configurations (DPCCH & DPDCH_n), HSDPA and HSPA (HSUPA/HSDPA) modes according to output power, exposure conditions and device operating capabilities. Both uplink and downlink should be configured with the same RMC or AMR, when required. SAR for Release 5 HSDPA and Release 6 HSPA are measured using the applicable FRC (fixed reference channel) and E-DCH reference channel configurations. Maximum output power is verified according to applicable versions of 3GPP TS 34.121 and SAR must be measured according to these maximum output conditions. When Maximum Power Reduction (MPR) is not implemented according to Cubic Metric (CM) requirements for Release 6 HSPA, the following procedures do not apply.

For Release 5 HSDPA Data Devices:

Sub-test	β_c	β_d	β_d (SF)	β_c / β_d	β_{hs}	CM/dB
1	2/15	15/15	64	2/15	4/15	0.0
2	12/15	15/15	64	12/15	24/25	1.0
3	15/15	8/15	64	15/8	30/15	1.5
4	15/15	4/15	64	15/4	30/15	1.5

For Release 6 HSPA Data Devices

Sub-test	β_c	β_d	β_d (SF)	β_c / β_d	β_{hs}	β_{ec}	β_{ed}	β_{ed} (SF)	β_{ed} (codes)	CM (dB)	MPR (dB)	AG Index	E-TFCI
1	11/15	15/15	64	11/15	22/15	209/225	1039/225	4	1	1.5	1.5	20	75
2	6/15	15/15	64	6/15	12/15	12/15	12/15	4	1	1.5	1.5	12	67
3	15/15	9/15	64	15/9	30/15	30/15	$\beta_{ed1}:47/15$ $\beta_{ed2}:47/15$	4	2	1.5	1.5	15	92
4	2/15	15/15	64	2/15	4/15	4/15	56/75	4	1	1.5	1.5	17	71
5	15/15	15/15	64	15/15	24/15	30/15	134/15	4	1	1.5	1.5	21	81

Rel.8 DC-HSDPA (Cat 24)

SAR test exclusion for Rel.8 DC-HSDPA must satisfy the SAR test exclusion requirements of Rel.5 HSDPA. SAR test exclusion for DC-HSDPA devices is determined by power measurements according to the H-Set 12, Fixed Reference Channel (FRC) configuration in Table C.8.1.12 of 3GPP TS 34.121-1. A primary and a secondary serving HS-DSCH Cell are required to perform the power measurement and for the results to qualify for SAR test exclusion.

9.4 SAR Measurement for LTE

SAR tests for LTE are performed with a base station simulator, Rohde & Schwarz CMW500. Closed loop power control was used so the UE transmits with maximum output power during SAR testing. All powers were measured with the CMW 500.

It is performed for conducted power and SAR based on the KDB941225 D05.

SAR is evaluated separately according to the following procedures for the different test positions in each exposure condition – head, body, body-worn accessories and other use conditions. The procedures in the following subsections are applied separately to test each LTE frequency band.

1) QPSK with 1 RB allocation

Start with the largest channel bandwidth and measure SAR for QPSK with 1 RB allocation, using the RB offset and required test channel combination with the highest maximum output power among RB offsets at the upper edge, middle and lower edge of each required test channel. When the reported SAR is ≤ 0.8 W/kg, testing of the remaining RB offset configurations and required test channels is not required for 1 RB allocation; otherwise, SAR is required for the remaining required test channels and only for the RB offset configuration with the highest output power for that channel. When the reported SAR of a required test channel is > 1.45 W/kg, SAR is required for all three RB offset configurations for that required test channel.

2) QPSK with 50% RB allocation

The procedures required for 1 RB allocation in 1) are applied to measure the SAR for QPSK with 50% RB allocation.

3) QPSK with 100% RB allocation

For QPSK with 100% RB allocation, SAR is not required when the highest maximum output power for 100 % RB allocation is less than the highest maximum output power in 50% and 1 RB allocations and the highest reported SAR for 1 RB and 50% RB allocation in 1) and 2) are ≤ 0.8 W/kg. Otherwise, SAR is measured for the highest output power channel; and if the reported SAR is > 1.45 W/kg, the remaining required test channels must also be tested.

TDD test:

TDD testing is performed using guidance from FCC KDB 941225 D05 and the SAR test guidance provided in April 2013 TCB works hop notes. TDD is tested at the highest duty factor using UL-DL configuration 0 with special subframe configuration 6 and applying the FDD LTE procedures in KDB 941225 D05. SAR testing is performed using the extended cyclic prefix listed in 3GPP TS 36.211.

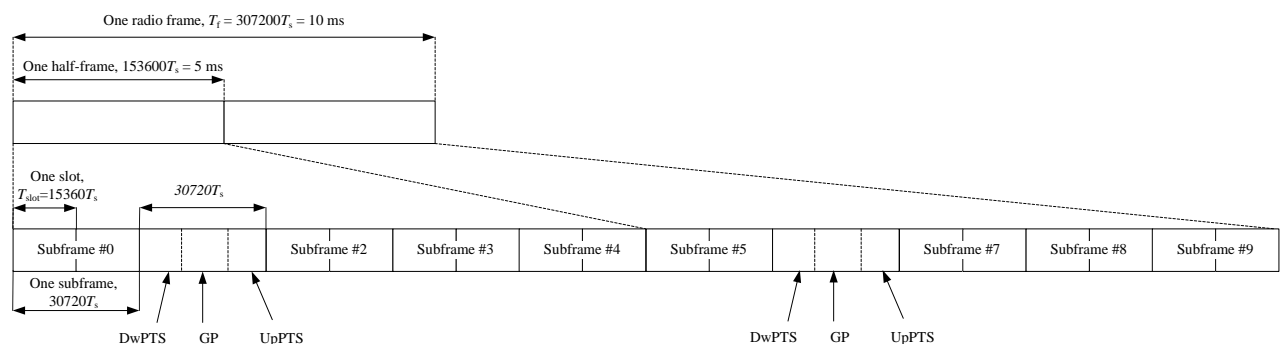

Figure 9.2: Frame structure type 2 (for 5 ms switch-point periodicity)

Table 9.1: Configuration of special subframe (lengths of DwPTS/GP/UpPTS)

Special subframe configuration	Normal cyclic prefix in downlink			Extended cyclic prefix in downlink		
	DwPTS	UpPTS		DwPTS	UpPTS	
		Normal cyclic prefix in uplink	Extended cyclic prefix in uplink		Normal cyclic prefix in uplink	Extended cyclic prefix in uplink
0	$6592 \cdot T_s$	$2192 \cdot T_s$	$2560 \cdot T_s$	$7680 \cdot T_s$	$2192 \cdot T_s$	$2560 \cdot T_s$
1	$19760 \cdot T_s$			$20480 \cdot T_s$		
2	$21952 \cdot T_s$			$23040 \cdot T_s$		
3	$24144 \cdot T_s$			$25600 \cdot T_s$		
4	$26336 \cdot T_s$			$7680 \cdot T_s$		
5	$6592 \cdot T_s$	$4384 \cdot T_s$	$5120 \cdot T_s$	$20480 \cdot T_s$	$4384 \cdot T_s$	$5120 \cdot T_s$
6	$19760 \cdot T_s$			$23040 \cdot T_s$		
7	$21952 \cdot T_s$			$12800 \cdot T_s$		
8	$24144 \cdot T_s$			-		
9	$13168 \cdot T_s$			-		

Table 9.2: Uplink-downlink configurations

Uplink-downlink configuration	Downlink-to-Uplink Switch-point periodicity	Subframe number									
		0	1	2	3	4	5	6	7	8	9
0	5 ms	D	S	U	U	U	D	S	U	U	U
1	5 ms	D	S	U	U	D	D	S	U	U	D
2	5 ms	D	S	U	D	D	D	S	U	D	D
3	10 ms	D	S	U	U	U	D	D	D	D	D
4	10 ms	D	S	U	U	D	D	D	D	D	D
5	10 ms	D	S	U	D	D	D	D	D	D	D
6	5 ms	D	S	U	U	U	D	S	U	U	D

Duty factor is calculated by:

Duty factor = uplink frame*6+UpPTS*2/one frame length

$$= (30720 \cdot T_s * 6 + 5120 \cdot T_s * 2) / 307200 \cdot T_s$$

$$= 0.633$$

9.5 Bluetooth & Wi-Fi Measurement Procedures for SAR

Normal network operating configurations are not suitable for measuring the SAR of 802.11 transmitters in general. Unpredictable fluctuations in network traffic and antenna diversity conditions can introduce undesirable variations in SAR results. The SAR for these devices should be measured using chipset based test mode software to ensure that the results are consistent and reliable.

Chipset based test mode software is hardware dependent and generally varies among manufacturers. The device operating parameters established in a test mode for SAR measurements must be identical to those programmed in production units, including output power levels, amplifier gain settings and other RF performance tuning parameters. The test frequencies should correspond to actual channel frequencies defined for domestic use. SAR for devices with switched diversity should be measured with only one antenna transmitting at a time during each SAR measurement, according to a fixed modulation and data rate. The same data pattern should be used for all measurements.

9.6 Power Drift

To control the output power stability during the SAR test, DASY5 system calculates the power drift by measuring the E-field at the same location at the beginning and at the end of the measurement for each test position. These drift values can be found in section 14 labeled as: (Power Drift [dB]). This ensures that the power drift during one measurement is within 5%.

10 Area Scan Based 1-g SAR

10.1 Requirement of KDB

According to the KDB447498 D01, when the implementation is based the specific polynomial fit algorithm as presented at the 29th Bioelectromagnetics Society meeting (2007) and the estimated 1-gSAR is ≤ 1.2 W/kg, a zoom scan measurement is not required provided it is also not needed for any other purpose; for example, if the peak SAR location required for simultaneous transmission SAR test exclusion can be determined accurately by the SAR system or manually to discriminate between distinctive peaks and scattered noisy SAR distributions from area scans.

There must not be any warning or alert messages due to various measurement concerns identified by the SAR system; for example, noise in measurements, peaks too close to scan boundary, peaks are too sharp, spatial resolution and uncertainty issues etc. The SAR system verification must also demonstrate that the area scan estimated 1-g SAR is within 3% of the zoom scan 1-g SAR (See Annex B). When all the SAR results for each exposure condition in a frequency band and wireless mode are based on estimated 1-g SAR, the 1-g SAR for the highest SAR configuration must be determined by a zoom scan.

10.2 Fast SAR Algorithms

The approach is based on the area scan measurement applying a frequency dependent attenuation parameter. This attenuation parameter was empirically determined by analyzing a large number of phones. The MOTOROLA FAST SAR was developed and validated by the MOTOROLA Research Group in Ft. Lauderdale.

In the initial study, an approximation algorithm based on Linear fit was developed. The accuracy of the algorithm has been demonstrated across a broad frequency range (136-2450 MHz) and for both 1- and 10-g averaged SAR using a sample of 264 SAR measurements from 55 wireless handsets. For the sample size studied, the root-mean-squared errors of the algorithm are 1.2% and 5.8% for 1- and 10-g averaged SAR, respectively. The paper describing the algorithm in detail is expected to be published in August 2004 within the Special Issue of Transactions on MTT.

In the second step, the same research group optimized the fitting algorithm to an Polynomial fit whereby the frequency validity was extended to cover the range 30-6000MHz. Details of this study can be found in the BEMS 2007 Proceedings.

Both algorithms are implemented in DASY software.

11 Conducted Output Power

11.1 GSM Measurement result

Table 11.1-1: The conducted power measurement results–GSM850

GSM 850 Speech (GMSK)	Measured Power (dBm)			Tune up	calculation	Averaged Power (dBm)		
	251	190	128			251	190	128
1 Txslot	31.74	31.69	31.66	33.30				
GSM 850 GPRS (GMSK)	Measured Power (dBm)				calculation	Averaged Power (dBm)		
	251	190	128			251	190	128
1 Txslot	32.82	32.71	32.48	33.50	-9.03	23.79	23.68	23.45
2 Txslots	30.77	30.69	30.41	31.50	-6.02	24.75	24.67	24.39
3Txslots	28.75	28.66	28.40	29.50	-4.26	24.49	24.40	24.14
4 Txslots	27.80	27.69	27.42	28.50	-3.01	24.79	24.68	24.41
GSM 850 EGPRS (GMSK)	Measured Power (dBm)				calculation	Averaged Power (dBm)		
	251	190	128			251	190	128
1 Txslot	32.71	32.68	32.46	33.50	-9.03	23.68	23.65	23.43
2 Txslots	30.70	30.67	30.40	31.50	-6.02	24.68	24.65	24.38
3Txslots	28.69	28.64	28.38	29.50	-4.26	24.43	24.38	24.12
4 Txslots	27.75	27.67	27.41	28.50	-3.01	24.74	24.66	24.40
GSM 850 EGPRS (8PSK)	Measured Power (dBm)				calculation	Averaged Power (dBm)		
	251	190	128			251	190	128
1 Txslot	25.61	25.38	25.58	26.50	-9.03	16.58	16.35	16.55
2 Txslots	24.46	25.42	24.18	24.50	-6.02	18.44	19.40	18.16
3Txslots	22.27	22.22	21.79	22.50	-4.26	18.01	17.96	17.53
4 Txslots	20.76	20.68	20.46	21.50	-3.01	17.75	17.67	17.45

NOTES:

1) Division Factors

To average the power, the division factor is as follows:

1TX-slot = 1 transmit time slot out of 8 time slots=> conducted power divided by (8/1) => -9.03dB

2TX-slots = 2 transmit time slots out of 8 time slots=> conducted power divided by (8/2) => -6.02dB

3TX-slots = 3 transmit time slots out of 8 time slots=> conducted power divided by (8/3) => -4.26dB

4TX-slots = 4 transmit time slots out of 8 time slots=> conducted power divided by (8/4) => -3.01dB

According to the conducted power as above, the body measurements are performed with 4Txslots for GSM850.

Table 11.1-2: The conducted power measurement results-GSM1900

GSM 1900 Speech (GMSK)	Measured Power (dBm)			Tune up	calculation	Averaged Power (dBm)		
	810	661	512			810	661	512
1 Txslot	28.60	28.63	28.98	30.00				
GSM 1900 GPRS (GMSK)	Measured Power (dBm)				calculation	Averaged Power (dBm)		
	251	190	128			251	190	128
1 Txslot	28.58	28.61	28.97	30.00	-9.03	19.55	19.58	19.94
2 Txslots	27.03	27.07	27.45	28.00	-6.02	21.01	21.05	21.43
3Txslots	24.96	25.04	25.45	26.00	-4.26	20.70	20.78	21.19
4 Txslots	24.14	24.26	24.51	25.00	-3.01	21.13	21.25	21.50
GSM 1900 EGPRS (GMSK)	Measured Power (dBm)				calculation	Averaged Power (dBm)		
	810	661	512			810	661	512
1 Txslot	28.52	28.57	28.91	30.00	-9.03	19.49	19.54	19.88
2 Txslots	26.94	27.03	27.40	28.00	-6.02	20.92	21.01	21.38
3Txslots	24.90	25.00	25.39	26.00	-4.26	20.64	20.74	21.13
4 Txslots	24.02	24.24	24.45	25.00	-3.01	21.01	21.23	21.44
GSM 1900 EGPRS (8PSK)	Measured Power (dBm)				calculation	Averaged Power (dBm)		
	810	661	512			810	661	512
1 Txslot	24.56	24.07	24.35	26.00	-9.03	15.53	15.04	15.32
2 Txslots	23.01	22.90	23.24	24.00	-6.02	16.99	16.88	17.22
3Txslots	20.83	20.82	21.18	22.00	-4.26	16.57	16.56	16.92
4 Txslots	19.60	20.09	20.31	21.00	-3.01	16.59	17.08	17.30

NOTES:

1) Division Factors

To average the power, the division factor is as follows:

1TX-slot = 1 transmit time slot out of 8 time slots=> conducted power divided by (8/1) => -9.03dB

2TX-slots = 2 transmit time slots out of 8 time slots=> conducted power divided by (8/2) => -6.02dB

3TX-slots = 3 transmit time slots out of 8 time slots=> conducted power divided by (8/3) => -4.26dB

4TX-slots = 4 transmit time slots out of 8 time slots=> conducted power divided by (8/4) => -3.01dB

According to the conducted power as above, the body measurements are performed with 4Txslots for GSM1900.

11.2 WCDMA Measurement result

Table 11.2-1: The conducted Power for WCDMA B5

WCDMA850	FDDV result (dBm)			Tune up
	4233/4458	4183/4408	4132/4357	
	(846.6MHz)	(836.6MHz)	(826.4MHz)	
	24.48	24.41	24.36	25.5
HSUPA	20.47	20.31	20.17	21.50
	20.45	20.30	20.12	21.50
	21.35	21.19	21.07	22.50
	20.73	20.84	20.79	21.00
	21.35	21.18	21.06	22.50
HSPA+	21.84	21.70	21.61	23.50
DC-HSDPA	22.16	22.13	21.97	22.50
	22.12	22.13	21.96	22.50
	21.68	21.63	21.51	22.50
	21.61	21.61	21.48	22.50

Table 11.2-2: The conducted Power for WCDMA B4

WCDMA1700	FDDIV result (dBm)			Tune up
	1513/1738	1412/1637	1312/1537	
	(1752.6MHz)	(1732.4MHz)	(1712.4MHz)	
	22.59	22.35	22.41	23
HSUPA	18.71	18.63	18.57	19.50
	18.61	18.51	18.44	19.50
	18.55	18.58	18.56	20.50
	18.37	18.44	18.35	19.00
	18.53	18.69	18.71	20.50
HSPA+	20.05	19.94	19.88	21.50
DC-HSDPA	20.39	20.42	20.35	20.50
	20.34	20.37	20.15	20.50
	19.87	19.90	19.79	20.50
	19.83	19.86	19.77	20.50

Table 11.2-3: The conducted Power for WCDMA B2

WCDMA1900	FDDII result (dBm)			Tune up
	9538/9938	9400/9800	9262/9662	
	(1907.6MHz)	(1880MHz)	(1852.4MHz)	
	22.67	22.77	22.40	23.5
HSUPA	18.73	18.80	18.45	19.50
	18.48	18.48	18.17	19.50
	18.76	18.64	18.91	20.50
	18.63	18.57	18.61	19.00
	19.18	19.31	19.18	20.50
HSPA+	19.98	19.96	19.68	21.50
DC-HSDPA	20.43	20.48	20.12	20.50
	20.37	20.45	20.11	20.50
	19.94	19.95	19.62	20.50
	19.91	19.93	19.58	20.50

11.3 LTE Measurement result

Maximum Target Power for Production Unit

Band	Tune up (dBm)
LTE B2	24
LTE B7	23.5
LTE B12	24.5
LTE B13	24.5
LTE B26	25
LTE B41	23.5
LTE B66	22.5

Maximum Power Reduction (MPR) for LTE

Modulation	Channel bandwidth / Transmission bandwidth configuration [RB]						MPR (dB)
	1.4 MHz	3 MHz	5 MHz	10 MHz	15 MHz	20 MHz	
QPSK	> 5	> 4	> 8	> 12	> 16	> 18	1
16 QAM	≤ 5	≤ 4	≤ 8	≤ 12	≤ 16	≤ 18	1
16 QAM	> 5	> 4	> 8	> 12	> 16	> 18	2
64 QAM	≤ 5	≤ 4	≤ 8	≤ 12	≤ 16	≤ 18	3
64 QAM	> 5	> 4	> 8	> 12	> 16	> 18	3

LTE B2

Band 2					
Bandwidth (MHz)	RB allocation	Frequency (MHz)	Actual output power (dBm)		
	RB offset		QPSK	16QAM	64QAM
1.4MHz	1RB-High (5)	1909.3	23.36	22.21	21.03
		1880	22.96	22.20	21.25
		1850.7	22.40	21.62	20.56
	1RB-Middle (3)	1909.3	23.53	22.30	21.20
		1880	23.09	22.40	21.28
		1850.7	22.51	21.86	20.67
	1RB-Low (0)	1909.3	23.36	22.20	21.13
		1880	22.94	22.26	21.19
		1850.7	22.35	21.75	20.52
	3RB-High (3)	1909.3	23.47	21.88	21.04
		1880	23.04	22.02	21.17
		1850.7	22.44	21.47	20.54
	3RB-Middle (1)	1909.3	23.08	22.03	21.09
		1880	23.11	22.06	21.20

	3RB-Low (0)	1850.7	22.55	21.56	20.62	
		1909.3	22.98	21.89	21.06	
		1880	23.06	21.95	21.19	
		1850.7	22.49	21.48	20.57	
		1909.3	21.95	21.08	19.92	
		1880	22.03	21.19	20.07	
	6RB (0)	1850.7	21.47	20.59	19.49	
		1909.3	23.40	22.09	21.11	
		1880	23.17	22.29	21.27	
		1851.5	22.49	21.85	20.73	
		1908.5	23.64	22.44	21.34	
		1880	23.41	22.43	21.34	
3MHz	1RB-High (14)	1851.5	22.60	21.84	20.92	
		1908.5	23.41	22.24	21.14	
		1880	23.09	22.26	21.30	
	1RB-Middle (7)	1851.5	22.40	21.80	20.72	
		1908.5	22.43	20.99	19.99	
		1880	22.21	21.17	20.29	
	1RB-Low (0)	1851.5	21.48	20.54	19.53	
		1908.5	22.49	21.08	20.03	
		1880	22.25	21.14	20.26	
	8RB-High (7)	1851.5	21.52	20.56	19.54	
		1908.5	22.46	21.02	20.00	
		1880	22.29	21.12	20.32	
	8RB-Middle (4)	1851.5	21.49	20.56	19.71	
		1908.5	22.27	20.98	19.95	
		1880	22.17	21.31	20.35	
	8RB-Low (0)	1851.5	21.47	20.51	19.65	
		1907.5	23.31	22.02	21.03	
		1880	23.32	22.18	21.51	
	5MHz	1RB-High (24)	1852.5	22.40	21.79	21.13
			1907.5	23.65	22.50	21.26
			1880	23.57	22.38	21.80
		1RB-Middle (12)	1852.5	22.59	22.04	21.36
			1907.5	23.31	22.12	21.08
			1880	23.00	22.10	21.54
1RB-Low (0)		1852.5	22.31	21.61	21.00	
		1907.5	22.42	20.94	19.91	
		1880	22.39	21.07	20.57	
12RB-High (13)		1852.5	21.53	20.54	20.04	
		1907.5	22.52	20.99	20.15	
		1880	22.52	21.14	20.60	
12RB-Middle (6)		1852.5	21.55	20.55	20.07	
		1907.5	22.49	20.98	20.07	
		1880	22.44	21.11	20.55	
12RB-Low (0)		1852.5	21.52	20.54	19.98	
		1907.5	22.41	20.97	20.06	
		1880	22.46	21.37	20.57	
25RB (0)		1852.5	21.57	20.60	20.01	
		1905	23.42	22.22	21.06	
		1880	23.02	22.41	21.54	
10MHz		1RB-High (49)	1855	22.61	21.94	21.23

	1RB-Middle (24)	1905	23.55	22.34	21.28	
		1880	23.10	22.36	21.63	
		1855	22.62	21.88	21.16	
	1RB-Low (0)	1905	23.57	22.40	21.26	
		1880	22.91	22.14	21.45	
		1855	22.41	21.71	21.03	
	25RB-High (25)	1905	22.49	20.98	19.98	
		1880	22.08	21.05	20.39	
		1855	21.51	20.53	20.02	
	25RB-Middle (12)	1905	22.55	21.06	20.09	
		1880	22.09	21.08	20.57	
		1855	21.58	20.56	20.09	
	25RB-Low (0)	1905	22.52	21.08	20.24	
		1880	21.99	20.99	20.51	
		1855	21.53	20.53	20.04	
	50RB (0)	1905	22.44	21.05	20.13	
		1880	22.06	21.09	20.54	
		1855	21.53	20.53	20.03	
15MHz	1RB-High (74)	1902.5	23.34	22.08	21.08	
		1880	23.01	22.18	21.20	
		1857.5	22.63	22.03	20.94	
	1RB-Middle (37)	1902.5	23.50	22.29	21.15	
		1880	23.03	22.38	21.22	
		1857.5	22.57	21.96	20.99	
	1RB-Low (0)	1902.5	23.50	22.24	21.17	
		1880	22.83	22.15	20.99	
		1857.5	22.37	21.71	20.76	
	36RB-High (38)	1902.5	22.49	20.97	19.95	
		1880	22.06	21.06	20.09	
		1857.5	21.71	20.66	19.70	
	36RB-Middle (19)	1902.5	22.40	21.03	20.04	
		1880	22.05	21.05	20.07	
		1857.5	21.63	20.59	19.64	
	36RB-Low (0)	1902.5	22.28	21.06	20.10	
		1880	21.93	20.93	19.95	
		1857.5	21.57	20.54	19.65	
	75RB (0)	1902.5	22.14	21.06	20.00	
		1880	22.00	21.03	20.12	
		1857.5	21.61	20.59	19.94	
	20MHz	1RB-High (99)	1900	22.66	21.88	20.91
			1880	22.84	22.17	21.05
			1860	22.55	21.85	20.72
		1RB-Middle (50)	1900	23.15	22.49	21.28
			1880	23.10	22.40	21.32
			1860	22.73	22.06	20.92
1RB-Low (0)		1900	22.91	22.25	21.02	
		1880	22.60	21.95	20.84	
		1860	22.19	21.58	20.74	
50RB-High (50)		1900	22.00	21.02	19.96	
		1880	22.04	21.09	20.05	
		1860	21.80	20.76	19.76	
50RB-Middle		1900	22.08	21.12	20.09	



	(25)	1880	22.03	21.08	20.06
		1860	21.71	20.73	19.68
	50RB-Low (0)	1900	22.16	21.19	20.20
		1880	22.08	20.96	19.94
		1860	21.95	20.68	19.66
	100RB (0)	1900	22.07	21.11	20.09
		1880	22.00	21.02	20.03
		1860	21.73	20.73	19.71

LTE B7

Band 7						
Bandwidth (MHz)	RB allocation	Frequency (MHz)	Actual output power (dBm)			
	RB offset		QPSK	16QAM	64QAM	
5MHz	1RB-High (24)	2567.5	22.80	21.66	20.51	
		2535	22.42	21.43	20.68	
		2502.5	22.71	21.78	20.92	
	1RB-Middle (12)	2567.5	23.00	21.78	20.86	
		2535	22.68	21.68	20.81	
		2502.5	22.95	21.83	20.94	
	1RB-Low (0)	2567.5	22.73	21.57	20.43	
		2535	22.43	21.47	20.54	
		2502.5	22.35	21.65	20.85	
	12RB-High (13)	2567.5	21.97	20.55	19.68	
		2535	21.61	20.47	19.47	
		2502.5	21.64	20.56	19.92	
	12RB-Middle (6)	2567.5	21.99	20.53	19.71	
		2535	21.66	20.56	19.59	
		2502.5	21.58	20.60	19.97	
	12RB-Low (0)	2567.5	21.94	20.51	19.79	
		2535	21.63	20.41	19.61	
		2502.5	21.47	20.49	19.97	
	25RB (0)	2567.5	21.95	20.57	19.95	
		2535	21.60	20.58	19.56	
		2502.5	21.56	20.53	19.99	
	10MHz	1RB-High (49)	2565	22.85	21.74	20.94
			2535	22.47	21.76	20.57
			2505	22.80	21.97	20.94
1RB-Middle (24)		2565	22.93	21.73	20.77	
		2535	22.65	21.74	20.70	
		2505	22.97	21.96	20.96	
1RB-Low (0)		2565	22.75	21.50	20.83	
		2535	22.57	21.90	20.69	
		2505	22.45	21.67	20.97	
25RB-High (25)		2565	21.99	20.56	19.84	
		2535	21.63	20.72	19.50	
		2505	21.83	20.92	19.93	
25RB-Middle (12)		2565	21.94	20.70	19.86	
		2535	21.65	20.70	19.54	
		2505	21.92	20.76	19.93	
25RB-Low (0)		2565	21.92	20.78	19.91	
		2535	21.68	20.70	19.64	
		2505	21.85	20.72	19.99	
50RB (0)	2565	21.98	20.95	19.97		

		2535	21.66	20.71	19.62
		2505	21.81	20.83	19.96
15MHz	1RB-High (74)	2562.5	22.76	21.93	21.00
		2535	22.41	21.78	20.61
		2507.5	22.67	21.95	20.98
	1RB-Middle (37)	2562.5	22.79	21.97	20.98
		2535	22.59	21.85	20.79
		2507.5	22.89	21.97	20.95
	1RB-Low (0)	2562.5	22.56	21.76	20.83
		2535	22.52	21.77	20.75
		2507.5	22.83	21.96	20.91
	36RB-High (38)	2562.5	21.96	20.95	19.98
		2535	21.64	20.65	19.60
		2507.5	21.99	20.99	19.99
	36RB-Middle (19)	2562.5	21.92	20.90	19.91
		2535	21.68	20.67	19.65
		2507.5	21.99	20.98	19.99
	36RB-Low (0)	2562.5	21.88	20.84	19.83
		2535	21.67	20.71	19.66
		2507.5	21.96	20.95	19.95
75RB (0)	2562.5	21.91	20.89	19.93	
	2535	21.66	20.66	19.60	
	2507.5	21.97	20.97	19.92	
20MHz	1RB-High (99)	2560	22.59	21.84	20.84
		2535	22.21	21.57	20.39
		2510	22.40	21.71	20.70
	1RB-Middle (50)	2560	22.92	21.85	20.91
		2535	22.62	21.98	20.82
		2510	22.91	21.98	20.93
	1RB-Low (0)	2560	22.37	21.77	20.62
		2535	22.37	21.75	20.56
		2510	22.65	21.91	20.82
	50RB-High (50)	2560	21.90	20.91	19.95
		2535	21.59	20.67	19.56
		2510	21.91	20.97	20.00
	50RB-Middle (25)	2560	21.96	20.87	19.90
		2535	21.76	20.72	19.65
		2510	21.94	20.95	19.96
	50RB-Low (0)	2560	21.84	20.82	19.81
		2535	21.70	20.73	19.67
		2510	21.92	20.94	19.92
100RB (0)	2560	21.94	20.83	19.90	
	2535	21.63	20.65	19.62	
	2510	21.92	20.91	19.89	

LTE B12

Band 12					
Bandwidth (MHz)	RB allocation	Frequency (MHz)	Actual output power (dBm)		
	RB offset		QPSK	16QAM	64QAM
1.4MHz	1RB-High	715.3	23.77	23.05	21.99
		707.5	23.82	23.03	22.13
		699.7	23.81	23.09	22.07
	1RB-Middle (3)	715.3	23.87	23.05	22.09
		707.5	23.99	23.27	22.18
		699.7	23.97	23.14	22.16
	1RB-Low (0)	715.3	23.78	23.08	22.02
		707.5	23.82	23.11	22.07
		699.7	23.82	23.08	22.09
	3RB-High (3)	715.3	23.90	22.91	21.93
		707.5	23.91	22.87	22.11
		699.7	23.90	22.95	22.05
	3RB-Middle (1)	715.3	23.91	22.88	22.06
		707.5	23.96	23.03	22.11
		699.7	23.94	22.94	22.14
	3RB-Low (0)	715.3	23.90	22.86	21.99
		707.5	23.94	22.99	22.07
		699.7	23.93	22.93	22.09
	6RB (0)	715.3	22.95	21.97	20.93
		707.5	22.99	22.10	20.99
		699.7	22.97	22.06	20.98
3MHz	1RB-High (14)	714.5	23.84	23.09	22.01
		707.5	23.88	23.20	22.16
		700.5	23.94	23.20	22.20
	1RB-Middle (7)	714.5	24.06	23.25	22.24
		707.5	24.11	23.29	22.27
		700.5	24.04	23.39	22.35
	1RB-Low (0)	714.5	23.88	23.14	22.13
		707.5	23.93	23.30	22.16
		700.5	23.90	23.26	22.20
	8RB-High (7)	714.5	22.92	21.95	20.96
		707.5	22.97	22.07	21.07
		700.5	22.94	22.03	21.03
	8RB-Middle (4)	714.5	22.97	22.00	21.00
		707.5	23.02	22.09	21.08
		700.5	22.99	22.05	21.09
	8RB-Low (0)	714.5	22.99	21.99	20.99
		707.5	22.98	22.04	21.05
		700.5	23.00	22.05	21.04
15RB (0)	714.5	22.96	21.95	20.91	

		707.5	23.02	22.04	21.00
		700.5	22.99	22.00	20.99
5MHz	1RB-High (24)	713.5	23.74	23.04	21.93
		707.5	23.75	23.09	21.94
		701.5	23.86	23.15	22.02
	1RB-Middle (12)	713.5	24.04	23.24	22.28
		707.5	24.12	23.42	22.38
		701.5	24.09	23.37	22.29
	1RB-Low (0)	713.5	23.75	23.09	22.01
		707.5	23.84	23.22	22.04
		701.5	23.81	23.18	21.99
	12RB-High (13)	713.5	22.86	21.87	20.88
		707.5	23.02	21.99	21.01
		701.5	22.98	22.01	21.04
	12RB-Middle (6)	713.5	23.03	22.00	21.01
		707.5	23.05	22.04	21.04
		701.5	23.06	22.05	21.06
	12RB-Low (0)	713.5	23.02	22.01	21.03
		707.5	23.01	22.01	21.01
		701.5	23.02	22.05	21.03
	25RB (0)	713.5	22.98	21.97	20.95
		707.5	23.02	22.01	21.01
		701.5	23.02	22.05	21.04
10MHz	1RB-High (49)	711	23.78	23.00	21.98
		707.5	23.81	23.09	21.96
		704	23.85	23.18	22.12
	1RB-Middle (24)	711	23.96	23.20	22.19
		707.5	24.00	23.27	22.21
		704	24.04	23.35	22.33
	1RB-Low (0)	711	23.93	23.14	22.13
		707.5	23.92	23.25	22.13
		704	23.88	23.26	22.15
	25RB-High (25)	711	22.94	21.92	20.92
		707.5	23.02	22.00	21.02
		704	23.11	22.12	21.10
	25RB-Middle (12)	711	23.04	22.03	21.01
		707.5	23.02	22.03	21.01
		704	23.04	22.06	21.05
	25RB-Low (0)	711	23.00	22.00	20.98
		707.5	23.01	22.03	21.02
		704	23.08	22.12	21.09
	50RB (0)	711	22.96	21.97	20.96
		707.5	23.03	22.04	21.03
		704	23.09	22.10	21.12

LTE B13

Band 13					
Bandwidth (MHz)	RB allocation	Frequency (MHz)	Actual output power (dBm)		
	RB offset		QPSK	16QAM	64QAM
5MHz	1RB-High (24)	784.5	23.61	22.98	21.83
		782	23.59	22.82	21.87
		779.5	23.55	22.80	21.80
	1RB-Middle (12)	784.5	23.86	22.98	21.99
		782	23.84	22.99	21.97
		779.5	23.83	22.97	21.90
	1RB-Low (0)	784.5	23.63	22.93	21.81
		782	23.59	22.91	21.82
		779.5	23.55	22.84	21.77
	12RB-High (13)	784.5	22.79	21.78	20.78
		782	22.70	21.71	20.73
		779.5	22.77	21.78	20.79
	12RB-Middle (6)	784.5	22.87	21.85	20.86
		782	22.81	21.81	20.80
		779.5	22.79	21.82	20.82
	12RB-Low (0)	784.5	22.83	21.81	20.86
		782	22.76	21.72	20.74
		779.5	22.61	21.60	20.61
25RB (0)	784.5	22.84	21.84	20.80	
	782	22.76	21.74	20.76	
	779.5	22.73	21.72	20.73	
10MHz	1RB-High (49)	782	23.74	22.97	21.95
	1RB-Middle (24)	782	23.84	22.99	22.01
	1RB-Low (0)	782	23.71	22.93	21.93
	25RB-High (25)	782	22.79	21.81	20.78
	25RB-Middle (12)	782	22.82	21.81	20.79
	25RB-Low (0)	782	22.73	21.74	20.73
	50RB (0)	782	22.78	21.78	20.76

LTE B26

Band 26					
Bandwidth (MHz)	RB allocation	Frequency (MHz)	Actual output power (dBm)		
	RB offset		QPSK	16QAM	64QAM
1.4MHz	1RB-High (5)	848.3 (27033)	23.70	23.01	21.99
		831.5 (26865)	23.37	22.65	21.58
		814.7 (26697)	23.50	22.04	21.81
	1RB-Middle (3)	848.3 (27033)	23.81	23.03	22.09
		831.5 (26865)	23.49	22.81	21.67
		814.7 (26697)	23.76	22.27	21.94
	1RB-Low (0)	848.3 (27033)	23.70	22.88	21.97
		831.5 (26865)	23.35	22.55	21.51
		814.7 (26697)	23.46	22.72	21.31
	3RB-High (3)	848.3 (27033)	23.80	22.80	21.93
		831.5 (26865)	23.47	22.43	21.56
		814.7 (26697)	23.22	22.46	21.46
	3RB-Middle (1)	848.3 (27033)	23.83	22.83	21.95
		831.5 (26865)	23.51	22.51	21.67
		814.7 (26697)	23.29	22.46	21.30
	3RB-Low (0)	848.3 (27033)	23.81	22.83	21.93
		831.5 (26865)	23.46	22.36	21.61
		814.7 (26697)	23.59	22.66	21.47
	6RB (0)	848.3 (27033)	22.81	21.95	20.85
		831.5 (26865)	22.46	21.59	20.47
		814.7 (26697)	22.46	21.81	20.49
3MHz	1RB-High (14)	847.5 (27025)	23.80	23.10	22.04

		831.5	23.48	22.72	21.72
		815.5	23.80	23.59	21.59
	1RB-Middle (7)	847.5 (27025)	23.97	23.29	22.22
		831.5	23.66	22.77	21.73
		815.5	23.39	22.05	22.01
	1RB-Low (0)	847.5 (27025)	23.81	23.19	22.09
		831.5	23.44	22.73	21.65
		815.5	23.09	22.50	21.54
	8RB-High (7)	847.5 (27025)	22.84	21.96	20.94
		831.5	22.50	21.60	20.57
		815.5	23.17	22.83	20.87
	8RB-Middle (4)	847.5 (27025)	22.88	21.97	20.97
		831.5	22.55	21.62	20.64
		815.5	22.49	22.12	20.13
	8RB-Low (0)	847.5 (27025)	22.82	21.97	20.94
		831.5	22.45	21.60	20.57
		815.5	22.87	21.42	20.47
	15RB (0)	847.5 (27025)	22.86	21.92	20.84
		831.5	22.49	21.54	20.53
		815.5	22.06	21.61	21.60
5MHz	1RB-High (24)	846.5 (27015)	23.78	23.00	22.00
		831.5 (26865)	23.47	22.81	21.71
		816.5 (26715)	23.69	23.54	22.46
	1RB-Middle (12)	846.5 (27015)	24.03	23.22	22.31
		831.5 (26865)	23.70	22.93	21.92
		816.5 (26715)	23.27	23.02	22.94
	1RB-Low (0)	846.5 (27015)	23.71	22.98	21.92
		831.5 (26865)	23.39	22.71	21.64
		816.5 (26715)	23.79	22.45	22.39
	12RB-High (13)	846.5 (27015)	22.88	21.92	20.93
		831.5 (26865)	22.60	21.60	20.64
		816.5 (26715)	22.19	21.81	20.78
	12RB-Middle (6)	846.5 (27015)	22.94	21.99	21.00

		831.5 (26865)	22.60	21.63	20.63	
		816.5 (26715)	22.24	21.78	20.72	
	12RB-Low (0)	846.5 (27015)	22.89	21.93	20.97	
		831.5 (26865)	22.53	21.53	20.57	
		816.5 (26715)	22.15	21.65	20.65	
	25RB (0)	846.5 (27015)	22.89	21.93	20.93	
		831.5 (26865)	22.56	21.62	20.62	
		816.5 (26715)	22.23	21.83	20.81	
	10MHz	1RB-High (49)	844 (26990)	24.42	23.16	22.07
			831.5 (26865)	24.08	22.95	21.87
			820 (26750)	23.50	22.65	21.62
		1RB-Middle (24)	844 (26990)	24.46	23.14	22.17
831.5 (26865)			24.17	23.00	21.93	
820 (26750)			24.04	22.86	21.81	
1RB-Low (0)		844 (26990)	24.25	23.00	21.98	
		831.5 (26865)	23.83	22.88	21.67	
		820 (26750)	24.46	23.11	21.04	
25RB-High (25)		844 (26990)	23.43	21.99	20.95	
		831.5 (26865)	23.25	21.74	20.90	
		820 (26750)	23.70	21.45	20.56	
25RB-Middle (12)		844 (26990)	23.43	21.96	20.95	
		831.5 (26865)	23.13	21.73	20.90	
		820 (26750)	23.87	21.55	20.55	
25RB-Low (0)		844 (26990)	23.52	22.05	21.01	
		831.5 (26865)	23.14	21.72	20.97	
		820 (26750)	23.15	21.76	20.73	
50RB (0)		844 (26990)	23.43	22.02	20.96	
		831.5 (26865)	22.96	21.81	21.08	

		820 (26750)	22.50	21.25	20.36
15MHz	1RB-High (74)	841.5 (26965)	24.42	23.66	22.16
		831.5 (26865)	24.20	23.42	22.35
		822.5 (26775)	24.05	23.33	22.22
	1RB-Middle (37)	841.5 (26965)	24.40	23.62	22.42
		831.5 (26865)	24.16	23.38	22.33
		822.5	24.35	23.07	22.95
	1RB-Low (0)	841.5 (26965)	24.43	23.40	22.34
		831.5 (26865)	24.37	23.29	22.24
		822.5	24.85	23.60	22.45
	36RB-High (38)	841.5 (26965)	23.49	22.42	21.44
		831.5 (26865)	23.30	22.27	21.25
		822.5 (26775)	23.21	22.88	21.97
	36RB-Middle (19)	841.5 (26965)	23.51	22.44	21.45
		831.5 (26865)	23.25	22.21	21.21
		822.5 (26775)	23.22	22.46	21.79
	36RB-Low (0)	841.5 (26965)	23.55	22.37	21.39
		831.5 (26865)	23.42	22.17	21.19
		822.5 (26775)	23.72	22.37	21.27
	75RB (0)	841.5 (26965)	23.49	22.42	21.44
		831.5 (26865)	23.26	22.26	21.20
		822.5 (26775)	23.91	22.47	21.42

LTE B41

Band 41			
Bandwidth (MHz)	RB allocation	Frequency (MHz)	Actual output power (dBm)

	RB offset		QPSK	16QAM	64QAM
5MHz	1RB-High (24)	2687.5 (41565)	23.02	22.09	20.64
		2640.3(41093)	23.01	22.07	20.69
		2593 (40620)	23.27	22.38	20.98
		2545.8(40148)	22.70	21.83	20.40
		2498.5 (39675)	23.01	22.13	20.73
	1RB-Middle (12)	2687.5 (41565)	23.24	22.34	20.97
		2640.3(41093)	23.18	22.29	20.87
		2593 (40620)	23.44	22.34	21.24
		2545.8(40148)	22.93	22.07	20.62
		2498.5 (39675)	23.30	22.37	21.01
	1RB-Low (0)	2687.5 (41565)	23.04	22.14	20.70
		2640.3(41093)	22.99	22.08	20.69
		2593 (40620)	23.36	22.42	21.05
		2545.8(40148)	22.67	21.80	20.38
		2498.5 (39675)	22.98	22.12	20.72
	12RB-High (13)	2687.5 (41565)	22.13	21.00	20.16
		2640.3(41093)	22.08	21.03	20.03
		2593 (40620)	22.47	21.32	20.44
		2545.8(40148)	21.81	20.75	19.76
		2498.5 (39675)	22.22	21.11	20.17
	12RB-Middle (6)	2687.5 (41565)	22.23	21.19	20.25
		2640.3(41093)	22.15	21.08	20.15
		2593 (40620)	22.42	21.43	20.50
		2545.8(40148)	21.86	20.80	19.86
		2498.5 (39675)	22.26	21.20	20.27
	12RB-Low (0)	2687.5 (41565)	22.17	21.09	20.17
		2640.3(41093)	22.12	21.05	20.03
		2593 (40620)	22.45	21.35	20.41
		2545.8(40148)	21.83	20.72	19.75
		2498.5 (39675)	22.14	21.06	20.14
	25RB (0)	2687.5 (41565)	22.16	21.19	20.19
		2640.3(41093)	22.13	21.12	20.11
2593 (40620)		22.45	21.48	20.47	
2545.8(40148)		21.82	20.78	19.77	
2498.5 (39675)		22.18	21.19	20.17	
10MHz	1RB-High (49)	2685 (41540)	23.11	22.19	20.80
		2639(41080)	23.06	22.13	20.74
		2593 (40620)	23.35	22.46	21.03
		2547(40160)	22.80	21.95	20.52
		2501 (39700)	23.05	22.17	20.77
	1RB-Middle (24)	2685 (41540)	23.25	22.34	20.91
		2639(41080)	23.14	22.29	20.90
		2593 (40620)	23.46	22.36	21.20
		2547(40160)	22.89	22.06	20.60

	1RB-Low (0)	2501 (39700)	23.25	22.33	20.94
		2685 (41540)	23.23	22.31	20.90
		2639(41080)	23.12	22.15	20.75
		2593 (40620)	23.44	22.43	21.14
		2547(40160)	22.83	21.95	20.52
	25RB-High (25)	2501 (39700)	23.11	22.23	20.83
		2685 (41540)	22.15	21.10	20.16
		2639(41080)	22.12	21.08	20.17
		2593 (40620)	22.46	21.41	20.47
		2547(40160)	21.83	20.88	19.87
	25RB-Middle (12)	2501 (39700)	22.17	21.19	20.15
		2685 (41540)	22.17	21.17	20.19
		2639(41080)	22.14	21.14	20.14
		2593 (40620)	22.32	21.46	20.50
		2547(40160)	21.84	20.83	19.85
	25RB-Low (0)	2501 (39700)	22.22	21.20	20.20
		2685 (41540)	22.21	21.21	20.27
		2639(41080)	22.14	21.11	20.12
		2593 (40620)	22.48	21.44	20.36
		2547(40160)	21.83	20.86	19.86
50RB (0)	2501 (39700)	22.15	21.19	20.11	
	2685 (41540)	22.12	21.17	20.19	
	2639(41080)	22.07	21.13	20.11	
	2593 (40620)	22.38	21.47	20.47	
	2547(40160)	21.83	20.87	19.80	
15MHz	1RB-High (74)	2501 (39700)	22.14	21.19	20.11
		2682.5 (41515)	22.96	22.04	20.65
		2637.8(41068)	22.93	21.99	20.64
		2593 (40620)	23.21	22.32	20.86
		2548.3(40173)	22.76	21.90	20.47
	1RB-Middle (37)	2503.5 (39725)	22.90	22.08	20.59
		2682.5 (41515)	23.23	22.21	20.89
		2637.8(41068)	23.09	22.19	20.76
		2593 (40620)	23.44	22.46	21.13
		2548.3(40173)	22.87	21.97	20.54
	1RB-Low (0)	2503.5 (39725)	23.06	22.24	20.84
		2682.5 (41515)	23.05	22.17	20.75
		2637.8(41068)	23.03	22.14	20.73
		2593 (40620)	23.35	22.46	21.06
		2548.3(40173)	22.73	21.83	20.40
	36RB-High (38)	2503.5 (39725)	22.96	22.11	20.69
		2682.5 (41515)	22.13	21.06	20.05
		2637.8(41068)	22.15	21.03	20.00
		2593 (40620)	22.44	21.37	20.20
		2548.3(40173)	21.90	20.83	19.82
		2503.5 (39725)	22.21	21.09	20.09

	36RB-Middle (19)	2682.5 (41515)	22.23	21.19	20.17
		2637.8(41068)	22.16	21.06	20.04
		2593 (40620)	22.50	21.45	20.44
		2548.3(40173)	21.90	20.77	19.83
		2503.5 (39725)	22.22	21.10	20.13
	36RB-Low (0)	2682.5 (41515)	22.26	21.20	20.20
		2637.8(41068)	22.13	21.08	20.13
		2593 (40620)	22.50	21.41	20.43
		2548.3(40173)	21.88	20.78	19.75
		2503.5 (39725)	22.15	21.13	20.06
	75RB (0)	2682.5 (41515)	22.09	21.12	20.14
		2637.8(41068)	22.05	21.05	20.10
		2593 (40620)	22.35	21.42	20.42
		2548.3(40173)	21.81	20.84	19.82
		2503.5 (39725)	22.13	21.07	20.06
20MHz	1RB-High (99)	2680 (41490)	22.73	21.86	20.46
		2636.5(41055)	22.73	21.80	20.43
		2593 (40620)	22.97	22.02	20.69
		2549.5(40185)	22.57	21.76	20.33
		2506 (39750)	22.65	21.75	20.39
	1RB-Middle (50)	2680 (41490)	23.19	22.35	20.98
		2636.5(41055)	23.14	22.23	20.85
		2593 (40620)	23.49	22.48	21.19
		2549.5(40185)	22.95	22.03	20.61
		2506 (39750)	23.17	22.28	20.92
	1RB-Low (0)	2680 (41490)	22.93	22.01	20.59
		2636.5(41055)	22.83	21.90	20.48
		2593 (40620)	23.15	22.24	20.89
		2549.5(40185)	22.48	21.58	20.20
		2506 (39750)	22.79	21.95	20.54
	50RB-High (50)	2680 (41490)	21.97	21.00	20.01
		2636.5(41055)	21.99	21.06	20.10
		2593 (40620)	22.29	21.36	20.36
		2549.5(40185)	21.83	20.88	19.83
		2506 (39750)	22.07	21.09	20.03
	50RB-Middle (25)	2680 (41490)	22.16	21.11	20.12
		2636.5(41055)	22.05	21.08	20.06
		2593 (40620)	22.39	21.40	20.37
		2549.5(40185)	21.88	20.83	19.79
		2506 (39750)	22.09	21.13	20.10
	50RB-Low (0)	2680 (41490)	22.14	21.16	20.16
		2636.5(41055)	22.00	21.04	20.03
		2593 (40620)	22.38	21.41	20.41
		2549.5(40185)	21.74	20.76	19.76
		2506 (39750)	22.03	21.09	20.09
100RB (0)	2680 (41490)	22.05	21.12	20.06	

		2636.5(41055)	22.12	21.12	20.06
		2593 (40620)	22.35	21.38	20.37
		2549.5(40185)	21.82	20.88	19.82
		2506 (39750)	22.09	21.12	20.13

LTE B66

Band 66					
Bandwidth (MHz)	RB allocation	Frequency (MHz)	Actual output power (dBm)		
	RB offset		QPSK	16QAM	64QAM
1.4MHz	1RB-High	1779.3	21.59	20.86	19.80
		1745	21.88	21.11	20.15
		1710.7	21.54	20.91	19.73
	1RB-Middle (3)	1779.3	21.73	21.11	19.92
		1745	21.98	21.28	20.21
		1710.7	21.67	21.00	19.90
	1RB-Low (0)	1779.3	21.60	20.97	19.82
		1745	21.82	21.11	20.11
		1710.7	21.51	20.87	19.80
	3RB-High (3)	1779.3	21.70	20.69	19.80
		1745	21.99	21.04	20.08
		1710.7	21.66	20.65	19.75
	3RB-Middle (1)	1779.3	21.76	20.80	19.91
		1745	22.00	21.01	20.14
		1710.7	21.71	20.77	19.80
	3RB-Low (0)	1779.3	21.72	20.71	19.89
		1745	21.93	20.98	20.04
		1710.7	21.64	20.62	19.79
	6RB (0)	1779.3	20.74	19.83	18.74
		1745	20.97	20.10	18.97
		1710.7	20.68	19.79	18.64
3MHz	1RB-High (14)	1778.5	21.59	20.98	19.81
		1745	21.83	21.18	20.18
		1711.5	21.55	20.84	19.83
	1RB-Middle (7)	1778.5	21.75	21.14	19.99
		1745	21.99	21.45	20.16
		1711.5	21.60	21.08	19.87
	1RB-Low (0)	1778.5	21.61	21.01	19.84
		1745	21.82	21.10	20.03
		1711.5	21.54	20.78	19.69
8RB-High (7)	1778.5	20.68	19.73	18.72	
	1745	20.91	19.96	18.94	
	1711.5	20.57	19.63	18.62	

	8RB-Middle (4)	1778.5	20.71	19.77	18.72	
		1745	20.95	20.03	18.98	
		1711.5	20.62	19.66	18.63	
	8RB-Low (0)	1778.5	20.68	19.75	18.71	
		1745	20.91	19.96	18.95	
		1711.5	20.57	19.65	18.66	
	15RB (0)	1778.5	20.66	19.71	18.65	
		1745	20.91	19.92	18.88	
		1711.5	20.55	19.60	18.58	
5MHz	1RB-High (24)	1777.5	21.47	20.81	19.73	
		1745	21.73	21.12	19.92	
		1712.5	21.42	20.80	19.61	
	1RB-Middle (12)	1777.5	21.77	21.08	19.97	
		1745	22.02	21.36	20.34	
		1712.5	21.71	21.11	19.91	
	1RB-Low (0)	1777.5	21.55	20.85	19.77	
		1745	21.73	21.00	19.99	
		1712.5	21.41	20.66	19.68	
	12RB-High (13)	1777.5	20.62	19.63	18.65	
		1745	20.85	19.88	18.88	
		1712.5	20.56	19.57	18.60	
	12RB-Middle (6)	1777.5	20.72	19.69	18.76	
		1745	20.97	19.95	18.98	
		1712.5	20.62	19.66	18.66	
	12RB-Low (0)	1777.5	20.69	19.69	18.69	
		1745	20.89	19.90	18.91	
		1712.5	20.54	19.52	18.58	
	25RB (0)	1777.5	20.68	19.69	18.68	
		1745	20.88	19.89	18.89	
		1712.5	20.56	19.59	18.57	
	10MHz	1RB-High (49)	1775	21.58	20.97	19.78
			1745	21.87	21.16	20.12
			1715	21.54	20.83	19.73
1RB-Middle (24)		1775	21.81	21.20	20.06	
		1745	21.97	21.28	20.27	
		1715	21.64	21.10	19.88	
1RB-Low (0)		1775	21.75	21.14	20.00	
		1745	21.84	21.23	20.02	
		1715	21.51	20.86	19.72	
25RB-High (25)		1775	20.67	19.68	18.68	
		1745	20.94	19.96	18.97	
		1715	20.64	19.64	18.63	
25RB-Middle (12)		1775	20.80	19.80	18.82	
		1745	20.98	20.00	18.98	
		1715	20.65	19.65	18.66	
25RB-Low (0)		1775	20.80	19.85	18.85	
		1745	20.95	19.96	18.95	
		1715	20.60	19.60	18.61	
50RB (0)		1775	20.78	19.77	18.77	
		1745	20.95	19.98	18.96	

		1715	20.63	19.65	18.62
15MHz	1RB-High (74)	1772.5	21.50	20.77	19.76
		1745	21.79	21.13	19.95
		1717.5	21.51	20.80	19.67
	1RB-Middle (37)	1772.5	21.73	21.13	20.04
		1745	21.86	21.24	20.16
		1717.5	21.55	20.90	19.79
	1RB-Low (0)	1772.5	21.71	21.11	19.99
		1745	21.73	21.05	19.92
		1717.5	21.47	20.90	19.76
	36RB-High (38)	1772.5	20.70	19.66	18.68
		1745	20.91	19.93	18.93
		1717.5	20.64	19.66	18.68
	36RB-Middle (19)	1772.5	20.82	19.81	18.82
		1745	20.98	19.98	18.97
		1717.5	20.62	19.61	18.64
	36RB-Low (0)	1772.5	20.88	19.81	18.87
		1745	20.94	19.92	18.94
		1717.5	20.58	19.54	18.58
75RB (0)	1772.5	20.79	19.78	18.76	
	1745	20.90	19.91	18.91	
	1717.5	20.64	19.63	18.59	
20MHz	1RB-High (99)	1770	21.32	20.76	19.62
		1745	21.61	20.85	19.81
		1720	21.42	20.83	19.69
	1RB-Middle (50)	1770	21.86	21.15	20.06
		1745	21.94	21.21	20.21
		1720	21.83	20.97	19.87
	1RB-Low (0)	1770	21.57	20.88	19.84
		1745	21.50	20.99	19.78
		1720	21.26	20.62	19.53
	50RB-High (50)	1770	20.70	19.72	18.98
		1745	20.88	19.88	18.91
		1720	20.68	19.72	18.70
	50RB-Middle (25)	1770	20.83	19.86	18.76
		1745	20.95	19.98	18.96
		1720	20.62	19.65	18.63
	50RB-Low (0)	1770	20.89	19.90	18.93
		1745	20.98	19.98	18.96
		1720	20.96	19.64	18.62
100RB (0)	1770	20.81	19.81	18.80	
	1745	20.92	19.92	18.90	
	1720	20.65	19.67	18.68	

11.4 Wi-Fi and BT Measurement result

The maximum output power of BT antenna is 9.66dBm.

The maximum tune up of BT antenna is 10dBm.

FCC									
802.11b	Channel\ld	1Mbps	2Mbps	5.5Mbps	11Mbps				
WLAN2450	11(2462M	19.17	19.27	19.31	19.21				
	6(2437(M	18.97	\	19.20	\				
	1(2412MH	18.91	\	19.19	\				
tune up		19.50	19.50	19.50	19.50				
802.11g	Channel\ld	6Mbps	9Mbps	12Mbps	18Mbps	24Mbps	36Mbps	48Mbps	54Mbps
WLAN2450	11(2462M	13.03	\	\	\	\	\	\	\
	tune up	13.50	13.50	13.50	13.50	13.50	13.50	13.50	13.50
	6(2437(M	18.22	17.18	17.18	17.22	16.25	16.23	16.31	15.35
	tune up	18.50	18.00	18.00	18.00	17.00	17.00	17.00	16.50
	1(2412MH	12.35	\	\	\	\	\	\	\
tune up		13.50	13.50	13.50	13.50	13.50	13.50	13.50	13.50
802.11n-20MHz	Channel\ld	MCS0	MCS1	MCS2	MCS3	MCS4	MCS5	MCS6	MCS7
WLAN2450	11(2462M	12.99	\	\	\	\	\	\	\
	tune up	13.50	13.50	13.50	13.50	13.50	13.50	13.50	13.50
	6(2437(M	18.10	17.08	17.11	17.06	16.15	16.20	16.22	15.23
	tune up	18.50	18.00	18.00	18.00	17.00	17.00	17.00	16.00
	1(2412MH	12.49	\	\	\	\	\	\	\
tune up		13.50	13.50	13.50	13.50	13.50	13.50	13.50	13.50

5GHz									
802.11a(dBm)									
Channel\data rate	6Mbps	9Mbps	12Mbps	18Mbps	24Mbps	36Mbps	48Mbps	54Mbps	
36(5180 MHz)	15.05								
40(5200 MHz)	15.00								
44(5220 MHz)	15.07	13.66	13.47	13.45	13.32	13.42	13.36	13.34	
48(5240 MHz)	15.02								
52(5260 MHz)	15.01								
56(5280 MHz)	14.97								
60(5300 MHz)	15.01								
64(5320 MHz)	15.02	14.44	14.26	14.18	14.14	14.19	14.17	14.10	
100(5500 MHz)	14.50								
104(5520 MHz)	14.44								
108(5540 MHz)	14.37								
112(5560 MHz)	14.52								
116(5580 MHz)	14.55								
120(5600 MHz)	14.56								
124(5620 MHz)	14.48								
128(5640 MHz)	14.53								
132(5660 MHz)	14.61								
136(5680 MHz)	14.83	13.95	13.74	13.69	13.74	13.43	13.49	13.46	
144(5720 MHz)	14.81								
tune up	15.50	15.00	15.00	15.00	15.00	15.00	15.00	15.00	15.00
140(5700 MHz)	11.96								
tune up	13.00	13.00	13.00	13.00	13.00	13.00	13.00	13.00	13.00
149(5745 MHz)	14.46								
153(5765 MHz)	14.51								
157(5785 MHz)	14.76								
161(5805 MHz)	14.93	14.31	14.25	14.08	14.13	13.96	13.97	13.82	
165(5825 MHz)	14.86								
tune up	15.50	15.00	15.00	15.00	15.00	15.00	15.00	15.00	14.50

12 Simultaneous TX SAR Considerations

12.1 Introduction

The following procedures adopted from “FCC SAR Considerations for Cell Phones with Multiple Transmitters” are applicable to handsets with built-in unlicensed transmitters such as 802.11 a/b/g and Bluetooth devices which may simultaneously transmit with the licensed transmitter.

For this device, the BT and Wi-Fi can transmit simultaneous with other transmitters.

12.2 Transmit Antenna Separation Distances

Please refer to the picture of antenna locations in the document: “The Photos of SAR test - I22Z70093”

12.3 SAR Measurement Positions

According to the KDB941225 D06 Hot Spot SAR, the edges with less than 2.5 cm distance to the antennas need to be tested for SAR.

SAR measurement positions						
Mode	Front	Rear	Left edge	Right edge	Top edge	Bottom edge
WWAN-Main	Yes	Yes	Yes	Yes	No	Yes
WIFI	Yes	Yes	No	Yes	Yes	No

13 Evaluation of Simultaneous

Table 13.1: The sum of SAR values for Main antenna + WiFi-2.4G

	Position	Main antenna	WiFi-2.4G	Sum
Highest SAR value for Head	Left head, Tilt (LTE B7)	0.20	1.01	1.21
Highest SAR value for Body	Rear 10mm (GSM1900)	0.79	0.5	1.29

Table 13.2: The sum of SAR values for Main antenna + WiFi-5G + BT

	Position	Main antenna	WiFi-5G	BT	Sum
Highest SAR value for Head	Left head, Tilt (LTE B7)	0.20	0.35	0.04	0.59
Highest SAR value for Body	Rear 10mm (GSM1900)	0.79	0.76	0.03	1.58

Conclusion:

According to the above tables, the sum of reported SAR values is $1.6W/kg$. So the simultaneous transmission SAR with volume scans is not required.

14 SAR Test Result

Note:

KDB 447498 D01 General RF Exposure Guidance:

For WWAN: Reported SAR(W/kg)= Measured SAR(W/kg)*Tune-up Scaling Factor

For BT/WLAN: Reported SAR(W/kg)= Measured SAR(W/kg)* Duty Cycle scaling factor * Tune-up scaling factor

Testing of other required channels within the operating mode of a frequency band is not required when the reported 1-g or 10-g SAR for the mid-band or highest output power channel is:

≤ 0.8 W/kg or 2.0 W/kg, for 1-g or 10-g respectively, when the transmission band is ≤ 100 MHz

≤ 0.6 W/kg or 1.5 W/kg, for 1-g or 10-g respectively, when the transmission band is between 100 MHz and 200 MHz

≤ 0.4 W/kg or 1.0 W/kg, for 1-g or 10-g respectively, when the transmission band is ≥ 200 MHz

KDB 648474 D04 Handset SAR:

With headset attached, when the reported SAR for body-worn accessory, measured without a headset connected to the handset, is > 1.2 W/kg, the highest reported SAR configuration for that wireless mode and frequency band should be repeated for that body-worn accessory with a headset attached to the handset.

KDB 941225 D01 SAR test for 3G devices:

When the maximum output power and tune-up tolerance specified for production units in a secondary mode is $\leq \frac{1}{4}$ dB higher than the primary mode or when the highest reported SAR of the primary mode is scaled by the ratio of specified maximum output power and tune-up tolerance of secondary to primary mode and the adjusted SAR is ≤ 1.2 W/kg, SAR measurement is not required for the secondary mode.

KDB 941225 D05 SAR for LTE Devices:

SAR test reduction is applied using the following criteria:

Start with the largest channel bandwidth and measure SAR for QPSK with 1 RB, and 50% RB allocation, using the RB offset and required test channel combination with the highest maximum output power among RB offsets at the upper edge, middle and lower edge of each required test channel.

When the reported SAR is > 0.8 W/kg, testing for other Channels is performed at the highest output power level for 1RB, and 50% RB configuration for that channel.

Testing for 100% RB configuration is performed at the highest output power level for 100% RB configuration across the Low, Mid and High Channel when the highest reported SAR for 1 RB and 50% RB are > 0.8 W/kg. Testing for the remaining required channels is not needed because the reported SAR for 100% RB Allocation < 1.45 W/kg.

Testing for 16-QAM modulation is not required because the reported SAR for QPSK is < 1.45 W/Kg and its output power is not more than 0.5 dB higher than that of QPSK.

Testing for the other channel bandwidths is not required because the reported SAR for the highest channel bandwidth is < 1.45 W/Kg and its output power is not more than 0.5 dB higher than that of the highest channel bandwidth.

For LTE bands that do not support at least three non-overlapping channels in certain channel bandwidths, test the available non-overlapping channels instead. When a device supports overlapping channel assignment in a channel bandwidth configuration, the middle channel of the

group of overlapping channels should be selected for testing; therefore, the requirement for H, M and L channels may not fully apply.

KDB 248227 D01 SAR meas for 802.11:

SAR test reduction for 802.11 Wi-Fi transmission mode configurations are considered separately for DSSS and OFDM. An initial test position is determined to reduce the number of tests required for certain exposure configurations with multiple test positions. An initial test configuration is determined for each frequency band and aggregated band according to maximum output power, channel bandwidth, wireless mode configurations and other operating parameters to streamline the measurement requirements. For 2.4 GHz DSSS, either the initial test position or DSSS procedure is applied to reduce the number of SAR tests; these are mutually exclusive. For OFDM, an initial test position is only applicable to next to the ear, UMPC mini-tablet and hotspot mode configurations, which is tested using the initial test configuration to facilitate test reduction. For other exposure conditions with a fixed test position, SAR test reduction is determined using only the initial test configuration.

To determine the initial test position, Area Scans were performed to determine the position with the Maximum Value of SAR (measured). The position that produced the highest Maximum Value of SAR is considered the worst case position; thus used as the initial test position.

The multiple test positions require SAR measurements in head, hotspot mode or UMPC mini-tablet configurations may be reduced according to the highest reported SAR determined using the initial test position(s) by applying the DSSS or OFDM SAR measurement procedures in the required wireless mode test configuration(s). The initial test position(s) is measured using the highest measured maximum output power channel in the required wireless mode test configuration(s).

When the reported SAR for the initial test position is:

≤ 0.4 W/kg, further SAR measurement is not required for the other test positions in that exposure configuration and wireless mode combination within the frequency band or aggregated band. DSSS and OFDM configurations are considered separately according to the required SAR procedures.

> 0.4 W/kg, SAR is repeated using the same wireless mode test configuration tested in the initial test position to measure the subsequent next closet/smallest test separation distance and maximum coupling test position, on the highest maximum output power channel, until the reported SAR is ≤ 0.8 W/kg or all required test positions are tested.

- For subsequent test positions with equivalent test separation distance or when exposure is dominated by coupling conditions, the position for maximum coupling condition should be tested.
- When it is unclear, all equivalent conditions must be tested.

For all positions/configurations tested using the initial test position and subsequent test positions, when the reported SAR is > 0.8 W/kg, measure the SAR for these positions/configurations on the subsequent next highest measured output power channel(s) until the reported SAR is ≤ 1.2 W/kg or all required test channels are considered.

- The additional power measurements required for this step should be limited to those necessary for identifying subsequent highest output power channels to apply the test reduction.

When the specified maximum output power is the same for both UNII 1 and UNII 2A, begin SAR measurements in UNII 2A with the channel with the highest measured output power. If the reported SAR for UNII 2A is ≤ 1.2 W/kg, SAR is not required for UNII 1; otherwise treat the remaining bands separately and test them independently for SAR.

When the specified maximum output power is different between UNII 1 and UNII 2A, begin SAR with the band that has the higher specified maximum output. If the highest reported SAR for the band with the highest specified power is ≤ 1.2 W/kg, testing for the band with the lower specified output power is not required; otherwise test the remaining bands independently for SAR..

Table 14.1: Duty Cycle

Mode	Duty Cycle
GSM850	1:2
WCDMA<E FDD	1:1
LTE TDD	1:1.58

14.1 SAR results for Cellular

S2: SIM2

S3: Single SIM card slot

Head

RF Exposure Conditions	Frequency Band	Channel Number	Frequency (MHz)	Mode/RB	Test Position	Distance	Figure No./Note	EUT Measured Power (dBm)	Tune up (dBm)	Measured SAR 1g (W/kg)	Reported SAR 1g (W/kg)	Measured SAR 10g (W/kg)	Reported SAR 10g (W/kg)	Power Drift
Head	GSM850	190	836.6	GSM	Cheek Left	0mm	\	32.74	33.5	0.216	0.26	0.161	0.19	0.03
Head	GSM850	190	836.6	GSM	Tilt Left	0mm	\	32.74	33.5	0.102	0.12	0.079	0.09	-0.18
Head	GSM850	251	848.8	GSM	Cheek Right	0mm	A.1	32.79	33.5	0.255	0.30	0.194	0.23	0.09
Head	GSM850	190	836.6	GSM	Cheek Right	0mm	\	32.74	33.5	0.184	0.22	0.142	0.17	0.16
Head	GSM850	128	824.2	GSM	Cheek Right	0mm	\	32.55	33.5	0.143	0.18	0.109	0.14	0.00
Head	GSM850	190	836.6	GSM	Tilt Right	0mm	\	32.74	33.5	0.188	0.22	0.146	0.17	-0.19
Head	GSM1900	810	1909.8	GSM	Cheek Left	0mm	\	28.60	30	0.068	0.09	0.042	0.06	0.05
Head	GSM1900	661	1880	GSM	Cheek Left	0mm	A.2	28.63	30	0.076	0.10	0.048	0.07	-0.09
Head	GSM1900	512	1850.2	GSM	Cheek Left	0mm	\	28.98	30	0.062	0.08	0.038	0.05	0.08
Head	GSM1900	661	1880	GSM	Tilt Left	0mm	\	28.63	30	0.044	0.06	0.028	0.04	0.11
Head	GSM1900	661	1880	GSM	Cheek Right	0mm	\	28.63	30	0.048	0.07	0.031	0.04	0.01
Head	GSM1900	661	1880	GSM	Tilt Right	0mm	\	28.63	30	0.035	0.05	0.022	0.03	0.19
Head	WCDMA1900	9538	1907.6	RMC	Cheek Left	0mm	A.3	22.67	23.5	0.114	0.14	0.073	0.09	0.08
Head	WCDMA1900	9400	1880	RMC	Cheek Left	0mm	\	22.77	23.5	0.102	0.12	0.066	0.08	-0.18
Head	WCDMA1900	9262	1852.4	RMC	Cheek Left	0mm	\	22.50	23.5	0.103	0.13	0.066	0.08	-0.11
Head	WCDMA1900	9400	1880	RMC	Tilt Left	0mm	\	22.77	23.5	0.064	0.08	0.04	0.05	-0.09
Head	WCDMA1900	9400	1880	RMC	Cheek Right	0mm	\	22.77	23.5	0.054	0.06	0.034	0.04	0.05
Head	WCDMA1900	9400	1880	RMC	Tilt Right	0mm	\	22.77	23.5	0.051	0.06	0.033	0.04	-0.15
Head	WCDMA1700	1413	1732.6	RMC	Cheek Left	0mm	\	22.35	23	0.127	0.15	0.083	0.10	0.11
Head	WCDMA1700	1413	1732.6	RMC	Tilt Left	0mm	\	22.35	23	0.076	0.09	0.049	0.06	0.18
Head	WCDMA1700	1513	1752.6	RMC	Cheek Right	0mm	\	22.59	23	0.111	0.12	0.072	0.08	-0.08
Head	WCDMA1700	1413	1732.6	RMC	Cheek Right	0mm	\	22.35	23	0.143	0.17	0.092	0.11	0.02
Head	WCDMA1700	1312	1712.4	RMC	Cheek Right	0mm	A.4	22.41	23	0.168	0.19	0.11	0.13	0.01
Head	WCDMA1700	1413	1732.6	RMC	Tilt Right	0mm	\	22.35	23	0.076	0.09	0.05	0.06	-0.09
Head	WCDMA 850	4183	836.6	RMC	Cheek Left	0mm	\	24.41	25.5	0.226	0.29	0.168	0.22	-0.10
Head	WCDMA 850	4183	836.6	RMC	Tilt Left	0mm	\	24.41	25.5	0.127	0.16	0.099	0.13	0.16
Head	WCDMA 850	4233	846.6	RMC	Cheek Right	0mm	A.5	24.48	25.5	0.23	0.29	0.176	0.22	0.14
Head	WCDMA 850	4183	836.6	RMC	Cheek Right	0mm	\	24.41	25.5	0.205	0.26	0.158	0.20	0.01
Head	WCDMA 850	4132	826.4	RMC	Cheek Right	0mm	\	24.36	25.5	0.168	0.22	0.128	0.17	-0.12
Head	WCDMA 850	4183	836.6	RMC	Tilt Right	0mm	\	24.41	25.5	0.146	0.19	0.111	0.14	-0.13
Head	LTE Band2	19100	1900	1RB-Mid	Cheek Left	0mm	A.6	23.15	24	0.086	0.10	0.055	0.07	0.01
Head	LTE Band2	19100	1900	1RB-Mid	Tilt Left	0mm	\	23.15	24	0.052	0.06	0.035	0.04	0.03
Head	LTE Band2	19100	1900	1RB-Mid	Cheek Right	0mm	\	23.15	24	0.081	0.10	0.05	0.06	-0.11
Head	LTE Band2	19100	1900	1RB-Mid	Tilt Right	0mm	\	23.15	24	0.049	0.06	0.03	0.04	0.18
Head	LTE Band2	19100	1900	50RB-Low	Cheek Left	0mm	\	22.16	23	0.071	0.09	0.045	0.05	0.18
Head	LTE Band2	19100	1900	50RB-Low	Tilt Left	0mm	\	22.16	23	0.044	0.05	0.028	0.03	0.03
Head	LTE Band2	19100	1900	50RB-Low	Cheek Right	0mm	\	22.16	23	0.068	0.08	0.041	0.05	-0.10
Head	LTE Band2	19100	1900	50RB-Low	Tilt Right	0mm	\	22.16	23	0.042	0.05	0.026	0.03	-0.04
Head	LTE Band7	21350	2560	1RB-Mid	Cheek Left	0mm	A.7	22.92	23.5	0.241	0.28	0.128	0.15	0.06
Head	LTE Band7	21350	2560	1RB-Mid	Tilt Left	0mm	\	22.92	23.5	0.173	0.20	0.09	0.10	0.13
Head	LTE Band7	21350	2560	1RB-Mid	Cheek Right	0mm	\	22.92	23.5	0.104	0.12	0.056	0.06	-0.03
Head	LTE Band7	21350	2560	1RB-Mid	Tilt Right	0mm	\	22.92	23.5	0.094	0.11	0.048	0.05	0.15
Head	LTE Band7	21350	2560	50RB-Mid	Cheek Left	0mm	\	21.96	22.5	0.193	0.22	0.099	0.11	-0.01
Head	LTE Band7	21350	2560	50RB-Mid	Tilt Left	0mm	\	21.96	22.5	0.119	0.13	0.063	0.07	0.10
Head	LTE Band7	21350	2560	50RB-Mid	Cheek Right	0mm	\	21.96	22.5	0.079	0.09	0.043	0.05	-0.13
Head	LTE Band7	21350	2560	50RB-Mid	Tilt Right	0mm	\	21.96	22.5	0.074	0.08	0.038	0.04	-0.19
Head	LTE Band12	23060	704	1RB-Mid	Cheek Left	0mm	\	24.04	24.5	0.057	0.06	0.044	0.05	0.14
Head	LTE Band12	23060	704	1RB-Mid	Tilt Left	0mm	\	24.04	24.5	0.037	0.04	0.028	0.03	0.01
Head	LTE Band12	23060	704	1RB-Mid	Cheek Right	0mm	\	24.04	24.5	0.034	0.04	0.026	0.03	0.03
Head	LTE Band12	23060	704	1RB-Mid	Tilt Right	0mm	A.8	24.04	24.5	0.079	0.09	0.062	0.07	0.02
Head	LTE Band12	23060	704	25RB-High	Cheek Left	0mm	\	23.11	23.5	0.049	0.05	0.037	0.04	0.16
Head	LTE Band12	23060	704	25RB-High	Tilt Left	0mm	\	23.11	23.5	0.034	0.04	0.025	0.03	-0.11
Head	LTE Band12	23060	704	25RB-High	Cheek Right	0mm	\	23.11	23.5	0.052	0.06	0.04	0.04	0.11
Head	LTE Band12	23060	704	25RB-High	Tilt Right	0mm	\	23.11	23.5	0.068	0.07	0.053	0.06	0.09
Head	LTE Band13	23230	782	1RB-Mid	Cheek Left	0mm	\	23.84	24.5	0.115	0.13	0.086	0.10	0.16
Head	LTE Band13	23230	782	1RB-Mid	Tilt Left	0mm	\	23.84	24.5	0.09	0.10	0.071	0.08	-0.12
Head	LTE Band13	23230	782	1RB-Mid	Cheek Right	0mm	\	23.84	24.5	0.107	0.12	0.082	0.10	0.16
Head	LTE Band13	23230	782	1RB-Mid	Tilt Right	0mm	A.9	23.84	24.5	0.116	0.14	0.09	0.10	0.09
Head	LTE Band13	23230	782	25RB-Mid	Cheek Left	0mm	\	22.82	23.5	0.084	0.10	0.064	0.07	0.08
Head	LTE Band13	23230	782	25RB-Mid	Tilt Left	0mm	\	22.82	23.5	0.057	0.07	0.045	0.05	-0.10
Head	LTE Band13	23230	782	25RB-Mid	Cheek Right	0mm	\	22.82	23.5	0.075	0.09	0.058	0.07	-0.19
Head	LTE Band13	23230	782	25RB-Mid	Tilt Right	0mm	\	22.82	23.5	0.09	0.11	0.07	0.08	0.03
Head	LTE Band26	26775	822.5	1RB-Low	Cheek Left	0mm	A.10	24.85	25	0.178	0.18	0.136	0.14	0.01
Head	LTE Band26	26775	822.5	1RB-Low	Tilt Left	0mm	\	24.85	25	0.116	0.12	0.091	0.09	0.13
Head	LTE Band26	26775	822.5	1RB-Low	Cheek Right	0mm	\	24.85	25	0.129	0.13	0.101	0.10	-0.12
Head	LTE Band26	26775	822.5	1RB-Low	Tilt Right	0mm	\	24.85	25	0.126	0.13	0.099	0.10	-0.14
Head	LTE Band26	26775	822.5	36RB-Low	Cheek Left	0mm	\	23.72	24	0.152	0.16	0.116	0.12	0.10
Head	LTE Band26	26775	822.5	36RB-Low	Tilt Left	0mm	\	23.72	24	0.096	0.10	0.076	0.08	0.08
Head	LTE Band26	26775	822.5	36RB-Low	Cheek Right	0mm	\	23.72	24	0.11	0.12	0.085	0.09	-0.12
Head	LTE Band26	26775	822.5	36RB-Low	Tilt Right	0mm	\	23.72	24	0.113	0.12	0.089	0.09	0.03



Hotspot	LTE Band13	23230	782	1RB-Mid	Front	10mm	\	23.84	24.5	0.232	0.27	0.176	0.20	-0.19
Hotspot	LTE Band13	23230	782	1RB-Mid	Rear	10mm	A.21	23.84	24.5	0.334	0.39	0.253	0.29	0.07
Hotspot	LTE Band13	23230	782	1RB-Mid	Left	10mm	\	23.84	24.5	0.181	0.21	0.129	0.15	0.12
Hotspot	LTE Band13	23230	782	1RB-Mid	Right	10mm	\	23.84	24.5	0.212	0.25	0.152	0.18	0.03
Hotspot	LTE Band13	23230	782	1RB-Mid	Bottom	10mm	\	23.84	24.5	0.3	0.35	0.184	0.21	-0.09
Hotspot	LTE Band13	23230	782	25RB-Mid	Front	10mm	\	22.82	23.5	0.155	0.18	0.12	0.14	-0.15
Hotspot	LTE Band13	23230	782	25RB-Mid	Rear	10mm	\	22.82	23.5	0.25	0.29	0.188	0.22	-0.08
Hotspot	LTE Band13	23230	782	25RB-Mid	Left	10mm	\	22.82	23.5	0.148	0.17	0.104	0.12	-0.05
Hotspot	LTE Band13	23230	782	25RB-Mid	Right	10mm	\	22.82	23.5	0.173	0.20	0.123	0.14	0.01
Hotspot	LTE Band13	23230	782	25RB-Mid	Bottom	10mm	\	22.82	23.5	0.233	0.27	0.142	0.17	-0.12
Hotspot	LTE Band26	26775	822.5	1RB-Low	Front	10mm	A.22	24.85	25	0.151	0.16	0.115	0.12	0.03
Hotspot	LTE Band26	26775	822.5	1RB-Low	Rear	10mm	\	24.85	25	0.09	0.09	0.07	0.07	0.18
Hotspot	LTE Band26	26775	822.5	1RB-Low	Left	10mm	\	24.85	25	0.07	0.07	0.05	0.05	-0.09
Hotspot	LTE Band26	26775	822.5	1RB-Low	Right	10mm	\	24.85	25	0.105	0.11	0.073	0.08	0.16
Hotspot	LTE Band26	26775	822.5	1RB-Low	Bottom	10mm	\	24.85	25	0.085	0.09	0.049	0.05	-0.17
Hotspot	LTE Band26	26775	822.5	36RB-Low	Front	10mm	\	23.72	24	0.083	0.09	0.064	0.07	0.11
Hotspot	LTE Band26	26775	822.5	36RB-Low	Rear	10mm	\	23.72	24	0.125	0.13	0.095	0.10	0.05
Hotspot	LTE Band26	26775	822.5	36RB-Low	Left	10mm	\	23.72	24	0.066	0.07	0.046	0.05	-0.06
Hotspot	LTE Band26	26775	822.5	36RB-Low	Right	10mm	\	23.72	24	0.092	0.10	0.064	0.07	0.13
Hotspot	LTE Band26	26775	822.5	36RB-Low	Bottom	10mm	\	23.72	24	0.074	0.08	0.044	0.05	0.14
Hotspot	LTE Band41	40620	2593	1RB-Mid	Front	10mm	\	23.49	23.5	0.145	0.15	0.085	0.09	-0.13
Hotspot	LTE Band41	40620	2593	1RB-Mid	Rear	10mm	A.23	23.49	23.5	0.265	0.27	0.13	0.13	-0.03
Hotspot	LTE Band41	40620	2593	1RB-Mid	Left	10mm	\	23.49	23.5	0.149	0.15	0.079	0.08	-0.05
Hotspot	LTE Band41	40620	2593	1RB-Mid	Right	10mm	\	23.49	23.5	<0.01	<0.01	<0.01	<0.01	\
Hotspot	LTE Band41	40620	2593	1RB-Mid	Bottom	10mm	\	23.49	23.5	0.253	0.25	0.12	0.12	-0.02
Hotspot	LTE Band41	40620	2593	50RB-Mid	Front	10mm	\	22.39	22.5	0.109	0.11	0.063	0.06	0.06
Hotspot	LTE Band41	40620	2593	50RB-Mid	Rear	10mm	\	22.39	22.5	0.18	0.18	0.09	0.09	0.14
Hotspot	LTE Band41	40620	2593	50RB-Mid	Left	10mm	\	22.39	22.5	0.113	0.12	0.06	0.06	-0.17
Hotspot	LTE Band41	40620	2593	50RB-Mid	Right	10mm	\	22.39	22.5	<0.01	<0.01	<0.01	<0.01	\
Hotspot	LTE Band41	40620	2593	50RB-Mid	Bottom	10mm	\	22.39	22.5	0.187	0.19	0.089	0.09	0.14
Hotspot	LTE Band66	132322	1745	1RB-Mid	Front	10mm	\	21.94	22.5	0.182	0.21	0.12	0.14	0.11
Hotspot	LTE Band66	132322	1745	1RB-Mid	Rear	10mm	\	21.94	22.5	0.467	0.53	0.289	0.33	-0.04
Hotspot	LTE Band66	132322	1745	1RB-Mid	Left	10mm	\	21.94	22.5	0.104	0.12	0.066	0.08	-0.12
Hotspot	LTE Band66	132322	1745	1RB-Mid	Right	10mm	\	21.94	22.5	<0.01	<0.01	<0.01	<0.01	\
Hotspot	LTE Band66	132322	1745	1RB-Mid	Bottom	10mm	A.24	21.94	22.5	0.531	0.60	0.304	0.35	-0.16
Hotspot	LTE Band66	132322	1745	50RB-Low	Front	10mm	\	20.98	21.5	0.14	0.16	0.092	0.10	0.12
Hotspot	LTE Band66	132322	1745	50RB-Low	Rear	10mm	\	20.98	21.5	0.379	0.43	0.232	0.26	-0.05
Hotspot	LTE Band66	132322	1745	50RB-Low	Left	10mm	\	20.98	21.5	0.085	0.10	0.054	0.06	0.16
Hotspot	LTE Band66	132322	1745	50RB-Low	Right	10mm	\	20.98	21.5	<0.01	<0.01	<0.01	<0.01	\
Hotspot	LTE Band66	132322	1745	50RB-Low	Bottom	10mm	\	20.98	21.5	0.419	0.47	0.242	0.27	0.05

14.2 SAR Evaluation for 2.4GWIFI/BT

The maximum output power specified for production units are determined for all applicable 802.11 transmission modes in each standalone and aggregated frequency band. Maximum output power is measured for the highest maximum output power configuration(s) in each frequency band according to the default power measurement procedures.

When the same transmission mode configurations have the same maximum output power on the same channel for the 802.11 a/g/n/ac/ax modes, the channel in the lower order/sequence 802.11 mode (i.e. a, g, n ac then ax) is selected.

SAR Test reduction was applied from KDB 248227 guidance, when the same maximum power is specified for multiple transmission modes in a frequency band, the largest channel bandwidth, lowest order modulation, lowest data rate and lowest order 802.11a/g/n/ac mode is used for SAR measurement, on the highest measured output power channel in the initial test configuration, for each frequency band. Additional output power measurements were not deemed necessary.

Duty factor plot

CH1

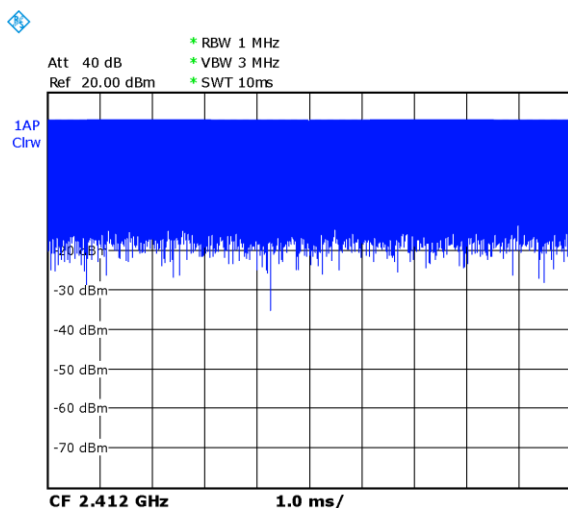

CH6

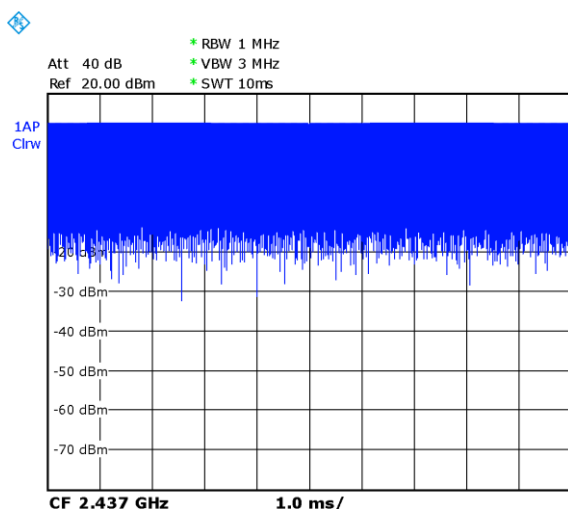

CH11

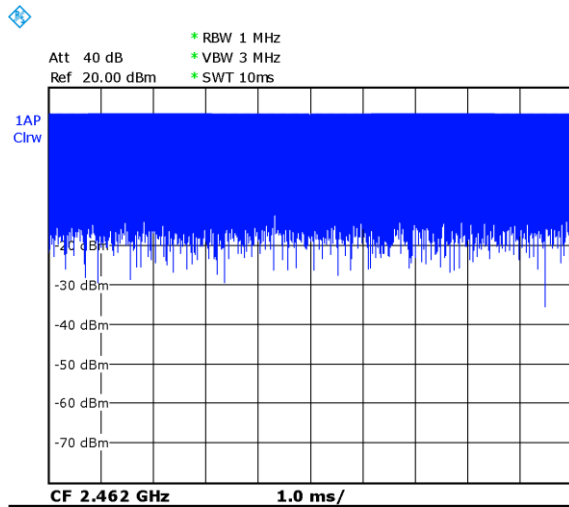

WLAN 2.4G

S2: SIM2

S3: Single SIM card slot

Test Position	Frequency Band	Channel Number	Frequency (MHz)	Mode/RB	Test Position	Distance	Figure No./Note	EUT Measured Power (dBm)	Tune up (dBm)	Duty Cycle	Measured SAR 1g (W/kg)	Reported SAR 1g (W/kg)	Measured SAR 10g (W/kg)	Reported SAR 10g (W/kg)	Power Drift
Head	WLAN 2.4G	11	2462	11b	Cheek Left	0mm	\	19.31	19.5	100%	0.759	0.79	0.331	0.35	0.03
Head	WLAN 2.4G	11	2462	11b	Tilt Left	0mm	A.25	19.31	19.5	100%	0.971	1.01	0.399	0.42	0.12
Head	WLAN 2.4G	6	2437	11b	Tilt Left	0mm	\	19.20	19.5	100%	0.923	0.99	0.351	0.38	0.03
Head	WLAN 2.4G	1	2412	11b	Tilt Left	0mm	\	19.19	19.5	100%	0.933	1.00	0.357	0.38	0.01
Head	WLAN 2.4G	11	2462	11b	Cheek Right	0mm	\	19.31	19.5	100%	0.408	0.43	0.179	0.19	-0.06
Head	WLAN 2.4G	11	2462	11b	Tilt Right	0mm	\	19.31	19.5	100%	0.476	0.50	0.212	0.22	0.15
Head	WLAN 2.4G	11	2462	11b	Tilt Left	0mm	S2	19.31	19.5	100%	0.916	0.96	0.378	0.39	0.04
Head	WLAN 2.4G	11	2462	11b	Tilt Left	0mm	S3	19.31	19.5	100%	0.922	0.96	0.386	0.40	-0.03
Body	WLAN 2.4G	11	2462	11b	Front	10mm	\	19.31	19.5	100%	0.216	0.23	0.111	0.12	-0.19
Body	WLAN 2.4G	11	2462	11b	Rear	10mm	A.26	19.31	19.5	100%	0.475	0.50	0.210	0.22	-0.04
Body	WLAN 2.4G	11	2462	11b	Right	10mm	\	19.31	19.5	100%	0.091	0.10	0.048	0.05	-0.04
Body	WLAN 2.4G	11	2462	11b	Top	10mm	\	19.31	19.5	100%	0.428	0.45	0.201	0.21	-0.01

BT

RF Exposure Conditions	Frequency Band	Channel Number	Frequency (MHz)	Mode/RB	Test Position	Distance	Figure No./Note	EUT Measured Power (dBm)	Tune up (dBm)	Measured SAR 1g (W/kg)	Reported SAR 1g (W/kg)	Measured SAR 10g (W/kg)	Reported SAR 10g (W/kg)	Power Drift
Head	BT	78	2480	GFSK	Cheek Left	0mm	\	9.66	10	0.026	0.03	0.011	0.01	-0.09
Head	BT	78	2480	GFSK	Tilt Left	0mm	A.27	9.66	10	0.035	0.04	0.014	0.02	0.11
Head	BT	78	2480	GFSK	Cheek Right	0mm	\	9.66	10	0.012	0.01	0.006	0.01	0.04
Head	BT	78	2480	GFSK	Tilt Right	0mm	\	9.66	10	0.021	0.02	0.009	0.01	-0.13
Body	BT	78	2480	GFSK	Front	10mm	\	9.66	10	<0.01	<0.01	<0.01	<0.01	\
Body	BT	78	2480	GFSK	Rear	10mm	A.28	9.66	10	0.0233	0.03	0.010	0.01	0.13
Body	BT	78	2480	GFSK	Right	10mm	\	9.66	10	<0.01	<0.01	<0.01	<0.01	\
Body	BT	78	2480	GFSK	Top	10mm	\	9.66	10	<0.01	<0.01	<0.01	<0.01	\

14.3 SAR Evaluation For WIFI 5G

The maximum output power specified for production units are determined for all applicable 802.11 transmission modes in each standalone and aggregated frequency band. Maximum output power is measured for the highest maximum output power configuration(s) in each frequency band according to the default power measurement procedures.

When the same transmission mode configurations have the same maximum output power on the same channel for the 802.11 a/g/n/ac/ax modes, the channel in the lower order/sequence 802.11 mode (i.e. a, g, n ac then ax) is selected.

SAR Test reduction was applied from KDB 248227 guidance, when the same maximum power is specified for multiple transmission modes in a frequency band, the largest channel bandwidth, lowest order modulation, lowest data rate and lowest order 802.11a/g/n/ac mode is used for SAR measurement, on the highest measured output power channel in the initial test configuration, for each frequency band. Additional output power measurements were not deemed necessary.

Duty factor plot

CH64

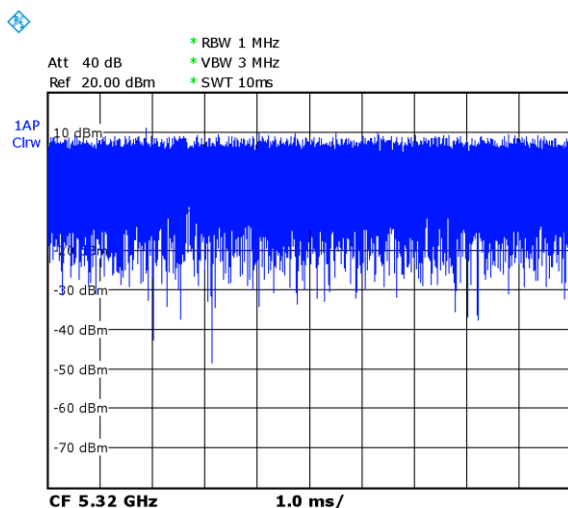

CH136

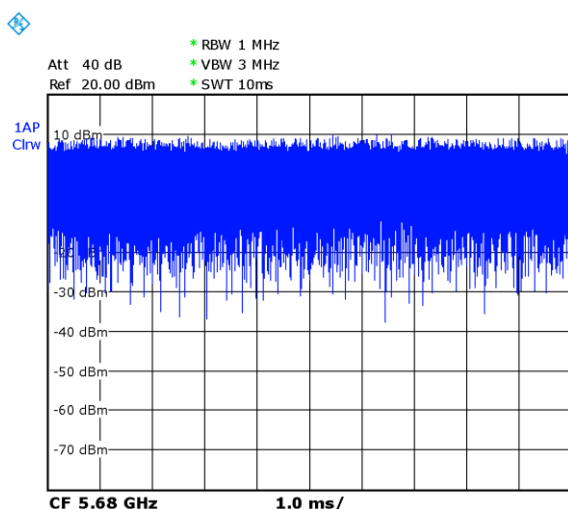

CH161

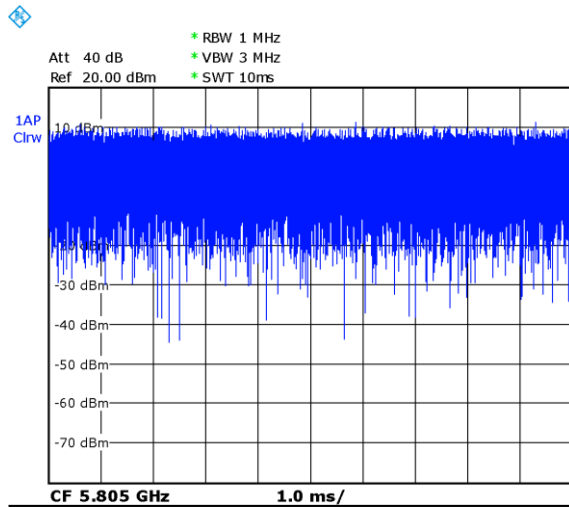

WLAN 5G

Test Position	Frequency Band	Channel Number	Frequency (MHz)	Mode/RB	Test Position	Distance	Figure No./Note	EUT Measured Power (dBm)	Tune up (dBm)	Duty Cycle	Measured SAR 1g (W/kg)	Reported SAR 1g (W/kg)	Measured SAR 10g (W/kg)	Reported SAR 10g (W/kg)	Power Drift
Head	WLAN 5G	64	5320	11a	Cheek Left	0mm	\	15.02	15.5	100%	0.189	0.21	0.066	0.07	0.12
Head	WLAN 5G	64	5320	11a	Tilt Left	0mm	\	15.02	15.5	100%	0.269	0.30	0.089	0.10	0.08
Head	WLAN 5G	64	5320	11a	Cheek Right	0mm	\	15.02	15.5	100%	0.130	0.15	0.043	0.05	0.12
Head	WLAN 5G	64	5320	11a	Tilt Right	0mm	\	15.02	15.5	100%	0.195	0.22	0.064	0.07	-0.02
Head	WLAN 5G	136	5680	11a	Cheek Left	0mm	\	14.83	15.5	100%	0.181	0.21	0.058	0.07	-0.12
Head	WLAN 5G	136	5680	11a	Tilt Left	0mm	\	14.83	15.5	100%	0.260	0.30	0.085	0.10	0.15
Head	WLAN 5G	136	5680	11a	Cheek Right	0mm	\	14.83	15.5	100%	0.109	0.13	0.038	0.04	0.16
Head	WLAN 5G	136	5680	11a	Tilt Right	0mm	\	14.83	15.5	100%	0.151	0.18	0.049	0.06	-0.13
Head	WLAN 5G	161	5825	11a	Cheek Left	0mm	\	14.93	15.5	100%	0.223	0.25	0.073	0.08	-0.04
Head	WLAN 5G	161	5825	11a	Tilt Left	0mm	A.29	14.93	15.5	100%	0.305	0.35	0.095	0.11	0.05
Head	WLAN 5G	161	5825	11a	Cheek Right	0mm	\	14.93	15.5	100%	0.166	0.19	0.052	0.06	0.08
Head	WLAN 5G	161	5825	11a	Tilt Right	0mm	\	14.93	15.5	100%	0.246	0.28	0.074	0.08	0.17
Body	WLAN 5G	64	5320	11a	Front	10mm	\	15.02	15.5	100%	0.059	0.07	0.022	0.02	0.02
Body	WLAN 5G	64	5320	11a	Rear	10mm	\	15.02	15.5	100%	0.408	0.46	0.147	0.16	0.14
Body	WLAN 5G	64	5320	11a	Right	10mm	\	15.02	15.5	100%	0.050	0.06	0.022	0.02	-0.07
Body	WLAN 5G	64	5320	11a	Top	10mm	\	15.02	15.5	100%	0.296	0.33	0.107	0.12	0.11
Body	WLAN 5G	136	5680	11a	Front	10mm	\	14.83	15.5	100%	0.098	0.11	0.022	0.03	-0.13
Body	WLAN 5G	136	5680	11a	Rear	10mm	\	14.83	15.5	100%	0.528	0.62	0.184	0.21	0.02
Body	WLAN 5G	136	5680	11a	Right	10mm	\	14.83	15.5	100%	0.089	0.10	0.022	0.03	0.18
Body	WLAN 5G	136	5680	11a	Top	10mm	\	14.83	15.5	100%	0.343	0.40	0.117	0.14	0.01
Body	WLAN 5G	161	5825	11a	Front	10mm	\	14.93	15.5	100%	0.072	0.08	0.020	0.02	-0.18
Body	WLAN 5G	161	5825	11a	Rear	10mm	A.30	14.93	15.5	100%	0.666	0.76	0.229	0.26	0.09
Body	WLAN 5G	161	5825	11a	Right	10mm	\	14.93	15.5	100%	0.068	0.08	0.028	0.03	0.04
Body	WLAN 5G	161	5825	11a	Top	10mm	\	14.93	15.5	100%	0.420	0.48	0.146	0.17	0.08

15 SAR Measurement Variability

SAR measurement variability must be assessed for each frequency band, which is determined by the SAR probe calibration point and tissue-equivalent medium used for the device measurements. When both head and body tissue-equivalent media are required for SAR measurements in a frequency band, the variability measurement procedures should be applied to the tissue medium with the highest measured SAR, using the highest measured SAR configuration for that tissue-equivalent medium.

The following procedures are applied to determine if repeated measurements are required.

- 1) Repeated measurement is not required when the original highest measured SAR is < 0.80 W/kg; steps 2) through 4) do not apply.
- 2) When the original highest measured SAR is ≥ 0.80 W/kg, repeat that measurement once.
- 3) Perform a second repeated measurement only if the ratio of largest to smallest SAR for the original and first repeated measurements is > 1.20 or when the original or repeated measurement is ≥ 1.45 W/kg ($\sim 10\%$ from the 1-g SAR limit).
- 4) Perform a third repeated measurement only if the original, first or second repeated measurement is ≥ 1.5 W/kg and the ratio of largest to smallest SAR for the original, first and second repeated measurements is > 1.20

Mode	CH	Freq	Test Position		Original SAR(W/kg)	First Repeated SAR(W/kg)	The Ratio
WCDMA1700	1413	1732.6	Bottom	10mm	0.858	0.841	1.02
WCDMA1700	1312	1712.4	Bottom	10mm	0.946	0.912	1.04
WIFI2.4G	11	2462	Tilt Left	0mm	0.971	0.962	1.01
WIFI2.4G	6	2437	Tilt Left	0mm	0.923	0.907	1.02
WIFI2.4G	1	2412	Tilt Left	0mm	0.933	0.922	1.01

16 Measurement Uncertainty

16.1 Measurement Uncertainty for Normal SAR Tests (300MHz~3GHz)

No.	Error Description	Type	Uncertainty value	Probably Distribution	Div.	(Ci) 1g	(Ci) 10g	Std. Unc. (1g)	Std. Unc. (10g)	Degree of freedom
Measurement system										
1	Probe calibration	B	6.0	N	1	1	1	6.0	6.0	∞
2	Isotropy	B	4.7	R	$\sqrt{3}$	0.7	0.7	1.9	1.9	∞
3	Boundary effect	B	1.0	R	$\sqrt{3}$	1	1	0.6	0.6	∞
4	Linearity	B	4.7	R	$\sqrt{3}$	1	1	2.7	2.7	∞
5	Detection limit	B	1.0	N	1	1	1	0.6	0.6	∞
6	Readout electronics	B	0.3	R	$\sqrt{3}$	1	1	0.3	0.3	∞
7	Response time	B	0.8	R	$\sqrt{3}$	1	1	0.5	0.5	∞
8	Integration time	B	2.6	R	$\sqrt{3}$	1	1	1.5	1.5	∞
9	RF ambient conditions-noise	B	0	R	$\sqrt{3}$	1	1	0	0	∞
10	RF ambient conditions-reflection	B	0	R	$\sqrt{3}$	1	1	0	0	∞
11	Probe positioned mech. restrictions	B	0.4	R	$\sqrt{3}$	1	1	0.2	0.2	∞
12	Probe positioning with respect to phantom shell	B	2.9	R	$\sqrt{3}$	1	1	1.7	1.7	∞
13	Post-processing	B	1.0	R	$\sqrt{3}$	1	1	0.6	0.6	∞
Test sample related										
14	Test sample positioning	A	3.3	N	1	1	1	3.3	3.3	71
15	Device holder uncertainty	A	3.4	N	1	1	1	3.4	3.4	5
16	Drift of output power	B	5.0	R	$\sqrt{3}$	1	1	2.9	2.9	∞
Phantom and set-up										
17	Phantom uncertainty	B	4.0	R	$\sqrt{3}$	1	1	2.3	2.3	∞
18	Liquid conductivity (target)	B	5.0	R	$\sqrt{3}$	0.64	0.43	1.8	1.2	∞
19	Liquid conductivity (meas.)	A	2.06	N	1	0.64	0.43	1.32	0.89	43
20	Liquid permittivity (target)	B	5.0	R	$\sqrt{3}$	0.6	0.49	1.7	1.4	∞
21	Liquid permittivity (meas.)	A	1.6	N	1	0.6	0.49	1.0	0.8	521

Combined standard uncertainty	$u_c = \sqrt{\sum_{i=1}^{21} c_i^2 u_i^2}$							9.55	9.43	257
Expanded uncertainty (confidence interval of 95 %)	$u_e = 2u_c$							19.1	18.9	

16.2 Measurement Uncertainty for Normal SAR Tests (3~6GHz)

No.	Error Description	Type	Uncertainty value	Probably Distribution	Div.	(Ci) 1g	(Ci) 10g	Std. Unc. (1g)	Std. Unc. (10g)	Degree of freedom
Measurement system										
1	Probe calibration	B	6.55	N	1	1	1	6.55	6.55	∞
2	Isotropy	B	4.7	R	$\sqrt{3}$	0.7	0.7	1.9	1.9	∞
3	Boundary effect	B	2.0	R	$\sqrt{3}$	1	1	1.2	1.2	∞
4	Linearity	B	4.7	R	$\sqrt{3}$	1	1	2.7	2.7	∞
5	Detection limit	B	1.0	R	$\sqrt{3}$	1	1	0.6	0.6	∞
6	Readout electronics	B	0.3	R	$\sqrt{3}$	1	1	0.3	0.3	∞
7	Response time	B	0.8	R	$\sqrt{3}$	1	1	0.5	0.5	∞
8	Integration time	B	2.6	R	$\sqrt{3}$	1	1	1.5	1.5	∞
9	RF ambient conditions-noise	B	0	R	$\sqrt{3}$	1	1	0	0	∞
10	RFambient conditions-reflection	B	0	R	$\sqrt{3}$	1	1	0	0	∞
11	Probe positioned mech. restrictions	B	0.8	R	$\sqrt{3}$	1	1	0.5	0.5	∞
12	Probe positioning with respect to phantom shell	B	6.7	R	$\sqrt{3}$	1	1	3.9	3.9	∞
13	Post-processing	B	4.0	R	$\sqrt{3}$	1	1	2.3	2.3	∞
Test sample related										
14	Test sample positioning	A	3.3	N	1	1	1	3.3	3.3	71
15	Device holder uncertainty	A	3.4	N	1	1	1	3.4	3.4	5
16	Drift of output power	B	5.0	R	$\sqrt{3}$	1	1	2.9	2.9	∞
Phantom and set-up										
17	Phantom uncertainty	B	4.0	R	$\sqrt{3}$	1	1	2.3	2.3	∞
18	Liquid conductivity (target)	B	5.0	R	$\sqrt{3}$	0.64	0.43	1.8	1.2	∞
19	Liquid conductivity (meas.)	A	2.06	N	1	0.64	0.43	1.32	0.89	43
20	Liquid permittivity (target)	B	5.0	R	$\sqrt{3}$	0.6	0.49	1.7	1.4	∞

21	Liquid permittivity (meas.)	A	1.6	N	1	0.6	0.49	1.0	0.8	521
Combined standard uncertainty		$u_c' = \sqrt{\sum_{i=1}^{21} c_i^2 u_i^2}$						10.7	10.6	257
Expanded uncertainty (confidence interval of 95 %)		$u_e = 2u_c$						21.4	21.1	

16.3 Measurement Uncertainty for Fast SAR Tests (300MHz~3GHz)

No.	Error Description	Type	Uncertainty value	Probably Distribution	Div.	(Ci) 1g	(Ci) 10g	Std. Unc. (1g)	Std. Unc. (10g)	Degree of freedom
Measurement system										
1	Probe calibration	B	6.0	N	1	1	1	6.0	6.0	∞
2	Isotropy	B	4.7	R	$\sqrt{3}$	0.7	0.7	1.9	1.9	∞
3	Boundary effect	B	1.0	R	$\sqrt{3}$	1	1	0.6	0.6	∞
4	Linearity	B	4.7	R	$\sqrt{3}$	1	1	2.7	2.7	∞
5	Detection limit	B	1.0	R	$\sqrt{3}$	1	1	0.6	0.6	∞
6	Readout electronics	B	0.3	R	$\sqrt{3}$	1	1	0.3	0.3	∞
7	Response time	B	0.8	R	$\sqrt{3}$	1	1	0.5	0.5	∞
8	Integration time	B	2.6	R	$\sqrt{3}$	1	1	1.5	1.5	∞
9	RF ambient conditions-noise	B	0	R	$\sqrt{3}$	1	1	0	0	∞
10	RFambient conditions-reflection	B	0	R	$\sqrt{3}$	1	1	0	0	∞
11	Probe positioned mech. Restrictions	B	0.4	R	$\sqrt{3}$	1	1	0.2	0.2	∞
12	Probe positioning with respect to phantom shell	B	2.9	R	$\sqrt{3}$	1	1	1.7	1.7	∞
13	Post-processing	B	1.0	R	$\sqrt{3}$	1	1	0.6	0.6	∞
14	Fast SAR z-Approximation	B	7.0	R	$\sqrt{3}$	1	1	4.0	4.0	∞
Test sample related										
15	Test sample positioning	A	3.3	N	1	1	1	3.3	3.3	71
16	Device holder uncertainty	A	3.4	N	1	1	1	3.4	3.4	5
17	Drift of output power	B	5.0	R	$\sqrt{3}$	1	1	2.9	2.9	∞
Phantom and set-up										
18	Phantom uncertainty	B	4.0	R	$\sqrt{3}$	1	1	2.3	2.3	∞
19	Liquid conductivity (target)	B	5.0	R	$\sqrt{3}$	0.64	0.43	1.8	1.2	∞

20	Liquid conductivity (meas.)	A	2.06	N	1	0.64	0.43	1.32	0.89	43
21	Liquid permittivity (target)	B	5.0	R	$\sqrt{3}$	0.6	0.49	1.7	1.4	∞
22	Liquid permittivity (meas.)	A	1.6	N	1	0.6	0.49	1.0	0.8	521
Combined standard uncertainty		$u_c = \sqrt{\sum_{i=1}^{22} c_i^2 u_i^2}$						10.4	10.3	257
Expanded uncertainty (confidence interval of 95 %)		$u_e = 2u_c$						20.8	20.6	

16.4 Measurement Uncertainty for Fast SAR Tests (3~6GHz)

No.	Error Description	Type	Uncertainty value	Probably Distribution	Div.	(Ci) 1g	(Ci) 10g	Std. Unc. (1g)	Std. Unc. (10g)	Degree of freedom
Measurement system										
1	Probe calibration	B	6.55	N	1	1	1	6.55	6.55	∞
2	Isotropy	B	4.7	R	$\sqrt{3}$	0.7	0.7	1.9	1.9	∞
3	Boundary effect	B	2.0	R	$\sqrt{3}$	1	1	1.2	1.2	∞
4	Linearity	B	4.7	R	$\sqrt{3}$	1	1	2.7	2.7	∞
5	Detection limit	B	1.0	R	$\sqrt{3}$	1	1	0.6	0.6	∞
6	Readout electronics	B	0.3	R	$\sqrt{3}$	1	1	0.3	0.3	∞
7	Response time	B	0.8	R	$\sqrt{3}$	1	1	0.5	0.5	∞
8	Integration time	B	2.6	R	$\sqrt{3}$	1	1	1.5	1.5	∞
9	RF ambient conditions-noise	B	0	R	$\sqrt{3}$	1	1	0	0	∞
10	RFambient conditions-reflection	B	0	R	$\sqrt{3}$	1	1	0	0	∞
11	Probe positioned mech. Restrictions	B	0.8	R	$\sqrt{3}$	1	1	0.5	0.5	∞
12	Probe positioning with respect to phantom shell	B	6.7	R	$\sqrt{3}$	1	1	3.9	3.9	∞
13	Post-processing	B	1.0	R	$\sqrt{3}$	1	1	0.6	0.6	∞
14	Fast SAR z-Approximation	B	14.0	R	$\sqrt{3}$	1	1	8.1	8.1	∞
Test sample related										
15	Test sample positioning	A	3.3	N	1	1	1	3.3	3.3	71
16	Device holder uncertainty	A	3.4	N	1	1	1	3.4	3.4	5

17	Drift of output power	B	5.0	R	$\sqrt{3}$	1	1	2.9	2.9	∞
Phantom and set-up										
18	Phantom uncertainty	B	4.0	R	$\sqrt{3}$	1	1	2.3	2.3	∞
19	Liquid conductivity (target)	B	5.0	R	$\sqrt{3}$	0.64	0.43	1.8	1.2	∞
20	Liquid conductivity (meas.)	A	2.06	N	1	0.64	0.43	1.32	0.89	43
21	Liquid permittivity (target)	B	5.0	R	$\sqrt{3}$	0.6	0.49	1.7	1.4	∞
22	Liquid permittivity (meas.)	A	1.6	N	1	0.6	0.49	1.0	0.8	521
Combined standard uncertainty		$u_c = \sqrt{\sum_{i=1}^{22} c_i^2 u_i^2}$						13.5	13.4	257
Expanded uncertainty (confidence interval of 95 %)		$u_e = 2u_c$						27.0	26.8	

17 MAIN TEST INSTRUMENTS

Table 17.1: List of Main Instruments

No.	Name	Type	Serial Number	Calibration Date	Valid Period
01	Network analyzer	E5071C	MY46110673	January 14, 2022	One year
02	Power sensor	NRP110T	101139	January 13, 2022	One year
03	Power sensor	NRP110T	101159	January 13, 2022	
04	Signal Generator	E4438C	MY49071430	January 13, 2022	One Year
05	Amplifier	60S1G4	0331848	No Calibration Requested	
06	BTS	CMW500	129942	February 14, 2022	One year
07	E-field Probe	SPEAG EX3DV4	7517	January 19, 2022	One year
08	DAE	SPEAG DAE4	1525	September 1, 2021	One year
09	Dipole Validation Kit	SPEAG D750V3	1017	July 12,,2021	One year
10	Dipole Validation Kit	SPEAG D835V2	4d069	July 21,,2021	One year
11	Dipole Validation Kit	SPEAG D1750V2	1003	July 12,,2021	One year
12	Dipole Validation Kit	SPEAG D1900V2	5d101	July 15,2021	One year
13	Dipole Validation Kit	SPEAG D2450V2	853	July 26,2021	One year
14	Dipole Validation Kit	SPEAG D2600V2	1012	July 26,2021	One year
15	Dipole Validation Kit	SPEAG D5GHzV2	1060	June 22,2021	One year

END OF REPORT BODY



Appendixes

Refer to separated files for the following appendixes

ANNEX A Graph Results

ANNEX B System Verification Results

ANNEX C SAR Measurement Setup

ANNEX D Position of the wireless device in relation to the phantom

ANNEX E Equivalent Media Recipes

ANNEX F System Validation

ANNEX G Probe Calibration Certificate

ANNEX H Dipole Calibration Certificate

ANNEX I Accreditation Certificate

ANNEX A Graph Results

GSM850 Head

Date/Time: 6/4/2022

Electronics: DAE4 Sn1525

Medium: H700-6000M

Medium parameters used (interpolated): $f = 848.8$ MHz; $\sigma = 0.94$ S/m; $\epsilon_r = 44.09$; $\rho = 1000$ kg/m³

Ambient Temperature: 23.3°C Liquid Temperature: 22.5°C

Communication System: UID 0, GSM 850 (0) Frequency: 848.8 MHz Duty Cycle: 1:8.30042

Probe: EX3DV4 - SN7517 ConvF(9.7, 9.7, 9.7); Calibrated: 1/19/2022

Area Scan (81x151x1): Interpolated grid: dx=1.500 mm, dy=1.500 mm

Maximum value of SAR (interpolated) = 0.307 W/kg

Zoom Scan (5x5x7)/Cube 0: Measurement grid: dx=8mm, dy=8mm, dz=5mm

Reference Value = 5.015 V/m; Power Drift = 0.09 dB

Peak SAR (extrapolated) = 0.347 W/kg

SAR(1 g) = 0.255 W/kg; SAR(10 g) = 0.194 W/kg

Maximum value of SAR (measured) = 0.309 W/kg

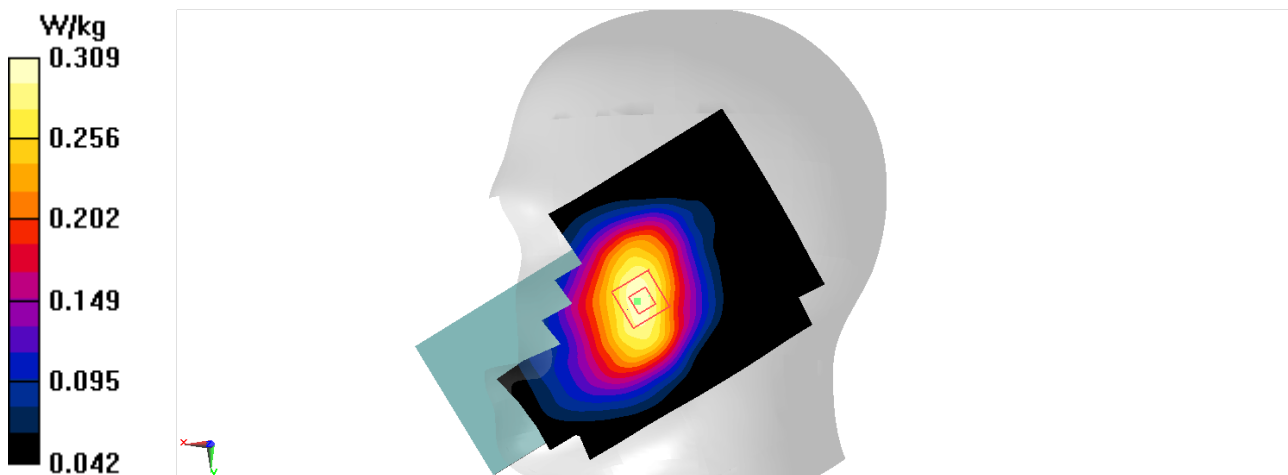

GSM1900 Head

Date/Time: 6/8/2022

Electronics: DAE4 Sn1525

Medium: H700-6000M

Medium parameters used: $f = 1880 \text{ MHz}$; $\sigma = 1.481 \text{ S/m}$; $\epsilon_r = 41.748$; $\rho = 1000 \text{ kg/m}^3$

Ambient Temperature: 23.3°C Liquid Temperature: 22.5°C

Communication System: UID 0, GSM 1900 (0) Frequency: 1880 MHz Duty Cycle: 1:8.30042

Probe: EX3DV4 - SN7517 ConvF(7.74, 7.74, 7.74); Calibrated: 1/19/2022

Area Scan (81x151x1): Interpolated grid: $dx=1.500 \text{ mm}$, $dy=1.500 \text{ mm}$

Maximum value of SAR (interpolated) = 0.105 W/kg

Zoom Scan (5x5x7)/Cube 0: Measurement grid: $dx=8\text{mm}$, $dy=8\text{mm}$, $dz=5\text{mm}$

Reference Value = 2.251 V/m ; Power Drift = -0.09 dB

Peak SAR (extrapolated) = 0.122 W/kg

SAR(1 g) = 0.076 W/kg ; SAR(10 g) = 0.048 W/kg

Maximum value of SAR (measured) = 0.104 W/kg

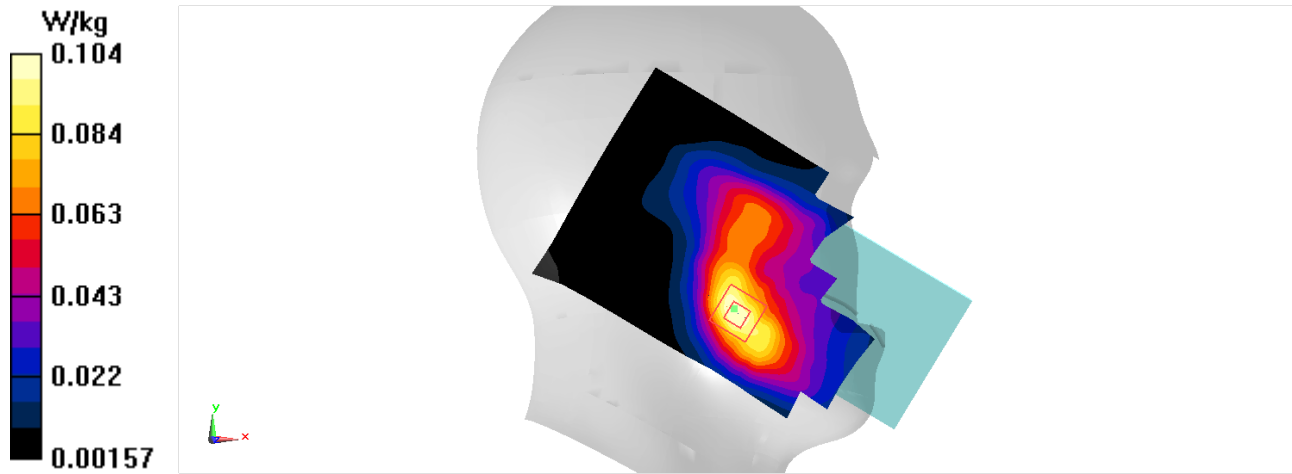

W1900 Head

Date/Time: 6/8/2022

Electronics: DAE4 Sn1525

Medium: H700-6000M

Medium parameters used (interpolated): $f = 1907.6$ MHz; $\sigma = 1.501$ S/m; $\epsilon_r = 41.677$; $\rho = 1000$ kg/m³

Ambient Temperature: 23.3°C Liquid Temperature: 22.5°C

Communication System: UID 0, WCDMA 1900 (0) Frequency: 1907.6 MHz Duty Cycle: 1:1

Probe: EX3DV4 - SN7517 ConvF(7.74, 7.74, 7.74); Calibrated: 1/19/2022

Area Scan (81x151x1): Interpolated grid: dx=1.500 mm, dy=1.500 mm

Maximum value of SAR (interpolated) = 0.154 W/kg

Zoom Scan (5x5x7)/Cube 0: Measurement grid: dx=8mm, dy=8mm, dz=5mm

Reference Value = 3.487 V/m; Power Drift = 0.08 dB

Peak SAR (extrapolated) = 0.177 W/kg

SAR(1 g) = 0.114 W/kg; SAR(10 g) = 0.073 W/kg

Maximum value of SAR (measured) = 0.151 W/kg

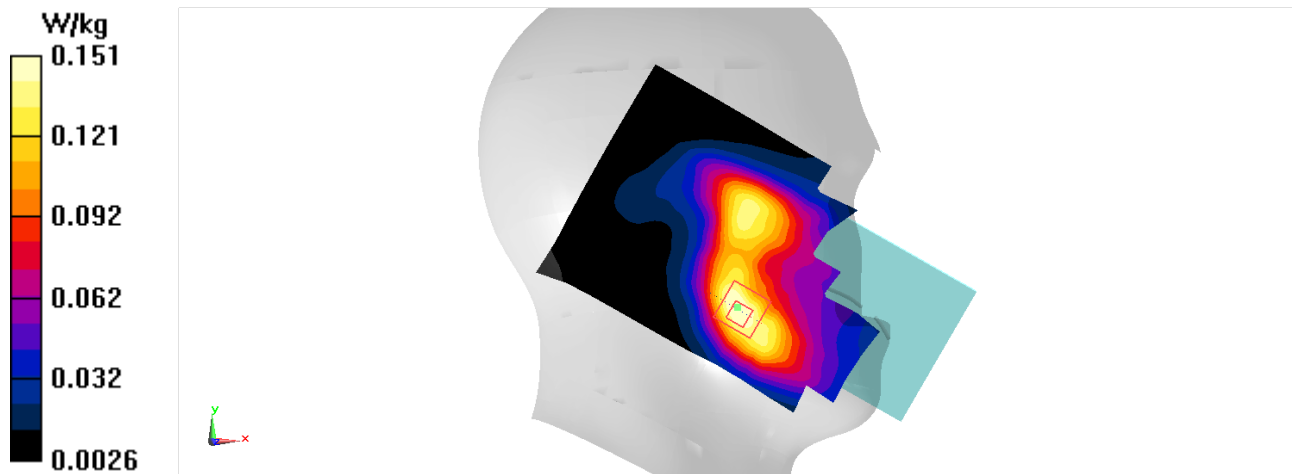

W1700 Head

Date/Time: 6/6/2022

Electronics: DAE4 Sn1525

Medium: H700-6000M

Medium parameters used (interpolated): $f = 1712.4$ MHz; $\sigma = 1.391$ S/m; $\epsilon_r = 41.856$; $\rho = 1000$ kg/m³

Ambient Temperature: 23.3°C Liquid Temperature: 22.5°C

Communication System: UID 0, WCDMA 1700 Band4 (0) Frequency: 1712.4 MHz Duty Cycle: 1:1

Probe: EX3DV4 - SN7517 ConvF(8.1, 8.1, 8.1); Calibrated: 1/19/2022

Area Scan (81x151x1): Interpolated grid: dx=1.500 mm, dy=1.500 mm

Maximum value of SAR (interpolated) = 0.236 W/kg

Zoom Scan (5x5x7)/Cube 0: Measurement grid: dx=8mm, dy=8mm, dz=5mm

Reference Value = 4.626 V/m; Power Drift = 0.01 dB

Peak SAR (extrapolated) = 0.258 W/kg

SAR(1 g) = 0.168 W/kg; SAR(10 g) = 0.110 W/kg

Maximum value of SAR (measured) = 0.221 W/kg

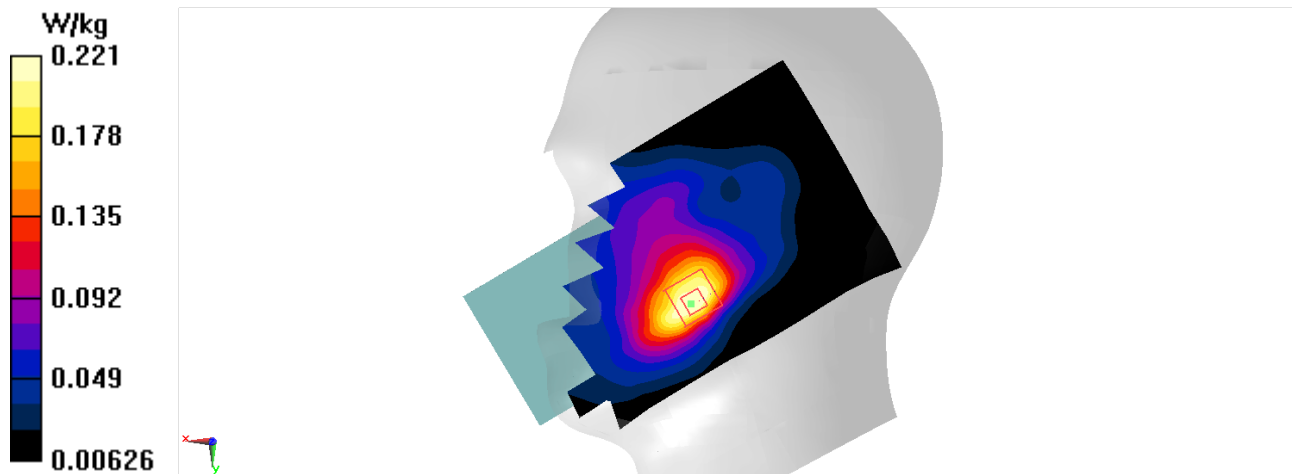

W850 Head

Date/Time: 6/4/2022

Electronics: DAE4 Sn1525

Medium: H700-6000M

Medium parameters used (interpolated): $f = 846.6$ MHz; $\sigma = 0.939$ S/m; $\epsilon_r = 44.083$; $\rho = 1000$ kg/m³

Ambient Temperature: 23.3°C Liquid Temperature: 22.5°C

Communication System: UID 0, WCDMA 850 (0) Frequency: 846.6 MHz Duty Cycle: 1:1

Probe: EX3DV4 - SN7517 ConvF(9.7, 9.7, 9.7); Calibrated: 1/19/2022

Area Scan (81x151x1): Interpolated grid: dx=1.500 mm, dy=1.500 mm

Maximum value of SAR (interpolated) = 0.272 W/kg

Zoom Scan (5x5x7)/Cube 0: Measurement grid: dx=8mm, dy=8mm, dz=5mm

Reference Value = 5.690 V/m; Power Drift = 0.14 dB

Peak SAR (extrapolated) = 0.317 W/kg

SAR(1 g) = 0.230 W/kg; SAR(10 g) = 0.176 W/kg

Maximum value of SAR (measured) = 0.280 W/kg

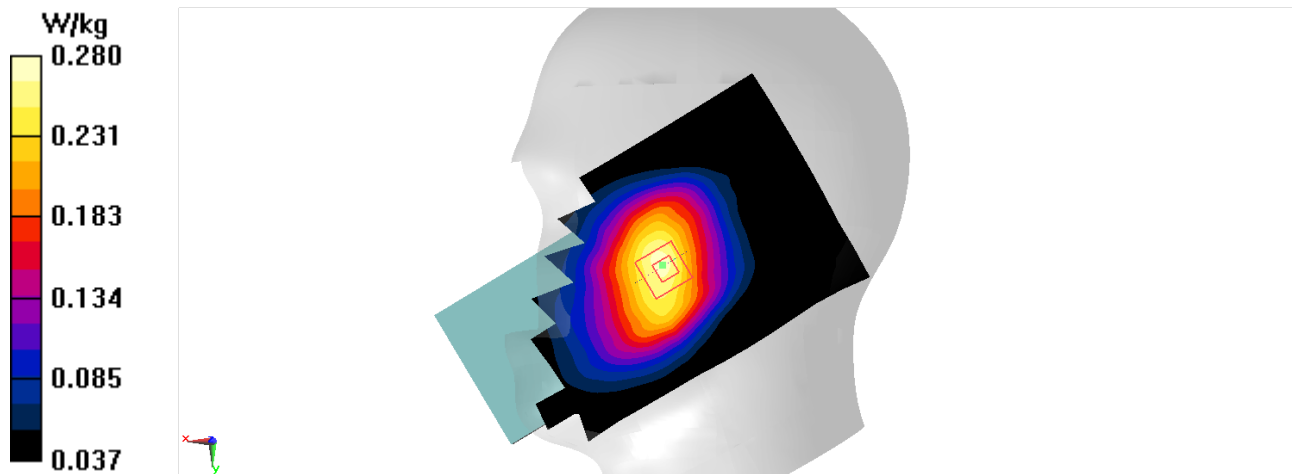

LTEBand2 Head

Date/Time: 6/8/2022

Electronics: DAE4 Sn1525

Medium: H700-6000M

Medium parameters used: $f = 1900$ MHz; $\sigma = 1.494$ S/m; $\epsilon_r = 41.692$; $\rho = 1000$ kg/m³

Ambient Temperature: 23.3°C Liquid Temperature: 22.5°C

Communication System: UID 0, LTE Band2(20MB) (0) Frequency: 1900 MHz Duty Cycle: 1:1

Probe: EX3DV4 - SN7517 ConvF(7.74, 7.74, 7.74); Calibrated: 1/19/2022

Area Scan (81x141x1): Interpolated grid: dx=1.500 mm, dy=1.500 mm

Maximum value of SAR (interpolated) = 0.113 W/kg

Zoom Scan (6x6x7)/Cube 0: Measurement grid: dx=8mm, dy=8mm, dz=5mm

Reference Value = 3.128 V/m; Power Drift = 0.01 dB

Peak SAR (extrapolated) = 0.138 W/kg

SAR(1 g) = 0.086 W/kg; SAR(10 g) = 0.055 W/kg

Maximum value of SAR (measured) = 0.119 W/kg

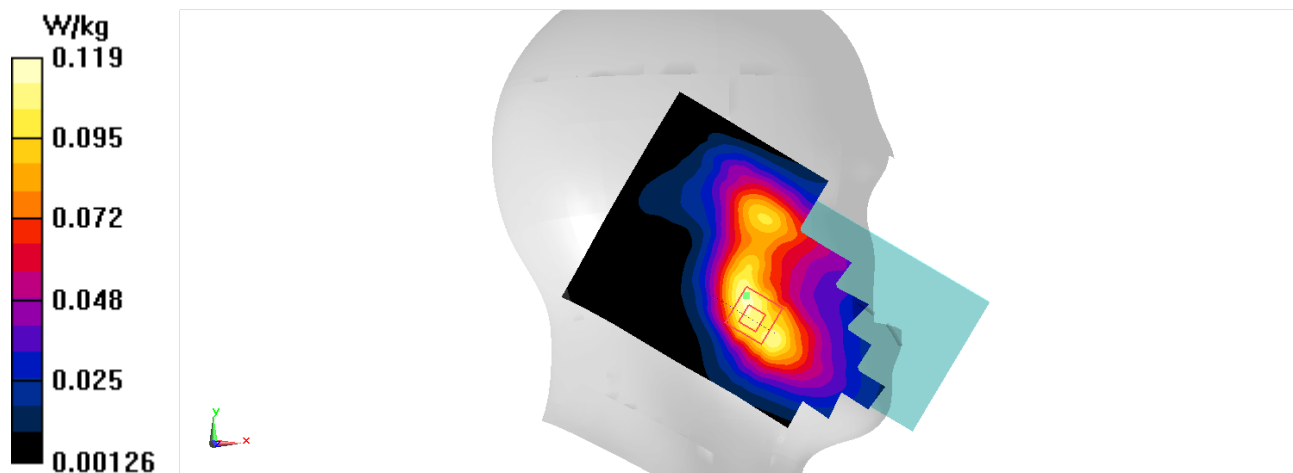

LTEBand7 Head

Date/Time: 6/12/2022

Electronics: DAE4 Sn1525

Medium: H700-6000M

Medium parameters used: $f = 2560$ MHz; $\sigma = 1.967$ S/m; $\epsilon_r = 40.804$; $\rho = 1000$ kg/m³

Ambient Temperature: 23.3°C Liquid Temperature: 22.5°C

Communication System: UID 0, LTE Band7-20M (0) Frequency: 2560 MHz Duty Cycle: 1:1

Probe: EX3DV4 - SN7517 ConvF(6.97, 6.97, 6.97); Calibrated: 1/19/2022

Area Scan (101x181x1): Interpolated grid: dx=1.200 mm, dy=1.200 mm

Maximum value of SAR (interpolated) = 0.396 W/kg

Zoom Scan (7x7x7)/Cube 0: Measurement grid: dx=5mm, dy=5mm, dz=5mm

Reference Value = 2.474 V/m; Power Drift = 0.06dB

Peak SAR (extrapolated) = 0.441 W/kg

SAR(1 g) = 0.241 W/kg; SAR(10 g) = 0.128 W/kg

Maximum value of SAR (measured) = 0.356 W/kg

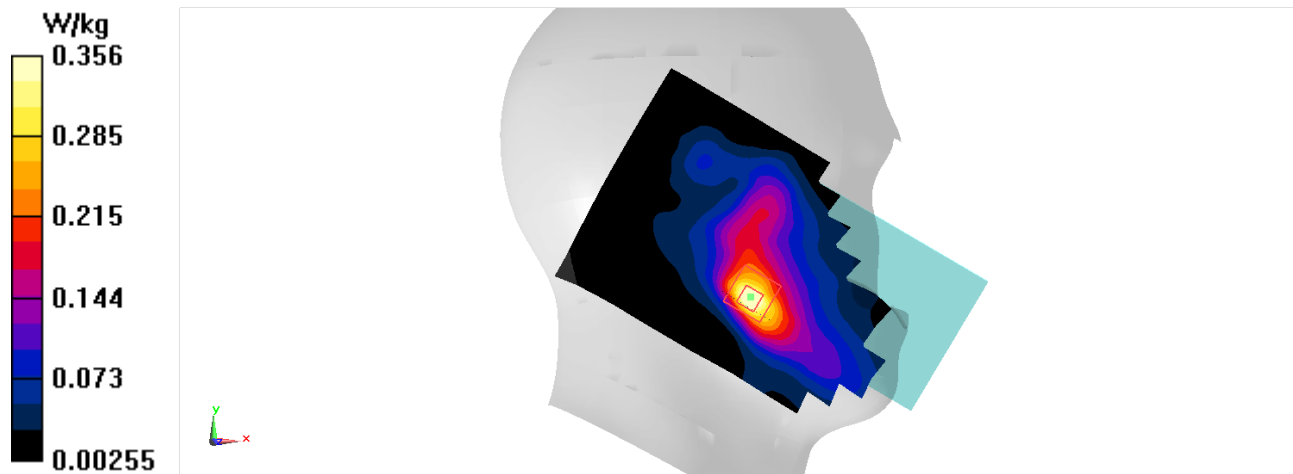

LTEBand12 Head

Date/Time: 6/2/2022

Electronics: DAE4 Sn1525

Medium: H700-6000M

Medium parameters used (interpolated): $f = 704$ MHz; $\sigma = 0.885$ S/m; $\epsilon_r = 44.41$; $\rho = 1000$ kg/m³

Ambient Temperature: 23.3°C Liquid Temperature: 22.5°C

Communication System: UID 0, LTE Band12 (0) Frequency: 704 MHz Duty Cycle: 1:1

Probe: EX3DV4 - SN7517 ConvF(9.7, 9.7, 9.7); Calibrated: 1/19/2022

Area Scan (81x151x1): Interpolated grid: dx=1.500 mm, dy=1.500 mm

Maximum value of SAR (interpolated) = 0.0946 W/kg

Zoom Scan (6x6x7)/Cube 0: Measurement grid: dx=8mm, dy=8mm, dz=5mm

Reference Value = 6.849 V/m; Power Drift = 0.02 dB

Peak SAR (extrapolated) = 0.105 W/kg

SAR(1 g) = 0.079 W/kg; SAR(10 g) = 0.062 W/kg

Maximum value of SAR (measured) = 0.0954 W/kg

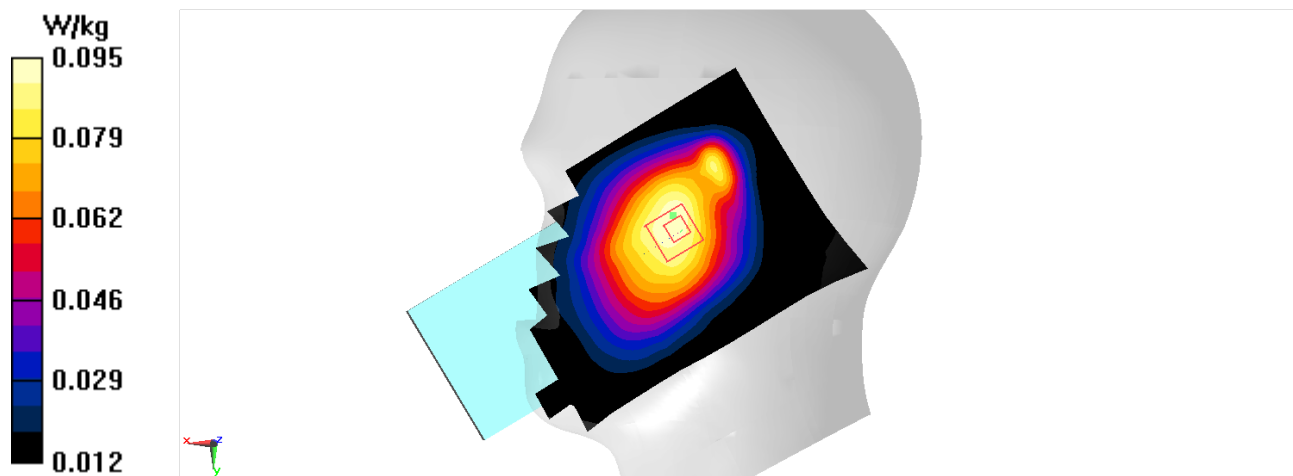

LTEBand13 Head

Date/Time: 6/2/2022

Electronics: DAE4 Sn1525

Medium: H700-6000M

Medium parameters used (interpolated): $f = 782 \text{ MHz}$; $\sigma = 0.913 \text{ S/m}$; $\epsilon_r = 44.238$; $\rho = 1000 \text{ kg/m}^3$

Ambient Temperature: 23.3°C Liquid Temperature: 22.5°C

Communication System: UID 0, LTE Band13 (0) Frequency: 782 MHz Duty Cycle: 1:1

Probe: EX3DV4 - SN7517 ConvF(9.7, 9.7, 9.7); Calibrated: 1/19/2022

Area Scan (81x151x1): Interpolated grid: $dx=1.500 \text{ mm}$, $dy=1.500 \text{ mm}$

Maximum value of SAR (interpolated) = 0.136 W/kg

Zoom Scan (6x5x7)/Cube 0: Measurement grid: $dx=8\text{mm}$, $dy=8\text{mm}$, $dz=5\text{mm}$

Reference Value = 7.110 V/m ; Power Drift = 0.09 dB

Peak SAR (extrapolated) = 0.153 W/kg

SAR(1 g) = 0.116 W/kg ; SAR(10 g) = 0.091 W/kg

Maximum value of SAR (measured) = 0.139 W/kg

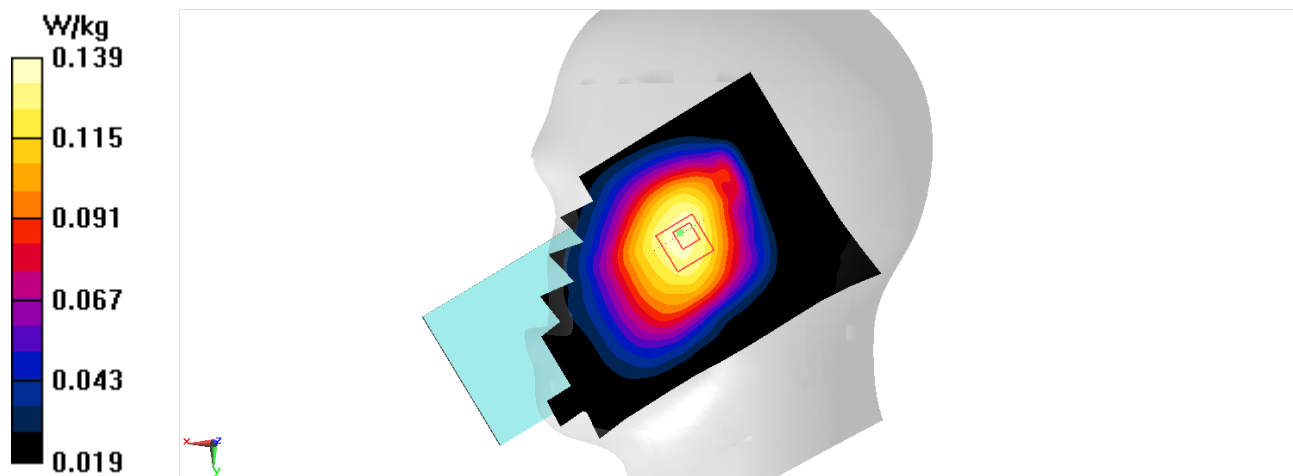

LTEBand26 Head

Date/Time: 6/4/2022

Electronics: DAE4 Sn1525

Medium: H700-6000M

Medium parameters used (interpolated): $f = 822.5$ MHz; $\sigma = 0.927$ S/m; $\epsilon_r = 44.007$; $\rho = 1000$ kg/m³

Ambient Temperature: 23.3°C Liquid Temperature: 22.5°C

Communication System: UID 0, LTE Band26 (0) Frequency: 822.5 MHz Duty Cycle: 1:1

Probe: EX3DV4 - SN7517 ConvF(9.7, 9.7, 9.7); Calibrated: 1/19/2022

Area Scan (101x181x1): Interpolated grid: dx=1.200 mm, dy=1.200 mm

Maximum value of SAR (interpolated) = 0.221 W/kg

Zoom Scan (7x7x7)/Cube 0: Measurement grid: dx=5mm, dy=5mm, dz=5mm

Reference Value = 3.752 V/m; Power Drift = 0.01 dB

Peak SAR (extrapolated) = 0.243 W/kg

SAR(1 g) = 0.178 W/kg; SAR(10 g) = 0.136 W/kg

Maximum value of SAR (measured) = 0.218 W/kg

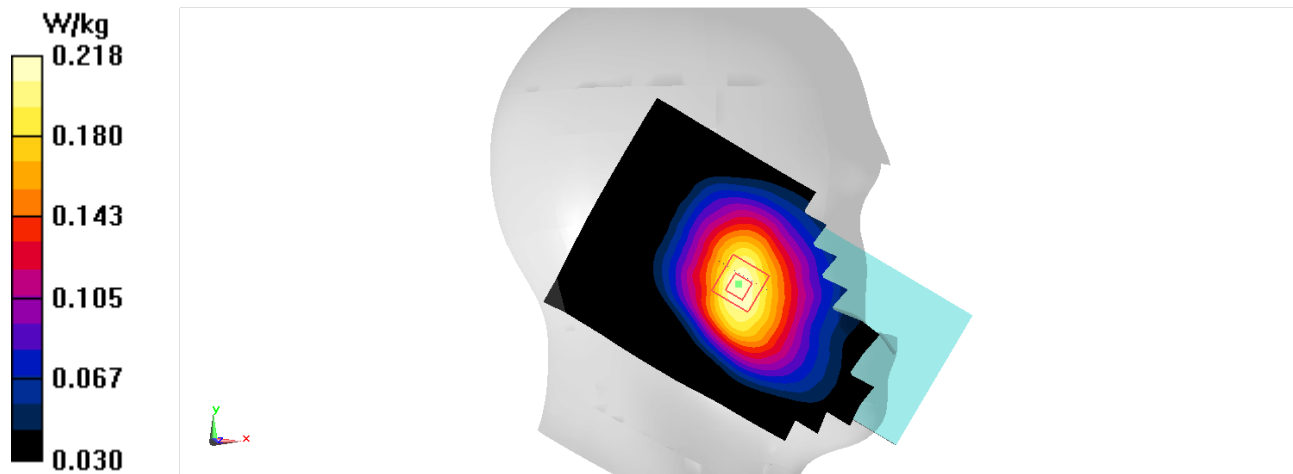

LTEBand41 Head

Date/Time: 6/12/2022

Electronics: DAE4 Sn1525

Medium: H700-6000M

Medium parameters used (interpolated): $f = 2593$ MHz; $\sigma = 1.981$ S/m; $\epsilon_r = 40.625$; $\rho = 1000$ kg/m³

Ambient Temperature: 23.3°C Liquid Temperature: 22.5°C

Communication System: UID 0, LTE Band41 PC3 (0) Frequency: 2593 MHz Duty Cycle: 1:1.5787

Probe: EX3DV4 - SN7517 ConvF(6.97, 6.97, 6.97); Calibrated: 1/19/2022

Area Scan (101x181x1): Interpolated grid: dx=1.200 mm, dy=1.200 mm

Maximum value of SAR (interpolated) = 0.222 W/kg

Zoom Scan (7x7x7)/Cube 0: Measurement grid: dx=5mm, dy=5mm, dz=5mm

Reference Value = 1.884 V/m; Power Drift = 0.09 dB

Peak SAR (extrapolated) = 0.264 W/kg

SAR(1 g) = 0.144 W/kg; SAR(10 g) = 0.076 W/kg

Maximum value of SAR (measured) = 0.217 W/kg

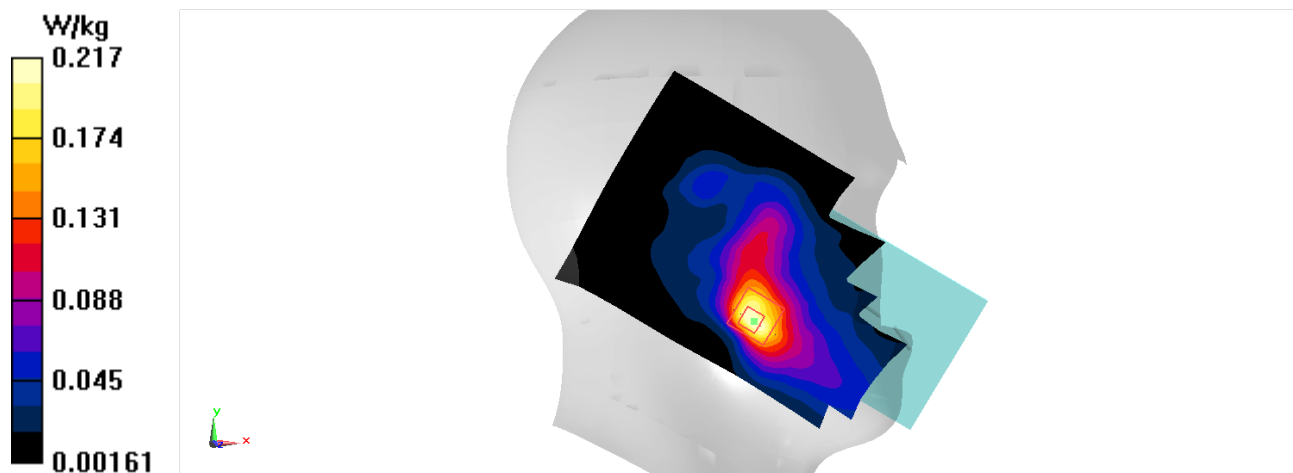

LTEBand66 Head

Date/Time: 6/6/2022

Electronics: DAE4 Sn1525

Medium: H700-6000M

Medium parameters used: $f = 1745$ MHz; $\sigma = 1.413$ S/m; $\epsilon_r = 41.894$; $\rho = 1000$ kg/m³

Ambient Temperature: 23.3°C Liquid Temperature: 22.5°C

Communication System: UID 0, LTE Band66 (0) Frequency: 1745 MHz Duty Cycle: 1:1

Probe: EX3DV4 - SN7517 ConvF(8.1, 8.1, 8.1); Calibrated: 1/19/2022

Area Scan (81x151x1): Interpolated grid: dx=1.500 mm, dy=1.500 mm

Maximum value of SAR (interpolated) = 0.145 W/kg

Zoom Scan (5x5x7)/Cube 0: Measurement grid: dx=8mm, dy=8mm, dz=5mm

Reference Value = 4.235 V/m; Power Drift = 0.08 dB

Peak SAR (extrapolated) = 0.163 W/kg

SAR(1 g) = 0.107 W/kg; SAR(10 g) = 0.070 W/kg

Maximum value of SAR (measured) = 0.140 W/kg

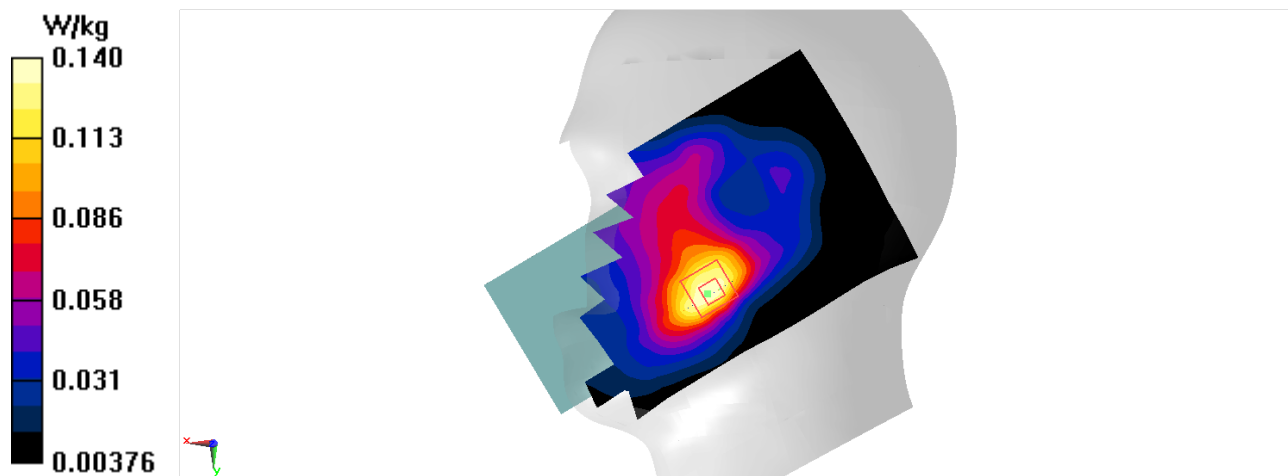

GSM850 Bod

Date/Time: 6/4/2022

Electronics: DAE4 Sn1525

Medium: H700-6000M

Medium parameters used (interpolated): $f = 848.8$ MHz; $\sigma = 0.94$ S/m; $\epsilon_r = 44.09$; $\rho = 1000$ kg/m³

Ambient Temperature: 23.3°C Liquid Temperature: 22.5°C

Communication System: UID 0, GSM 850 Glass 12 (0) Frequency: 848.8 MHz Duty Cycle: 1:1.99986

Probe: EX3DV4 - SN7517 ConvF(9.7, 9.7, 9.7); Calibrated: 1/19/2022

Area Scan (81x151x1): Interpolated grid: dx=1.500 mm, dy=1.500 mm

Maximum value of SAR (interpolated) = 0.607 W/kg

Zoom Scan (6x6x7)/Cube 0: Measurement grid: dx=8mm, dy=8mm, dz=5mm

Reference Value = 19.52 V/m; Power Drift = -0.06 dB

Peak SAR (extrapolated) = 0.737 W/kg

SAR(1 g) = 0.398 W/kg; SAR(10 g) = 0.237 W/kg

Maximum value of SAR (measured) = 0.591 W/kg

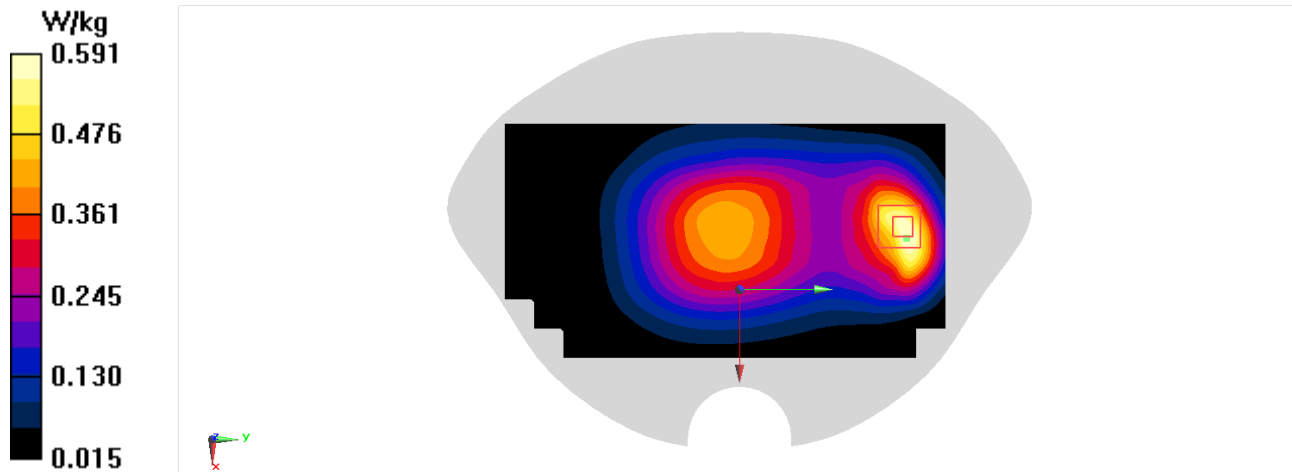

GSM1900 Body

Date/Time: 6/8/2022

Electronics: DAE4 Sn1525

Medium: H700-6000M

Medium parameters used: $f = 1880 \text{ MHz}$; $\sigma = 1.481 \text{ S/m}$; $\epsilon_r = 41.748$; $\rho = 1000 \text{ kg/m}^3$

Ambient Temperature: 23.3°C Liquid Temperature: 22.5°C

Communication System: UID 0, GSM 1900 GPRS12 (0) Frequency: 1880 MHz Duty Cycle: 1:1.99986

Probe: EX3DV4 - SN7517 ConvF(7.74, 7.74, 7.74); Calibrated: 1/19/2022

Area Scan (81x151x1): Interpolated grid: $dx=1.500 \text{ mm}$, $dy=1.500 \text{ mm}$

Maximum value of SAR (interpolated) = 1.02 W/kg

Zoom Scan (5x5x7)/Cube 0: Measurement grid: $dx=8\text{mm}$, $dy=8\text{mm}$, $dz=5\text{mm}$

Reference Value = 10.56 V/m ; Power Drift = -0.06 dB

Peak SAR (extrapolated) = 1.16 W/kg

SAR(1 g) = 0.664 W/kg ; SAR(10 g) = 0.389 W/kg

Maximum value of SAR (measured) = 0.968 W/kg

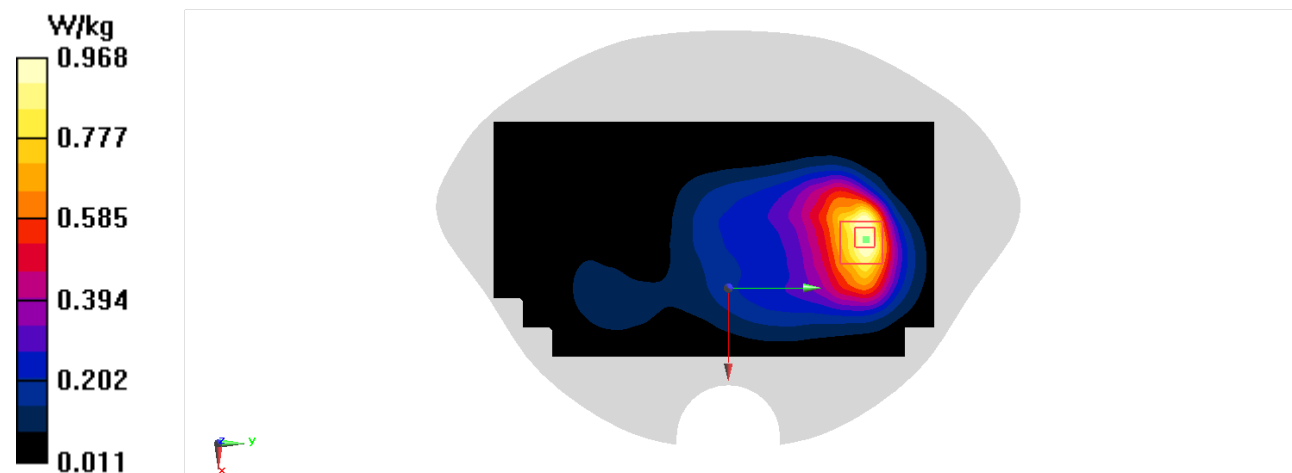

W1900 Body

Date/Time: 6/8/2022

Electronics: DAE4 Sn1525

Medium: H700-6000M

Medium parameters used (interpolated): $f = 1907.6$ MHz; $\sigma = 1.501$ S/m; $\epsilon_r = 41.677$; $\rho = 1000$ kg/m³

Ambient Temperature: 23.3°C Liquid Temperature: 22.5°C

Communication System: UID 0, WCDMA 1900 (0) Frequency: 1907.6 MHz Duty Cycle: 1:1

Probe: EX3DV4 - SN7517 ConvF(7.74, 7.74, 7.74); Calibrated: 1/19/2022

Area Scan (81x151x1): Interpolated grid: dx=1.500 mm, dy=1.500 mm

Maximum value of SAR (interpolated) = 0.858 W/kg

Zoom Scan (5x5x7)/Cube 0: Measurement grid: dx=8mm, dy=8mm, dz=5mm

Reference Value = 17.43 V/m; Power Drift = -0.07 dB

Peak SAR (extrapolated) = 0.990 W/kg

SAR(1 g) = 0.558 W/kg; SAR(10 g) = 0.313 W/kg

Maximum value of SAR (measured) = 0.829 W/kg

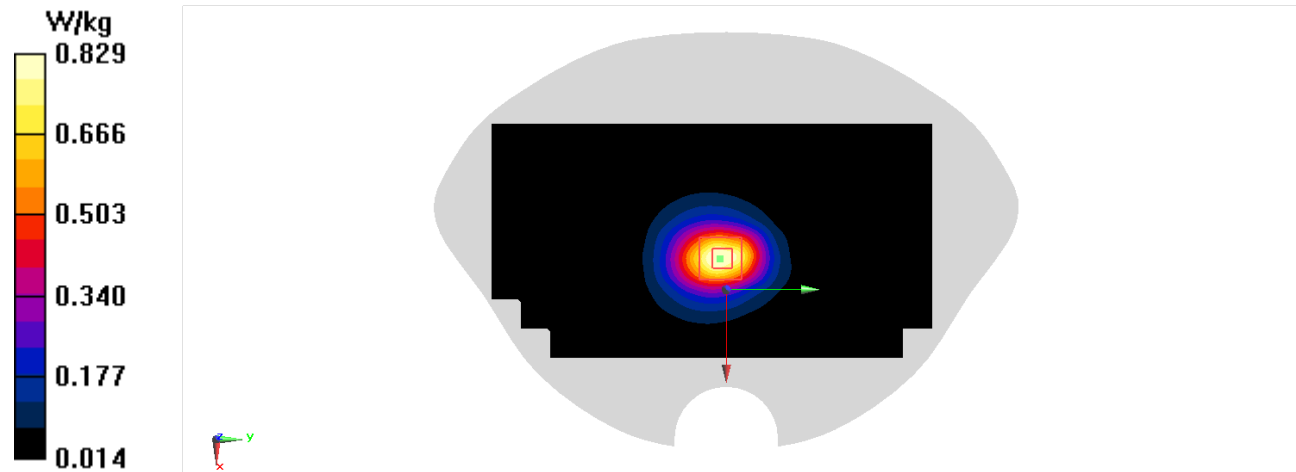

W1700 Body

Date/Time: 6/6/2022

Electronics: DAE4 Sn1525

Medium: H700-6000M

Medium parameters used (interpolated): $f = 1712.4$ MHz; $\sigma = 1.391$ S/m; $\epsilon_r = 41.856$; $\rho = 1000$ kg/m³

Ambient Temperature: 23.3°C Liquid Temperature: 22.5°C

Communication System: UID 0, WCDMA 1700 Band4 (0) Frequency: 1712.4 MHz Duty Cycle: 1:1

Probe: EX3DV4 - SN7517 ConvF(8.1, 8.1, 8.1); Calibrated: 1/19/2022

Area Scan (81x151x1): Interpolated grid: dx=1.500 mm, dy=1.500 mm

Maximum value of SAR (interpolated) = 1.39 W/kg

Zoom Scan (5x5x7)/Cube 0: Measurement grid: dx=8mm, dy=8mm, dz=5mm

Reference Value = 23.44 V/m; Power Drift = -0.04 dB

Peak SAR (extrapolated) = 1.64 W/kg

SAR(1 g) = 0.946 W/kg; SAR(10 g) = 0.541 W/kg

Maximum value of SAR (measured) = 1.38 W/kg

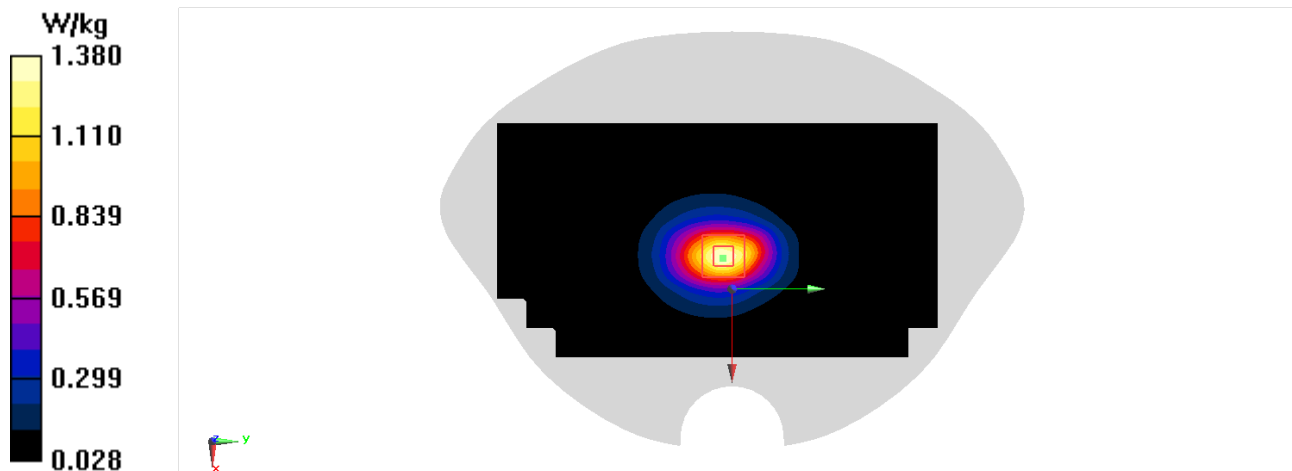

W850 Body

Date/Time: 6/4/2022

Electronics: DAE4 Sn1525

Medium: H700-6000M

Medium parameters used (interpolated): $f = 846.6$ MHz; $\sigma = 0.939$ S/m; $\epsilon_r = 44.083$; $\rho = 1000$ kg/m³

Ambient Temperature: 23.3°C Liquid Temperature: 22.5°C

Communication System: UID 0, WCDMA 850 (0) Frequency: 846.6 MHz Duty Cycle: 1:1

Probe: EX3DV4 - SN7517 ConvF(9.7, 9.7, 9.7); Calibrated: 1/19/2022

Area Scan (81x151x1): Interpolated grid: dx=1.500 mm, dy=1.500 mm

Maximum value of SAR (interpolated) = 0.601 W/kg

Body/Rear 10mm/Zoom Scan (5x5x7)/Cube 0: Measurement grid: dx=8mm, dy=8mm, dz=5mm

Reference Value = 16.77 V/m; Power Drift = 0.06 dB

Peak SAR (extrapolated) = 0.714 W/kg

SAR(1 g) = 0.385 W/kg; SAR(10 g) = 0.230 W/kg

Maximum value of SAR (measured) = 0.581 W/kg

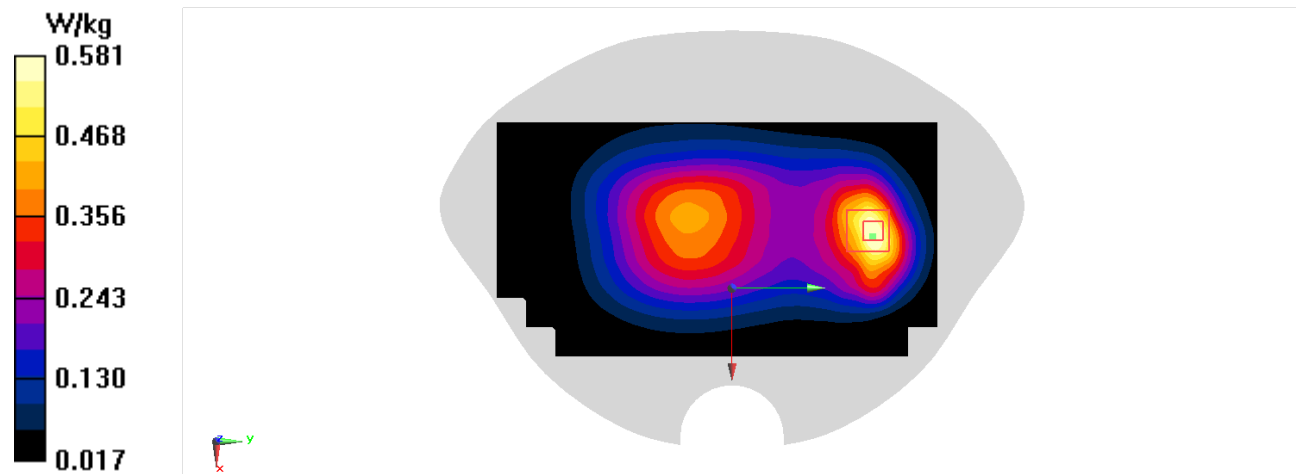

LTEBand2 Body

Date/Time: 6/8/2022

Electronics: DAE4 Sn1525

Medium: H700-6000M

Medium parameters used: $f = 1860$ MHz; $\sigma = 1.475$ S/m; $\epsilon_r = 41.757$; $\rho = 1000$ kg/m³

Ambient Temperature: 23.3°C Liquid Temperature: 22.5°C

Communication System: UID 0, LTE Band2(20MB) (0) Frequency: 1860 MHz Duty Cycle: 1:1

Probe: EX3DV4 - SN7517 ConvF(7.74, 7.74, 7.74); Calibrated: 1/19/2022

Area Scan (81x141x1): Interpolated grid: dx=1.500 mm, dy=1.500 mm

Maximum value of SAR (interpolated) = 0.689 W/kg

Zoom Scan (5x5x7)/Cube 0: Measurement grid: dx=8mm, dy=8mm, dz=5mm

Reference Value = 18.06 V/m; Power Drift = -0.03 dB

Peak SAR (extrapolated) = 0.782 W/kg

SAR(1 g) = 0.438 W/kg; SAR(10 g) = 0.246 W/kg

Maximum value of SAR (measured) = 0.649 W/kg

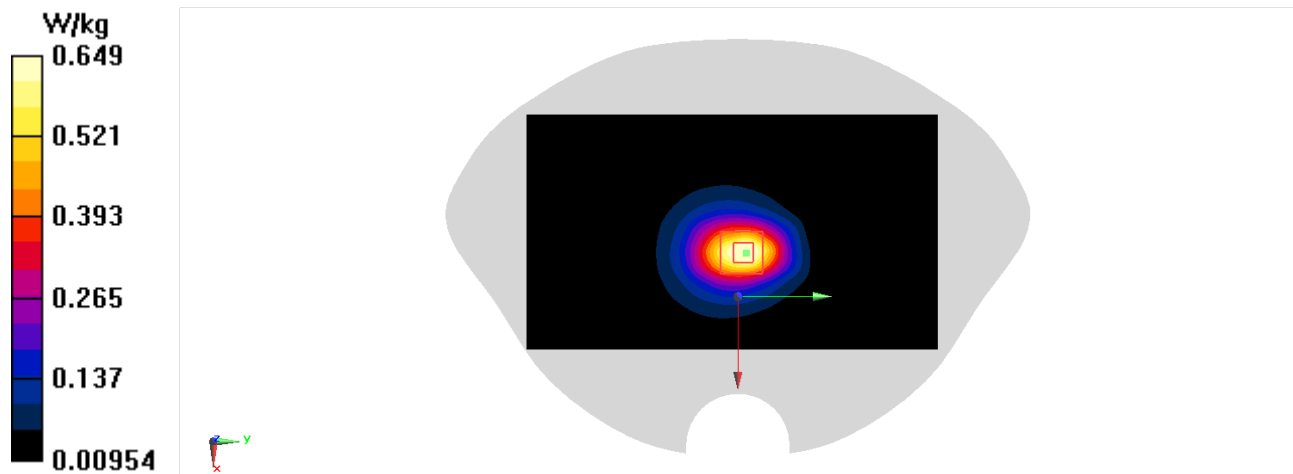

LTEBand7 Body

Date/Time: 6/12/2022

Electronics: DAE4 Sn1525

Medium: H700-6000M

Medium parameters used: $f = 2560$ MHz; $\sigma = 1.967$ S/m; $\epsilon_r = 40.804$; $\rho = 1000$ kg/m³

Ambient Temperature: 23.3°C Liquid Temperature: 22.5°C

Communication System: UID 0, LTE Band7-20M (0) Frequency: 2560 MHz Duty Cycle: 1:1

Probe: EX3DV4 - SN7517 ConvF(6.97, 6.97, 6.97); Calibrated: 1/19/2022

Area Scan (101x181x1): Interpolated grid: dx=1.200 mm, dy=1.200 mm

Maximum value of SAR (interpolated) = 0.802 W/kg

Zoom Scan (7x7x7)/Cube 0: Measurement grid: dx=5mm, dy=5mm, dz=5mm

Reference Value = 7.437 V/m; Power Drift = 0.19 dB

Peak SAR (extrapolated) = 0.914 W/kg

SAR(1 g) = 0.428 W/kg; SAR(10 g) = 0.204 W/kg

Maximum value of SAR (measured) = 0.722 W/kg

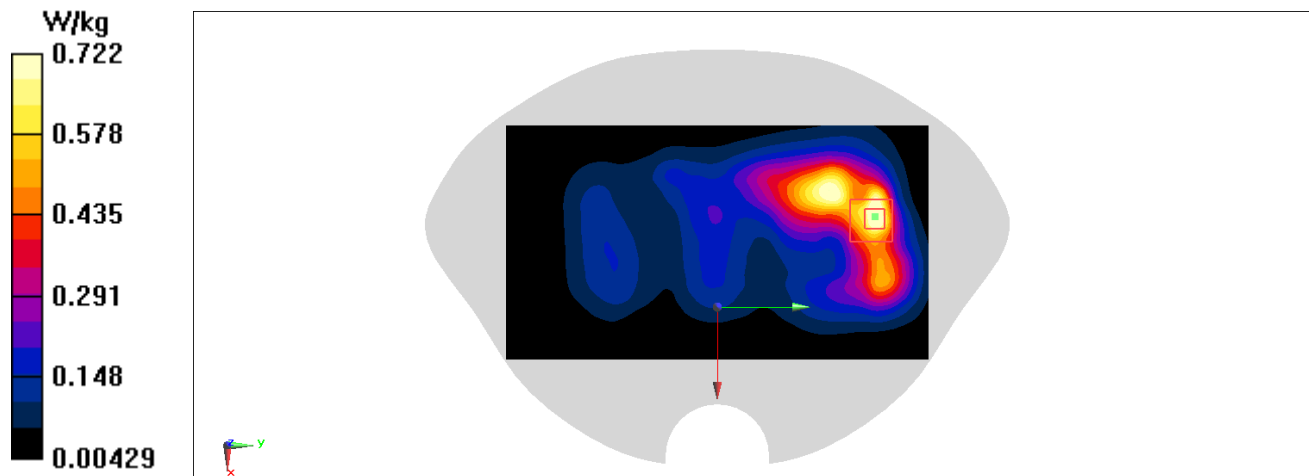

LTEBand12 Body

Date/Time: 6/2/2022

Electronics: DAE4 Sn1525

Medium: H700-6000M

Medium parameters used (interpolated): $f = 704 \text{ MHz}$; $\sigma = 0.885 \text{ S/m}$; $\epsilon_r = 44.41$; $\rho = 1000 \text{ kg/m}^3$

Ambient Temperature: 23.3°C Liquid Temperature: 22.5°C

Communication System: UID 0, LTE Band12 (0) Frequency: 704 MHz Duty Cycle: 1:1

Probe: EX3DV4 - SN7517 ConvF(9.7, 9.7, 9.7); Calibrated: 1/19/2022

Area Scan (81x141x1): Interpolated grid: $dx=1.500 \text{ mm}$, $dy=1.500 \text{ mm}$

Maximum value of SAR (interpolated) = 0.291 W/kg

Zoom Scan (6x6x7)/Cube 0: Measurement grid: $dx=8\text{mm}$, $dy=8\text{mm}$, $dz=5\text{mm}$

Reference Value = 15.81 V/m ; Power Drift = 0.09 dB

Peak SAR (extrapolated) = 0.328 W/kg

SAR(1 g) = 0.237 W/kg ; SAR(10 g) = 0.181 W/kg

Maximum value of SAR (measured) = 0.293 W/kg

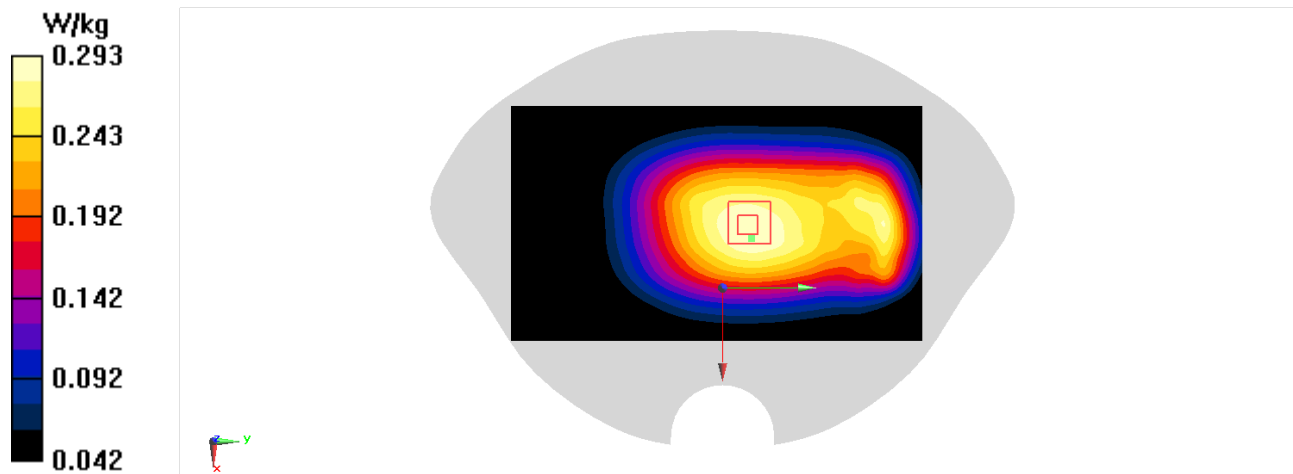

LTEBand13 Body

Date/Time: 6/2/2022

Electronics: DAE4 Sn1525

Medium: H700-6000M

Medium parameters used (interpolated): $f = 782 \text{ MHz}$; $\sigma = 0.913 \text{ S/m}$; $\epsilon_r = 44.238$; $\rho = 1000 \text{ kg/m}^3$

Ambient Temperature: 23.3°C Liquid Temperature: 22.5°C

Communication System: UID 0, LTE Band13 (0) Frequency: 782 MHz Duty Cycle: 1:1

Probe: EX3DV4 - SN7517 ConvF(9.7, 9.7, 9.7); Calibrated: 1/19/2022

Area Scan (81x141x1): Interpolated grid: $dx=1.500 \text{ mm}$, $dy=1.500 \text{ mm}$

Maximum value of SAR (interpolated) = 0.418 W/kg

Zoom Scan (6x5x7)/Cube 0: Measurement grid: $dx=8\text{mm}$, $dy=8\text{mm}$, $dz=5\text{mm}$

Reference Value = 19.15 V/m ; Power Drift = 0.07 dB

Peak SAR (extrapolated) = 0.469 W/kg

SAR(1 g) = 0.334 W/kg ; SAR(10 g) = 0.253 W/kg

Maximum value of SAR (measured) = 0.417 W/kg

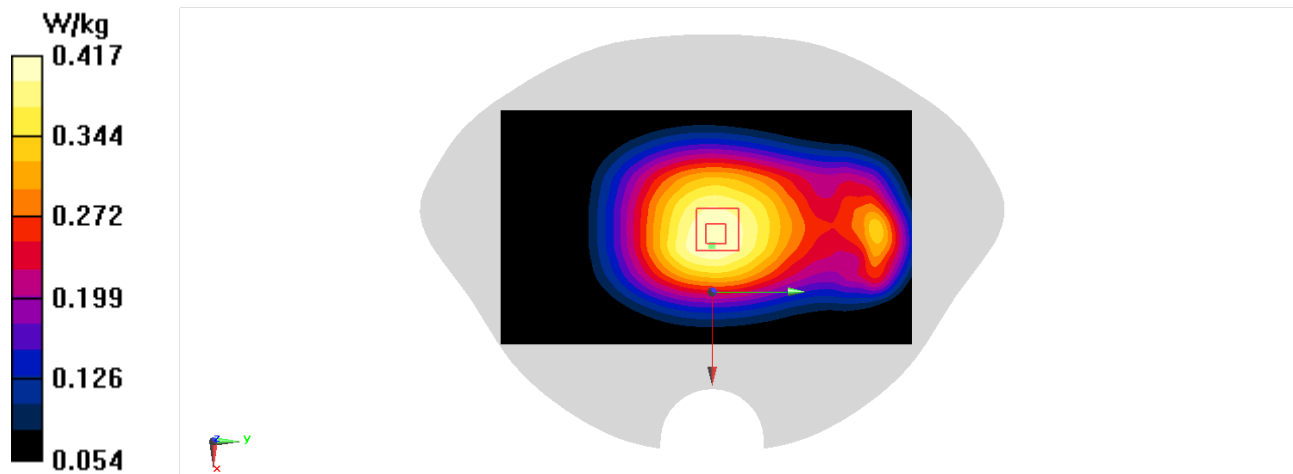

LTEBand26 Body

Date/Time: 6/4/2022

Electronics: DAE4 Sn1525

Medium: H700-6000M

Medium parameters used (interpolated): $f = 822.5$ MHz; $\sigma = 0.927$ S/m; $\epsilon_r = 44.007$; $\rho = 1000$ kg/m³

Ambient Temperature: 23.3°C Liquid Temperature: 22.5°C

Communication System: UID 0, LTE Band26 (0) Frequency: 822.5 MHz Duty Cycle: 1:1

Probe: EX3DV4 - SN7517 ConvF(9.7, 9.7, 9.7); Calibrated: 1/19/2022

Area Scan (81x141x1): Interpolated grid: dx=1.500 mm, dy=1.500 mm

Maximum value of SAR (interpolated) = 0.187 W/kg

Zoom Scan (5x5x7)/Cube 0: Measurement grid: dx=8mm, dy=8mm, dz=5mm

Reference Value = 12.50 V/m; Power Drift = 0.03 dB

Peak SAR (extrapolated) = 0.210 W/kg

SAR(1 g) = 0.151 W/kg; SAR(10 g) = 0.115 W/kg

Maximum value of SAR (measured) = 0.188 W/kg

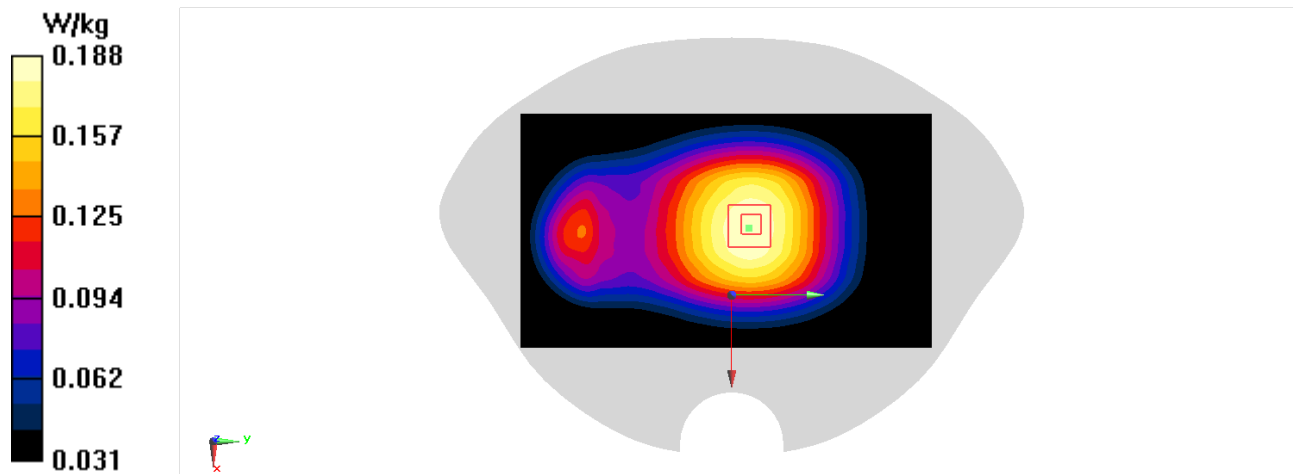

LTEBand41 Body

Date/Time: 6/12/2022

Electronics: DAE4 Sn1525

Medium: H700-6000M

Medium parameters used (interpolated): $f = 2593$ MHz; $\sigma = 1.981$ S/m; $\epsilon_r = 40.625$; $\rho = 1000$ kg/m³

Ambient Temperature: 23.3°C Liquid Temperature: 22.5°C

Communication System: UID 0, LTE Band41 PC3 (0) Frequency: 2593 MHz Duty Cycle: 1:1.5787

Probe: EX3DV4 - SN7517 ConvF(6.97, 6.97, 6.97); Calibrated: 1/19/2022

Area Scan (101x181x1): Interpolated grid: dx=1.200 mm, dy=1.200 mm

Maximum value of SAR (interpolated) = 0.440 W/kg

Zoom Scan (8x8x7)/Cube 0: Measurement grid: dx=5mm, dy=5mm, dz=5mm

Reference Value = 5.441 V/m; Power Drift = -0.03 dB

Peak SAR (extrapolated) = 0.557 W/kg

SAR(1 g) = 0.265 W/kg; SAR(10 g) = 0.130 W/kg

Maximum value of SAR (measured) = 0.437 W/kg

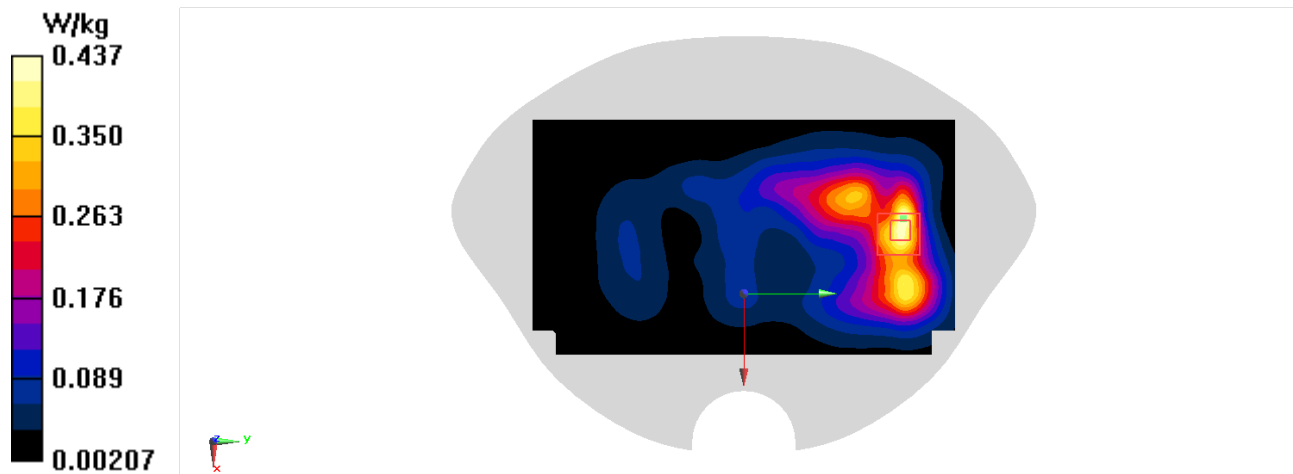

LTEBand66 Body

Date/Time: 6/6/2022

Electronics: DAE4 Sn1525

Medium: H700-6000M

Medium parameters used: $f = 1720 \text{ MHz}$; $\sigma = 1.396 \text{ S/m}$; $\epsilon_r = 41.845$; $\rho = 1000 \text{ kg/m}^3$

Ambient Temperature: 23.3°C Liquid Temperature: 22.5°C

Communication System: UID 0, LTE Band66 (0) Frequency: 1720 MHz Duty Cycle: 1:1

Probe: EX3DV4 - SN7517 ConvF(8.1, 8.1, 8.1); Calibrated: 1/19/2022

Area Scan (81x141x1): Interpolated grid: $dx=1.500 \text{ mm}$, $dy=1.500 \text{ mm}$

Maximum value of SAR (interpolated) = 1.65 W/kg

Zoom Scan (5x5x7)/Cube 0: Measurement grid: $dx=8\text{mm}$, $dy=8\text{mm}$, $dz=5\text{mm}$

Reference Value = 20.05 V/m ; Power Drift = -0.06 dB

Peak SAR (extrapolated) = 1.90 W/kg

SAR(1 g) = 1.1 W/kg ; SAR(10 g) = 0.628 W/kg

Maximum value of SAR (measured) = 1.61 W/kg

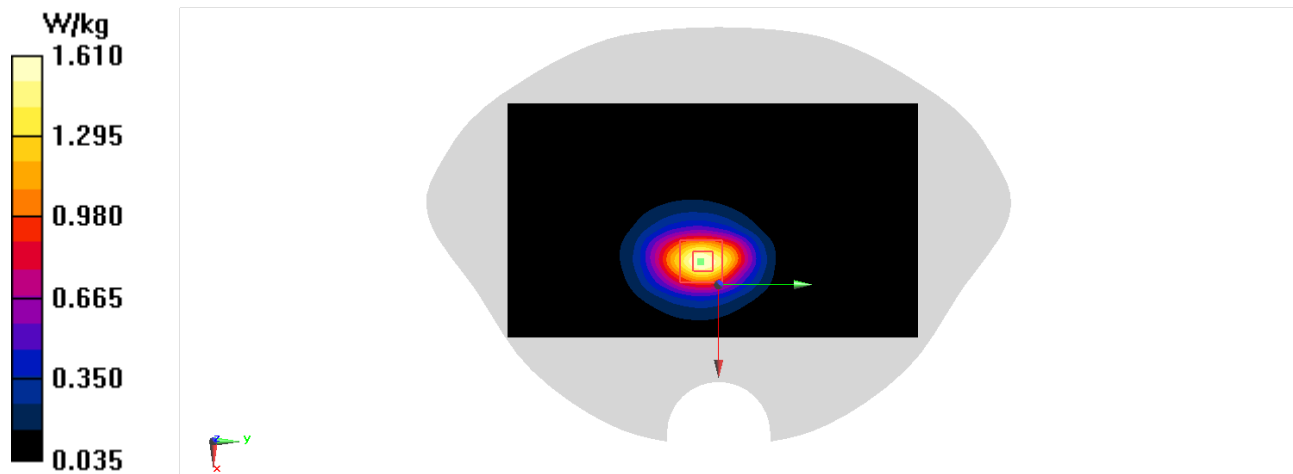

WIFI 2.4G Head

Date/Time: 6/10/2022

Electronics: DAE4 Sn1525

Medium: H700-6000M

Medium parameters used (interpolated): $f = 2462$ MHz; $\sigma = 1.887$ S/m; $\epsilon_r = 41.04$; $\rho = 1000$ kg/m³

Ambient Temperature: 23.3°C Liquid Temperature: 22.5°C

Communication System: UID 0, Wlan 2450 (0) Frequency: 2462 MHz Duty Cycle: 1:1

Probe: EX3DV4 - SN7517 ConvF(7.16, 7.16, 7.16); Calibrated: 1/19/2022

Area Scan (101x181x1): Interpolated grid: dx=1.200 mm, dy=1.200 mm

Maximum value of SAR (interpolated) = 1.79 W/kg

Zoom Scan (7x7x7)/Cube 0: Measurement grid: dx=5mm, dy=5mm, dz=5mm

Reference Value = 8.956 V/m; Power Drift = 0.12 dB

Peak SAR (extrapolated) = 2.37 W/kg

SAR(1 g) = 0.971 W/kg; SAR(10 g) = 0.399 W/kg

Maximum value of SAR (measured) = 1.83 W/kg

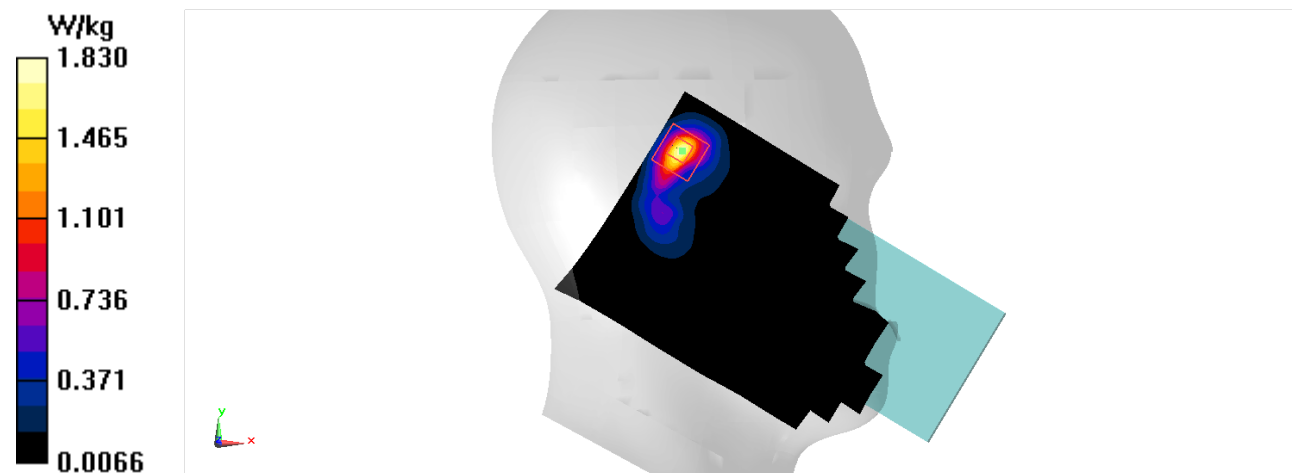

WIFI 2.4G Body

Date/Time: 6/10/2022

Electronics: DAE4 Sn1525

Medium: H700-6000M

Medium parameters used (interpolated): $f = 2462$ MHz; $\sigma = 1.887$ S/m; $\epsilon_r = 41.04$; $\rho = 1000$ kg/m³

Ambient Temperature: 23.3°C Liquid Temperature: 22.5°C

Communication System: UID 0, WLan 2450 (0) Frequency: 2462 MHz Duty Cycle: 1:1

Probe: EX3DV4 - SN7517 ConvF(7.16, 7.16, 7.16); Calibrated: 1/19/2022

Area Scan (101x181x1): Interpolated grid: dx=1.200 mm, dy=1.200 mm

Maximum value of SAR (interpolated) = 0.759 W/kg

Zoom Scan (7x7x7)/Cube 0: Measurement grid: dx=5mm, dy=5mm, dz=5mm

Reference Value = 2.578 V/m; Power Drift = -0.04 dB

Peak SAR (extrapolated) = 0.996 W/kg

SAR(1 g) = 0.475 W/kg; SAR(10 g) = 0.210 W/kg

Maximum value of SAR (measured) = 0.801 W/kg

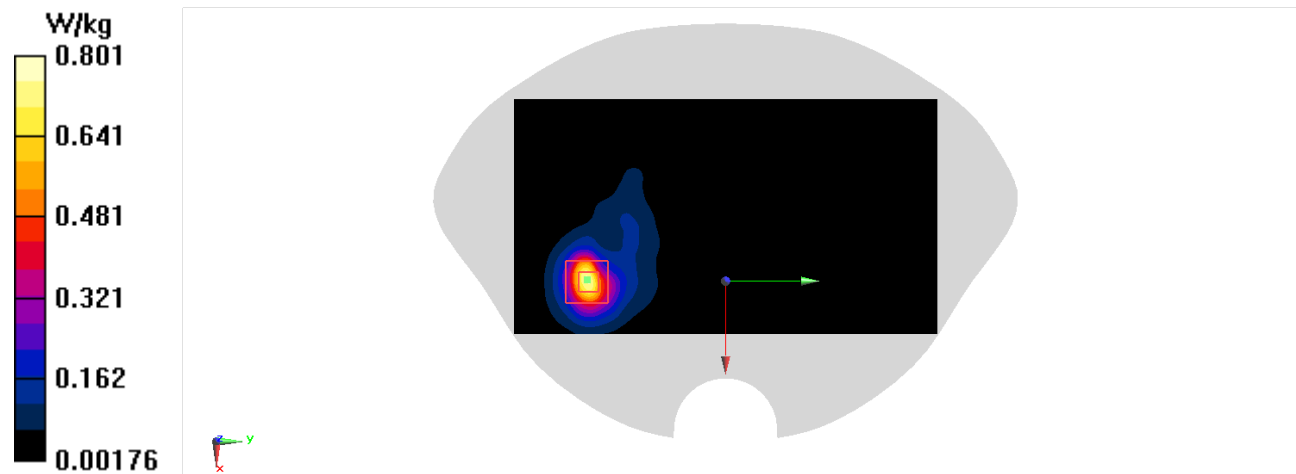

BT head

Date/Time: 6/10/2022

Electronics: DAE4 Sn1525

Medium: H700-6000M

Medium parameters used (interpolated): $f = 2441$ MHz; $\sigma = 1.878$ S/m; $\epsilon_r = 41.019$; $\rho = 1000$ kg/m³

Ambient Temperature: 23.3°C Liquid Temperature: 22.5°C

Communication System: UID 0, Bluetooth2 (0) Frequency: 2441 MHz Duty Cycle: 1:1

Probe: EX3DV4 - SN7517 ConvF(7.16, 7.16, 7.16); Calibrated: 1/19/2022

Area Scan (101x191x1): Interpolated grid: dx=1.200 mm, dy=1.200 mm

Maximum value of SAR (interpolated) = 0.0670 W/kg

Zoom Scan (11x11x7)/Cube 0: Measurement grid: dx=5mm, dy=5mm, dz=5mm

Reference Value = 0.6580 V/m; Power Drift = 0.11 dB

Peak SAR (extrapolated) = 0.0930 W/kg

SAR(1 g) = 0.035 W/kg; SAR(10 g) = 0.014 W/kg

Maximum value of SAR (measured) = 0.0672 W/kg

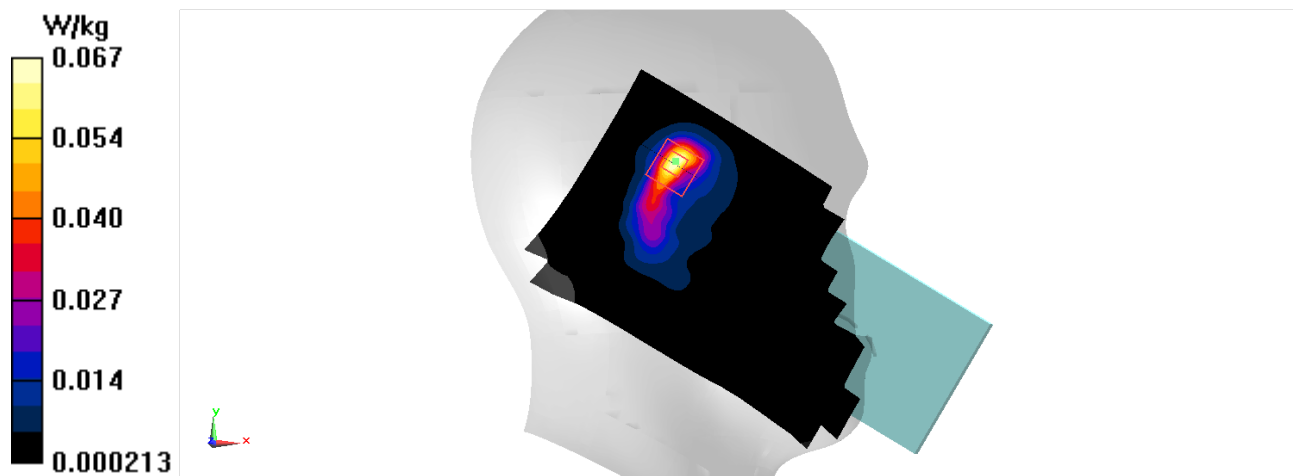

BT Body

Date/Time: 6/10/2022

Electronics: DAE4 Sn1525

Medium: H700-6000M

Medium parameters used (interpolated): $f = 2441$ MHz; $\sigma = 1.878$ S/m; $\epsilon_r = 41.019$; $\rho = 1000$ kg/m³

Ambient Temperature: 23.3°C Liquid Temperature: 22.5°C

Communication System: UID 0, Bluetooth2 (0) Frequency: 2441 MHz Duty Cycle: 1:1

Probe: EX3DV4 - SN7517 ConvF(7.16, 7.16, 7.16); Calibrated: 1/19/2022

Area Scan (101x181x1): Interpolated grid: dx=1.200 mm, dy=1.200 mm

Maximum value of SAR (interpolated) = 0.0419 W/kg

Zoom Scan (7x7x7)/Cube 0: Measurement grid: dx=5mm, dy=5mm, dz=5mm

Reference Value = 1.086 V/m; Power Drift = 0.13 dB

Peak SAR (extrapolated) = 0.0550 W/kg

SAR(1 g) = 0.023 W/kg; SAR(10 g) = 0.010 W/kg

Maximum value of SAR (measured) = 0.0392 W/kg

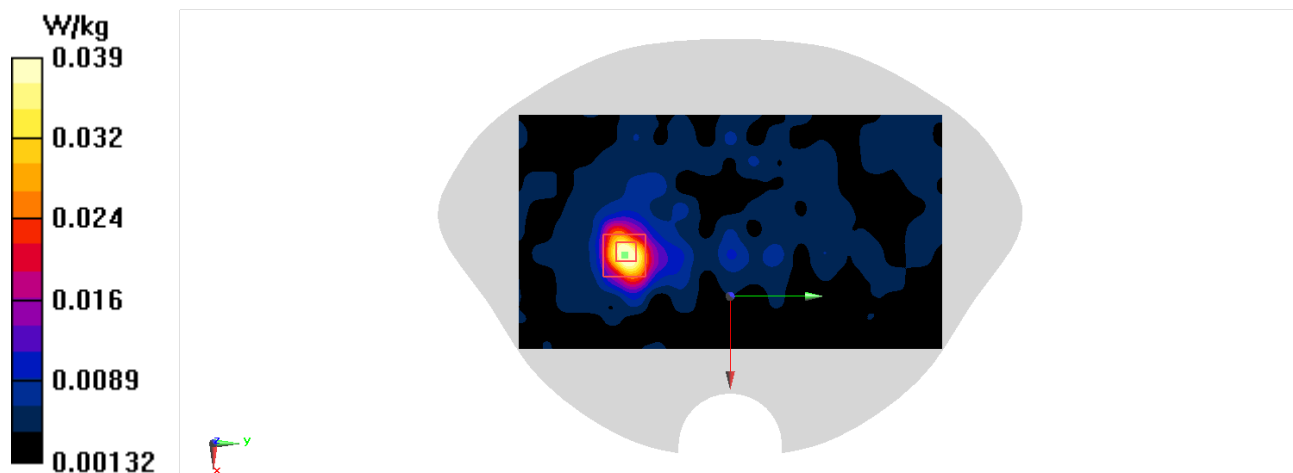

WIFI 5G Head

Date/Time: 6/21/2022

Electronics: DAE4 Sn1525

Medium: H700-6000M

Medium parameters used: $f = 5805$ MHz; $\sigma = 5.333$ S/m; $\epsilon_r = 34.966$; $\rho = 1000$ kg/m³

Ambient Temperature: 23.3°C Liquid Temperature: 22.5°C

Communication System: UID 0, WLan 11a (0) Frequency: 5805 MHz Duty Cycle: 1:1

Probe: EX3DV4 - SN7517 ConvF(4.75, 4.75, 4.75); Calibrated: 1/19/2022

Area Scan (121x221x1): Interpolated grid: dx=1.000 mm, dy=1.000 mm

Maximum value of SAR (interpolated) = 0.823 W/kg

Zoom Scan (9x8x7)/Cube 0: Measurement grid: dx=4mm, dy=4mm, dz=1.4mm

Reference Value = 2.694 V/m; Power Drift = 0.05 dB

Peak SAR (extrapolated) = 1.44 W/kg

SAR(1 g) = 0.305 W/kg; SAR(10 g) = 0.095 W/kg

Maximum value of SAR (measured) = 0.833 W/kg

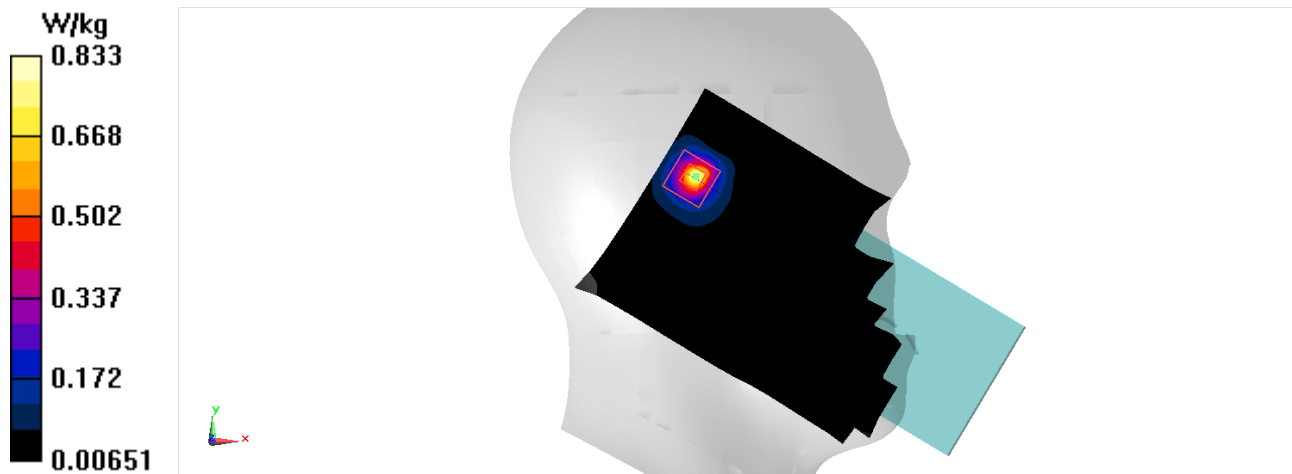

WIFI 5G Body

Date/Time: 6/21/2022

Electronics: DAE4 Sn1525

Medium: H700-6000M

Medium parameters used: $f = 5805$ MHz; $\sigma = 5.333$ S/m; $\epsilon_r = 34.966$; $\rho = 1000$ kg/m³

Ambient Temperature: 23.3°C Liquid Temperature: 22.5°C

Communication System: UID 0, WLan 11a (0) Frequency: 5805 MHz Duty Cycle: 1:1

Probe: EX3DV4 - SN7517 ConvF(4.75, 4.75, 4.75); Calibrated: 1/19/2022

Area Scan (111x211x1): Interpolated grid: dx=1.000 mm, dy=1.000 mm

Maximum value of SAR (interpolated) = 1.68 W/kg

Zoom Scan (8x8x7)/Cube 0: Measurement grid: dx=4mm, dy=4mm, dz=1.4mm

Reference Value = 1.156 V/m; Power Drift = 0.09 dB

Peak SAR (extrapolated) = 2.76 W/kg

SAR(1 g) = 0.666 W/kg; SAR(10 g) = 0.229 W/kg

Maximum value of SAR (measured) = 1.62 W/kg

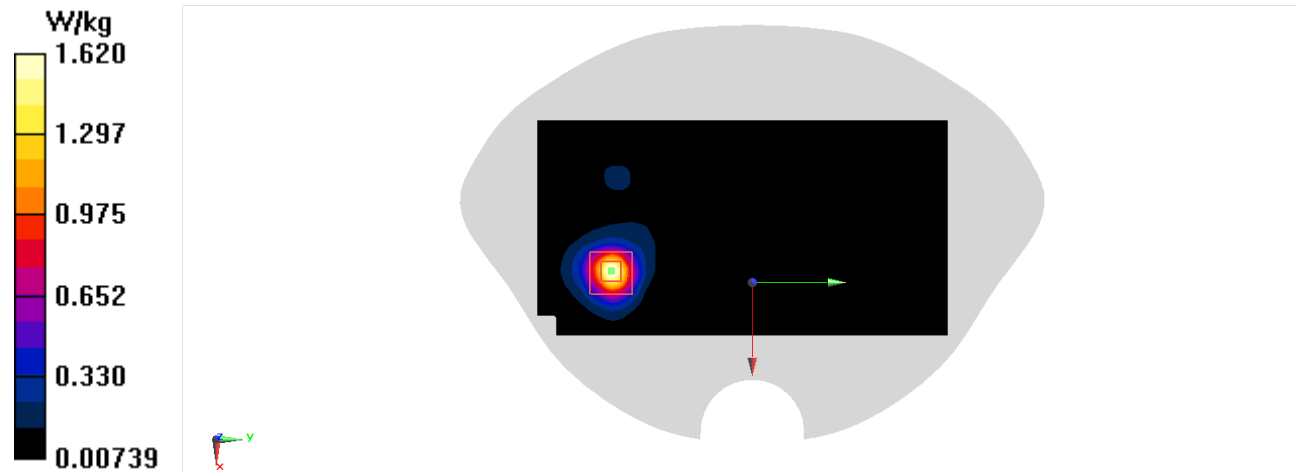

ANNEX B System Verification Results

SystemPerformanceCheck-D750-1017

Date/Time: 6/2/2022

Electronics: DAE4 Sn1525

Medium: H700-6000M

Medium parameters used: $f = 750$ MHz; $\sigma = 0.909$ S/m; $\epsilon_r = 44.234$; $\rho = 1000$ kg/m³

Ambient Temperature: 23.3°C Liquid Temperature: 22.5°C

Communication System: UID 0, CW (0) Frequency: 750 MHz Duty Cycle: 1:1

Probe: EX3DV4 - SN7517 ConvF(9.7, 9.7, 9.7); Calibrated: 1/19/2022

System Performance Check at Frequencies below 1 GHz/d=15mm, Pin=250 mW, dist=2.0mm

(EX-Probe)/Area Scan (61x141x1): Interpolated grid: dx=1.000 mm, dy=1.000 mm

Maximum value of SAR (interpolated) = 2.44 W/kg

System Performance Check at Frequencies below 1 GHz/d=15mm, Pin=250 mW, dist=2.0mm

(EX-Probe)/Zoom Scan (7x7x7) (7x7x7)/Cube 0: Measurement grid: dx=5mm, dy=5mm, dz=5mm

Reference Value = 50.22 V/m; Power Drift = -0.17 dB

Peak SAR (extrapolated) = 2.91 W/kg

SAR(1 g) = 1.99 W/kg; SAR(10 g) = 1.3 W/kg

Maximum value of SAR (measured) = 2.47 W/kg

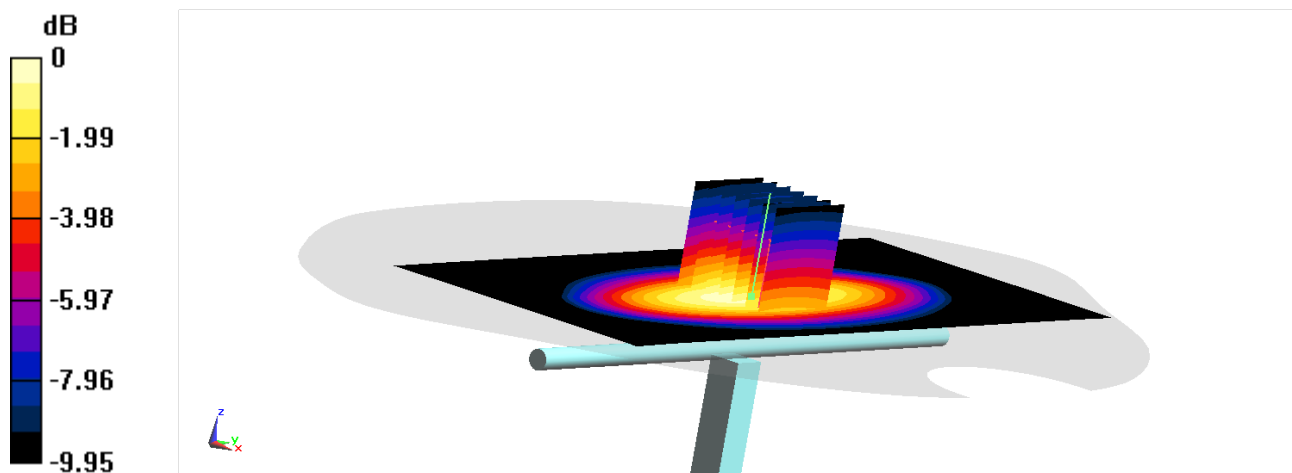

0 dB = 2.47 W/kg = 3.93 dBW/kg

SystemPerformanceCheck-D835_4d120

Date/Time: 6/4/2022

Electronics: DAE4 Sn1525

Medium: H700-6000M

Medium parameters used: $f = 835 \text{ MHz}$; $\sigma = 0.933 \text{ S/m}$; $\epsilon_r = 44.038$; $\rho = 1000 \text{ kg/m}^3$

Ambient Temperature: 23.3°C Liquid Temperature: 22.5°C

Communication System: UID 0, CW (0) Frequency: 835 MHz Duty Cycle: 1:1

Probe: EX3DV4 - SN7517 ConvF(9.3, 9.3, 9.3); Calibrated: 1/19/2022

System Performance Check at Frequencies below 1 GHz/d=15mm, Pin=250 mW, dist=2.0mm (EX-Probe)/Area Scan (61x121x1): Interpolated grid: $dx=1.000 \text{ mm}$, $dy=1.000 \text{ mm}$
Maximum value of SAR (interpolated) = 2.76 W/kg

System Performance Check at Frequencies below 1 GHz/d=15mm, Pin=250 mW, dist=2.0mm (EX-Probe)/Zoom Scan (7x7x7) (7x7x7)/Cube 0: Measurement grid: $dx=5\text{mm}$, $dy=5\text{mm}$, $dz=5\text{mm}$
Reference Value = 54.37 V/m ; Power Drift = -0.17 dB
Peak SAR (extrapolated) = 3.34 W/kg
SAR(1 g) = 2.24 W/kg ; SAR(10 g) = 1.47 W/kg
Maximum value of SAR (measured) = 2.82 W/kg

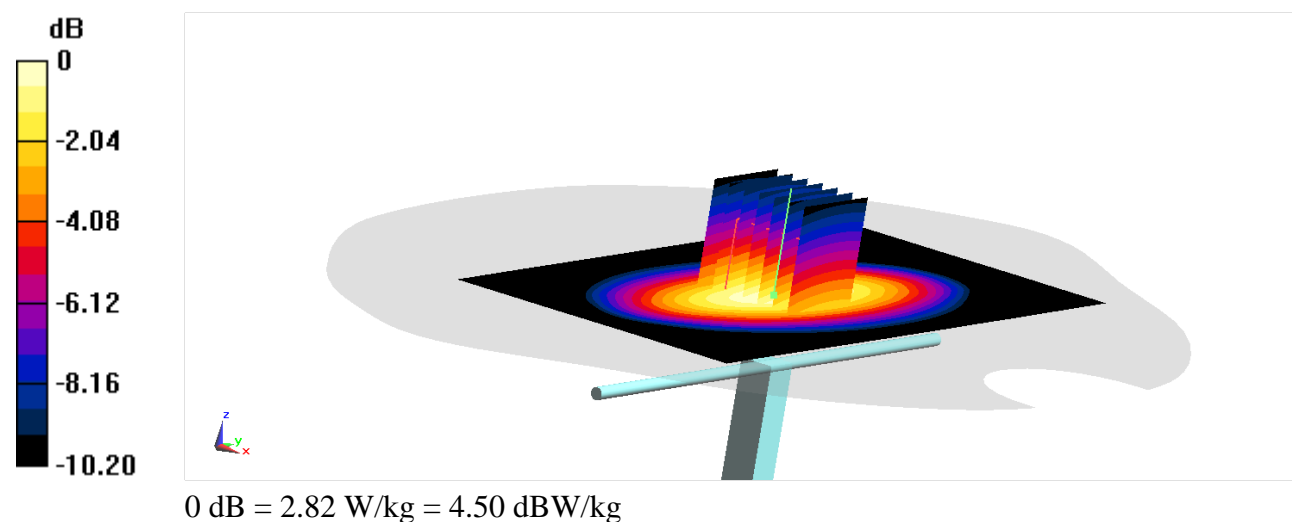

SystemPerformanceCheck-D1750_1023

Date/Time: 6/6/2022

Electronics: DAE4 Sn1525

Medium: H700-6000M

Medium parameters used: $f = 1750 \text{ MHz}$; $\sigma = 1.415 \text{ S/m}$; $\epsilon_r = 41.903$; $\rho = 1000 \text{ kg/m}^3$

Ambient Temperature: 23.3°C Liquid Temperature: 22.5°C

Communication System: UID 0, CW Frequency: 1750 MHz Duty Cycle: 1:1

Probe: EX3DV4 - SN7517 ConvF(8.1, 8.1, 8.1); Calibrated: 1/19/2022

System Performance Check at Frequencies above 1 GHz/d=10mm, Pin=xx mW, dist=2.0mm (EX-Probe)/Area Scan (61x81x1): Interpolated grid: dx=1.000 mm, dy=1.000 mm

Maximum value of SAR (interpolated) = 12.2 W/kg

System Performance Check at Frequencies above 1 GHz/d=10mm, Pin=xx mW, dist=2.0mm (EX-Probe)/Zoom Scan (7x7x7) (7x7x7)/Cube 0: Measurement grid: dx=5mm, dy=5mm, dz=5mm

Reference Value = 88.41 V/m; Power Drift = -0.06 dB

Peak SAR (extrapolated) = 14.8 W/kg

SAR(1 g) = 8.26 W/kg; SAR(10 g) = 4.38 W/kg

Maximum value of SAR (measured) = 11.6 W/kg

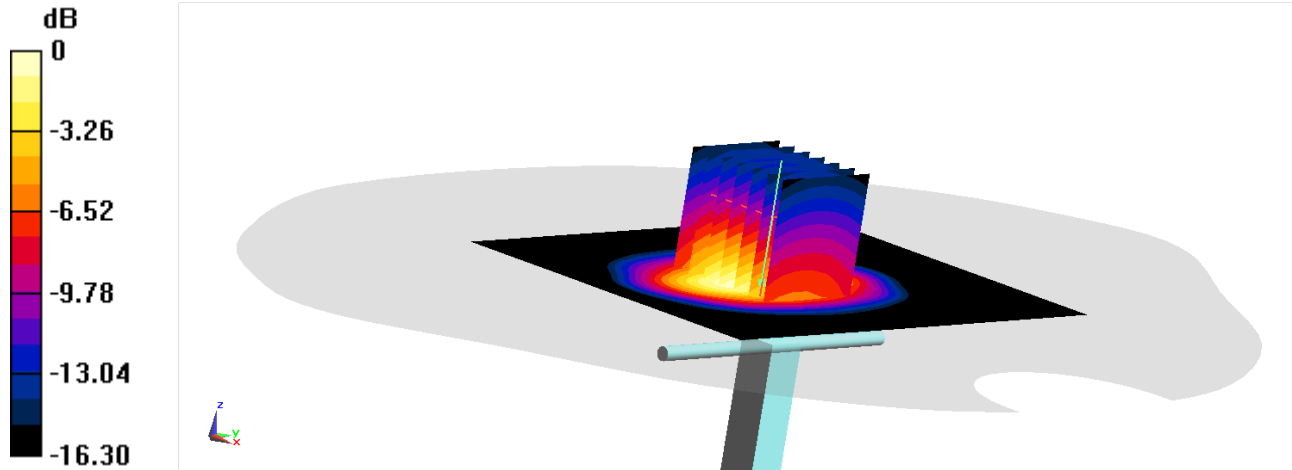

0 dB = 11.6 W/kg = 10.64 dBW/kg

SystemPerformanceCheck-D1900_5d142

Date/Time: 6/8/2022

Electronics: DAE4 Sn1525

Medium: H700-6000M

Medium parameters used: $f = 1900$ MHz; $\sigma = 1.494$ S/m; $\epsilon_r = 41.692$; $\rho = 1000$ kg/m³

Ambient Temperature: 23.3°C Liquid Temperature: 22.5°C

Communication System: UID 0, CW (0) Frequency: 1900 MHz Duty Cycle: 1:1

Probe: EX3DV4 - SN7517 ConvF(7.74, 7.74, 7.74); Calibrated: 1/19/2022

System Performance Check at Frequencies above 1 GHz/d=10mm, Pin=250mW, dist=2.0mm

(EX-Probe)/Area Scan (61x81x1): Interpolated grid: dx=1.000 mm, dy=1.000 mm

Maximum value of SAR (interpolated) = 13.0 W/kg

System Performance Check at Frequencies above 1 GHz/d=10mm, Pin=250mW, dist=2.0mm

(EX-Probe)/Zoom Scan (7x7x7) (7x7x7)/Cube 0: Measurement grid: dx=5mm, dy=5mm, dz=5mm

Reference Value = 94.33 V/m; Power Drift = -0.12 dB

Peak SAR (extrapolated) = 16.7 W/kg

SAR(1 g) = 9.08 W/kg; SAR(10 g) = 4.73 W/kg

Maximum value of SAR (measured) = 13.0 W/kg

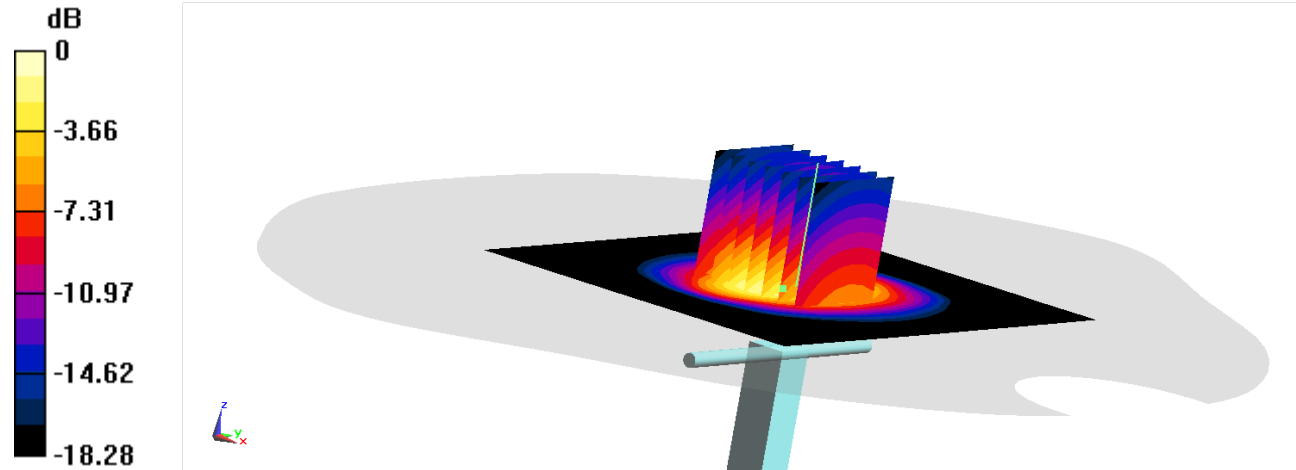

0 dB = 13.0 W/kg = 11.14 dBW/kg

SystemPerformanceCheck-D2450_869

Date/Time: 6/10/2022

Electronics: DAE4 Sn1525

Medium: H700-6000M

Medium parameters used: $f = 2450$ MHz; $\sigma = 1.882$ S/m; $\epsilon_r = 41.039$; $\rho = 1000$ kg/m³

Ambient Temperature: 23.3°C Liquid Temperature: 22.5°C

Communication System: UID 0, CW (0) Frequency: 2450 MHz Duty Cycle: 1:1

Probe: EX3DV4 - SN7517 ConvF(7.16, 7.16, 7.16); Calibrated: 1/19/2022

System Performance Check at Frequencies above 1 GHz/d=10mm, Pin=250mW, dist=2.0mm (EX-Probe)/Area Scan (51x71x1): Interpolated grid: dx=1.000 mm, dy=1.000 mm
Maximum value of SAR (interpolated) = 21.5 W/kg

System Performance Check at Frequencies above 1 GHz/d=10mm, Pin=250mW, dist=2.0mm (EX-Probe)/Zoom Scan (7x7x7) (7x7x7)/Cube 0: Measurement grid: dx=5mm, dy=5mm, dz=5mm
Reference Value = 103.5 V/m; Power Drift = -0.09 dB
Peak SAR (extrapolated) = 25.8 W/kg
SAR(1 g) = 12.7 W/kg; SAR(10 g) = 5.95 W/kg
Maximum value of SAR (measured) = 19.3 W/kg

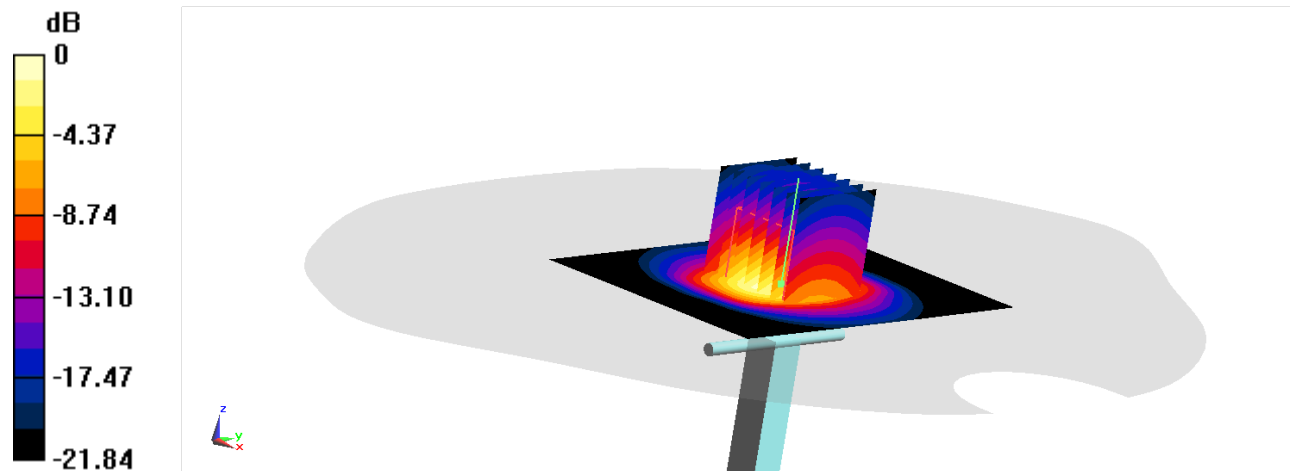

0 dB = 19.3 W/kg = 12.86 dBW/kg

SystemPerformanceCheck-2600_1012

Date/Time: 6/12/2022

Electronics: DAE4 Sn1525

Medium: H700-6000M

Medium parameters used: $f = 2600$ MHz; $\sigma = 1.988$ S/m; $\epsilon_r = 40.575$; $\rho = 1000$ kg/m³

Ambient Temperature: 23.3°C Liquid Temperature: 22.5°C

Communication System: UID 0, CW (0) Frequency: 2600 MHz Duty Cycle: 1:1

Probe: EX3DV4 - SN7517 ConvF(6.97, 6.97, 6.97); Calibrated: 1/19/2022

System Performance Check at Frequencies above 1 GHz/d=10mm, Pin=250 mW, dist=2.0mm

(EX-Probe)/Area Scan (81x91x1): Interpolated grid: dx=1.000 mm, dy=1.000 mm

Maximum value of SAR (interpolated) = 20.4 W/kg

System Performance Check at Frequencies above 1 GHz/d=10mm, Pin=250 mW, dist=2.0mm

(EX-Probe)/Zoom Scan (7x7x7) (7x7x7)/Cube 0: Measurement grid: dx=5mm, dy=5mm, dz=5mm

Reference Value = 92.39 V/m; Power Drift = 0.20 dB

Peak SAR (extrapolated) = 27.8 W/kg

SAR(1 g) = 13.24 W/kg; SAR(10 g) = 5.86 W/kg

Maximum value of SAR (measured) = 20.3 W/kg

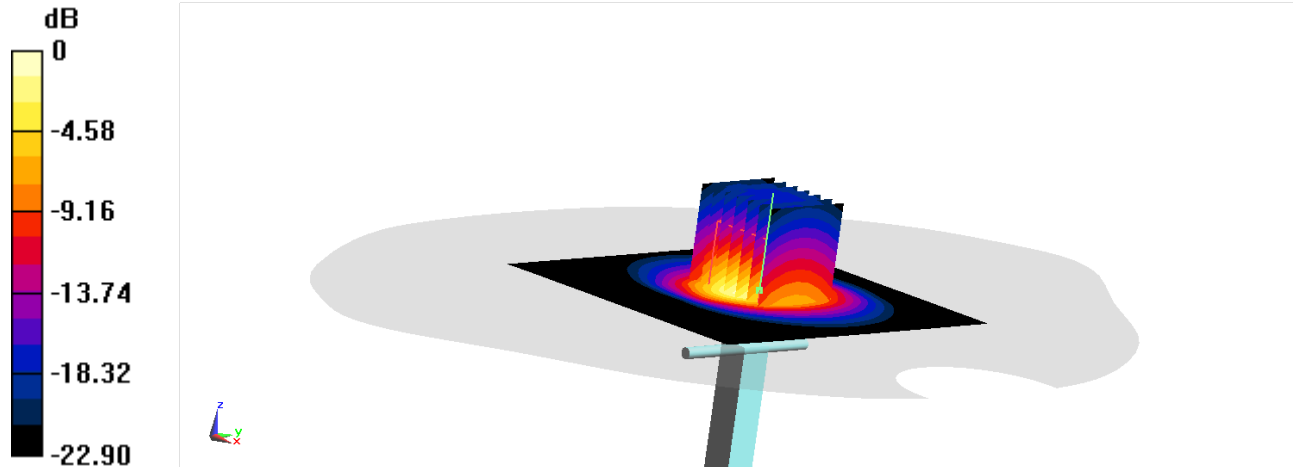

0 dB = 20.3 W/kg = 13.07 dBW/kg

SystemPerformanceCheck-D5GHz-graded

Date/Time: 6/15/2022

Electronics: DAE4 Sn1525

Medium: H700-6000M

Medium parameters used: $f = 5250$ MHz; $\sigma = 4.656$ S/m; $\epsilon_r = 36.068$; $\rho = 1000$ kg/m³

Ambient Temperature: 23.3°C Liquid Temperature: 22.5°C

Communication System: UID 0, CW (0) Frequency: 5250 MHz Duty Cycle: 1:1

Probe: EX3DV4 - SN7517 ConvF(5.3, 5.3, 5.3); Calibrated: 1/19/2022

System Performance Check with D5GHzV2 Dipole (graded grid)/d=10mm, Pin=100mW, f=5250 MHz/Area Scan (91x91x1): Interpolated grid: dx=1.000 mm, dy=1.000 mm
Maximum value of SAR (interpolated) = 19.5 W/kg

System Performance Check with D5GHzV2 Dipole (graded grid)/d=10mm, Pin=100mW, f=5250 MHz/Zoom Scan (7x7x11)/Cube 0: Measurement grid: dx=4mm, dy=4mm, dz=1.4mm
Reference Value = 44.80 V/m; Power Drift = -0.07 dB
Peak SAR (extrapolated) = 28.2 W/kg
SAR(1 g) = 7.72 W/kg; SAR(10 g) = 2.2 W/kg
Maximum value of SAR (measured) = 17.8 W/kg

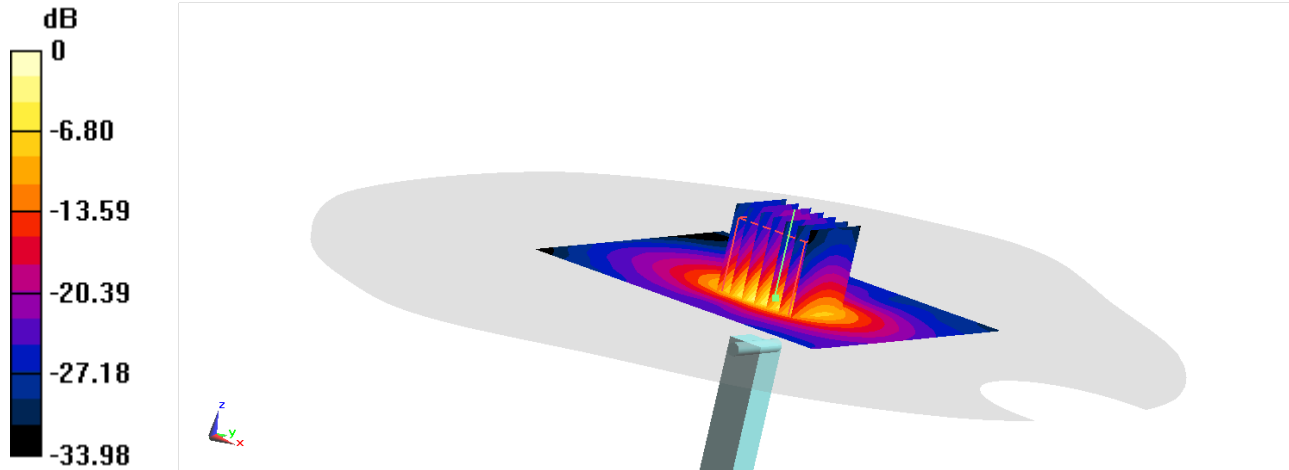

0 dB = 17.8 W/kg = 12.50 dBW/kg

System Performance Check-D5GHz-graded

Date/Time: 6/19/2022

Electronics: DAE4 Sn1525

Medium: H700-6000M

Medium parameters used: $f = 5600$ MHz; $\sigma = 5.071$ S/m; $\epsilon_r = 35.418$; $\rho = 1000$ kg/m³

Ambient Temperature: 23.3°C Liquid Temperature: 22.5°C

Communication System: UID 0, CW (0) Frequency: 5600 MHz Duty Cycle: 1:1

Probe: EX3DV4 - SN7517 ConvF(4.7, 4.7, 4.7); Calibrated: 1/19/2022

System Performance Check with D5GHzV2 Dipole (graded grid)/d=10mm, Pin=100mW, f=5600 MHz/Area Scan (91x91x1): Interpolated grid: dx=1.000 mm, dy=1.000 mm

Maximum value of SAR (interpolated) = 24.5 W/kg

System Performance Check with D5GHzV2 Dipole (graded grid)/d=10mm, Pin=100mW, f=5600 MHz/Zoom Scan 2 (7x7x7)/Cube 0: Measurement grid: dx=4mm, dy=4mm, dz=1.4mm

Reference Value = 71.81 V/m; Power Drift = -0.08 dB

Peak SAR (extrapolated) = 35.6 W/kg

SAR(1 g) = 8.31 W/kg; SAR(10 g) = 2.37 W/kg

Maximum value of SAR (measured) = 20.9 W/kg

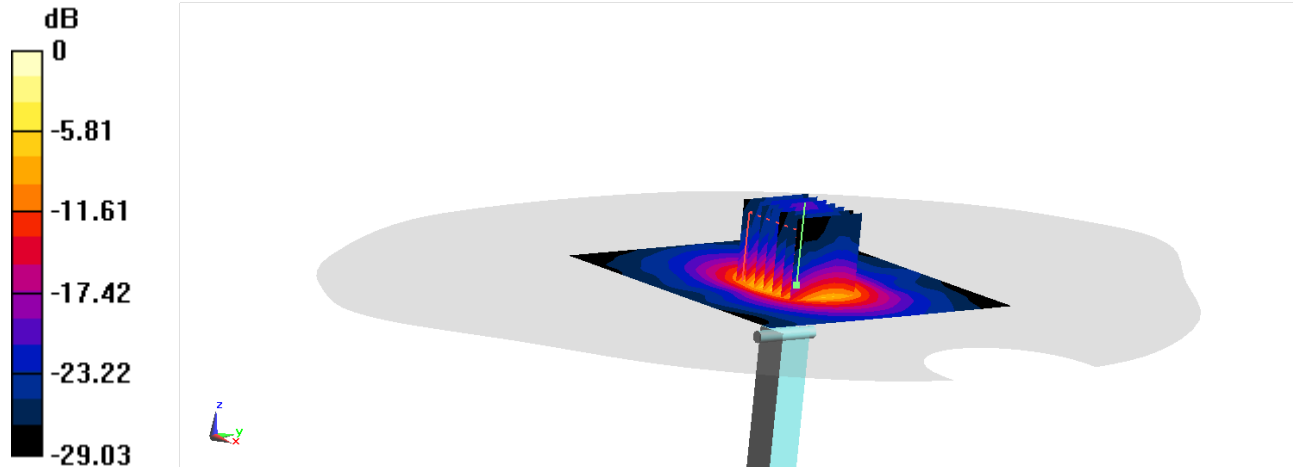

0 dB = 20.9 W/kg = 13.20 dBW/kg

SystemPerformanceCheck-D5GHz-graded

Date/Time: 6/21/2022

Electronics: DAE4 Sn1525

Medium: H700-6000M

Medium parameters used: $f = 5750$ MHz; $\sigma = 5.265$ S/m; $\epsilon_r = 34.967$; $\rho = 1000$ kg/m³

Ambient Temperature: 23.3°C Liquid Temperature: 22.5°C

Communication System: UID 0, CW (0) Frequency: 5750 MHz Duty Cycle: 1:1

Probe: EX3DV4 - SN7517 ConvF(4.75, 4.75, 4.75); Calibrated: 1/19/2022

System Performance Check with D5GHzV2 Dipole (graded grid)/d=10mm, Pin=100mW, f=5750 MHz/Area Scan (91x91x1): Interpolated grid: dx=1.000 mm, dy=1.000 mm

Maximum value of SAR (interpolated) = 20.7 W/kg

System Performance Check with D5GHzV2 Dipole (graded grid)/d=10mm, Pin=100mW, f=5750 MHz/Zoom Scan 2 (7x7x7)/Cube 0: Measurement grid: dx=4mm, dy=4mm, dz=1.4mm

Reference Value = 44.31 V/m; Power Drift = -0.03 dB

Peak SAR (extrapolated) = 30.6 W/kg

SAR(1 g) = 7.78 W/kg; SAR(10 g) = 2.23 W/kg

Maximum value of SAR (measured) = 18.8 W/kg

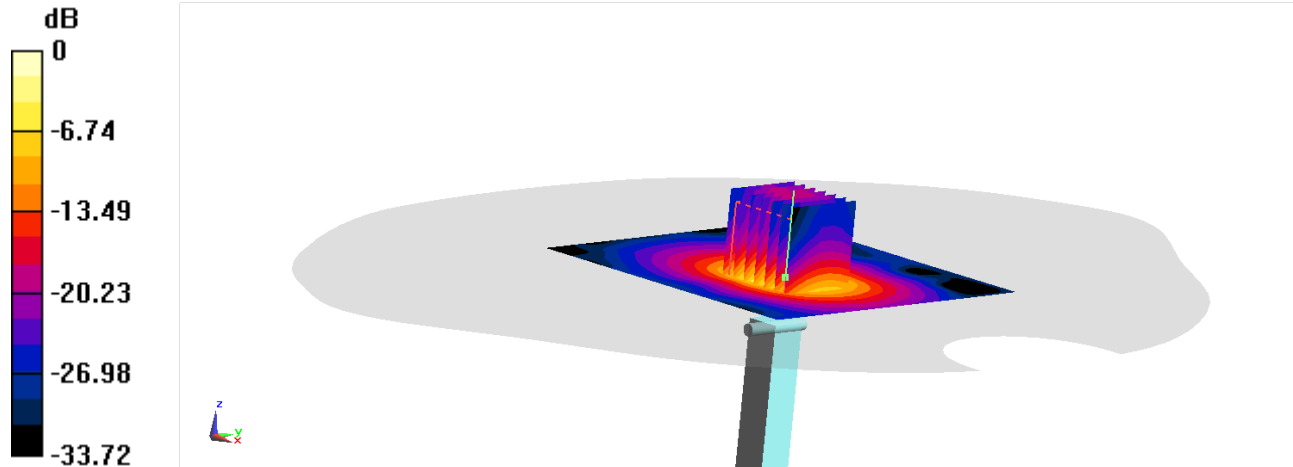

0 dB = 18.8 W/kg = 12.74 dBW/kg

ANNEX C SAR Measurement Setup

C.1 Measurement Set-up

The Dasy4 or DASY5 system for performing compliance tests is illustrated above graphically. This system consists of the following items:

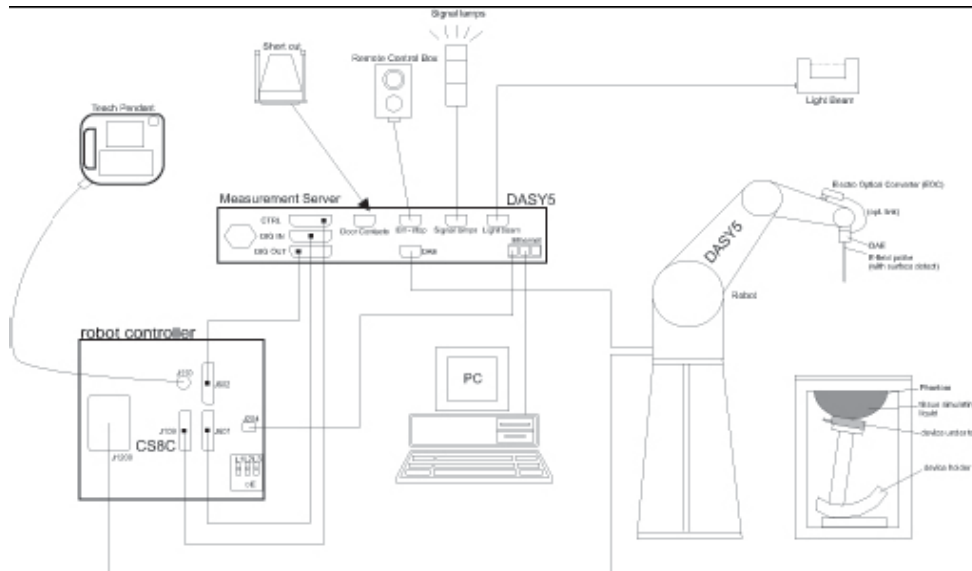

Picture C.1 SAR Lab Test Measurement Set-up

- A standard high precision 6-axis robot (StäubliTX=RX family) with controller, teach pendant and software. An arm extension for accommodating the data acquisition electronics (DAE).
- An isotropic field probe optimized and calibrated for the targeted measurement.
- A data acquisition electronics (DAE) which performs the signal amplification, signal multiplexing, AD-conversion, offset measurements, mechanical surface detection, collision detection, etc. The unit is battery powered with standard or rechargeable batteries. The signal is optically transmitted to the EOC.
- The Electro-optical converter (EOC) performs the conversion from optical to electrical signals for the digital communication to the DAE. To use optical surface detection, a special version of the EOC is required. The EOC signal is transmitted to the measurement server.
- The function of the measurement server is to perform the time critical tasks such as signal filtering, control of the robot operation and fast movement interrupts.
- The Light Beam used is for probe alignment. This improves the (absolute) accuracy of the probe positioning.
- A computer running WinXP and the DASY4 or DASY5 software.
- Remote control and teach pendant as well as additional circuitry for robot safety such as
- warning lamps, etc.
- The phantom, the device holder and other accessories according to the targeted measurement.

C.2 Dasy4 or DASY5 E-field Probe System

The SAR measurements were conducted with the dosimetric probe designed in the classical triangular configuration and optimized for dosimetric evaluation. The probe is constructed using the thick film technique; with printed resistive lines on ceramic substrates. The probe is equipped with an optical multifiber line ending at the front of the probe tip. It is connected to the EOC box on the robot arm and provides an automatic detection of the phantom surface. Half of the fibers are connected to a pulsed infrared transmitter, the other half to a synchronized receiver. As the probe approaches the surface, the reflection from the surface produces a coupling from the transmitting to the receiving fibers. This reflection increases first during the approach, reaches maximum and then decreases. If the probe is flatly touching the surface, the coupling is zero. The distance of the coupling maximum to the surface is independent of the surface reflectivity and largely independent of the surface to probe angle. The DASY4 or DASY5 software reads the reflection during a software approach and looks for the maximum using 2nd order curve fitting. The approach is stopped at reaching the maximum.

Probe Specifications:

Model:	ES3DV3, EX3DV4
Frequency	10MHz — 6.0GHz(EX3DV4)
Range:	10MHz — 4GHz(ES3DV3)
Calibration:	In head and body simulating tissue at Frequencies from 835 up to 5800MHz
Linearity:	± 0.2 dB(30 MHz to 6 GHz) for EX3DV4 ± 0.2 dB(30 MHz to 4 GHz) for ES3DV3
DynamicRange:	10 mW/kg — 100W/kg
Probe Length:	330 mm
Probe Tip	
Length:	20 mm
Body Diameter:	12 mm
Tip Diameter:	2.5 mm (3.9 mm for ES3DV3)
Tip-Center:	1 mm (2.0mm for ES3DV3)
Application:	SAR Dosimetry Testing Compliance tests of mobile phones Dosimetry in strong gradient fields



Picture C.2 Near-field Probe



Picture C.3 E-field Probe

C.3 E-field Probe Calibration

Each E-Probe/Probe Amplifier combination has unique calibration parameters. A TEM cell calibration procedure is conducted to determine the proper amplifier settings to enter in the probe parameters. The amplifier settings are determined for a given frequency by subjecting the probe to a known E-field density (1 mW/cm²) using an RF Signal generator, TEM cell, and RF Power Meter.

The free space E-field from amplified probe outputs is determined in a test chamber. This calibration can be performed in a TEM cell if the frequency is below 1 GHz and in a waveguide or

other methodologies above 1 GHz for free space. For the free space calibration, the probe is placed in the volumetric center of the cavity and at the proper orientation with the field. The probe is then rotated 360 degrees until the three channels show the maximum reading. The power density readings equates to 1 mW/cm².

E-field temperature correlation calibration is performed in a flat phantom filled with the appropriate simulated brain tissue. The E-field in the medium correlates with the temperature rise in the dielectric medium. For temperature correlation calibration a RF transparent thermistor-based temperature probe is used in conjunction with the E-field probe.

$$SAR = C \frac{\Delta T}{\Delta t}$$

Where:

Δt = Exposure time (30 seconds),

C = Heat capacity of tissue (brain or muscle),

ΔT = Temperature increase due to RF exposure.

$$SAR = \frac{|E|^2 \cdot \sigma}{\rho}$$

Where:

σ = Simulated tissue conductivity,

ρ = Tissue density (kg/m³).

C.4 Other Test Equipment

C.4.1 Data Acquisition Electronics(DAE)

The data acquisition electronics consist of a highly sensitive electrometer-grade preamplifier with auto-zeroing, a channel and gain-switching multiplexer, a fast 16 bit AD-converter and a command decoder with a control logic unit. Transmission to the measurement server is accomplished through an optical downlink for data and status information, as well as an optical uplink for commands and the clock.

The mechanical probe mounting device includes two different sensor systems for frontal and sideways probe contacts. They are used for mechanical surface detection and probe collision detection.

The input impedance of the DAE is 200 MOhm; the inputs are symmetrical and floating. Common mode rejection is above 80 dB.



PictureC.4: DAE

C.4.2 Robot

The SPEAG DASY system uses the high precision robots (DASY4: RX90XL; DASY5: RX160L) type from Stäubli SA (France). For the 6-axis controller system, the robot controller version from Stäubli is used. The Stäubli robot series have many features that are important for our application:

- High precision (repeatability 0.02mm)
- High reliability (industrial design)
- Low maintenance costs (virtually maintenance free due to direct drive gears; no belt drives)
- Jerk-free straight movements (brushless synchron motors; no stepper motors)
- Low ELF interference (motor control fields shielded via the closed metallic construction shields)



Picture C.5 DASY 4



Picture C.6 DASY 5

C.4.3 Measurement Server

The Measurement server is based on a PC/104 CPU board with CPU (dasy4: 166 MHz, Intel Pentium; DASY5: 400 MHz, Intel Celeron), chipdisk (DASY4: 32 MB; DASY5: 128MB), RAM (DASY4: 64 MB, DASY5: 128MB). The necessary circuits for communication with the DAE electronic box, as well as the 16 bit AD converter system for optical detection and digital I/O interface are contained on the DASY I/O board, which is directly connected to the PC/104 bus of the CPU board.

The measurement server performs all real-time data evaluation of field measurements and surface detection, controls robot movements and handles safety operation. The PC operating system cannot interfere with these time critical processes. All connections are supervised by a watchdog, and disconnection of any of the cables to the measurement server will automatically disarm the robot and disable all program-controlled robot movements. Furthermore, the measurement server is equipped with an expansion port which is reserved for future applications. Please note that this expansion port does not have a standardized pinout, and therefore only devices provided by SPEAG can be connected. Devices from any other supplier could seriously damage the measurement server.



Picture C.7 Server for DASY 4



Picture C.8 Server for DASY 5

C.4.4 Device Holder for Phantom

The SAR in the phantom is approximately inversely proportional to the square of the distance between the source and the liquid surface. For a source at 5mm distance, a positioning uncertainty of $\pm 0.5\text{mm}$ would produce a SAR uncertainty of $\pm 20\%$. Accurate device positioning is therefore crucial for accurate and repeatable measurements. The positions in which the devices must be measured are defined by the standards.

The DASY device holder is designed to cope with the different positions given in the standard. It has two scales for device rotation (with respect to the body axis) and device inclination (with respect to the line between the ear reference points). The rotation centers for both scales are the ear reference point (ERP). Thus the device needs no repositioning when changing the angles. The DASY device holder is constructed of low-loss POM material having the following dielectric parameters: relative permittivity $\epsilon = 3$ and loss tangent $\delta = 0.02$. The amount of dielectric material has been reduced in the closest vicinity of the device, since measurements have suggested that the influence of the clamp on the test results could thus be lowered.

<Laptop Extension Kit>

The extension is lightweight and made of POM, acrylic glass and foam. It fits easily on the upper part of the Mounting Device in place of the phone positioner. The extension is fully compatible with the Twin-SAM and ELI phantoms.



Picture C.9-1: Device Holder

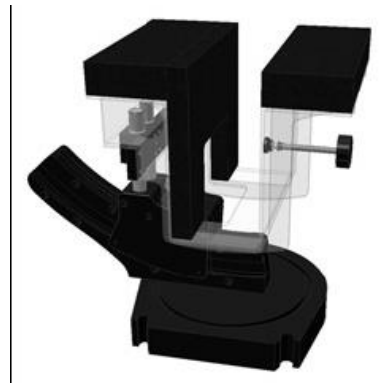

Picture C.9-2: Laptop Extension Kit

C.4.5 Phantom

The SAM Twin Phantom V4.0 is constructed of a fiberglass shell integrated in a table. The shape of the shell is based on data from an anatomical study designed to

Represent the 90th percentile of the population. The phantom enables the dissymmetric evaluation of SAR for both left and right handed handset usage, as well as body-worn usage using the flat phantom region. Reference markings on the Phantom allow the complete setup of all predefined phantom positions and measurement grids by manually teaching three points in the robot. The shell phantom has a 2mm shell thickness (except the ear region where shell thickness increases to 6 mm).

Shell Thickness: 2 ± 0.2 mm

Filling Volume: Approx. 25 liters

Dimensions: 810 x 1000 x 500 mm (H x L x W)

Available: Special



Picture C.10: SAM Twin Phantom

ANNEX D Position of the wireless device in relation to the phantom

D.1 General considerations

This standard specifies two handset test positions against the head phantom – the “cheek” position and the “tilt” position.

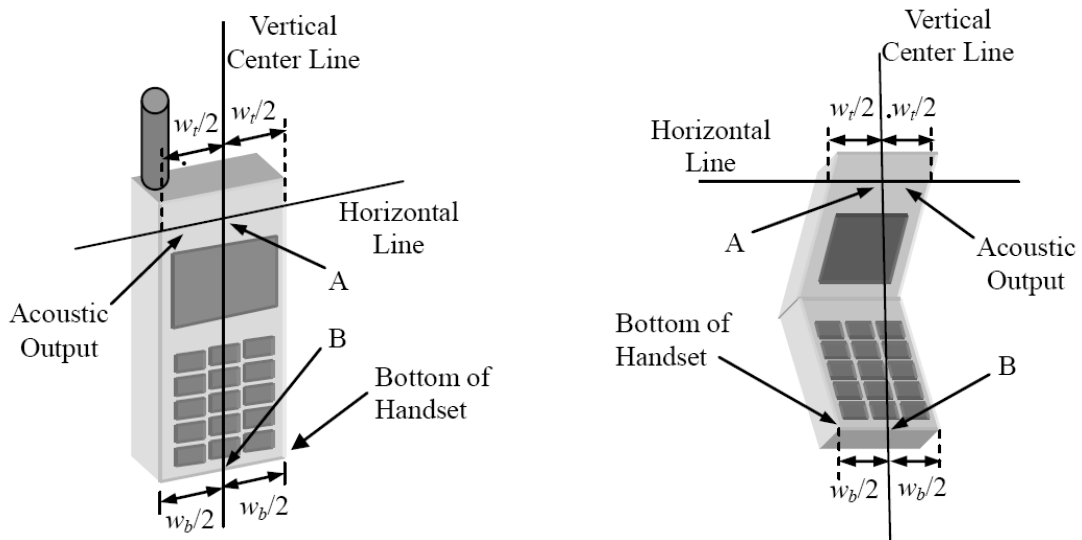

- w_t Width of the handset at the level of the acoustic
- w_b Width of the bottom of the handset
- A Midpoint of the width w_t of the handset at the level of the acoustic output
- B Midpoint of the width w_b of the bottom of the handset

Picture D.1-a Typical “fixed” case handset Picture D.1-b Typical “clam-shell” case handset

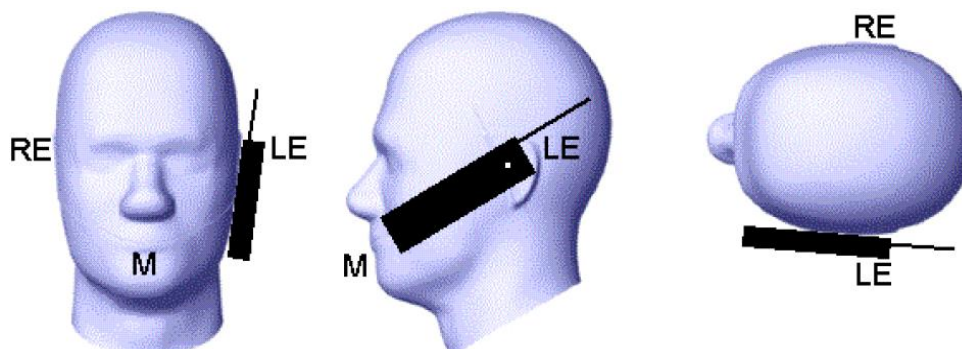

Picture D.2 Cheek position of the wireless device on the left side of SAM

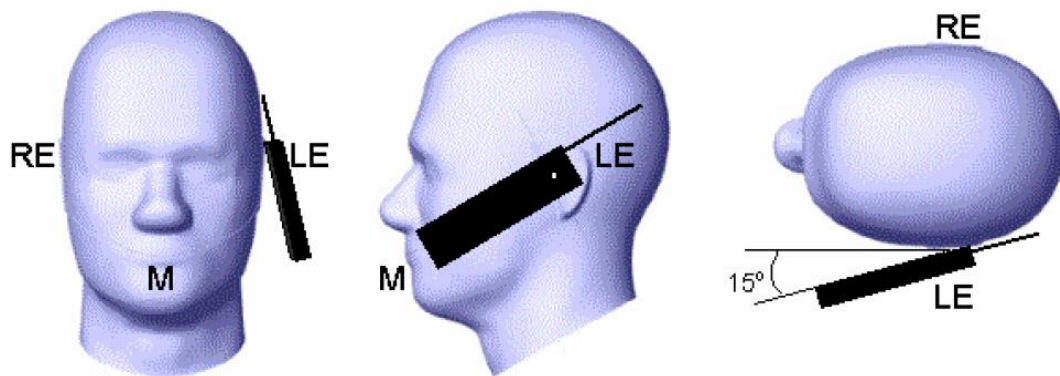

Picture D.3 Tilt position of the wireless device on the left side of SAM

D.2 Body-worn device

A typical example of a body-worn device is a mobile phone, wireless enabled PDA or other battery operated wireless device with the ability to transmit while mounted on a person's body using a carry accessory approved by the wireless device manufacturer.

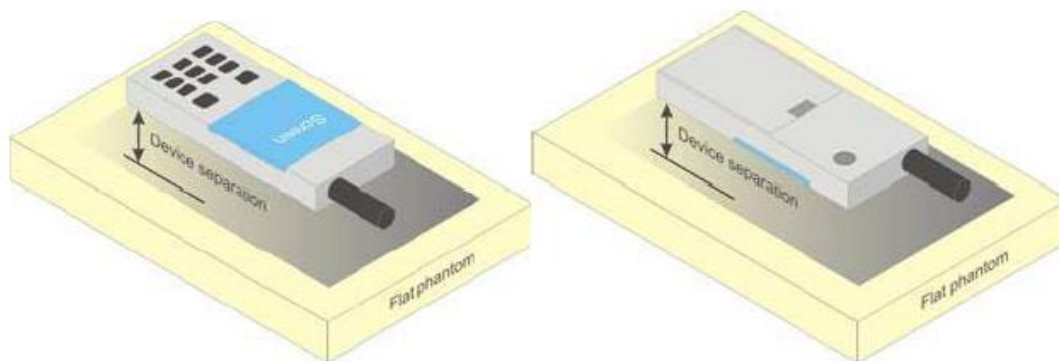

Picture D.4 Test positions for body-worn devices

D.3 Desktop device

A typical example of a desktop device is a wireless enabled desktop computer placed on a table or desk when used.

The DUT shall be positioned at the distance and in the orientation to the phantom that corresponds to the intended use as specified by the manufacturer in the user instructions. For devices that employ an external antenna with variable positions, tests shall be performed for all antenna positions specified. Picture 8.5 show positions for desktop device SAR tests. If the intended use is not specified, the device shall be tested directly against the flat phantom.

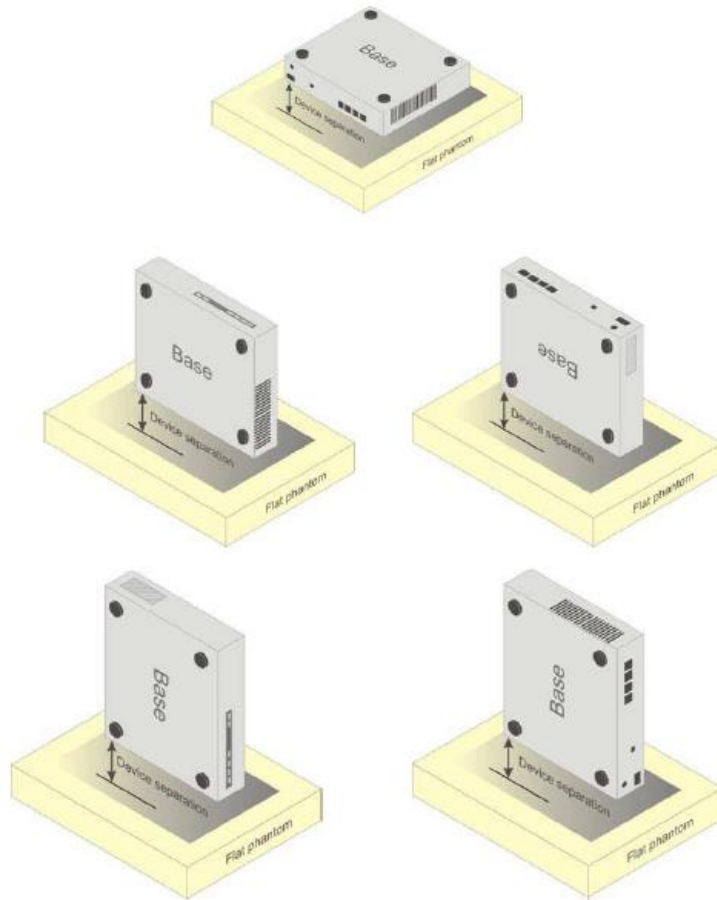

Picture D.5 Test positions for desktop devices

D.4 DUT Setup Photos



Picture D.6

ANNEX E Equivalent Media Recipes

The liquid used for the frequency range of 800-3000 MHz consisted of water, sugar, salt, preventol, glycol monobutyl and Cellulose. The liquid has been previously proven to be suited for worst-case. The Table E.1 shows the detail solution. It's satisfying the latest tissue dielectric parameters requirements proposed by the IEEE 1528 and IEC 62209.

TableE.1: Composition of the Tissue Equivalent Matter

Frequency (MHz)	835Head	835Body	1900 Head	1900 Body	2450 Head	2450 Body	5800 Head	5800 Body
Ingredients (% by weight)								
Water	41.45	52.5	55.242	69.91	58.79	72.60	65.53	65.53
Sugar	56.0	45.0	\	\	\	\	\	\
Salt	1.45	1.4	0.306	0.13	0.06	0.18	\	\
Preventol	0.1	0.1	\	\	\	\	\	\
Cellulose	1.0	1.0	\	\	\	\	\	\
Glycol Monobutyl	\	\	44.452	29.96	41.15	27.22	\	\
Diethylenglycol monohexylether	\	\	\	\	\	\	17.24	17.24
Triton X-100	\	\	\	\	\	\	17.24	17.24
Dielectric Parameters Target Value	$\epsilon=41.5$ $\sigma=0.90$	$\epsilon=55.2$ $\sigma=0.97$	$\epsilon=40.0$ $\sigma=1.40$	$\epsilon=53.3$ $\sigma=1.52$	$\epsilon=39.2$ $\sigma=1.80$	$\epsilon=52.7$ $\sigma=1.95$	$\epsilon=35.3$ $\sigma=5.27$	$\epsilon=48.2$ $\sigma=6.00$

Note: There are a little adjustment respectively for 750, 1750, 2600, 5200, 5300 and 5600 based on the recipe of closest frequency in table E.1.

ANNEX F System Validation

The SAR system must be validated against its performance specifications before it is deployed. When SAR probes, system components or software are changed, upgraded or recalibrated, these must be validated with the SAR system(s) that operates with such components.

Table F.1: System Validation for 7517

Probe SN.	Liquid name	Validation date	Frequency point	Status (OK or Not)
7517	Head 750MHz	February.7,2022	750 MHz	OK
7517	Head 835MHz	February.7,2022	835 MHz	OK
7517	Head 900MHz	February.7,2022	900 MHz	OK
7517	Head 1750MHz	February.7,2022	1750 MHz	OK
7517	Head 1900MHz	February.8,2022	1900 MHz	OK
7517	Head 2300MHz	February.8,2022	2300 MHz	OK
7517	Head 2450MHz	February.8,2022	2450 MHz	OK
7517	Head 2600MHz	February.8,2022	2600 MHz	OK
7517	Head 3300MHz	February.9,2022	3300 MHz	OK
7517	Head 3500MHz	February.9,2022	3500 MHz	OK
7517	Head 3700MHz	February.9,2022	3700 MHz	OK
7517	Head 5250MHz	February.10,2022	5250 MHz	OK
7517	Head 5600MHz	February.10,2022	5600 MHz	OK
7517	Head 5750MHz	February.10,2022	5750 MHz	OK



ANNEX G Probe Calibration Certificate

Probe 7517 Calibration Certificate



Add: No.52 HuaYuanBei Road, Haidian District, Beijing, 100191, China
 Tel: +86-10-62304633-2512 Fax: +86-10-62304633-2504
 E-mail: cttl@chinattl.com Http://www.chinattl.cn

Client

CTTL

Certificate No: Z21-60558

CALIBRATION CERTIFICATE

Object EX3DV4 - SN : 7517

Calibration Procedure(s) FF-Z11-004-02
 Calibration Procedures for Dosimetric E-field Probes

Calibration date: January 19, 2022

This calibration Certificate documents the traceability to national standards, which realize the physical units of measurements(SI). The measurements and the uncertainties with confidence probability are given on the following pages and are part of the certificate.

All calibrations have been conducted in the closed laboratory facility: environment temperature(22±3)°C and humidity<70%.

Calibration Equipment used (M&TE critical for calibration)

Primary Standards	ID #	Cal Date(Calibrated by, Certificate No.)	Scheduled Calibration
Power Meter NRP2	101919	15-Jun-21(CTTL, No.J21X04466)	Jun-22
Power sensor NRP-Z91	101547	15-Jun-21(CTTL, No.J21X04466)	Jun-22
Power sensor NRP-Z91	101548	15-Jun-21(CTTL, No.J21X04466)	Jun-22
Reference 10dBAttenuator	18N50W-10dB	10-Feb-20(CTTL, No.J20X00525)	Feb-22
Reference 20dBAttenuator	18N50W-20dB	10-Feb-20(CTTL, No.J20X00526)	Feb-22
Reference Probe EX3DV4	SN 3617	27-Jan-21(SPEAG, No.EX3-3617_Jan21)	Jan-22
DAE4	SN 1555	20-Aug-21(SPEAG, No.DAE4-1555_Aug21/2)	Aug-22

Secondary Standards	ID #	Cal Date(Calibrated by, Certificate No.)	Scheduled Calibration
SignalGenerator MG3700A	6201052605	16-Jun-21(CTTL, No.J21X04467)	Jun-22
Network Analyzer E5071C	MY46110673	14-Jan-22 (CTTL, No.J22X00406)	Jan -23

	Name	Function	Signature
Calibrated by:	Yu Zongying	SAR Test Engineer	
Reviewed by:	Lin Hao	SAR Test Engineer	
Approved by:	Qi Dianyuan	SAR Project Leader	

Issued: January 21, 2022

This calibration certificate shall not be reproduced except in full without written approval of the laboratory.

Certificate No: Z21-60558

Page 1 of 10

Glossary:

TSL	tissue simulating liquid
NORM _{x,y,z}	sensitivity in free space
ConvF	sensitivity in TSL / NORM _{x,y,z}
DCP	diode compression point
CF	crest factor (1/duty_cycle) of the RF signal
A,B,C,D	modulation dependent linearization parameters
Polarization Φ	Φ rotation around probe axis
Polarization θ	θ rotation around an axis that is in the plane normal to probe axis (at measurement center), i $\theta=0$ is normal to probe axis
Connector Angle	information used in DASY system to align probe sensor X to the robot coordinate system

Calibration is Performed According to the Following Standards:

- IEEE Std 1528-2013, "IEEE Recommended Practice for Determining the Peak Spatial-Averaged Specific Absorption Rate (SAR) in the Human Head from Wireless Communications Devices: Measurement Techniques", June 2013
- IEC 62209-1, "Measurement procedure for the assessment of Specific Absorption Rate (SAR) from hand-held and body-mounted devices used next to the ear (frequency range of 300 MHz to 6 GHz)", July 2016
- IEC 62209-2, "Procedure to determine the Specific Absorption Rate (SAR) for wireless communication devices used in close proximity to the human body (frequency range of 30 MHz to 6 GHz)", March 2010
- KDB 865664, "SAR Measurement Requirements for 100 MHz to 6 GHz"

Methods Applied and Interpretation of Parameters:

- NORM_{x,y,z}**: Assessed for E-field polarization $\theta=0$ ($f \leq 900\text{MHz}$ in TEM-cell; $f > 1800\text{MHz}$: waveguide). NORM_{x,y,z} are only intermediate values, i.e., the uncertainties of NORM_{x,y,z} does not effect the E^2 -field uncertainty inside TSL (see below ConvF).
- NORM(f)_{x,y,z}** = NORM_{x,y,z} * frequency_response (see Frequency Response Chart). This linearization is implemented in DASY4 software versions later than 4.2. The uncertainty of the frequency response is included in the stated uncertainty of ConvF.
- DCP_{x,y,z}**: DCP are numerical linearization parameters assessed based on the data of power sweep (no uncertainty required). DCP does not depend on frequency nor media.
- PAR**: PAR is the Peak to Average Ratio that is not calibrated but determined based on the signal characteristics.
- A_{x,y,z}; B_{x,y,z}; C_{x,y,z}; VR_{x,y,z}; A,B,C** are numerical linearization parameters assessed based on the data of power sweep for specific modulation signal. The parameters do not depend on frequency nor media. VR is the maximum calibration range expressed in RMS voltage across the diode.
- ConvF and Boundary Effect Parameters**: Assessed in flat phantom using E-field (or Temperature Transfer Standard for $f \leq 800\text{MHz}$) and inside waveguide using analytical field distributions based on power measurements for $f > 800\text{MHz}$. The same setups are used for assessment of the parameters applied for boundary compensation (alpha, depth) of which typical uncertainty valued are given. These parameters are used in DASY4 software to improve probe accuracy close to the boundary. The sensitivity in TSL corresponds to NORM_{x,y,z} * ConvF whereby the uncertainty corresponds to that given for ConvF. A frequency dependent ConvF is used in DASY version 4.4 and higher which allows extending the validity from $\pm 50\text{MHz}$ to $\pm 100\text{MHz}$.
- Spherical isotropy (3D deviation from isotropy)**: in a field of low gradients realized using a flat phantom exposed by a patch antenna.
- Sensor Offset**: The sensor offset corresponds to the offset of virtual measurement center from the probe tip (on probe axis). No tolerance required.
- Connector Angle**: The angle is assessed using the information gained by determining the NORM_x (no uncertainty required).

DASY/EASY – Parameters of Probe: EX3DV4 – SN:7517

Basic Calibration Parameters

	Sensor X	Sensor Y	Sensor Z	Unc (k=2)
Norm($\mu\text{V}/(\text{V}/\text{m})^2$) ^A	0.49	0.51	0.55	±10.0%
DCP(mV) ^B	101.9	101.5	100.9	

Modulation Calibration Parameters

UID	Communication System Name		A dB	B dB- μV	C	D dB	VR mV	Unc ^E (k=2)
0	CW	X	0.0	0.0	1.0	0.00	168.0	±3.0%
		Y	0.0	0.0	1.0		172.3	
		Z	0.0	0.0	1.0		178.0	

The reported uncertainty of measurement is stated as the standard uncertainty of Measurement multiplied by the coverage factor $k=2$, which for a normal distribution Corresponds to a coverage probability of approximately 95%.

^A The uncertainties of Norm X, Y, Z do not affect the E^2 -field uncertainty inside TSL (see Page 4 and Page 5).

^B Numerical linearization parameter: uncertainty not required.

^E Uncertainty is determined using the max. deviation from linear response applying rectangular distribution and is expressed for the square of the field value.

DASY/EASY – Parameters of Probe: EX3DV4 – SN:7517

Calibration Parameter Determined in Head Tissue Simulating Media

f [MHz] ^C	Relative Permittivity ^F	Conductivity (S/m) ^F	ConvF X	ConvF Y	ConvF Z	Alpha ^G	Depth ^G (mm)	Unct. (k=2)
750	41.9	0.89	9.70	9.70	9.70	0.15	1.32	±12.1%
900	41.5	0.97	9.30	9.30	9.30	0.21	1.19	±12.1%
1450	40.5	1.20	8.40	8.40	8.40	0.18	1.06	±12.1%
1640	40.3	1.29	8.20	8.20	8.20	0.30	0.90	±12.1%
1750	40.1	1.37	8.10	8.10	8.10	0.25	0.93	±12.1%
1900	40.0	1.40	7.74	7.74	7.74	0.30	0.90	±12.1%
2100	39.8	1.49	7.64	7.64	7.64	0.24	1.09	±12.1%
2300	39.5	1.67	7.44	7.44	7.44	0.64	0.68	±12.1%
2450	39.2	1.80	7.16	7.16	7.16	0.43	0.91	±12.1%
2600	39.0	1.96	6.97	6.97	6.97	0.57	0.77	±12.1%
3300	38.2	2.71	6.85	6.85	6.85	0.45	0.92	±13.3%
3500	37.9	2.91	6.60	6.60	6.60	0.40	1.03	±13.3%
3700	37.7	3.12	6.34	6.34	6.34	0.41	1.03	±13.3%
3900	37.5	3.32	6.25	6.25	6.25	0.35	1.35	±13.3%
4100	37.2	3.53	6.34	6.34	6.34	0.40	1.15	±13.3%
4200	37.1	3.63	6.26	6.26	6.26	0.35	1.35	±13.3%
4400	36.9	3.84	6.15	6.15	6.15	0.35	1.35	±13.3%
4600	36.7	4.04	6.05	6.05	6.05	0.50	1.13	±13.3%
4800	36.4	4.25	6.01	6.01	6.01	0.50	1.13	±13.3%
4950	36.3	4.40	5.74	5.74	5.74	0.45	1.25	±13.3%
5250	35.9	4.71	5.30	5.30	5.30	0.50	1.25	±13.3%
5600	35.5	5.07	4.70	4.70	4.70	0.55	1.20	±13.3%
5750	35.4	5.22	4.75	4.75	4.75	0.55	1.20	±13.3%

^C Frequency validity above 300 MHz of ±100MHz only applies for DASY v4.4 and higher (Page 2), else it is restricted to ±50MHz. The uncertainty is the RSS of ConvF uncertainty at calibration frequency and the uncertainty for the indicated frequency band. Frequency validity below 300 MHz is ± 10, 25, 40, 50 and 70 MHz for ConvF assessments at 30, 64, 128, 150 and 220 MHz respectively. Above 5 GHz frequency validity can be extended to ± 110 MHz.

^F At frequency below 3 GHz, the validity of tissue parameters (ϵ and σ) can be relaxed to ±10% if liquid compensation formula is applied to measured SAR values. At frequencies above 3 GHz, the validity of tissue parameters (ϵ and σ) is restricted to ±5%. The uncertainty is the RSS of the ConvF uncertainty for indicated target tissue parameters.

^G Alpha/Depth are determined during calibration. SPEAG warrants that the remaining deviation due to the boundary effect after compensation is always less than ± 1% for frequencies below 3 GHz and below ± 2% for the frequencies between 3-6 GHz at any distance larger than half the probe tip diameter from the boundary.