



NFC TEST REPORT

No.I21Z70530-IOT13

for

Samsung Electronics Co.,Ltd

Smart Phone

SM-A035G/DSN

FCC ID : ZCASMA035G

with

Hardware Version: REV1.0

Software Version: A035G.001

Issued Date: 2021-11-18

Note:

The test results in this test report relate only to the devices specified in this report. This report shall not be reproduced except in full without the written approval of CTTL.

The report must not be used by the client to claim product certification, approval, or endorsement by NVLAP, NIST, or any agency of the U.S.Government.

Test Laboratory:

CTTL-Telecommunication Technology Labs, CAICT

No. 52, Huayuan North Road, Haidian District, Beijing, P. R. China 100191.

Tel:+86(0)10-62304633-2512, Fax:+86(0)10-62304633-2504

Email: cttl_terminals@caict.ac.cn, website: www.caict.ac.cn



REPORT HISTORY

| Report Number | Revision | Description | Issue Date |
|----------------------|-----------------|--------------------|-------------------|
| I21Z70530-IOT13 | Rev.0 | 1st edition | 2021-11-18 |

CONTENTS

| | |
|---|-----------|
| 1. TEST LABORATORY | 4 |
| 1.1. INTRODUCTION & ACCREDITATION..... | 4 |
| 1.2. TESTING LOCATION | 4 |
| 1.3. TESTING ENVIRONMENT | 5 |
| 1.4. PROJECT DATA | 5 |
| 1.5. SIGNATURE..... | 5 |
| 2. CLIENT INFORMATION..... | 5 |
| 2.1. APPLICANT INFORMATION..... | 6 |
| 2.2. MANUFACTURER INFORMATION..... | 6 |
| 3. EQUIPMENT UNDER TEST (EUT) AND ANCILLARY EQUIPMENT (AE) | 5 |
| 3.1. ABOUT EUT | 7 |
| 3.2. INTERNAL IDENTIFICATION OF EUT | 7 |
| 3.3. INTERNAL IDENTIFICATION OF AE | 7 |
| 3.4. EUT SET-UPS..... | 9 |
| 4. REFERENCE DOCUMENTS..... | 10 |
| 4.1. DOCUMENTS SUPPLIED BY APPLICANT | 10 |
| 4.2. REFERENCE DOCUMENTS FOR TESTING..... | 10 |
| 5. TEST RESULTS | 10 |
| 5.1. SUMMARY OF TEST RESULTS | 11 |
| 5.2. STATEMENTS..... | 12 |
| 6. TEST FACILITIES UTILIZED | 13 |
| 7. MEASUREMENT UNCERTAINTY | 14 |
| ANNEX A: EUT PARAMETERS..... | 15 |
| ANNEX B: DETAILED TEST RESULTS..... | 16 |
| ANNEX C: PERSONS INVOLVED IN THIS TESTING | 30 |
| ANNEX D: ACCREDITATION CERTIFICATE | 32 |



1. Test Laboratory

1.1. Introduction & Accreditation

Telecommunication Technology Labs, CAICT is an ISO/IEC 17025:2017 accredited test laboratory under NATIONAL VOLUNTARY LABORATORY ACCREDITATION PROGRAM (NVLAP) with lab code 600118-0, and is also an FCC accredited test laboratory (CN5017), and ISED accredited test laboratory (ISED#: 24849). The detail accreditation scope can be found on NVLAP website.

1.2. Testing Location

Location 1: CTTL(BDA)

Address: No. 18A, Kangding Street, Beijing Economic-Technology Development Area, Beijing, P. R. China 100176

Location 2: CTTL(huayuan North Road)

Address: No. 52, Huayuan North Road, Haidian District, Beijing, P. R. China 100191

1.3. Testing Environment

Normal Temperature: 15-35°C
Extreme Temperature: -20/+50°C
Normal Relative Humidity: 20-75%
Normal Air Pressure: 86Kpa-106Kpa

1.4. Project data

Testing Start Date: 2021-10-25
Testing End Date: 2021-11-15

1.5. Signature



Zhou Bin
(Prepared this test report)



Zhang Qiang
(Reviewed this test report)



Zhu Liang
(Approved this test report)



2. Client Information

2.1. Applicant Information

Company Name: Samsung Electronics Co.,Ltd
Address: Samsung R5, Maetan dong 129, Samsung ro Youngtong gu, Suwon city 443 742, Korea
Contact: Sunghoon Cho
Email: ggobi.cho@samsung.com
Telephone: +82-10-2722-4159
Fax: /

2.2. Manufacturer Information

Company Name: Samsung Electronics Co.,Ltd
Address: Samsung R5, Maetan dong 129, Samsung ro Youngtong gu, Suwon city 443 742, Korea
Contact: Sunghoon Cho
Email: ggobi.cho@samsung.com
Telephone: +82-10-2722-4159
Fax: /

3. Equipment Under Test (EUT) and Ancillary Equipment (AE)

3.1. About EUT

| | |
|------------------------|--|
| Description | Smart Phone |
| Model name/HVIN | SM-A035G/DSN |
| FCC ID | ZCASMA035G |
| GSM Frequency Bands | 900/1800/850 |
| UMTS Frequency Bands | FDD I/ V/ VIII |
| E-UTRA Frequency Bands | FDD 1/3/5/7/8/20/28/28a/28b TDD 38/40/41 |
| Operating Temperature | -10/+55°C |
| Nominal Voltage | 3.85V |
| Extreme High Voltage | 4.4 V |
| Extreme Low Voltage | 3.6V |

3.2. Internal Identification of EUT

| EUT ID* | SN | HW Version | SW Version | Date of receipt |
|----------------|--------------|-------------------|-------------------|------------------------|
| UT14a | 2170530UT14a | REV1.0 | A035G.001 | 2021-10-10 |
| UT25a | 2170530UT25a | REV1.0 | A035G.001 | 2021-10-20 |

*EUT ID: is used to identify the test sample in the lab internally.

3.3. Internal Identification of AE

| AE ID* | Description | SN | Note |
|---------------|--------------------|-----------|-------------|
| AE1 | Adapter1 | / | |
| AE2 | Adapter2 | / | |
| AE3 | Adapter3 | / | |
| AE4 | Adapter4 | / | |
| AE5 | Adapter5 | / | |
| AE6 | Adapter6 | / | |
| AE7 | Adapter7 | / | |
| AE8 | Adapter8 | / | |
| AE9 | USB Cable | / | |
| AE10 | Headset1 | / | |
| AE11 | Headset2 | / | |
| AE12 | Battery1 | / | |
| AE13 | Battery2 | / | |
| AE1 | | | |
| Model | EP-TA50JWS | | |

| | |
|-----------------|--------------------------------------|
| Manufacturer | RFTECH Co., Ltd. |
| Length of cable | / |
| AE2 | |
| Model | EP-TA50JWS |
| Manufacturer | HAMEN |
| Length of cable | / |
| AE3 | |
| Model | EP-TA50EWE |
| Manufacturer | DY |
| Length of cable | / |
| AE4 | |
| Model | EP-TA50EWE |
| Manufacturer | HAMEN |
| Length of cable | / |
| AE5 | |
| Model | EP-TA50EWE |
| Manufacturer | Salcomp |
| Length of cable | / |
| AE6 | |
| Model | EP-TA50UWE |
| Manufacturer | DY |
| Length of cable | / |
| AE7 | |
| Model | EP-TA50UWE |
| Manufacturer | HAMEN |
| Length of cable | / |
| AE8 | |
| Model | EP- TA50UWE |
| Manufacturer | Salcomp |
| Length of cable | / |
| AE9 | |
| Model | ECB-DU68WE |
| Manufacturer | Samsung Electronics Co., Ltd. |
| Length | / |
| AE10 | |
| Model | EHS61ASFWE |
| Manufacturer | CRESYN HANOI Co., Ltd |
| Length | / |
| AE11 | |
| Model | EHS61ASFWE |
| Manufacturer | DONGGUAN YOUNGBO ELECTRONICS CO.,LTD |
| Length | / |
| AE12 | |

| | |
|--------------|-----------------------------------|
| TYPE | Secondary Li-ion Battery |
| SN | HQ-50SD |
| Manufacturer | SCUD (Fujian) Electronics CO.,LTD |

AE13

| | |
|--------------|-----------------------------------|
| TYPE | Secondary Li-ion Battery |
| SN | HQ-50N |
| Manufacturer | SCUD (Fujian) Electronics CO.,LTD |

*AE ID: is used to identify the ancillary equipment in the lab internally.

3.4. EUT Set-ups

Table 1: Eut Set-ups

| EUT Set-up No. | Combination of EUT and AE | Remarks |
|----------------|---------------------------|----------|
| Set.NFC01 | UT25a + AE1+AE9+AE12/AE13 | Charging |
| Set.NFC02 | UT25a | -- |
| Set.NFC03 | UT14a | -- |

The Transmit State of NFC: the NFC function is on. The EUT will transmit the NFC data and command continuously during the test.

The Transmit state without modulation: The EUT will transmit the CW signal at the operating frequency.

4. Reference Documents

4.1. Documents supplied by applicant

EUT parameters, referring to Annex A for detailed information, are supplied by the client or manufacturer, which are the bases of testing.

4.2. Reference Documents for testing

The following documents listed in this section are referred for testing.

| Reference | Title | Version |
|----------------|--|---------|
| CFR 47 Part 2 | Part 2 — Frequency Allocations and Radio Treaty Matters; General Rules and Regulations. | 2019 |
| CFR 47 Part 15 | Part 15 — Radio Frequency Devices. Subpart C — Intentional Radiators. § 15.35 Measurement detector functions and bandwidths. § 15.207 Conducted limits. § 15.209 Radiated emission limits, general requirements. § 15.215 Additional provisions to the general radiated emission limitations. § 15.225 Operation within the band 13.110–14.010 MHz. | 2019 |
| ANSI C63.10 | American National Standard of Procedures for Compliance Testing of Unlicensed Wireless Devices | 2013 |

5. Test Results

5.1. Summary of Test Results

Table 2: Summary of Test Results

| No | Test Cases | Clause in Regulation | Section in This Report | Verdict |
|--|--|--|------------------------|----------------|
| 1 | Electric Field Strength of Fundamental Emissions | CFR 47 § 15.225(a) | B.1 | P (Set. NFC02) |
| 2 | Electric Field Strength of Outside the Allocated Bands | CFR 47 § 15.225(b) CFR 47 § 15.225(c) | | P (Set. NFC02) |
| 3 | Electric Field Radiated Emissions | CFR 47 § 15.209 | B.2 | P (Set. NFC01) |
| | | CFR 47 § 15.225(d) | B.3 | P (Set. NFC01) |
| 4 | Frequency Tolerance | CFR 47 § 15.225(e) | B.4 | P(Set. NFC03) |
| 5 | 20dB Bandwidth | CFR 47 § 15.215(c) | B.5 | P(Set. NFC03) |
| 6 | Conducted Emissions | CFR 47 § 15.207 | B.6 | P (Set. NFC01) |
| The measurement is carried out according to ANSI C63.10. See ANNEX B for details. | | | | |

Note: All combinations were tested, and only the worst results are shown in this report.

Test Conditions:

For this report, all the test cases listed above were tested under normal Temperature, Voltage, humidity and Air Pressure except the Frequency Tolerance test case. The specific conditions of Frequency Tolerance test case are listed in section B.4.3

See Table 3 for terms for result verdict:

Table 3 Terms for result verdict

| | |
|----|---|
| P | Pass, The EUT complies with the essential requirements in the standard. |
| NP | Not Perform, The test was not performed by CTTL |
| NA | Not Applicable, The test was not applicable |
| F | Fail, The EUT does not comply with the essential requirements in the standard |



5.2. Statements

The test cases listed in Section 5.1 of this report for the EUT specified in Section 3 were performed by CTTL according to the reference documents in Section 4.

The EUT meets all applicable requirements of the regulations and standards in Section 4.2

6. Test Facilities Utilized

Table 4: Test Facilities Utilized

| NO. | NAME | TYPE | SERIES NUMBER | PRODUCER | CAL. DUE DATE | CAL. INTERVAL |
|-----|---------------------|----------|---------------|-----------------|---------------|---------------|
| 1. | PXA Signal Analyzer | N9030A | MY49432143 | Agilent | 2022-10-14 | 1 Year |
| 2. | Climatic chamber | SH242 | 93008658 | ESPEC | 2022-01-22 | 1 Year |
| 3. | Test Receiver | ESU26 | 100235 | Rohde & Schwarz | 2022-03-23 | 1 Year |
| 4. | BiLog Antenna | VULB9163 | 01223 | Schwarzbeck | 2022-03-22 | 1 Year |
| 5. | LISN | ENV216 | 101459 | R&S | 2022-03-22 | 1 Year |
| 6. | Test Receiver | ESCI | 100766 | R&S | 2022-03-09 | 1 Year |
| 7. | H-field Antenna | HFH2-Z2 | 829324/007 | R&S | 2021-12-10 | 1 Year |

7. Measurement Uncertainty

Table 5: Measurement Uncertainty

| Item | Uncertainty |
|---|-----------------------------|
| Frequency Tolerance | $U = 73 \text{ Hz, } k=2$ |
| 20dB Bandwidth | $U = 73 \text{ Hz, } k=2$ |
| Radiated Emissions (<300MHz) | $U = 4.86 \text{ dB, } k=2$ |
| Radiated Emissions ($\geq 300\text{MHz}$) | $U = 5.16 \text{ dB, } k=2$ |
| Conducted emission | $U = 3.08 \text{ dB, } k=2$ |



ANNEX A: EUT parameters

/

ANNEX B: Detailed Test Results

B.1. Electric Field Strength of Fundamental and Outside the Allocated bands

B.1.1. Reference

See Clause 4, Clause 5 of ANSI C63.10-2013 generally.

B.1.2. Measurement Methods

The transmitter carrier output levels (E-Field) from the EUT are measured in a semi-anechoic chamber. The EUT is placed on a non-conductive stand of 80cm high, and at a measurement distance of 3m from the receiving antenna. The center of the receiving loop antenna is 1.0 meter above the ground. The E-field is measured with a shielded loop antenna connected to a measurement receiver. Detected E-field was maximized by rotating the EUT through 360° and adjusting the receiving antenna polarizations. The maximization processes were repeated with the EUT positioned respectively in its three orthogonal axes. The measurements were performed with the peak detector and if required, the quasi-peak detector.

The measurement bandwidth is:

Table B-1: Measurement bandwidth

| Frequency of Emission (MHz) | RBW/VBW |
|-----------------------------|-----------|
| 12.56-14.56 | 10/30 kHz |

The E-field measured at 3m is calculated as:

$$\text{E-field (dB}\mu\text{V/m)} = \text{Rx (dB}\mu\text{V)} + \text{Cable Loss (dB)} + \text{AF@3m (dB/m)}$$

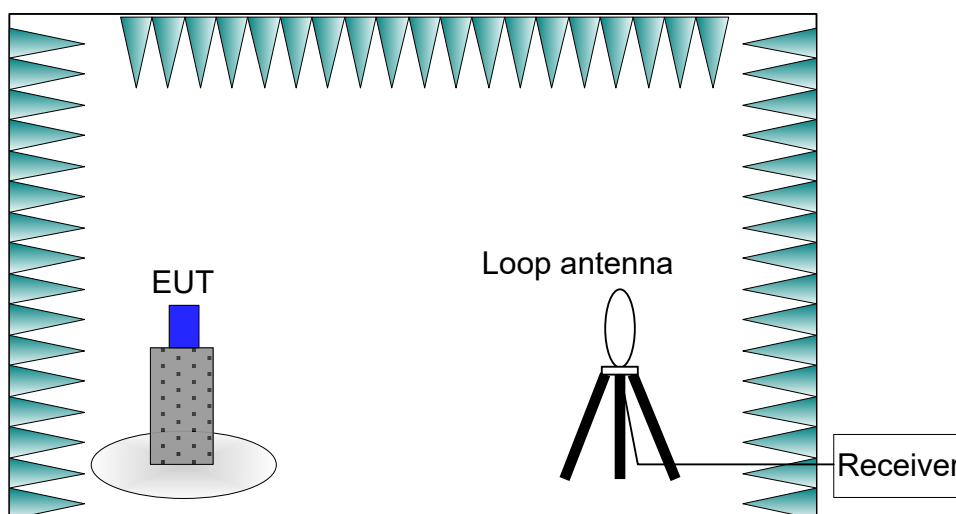

Figure B-1: Measurement Setup

B.1.3. EUT Operating Mode and Test Conditions

The measurement of EUT is carried out under the transmit state of NFC(See 3.4).

The EUT is powered by a travel adapter.

All possible configurations were investigated and only the worst case is reported.

During the measurements, the ambient temperature of the electromagnetic anechoic chamber is in the range of 15 ~ 25 °C.

B.1.4. Limits

Table B-2: Limits

| Frequency Range (MHz) | E-field Strength Limit @ 30 m ($\mu\text{V/m}$) | E-field Strength Limit @ 3 m ($\text{dB}\mu\text{V/m}$) |
|---|--|--|
| 13.560 \pm 0.007 | +15,848 | 124 |
| 13.410 to 13.553 13.567 to 13.710 | +334 | 90 |
| 13.110 to 13.410 13.710 to 14.010 | +106 | 81 |
| Note: Where the limits have been defined at one distance, and a signal level measured at another, the limits have been extrapolated using the following formula: $\text{Extrapolation(dB)} = 40\log_{10}(\text{Measurement Distance}/\text{Specification Distance})$ | | |

B.1.5. Measurement Results

Measurement results of normal conditions see Figure B-2 for different set-ups of EUT. The results displayed take into account applicable antenna factors and cable losses.

Conclusions: Set.NFC02, **PASS**.

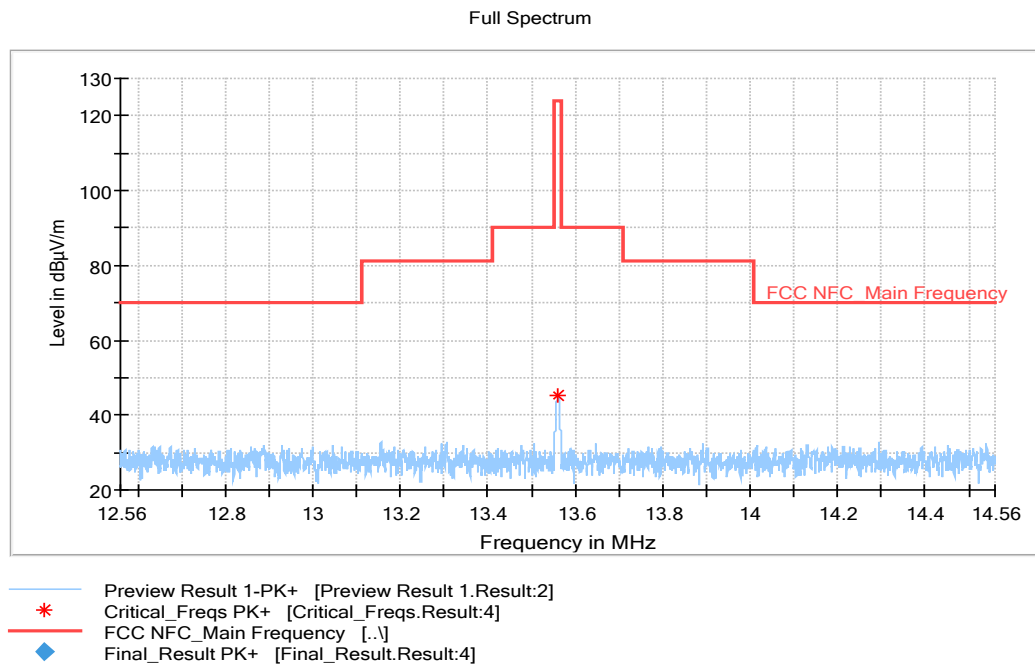

Figure B-2: Measurement results for Electric Field Strength of Fundamental and Outside the Allocated bands

Critical_Freqs

| Frequency (MHz) | MaxPeak (dBµV/m) | Limit (dBµV/) | Margin (dB) | Pol | Azimuth (deg) | Corr. (dB/m) |
|-----------------|------------------|---------------|-------------|-----|---------------|--------------|
| 13.561000 | 45.36 | 124.00 | 78.64 | V | 0.0 | 17.9 |

B.2. Electric Field Radiated Emissions (< 30MHz)

B.2.1. Reference

See Clause 6.4 of ANSI C63.10-2013 specifically.

See Clause 4 and Clause 5 of ANSI C63.10-2013 generally.

B.2.2. Measurement Methods

The transmitter carrier output levels (E-Field) from the EUT are measured in a semi-anechoic chamber. The EUT is placed on a non-conductive stand of 80cm high, and at a measurement

distance of 3m from the receiving antenna. The center of the receiving loop antenna is 1.0 meter above the ground. The E-field is measured with a shielded loop antenna connected to a measurement receiver. Detected E-field was maximized by rotating the EUT through 360° and adjusting the receiving antenna polarizations. The maximization processes were repeated with the EUT positioned respectively in its three orthogonal axes. The measurements were performed with the peak detector and if required, the quasi-peak detector.

The measurement bandwidth is:

Table B-3: Measurement bandwidth

| Frequency of Emission (MHz) | RBW/VBW |
|-----------------------------|------------|
| 0.009-0.15 | 100/300 Hz |
| 0.15-30 | 10/30 kHz |

The E-field measured at 3m is calculated as:

$$\text{E-field (dB}\mu\text{V/m)} = \text{Rx (dB}\mu\text{V)} + \text{Cable Loss (dB)} + \text{AF@3m (dB/m)}$$

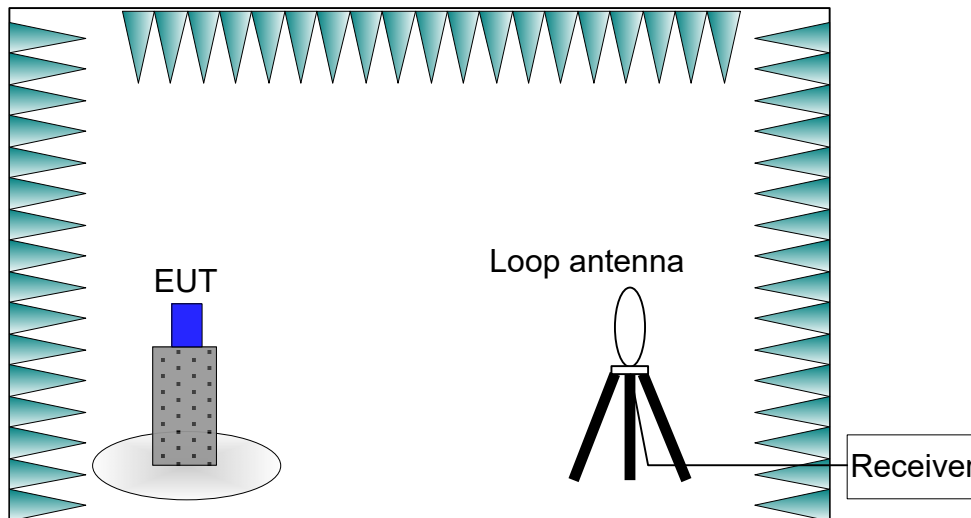

Figure B-3: Measurement Setup

B.2.3. EUT Operating Mode and Test Conditions

The measurement of EUT is carried out under the transmit state of NFC(See 3.4).

The EUT is powered by a travel adapter.

All possible configurations were investigated and only the worst case is reported.

During the measurements, the ambient temperature of the electromagnetic anechoic chamber is in the range of 15 ~ 25 °C.

B.2.4. Limits

Table B-4: Limits

| Frequency Range (MHz) | E-field Strength Limit @ 30m (mV/m) | E-field Strength Limit @ 3m (dB μ V/m) |
|-----------------------|--|---|
| 0.009-0.490 | 2400/F(kHz) | 129-94 |
| 0.490-1.705 | 24000/F(kHz) | 74-63 |
| 1.705-30 | 30 | 70 |

Note: Where the limits have been defined at one distance, and a signal level measured at another, the limits have been extrapolated using the following formula:

$$\text{Extrapolation(dB)} = 40\log_{10}(\text{Measurement Distance/Specification Distance})$$

B.2.5. Measurement Results

Measurement results of normal conditions see Figure B-4 for different set-ups of EUT. The results displayed take into account applicable antenna factors and cable losses.

Conclusions:Set.NFC01, **PASS**.

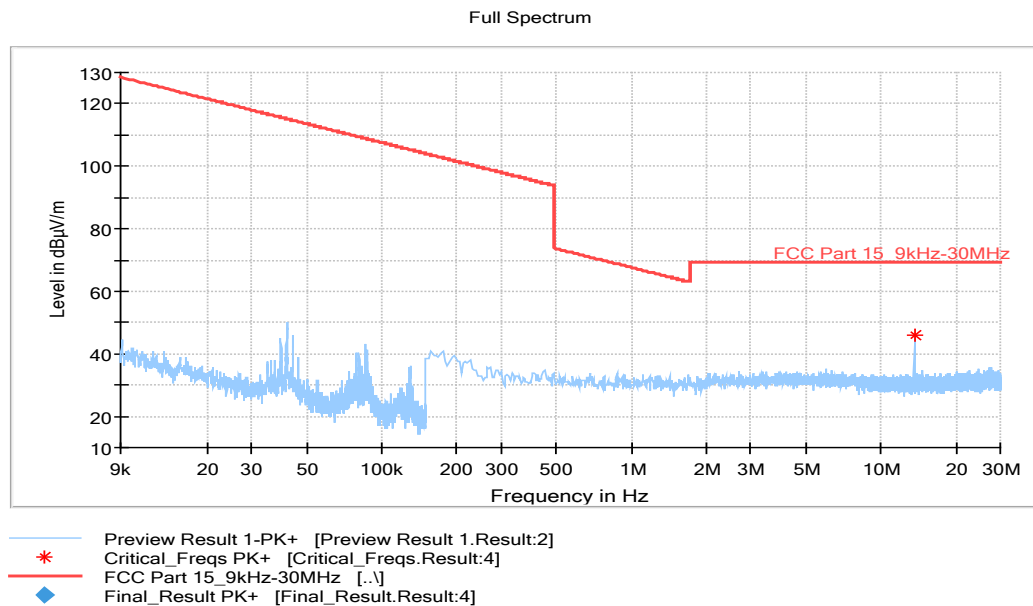

Figure B-4: Measurement results for Electric Field Radiated Emissions (< 30MHz)

Critical_Freqs

| Frequency (MHz) | MaxPeak (dB μ V/m) | Limit (dB μ V/) | Margin (dB) | Pol | Azimuth (deg) | Corr. (dB/m) |
|-----------------|------------------------|---------------------|-------------|-----|---------------|--------------|
| 13.561000 | 45.36 | 124.00 | 78.64 | V | 0.0 | 17.9 |

B.3. Electric Field Radiated Emissions (≥ 30 MHz)

B.3.1. Reference

See Clause 6.5 of ANSI C63.10-2013 specifically.

See Clause 4 and Clause 5 of ANSI C63.10-2013 generally.

B.3.2. Measurement Methods

The electric field radiated emissions from the EUT are measured in a semi-anechoic chamber. The EUT is placed on a non-conductive stand of 80cm high, and at a measurement distance of 3m from the receiving antenna. The receiving antennas connected to a measurement receiver. In order to search for maximum field strength emitted from the EUT, the receiving antenna can be moved between the height of 1.0 m to 4.0 m. Detected E-field was maximized at each frequency by rotating the EUT through 360° and adjusting the receiving antenna positions for both vertical and horizontal antenna polarizations. The maximization processes were repeated with the EUT positioned respectively in its three orthogonal axes. The measurements were performed with the peak detector and if required, the quasi-peak detector.

The measurement bandwidth is:

Table B-5: Measurement bandwidth

| Frequency of Emission (MHz) | RBW/VBW |
|-----------------------------|---------|
| 30-1000 | 120kHz |

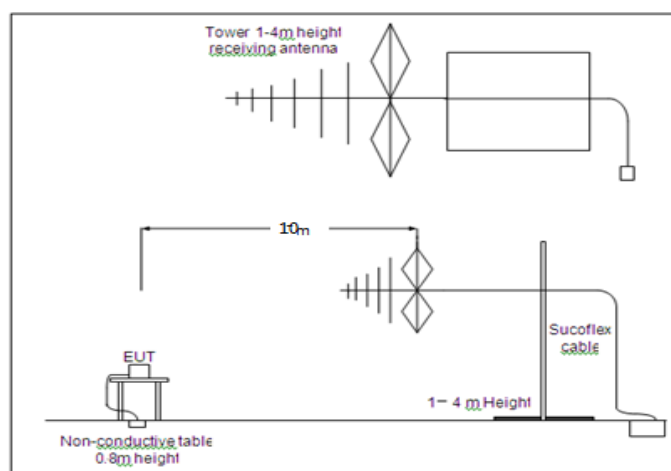

Figure B-5: Measurement Setup

B.3.3. EUT Operating Mode and Test Conditions

The measurement of EUT is carried out under the transmit state of NFC(See 3.4).

The EUT had been connected to a travel adapter.

All possible configurations were investigated and only the worst case is reported.

During the measurements, the ambient temperature of the electromagnetic anechoic chamber is in the range of 15 ~ 25 °C.

B.3.4. Limits

Table B-6: Limits

| Frequency Range (MHz) | E-field Strength Limit @ 3m (mV/m) | E-field Strength Limit @ 3m (dB μ V/m) | E-field Strength Limit @ 10m (dB μ V/m) |
|-----------------------|------------------------------------|--|---|
| 30-88 | 100 | 40 | 30 |
| 88-216 | 150 | 43.5 | 33.5 |
| 216-960 | 200 | 46 | 36 |
| 960-1000 | 500 | 54 | 44 |

B.3.5. Measurement Results

Measurement results of normal conditions see Figure B-6 for different set-ups of EUT. The results displayed take into account applicable antenna factors and cable losses.

Conclusions: Set.NFC01 , **PASS**.

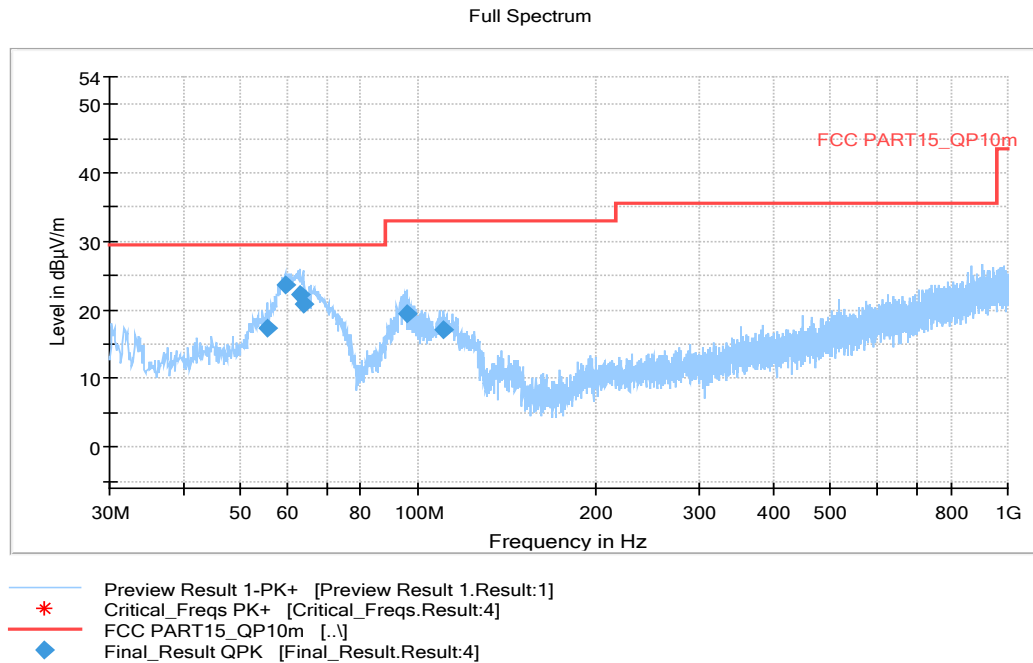

Figure B-6: Measurement results for Electric Field Radiated Emissions ($\geq 30\text{MHz}$)

Final_Result

| Frequency (MHz) | QuasiPeak (dBµV/m) | Limit (dBµV/m) | Margin (dB) | Meas. Time (ms) | Bandwidth (kHz) | Height (cm) | Pol | Azimuth (deg) | Corr. (dB/m) |
|-----------------|--------------------|----------------|-------------|-----------------|-----------------|-------------|-----|---------------|--------------|
| 55.511000 | 17.30 | 29.54 | 12.24 | 2000.0 | 120.000 | 334.0 | V | 300.0 | -11.3 |
| 59.488000 | 23.66 | 29.54 | 5.88 | 2000.0 | 120.000 | 186.0 | V | 30.0 | -11.9 |
| 62.980000 | 22.21 | 29.54 | 7.33 | 2000.0 | 120.000 | 230.0 | V | 106.0 | -13.1 |
| 63.853000 | 20.85 | 29.54 | 8.69 | 2000.0 | 120.000 | 125.0 | V | 82.0 | -13.3 |
| 95.766000 | 19.35 | 33.06 | 13.71 | 2000.0 | 120.000 | 109.0 | V | 273.0 | -13.2 |
| 110.316000 | 17.08 | 33.06 | 15.98 | 2000.0 | 120.000 | 189.0 | V | 177.0 | -12.9 |

B.4. Frequency Tolerance

B.4.1. Reference

See Clause 6.8 of ANSI C63.10-2013 specifically.

See Clause 4 and Clause 5 of ANSI C63.10-2013 generally.

B.4.2. Measurement Methods

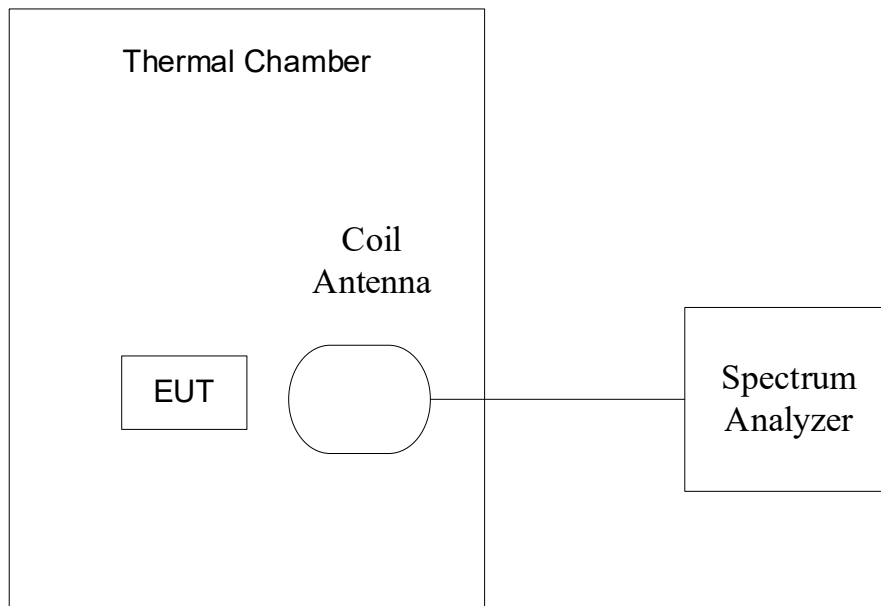

Figure B-7: Measurement Setup

The transmitter output signal was picked up by coil antenna connected to the spectrum analyzer. The center frequency was measured with 30Hz RBW and 1kHz span.

During the test, the EUT was placed in a thermal chamber until thermal balance and lasting appropriate time.

B.4.3. EUT Operating Mode and Test Conditions

The measurement of EUT was carried out under the transmit state of without modulation(See 3.4).

EUT had not been connected to a travel adapter. The frequency stability was measured with the different voltage and temperature combinations:

- a) The nominal voltage 3.85V(See 3.1)was used and the temperature was varied from -20°C to +50°C in 10°C increments using an environmental chamber.
- b) The 20°C was used and the voltages were 3.6V, 3.85V and 4.4V (The extreme low voltage , the nominal voltage and the extreme high voltage).

Note: The extreme low voltage , the nominal voltage and the extreme high voltage were defined in section 3.1

The details were as following:

Table B-7: Combinations of Voltage and Temperature

| Test items | Voltage | Temperature |
|---|---------|-------------|
| Frequency stability with respect to ambient temperature | 3.85V | -20°C |
| | | -10°C |
| | | 0°C |
| | | 10°C |
| | | 20°C |
| | | 30°C |
| | | 40°C |
| | | 50°C |
| Frequency stability when varying supply voltage | 3.6V | 20°C |
| | 3.85V | |
| | 4.4V | |

B.4.4. Test Layouts

See B.4.2.

B.4.5. Limits

The frequency tolerance of the carrier signal shall be maintained within +/- 0.01% of the operating frequency.

B.4.6. Measurement Results

Measurement results see Table B-8 for different test conditions.

Conclusions: Set.NFC03, **PASS**.

Table B-8: Measurement results for Frequency Tolerance

| Temperature | Voltage | Frequency (MHz) | | | |
|-------------|---------|-----------------|--------------|--------------|--------------|
| | | Startup | 2 Min Later | 5 Min Later | 10 Min Later |
| -20°C | 3.85V | 13.560037000 | 13.560042000 | 13.560051000 | 13.560054000 |
| -10°C | 3.85V | 13.560062000 | 13.560067000 | 13.560071000 | 13.560073000 |
| 0°C | 3.85V | 13.560073000 | 13.560069000 | 13.560067000 | 13.560061000 |
| 10°C | 3.85V | 13.560051000 | 13.560045000 | 13.560040000 | 13.560036000 |
| 20°C | 3.85V | 13.560018000 | 13.560013000 | 13.560009000 | 13.560005000 |
| 30°C | 3.85V | 13.559985000 | 13.559979000 | 13.559974000 | 13.559973000 |
| 40°C | 3.85V | 13.559959000 | 13.559952000 | 13.559948000 | 13.559946000 |
| 50°C | 3.85V | 13.559939000 | 13.559937000 | 13.559934000 | 13.559928000 |
| 20°C | 3.6V | 13.559981000 | 13.559974000 | 13.559971000 | 13.559967000 |
| 20°C | 4.4V | 13.560006000 | 13.560004000 | 13.560001000 | 13.559997000 |

| Temperature | Voltage | Frequency Error (%) | | | |
|-------------|---------|---------------------|-------------|-------------|--------------|
| | | Startup | 2 Min Later | 5 Min Later | 10 Min Later |
| -20°C | 3.85V | 0.000 | 0.000 | 0.000 | 0.000 |
| -10°C | 3.85V | 0.000 | 0.000 | 0.001 | 0.001 |
| 0°C | 3.85V | 0.001 | 0.001 | 0.000 | 0.000 |
| 10°C | 3.85V | 0.000 | 0.000 | 0.000 | 0.000 |
| 20°C | 3.85V | 0.000 | 0.000 | 0.000 | 0.000 |
| 30°C | 3.85V | 0.000 | 0.000 | 0.000 | 0.000 |
| 40°C | 3.85V | 0.000 | 0.000 | 0.000 | 0.000 |
| 50°C | 3.85V | 0.000 | 0.000 | 0.000 | -0.001 |
| 20°C | 3.6V | 0.000 | 0.000 | 0.000 | 0.000 |
| 20°C | 4.4V | 0.000 | 0.000 | 0.000 | 0.000 |

B.4.7. Measurement Uncertainty

Measurement uncertainty: $U = 73 \text{ Hz}$, $k=2$

B.5. 20dB Bandwidth

B.5.1. Reference

See Clause 6.9 of ANSI C63.10-2013 specifically.

See Clause 4 and Clause 5 of ANSI C63.10-2013 generally.

B.5.2. Measurement Methods

The transmitter output signal was picked up by coil antenna connected to the spectrum analyzer. The bandwidth of the center frequency was measured with 150Hz RBW, 470Hz VBW and 15kHz span.

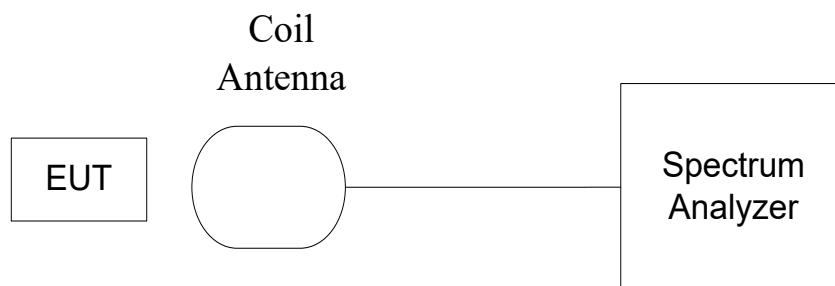

Figure B-8: Measurement Setup

B.5.3. EUT Operating Mode and Test Conditions

The measurement of EUT was carried out under the transmit state of NFC (See 3.4).

EUT had not been connected to a travel adapter.

During the measurements, the ambient temperature was in the range of 15 ~ 25 °C.

B.5.4. Test Layouts

See B.5.2.

B.5.5. Limits

The 20dB bandwidth shall be less than 80% of the permitted frequency band. For 13.56 MHz NFC, the permitted frequency band is 14kHz, so the limit is 11.2 kHz.

B.5.6. Measurement Results

Measurement results see Figure B-9.

Conclusions: Set.NFC03, **PASS**.

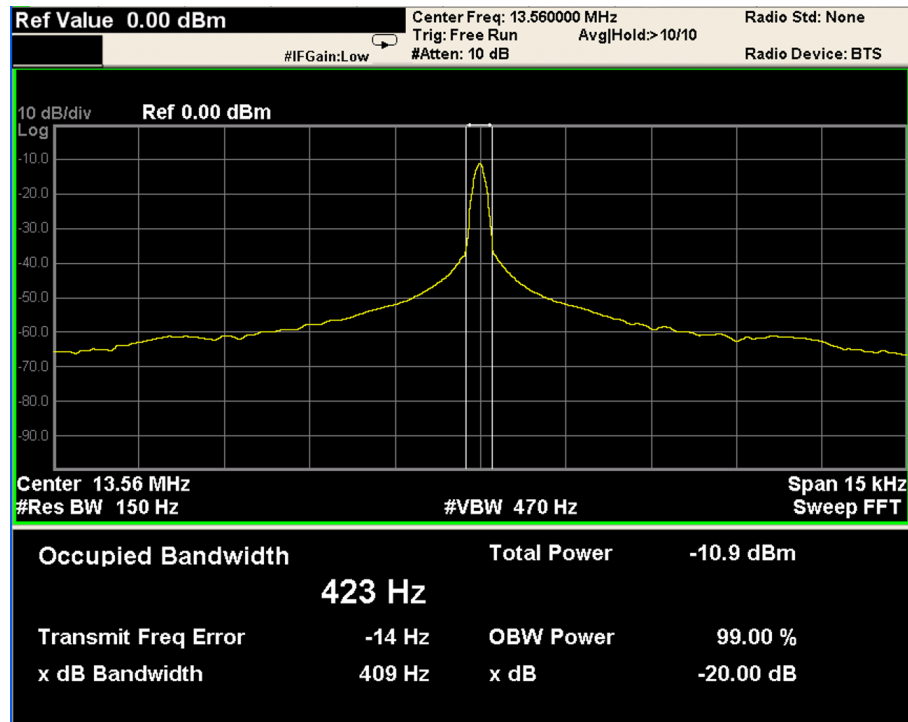

Figure B-9: Measurement results for 20dB Bandwidth

B.5.7. Measurement Uncertainty

Measurement uncertainty: $U = 73 \text{ Hz}$, $k=2$

B.6. Conducted emission

B.6.1. Reference

See Clause 6.2 of ANSI C63.10-2013 specifically.

See Clause 4 and Clause 5 of ANSI C63.10-2013 generally.

B.6.2. Measurement Methods

The conducted emissions from the AC port of the EUT are measured in a shielding room. The EUT is connected to a Line Impedance Stabilization Network (LISN). An overview sweep with peak detection was performed. The measurements were performed with a quasi-peak detector and if required, an average detector.

The conducted emission measurements were made with the following detector of the test receiver:

Quasi-Peak / Average Detector.

The measurement bandwidth is:

Table B-9: Measurement Bandwidth

| Frequency of Emission (MHz) | RBW/VBW |
|-----------------------------|---------|
| 0.15-30 | 9kHz |

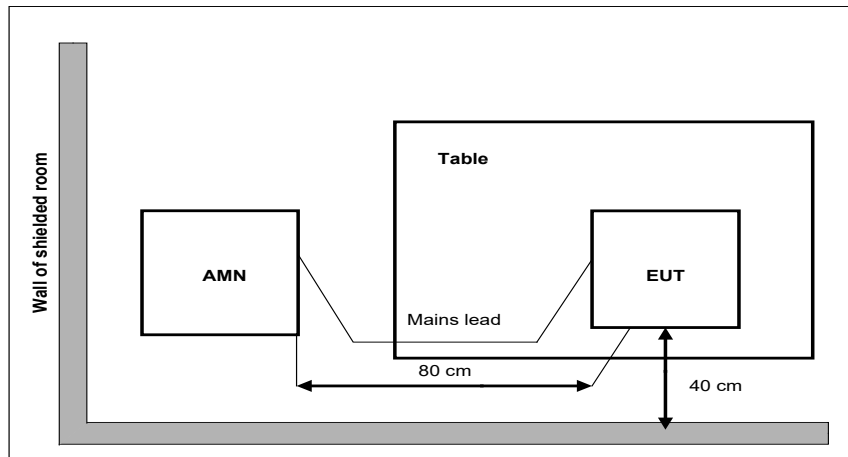

Figure B-10: Measurement Setup

B.6.3. EUT Operating Mode and Test Conditions

The measurement of EUT is carried out under the transmit state of NFC(See 3.4).

The EUT is powered by a travel adapter.

All possible configurations were investigated and only the worst case is reported.

During the measurements, the ambient temperature is in the range of 15 ~ 25 °C.

B.6.4. Limits

Table B-10: Limits

| Frequency range (MHz) | Quasi-peak Limit (dB μ V) | Average Limit (dB μ V) |
|-----------------------|-------------------------------|----------------------------|
| 0.15 to 0.5 | 66 to 56 | 56 to 46 |
| 0.5 to 5 | 56 | 46 |
| 5 to 30 | 60 | 50 |

B.6.5. Measurement Results

Measurement Result = Receiver Reading + Voltage division factor + Cable loss

Measurement results see Figure B-11.

Conclusions: Set.NFC01, **PASS**.

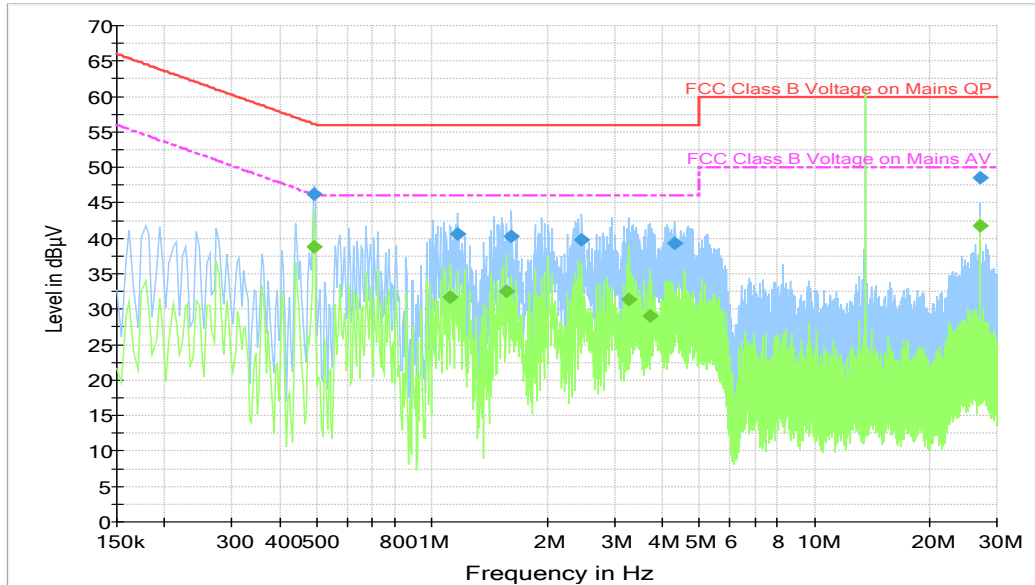

Figure B-11: Measurement results for Conducted Emission

Note: 13.56MHz is NFC operating frequency

Final Result 1

| Frequency (MHz) | QuasiPeak (dBµV) | Meas. Time (ms) | Bandwidth (kHz) | Line | Corr. (dB) | Margin (dB) | Limit (dBµV) |
|-----------------|------------------|-----------------|-----------------|------|------------|-------------|--------------|
| 0.490000 | 46.3 | 2000.0 | 9.000 | L1 | 19.9 | 9.9 | 56.2 |
| 1.166000 | 40.6 | 2000.0 | 9.000 | L1 | 19.6 | 15.4 | 56.0 |
| 1.614000 | 40.2 | 2000.0 | 9.000 | L1 | 19.5 | 15.8 | 56.0 |
| 2.466000 | 39.8 | 2000.0 | 9.000 | L1 | 19.5 | 16.2 | 56.0 |
| 4.326000 | 39.4 | 2000.0 | 9.000 | L1 | 19.6 | 16.6 | 56.0 |
| 27.122000 | 48.5 | 2000.0 | 9.000 | L1 | 20.2 | 11.5 | 60.0 |

Final Result 2

| Frequency (MHz) | Average (dBµV) | Meas. Time (ms) | Bandwidth (kHz) | Line | Corr. (dB) | Margin (dB) | Limit (dBµV) |
|-----------------|----------------|-----------------|-----------------|------|------------|-------------|--------------|
| 0.490000 | 38.7 | 2000.0 | 9.000 | L1 | 19.9 | 7.4 | 46.2 |
| 1.118000 | 31.7 | 2000.0 | 9.000 | L1 | 19.5 | 14.3 | 46.0 |
| 1.566000 | 32.6 | 2000.0 | 9.000 | L1 | 19.5 | 13.4 | 46.0 |
| 3.270000 | 31.3 | 2000.0 | 9.000 | L1 | 19.5 | 14.7 | 46.0 |
| 3.714000 | 29.1 | 2000.0 | 9.000 | L1 | 19.5 | 16.9 | 46.0 |
| 27.122000 | 41.8 | 2000.0 | 9.000 | L1 | 20.2 | 8.2 | 50.0 |

ANNEX C: Persons involved in this testing

Table C-1: Persons involved

| Test Item | Tester |
|--|---------------|
| 20dB Bandwidth | Zhou Bin |
| Frequency Tolerance | Zhou Bin |
| Electric Field Strength of Fundamental and Outside the Allocated bands | Zhang Tianli |
| Electric Field Radiated Emissions (< 30MHz) | Li Pengfei |
| Electric Field Radiated Emissions (≥ 30 MHz) | Li Pengfei |
| Conducted Emissions | Zhang Tianli |

ANNEX D: Accreditation Certificate

| | |
|--|--|
| <p>United States Department of Commerce National Institute of Standards and Technology</p>   | |
| <hr/> <h3>Certificate of Accreditation to ISO/IEC 17025:2017</h3> <hr/> | |
| <p>NVLAP LAB CODE: 600118-0</p> | |
| <p>Telecommunication Technology Labs, CAICT Beijing China</p> | |
| <p><i>is accredited by the National Voluntary Laboratory Accreditation Program for specific services, listed on the Scope of Accreditation, for:</i></p> | |
| <p>Electromagnetic Compatibility & Telecommunications</p> | |
| <p><i>This laboratory is accredited in accordance with the recognized International Standard ISO/IEC 17025:2017. This accreditation demonstrates technical competence for a defined scope and the operation of a laboratory quality management system (refer to joint ISO-ILAC-IAF Communique dated January 2009).</i></p> | |
| <hr/> <p>2020-09-29 through 2021-09-30 <i>Effective Dates</i></p> |  <hr/> <p><i>[Signature]</i> For the National Voluntary Laboratory Accreditation Program</p> |

END OF REPORT