



SAR TEST REPORT

No. I21Z70411-SEM01

For

Samsung Electronics Co., Ltd.

Multi-band GSM/WCDMA/LTE phone with Bluetooth, WLAN

Model Name: SM-A032M/DS, SM-A032M

with

Hardware Version: REV1.0

Software Version: A032M.001

FCC ID: ZCasma032M

Issued Date: 2021-9-26

Note:

The test results in this test report relate only to the devices specified in this report. This report shall not be reproduced except in full without the written approval of CTTL.

Test Laboratory:

CTTL, Telecommunication Technology Labs, CAICT

No. 51, Xueyuan Road, Haidian District, Beijing, P. R. China 100191.

Tel:+86(0)10-62304633-2512, Fax:+86(0)10-62304633-2504

Email: ctl_terminals@caict.ac.cn, website: www.caict.ac.cn

**REPORT HISTORY**

Report Number	Revision	Issue Date	Description
I21Z70411-SEM01	Rev.0	2021-9-22	Initial creation of test report
I21Z70411-SEM01	Rev.1	2021-9-26	Update the frequency for LTE band38 on page9. Update the tune-up power for GSM1900MHz on page26 Update the tune-up power for GSM850 2Tx on page49/50/55 Update the description on page44/52

TABLE OF CONTENT

1 TEST LABORATORY	5
1.1 TESTING LOCATION	5
1.2 TESTING ENVIRONMENT.....	5
1.3 PROJECT DATA	5
1.4 SIGNATURE.....	5
2 STATEMENT OF COMPLIANCE	6
3 CLIENT INFORMATION	8
3.1 APPLICANT INFORMATION	8
3.2 MANUFACTURER INFORMATION	8
4 EQUIPMENT UNDER TEST (EUT) AND ANCILLARY EQUIPMENT (AE)	9
4.1 ABOUT EUT	9
4.2 INTERNAL IDENTIFICATION OF EUT USED DURING THE TEST	10
4.3 INTERNAL IDENTIFICATION OF AE USED DURING THE TEST	10
5 TEST METHODOLOGY	11
5.1 APPLICABLE LIMIT REGULATIONS	11
5.2 APPLICABLE MEASUREMENT STANDARDS.....	11
6 SPECIFIC ABSORPTION RATE (SAR)	12
6.1 INTRODUCTION.....	12
6.2 SAR DEFINITION.....	12
7 TISSUE SIMULATING LIQUIDS	13
7.1 TARGETS FOR TISSUE SIMULATING LIQUID	13
7.2 DIELECTRIC PERFORMANCE	13
8 SYSTEM VERIFICATION	17
8.1 SYSTEM SETUP.....	17
8.2 SYSTEM VERIFICATION.....	18
9 GENERAL MEASUREMENT PROCEDURE	19
9.1 <i>POWER REFERENCE MEASUREMENT</i>	19
9.2 <i>AREA SCAN</i>	19
9.3 <i>ZOOM SCAN</i>	20
9.4 <i>POWER DRIFT MEASUREMENT</i>	20
10 MEASUREMENT PROCEDURE FOR DIFFERENT TECHNOLOGIES	21
10.1 GSM/GPRS MEASUREMENT PROCEDURES FOR SAR	21
10.2 WCDMA MEASUREMENT PROCEDURES FOR SAR	21
10.3 LTE MEASUREMENT PROCEDURES FOR SAR.....	23
10.4 BLUETOOTH & WI-FI MEASUREMENT PROCEDURES FOR SAR	25



11 CONDUCTED OUTPUT POWER	26
11.1 GSM MEASUREMENT RESULT	26
11.2 WCDMA MEASUREMENT RESULT.....	27
11.3 LTE MEASUREMENT RESULT	28
11.4 WI-FI AND BT MEASUREMENT RESULT	44
12 ANTENNA LOCATION	45
12.1 TRANSMIT ANTENNA SEPARATION DISTANCES	45
12.2 SAR MEASUREMENT POSITIONS	45
12.3 STANDALONE SAR TEST EXCLUSION CONSIDERATIONS	45
13 SAR TEST RESULT	47
13.1 SAR RESULTS FOR CELLULAR	49
13.2 SAR RESULTS FOR WLAN	52
13.3 SAR EVALUATION FOR PHABLET	54
14 SAR MEASUREMENT VARIABILITY	56
15 EVALUATION OF SIMULTANEOUS	57
15.1 INTRODUCTION.....	57
15.2 SIMULTANEOUS TRANSMISSION CAPABILITIES	58
15.3 SAR SIMULTANEOUS TRANSMISSION ANALYSIS	58
15.4 CONCLUSION	58
16 MEASUREMENT UNCERTAINTY	59
17 MAIN TEST INSTRUMENTS	59
APPENDIXES	60

1 Test Laboratory

1.1 Testing Location

Company Name:	CTTL(Shouxiang)
Address:	No. 51 Shouxiang Science Building, Xueyuan Road, Haidian District, Beijing, P. R. China100191

1.2 Testing Environment

Temperature:	18°C~25°C,
Relative humidity:	30%~ 70%
Ground system resistance:	< 0.5 Ω
Ambient noise & Reflection:	< 0.012 W/kg

1.3 Project Data

Project Leader:	Qi Dianyuan
Test Engineer:	Lin Xiaojun
Testing Start Date:	August 20, 2021
Testing End Date:	September 7, 2021

1.4 Signature



Lin Xiaojun

(Prepared this test report)

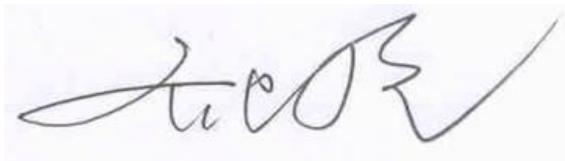

Qi Dianyuan

(Reviewed this test report)

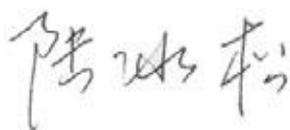

Lu Bingsong

Deputy Director of the laboratory

(Approved this test report)

2 Statement of Compliance

The maximum results of SAR found during testing for Samsung Electronics Co., Ltd. Multi-band GSM/WCDMA/LTE phone with Bluetooth, WLAN SM-A032M/DS, SM-A032M are as follows:

Table 2.1: Highest Reported SAR -Standalone(1g)

Equipment Class	Mode		Highest Reported SAR (1g)		Product Specific 10-g SAR 0mm
			1g SAR Head	1g SAR Body	
PCE	GSM	GSM 850	0.22	0.37	/
		PCS 1900	0.15	0.72	/
	WCDMA	UMTS FDD 2	0.20	1.25	2.59
		UMTS FDD 4	0.15	1.05	/
		UMTS FDD 5	0.21	0.31	/
	LTE	LTE Band 2	0.15	1.03	/
		LTE Band 4	/	/	/
		LTE Band 5	0.16	0.28	/
		LTE Band 7	0.33	0.91	/
		LTE Band 12	0.09	0.18	/
		LTE Band 17	/	/	/
		LTE Band 38	/	/	/
		LTE Band 41	0.12	0.25	/
		LTE Band 66	0.25	0.94	/
	DTS	WLAN 2.4 GHz	0.43	0.27	/

Note: The device have similar frequency in some LTE bands : LTEB4/66, 12/17, 38/41 since the supported frequency spans for the smaller LTE bands are completely cover by the larger LTE bands and the channel bandwidth and other operating parameters for the smaller band be fully supported by the larger band, therefore, only larger LTE bands were required to be tested for SAR.

The SAR values found for the Mobile Phone are below the maximum recommended levels of 1.6 W/kg as averaged over any 1g tissue according to the ANSI C95.1-1992.

For body operation, this device has been tested and meets FCC RF exposure guidelines when used with any accessory that contains no metal and which provides a minimum separation distance of 10 mm for body between this device and the body of the user. Use of other accessories may not ensure compliance with FCC RF exposure guidelines.

The EUT battery must be fully charged and checked periodically during the test to ascertain uniform power output.

The measurement together with the test system set-up is described in annex C. A detailed description of the equipment under test can be found in chapter 4 of this test report. The highest reported SAR value is obtained at the case of **(Table 2.1)**, and the values are:

Head:0.43 W/kg(1g)

Body:1.25 W/kg(1g)

Table 2.2: Highest Reported SAR -Simultaneous transmission

reported SAR 1g (W/kg)						
Head		LTE Band7	2.4G	BT ^[1]	Cellular+WiFi2.4G	Cellular+WiFi2.4G+BT
Cheek	Left	0.33	0.43	0.26	0.76	1.02
Body		WCDMA 1900	2.4G	BT ^[1]	Cellular+WiFi2.4G	Cellular+WiFi2.4G+BT
Rear	10mm	1.10	0.27	0.13	1.37	1.50

Note:

1. Estimated SAR for Bluetooth (see the section 12.3)
2. The detail for simultaneous transmission consideration is described in chapter 15.

The highest reported SAR for Head, Body, Product Specific 10-g SAR and Simultaneous transmission exposure conditions are 0.43W/kg, 1.25W/kg, 2.59W/kg and 1.50W/kg.

3 Client Information

3.1 Applicant Information

Company Name:	Samsung Electronics Co., Ltd.
Address/Post:	19 Chapin Rd., Building D Pine Brook, NJ 07058
Contact Person:	Jenni Chun
Contact Email:	j1.chun@samsung.com
Telephone:	+1-201-937-4203
Fax	/

3.2 Manufacturer Information

Company Name:	Samsung Electronics Co., Ltd.
Address/Post:	Samsung R5, Maetan dong 129, Samsung roYoungtong gu, Suwon city 443 742, Korea
Contact Person:	조성훈 (Sunghoon Cho)
Contact Email:	ggobi.cho@samsung.com
Telephone:	+82-10-2722-4159
Fax	/



4 Equipment Under Test (EUT) and Ancillary Equipment (AE)

4.1 About EUT

Description:	Multi-band GSM/WCDMA/LTE phone with Bluetooth, WLAN
Model name:	SM-A032M/DS, SM-A032M
Operating mode(s):	GSM850/900/1800/1900, WCDMA850/900/1700/1900/2100, BT, Wi-Fi 2.4G,LTE Band 1/2/3/4/5/7/8/12/17/28/38/40/41/66
Tested Tx Frequency:	824 – 849 MHz (GSM 850)
	1850 – 1910 MHz (GSM 1900)
	824–849 MHz (WCDMA 850 Band V)
	1710 – 1755 MHz (WCDMA 1700 Band IV)
	1850–1910 MHz (WCDMA1900 Band II)
	1850 – 1910 MHz(LTE Band 2)
	1710 – 1755 MHz (LTE Band 4)
	824 – 849 MHz (LTE Band 5)
	2500 – 2570 MHz(LTE Band 7)
	699 – 716 MHz (LTE Band 12)
	704 –716 MHz (LTE Band 17)
	2570 –2620 MHz (LTE Band 38)
	2498.5 – 2687.5 MHz (LTE Band41)
	1710 – 1780 MHz (LTE Band 66)
2402 – 2480 MHz (Bluetooth)	
2412 – 2462 MHz (Wi-Fi 2.4G)	
GPRS/EGPRS Multislot Class:	12
GPRS capability Class:	B
Antenna type:	Integrated antenna
Hotspot mode:	Support

4.2 Internal Identification of EUT used during the test

EUT ID*	IMEI	HW	SW Version
EUT1	70411UT01a	REV1.0	A032M.001
EUT2	70411UT02a	REV1.0	A032M.001
EUT3	70411UT03a	REV1.0	A032M.001
EUT4	70411UT04a	REV1.0	A032M.001

*EUT ID: is used to identify the test sample in the lab internally.

Note: It is performed to test SAR with the EUT3-4 and conducted power with the EUT1-2.

4.3 Internal Identification of AE used during the test

AE ID*	Description	Model	SN	Manufacturer
AE1	Battery	Secondary Li-ion Battery	SLC-50	Ningde Amperex Technology Limited
AE2	Headset	GH59-15054A (White). WW.	/	Youngbo
AE3	Headset	GH59-15071A (White). India.	/	Youngbo
AE4	Headset	GH59-15054A (White). WW.	/	Cresyn
AE5	Headset	GH59-15071A (White). India.	/	Cresyn

*AE ID: is used to identify the test sample in the lab internally.

5 TEST METHODOLOGY

5.1 Applicable Limit Regulations

ANSI C95.1–1992:IEEE Standard for Safety Levels with Respect to Human Exposure to Radio Frequency Electromagnetic Fields, 3 kHz to 300 GHz.

It specifies the maximum exposure limit of **1.6 W/kg** as averaged over any 1 gram of tissue for portable devices being used within 20 cm of the user in the uncontrolled environment.

5.2 Applicable Measurement Standards

IEEE 1528–2013: Recommended Practice for Determining the Peak Spatial-Average Specific Absorption Rate (SAR) in the Human Head from Wireless Communications Devices: Measurement Techniques.

KDB447498 D01: General RF Exposure Guidance v06: Mobile and Portable Devices RF Exposure Procedures and Equipment Authorization Policies.

KDB648474 D04 Handset SAR v01r03: SAR Evaluation Considerations for Wireless Handsets.

KDB941225 D01 SAR test for 3G devices v03r01: SAR Measurement Procedures for 3G Devices

KDB941225 D05 SAR for LTE Devices v02r05: SAR Evaluation Considerations for LTE Devices

KDB941225 D06 Hotspot Mode SAR v02r01: SAR Evaluation Procedures for Portable Devices with Wireless Router Capabilities

KDB248227 D01 802.11 Wi-Fi SAR v02r02: SAR GUIDANCE FOR IEEE 802.11 (Wi-Fi) TRANSMITTERS

KDB865664 D01 SAR measurement 100 MHz to 6 GHz v01r04: SAR Measurement Requirements for 100 MHz to 6 GHz.

KDB865664 D02 RF Exposure Reporting v01r02: RF Exposure Compliance Reporting and Documentation Considerations

6 Specific Absorption Rate (SAR)

6.1 Introduction

SAR is related to the rate at which energy is absorbed per unit mass in an object exposed to a radio field. The SAR distribution in a biological body is complicated and is usually carried out by experimental techniques or numerical modeling. The standard recommends limits for two tiers of groups, occupational/controlled and general population/uncontrolled, based on a person's awareness and ability to exercise control over his or her exposure. In general, occupational/controlled exposure limits are higher than the limits for general population/uncontrolled.

6.2 SAR Definition

The SAR definition is the time derivative (rate) of the incremental energy (dW) absorbed by (dissipated in) an incremental mass (dm) contained in a volume element (dv) of a given density (ρ). The equation description is as below:

$$SAR = \frac{d}{dt} \left(\frac{dW}{dm} \right) = \frac{d}{dt} \left(\frac{dW}{\rho dv} \right)$$

SAR is expressed in units of Watts per kilogram (W/kg)

SAR measurement can be either related to the temperature elevation in tissue by

$$SAR = c \left(\frac{\delta T}{\delta t} \right)$$

Where: C is the specific heat capacity, δT is the temperature rise and δt is the exposure duration, or related to the electrical field in the tissue by

$$SAR = \frac{\sigma |E|^2}{\rho}$$

Where: σ is the conductivity of the tissue, ρ is the mass density of tissue and E is the RMS electrical field strength.

However for evaluating SAR of low power transmitter, electrical field measurement is typically applied.

7 Tissue Simulating Liquids

The temperature of the tissue-equivalent medium used during measurement must also be within 18 °C to 25 °C and within ± 2 °C of the temperature when the tissue parameters are characterized. The dielectric parameters must be measured before the tissue-equivalent medium is used in a series of SAR measurements. The parameters should be re-measured after each 3 – 4 days of use; or earlier if the dielectric parameters can become out of tolerance; for example, when the parameters are marginal at the beginning of the measurement series.

The dielectric constant (ϵ_r) and conductivity (σ) of typical tissue-equivalent media recipes are expected to be within $\pm 5\%$ of the required target values; but for SAR measurement systems that have implemented the SAR error compensation algorithms documented in IEEE Std 1528-2013, to automatically compensate the measured SAR results for deviations between the measured and required tissue dielectric parameters, the tolerance for ϵ_r and σ may be relaxed to $\pm 10\%$. This is limited to frequencies ≤ 3 GHz.

The below measured tissue parameters were used in the DASY software. The DASY software was used to perform interpolation to determine the dielectric parameters at the SAR test device frequencies. The tissue parameters listed in the SAR test plots may slightly differ from the table above due to significant digit rounding in the software.

7.1 Targets for tissue simulating liquid

Table 7.1: Targets for tissue simulating liquid

Frequency(MHz)	Liquid Type	Conductivity(σ)	$\pm 10\%$ Range	Permittivity(ϵ)	$\pm 10\%$ Range
750	Head	0.89	0.80~0.98	41.94	37.75~46.13
835	Head	0.90	0.81~0.99	41.5	37.35~45.65
1750	Head	1.37	1.26~1.54	40.0	36~44
1900	Head	1.40	1.26~1.54	40.0	36~44
2450	Head	1.80	1.62~1.98	39.2	35.28~43.12
2600	Head	1.96	1.76~2.16	39.01	35.11~42.91
Frequency(MHz)	Liquid Type	Conductivity(σ)	$\pm 5\%$ Range	Permittivity(ϵ)	$\pm 5\%$ Range
5250	Head	4.71	4.47~4.95	35.93	34.13~37.73
5600	Head	5.07	4.82~5.32	35.53	33.8~37.3
5750	Head	5.22	4.96~5.48	35.36	33.59~37.13

7.2 Dielectric Performance

Table 7.2: Dielectric Performance of Tissue Simulating Liquid

Measurement Date (yyyy-mm-dd)	Type	Frequency	Permittivity ϵ	Drift (%)	Conductivity σ (S/m)	Drift (%)
2021/8/24	Head	750MHz	44.8	6.82%	0.8726	-1.96%
2021/8/24	Head	835 MHz	44.51	7.25%	0.9076	0.84%
2021/8/28	Head	1750MHz	43.23	7.86%	1.364	-0.44%
2021/8/28	Head	1900 MHz	43.09	7.73%	1.451	3.64%
2021/9/6	Head	2450 MHz	41.99	7.12%	1.886	4.78%
2021/8/30	Head	2600 MHz	41.72	6.95%	1.961	0.05%
2021/9/1	Head	2600 MHz	41.75	7.02%	1.957	-0.15%

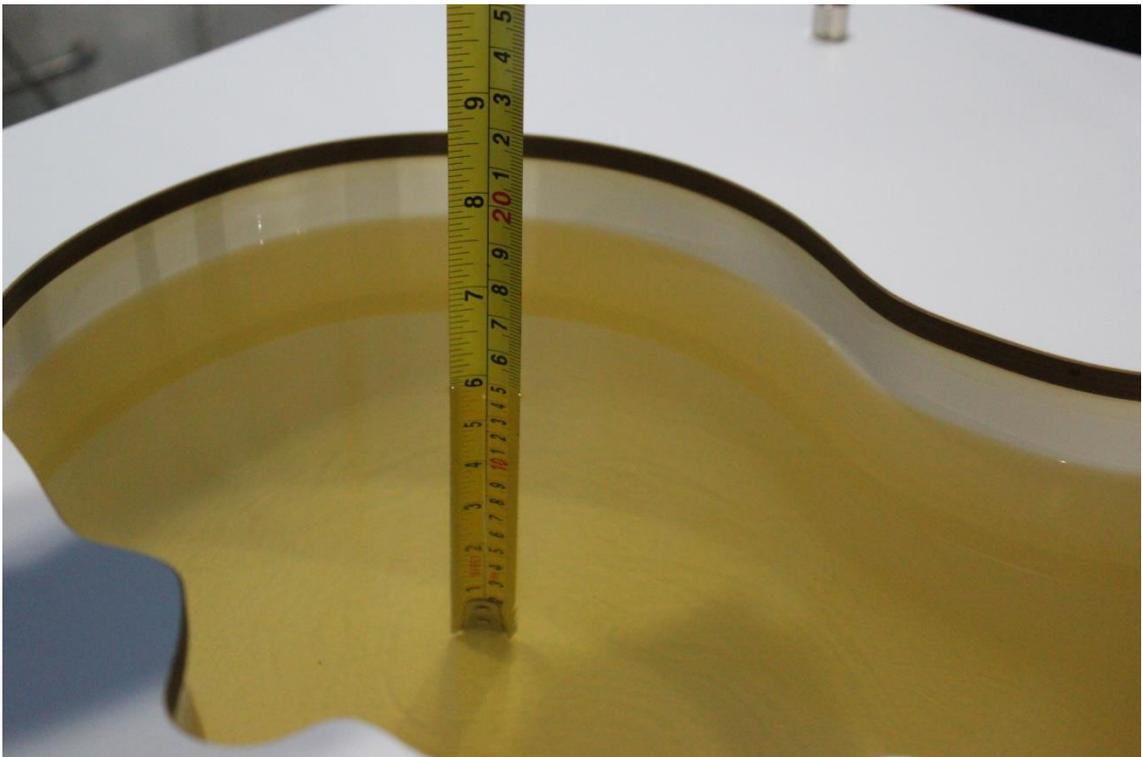

Picture 7-1 Liquid depth in the Head Phantom (750MHz)

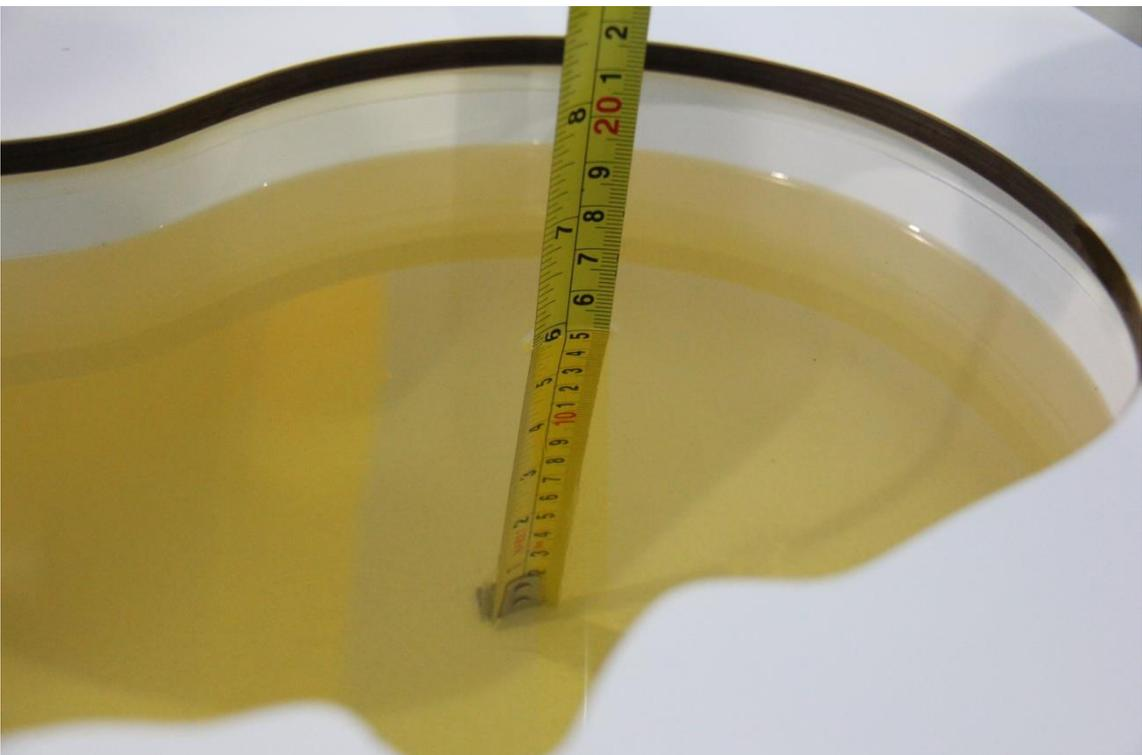

Picture 7-2 Liquid depth in the Head Phantom (835 MHz)



Picture 7-3 Liquid depth in the Head Phantom (1750 MHz)



Picture 7-4 Liquid depth in the Head Phantom (1900 MHz)

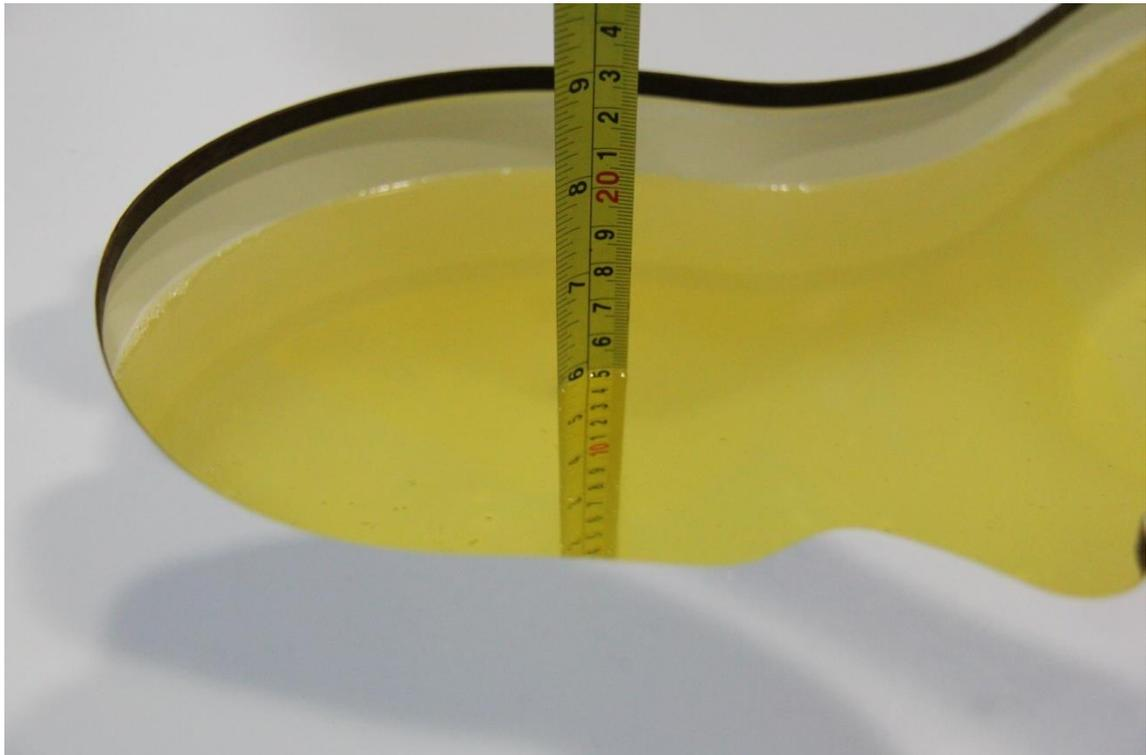

Picture 7-5 Liquid depth in the Head Phantom (2450MHz)



Picture 7-6 Liquid depth in the Head Phantom (2600 MHz)

8 System verification

8.1 System Setup

In the simplified setup for system evaluation, the DUT is replaced by a calibrated dipole and the power source is replaced by a continuous wave that comes from a signal generator. The calibrated dipole must be placed beneath the flat phantom section of the SAM twin phantom with the correct distance holder. The distance holder should touch the phantom surface with a light pressure at the reference marking and be oriented parallel to the long side of the phantom. The equipment setup is shown below:

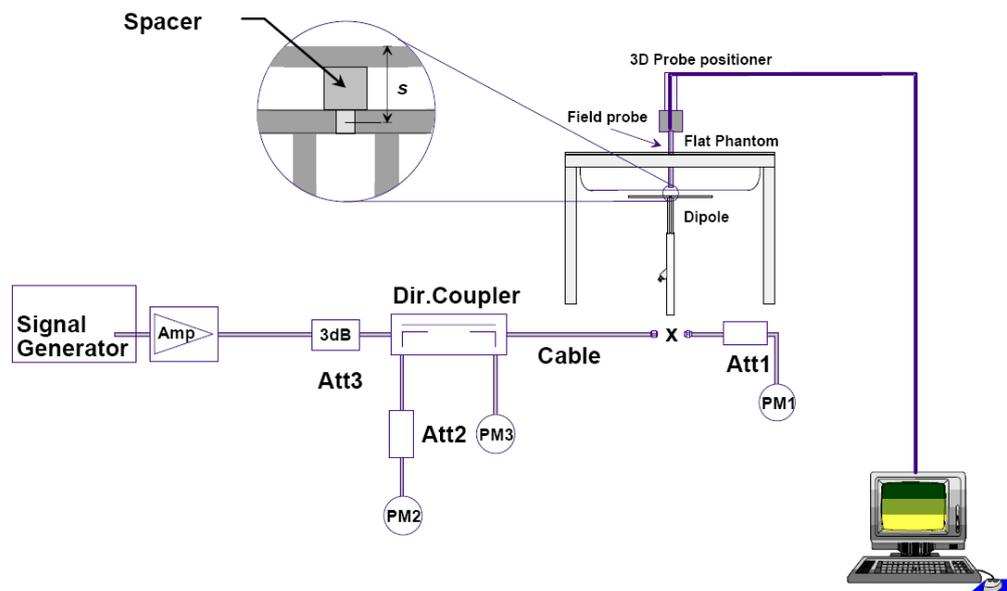

Picture 8.1 System Setup for System Evaluation



Picture 8.2 Photo of Dipole Setup

8.2 System Verification

SAR system verification is required to confirm measurement accuracy, according to the tissue dielectric media, probe calibration points and other system operating parameters required for measuring the SAR of a test device. The system verification must be performed for each frequency band and within the valid range of each probe calibration point required for testing the device.

Table 8.1: System Verification of Head

Measurement Date (yyyy-mm-dd)	Frequency	Target value (W/kg)	Measured value(W/kg)	Deviation
		1 g Average	1 g Average	1 g Average
2021/8/24	750 MHz	8.68	8.40	-3.23%
2021/8/24	835 MHz	9.63	9.16	-4.88%
2021/8/28	1750 MHz	36.9	37.0	0.38%
2021/8/28	1900 MHz	40.1	41.2	2.74%
2021/9/6	2450 MHz	53.3	53.6	0.56%
2021/8/30	2600 MHz	57.1	56.8	-0.53%
2021/9/1	2600 MHz	57.1	57.2	0.18%

9 General Measurement Procedure

9.1 Power Reference Measurement

The Power Reference Measurement and Power Drift Measurements are for monitoring the power drift of the device under test in the batch process. The minimum distance of probe sensors to surface determines the closest measurement point to phantom surface. This distance cannot be smaller than the distance of sensor calibration points to probe tip as defined in the probe properties.

9.2 Area Scan

The area scan is used as a fast scan in two dimensions to find the area of high field values, before doing a fine measurement around the hot spot. The sophisticated interpolation routines implemented in DASY software can find the maximum found in the scanned area, within a range of the global maximum. The range (in dB) is specified in the standards for compliance testing. For example, a 2 dB range is required in IEEE standard 1528 and IEC 62209 standards, whereby 3 dB is a requirement when compliance is assessed in accordance with the ARIB standard (Japan), if only one zoom scan follows the area scan, then only the absolute maximum will be taken as reference. For cases where multiple maximums are detected, the number of zoom scans has to be increased accordingly.

Area scan parameters extracted from FCC KDB 865664 D01v01r04 SAR measurement 100 MHz to 6 GHz.

	≤ 3 GHz	> 3 GHz
Maximum distance from closest measurement point (geometric center of probe sensors) to phantom surface	5 ± 1 mm	$\frac{1}{2} \cdot \delta \cdot \ln(2) \pm 0.5$ mm
Maximum probe angle from probe axis to phantom surface normal at the measurement location	30° ± 1°	20° ± 1°
Maximum area scan spatial resolution: Δx_{Area} , Δy_{Area}	≤ 2 GHz: ≤ 15 mm 2 – 3 GHz: ≤ 12 mm	3 – 4 GHz: ≤ 12 mm 4 – 6 GHz: ≤ 10 mm
	When the x or y dimension of the test device, in the measurement plane orientation, is smaller than the above, the measurement resolution must be ≤ the corresponding x or y dimension of the test device with at least one measurement point on the test device.	

9.3 Zoom Scan

Zoom Scans are used to assess the peak spatial SAR values within a cubic averaging volume containing 1 g and 10g of simulated tissue. The Zoom Scan measures points (refer to table below) within a cube whose base faces are centered on the maxima found in a preceding area scan job within the same procedure. When the measurement is done, the Zoom Scan evaluates the averaged SAR for 1 g and 10 g and displays these values next to the job' s label.

Zoom Scan Parameters extracted from KDB 865664 D01 SAR Measurement 100 MHz to 6 GHz

Maximum zoom scan spatial resolution: $\Delta x_{Zoom}, \Delta y_{Zoom}$		≤ 2 GHz: ≤ 8 mm 2 – 3 GHz: ≤ 5 mm*	3 – 4 GHz: ≤ 5 mm* 4 – 6 GHz: ≤ 4 mm*
Maximum zoom scan spatial resolution, normal to phantom surface	uniform grid: $\Delta z_{Zoom}(n)$	≤ 5 mm	3 – 4 GHz: ≤ 4 mm 4 – 5 GHz: ≤ 3 mm 5 – 6 GHz: ≤ 2 mm
	graded grid	$\Delta z_{Zoom}(1)$: between 1 st two points closest to phantom surface	≤ 4 mm 3 – 4 GHz: ≤ 3 mm 4 – 5 GHz: ≤ 2.5 mm 5 – 6 GHz: ≤ 2 mm
		$\Delta z_{Zoom}(n>1)$: between subsequent points	$\leq 1.5 \cdot \Delta z_{Zoom}(n-1)$
Minimum zoom scan volume	x, y, z	≥ 30 mm	3 – 4 GHz: ≥ 28 mm 4 – 5 GHz: ≥ 25 mm 5 – 6 GHz: ≥ 22 mm
Note: δ is the penetration depth of a plane-wave at normal incidence to the tissue medium; see draft standard IEEE P1528-2011 for details. * When zoom scan is required and the <i>reported</i> SAR from the <i>area scan based 1-g SAR estimation</i> procedures of KDB 447498 is ≤ 1.4 W/kg, ≤ 8 mm, ≤ 7 mm and ≤ 5 mm zoom scan resolution may be applied, respectively, for 2 GHz to 3 GHz, 3 GHz to 4 GHz and 4 GHz to 6 GHz.			

9.4 Power drift measurement

The Power Drift Measurement measures the field at the same location as the most recent power reference measurement within the same procedure, and with the same settings. The Power Drift Measurement gives the field difference in dB from the reading conducted within the last Power Reference Measurement. This allows a user to monitor the power drift of the device under test within a batch process. The measurement procedure is the same as 9.1.

10 Measurement Procedure for different technologies

10.1 GSM/GPRS Measurement Procedures for SAR

GSM / GPRS / EDGE modes is determined by the source-based time-averaged output power including tune-up tolerance. The mode with highest specified time-averaged output power should be tested for SAR compliance in the applicable exposure conditions. For modes with the same specified maximum output power and tolerance, the higher number time-slot configuration should be tested. Other configurations of GSM / GPRS / EDGE are considered as secondary modes. The 3G SAR test reduction procedure is applied, when the maximum output power and tune-up tolerance specified for production units in a secondary mode is $\leq \frac{1}{4}$ dB higher than the primary mode, SAR measurement is not required for the secondary mode.

10.2 WCDMA Measurement Procedures for SAR

The following procedures are applicable to WCDMA handsets operating under 3GPP Release99, Release 5 and Release 6. The default test configuration is to measure SAR with an established radio link between the DUT and a communication test set using a 12.2kbps RMC (reference measurement channel) configured in Test Loop Mode 1. SAR is selectively confirmed for other physical channel configurations (DPCCH & DPDCH_n), HSDPA and HSPA (HSUPA/HSDPA) modes according to output power, exposure conditions and device operating capabilities. Both uplink and downlink should be configured with the same RMC or AMR, when required. SAR for Release 5 HSDPA and Release 6 HSPA are measured using the applicable FRC (fixed reference channel) and E-DCH reference channel configurations. Maximum output power is verified according to applicable versions of 3GPP TS 34.121 and SAR must be measured according to these maximum output conditions. When Maximum Power Reduction (MPR) is not implemented according to Cubic Metric (CM) requirements for Release 6 HSPA, the following procedures do not apply.

For Release 5 HSDPA Data Devices:

Sub-test	β_c	β_d	β_d (SF)	β_c / β_d	β_{hs}	CM/dB
1	2/15	15/15	64	2/15	4/15	0.0
2	12/15	15/15	64	12/15	24/25	1.0
3	15/15	8/15	64	15/8	30/15	1.5
4	15/15	4/15	64	15/4	30/15	1.5

For Release 6 HSPA Data Devices

Sub-test	β_c	β_d	β_d (SF)	β_c / β_d	β_{hs}	β_{ec}	β_{ed}	β_{ed} (SF)	β_{ed} (codes)	CM (dB)	MPR (dB)	AG Index	E-TFCI
1	11/15	15/15	64	11/15	22/15	209/225	1039/225	4	1	1.5	1.5	20	75
2	6/15	15/15	64	6/15	12/15	12/15	12/15	4	1	1.5	1.5	12	67

3	15/15	9/15	64	15/9	30/15	30/15	$\beta_{ed1}:47/15$ $\beta_{ed2}:47/15$	4	2	1.5	1.5	15	92
4	2/15	15/15	64	2/15	4/15	4/15	56/75	4	1	1.5	1.5	17	71
5	15/15	15/15	64	15/15	24/15	30/15	134/15	4	1	1.5	1.5	21	81

Rel.7 Release 7 HSPA+ Data Devices

Table C.11.1.4: β values for transmitter characteristics tests with HS-DPCCH and E-DCH with 16QAM

Sub-test	β_c (Note 3)	β_d	β_{HS} (Note 1)	β_{ec}	β_{ed} (2xSF2) (Note 4)	β_{ed} (2xSF4) (Note 4)	CM (dB) (Note 2)	MPR (dB) (Note 2)	AG Index (Note 4)	E-TFCI (Note 5)	E-TFCI (boost)
1	1	0	30/15	30/15	$\beta_{ed1}: 30/15$ $\beta_{ed2}: 30/15$	$\beta_{ed3}: 24/15$ $\beta_{ed4}: 24/15$	3.5	2.5	14	105	105
<p>Note 1: $\Delta_{ACK}, \Delta_{NACK}$ and $\Delta_{CQI} = 30/15$ with $\beta_{hs} = 30/15 * \beta_c$.</p> <p>Note 2: CM = 3.5 and the MPR is based on the relative CM difference, MPR = MAX(CM-1,0).</p> <p>Note 3: DPDCH is not configured, therefore the β_c is set to 1 and $\beta_d = 0$ by default.</p> <p>Note 4: β_{ed} can not be set directly; it is set by Absolute Grant Value.</p> <p>Note 5: All the sub-tests require the UE to transmit 2SF2+2SF4 16QAM EDCH and they apply for UE using E-DPDCH category 7. E-DCH TTI is set to 2ms TTI and E-DCH table index = 2. To support these E-DCH configurations DPDCH is not allocated. The UE is signalled to use the extrapolation algorithm.</p>											

Rel.8 DC-HSDPA (Cat 24)

SAR test exclusion for Rel.8 DC-HSDPA must satisfy the SAR test exclusion requirements of Rel.5 HSDPA. SAR test exclusion for DC-HSDPA devices is determined by power measurements according to the H-Set 12, Fixed Reference Channel (FRC) configuration in Table C.8.1.12 of 3GPP TS 34.121-1. A primary and a secondary serving HS-DSCH Cell are required to perform the power measurement and for the results to qualify for SAR test exclusion.

Table C.8.1.12: Fixed Reference Channel H-Set 12

Parameter	Unit	Value
Nominal Avg. Inf. Bit Rate	kbps	60
Inter-TTI Distance	TTI's	1
Number of HARQ Processes	Processes	6
Information Bit Payload (N_{INF})	Bits	120
Number Code Blocks	Blocks	1
Binary Channel Bits Per TTI	Bits	960
Total Available SML's in UE	SML's	19200
Number of SML's per HARQ Proc.	SML's	3200
Coding Rate		0.15
Number of Physical Channel Codes	Codes	1
Modulation		QPSK
<p>Note 1: The RMC is intended to be used for DC-HSDPA mode and both cells shall transmit with identical parameters as listed in the table.</p> <p>Note 2: Maximum number of transmission is limited to 1, i.e., retransmission is not allowed. The redundancy and constellation version 0 shall be used.</p>		

10.3 LTE Measurement Procedures for SAR

SAR tests for LTE are performed with a base station simulator, Rohde & Schwarz CMW500 or Anritsu MT8821C Closed loop power control was used so the UE transmits with maximum output power during SAR testing.

It is performed for conducted power and SAR based on the KDB941225 D05.

SAR is evaluated separately according to the following procedures for the different test positions in each exposure condition – head, body, body-worn accessories and other use conditions. The procedures in the following subsections are applied separately to test each LTE frequency band.

1) QPSK with 1 RB allocation

Start with the largest channel bandwidth and measure SAR for QPSK with 1 RB allocation, using the RB offset and required test channel combination with the highest maximum output power among RB offsets at the upper edge, middle and lower edge of each required test channel. When the reported SAR is ≤ 0.8 W/kg, testing of the remaining RB offset configurations and required test channels is not required for 1 RB allocation; otherwise, SAR is required for the remaining required test channels and only for the RB offset configuration with the highest output power for that channel. When the reported SAR of a required test channel is > 1.45 W/kg, SAR is required for all three RB offset configurations for that required test channel.

2) QPSK with 50% RB allocation

The procedures required for 1 RB allocation in 1) are applied to measure the SAR for QPSK with 50% RB allocation.

3) QPSK with 100% RB allocation

For QPSK with 100% RB allocation, SAR is not required when the highest maximum output power for 100 % RB allocation is less than the highest maximum output power in 50% and 1 RB allocations and the highest reported SAR for 1 RB and 50% RB allocation in 1) and 2) are ≤ 0.8 W/kg. Otherwise, SAR is measured for the highest output power channel; and if the reported SAR is > 1.45 W/kg, the remaining required test channels must also be tested.

TDD test:

TDD testing is performed using guidance from FCC KDB 941225 D05 v02r05 and the SAR test guidance provided in April 2013 TCB works hop notes. TDD is tested at the highest duty factor using UL-DL configuration 0 with special subframe configuration 6 and applying the FDD LTE procedures in KDB 941225 D05 v02r05. SAR testing is performed using the extended cyclic prefix listed in 3GPP TS 36.211.

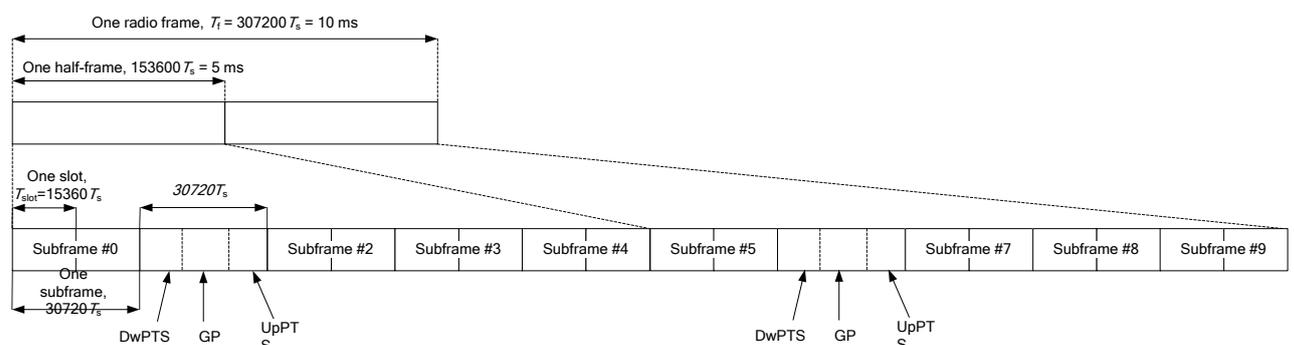

Figure 10.2: Frame structure type 2 (for 5 ms switch-point periodicity)

Table 10.1: Configuration of special subframe (lengths of DwPTS/GP/UpPTS)

Special subframe configuration	Normal cyclic prefix in downlink			Extended cyclic prefix in downlink		
	DwPTS	UpPTS		DwPTS	UpPTS	
		Normal cyclic prefix in uplink	Extended cyclic prefix in uplink		Normal cyclic prefix in uplink	Extended cyclic prefix in uplink
0	$6592 \cdot T_s$	$2192 \cdot T_s$	$2560 \cdot T_s$	$7680 \cdot T_s$	$2192 \cdot T_s$	$2560 \cdot T_s$
1	$19760 \cdot T_s$			$20480 \cdot T_s$		
2	$21952 \cdot T_s$			$23040 \cdot T_s$		
3	$24144 \cdot T_s$			$25600 \cdot T_s$		
4	$26336 \cdot T_s$	$4384 \cdot T_s$	$5120 \cdot T_s$	$7680 \cdot T_s$	$4384 \cdot T_s$	$5120 \cdot T_s$
5	$6592 \cdot T_s$			$20480 \cdot T_s$		
6	$19760 \cdot T_s$			$23040 \cdot T_s$		
7	$21952 \cdot T_s$			$12800 \cdot T_s$		
8	$24144 \cdot T_s$			-		
9	$13168 \cdot T_s$	-	-	-	-	-

Table 10.2: Uplink-downlink configurations

Uplink-downlink configuration	Downlink-to-Uplink Switch-point periodicity	Subframe number										
		0	1	2	3	4	5	6	7	8	9	
0	5 ms	D	S	U	U	U	D	S	U	U	U	
1	5 ms	D	S	U	U	D	D	S	U	U	D	
2	5 ms	D	S	U	D	D	D	S	U	D	D	
3	10 ms	D	S	U	U	U	D	D	D	D	D	
4	10 ms	D	S	U	U	D	D	D	D	D	D	
5	10 ms	D	S	U	D	D	D	D	D	D	D	
6	5 ms	D	S	U	U	U	D	S	U	U	D	

Duty factor is calculated by:

Duty factor = uplink frame*6+UpPTS*2/one frame length

$$= (30720 \cdot T_s * 6 + 5120 \cdot T_s * 2) / 307200 \cdot T_s$$

$$= 0.633$$

According to the KDB 447498 D01, SAR should be evaluated at more than 3 frequencies for devices supporting transmit bands wider than 100MHz. Oct.2014 FCC-TCB conference notes (Dec. 2014 rev.) specifies the 5 test channels to use for 3GPP band 38/41 SAR evaluation.

10.4 Bluetooth & Wi-Fi Measurement Procedures for SAR

Normal network operating configurations are not suitable for measuring the SAR of 802.11 transmitters in general. Unpredictable fluctuations in network traffic and antenna diversity conditions can introduce undesirable variations in SAR results. The SAR for these devices should be measured using chipset based test mode software to ensure that the results are consistent and reliable.

Chipset based test mode software is hardware dependent and generally varies among manufacturers. The device operating parameters established in a test mode for SAR measurements must be identical to those programmed in production units, including output power levels, amplifier gain settings and other RF performance tuning parameters. The test frequencies should correspond to actual channel frequencies defined for domestic use. SAR for devices with switched diversity should be measured with only one antenna transmitting at a time during each SAR measurement, according to a fixed modulation and data rate. The same data pattern should be used for all measurements.

11 Conducted Output Power

11.1 GSM Measurement result

During the process of testing, the EUT was controlled via R&S Digital Radio Communication tester (CMW500) to ensure the maximum power transmission and proper modulation. This result contains conducted output power for the EUT. In all cases, the measured peak output power should be greater and within 5% than EMI measurement.

GSM850

GSM 850 Speech (GMSK)	Measured Power (dBm)			Tune up	calculation	Averaged Power (dBm)		
	251	190	128			251	190	128
1 Txslot	32.72	32.77	32.80	33.50	-9.03	23.69	23.74	23.77
GSM 850 GPRS (GMSK)	Measured Power (dBm)				calculation	Averaged Power (dBm)		
	251	190	128			251	190	128
1 Txslot	32.75	32.82	32.84	33.50	-9.03	23.72	23.79	23.81
2 Txslots	30.90	30.96	30.99	31.50	-6.02	24.88	24.94	24.97
3Txslots	28.73	28.76	28.77	29.50	-4.26	24.47	24.50	24.51
4 Txslots	26.07	26.08	26.08	27.00	-3.01	23.06	23.07	23.07
GSM 850 EGPRS (GMSK)	Measured Power (dBm)				calculation	Averaged Power (dBm)		
	251	190	128			251	190	128
1 Txslot	32.73	32.79	32.81	33.50	-9.03	23.70	23.76	23.78
2 Txslots	30.87	30.94	30.96	31.50	-6.02	24.85	24.92	24.94
3Txslots	28.70	28.74	28.74	29.50	-4.26	24.44	24.48	24.48
4 Txslots	26.02	26.05	26.04	27.00	-3.01	23.01	23.04	23.03
GSM 850 EGPRS (8PSK)	Measured Power (dBm)				calculation	Averaged Power (dBm)		
	251	190	128			251	190	128
1 Txslot	25.33	24.58	24.25	26.00	-9.03	16.30	15.55	15.22
2 Txslots	24.29	24.06	23.91	25.00	-6.02	18.27	18.04	17.89
3Txslots	22.73	22.65	22.74	23.00	-4.26	18.47	18.39	18.48
4 Txslots	20.12	20.06	19.98	20.50	-3.01	17.11	17.05	16.97

GSM1900

GSM 1900 Speech (GMSK)	Measured Power (dBm)			Tune up	calculation	Averaged Power (dBm)		
	810	661	512			810	661	512
1 Txslot	29.98	29.98	30.19	31.50	-9.03	20.95	20.95	21.16
GSM 1900 GPRS (GMSK)	Measured Power (dBm)				calculation	Averaged Power (dBm)		
	251	190	128			251	190	128
1 Txslot	30.00	30.39	30.56	31.50	-9.03	20.97	21.36	21.53
2 Txslots	27.48	27.92	28.31	28.50	-6.02	21.46	21.90	22.29
3Txslots	25.92	26.32	26.76	27.00	-4.26	21.66	22.06	22.50
4 Txslots	23.38	23.67	23.99	24.50	-3.01	20.37	20.66	20.98
GSM 1900 EGPRS (GMSK)	Measured Power (dBm)				calculation	Averaged Power (dBm)		
	810	661	512			810	661	512

1 Txslot	30.36	30.37	30.55	31.50	-9.03	21.33	21.34	21.52
2 Txslots	27.44	27.89	28.32	28.50	-6.02	21.42	21.87	22.30
3Txslots	25.87	26.29	26.76	27.00	-4.26	21.61	22.03	22.50
4 Txslots	23.32	23.65	24.00	24.50	-3.01	20.31	20.64	20.99
GSM 1900 EGPRS (8PSK)	Measured Power (dBm)				calculation	Averaged Power (dBm)		
	810	661	512			810	661	512
1 Txslot	24.19	24.36	24.10	26.00	-9.03	15.16	15.33	15.07
2 Txslots	23.76	24.24	24.37	24.50	-6.02	17.74	18.22	18.35
3Txslots	22.58	23.01	22.77	23.50	-4.26	18.32	18.75	18.51
4 Txslots	19.87	20.36	20.17	20.50	-3.01	16.86	17.35	17.16

11.2 WCDMA Measurement result

WCDMA1900

Item	band	FDDII result			
	ARFCN	9538 (1907.6MHz)	9400 (1880MHz)	9262 (1852.4MHz)	Tune up
WCDMA	\	23.44	23.41	23.43	24.00
HSUPA	1	22.7	22.89	22.88	23.50
	2	22.85	23.04	22.96	23.50
	3	22.54	22.78	22.83	23.50
	4	22.97	23.12	23.09	23.50
	5	22.75	22.93	22.94	23.50
HSPA+		22.92	23.05	22.93	23.50
DC-HSDPA	1	22.23	21.97	20.62	22.50
	2	21.64	21.85	21.84	22.50
	3	21.41	21.59	21.53	22.50
	4	21.34	21.53	21.50	22.50

WCDMA1700

Item	band	FDDIV result			
	ARFCN	1513 (1752.6MHz)	1412 (1732.4MHz)	1312 (1712.4MHz)	Tune up
WCDMA	\	23.60	23.55	23.50	24.00
HSUPA	1	23.01	22.86	23.08	23.50
	2	23.15	23.03	23.09	23.50
	3	22.84	22.88	23.02	23.50
	4	23.17	23.09	23.13	23.50
	5	22.28	22.14	22.20	23.50
HSPA+		23.18	22.97	22.99	23.50
DC-HSDPA	1	20.74	20.63	20.70	22.50
	2	21.47	21.26	21.52	22.50
	3	21.33	21.11	21.09	22.50
	4	21.03	21.12	21.28	22.50

WCDMA850

Item	band	FDDV result			
	ARFCN	4233 (846.6MHz)	4183 (836.6MHz)	4132 (826.4MHz)	Tune up
WCDMA	\	23.37	23.31	23.29	24.00
HSUPA	1	22.42	22.94	23.17	23.50
	2	23.11	23.28	23.40	23.50
	3	22.7	22.92	23.01	23.50
	4	23.2	23.41	23.46	23.50
	5	22.17	22.41	22.52	23.50
HSPA+		22.8	22.93	23.15	23.50
DC-HSDPA	1	21.67	21.88	22.20	22.50
	2	21.42	21.47	21.65	22.50
	3	20.75	20.75	20.95	22.50
	4	20.78	20.74	20.93	22.50

11.3 LTE Measurement result

The maximum output power(Tune-up Limit)=Target power+ Tolerance

Band	Mode	Target Power(dBm)	Tolerance(dBm)
LTE Band 2	QPSK	23	(±1.0)
LTE Band 4/66	QPSK	23	(±1.0)
LTE Band 5	QPSK	23	(±1.0)
LTE Band 7	QPSK	23	(±1.0)
LTE Band 12/17	QPSK	23	(±1.0)
LTE Band 38/41	QPSK	23	(±1.5)

The following tests were conducted according to the test requirements outlined in section 6.2 of the 3GPP TS36.101 specification. UE Power Class: 3 (23 +/- 2dBm). The allowed Maximum Power Reduction (MPR) for the maximum output power due to higher order modulation and transmit bandwidth configuration (resource blocks) is specified in Table 6.2.3-1 of the 3GPP TS36.101.

Table 6.2.3-1: Maximum Power Reduction (MPR) for Power Class 1, 2 and 3

Modulation	Channel bandwidth / Transmission bandwidth (N _{RB})						MPR (dB)
	1.4 MHz	3.0 MHz	5 MHz	10 MHz	15 MHz	20 MHz	
QPSK	> 5	> 4	> 8	> 12	> 16	> 18	≤ 1
16 QAM	≤ 5	≤ 4	≤ 8	≤ 12	≤ 16	≤ 18	≤ 1
16 QAM	> 5	> 4	> 8	> 12	> 16	> 18	≤ 2
64 QAM	≤ 5	≤ 4	≤ 8	≤ 12	≤ 16	≤ 18	≤ 2
64 QAM	> 5	> 4	> 8	> 12	> 16	> 18	≤ 3
256 QAM	≥ 1						≤ 5

LTE B2

Band 2						
Bandwidth (MHz)	RB allocation	Frequency (MHz)	Actual output power (dBm)			
	RB offset		QPSK	16QAM	64QAM	
1.4MHz	1RB-High (5)	1909.3	23.06	22.70	21.29	
		1880	23.13	22.00	20.95	
		1850.7	23.12	22.64	21.46	
	1RB-Middle (3)	1909.3	23.15	22.72	21.39	
		1880	23.19	22.11	21.10	
		1850.7	23.18	22.70	21.52	
	1RB-Low (0)	1909.3	23.10	22.67	21.50	
		1880	23.13	22.15	21.09	
		1850.7	23.11	22.74	21.43	
	3RB-High (3)	1909.3	23.70	22.94	21.62	
		1880	23.85	22.67	21.55	
		1850.7	23.83	22.85	21.79	
	3RB-Middle (1)	1909.3	23.78	22.95	21.67	
		1880	23.89	22.71	21.55	
		1850.7	23.79	22.93	21.85	
	3RB-Low (0)	1909.3	23.75	22.94	21.63	
		1880	23.83	22.63	21.64	
		1850.7	23.83	22.86	21.90	
	6RB (0)	1909.3	22.61	21.61	19.65	
		1880	22.65	21.49	20.45	
		1850.7	22.87	21.59	20.23	
	3MHz	1RB-High (14)	1908.5	23.09	22.73	21.25
			1880	23.29	22.24	21.00
			1851.5	23.26	22.76	21.62
1RB-Middle (7)		1908.5	23.08	22.75	21.40	
		1880	23.26	22.22	21.14	
		1851.5	23.25	22.65	21.48	
1RB-Low (0)		1908.5	23.10	22.78	21.29	
		1880	23.18	22.31	21.23	
		1851.5	23.31	22.62	21.60	
8RB-High (7)		1908.5	22.66	21.79	19.83	
		1880	22.70	21.84	20.53	
		1851.5	22.73	21.94	20.26	
8RB-Middle (4)		1908.5	22.78	21.86	19.97	
		1880	22.75	21.80	20.51	
		1851.5	22.78	21.91	20.34	
8RB-Low (0)		1908.5	22.78	21.86	20.09	
		1880	22.71	21.74	20.41	
		1851.5	22.76	21.99	20.32	
15RB (0)		1908.5	22.73	21.79	19.96	

		1880	22.82	21.83	20.38
		1851.5	22.86	21.93	20.26
5MHz	1RB-High (24)	1907.5	23.00	22.61	21.30
		1880	23.17	22.78	21.32
		1852.5	23.18	22.89	21.48
	1RB-Middle (12)	1907.5	23.14	22.70	21.38
		1880	23.24	22.78	21.46
		1852.5	23.16	22.81	21.42
	1RB-Low (0)	1907.5	23.09	22.66	21.39
		1880	23.21	22.76	21.69
		1852.5	23.17	22.80	21.61
	12RB-High (13)	1907.5	22.62	21.86	19.90
		1880	22.65	21.85	20.33
		1852.5	22.67	21.86	20.17
	12RB-Middle (6)	1907.5	22.64	21.80	20.31
		1880	22.66	21.91	20.49
		1852.5	22.84	21.99	20.30
	12RB-Low (0)	1907.5	22.67	21.85	20.35
		1880	22.69	21.82	20.41
		1852.5	22.72	21.85	20.20
25RB (0)	1907.5	22.72	21.76	20.13	
	1880	22.69	21.97	20.36	
	1852.5	22.68	21.88	20.16	
10MHz	1RB-High (49)	1905	23.11	22.75	21.41
		1880	23.23	22.58	21.25
		1855	23.30	22.79	21.47
	1RB-Middle (24)	1905	23.07	22.77	21.49
		1880	23.22	22.79	21.36
		1855	23.29	22.70	21.60
	1RB-Low (0)	1905	23.09	22.86	21.36
		1880	23.22	22.72	21.42
		1855	23.32	22.77	21.51
	25RB-High (25)	1905	22.83	21.75	20.53
		1880	22.65	21.75	20.62
		1855	22.78	21.88	20.59
	25RB-Middle (12)	1905	22.71	21.78	20.71
		1880	22.70	21.78	20.55
		1855	22.87	21.98	20.37
	25RB-Low (0)	1905	22.67	21.74	20.84
		1880	22.71	21.79	20.55
		1855	22.78	21.91	20.28
50RB (0)	1905	22.69	21.79	20.64	
	1880	22.70	21.83	20.60	
	1855	22.81	21.91	20.44	
15MHz	1RB-High (74)	1902.5	23.15	22.85	21.36
		1880	23.11	22.90	21.24
		1857.5	23.25	22.91	21.59
	1RB-Middle	1902.5	23.10	22.76	21.41



	(37)	1880	23.15	22.87	21.24	
		1857.5	23.22	22.85	21.42	
	1RB-Low (0)	1902.5	23.04	22.70	21.39	
		1880	23.19	22.96	21.23	
	36RB-High (38)	1857.5	23.24	22.86	21.73	
		1902.5	22.76	21.89	19.82	
		1880	22.71	21.74	20.48	
	36RB-Middle (19)	1857.5	22.86	21.84	20.48	
		1902.5	22.71	21.87	20.20	
		1880	22.71	21.76	20.53	
	36RB-Low (0)	1857.5	22.79	21.87	20.39	
		1902.5	22.66	21.89	20.51	
		1880	22.81	21.80	20.72	
	75RB (0)	1857.5	22.82	21.89	20.42	
		1902.5	22.81	21.90	20.17	
		1880	22.80	21.85	20.57	
	20MHz	1RB-High (99)	1857.5	22.83	21.93	20.42
			1880	22.80	21.85	20.57
1900			23.25	22.71	21.59	
1RB-Middle (50)		1860	23.28	22.88	21.55	
		1880	23.30	22.23	21.03	
		1900	23.22	22.67	21.62	
1RB-Low (0)		1860	23.18	22.90	21.49	
		1880	23.23	21.92	21.11	
		1900	23.29	22.71	21.51	
50RB-High (50)		1860	23.29	22.79	21.70	
		1880	23.36	22.24	21.23	
		1900	22.75	21.75	20.26	
50RB-Middle (25)		1860	22.78	21.83	20.73	
		1880	22.87	21.93	20.56	
		1900	22.68	21.77	20.46	
50RB-Low (0)		1860	22.80	21.77	20.52	
		1880	22.91	21.88	20.35	
		1900	22.77	21.82	20.61	
100RB (0)		1860	22.82	21.92	20.70	
		1880	22.94	21.97	20.22	
		1900	22.74	21.88	20.42	
			1880	22.78	21.94	20.70
			1860	22.77	21.90	20.37

LTE B5

Band 5					
Bandwidth (MHz)	RB allocation	Frequency (MHz)	Actual output power (dBm)		
	RB offset		QPSK	16QAM	64QAM
		848.3	22.76	22.21	20.76

		836.5	22.69	22.17	21.04
		824.7	22.57	22.28	20.69
	1RB-Middle (3)	848.3	22.80	22.19	20.85
		836.5	22.73	22.20	20.94
		824.7	22.60	22.15	21.35
	1RB-Low (0)	848.3	22.78	22.12	20.74
		836.5	22.63	22.30	20.70
		824.7	22.63	22.27	21.52
	3RB-High (3)	848.3	23.40	22.53	21.25
		836.5	23.34	22.62	21.28
		824.7	23.19	22.55	21.25
	3RB-Middle (1)	848.3	23.46	22.67	21.20
		836.5	23.35	22.61	21.30
		824.7	23.24	22.64	21.08
	3RB-Low (0)	848.3	23.42	22.66	21.26
		836.5	23.29	22.67	21.32
		824.7	23.31	22.67	21.17
	6RB (0)	848.3	22.27	21.07	19.63
836.5		22.28	21.24	19.79	
824.7		22.28	21.04	19.99	
3MHz	1RB-High (14)	847.5	22.79	22.01	20.88
		836.5	22.67	22.32	20.94
		825.5	22.68	22.25	20.71
	1RB-Middle (7)	847.5	22.78	21.92	20.82
		836.5	22.60	22.28	20.79
		825.5	22.60	22.18	21.26
	1RB-Low (0)	847.5	22.83	22.00	20.83
		836.5	22.76	22.27	20.63
		825.5	22.68	22.26	21.20
	8RB-High (7)	847.5	22.34	21.41	19.70
		836.5	22.36	21.40	19.90
		825.5	22.16	21.35	20.12
	8RB-Middle (4)	847.5	22.39	21.45	19.74
		836.5	22.36	21.53	19.95
		825.5	22.32	21.24	20.13
	8RB-Low (0)	847.5	22.35	21.39	19.70
		836.5	22.28	21.45	19.82
		825.5	22.24	21.36	20.04
15RB (0)	847.5	22.38	21.38	19.68	
	836.5	22.33	21.40	19.87	
	825.5	22.27	21.32	20.07	
5MHz	1RB-High (24)	846.5	22.75	22.11	20.84
		836.5	22.67	22.28	20.85
		826.5	22.66	22.29	20.99
	1RB-Middle (12)	846.5	22.67	22.12	20.93
		836.5	22.61	22.13	21.01
		826.5	22.64	22.24	20.64
1RB-Low (0)	846.5	22.72	22.28	21.05	

	12RB-High (13)	836.5	22.65	22.23	20.74	
		826.5	22.61	22.18	20.75	
		846.5	22.28	21.42	19.62	
	12RB-Middle (6)	836.5	22.33	21.36	19.83	
		826.5	22.21	21.32	19.93	
		846.5	22.29	21.43	19.79	
	12RB-Low (0)	836.5	22.41	21.36	19.92	
		826.5	22.25	21.30	20.03	
		846.5	22.23	21.39	19.67	
	25RB (0)	836.5	22.31	21.33	19.66	
		826.5	22.23	21.20	19.84	
		846.5	22.33	21.59	19.60	
	10MHz	1RB-High (49)	844	22.79	22.17	20.85
			836.5	22.63	22.15	20.83
			829	22.68	22.34	20.93
1RB-Middle (24)		844	22.89	22.19	20.88	
		836.5	22.68	22.31	20.98	
		829	22.69	22.26	20.84	
1RB-Low (0)		844	22.82	22.17	21.04	
		836.5	22.67	22.22	21.33	
		829	22.56	22.31	20.60	
25RB-High (25)		844	22.35	21.32	20.16	
		836.5	22.28	21.26	20.02	
		829	22.31	21.61	19.83	
25RB-Middle (12)		844	22.39	21.37	20.05	
		836.5	22.29	21.28	19.90	
		829	22.32	21.25	19.61	
25RB-Low (0)		844	22.43	21.34	20.09	
		836.5	22.36	21.33	19.68	
		829	22.35	21.23	19.39	
50RB (0)		844	22.36	21.29	20.07	
		836.5	22.27	21.41	19.93	
		829	22.33	21.27	19.63	

LTE B7

Band 7					
Bandwidth (MHz)	RB allocation	Frequency (MHz)	Actual output power (dBm)		
	RB offset		QPSK	16QAM	64QAM
5MHz	1RB-High (24)	2567.5	23.49	22.55	21.64
		2535	23.39	22.93	21.32
		2502.5	23.71	23.40	21.78
	1RB-Middle	2567.5	23.38	22.59	21.65

	(12)	2535	23.46	23.09	21.71	
		2502.5	23.66	23.44	21.77	
	1RB-Low (0)	2567.5	23.42	23.05	21.65	
		2535	23.52	23.20	21.57	
		2502.5	23.74	23.53	21.87	
	12RB-High (13)	2567.5	22.57	21.68	21.64	
		2535	22.56	21.54	21.54	
		2502.5	22.94	21.94	21.88	
	12RB-Middle (6)	2567.5	22.53	21.62	21.70	
		2535	22.58	21.63	21.62	
		2502.5	22.81	21.97	21.94	
	12RB-Low (0)	2567.5	22.54	21.65	21.59	
		2535	22.68	21.64	21.61	
		2502.5	22.97	22.01	21.96	
	25RB (0)	2567.5	22.51	21.52	21.68	
2535		22.56	21.56	21.64		
2502.5		22.87	21.87	21.95		
10MHz	1RB-High (49)	2565	23.56	23.15	21.65	
		2535	23.35	22.43	21.35	
		2505	23.73	23.34	21.75	
	1RB-Middle (24)	2565	23.44	23.12	21.45	
		2535	23.45	22.44	21.52	
		2505	23.73	23.31	21.94	
	1RB-Low (0)	2565	23.51	23.10	21.57	
		2535	23.50	23.05	21.53	
		2505	23.86	23.48	22.12	
	25RB-High (25)	2565	22.55	21.48	21.73	
		2535	22.54	21.47	21.56	
		2505	22.77	22.04	21.87	
	25RB-Middle (12)	2565	22.54	21.55	21.63	
		2535	22.53	21.55	21.62	
		2505	22.77	22.09	21.90	
	25RB-Low (0)	2565	22.49	21.51	21.69	
		2535	22.65	21.50	21.71	
		2505	22.84	21.98	21.90	
	50RB (0)	2565	22.58	21.63	21.67	
		2535	22.49	21.62	21.69	
		2505	22.81	21.88	21.96	
	15MHz	1RB-High (74)	2562.5	23.28	22.49	21.61
			2535	23.23	22.54	21.33
			2507.5	23.55	22.81	21.86
		1RB-Middle (37)	2562.5	23.38	22.45	21.42
			2535	23.29	23.16	21.59
			2507.5	23.57	22.78	21.84
1RB-Low (0)		2562.5	23.24	22.46	21.44	
		2535	23.43	23.23	21.73	
		2507.5	23.77	23.59	22.02	
36RB-High (38)		2562.5	22.37	21.47	21.55	

	36RB-Middle (19)	2535	22.39	21.41	21.51
		2507.5	22.74	21.95	21.88
		2562.5	22.43	21.46	21.65
		2535	22.53	21.41	21.66
		2507.5	22.73	22.01	21.77
		2562.5	22.51	21.39	21.53
	36RB-Low (0)	2535	22.62	21.59	21.68
		2507.5	22.83	21.95	21.84
		2562.5	22.46	21.53	21.55
	75RB (0)	2535	22.52	21.69	21.59
		2507.5	22.76	21.81	21.87
		2560	23.45	22.61	21.56
20MHz	1RB-High (99)	2535	23.62	22.68	21.40
		2510	23.86	23.39	21.66
		2560	23.35	22.40	21.33
	1RB-Middle (50)	2535	23.45	22.87	21.44
		2510	23.71	23.51	21.76
		2560	23.35	22.53	21.33
	1RB-Low (0)	2535	23.61	23.05	21.55
		2510	23.84	23.59	21.83
		2560	22.58	21.49	21.60
	50RB-High (50)	2535	22.58	21.55	21.56
		2510	22.76	21.72	21.75
		2560	22.39	21.55	21.53
	50RB-Middle (25)	2535	22.54	21.52	21.64
		2510	22.73	21.85	21.85
		2560	22.53	21.50	21.62
	50RB-Low (0)	2535	22.56	21.67	21.66
		2510	22.74	21.92	21.93
		2560	22.47	21.46	21.52
	100RB (0)	2535	22.52	21.67	21.58
		2510	22.68	21.82	21.72

LTE B12

Band 12					
Bandwidth (MHz)	RB allocation	Frequency (MHz)	Actual output power (dBm)		
	RB offset		QPSK	16QAM	64QAM
1.4MHz	1RB-High	715.3	22.96	22.47	21.15
		707.5	22.87	22.40	20.93
		699.7	22.80	22.19	21.08
	1RB-Middle (3)	715.3	23.00	22.36	21.07
		707.5	22.88	22.37	21.01
		699.7	22.94	22.34	21.04
	1RB-Low (0)	715.3	22.89	22.03	21.15

	3RB-High (3)	707.5	22.87	22.51	21.42
		699.7	22.83	22.40	21.15
		715.3	23.59	22.83	21.38
	3RB-Middle (1)	707.5	23.56	22.82	21.39
		699.7	23.63	22.81	21.43
		715.3	23.62	22.82	21.48
	3RB-Low (0)	707.5	23.63	22.89	21.47
		699.7	23.63	22.67	21.40
		715.3	23.57	22.65	21.43
	6RB (0)	707.5	23.54	22.82	21.48
		699.7	23.52	22.81	21.35
		715.3	22.54	21.27	19.07
3MHz	1RB-High (14)	707.5	22.45	21.33	19.02
		699.7	22.46	21.36	19.00
		714.5	23.07	22.59	20.97
	1RB-Middle (7)	707.5	22.81	22.48	20.87
		700.5	22.92	22.36	21.14
		714.5	22.95	22.40	21.00
	1RB-Low (0)	707.5	22.87	22.45	20.98
		700.5	22.98	22.23	21.08
		714.5	23.08	22.53	20.91
	8RB-High (7)	707.5	22.92	22.53	21.46
		700.5	22.93	22.37	21.06
		714.5	22.56	21.61	19.14
	8RB-Middle (4)	707.5	22.49	21.71	19.13
		700.5	22.49	21.75	19.27
		714.5	22.51	21.67	19.08
	8RB-Low (0)	707.5	22.53	21.62	19.19
		700.5	22.49	21.63	19.30
		714.5	22.55	21.73	19.00
15RB (0)	707.5	22.50	21.95	19.16	
	700.5	22.54	21.65	19.17	
	714.5	22.30	21.61	19.03	
5MHz	1RB-High (24)	707.5	22.40	21.70	19.13
		700.5	22.44	21.54	19.18
		713.5	23.02	22.43	21.08
	1RB-Middle (12)	707.5	22.84	22.46	20.85
		701.5	22.85	22.56	21.24
		713.5	22.97	22.39	20.98
	1RB-Low (0)	707.5	22.84	22.36	21.14
		701.5	22.96	22.62	21.00
		713.5	23.08	22.48	21.10
	12RB-High (13)	707.5	22.92	22.45	21.46
		701.5	22.92	22.59	20.99
		713.5	22.49	21.54	19.02
	12RB-Middle	707.5	22.56	21.54	19.04
		701.5	22.49	21.54	19.14
			713.5	22.33	21.53

	(6)	707.5	22.54	21.58	19.18
		701.5	22.55	21.60	19.35
	12RB-Low (0)	713.5	22.62	21.62	19.13
		707.5	22.60	21.99	19.07
		701.5	22.50	21.52	19.12
	25RB (0)	713.5	22.34	21.72	19.08
		707.5	22.42	21.75	19.05
		701.5	22.52	21.75	19.11
	10MHz	1RB-High (49)	711	22.90	22.37
707.5			22.75	22.34	20.94
704			22.79	22.28	20.98
1RB-Middle (24)		711	22.93	22.41	20.79
		707.5	22.83	22.31	20.86
		704	22.86	22.35	21.17
1RB-Low (0)		711	22.86	22.25	21.30
		707.5	22.81	22.29	20.93
		704	22.79	22.49	21.06
25RB-High (25)		711	22.45	21.44	19.18
		707.5	22.31	21.38	19.31
		704	22.45	21.81	19.33
25RB-Middle (12)		711	22.43	21.32	19.17
		707.5	22.32	21.43	19.13
		704	22.45	21.92	19.21
25RB-Low (0)		711	22.60	21.88	19.07
		707.5	22.43	21.49	19.08
		704	22.48	21.70	19.16
50RB (0)		711	22.30	21.43	19.16
		707.5	22.36	21.52	19.22
		704	22.46	21.94	19.25

LTE B41

Band 41					
Bandwidth (MHz)	RB allocation	Frequency (MHz)	Actual output power (dBm)		
	RB offset		QPSK	16QAM	64QAM
5MHz	1RB-High (24)	2687.5	23.80	22.29	21.79
		2640.3	23.92	22.38	21.70
		2593	23.96	22.69	21.58
		2545.8	24.01	22.60	21.18
		2498.5	23.89	22.28	21.73
	1RB-Middle (12)	2687.5	23.79	22.43	21.95
		2640.3	23.69	22.51	22.02
		2593	24.11	22.57	21.55
		2545.8	23.87	22.41	21.23

	1RB-Low (0)	2498.5	23.83	22.49	21.66
		2687.5	23.82	22.59	21.74
		2640.3	23.90	22.39	21.81
		2593	24.04	22.76	21.64
		2545.8	23.88	22.40	21.20
		2498.5	23.86	22.40	21.68
	12RB-High (13)	2687.5	22.77	21.92	21.21
		2640.3	22.92	22.04	21.21
		2593	23.05	21.98	21.08
		2545.8	22.97	21.96	20.74
		2498.5	22.84	21.69	20.82
	12RB-Middle (6)	2687.5	22.81	21.90	21.14
		2640.3	22.89	21.95	21.22
		2593	23.10	22.07	20.86
		2545.8	22.86	21.99	20.54
	12RB-Low (0)	2498.5	22.83	21.72	20.86
		2687.5	22.80	21.88	21.24
		2640.3	22.93	21.96	20.76
		2593	23.02	22.08	20.99
		2545.8	22.86	21.89	20.58
25RB (0)	2498.5	22.84	21.76	20.74	
	2687.5	22.76	21.94	21.17	
	2640.3	22.95	22.00	20.85	
	2593	23.13	22.15	20.84	
	2545.8	22.90	21.91	20.49	
10MHz	1RB-High (49)	2498.5	22.84	21.76	20.82
		2685	23.84	22.30	21.81
		2639	23.87	22.30	21.83
		2593	23.93	22.14	21.45
		2547	24.08	22.29	21.32
	1RB-Middle (24)	2501	23.77	22.15	21.65
		2685	24.00	22.50	21.95
		2639	23.78	22.37	21.80
		2593	24.08	22.56	21.67
		2547	23.91	22.28	21.27
	1RB-Low (0)	2501	23.77	22.33	21.66
		2685	23.96	22.35	22.06
		2639	23.92	22.48	21.96
		2593	24.04	22.67	21.58
		2547	23.83	22.57	21.15
	25RB-High (25)	2501	22.78	22.35	21.60
		2685	22.80	21.95	21.10
		2639	22.94	21.96	20.77
		2593	23.09	22.04	20.82
		2547	22.94	22.05	20.52
25RB-Middle (12)	2501	22.81	21.89	20.86	
	2685	22.99	21.85	21.05	
	2639	22.92	22.00	20.82	

		2593	23.06	22.11	20.73	
		2547	23.03	22.05	20.51	
		2501	22.83	21.80	20.85	
		25RB-Low (0)	2685	22.92	21.87	20.99
			2639	22.96	21.94	20.78
	2593		23.18	22.12	20.81	
	50RB (0)	2547	22.86	22.02	20.57	
		2501	22.76	21.70	20.74	
		2685	23.00	21.90	21.31	
		2639	22.95	22.10	21.10	
	15MHz	1RB-High (74)	2593	24.05	22.53	21.55
			2548.3	24.13	22.43	21.27
			2503.5	23.78	22.33	21.63
			2682.5	23.87	22.25	21.72
			2637.8	23.58	22.36	21.86
1RB-Middle (37)		2593	24.13	22.59	21.47	
		2548.3	23.81	22.54	21.18	
		2503.5	23.82	22.40	21.66	
		2682.5	23.91	22.33	21.57	
1RB-Low (0)		2637.8	23.60	22.63	21.84	
		2593	23.97	22.75	21.49	
		2548.3	23.87	22.41	21.27	
		2503.5	23.73	22.36	21.64	
36RB-High (38)		2682.5	22.44	21.80	21.25	
		2637.8	22.89	21.94	20.96	
		2593	22.79	21.88	20.85	
		2548.3	22.98	21.98	20.55	
		2503.5	22.69	21.73	20.97	
36RB-Middle (19)		2682.5	22.89	21.82	21.03	
		2637.8	22.91	21.89	21.01	
		2593	23.05	22.13	21.08	
		2548.3	22.89	22.04	20.63	
		2503.5	22.78	21.79	20.92	
36RB-Low (0)		2682.5	22.99	21.93	21.21	
		2637.8	22.87	22.04	21.05	
	2593	23.09	22.18	20.94		
	2548.3	22.90	21.91	20.63		
	2503.5	22.80	21.84	20.91		
75RB (0)	2682.5	22.92	21.92	21.15		
	2637.8	22.88	22.12	21.23		
	2593	23.06	21.80	20.93		
	2548.3	22.95	22.16	20.82		
	2503.5	22.82	21.94	20.88		

20MHz	1RB-High (99)	2680	23.82	22.05	21.65
		2636.5	23.81	22.51	21.91
		2593	23.84	22.57	21.62
		2549.5	24.03	22.43	21.31
		2506	23.72	22.27	21.24
	1RB-Middle (50)	2680	23.92	22.35	21.66
		2636.5	23.68	22.61	22.01
		2593	24.00	22.51	21.62
		2549.5	23.85	22.55	20.64
		2506	23.74	22.29	21.61
	1RB-Low (0)	2680	24.05	22.59	21.79
		2636.5	23.74	22.45	22.03
		2593	24.10	22.72	21.61
		2549.5	23.86	22.43	21.37
		2506	23.79	22.31	21.69
	50RB-High (50)	2680	22.92	21.87	21.43
		2636.5	22.94	22.04	21.29
		2593	22.84	21.92	21.16
		2549.5	22.93	22.04	20.83
		2506	22.80	21.92	21.18
	50RB-Middle (25)	2680	22.81	21.96	21.31
		2636.5	22.91	21.95	20.90
		2593	23.10	22.20	21.15
		2549.5	23.00	22.07	20.58
		2506	22.78	21.80	21.17
	50RB-Low (0)	2680	22.96	22.09	21.33
		2636.5	22.93	22.06	20.96
		2593	22.99	22.23	20.96
		2549.5	22.90	22.00	20.60
2506		22.81	21.82	20.82	
100RB (0)	2680	22.79	21.95	21.31	
	2636.5	22.97	22.09	21.05	
	2593	23.10	22.19	20.93	
	2549.5	22.92	22.14	20.66	
	2506	22.88	21.90	20.93	

LTE B66

Band 66					
Bandwidth (MHz)	RB allocation	Frequency (MHz)	Actual output power (dBm)		
	RB offset		QPSK	16QAM	64QAM
1.4MHz	1RB-High	1779.3	23.25	22.71	21.44
		1745	23.24	22.74	21.42
		1710.7	23.09	22.72	21.49
	1RB-Middle (3)	1779.3	23.21	22.78	21.50
		1745	23.09	22.79	21.50
		1710.7	23.07	22.56	21.65

	1RB-Low (0)	1779.3	23.27	22.82	21.61
		1745	23.09	22.77	21.49
		1710.7	23.12	22.72	21.67
	3RB-High (3)	1779.3	23.85	22.95	21.77
		1745	23.87	22.92	21.63
		1710.7	23.80	22.80	21.66
	3RB-Middle (1)	1779.3	23.90	22.81	21.69
		1745	23.90	22.93	21.77
		1710.7	23.78	22.99	21.67
	3RB-Low (0)	1779.3	23.86	22.96	21.79
		1745	23.85	22.89	21.45
		1710.7	23.85	22.99	21.59
6RB (0)	1779.3	22.75	21.79	19.35	
	1745	22.75	21.52	20.14	
	1710.7	22.77	21.45	19.72	
3MHz	1RB-High (14)	1778.5	23.34	22.79	21.46
		1745	23.28	22.63	21.50
		1711.5	23.05	22.65	21.41
	1RB-Middle (7)	1778.5	23.31	22.79	21.54
		1745	23.23	22.89	21.20
		1711.5	23.09	22.60	21.37
	1RB-Low (0)	1778.5	23.31	22.79	21.37
		1745	23.27	22.88	21.45
		1711.5	23.15	22.69	21.43
	8RB-High (7)	1778.5	22.84	21.97	19.49
		1745	22.81	21.94	20.12
		1711.5	22.75	21.94	19.79
	8RB-Middle (4)	1778.5	22.93	21.97	19.58
		1745	22.85	21.88	20.15
		1711.5	22.76	21.95	19.81
	8RB-Low (0)	1778.5	22.84	21.96	19.66
		1745	22.80	21.96	20.13
		1711.5	22.68	21.90	19.74
	15RB (0)	1778.5	22.87	21.95	19.53
		1745	22.81	21.93	20.12
		1711.5	22.72	21.86	19.79
5MHz	1RB-High (24)	1777.5	23.28	22.76	21.52
		1745	23.17	22.84	21.44
		1712.5	23.30	22.79	21.35
	1RB-Middle (12)	1777.5	23.21	22.69	21.36
		1745	23.11	22.76	21.46
		1712.5	23.19	22.86	21.35
	1RB-Low (0)	1777.5	23.29	22.75	21.53
		1745	23.18	22.80	21.61
		1712.5	23.18	22.83	21.34
	12RB-High (13)	1777.5	22.82	21.94	19.50
		1745	22.85	21.97	20.04
		1712.5	22.74	21.84	19.80

	12RB-Middle (6)	1777.5	22.81	21.92	19.70
		1745	22.68	21.87	20.19
		1712.5	22.65	21.83	19.90
	12RB-Low (0)	1777.5	22.81	21.93	19.65
		1745	22.85	21.87	20.05
		1712.5	22.77	21.88	19.70
	25RB (0)	1777.5	22.82	21.84	19.54
		1745	22.76	21.76	20.04
		1712.5	22.70	21.94	19.73
10MHz	1RB-High (49)	1775	23.23	22.80	21.55
		1745	23.37	22.93	21.53
		1715	23.11	22.83	21.39
	1RB-Middle (24)	1775	23.23	22.79	21.34
		1745	23.26	22.91	21.43
		1715	23.03	22.75	21.28
	1RB-Low (0)	1775	23.22	22.89	21.39
		1745	23.33	22.97	21.36
		1715	23.13	22.75	21.33
	25RB-High (25)	1775	22.85	21.84	19.92
		1745	22.87	21.94	20.33
		1715	22.80	21.81	20.10
	25RB-Middle (12)	1775	22.83	21.82	19.98
		1745	22.79	22.00	20.18
		1715	22.75	21.99	19.87
	25RB-Low (0)	1775	22.73	21.79	20.07
		1745	22.82	21.97	20.08
		1715	22.80	21.78	19.73
	50RB (0)	1775	22.83	21.85	19.93
		1745	22.82	21.94	20.22
		1715	22.73	21.83	19.93
15MHz	1RB-High (74)	1772.5	23.29	22.83	21.47
		1745	23.27	22.86	21.48
		1717.5	23.19	22.55	21.69
	1RB-Middle (37)	1772.5	23.30	22.95	21.45
		1745	23.27	22.93	21.35
		1717.5	23.21	22.67	21.42
	1RB-Low (0)	1772.5	23.29	22.95	21.65
		1745	23.27	22.93	21.40
		1717.5	23.26	22.65	21.34
	36RB-High (38)	1772.5	22.85	21.88	19.73
		1745	22.94	21.89	20.17
		1717.5	22.75	21.78	20.01
	36RB-Middle (19)	1772.5	22.82	21.84	19.94
		1745	22.72	21.87	20.16
		1717.5	22.78	21.79	19.90
	36RB-Low (0)	1772.5	22.88	21.91	20.07
		1745	22.76	21.75	20.17
		1717.5	22.70	21.81	19.86



	75RB (0)	1772.5	22.84	21.85	19.89
		1745	22.82	21.91	20.15
		1717.5	22.78	21.87	19.91
20MHz	1RB-High (99)	1770	23.25	22.72	21.53
		1745	23.16	22.45	21.39
		1720	23.27	22.69	21.39
	1RB-Middle (50)	1770	23.18	22.61	21.44
		1745	23.11	22.49	21.39
		1720	23.17	22.62	21.40
	1RB-Low (0)	1770	23.15	22.82	21.50
		1745	23.11	22.40	21.22
		1720	23.22	22.62	21.32
	50RB-High (50)	1770	22.85	21.82	20.10
		1745	22.79	21.93	20.43
		1720	22.88	21.92	20.21
	50RB-Middle (25)	1770	22.77	21.86	20.11
		1745	22.72	21.85	20.15
		1720	22.79	21.68	19.93
	50RB-Low (0)	1770	22.78	21.88	20.09
		1745	22.72	21.84	20.08
		1720	22.62	21.77	19.70
	100RB (0)	1770	22.77	21.95	20.08
		1745	22.83	21.87	20.19
		1720	22.87	21.79	19.95

11.4 Wi-Fi and BT Measurement result

When the same transmission mode configurations have the same maximum output power on the same channel for the 802.11 a/n/ac/ax modes, the channel in the lower order/sequence 802.11 mode (i.e. a, n, ac then ax) is selected. Therefore the SAR measurements performed for the 802.11n/ac modes, as the lowest order modulation, cover 802.11ax modes.

When the specified maximum output power is the same for both UNII 1 and UNII 2A, begin SAR measurements in UNII 2A with the channel with the highest measured output power. If the reported SAR for UNII 2A is ≤ 1.2 W/kg, SAR is not required for UNII 1; otherwise treat the remaining bands separately and test them independently for SAR.

According to KDB 248227 D01, simultaneous SAR provisions in KDB 447498 D01 apply to determine simultaneous transmission SAR test exclusion for Wi-Fi MIMO. If the sum of 1-g single transmission chain SAR measurements is < 1.6 W/kg and/or the MIMO output power is equal or less than a single chain, then no additional SAR measurements for simultaneously at the specified maximum output power of MIMO operation.

When antennas are spatially separated to the extent that SAR distributions do not overlap and can be treated independently, SAR compliance for simultaneous transmission is determined separately for each individual antenna.

This device does not support UNII, therefore disregard all references and description to WiFi5G

The average conducted power for Wi-Fi is as following:

FCC 2.4GHz									
802.11b(dBm)									
Channel\data rate	1Mbps	2Mbps	5.5Mbps	11Mbps					
11(2462MHz)	17.71	/	/	/					
6(2437MHz)	18.37	/	/	/					
1(2412MHz)	18.48	18.39	18.47	18.32					
Tune up	19.00	19.00	19.00	19.00					
802.11g(dBm)									
Channel\data rate	6Mbps	9Mbps	12Mbps	18Mbps	24Mbps	36Mbps	48Mbps	54Mbps	
11(2462MHz)	9.75	/	/	/	/	/	/	/	/
Tune up	11.00	/	/	/	/	/	/	/	/
6(2437MHz)	14.52	/	/	/	/	/	/	/	/
Tune up	16.50	/	/	/	/	/	/	/	/
1(2412MHz)	14.62	14.59	14.55	14.51	14.40	14.26	13.00	12.87	
Tune up	15.00	15.00	15.00	15.00	15.00	15.00	15.00	15.00	14.50
802.11n(dBm)-20MHz									
Channel\data rate	MCS0	MCS1	MCS2	MCS3	MCS4	MCS5	MCS6	MCS7	
11(2462MHz)	/	/	9.23	/	/	/	/	/	/
Tune up	/	/	11.00	/	/	/	/	/	/
6(2437MHz)	/	/	14.10	/	/	/	/	/	/
1(2412MHz)	14.92	14.81	15.90	15.78	15.64	15.51	14.51	13.24	
Tune up	16.00	16.00	16.00	17.00	17.00	17.00	16.50	15.00	

The average conducted power for BT is as following:

BR/EDR									
	GFSK			EDR2M-4_DQPSK			EDR3M-8DPSK		
	Ch0	Ch 39	Ch 78	Ch 0	Ch 39	Ch 78	Ch 0	Ch 39	Ch 78
Maximum Transmit Power(<20dBm)	7.07	6.89	7.73	7.08	6.14	6.72	7.10	6.18	6.69

Tune up	8.00	8.00	8.00	8.00	8.00	8.00	8.00	8.00	8.00
---------	------	------	------	------	------	------	------	------	------

12 Antenna Location

12.1 Transmit Antenna Separation Distances

The detail for transmit antenna separation distances is described in the additional document: Appendix to test report No.I21Z70411-SEM01 The photos of SAR test

12.2 SAR Measurement Positions

According to the KDB941225 D06 Hot Spot SAR v01, the edges with less than 2.5 cm distance to the antennas need to be tested for SAR.

SAR measurement positions						
Mode	Front	Rear	Left edge	Right edge	Top edge	Bottom edge
Main ANT	Yes	Yes	Yes	Yes	No	Yes
WiFi ANT	Yes	Yes	No	Yes	Yes	No

12.3 Standalone SAR Test Exclusion Considerations

Standalone 1-g head or body SAR evaluation by measurement or numerical simulation is not required when the corresponding SAR Exclusion Threshold condition, listed below, is satisfied. The 1-g SAR test exclusion threshold for 100 MHz to 6 GHz at test separation distances ≤ 50 mm are determined by:

$[(\text{max. power of channel, including tune-up tolerance, mW}) / (\text{min. test separation distance, mm})] \cdot [\sqrt{f(\text{GHz})}] \leq 3.0$ for 1-g SAR, where

- f(GHz) is the RF channel transmit frequency in GHz
- Power and distance are rounded to the nearest mW and mm before calculation
- The result is rounded to one decimal place for comparison

Standalone SAR test exclusion considerations

Band/Mode	F(GHz)	Position	SAR test exclusion threshold(mW)	RF output power		SAR test exclusion
				dBm	mW	
Bluetooth	2.441	Head	9.60	8	6.31	Yes
		Body	19.20	8	6.31	Yes
2.4GHz WLAN	2.45	Head	9.58	19	79.43	No
		Body	19.17	19	79.43	No

When standalone SAR test exclusion applies to an antenna that transmits simultaneously with other antennas, the standalone SAR must be estimated according to following to determine simultaneous transmission SAR test exclusion:

$(\text{max. power of channel, including tune-up tolerance, mW}) / (\text{min. test separation distance, mm}) \cdot [\sqrt{f(\text{GHz})} / x] \text{ W/kg}$ for test separation distances ≤ 50 mm; where x = 7.5 for 1-g SAR.



When the minimum test separation distance is < 5 mm, a distance of 5 mm is applied to determine SAR test exclusion

Estimated SAR for Bluetooth

Mode/Band	F (GHz)	Position	Distance (mm)	Upper limit of power*		Estimated _{1g} (W/kg)
				dBm	mW	
Bluetooth	2.441	Head	5	8	6.31	0.26
Bluetooth	2.441	Body	10	8	6.31	0.13

* - Maximum possible output power declared by manufacturer



13 SAR Test Result

Note:

KDB 447498 D01 General RF Exposure Guidance:

For WWAN: Reported SAR(W/kg)= Measured SAR(W/kg)*Tune-up Scaling Factor

For BT/WLAN: Reported SAR(W/kg)= Measured SAR(W/kg)* Duty Cycle scaling factor * Tune-up scaling factor

Testing of other required channels within the operating mode of a frequency band is not required when the reported 1-g or 10-g SAR for the mid-band or highest output power channel is:

≤ 0.8 W/kg or 2.0 W/kg, for 1-g or 10-g respectively, when the transmission band is ≤ 100 MHz
 ≤ 0.6 W/kg or 1.5 W/kg, for 1-g or 10-g respectively, when the transmission band is between 100 MHz and 200 MHz

≤ 0.4 W/kg or 1.0 W/kg, for 1-g or 10-g respectively, when the transmission band is ≥ 200 MHz

KDB 648474 D04 Handset SAR:

With headset attached, when the reported SAR for body-worn accessory, measured without a headset connected to the handset, is > 1.2 W/kg, the highest reported SAR configuration for that wireless mode and frequency band should be repeated for that body-worn accessory with a headset attached to the handset.

KDB 941225 D01 SAR test for 3G devices:

When the maximum output power and tune-up tolerance specified for production units in a secondary mode is $\leq \frac{1}{4}$ dB higher than the primary mode or when the highest reported SAR of the primary mode is scaled by the ratio of specified maximum output power and tune-up tolerance of secondary to primary mode and the adjusted SAR is ≤ 1.2 W/kg, SAR measurement is not required for the secondary mode.

KDB 941225 D05 SAR for LTE Devices:

SAR test reduction is applied using the following criteria:

Start with the largest channel bandwidth and measure SAR for QPSK with 1 RB, and 50% RB allocation, using the RB offset and required test channel combination with the highest maximum output power among RB offsets at the upper edge, middle and lower edge of each required test channel.

When the reported SAR is > 0.8 W/kg, testing for other Channels is performed at the highest output power level for 1RB, and 50% RB configuration for that channel.

Testing for 100% RB configuration is performed at the highest output power level for 100% RB configuration across the Low, Mid and High Channel when the highest reported SAR for 1 RB and 50% RB are > 0.8 W/kg. Testing for the remaining required channels is not needed because the reported SAR for 100% RB Allocation < 1.45 W/kg.

Testing for 16-QAM modulation is not required because the reported SAR for QPSK is < 1.45 W/Kg and its output power is not more than 0.5 dB higher than that of QPSK.

Testing for the other channel bandwidths is not required because the reported SAR for the highest channel bandwidth is < 1.45 W/Kg and its output power is not more than 0.5 dB higher than that of the highest channel bandwidth.

For LTE bands that do not support at least three non-overlapping channels in certain channel bandwidths, test the available non-overlapping channels instead. When a device supports overlapping channel assignment in a channel bandwidth configuration, the middle channel of the

group of overlapping channels should be selected for testing; therefore, the requirement for H, M and L channels may not fully apply.

KDB 248227 D01 SAR meas for 802.11:

SAR test reduction for 802.11 Wi-Fi transmission mode configurations are considered separately for DSSS and OFDM. An initial test position is determined to reduce the number of tests required for certain exposure configurations with multiple test positions. An initial test configuration is determined for each frequency band and aggregated band according to maximum output power, channel bandwidth, wireless mode configurations and other operating parameters to streamline the measurement requirements. For 2.4 GHz DSSS, either the initial test position or DSSS procedure is applied to reduce the number of SAR tests; these are mutually exclusive. For OFDM, an initial test position is only applicable to next to the ear, UMPC mini-tablet and hotspot mode configurations, which is tested using the initial test configuration to facilitate test reduction. For other exposure conditions with a fixed test position, SAR test reduction is determined using only the initial test configuration.

To determine the initial test position, Area Scans were performed to determine the position with the Maximum Value of SAR (measured). The position that produced the highest Maximum Value of SAR is considered the worst case position; thus used as the initial test position.

The multiple test positions require SAR measurements in head, hotspot mode or UMPC mini-tablet configurations may be reduced according to the highest reported SAR determined using the initial test position(s) by applying the DSSS or OFDM SAR measurement procedures in the required wireless mode test configuration(s). The initial test position(s) is measured using the highest measured maximum output power channel in the required wireless mode test configuration(s).

When the reported SAR for the initial test position is:

≤ 0.4 W/kg, further SAR measurement is not required for the other test positions in that exposure configuration and wireless mode combination within the frequency band or aggregated band. DSSS and OFDM configurations are considered separately according to the required SAR procedures.
> 0.4 W/kg, SAR is repeated using the same wireless mode test configuration tested in the initial test position to measure the subsequent next closet/smallest test separation distance and maximum coupling test position, on the highest maximum output power channel, until the reported SAR is ≤ 0.8 W/kg or all required test positions are tested.

- For subsequent test positions with equivalent test separation distance or when exposure is dominated by coupling conditions, the position for maximum coupling condition should be tested.
- When it is unclear, all equivalent conditions must be tested.

For all positions/configurations tested using the initial test position and subsequent test positions, when the reported SAR is > 0.8 W/kg, measure the SAR for these positions/configurations on the subsequent next highest measured output power channel(s) until the reported SAR is ≤ 1.2 W/kg or all required test channels are considered.

- The additional power measurements required for this step should be limited to those necessary for identifying subsequent highest output power channels to apply the test reduction.

When the specified maximum output power is the same for both UNII 1 and UNII 2A, begin SAR measurements in UNII 2A with the channel with the highest measured output power. If the reported SAR for UNII 2A is ≤ 1.2 W/kg, SAR is not required for UNII 1; otherwise treat the remaining bands separately and test them independently for SAR.

When the specified maximum output power is different between UNII 1 and UNII 2A, begin SAR



No.I21Z70411-SEM01

with the band that has the higher specified maximum output. If the highest reported SAR for the band with the highest specified power is ≤ 1.2 W/kg, testing for the band with the lower specified output power is not required; otherwise test the remaining bands independently for SAR.

Duty Cycle

Table with 2 columns: Mode, Duty Cycle. Rows include Speech for GSM (1:8.3), GPRS&EGPRS 1 Slot (1:8.3), GPRS&EGPRS 2 Slot (1:4), GPRS&EGPRS 3 Slot (1:2.67), GPRS&EGPRS 4 Slot (1:2), WCDMA<E FDD (1:1), LTE TDD (1:1.58).

Ambient Temperature: 21.5-23.5 °C Liquid Temperature: 21.5-23.5 °C

Note

S2: SIM2

S3: Single SIM card slot.

H1: The headset of GH59-15054A (White). WW. by Youngbo/Cresyn

H2: The headset of GH59-15071A (White). India. by Youngbo/Cresyn

13.1 SAR results for Cellular

Head

Table with 15 columns: RF Exposure Conditions, Frequency Band, Channel Number, Frequency (MHz), Mode/RB, Test Position, Distance, Figure No./Note, EUT Measured Power (dBm), Tune up (dBm), Measured SAR 1g (W/kg), Reported SAR 1g (W/kg), Measured SAR 10g (W/kg), Reported SAR 10g (W/kg), Power Drift. Rows list various test configurations for GSM and WCDMA bands.



Head	LTE Band2	18900	1880	1RB-Low	Cheek Left	0mm	A.6	23.36	24	0.128	0.15	0.083	0.10	0.01
Head	LTE Band2	18900	1880	1RB-Low	Tilt Left	0mm	\	23.36	24	0.092	0.11	0.056	0.06	-0.01
Head	LTE Band2	18900	1880	1RB-Low	Cheek Right	0mm	\	23.36	24	0.112	0.13	0.07	0.08	-0.13
Head	LTE Band2	18900	1880	1RB-Low	Tilt Right	0mm	\	23.36	24	0.082	0.10	0.05	0.06	-0.10
Head	LTE Band2	18900	1880	50RB-Low	Cheek Left	0mm	\	22.94	23	0.118	0.12	0.076	0.08	-0.02
Head	LTE Band2	18900	1880	50RB-Low	Tilt Left	0mm	\	22.94	23	0.086	0.09	0.051	0.05	0.06
Head	LTE Band2	18900	1880	50RB-Low	Cheek Right	0mm	\	22.94	23	0.099	0.10	0.062	0.06	0.06
Head	LTE Band2	18900	1880	50RB-Low	Tilt Right	0mm	\	22.94	23	0.073	0.07	0.044	0.04	-0.09
Head	LTE Band2	18900	1880	1RB-Low	Cheek Left	0mm	S2	23.36	24	0.117	0.14	0.075	0.09	-0.13
Head	LTE Band5	20600	844	1RB-Middle	Cheek Left	0mm	A.7	22.89	24	0.126	0.16	0.109	0.14	-0.02
Head	LTE Band5	20600	844	1RB-Middle	Tilt Left	0mm	\	22.89	24	0.062	0.08	0.055	0.07	-0.10
Head	LTE Band5	20600	844	1RB-Middle	Cheek Right	0mm	\	22.89	24	0.094	0.12	0.082	0.11	-0.14
Head	LTE Band5	20600	844	1RB-Middle	Tilt Right	0mm	\	22.89	24	0.06	0.08	0.053	0.07	0.12
Head	LTE Band5	20600	844	25RB-Low	Cheek Left	0mm	\	22.43	23	0.111	0.13	0.095	0.11	0.06
Head	LTE Band5	20600	844	25RB-Low	Tilt Left	0mm	\	22.43	23	0.052	0.06	0.046	0.05	-0.04
Head	LTE Band5	20600	844	25RB-Low	Cheek Right	0mm	\	22.43	23	0.08	0.09	0.07	0.08	0.14
Head	LTE Band5	20600	844	25RB-Low	Tilt Right	0mm	\	22.43	23	0.052	0.06	0.046	0.05	-0.01
Head	LTE Band5	20600	844	1RB-Middle	Cheek Left	0mm	S2	22.89	24	0.118	0.15	0.104	0.13	0.02
Head	LTE Band7	20850	2510	1RB-High	Cheek Left	0mm	A.8	23.86	24	0.319	0.33	0.173	0.18	-0.11
Head	LTE Band7	20850	2510	1RB-High	Tilt Left	0mm	\	23.86	24	0.183	0.19	0.097	0.10	0.14
Head	LTE Band7	20850	2510	1RB-High	Cheek Right	0mm	\	23.86	24	0.145	0.15	0.085	0.09	-0.14
Head	LTE Band7	20850	2510	1RB-High	Tilt Right	0mm	\	23.86	24	0.124	0.13	0.066	0.07	-0.04
Head	LTE Band7	20850	2510	50RB-High	Cheek Left	0mm	\	22.76	23	0.26	0.27	0.141	0.15	0.03
Head	LTE Band7	20850	2510	50RB-High	Tilt Left	0mm	\	22.76	23	0.136	0.14	0.073	0.08	-0.14
Head	LTE Band7	20850	2510	50RB-High	Cheek Right	0mm	\	22.76	23	0.118	0.12	0.069	0.07	-0.08
Head	LTE Band7	20850	2510	50RB-High	Tilt Right	0mm	\	22.76	23	0.103	0.11	0.055	0.06	-0.19
Head	LTE Band7	20850	2510	1RB-High	Cheek Left	0mm	S2	23.86	24	0.305	0.31	0.161	0.17	0.06
Head	LTE Band12	23130	711	1RB-Middle	Cheek Left	0mm	A.9	22.93	24	0.068	0.09	0.053	0.07	0.08
Head	LTE Band12	23130	711	1RB-Middle	Tilt Left	0mm	\	22.93	24	<0.01	<0.01	<0.01	<0.01	\
Head	LTE Band12	23130	711	1RB-Middle	Cheek Right	0mm	\	22.93	24	0.056	0.07	0.045	0.06	0.11
Head	LTE Band12	23130	711	1RB-Middle	Tilt Right	0mm	\	22.93	24	0.033	0.04	0.027	0.03	0.05
Head	LTE Band12	23130	711	25RB-Low	Cheek Left	0mm	\	22.60	23	0.059	0.06	0.047	0.05	0.11
Head	LTE Band12	23130	711	25RB-Low	Tilt Left	0mm	\	22.60	23	<0.01	<0.01	<0.01	<0.01	\
Head	LTE Band12	23130	711	25RB-Low	Cheek Right	0mm	\	22.60	23	0.049	0.05	0.038	0.04	0.00
Head	LTE Band12	23130	711	25RB-Low	Tilt Right	0mm	\	22.60	23	<0.01	<0.01	<0.01	<0.01	\
Head	LTE Band12	23130	711	1RB-Middle	Cheek Left	0mm	S2	22.93	24	0.061	0.08	0.046	0.06	-0.17
Head	LTE Band41	40620	2593	1RB-Middle	Cheek Left	0mm	A.10	24.10	24.5	0.113	0.12	0.055	0.06	0.09
Head	LTE Band41	40620	2593	1RB-Middle	Tilt Left	0mm	\	24.10	24.5	0.095	0.10	0.046	0.05	0.18
Head	LTE Band41	40620	2593	1RB-Middle	Cheek Right	0mm	\	24.10	24.5	0.051	0.06	0.026	0.03	0.19
Head	LTE Band41	40620	2593	1RB-Middle	Tilt Right	0mm	\	24.10	24.5	0.039	0.04	0.022	0.02	0.17
Head	LTE Band41	40620	2593	50RB-Middle	Cheek Left	0mm	\	23.10	23.5	0.088	0.10	0.049	0.05	0.15
Head	LTE Band41	40620	2593	50RB-Middle	Tilt Left	0mm	\	23.10	23.5	0.079	0.09	0.035	0.04	-0.10
Head	LTE Band41	40620	2593	50RB-Middle	Cheek Right	0mm	\	23.10	23.5	0.039	0.04	0.028	0.03	0.06
Head	LTE Band41	40620	2593	50RB-Middle	Tilt Right	0mm	\	23.10	23.5	0.034	0.04	0.024	0.03	0.10
Head	LTE Band41	40620	2593	1RB-Middle	Cheek Left	0mm	S2	24.10	24.5	0.101	0.11	0.042	0.05	0.04
Head	LTE Band66	132072	1720	1RB-High	Cheek Left	0mm	\	23.27	24	0.153	0.18	0.073	0.09	0.18
Head	LTE Band66	132072	1720	1RB-High	Tilt Left	0mm	\	23.27	24	0.172	0.20	0.076	0.09	-0.01
Head	LTE Band66	132072	1720	1RB-High	Cheek Right	0mm	A.11	23.27	24	0.212	0.25	0.105	0.12	0.09
Head	LTE Band66	132072	1720	1RB-High	Tilt Right	0mm	\	23.27	24	0.191	0.23	0.092	0.11	-0.11
Head	LTE Band66	132072	1720	50RB-High	Cheek Left	0mm	\	22.88	23	0.151	0.16	0.073	0.08	-0.19
Head	LTE Band66	132072	1720	50RB-High	Tilt Left	0mm	\	22.88	23	0.133	0.14	0.06	0.06	0.02
Head	LTE Band66	132072	1720	50RB-High	Cheek Right	0mm	\	22.88	23	0.19	0.20	0.094	0.10	-0.14
Head	LTE Band66	132072	1720	50RB-High	Tilt Right	0mm	\	22.88	23	0.153	0.16	0.078	0.08	0.05
Head	LTE Band66	132072	1720	1RB-High	Cheek Right	0mm	S2	23.27	24	0.188	0.22	0.095	0.11	0.02

Body

RF Exposure Conditions	Frequency Band	Channel Number	Frequency (MHz)	Mode/RB	Test Position	Distance	Figure No./Note	EUT Measured Power (dBm)	Tune up (dBm)	Measured SAR 1g (W/kg)	Reported SAR 1g (W/kg)	Measured SAR 10g (W/kg)	Reported SAR 10g (W/kg)	Power Drift
Body	GSM850	190	836.6	GPRS(2TX)	Front	10mm	\	30.96	31.5	0.141	0.16	0.088	0.10	0.01
Body	GSM850	251	848.8	GPRS(2TX)	Rear	10mm	A.12	30.90	31.5	0.32	0.37	0.199	0.23	0.05
Body	GSM850	190	836.6	GPRS(2TX)	Rear	10mm	\	30.96	31.5	0.279	0.32	0.169	0.19	0.15
Body	GSM850	128	824.2	GPRS(2TX)	Rear	10mm	\	30.99	31.5	0.219	0.25	0.133	0.15	-0.10
Body	GSM850	190	836.6	GPRS(2TX)	Left	10mm	\	30.96	31.5	0.103	0.12	0.068	0.08	0.00
Body	GSM850	190	836.6	GPRS(2TX)	Right	10mm	\	30.96	31.5	0.122	0.14	0.081	0.09	-0.04
Body	GSM850	190	836.6	GPRS(2TX)	Bottom	10mm	\	30.96	31.5	0.126	0.14	0.073	0.08	0.08
Body	GSM850	251	848.8	EGPRS(2TX)	Rear	10mm	\	30.96	31.5	0.298	0.34	0.166	0.19	0.08
Body	GSM850	251	848.8	GPRS(2TX)	Rear	10mm	S2	30.90	31.5	0.313	0.36	0.192	0.22	0.11
Body	GSM1900	661	1880	GPRS(3TX)	Front	10mm	\	26.32	27	0.195	0.23	0.118	0.14	0.07
Body	GSM1900	661	1880	GPRS(3TX)	Rear	10mm	\	26.32	27	0.426	0.50	0.253	0.30	-0.04
Body	GSM1900	661	1880	GPRS(3TX)	Left	10mm	\	26.32	27	0.115	0.13	0.069	0.08	-0.03
Body	GSM1900	661	1880	GPRS(3TX)	Right	10mm	\	26.32	27	0.043	0.05	0.026	0.03	-0.18
Body	GSM1900	810	1909.8	GPRS(3TX)	Bottom	10mm	A.13	25.92	27	0.561	0.72	0.308	0.40	-0.18
Body	GSM1900	661	1880	GPRS(3TX)	Bottom	10mm	\	26.32	27	0.467	0.55	0.259	0.30	0.09
Body	GSM1900	512	1850.2	GPRS(3TX)	Bottom	10mm	\	26.76	27	0.531	0.56	0.298	0.31	-0.08
Body	GSM1900	810	1909.8	EGPRS(3TX)	Bottom	10mm	\	25.87	27	0.526	0.68	0.295	0.38	0.08
Body	GSM1900	810	1909.8	GPRS(3TX)	Bottom	10mm	S2	25.92	27	0.524	0.67	0.292	0.37	0.02



Body	WCDMA1900	9400	1880	RMC	Front	10mm	\	23.41	24	0.348	0.40	0.216	0.25	-0.04
Body	WCDMA1900	9538	1907.6	RMC	Rear	10mm	\	23.44	24	0.966	1.10	0.568	0.65	0.07
Body	WCDMA1900	9400	1880	RMC	Rear	10mm	\	23.41	24	0.872	1.00	0.509	0.58	0.12
Body	WCDMA1900	9262	1852.4	RMC	Rear	10mm	\	23.43	24	0.818	0.93	0.476	0.54	0.08
Body	WCDMA1900	9400	1880	RMC	Left	10mm	\	23.41	24	0.223	0.26	0.134	0.15	-0.10
Body	WCDMA1900	9400	1880	RMC	Right	10mm	\	23.41	24	0.089	0.10	0.056	0.06	0.16
Body	WCDMA1900	9538	1907.6	RMC	Bottom	10mm	A.14	23.44	24	1.1	1.25	0.613	0.70	0.14
Body	WCDMA1900	9400	1880	RMC	Bottom	10mm	\	23.41	24	1.03	1.18	0.582	0.67	-0.05
Body	WCDMA1900	9262	1852.4	RMC	Bottom	10mm	\	23.43	24	0.936	1.07	0.524	0.60	0.01
Body	WCDMA1900	9538	1907.6	RMC	Bottom	10mm	S2	23.44	24	1.01	1.15	0.594	0.68	0.06
Body	WCDMA1900	9538	1907.6	RMC	Bottom	10mm	S3	23.44	24	1.01	1.15	0.594	0.68	0.06
Body	WCDMA1900	9538	1907.6	RMC	Bottom	22.5mm ^[1]	H1	23.44	24	0.242	0.28	0.148	0.17	0.07
Body	WCDMA1900	9538	1907.6	RMC	Bottom	22.5mm ^[1]	H2	23.44	24	0.236	0.27	0.141	0.16	0.11
Body	WCDMA1700	1413	1732.6	RMC	Front	10mm	\	23.55	24	0.355	0.39	0.232	0.26	-0.04
Body	WCDMA1700	1513	1752.6	RMC	Rear	10mm	\	23.60	24	0.867	0.95	0.524	0.57	-0.15
Body	WCDMA1700	1413	1732.6	RMC	Rear	10mm	A.15	23.55	24	0.945	1.05	0.571	0.63	0.18
Body	WCDMA1700	1312	1712.4	RMC	Rear	10mm	\	23.50	24	0.911	1.02	0.553	0.62	0.18
Body	WCDMA1700	1413	1732.6	RMC	Left	10mm	\	23.55	24	0.196	0.22	0.129	0.14	0.10
Body	WCDMA1700	1413	1732.6	RMC	Right	10mm	\	23.55	24	0.077	0.09	0.051	0.06	-0.07
Body	WCDMA1700	1513	1752.6	RMC	Bottom	10mm	\	23.60	24	0.713	0.78	0.384	0.42	0.03
Body	WCDMA1700	1413	1732.6	RMC	Bottom	10mm	\	23.55	24	0.792	0.88	0.440	0.49	-0.15
Body	WCDMA1700	1312	1712.4	RMC	Bottom	10mm	\	23.50	24	0.844	0.95	0.492	0.55	0.00
Body	WCDMA1700	1413	1732.6	RMC	Rear	10mm	S2	23.55	24	0.909	1.01	0.556	0.62	0.11
Body	WCDMA 850	4183	836.6	RMC	Front	10mm	\	23.31	24	0.125	0.15	0.092	0.11	-0.13
Body	WCDMA 850	4233	846.6	RMC	Rear	10mm	A.16	23.37	24	0.267	0.31	0.165	0.19	-0.05
Body	WCDMA 850	4183	836.6	RMC	Rear	10mm	\	23.31	24	0.219	0.26	0.139	0.16	0.15
Body	WCDMA 850	4132	826.4	RMC	Rear	10mm	\	23.29	24	0.178	0.21	0.13	0.15	0.09
Body	WCDMA 850	4183	836.6	RMC	Left	10mm	\	23.31	24	0.063	0.07	0.043	0.05	0.06
Body	WCDMA 850	4183	836.6	RMC	Right	10mm	\	23.31	24	0.119	0.14	0.082	0.10	0.04
Body	WCDMA 850	4183	836.6	RMC	Bottom	10mm	\	23.31	24	0.159	0.19	0.087	0.10	-0.03
Body	WCDMA 850	4233	846.6	RMC	Rear	10mm	S2	23.37	24	0.252	0.29	0.148	0.17	0.01
Body	LTE Band2	18900	1880	1RB-Low	Front	10mm	\	23.36	24	0.267	0.31	0.165	0.19	-0.18
Body	LTE Band2	19100	1900	1RB-Low	Rear	10mm	A.17	23.29	24	0.875	1.03	0.506	0.60	0.11
Body	LTE Band2	18900	1880	1RB-Low	Rear	10mm	\	23.36	24	0.722	0.84	0.42	0.49	-0.12
Body	LTE Band2	18700	1860	1RB-Low	Rear	10mm	\	23.29	24	0.73	0.86	0.426	0.50	-0.18
Body	LTE Band2	18900	1880	1RB-Low	Left	10mm	\	23.36	24	0.199	0.23	0.117	0.14	-0.19
Body	LTE Band2	18900	1880	1RB-Low	Right	10mm	\	23.36	24	0.079	0.09	0.049	0.06	0.05
Body	LTE Band2	19100	1900	1RB-Low	Bottom	10mm	\	23.29	24	0.87	1.02	0.482	0.57	0.02
Body	LTE Band2	18900	1880	1RB-Low	Bottom	10mm	\	23.36	24	0.846	0.98	0.432	0.50	-0.10
Body	LTE Band2	18700	1860	1RB-Low	Bottom	10mm	\	23.29	24	0.847	1.00	0.436	0.51	-0.01
Body	LTE Band2	18900	1880	50RB-Low	Front	10mm	\	22.94	23	0.24	0.24	0.148	0.15	0.07
Body	LTE Band2	18900	1880	50RB-Low	Rear	10mm	\	22.94	23	0.678	0.69	0.392	0.40	-0.12
Body	LTE Band2	18900	1880	50RB-Low	Left	10mm	\	22.94	23	0.185	0.19	0.108	0.11	-0.10
Body	LTE Band2	18900	1880	50RB-Low	Right	10mm	\	22.94	23	0.073	0.07	0.044	0.04	-0.15
Body	LTE Band2	18900	1880	50RB-Low	Bottom	10mm	\	22.94	23	0.767	0.78	0.391	0.40	0.10
Body	LTE Band2	18900	1880	100RB	Rear	10mm	\	22.78	23	0.658	0.69	0.384	0.40	-0.04
Body	LTE Band2	18900	1880	100RB	Bottom	10mm	\	22.78	23	0.751	0.79	0.388	0.41	0.00
Body	LTE Band2	19100	1900	1RB-Low	Rear	10mm	S2	23.29	24	0.854	1.01	0.478	0.56	0.03
Body	LTE Band5	20600	844	1RB-Middle	Front	10mm	\	22.89	24	0.126	0.16	0.09	0.12	-0.07
Body	LTE Band5	20600	844	1RB-Middle	Rear	10mm	A.18	22.89	24	0.219	0.28	0.134	0.17	0.05
Body	LTE Band5	20600	844	1RB-Middle	Left	10mm	\	22.89	24	0.091	0.12	0.061	0.08	-0.12
Body	LTE Band5	20600	844	1RB-Middle	Right	10mm	\	22.89	24	0.115	0.15	0.077	0.10	-0.06
Body	LTE Band5	20600	844	1RB-Middle	Bottom	10mm	\	22.89	24	0.152	0.20	0.081	0.10	0.05
Body	LTE Band5	20600	844	25RB-Low	Front	10mm	\	22.43	23	0.112	0.13	0.08	0.09	-0.13
Body	LTE Band5	20600	844	25RB-Low	Rear	10mm	\	22.43	23	0.183	0.21	0.111	0.13	0.14
Body	LTE Band5	20600	844	25RB-Low	Left	10mm	\	22.43	23	0.082	0.09	0.054	0.06	0.13
Body	LTE Band5	20600	844	25RB-Low	Right	10mm	\	22.43	23	0.099	0.11	0.066	0.08	0.15
Body	LTE Band5	20600	844	25RB-Low	Bottom	10mm	\	22.43	23	0.129	0.15	0.069	0.08	0.08
Body	LTE Band5	20600	844	1RB-Middle	Rear	10mm	S2	22.89	24	0.212	0.27	0.127	0.16	0.14
Body	LTE Band7	20850	2510	1RB-High	Front	10mm	\	23.86	24	0.359	0.37	0.206	0.21	0.03
Body	LTE Band7	20850	2510	1RB-High	Rear	10mm	\	23.86	24	0.702	0.72	0.33	0.34	0.04
Body	LTE Band7	20850	2510	1RB-High	Left	10mm	\	23.86	24	0.279	0.29	0.154	0.16	-0.06
Body	LTE Band7	20850	2510	1RB-High	Right	10mm	\	23.86	24	0.161	0.17	0.093	0.10	0.15
Body	LTE Band7	21350	2560	1RB-High	Bottom	10mm	\	23.45	24	0.671	0.76	0.321	0.36	0.17
Body	LTE Band7	21100	2535	1RB-High	Bottom	10mm	\	23.62	24	0.775	0.85	0.371	0.40	-0.12
Body	LTE Band7	20850	2510	1RB-High	Bottom	10mm	A.19	23.86	24	0.879	0.91	0.422	0.44	-0.07
Body	LTE Band7	20850	2510	50RB-High	Front	10mm	\	22.76	23	0.287	0.30	0.165	0.17	0.00
Body	LTE Band7	20850	2510	50RB-High	Rear	10mm	\	22.76	23	0.573	0.61	0.269	0.28	-0.02
Body	LTE Band7	20850	2510	50RB-High	Left	10mm	\	22.76	23	0.221	0.23	0.124	0.13	-0.12
Body	LTE Band7	20850	2510	50RB-High	Right	10mm	\	22.76	23	0.135	0.14	0.078	0.08	0.17
Body	LTE Band7	20850	2510	50RB-High	Bottom	10mm	\	22.76	23	0.616	0.65	0.295	0.31	0.03
Body	LTE Band7	20850	2510	100RB	Bottom	10mm	\	22.68	23	0.637	0.69	0.305	0.33	0.13
Body	LTE Band7	20850	2510	1RB-High	Bottom	10mm	S2	23.86	24	0.862	0.89	0.405	0.42	0.05
Body	LTE Band12	23130	711	1RB-Middle	Front	10mm	\	22.93	24	0.075	0.10	0.059	0.08	-0.14
Body	LTE Band12	23130	711	1RB-Middle	Rear	10mm	A.20	22.93	24	0.143	0.18	0.111	0.14	-0.14
Body	LTE Band12	23130	711	1RB-Middle	Left	10mm	\	22.93	24	0.062	0.08	0.044	0.06	0.15
Body	LTE Band12	23130	711	1RB-Middle	Right	10mm	\	22.93	24	0.084	0.11	0.063	0.08	-0.18
Body	LTE Band12	23130	711	1RB-Middle	Bottom	10mm	\	22.93	24	0.052	0.07	0.028	0.04	0.08
Body	LTE Band12	23130	711	25RB-Low	Front	10mm	\	22.60	23	0.063	0.07	0.05	0.05	0.10
Body	LTE Band12	23130	711	25RB-Low	Rear	10mm	\	22.60	23	0.125	0.14	0.097	0.11	-0.03
Body	LTE Band12	23130	711	25RB-Low	Left	10mm	\	22.60	23	0.051	0.06	0.038	0.04	0.11
Body	LTE Band12	23130	711	25RB-Low	Right	10mm	\	22.60	23	0.071	0.08	0.052	0.06	0.14
Body	LTE Band12	23130	711	25RB-Low	Bottom	10mm	\	22.60	23	0.043	0.05	0.023	0.03	-0.14
Body	LTE Band12	23130	711	1RB-Middle	Rear	10mm	S2	22.93	24	0.129	0.17	0.101	0.13	0.13

Body	LTE Band41	40620	2593	1RB-Middle	Front	10mm	\	24.10	24.5	0.135	0.15	0.075	0.08	0.04
Body	LTE Band41	40620	2593	1RB-Middle	Rear	10mm	A.21	24.10	24.5	0.225	0.25	0.100	0.11	0.12
Body	LTE Band41	40620	2593	1RB-Middle	Left	10mm	\	24.10	24.5	0.104	0.11	0.057	0.06	0.03
Body	LTE Band41	40620	2593	1RB-Middle	Right	10mm	\	24.10	24.5	0.042	0.05	0.024	0.03	-0.19
Body	LTE Band41	40620	2593	1RB-Middle	Bottom	10mm	\	24.10	24.5	0.223	0.24	0.105	0.12	0.12
Body	LTE Band41	40620	2593	50RB-Middle	Front	10mm	\	23.10	23.5	0.131	0.14	0.072	0.08	-0.10
Body	LTE Band41	40620	2593	50RB-Middle	Rear	10mm	\	23.10	23.5	0.223	0.24	0.097	0.11	0.09
Body	LTE Band41	40620	2593	50RB-Middle	Left	10mm	\	23.10	23.5	0.103	0.11	0.056	0.06	0.11
Body	LTE Band41	40620	2593	50RB-Middle	Right	10mm	\	23.10	23.5	0.042	0.05	0.024	0.03	0.00
Body	LTE Band41	40620	2593	50RB-Middle	Bottom	10mm	\	23.10	23.5	0.19	0.21	0.088	0.10	-0.09
Body	LTE Band41	40620	2593	1RB-Middle	Rear	10mm	S2	24.10	24.5	0.209	0.23	0.082	0.09	0.11
Body	LTE Band66	132072	1720	1RB-High	Front	10mm	\	23.27	24	0.244	0.29	0.159	0.19	0.09
Body	LTE Band66	132572	1770	1RB-High	Rear	10mm	\	23.25	24	0.525	0.62	0.304	0.36	0.04
Body	LTE Band66	132322	1745	1RB-High	Rear	10mm	\	23.16	24	0.764	0.93	0.438	0.53	0.11
Body	LTE Band66	132072	1720	1RB-High	Rear	10mm	A.22	23.27	24	0.796	0.94	0.483	0.57	0.19
Body	LTE Band66	132072	1720	1RB-High	Left	10mm	\	23.27	24	0.143	0.17	0.093	0.11	-0.15
Body	LTE Band66	132072	1720	1RB-High	Right	10mm	\	23.27	24	0.057	0.07	0.036	0.04	0.15
Body	LTE Band66	132072	1720	1RB-High	Bottom	10mm	\	23.27	24	0.599	0.71	0.345	0.41	0.02
Body	LTE Band66	132072	1720	50RB-High	Front	10mm	\	22.88	23	0.224	0.23	0.146	0.15	-0.10
Body	LTE Band66	132072	1720	50RB-High	Rear	10mm	\	22.88	23	0.735	0.76	0.445	0.46	0.07
Body	LTE Band66	132072	1720	50RB-High	Left	10mm	\	22.88	23	0.126	0.13	0.082	0.08	-0.19
Body	LTE Band66	132072	1720	50RB-High	Right	10mm	\	22.88	23	0.052	0.05	0.035	0.04	0.12
Body	LTE Band66	132072	1720	50RB-High	Bottom	10mm	\	22.88	23	0.517	0.53	0.297	0.31	-0.14
Body	LTE Band66	132072	1720	100RB	Rear	10mm	\	22.87	23	0.552	0.57	0.327	0.34	0.06
Body	LTE Band66	132072	1720	1RB-High	Rear	10mm	S2	23.27	24	0.773	0.91	0.463	0.55	0.03

Note1: As the headset port is located at the bottom side and the device cannot be positioned at the distance of 5mm for bottom side with headset by design, so the bottom side with headset is positioned directly against the flat phantom, the distance of 22.5mm for bottom side.

13.2 SAR results for WLAN

The maximum output power specified for production units are determined for all applicable 802.11 transmission modes in each standalone and aggregated frequency band. Maximum output power is measured for the highest maximum output power configuration(s) in each frequency band according to the default power measurement procedures.

When the same transmission mode configurations have the same maximum output power on the same channel for the 802.11 a/g/n/ac/ax modes, the channel in the lower order/sequence 802.11 mode (i.e. a, g, n ac then ax) is selected.

SAR Test reduction was applied from KDB 248227 guidance, when the same maximum power is specified for multiple transmission modes in a frequency band, the largest channel bandwidth, lowest order modulation, lowest data rate and lowest order 802.11a/g/n/ac mode is used for SAR measurement, on the highest measured output power channel in the initial test configuration, for each frequency band. Additional output power measurements were not deemed necessary.

This device does not support UNII, therefore disregard all references and description to WiFi5G

Duty factor plot

CH1

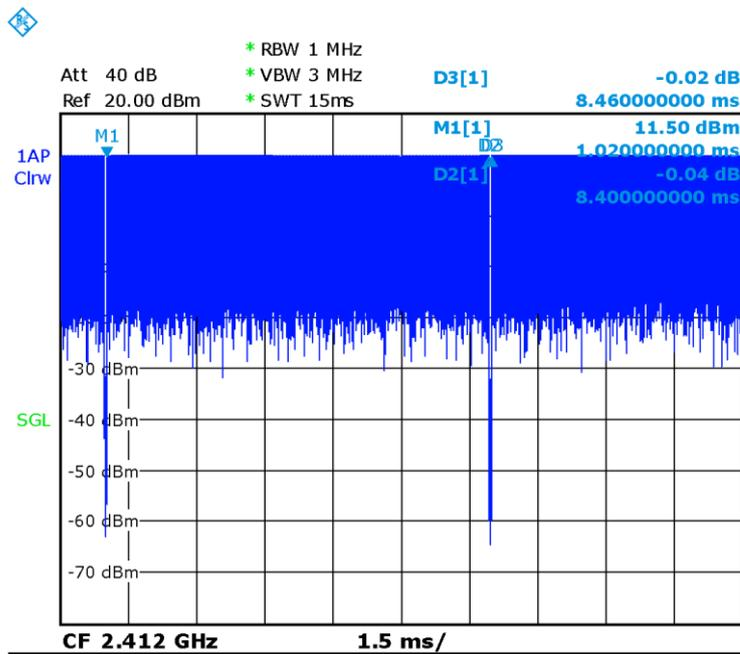

WLAN 2.4G SISO

Test Position	Frequency Band	Channel Number	Frequency (MHz)	Mode/RB	Test Position	Distance	Figure No./Note	EUT Measured Power (dBm)	Tune up (dBm)	Duty Cycle	Measured SAR 1g (W/kg)	Reported SAR 1g (W/kg)	Measured SAR 10g (W/kg)	Reported SAR 10g (W/kg)	Power Drift
Head	WLAN 2.4G	1	2412	11b	Cheek Left	0mm	A.23	18.48	19	99.3%	0.379	0.43	0.159	0.18	-0.09
Head	WLAN 2.4G	1	2412	11b	Tilt Left	0mm	\	18.48	19	99.3%	0.265	0.30	0.107	0.12	-0.09
Head	WLAN 2.4G	1	2412	11b	Cheek Right	0mm	\	18.48	19	99.3%	0.149	0.17	0.065	0.07	-0.06
Head	WLAN 2.4G	1	2412	11b	Tilt Right	0mm	\	18.48	19	99.3%	0.105	0.12	0.031	0.04	-0.09
Head	WLAN 2.4G	1	2412	11b	Cheek Left	0mm	S2	18.48	19	99.3%	0.364	0.41	0.142	0.16	0.04
Body	WLAN 2.4G	1	2412	11b	Front	10mm	\	18.48	19	99.3%	0.087	0.10	0.044	0.05	-0.09
Body	WLAN 2.4G	1	2412	11b	Rear	10mm	A.24	18.48	19	99.3%	0.238	0.27	0.105	0.12	-0.07
Body	WLAN 2.4G	1	2412	11b	Right	10mm	\	18.48	19	99.3%	0.156	0.18	0.073	0.08	0
Body	WLAN 2.4G	1	2412	11b	Top	10mm	\	18.48	19	99.3%	0.094	0.11	0.037	0.04	-0.09
Body	WLAN 2.4G	1	2412	11b	Rear	10mm	S2	18.48	19	99.3%	0.226	0.26	0.094	0.11	-0.11

13.3 SAR Evaluation for Phablet

According to the KDB648474 D04, for smart phones, with a display diagonal dimension > 15.0 cm or an overall diagonal dimension > 16.0 cm, that can provide similar mobile web access and multimedia support found in mini-tablets or UMPC mini-tablets and support voice calls next to the ear, unless it is confirmed otherwise through KDB inquiries, the following phablet procedures should be applied to evaluate SAR compliance for each applicable wireless modes and frequency band. Devices marketed as phablets, regardless of form factors and operating characteristics must be tested as a phablet to determine SAR compliance.

1. The normally required head and body-worn accessory SAR test procedures for handsets, including hotspot mode, must be applied.
2. The UMPC mini-tablet procedures must also be applied to test the SAR of all surfaces and edges with an antenna located at ≤ 25 mm from that surface or edge, in direct contact with a flat phantom, for 10-g extremity SAR according to the body-equivalent tissue dielectric parameters in KDB Publication 865664 D01 to address interactive hand use exposure conditions. When hotspot mode applies, 10-g extremity SAR is required only for the surfaces and edges with hotspot mode 1-g reported SAR > 1.2 W/kg; however, when power reduction applies to hotspot mode the measured SAR must be scaled to the maximum output power, including tolerance, allowed for phablet modes to compare with the 1.2 W/kg SAR test reduction threshold. The normal tablet procedures in KDB Publication 616217 are required when the overall diagonal dimension of the device is > 20.0 cm. Hotspot mode SAR is not required when normal tablet procedures are applied. Extremity 10-g SAR is also not required for the front (top) surface of larger form factor full size tablets. The more conservative normal tablet SAR results can be used to support phablet mode 10-g extremity SAR.
3. The simultaneous transmission operating configurations applicable to voice and data transmissions for both phone and mini-tablet modes must be taken into consideration separately for 1-g and 10-g SAR to determine the simultaneous transmission SAR test exclusion and measurement requirements for the relevant wireless modes and exposure conditions

10g extremity SAR determination

Frequency Band	Channel Number	Frequency (MHz)	Mode/RB	Test Position	EUT Measured Power (dBm)	Hotspot off tune-up Power (dBm)	Measured SAR 1g (W/kg)	Adjusted SAR(1g)(W/kg)	Test reduction threshold
GSM850	251	848.8	GPRS(2TX)	Rear	30.90	31.5	0.32	0.37	1.2W/kg
GSM1900	810	1909.8	GPRS(3TX)	Bottom	25.92	27	0.561	0.72	
WCDMA1900	9400	1880	RMC	Front	23.41	24	0.348	0.40	
WCDMA1900	9538	1907.6	RMC	Rear	23.44	24	0.966	1.10	
WCDMA1900	9400	1880	RMC	Rear	23.41	24	0.872	1.00	
WCDMA1900	9262	1852.4	RMC	Rear	23.43	24	0.818	0.93	
WCDMA1900	9400	1880	RMC	Left	23.41	24	0.223	0.26	
WCDMA1900	9400	1880	RMC	Right	23.41	24	0.089	0.10	
WCDMA1900	9538	1907.6	RMC	Bottom	23.44	24	1.1	1.25	
WCDMA1900	9400	1880	RMC	Bottom	23.41	24	1.03	1.18	
WCDMA1900	9262	1852.4	RMC	Bottom	23.43	24	0.936	1.07	
WCDMA1700	1413	1732.6	RMC	Rear	23.55	24	0.945	1.05	
WCDMA 850	4233	846.6	RMC	Rear	23.37	24	0.267	0.31	
LTE Band2	19100	1900	1RB-Low	Rear	23.29	24	0.875	1.03	
LTE Band5	20600	844	1RB-Middle	Rear	22.89	24	0.219	0.28	
LTE Band7	20850	2510	1RB-High	Bottom	23.86	24	0.879	0.91	
LTE Band12	23130	711	1RB-Middle	Rear	22.93	24	0.143	0.18	
LTE Band41	40620	2593	1RB-Middle	Rear	24.10	24.5	0.225	0.25	
LTE Band66	132072	1720	1RB-High	Rear	23.27	24	0.796	0.94	
WLAN 2.4G	1	2412	11b	Rear	18.48	19	0.238	0.27	

According to above evaluation procedure , the 10-g extremity SAR is required for WCDMA1900

SAR Values for 10g extremity SAR

RF Exposure Conditions	Frequency Band	Channel Number	Frequency (MHz)	Mode/RB	Test Position	Distance	Figure No./Note	EUT Measured Power (dBm)	Tune up (dBm)	Measured SAR 1g (W/kg)	Reported SAR 1g (W/kg)	Measured SAR 10g (W/kg)	Reported SAR 10g (W/kg)	Power Drift
Body	WCDMA1900	9538	1907.6	RMC	Bottom	0mm	A.25	23.44	24	4.6	5.23	2.28	2.59	-0.06

14 SAR Measurement Variability

SAR measurement variability must be assessed for each frequency band, which is determined by the SAR probe calibration point and tissue-equivalent medium used for the device measurements. When both head and body tissue-equivalent media are required for SAR measurements in a frequency band, the variability measurement procedures should be applied to the tissue medium with the highest measured SAR, using the highest measured SAR configuration for that tissue-equivalent medium.

The following procedures are applied to determine if repeated measurements are required.

- 1) Repeated measurement is not required when the original highest measured SAR is < 0.80 W/kg; steps 2) through 4) do not apply.
- 2) When the original highest measured SAR is ≥ 0.80 W/kg, repeat that measurement once.
- 3) Perform a second repeated measurement only if the ratio of largest to smallest SAR for the original and first repeated measurements is > 1.20 or when the original or repeated measurement is ≥ 1.45 W/kg ($\sim 10\%$ from the 1-g SAR limit).
- 4) Perform a third repeated measurement only if the original, first or second repeated measurement is ≥ 1.5 W/kg and the ratio of largest to smallest SAR for the original, first and second repeated measurements is > 1.20 .

Band	Frequency		Mode	Test Position	Distance (mm)	Highest Measured SAR (W/kg)	First Repeated SAR (W/kg)	The Ratio	Second Repeated SAR (W/kg)
	Ch.	MHz							
WCDMA1900	9538	1907.6	RMC	Rear	10mm	0.966	0.951	1.02	/
WCDMA1900	9400	1880	RMC	Rear	10mm	0.872	0.867	1.01	/
WCDMA1900	9262	1852.4	RMC	Rear	10mm	0.818	0.795	1.03	/
WCDMA1900	9538	1907.6	RMC	Bottom	10mm	1.1	1.05	1.05	/
WCDMA1900	9400	1880	RMC	Bottom	10mm	1.03	0.987	1.04	/
WCDMA1900	9262	1852.4	RMC	Bottom	10mm	0.936	0.906	1.03	/
WCDMA1700	1513	1752.6	RMC	Rear	10mm	0.867	0.852	1.02	/
WCDMA1700	1413	1732.6	RMC	Rear	10mm	0.945	0.931	1.02	/
WCDMA1700	1312	1712.4	RMC	Rear	10mm	0.911	0.897	1.02	/
WCDMA1700	1312	1712.4	RMC	Bottom	10mm	0.844	0.826	1.02	/
LTE Band2	19100	1900	1RB-Low	Rear	10mm	0.875	0.835	1.05	/
LTE Band2	19100	1900	1RB-Low	Bottom	10mm	0.87	0.859	1.01	/
LTE Band2	18900	1880	1RB-Low	Bottom	10mm	0.846	0.823	1.03	/
LTE Band2	18700	1860	1RB-Low	Bottom	10mm	0.847	0.836	1.01	/
LTE Band7	20850	2510	1RB-High	Bottom	10mm	0.879	0.845	1.04	/

15 Evaluation of Simultaneous

15.1 Introduction

The following procedures adopted from “FCC SAR Considerations for Cell Phones with Multiple Transmitters” are applicable to handsets with built-in unlicensed transmitters such as WLAN and Bluetooth devices which may simultaneously transmit with the licensed transmitter. KDB 447498 D01 provides two procedures for determining simultaneous transmission SAR test exclusion: Sum of SAR and SAR to Peak Location Ratio (SPLSR)

15.1.1 Sum of SAR

To qualify for simultaneous transmission SAR test exclusion based upon Sum of SAR the sum of the reported standalone SARs for all simultaneously transmitting antennas shall be below the applicable standalone SAR limit. If the sum of the SARs is above the applicable limit then simultaneous transmission SAR test exclusion may still apply if the requirements of the SAR to Peak Location Ratio (SPLSR) evaluation are met.

15.1.2 SAR to Peak Location Ratio (SPLSR)

KDB 447498 D01 General RF Exposure Guidance explains how to calculate the SAR to Peak Location Ratio (SPLSR) between pairs of simultaneously transmitting antennas:

$$SPLSR = (SAR1 + SAR2)^{1.5} / Ri$$

Where:

SAR1 is the highest reported or estimated SAR for the first of a pair of simultaneous transmitting antennas, in a specific test operating mode and exposure condition.

SAR2 is the highest reported or estimated SAR for the second of a pair of simultaneous transmitting antennas, in the same test operating mode and exposure condition as the first .

Ri is the separation distance between the pair of simultaneous transmitting antennas. When the SAR is measured, for both antennas in the pair, it is determined by the actual x, y and z coordinates in the 1-g SAR for each SAR peak location, based on the extrapolated and interpolated result in the zoom scan measurement, using the formula of

$$[(x1-x2)^2 + (y1-y2)^2 + (z1-z2)^2]$$

In order for a pair of simultaneous transmitting antennas with the sum of 1-g SAR > 1.6 W/kg to qualify for exemption from Simultaneous Transmission SAR measurements, it has to satisfy the condition of:

$$(SAR1 + SAR2)^{1.5} / Ri \leq 0.04$$

When an individual antenna transmits at on two bands simultaneously, the sum of the highest reported SAR for the frequency bands should be used to determine *SAR1* or *SAR2*. When SPLSR is necessary, the smallest distance between the peak SAR locations for the antenna pair with respect to the peaks from each antenna should be used.

15.2 Simultaneous Transmission Capabilities

The simultaneous transmission possibilities for this device are listed as below:

Capable Transmit Configurations	Head	Body	Product Specific 10-g (0mm)
GSM/WCDMA/LTE + Wi-Fi 2.4G SISO	Yes	Yes	Yes
GSM/WCDMA/LTE + Wi-Fi 2.4G SISO+BT	Yes	Yes	Yes

Note:

1. Wi-Fi 2.4GHz & Bluetooth can transmit simultaneously.
2. WWAN cannot transmit simultaneously.
3. The reported SAR summation is calculated based on the same configuration and test position.
4. For the devices edges with antennas more than 2.5 cm from edge are not required to be evaluated for SAR, where determined the SAR of these edges were less than 0.01. For the convenience of simultaneous transmission calculation, all SAR values less than 0.01 are uniformly written as 0.00

15.3 SAR Simultaneous Transmission Analysis

reported SAR 1g (W/kg)																
Head		GSM850	GSM1900	WCDMA 1900	WCDMA 1700	WCDMA 850	LTE Band2	LTE Band5	LTE Band7	LTE Band12	LTE Band41	LTE Band66	2.4G	BT [1]	Cellular+WiFi2.4G	Cellular+WiFi2.4G+BT
Cheek	L	0.22	0.15	0.19	0.11	0.21	0.15	0.16	0.33	0.09	0.12	0.18	0.43	0.26	0.76	1.02
Tilt	L	0.09	0.09	0.13	0.10	0.12	0.11	0.08	0.19	0.00	0.10	0.20	0.30	0.26	0.50	0.76
Cheek	R	0.14	0.11	0.20	0.15	0.17	0.13	0.12	0.15	0.07	0.06	0.25	0.17	0.26	0.42	0.68
Tilt	R	0.09	0.07	0.13	0.12	0.11	0.10	0.08	0.13	0.04	0.04	0.23	0.12	0.26	0.35	0.61

reported SAR 10g (W/kg)																
Body		GSM850	GSM1900	WCDMA 1900	WCDMA 1700	WCDMA 850	LTE Band2	LTE Band5	LTE Band7	LTE Band12	LTE Band41	LTE Band66	2.4G	BT [1]	Cellular+WiFi2.4G	Cellular+WiFi2.4G+BT
Front	10mm	0.16	0.23	0.40	0.39	0.15	0.31	0.16	0.37	0.10	0.15	0.29	0.10	0.13	0.50	0.63
Rear	10mm	0.37	0.50	1.10	1.05	0.31	1.03	0.28	0.72	0.18	0.25	0.94	0.27	0.13	1.37	1.50
Left	10mm	0.12	0.13	0.26	0.22	0.07	0.23	0.12	0.29	0.08	0.11	0.17	0.18	0.13	0.47	0.60
Right	10mm	0.14	0.05	0.10	0.09	0.14	0.09	0.15	0.17	0.11	0.05	0.07	\	\	0.17	0.17
Bottom	10mm	0.14	0.72	1.25	0.95	0.19	1.02	0.20	0.91	0.07	0.24	0.71	\	\	1.25	1.25
Top	10mm	\	\	\	\	\	\	\	\	\	\	\	0.11	0.13	0.11	0.24

reported SAR 10g (W/kg)																
Product Specific		GSM850	GSM1900	WCDMA 1900	WCDMA 1700	WCDMA 850	LTE Band2	LTE Band5	LTE Band7	LTE Band12	LTE Band41	LTE Band66	2.4G	BT	Cellular+WiFi2.4G	Cellular+WiFi2.4G+BT
Bottom	0mm	\	\	2.59	\	\	\	\	\	\	\	\	\	\	2.59	2.59

Note:

3. Estimated SAR for Bluetooth (see the section 12.3)

15.4 Conclusion

According to the above tables, the highest simultaneous transmission reported SAR values is **1.50W/kg (1g)**. The sum of reported SAR values is <1.6W/kg. So the simultaneous transmission SAR with volume scans is not required.

16 Measurement Uncertainty

Per KDB 865664 D01 SAR Measurement 100 MHz to 6 GHz, when the highest measured 1-g SAR within a frequency band is < 1.5 W/kg and the measured 10-g SAR within a frequency band is < 3.75 W/kg. The expanded SAR measurement uncertainty must be $\leq 30\%$, for a confidence interval of $k = 2$. If these conditions are met, extensive SAR measurement uncertainty analysis described in IEEE Std 1528-2013 is not required in SAR reports submitted for equipment approval.

Therefore, the measurement uncertainty is not required.

17 MAIN TEST INSTRUMENTS

No.	Name	Type	Serial Number	Calibration Date	Valid Period
01	Network analyzer	E5071C	MY46110673	January 14, 2021	One year
02	Power meter	NRP2	106276	May 11, 2021	One year
03	Power sensor	NRP6A	101369		
04	Signal Generator	E4438C	MY49070393	May 14, 2021	One Year
05	Amplifier	60S1G4	0331848	No Calibration Requested	
06	BTS	CMW500	159890	January 25 2021	One year
07	BTS	CMW500	166370	June 25, 2021	One year
08	E-field Probe	SPEAG EX3DV4	7464	December 18,2020	One year
09	DAE	SPEAG DAE4	1588	September 2, 2020	One year
10	DAE	SPEAG DAE4	549	January 08, 2021	One year
11	Dipole Validation Kit	SPEAG D750V3	1017	July 12,,2021	One year
12	Dipole Validation Kit	SPEAG D835V2	4d069	July 12,,2021	One year
13	Dipole Validation Kit	SPEAG D1750V2	1003	July 12, 2021	One year
14	Dipole Validation Kit	SPEAG D1900V2	5d101	July 15,2021	One year
15	Dipole Validation Kit	SPEAG D2450V2	853	July 26,2021	One year
16	Dipole Validation Kit	SPEAG D2600V2	1012	July 26,2021	One year

END OF REPORT BODY



Appendixes

Refer to separated files for the following appendixes

ANNEX A Graph Results

ANNEX B System Verification Results

ANNEX C SAR Measurement Setup

ANNEX D Position of the wireless device in relation to the phantom

ANNEX E Equivalent Media Recipes

ANNEX F System Validation

ANNEX G Probe Calibration Certificate

ANNEX H Dipole Calibration Certificate

ANNEX I Accreditation Certificate