



SAR TEST REPORT

No. I20Z70377-SEM02

For

Samsung Electronics Co., Ltd.

Smart Phone

Model name: SM-A025U

With

Hardware Version: REV1.0

Software Version: A025U.001

FCC ID: ZCASMA025U

Issued Date: 2021-2-5

Note:

The test results in this test report relate only to the devices specified in this report. This report shall not be reproduced except in full without the written approval of CTTL.

The report must not be used by the client to claim product certification, approval, or endorsement by NVLAP, NIST, or any agency of the U.S. Government.

Test Laboratory:

CTTL, Telecommunication Technology Labs, CAICT

No. 51, Xueyuan Road, Haidian District, Beijing, P. R. China 100191.

Tel:+86(0)10-62304633-2512, Fax:+86(0)10-62304633-2504

Email: ctl_terminals@caict.ac.cn, website: www.caict.ac.cn



No.I20Z70377-SEM02

REPORT HISTORY

Report Number	Revision	Issue Date	Description
I20Z70377-SEM02	Rev.0	2021-1-29	Initial creation of test report
I20Z70377-SEM02	Rev.1	2021-2-5	Update the information on section 3.1 of test report.

TABLE OF CONTENT

1 TEST LABORATORY	5
1.1 TESTING LOCATION	5
1.2 TESTING ENVIRONMENT.....	5
1.3 PROJECT DATA	5
1.4 SIGNATURE.....	5
2 STATEMENT OF COMPLIANCE	6
3 CLIENT INFORMATION	8
3.1 APPLICANT INFORMATION	8
3.2 MANUFACTURER INFORMATION	8
4 EQUIPMENT UNDER TEST (EUT) AND ANCILLARY EQUIPMENT (AE)	9
4.1 ABOUT EUT	9
4.2 INTERNAL IDENTIFICATION OF EUT USED DURING THE TEST	10
4.3 INTERNAL IDENTIFICATION OF AE USED DURING THE TEST	10
5 TEST METHODOLOGY	11
5.1 APPLICABLE LIMIT REGULATIONS	11
5.2 APPLICABLE MEASUREMENT STANDARDS.....	11
6 SPECIFIC ABSORPTION RATE (SAR)	12
6.1 INTRODUCTION.....	12
6.2 SAR DEFINITION.....	12
7 TISSUE SIMULATING LIQUIDS	13
7.1 TARGETS FOR TISSUE SIMULATING LIQUID	13
7.2 DIELECTRIC PERFORMANCE	13
8 SYSTEM VERIFICATION	18
8.1 SYSTEM SETUP.....	18
8.2 SYSTEM VERIFICATION.....	19
9 MEASUREMENT PROCEDURES	20
9.1 TESTS TO BE PERFORMED	20
9.2 GENERAL MEASUREMENT PROCEDURE.....	22
9.3 WCDMA MEASUREMENT PROCEDURES FOR SAR	23
9.4 SAR MEASUREMENT FOR LTE.....	24
9.5 BLUETOOTH & WI-FI MEASUREMENT PROCEDURES FOR SAR	26
9.6 POWER DRIFT.....	26
10 AREA SCAN BASED 1-G SAR	27
10.1 REQUIREMENT OF KDB.....	27
10.2 FAST SAR ALGORITHMS	27

11 CONDUCTED OUTPUT POWER	28
11.1 GSM MEASUREMENT RESULT	28
11.2 WCDMA MEASUREMENT RESULT.....	31
11.3 CDMA MEASUREMENT RESULT	33
11.4 LTE MEASUREMENT RESULT	35
11.5 WI-FI AND BT MEASUREMENT RESULT	92
12 SIMULTANEOUS TX SAR CONSIDERATIONS	94
12.1 INTRODUCTION.....	94
12.2 TRANSMIT ANTENNA SEPARATION DISTANCES	94
12.3 SAR MEASUREMENT POSITIONS	94
12.4 STANDALONE SAR TEST EXCLUSION CONSIDERATIONS	95
13 EVALUATION OF SIMULTANEOUS	96
14 SAR TEST RESULT	97
14.1 SAR RESULTS FOR FAST SAR.....	98
14.2 SAR RESULTS FOR STANDARD PROCEDURE	114
14.3 WLAN EVALUATION FOR 2.4G	122
14.4 WLAN EVALUATION FOR 5G.....	126
15 SAR MEASUREMENT VARIABILITY	132
16 MEASUREMENT UNCERTAINTY	133
16.1 MEASUREMENT UNCERTAINTY FOR NORMAL SAR TESTS (300MHZ~3GHZ)	133
16.2 MEASUREMENT UNCERTAINTY FOR NORMAL SAR TESTS (3~6GHZ)	134
16.3 MEASUREMENT UNCERTAINTY FOR FAST SAR TESTS (300MHZ~3GHZ)	135
16.4 MEASUREMENT UNCERTAINTY FOR FAST SAR TESTS (3~6GHZ).....	136
17 MAIN TEST INSTRUMENTS	137
ANNEX A GRAPH RESULTS	138
ANNEX B SYSTEM VERIFICATION RESULTS	189
ANNEX C SAR MEASUREMENT SETUP	202
ANNEX D POSITION OF THE WIRELESS DEVICE IN RELATION TO THE PHANTOM	208
ANNEX E EQUIVALENT MEDIA RECIPES	211
ANNEX F SYSTEM VALIDATION	212
ANNEX G PROBE CALIBRATION CERTIFICATE	213
ANNEX H DIPOLE CALIBRATION CERTIFICATE	236
ANNEX I SENSOR TRIGGERING DATA SUMMARY	307
ANNEX J ACCREDITATION CERTIFICATE	311

1 Test Laboratory

1.1 Testing Location

Company Name:	CTTL(Shouxiang)
Address:	No. 51 Shouxiang Science Building, Xueyuan Road, Haidian District, Beijing, P. R. China100191

1.2 Testing Environment

Temperature:	18°C~25°C,
Relative humidity:	30%~ 70%
Ground system resistance:	< 0.5 Ω
Ambient noise & Reflection:	< 0.012 W/kg

1.3 Project Data

Project Leader:	Qi Dianyuan
Test Engineer:	Lin Xiaojun
Testing Start Date:	January 4, 2021
Testing End Date:	January 15, 2021

1.4 Signature



Lin Xiaojun

(Prepared this test report)

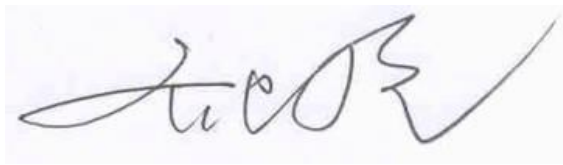

Qi Dianyuan

(Reviewed this test report)

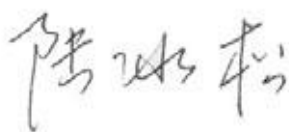

Lu Bingsong

Deputy Director of the laboratory

(Approved this test report)

2 Statement of Compliance

The maximum results of Specific Absorption Rate (SAR) found during testing for Samsung Electronics Co., Ltd. Smart Phone SM-A025U are as follows.

Table 2.1: Highest Reported SAR (1g)

Antenna	Band	Head	Body	1g SAR Limits (W/kg)
		1g SAR(W/kg)	1g SAR(W/kg)	
Main antenna	GSM 850	0.36	0.66	1.6
	PCS 1900	0.45	0.55	
	UMTS FDD 2	0.44	0.68	
	UMTS FDD 4	0.69	0.61	
	UMTS FDD 5	0.36	0.59	
	CDMA BC0	0.40	0.63	
	CDMA BC1	0.68	0.52	
	CDMA BC10	0.32	0.56	
	LTE Band 7	0.07	0.50	
	LTE Band 12	0.27	0.62	
	LTE Band 13	0.32	0.54	
	LTE Band 25	1.00	0.39	
	LTE Band 26	0.34	0.58	
	LTE Band 41(Power Class 3)	0.44	0.56	
	LTE Band 41(Power Class 2)	0.25	0.85	
	WiFi antenna	LTE Band 66	0.84	
LTE Band 71		0.27	0.66	
WiFi 2.4G		0.61	0.36	
	WiFi 5G	0.79	0.74	

The SAR values found for the Mobile Phone are below the maximum recommended levels of 1.6 W/kg as averaged over any 1g tissue according to the ANSI C95.1-1992.

For body operation, this device has been tested and meets FCC RF exposure guidelines when used with any accessory that contains no metal and which provides a minimum separation distance of 10/12/17/19 mm between this device and the body of the user. Use of other accessories may not ensure compliance with FCC RF exposure guidelines.

The EUT battery must be fully charged and checked periodically during the test to ascertain uniform power output.

The measurement together with the test system set-up is described in annex C of this test report. A detailed description of the equipment under test can be found in chapter 4 of this test report. The highest reported SAR value is obtained at the case of **(Table 2.1)**, and the values are: **1.00 W/kg(1g)**.

Table 2.2: The sum of SAR values for Main antenna + WiFi-2.4G

	Position	Band	Cellular antenna	WiFi-2.4G	Sum
Highest reported SAR value for Head	Right hand, Cheek	LTE Band25	1.00	0.05	1.05
Highest SAR value for Body	Right 10mm	LTE Band71	0.66	0.36	1.02

Table 2.3: The sum of SAR values for Main antenna + WiFi-5G

	Position	Band	Cellular antenna	WiFi-5G	Sum
Highest SAR value for Head	Right hand, Cheek	LTE Band25	1.00	0.26	1.26
Maximum reported SAR value for Body	Rear 10mm	GSM850	0.66	0.74	1.40

Table 2.4: The sum of SAR values for Main antenna + WiFi-5G +BT

	Position	Band	Cellular antenna	WiFi-5G	BT	Sum
Highest SAR value for Head	Right hand, Cheek	LTE Band25	1.00	0.26	<0.01	1.26
Maximum reported SAR value for Body	Rear 10mm	GSM850	0.66	0.74	<0.01	1.40

Note1: the test positions of above tables are for the worse case that have been evaluated.

[1] – The SAR of BT is too low to get it, so the “<0.01” is used to indicate the head SAR of BT.

According to the above tables, the highest sum of reported SAR values is **1.40 W/kg (1g)**. The detail for simultaneous transmission consideration is described in chapter 13.

3 Client Information

3.1 Applicant Information

Company Name:	Samsung Electronics Co., Ltd.
Address/Post:	19 Chapin Rd., Building D Pine Brook, NJ 07058
Contact Person:	Jenni Chun
Contact Email:	j1.chun@samsung.com
Telephone:	+1-201-937-4203
Fax	/

3.2 Manufacturer Information

Company Name:	Samsung Electronics Co., Ltd.
Address/Post:	Samsung R5, Maetan dong 129, Samsung ro Youngtong gu, Suwon city 443 742, Korea
Contact Person:	Sunghoon Cho
Contact Email:	ggobi.cho@samsung.com
Telephone:	+82-10-2722-4159
Fax	/

4 Equipment Under Test (EUT) and Ancillary Equipment (AE)

4.1 About EUT

Description:	Smart Phone
Model name:	SM-A025U
Operating mode(s):	GSM 850/900/1800/1900, UMTS FDD 1/2/4/5/8, CDMA BC0/1/10, BT, Wi-Fi(2.4/5G) LTE Band 2/4/5/7/12/13/25/26/41/66/71
Tested Tx Frequency:	824 – 849 MHz (GSM 850)
	1850 – 1910 MHz (GSM 1900)
	824–849 MHz (WCDMA 850 Band V)
	1710 – 1755 MHz (WCDMA 1700 Band IV)
	1850–1910 MHz (WCDMA1900 Band II)
	824.7 - 848.31 MHz (CDMA BC0)
	1851.25 - 1908.75 MHz (CDMA BC1)
	817.9 - 823.1 MHz (CDMA BC10)
	2502.5 – 2567.5 MHz(LTE Band 7)
	699 – 716 MHz (LTE Band 12)
	777 – 787 MHz (LTE Band 13)
	1850.7 – 1914.3 MHz (LTE Band 25)
	814.7 – 848.3 MHz (LTE Band 26)
	2498.5 – 2687.5 MHz (LTE Band 41)
	1710.7 – 1779.3 MHz (LTE Band 66)
665.5 – 695.5 MHz (LTE Band 71)	
2412 – 2462 MHz (Wi-Fi 2.4G)	
5150-5825 MHz (Wi-Fi 5G)	
GPRS/EGPRS Multislot Class:	33
GPRS capability Class:	B
Test device Production information:	Production unit
Device type:	Portable device
Antenna type:	Integrated antenna
HUPE	Support

4.2 Internal Identification of EUT used during the test

EUT ID*	IMEI	HW	SW Version
EUT1	2070377UT24a	REV1.0	A025U.001
EUT2	2070377UT25a	REV1.0	A025U.001
EUT3	2070377UT27a	REV1.0	A025U.001
EUT4	2070377UT28a	REV1.0	A025U.001
EUT5	2070377UT26a	REV1.0	A025U.001
EUT6	2070377UT18a	REV1.0	A025U.001
EUT7	2070377UT19a	REV1.0	A025U.001
EUT8	2070377UT20a	REV1.0	A025U.001
EUT9	2070377UT23a	REV1.0	A025U.001

*EUT ID: is used to identify the test sample in the lab internally.

Note: It is performed to test SAR with the EUT1~5 and conducted power with the EUT6~9.

4.3 Internal Identification of AE used during the test

AE ID*	Description	Model	SN	Manufacturer
AE1	Battery	Secondary Li-ion Battery	HQ-50S	SCUD (Fujian) Electronics CO.,LTD
AE2	Headset	EHS61ASFWE	/	DONGGUAN YOUNGBO ELECTRONICS CO.,LTD
AE3	Headset	EHS61ASFWE	/	WATA ELECTRONICS CO.,LTD

*AE ID: is used to identify the test sample in the lab internally.

5 TEST METHODOLOGY

5.1 Applicable Limit Regulations

ANSI C95.1–1992: IEEE Standard for Safety Levels with Respect to Human Exposure to Radio Frequency Electromagnetic Fields, 3 kHz to 300 GHz.

It specifies the maximum exposure limit of **1.6 W/kg** as averaged over any 1 gram of tissue for portable devices being used within 20 cm of the user in the uncontrolled environment.

5.2 Applicable Measurement Standards

IEEE 1528–2013: Recommended Practice for Determining the Peak Spatial-Average Specific Absorption Rate (SAR) in the Human Head from Wireless Communications Devices: Measurement Techniques.

KDB447498 D01: General RF Exposure Guidance v06: Mobile and Portable Devices RF Exposure Procedures and Equipment Authorization Policies.

KDB648474 D04 Handset SAR v01r03: SAR Evaluation Considerations for Wireless Handsets.

KDB941225 D01 SAR test for 3G devices v03r01: SAR Measurement Procedures for 3G Devices

KDB941225 D05 SAR for LTE Devices v02r05: SAR Evaluation Considerations for LTE Devices

KDB941225 D06 Hotspot Mode SAR v02r01: SAR Evaluation Procedures for Portable Devices with Wireless Router Capabilities

KDB248227 D01 802.11 Wi-Fi SAR v02r02: SAR GUIDANCE FOR IEEE 802.11 (Wi-Fi) TRANSMITTERS

KDB865664 D01 SAR measurement 100 MHz to 6 GHz v01r04: SAR Measurement Requirements for 100 MHz to 6 GHz.

KDB865664 D02 RF Exposure Reporting v01r02: RF Exposure Compliance Reporting and Documentation Considerations

6 Specific Absorption Rate (SAR)

6.1 Introduction

SAR is related to the rate at which energy is absorbed per unit mass in an object exposed to a radio field. The SAR distribution in a biological body is complicated and is usually carried out by experimental techniques or numerical modeling. The standard recommends limits for two tiers of groups, occupational/controlled and general population/uncontrolled, based on a person's awareness and ability to exercise control over his or her exposure. In general, occupational/controlled exposure limits are higher than the limits for general population/uncontrolled.

6.2 SAR Definition

The SAR definition is the time derivative (rate) of the incremental energy (dW) absorbed by (dissipated in) an incremental mass (dm) contained in a volume element (dv) of a given density (ρ). The equation description is as below:

$$SAR = \frac{d}{dt} \left(\frac{dW}{dm} \right) = \frac{d}{dt} \left(\frac{dW}{\rho dv} \right)$$

SAR is expressed in units of Watts per kilogram (W/kg)

SAR measurement can be either related to the temperature elevation in tissue by

$$SAR = c \left(\frac{\delta T}{\delta t} \right)$$

Where: C is the specific heat capacity, δT is the temperature rise and δt is the exposure duration, or related to the electrical field in the tissue by

$$SAR = \frac{\sigma |E|^2}{\rho}$$

Where: σ is the conductivity of the tissue, ρ is the mass density of tissue and E is the RMS electrical field strength.

However for evaluating SAR of low power transmitter, electrical field measurement is typically applied.

7 Tissue Simulating Liquids

7.1 Targets for tissue simulating liquid

Table 7.1: Targets for tissue simulating liquid

Frequency(MHz)	Liquid Type	Conductivity(σ)	$\pm 5\%$ Range	Permittivity(ϵ)	$\pm 5\%$ Range
750	Head	0.89	0.85~0.93	41.94	39.8~44.0
835	Head	0.90	0.86~0.95	41.5	39.4~43.6
1750	Head	1.37	1.30~1.44	40.08	38.1~42.1
1900	Head	1.40	1.33~1.47	40.0	38.0~42.0
2450	Head	1.80	1.71~1.89	39.2	37.2~41.2
2600	Head	1.96	1.86~2.06	39.01	37.1~41.0
5250	Head	4.71	4.47~4.95	35.93	34.13~37.73
5600	Head	5.07	4.82~5.32	35.53	33.8~37.3
5750	Head	5.22	4.96~5.48	35.36	33.59~37.13

7.2 Dielectric Performance

Table 7.2: Dielectric Performance of Tissue Simulating Liquid

Measurement Date (yyyy-mm-dd)	Type	Frequency	Permittivity ϵ	Drift (%)	Conductivity σ (S/m)	Drift (%)
2021-1-4	Head	750 MHz	42.22	0.67	0.881	-1.01
2021-1-5	Head	835 MHz	42.29	1.90	0.889	-1.22
2021-1-6	Head	835 MHz	40.8	-1.69	0.889	-1.22
2021-1-7	Head	1750 MHz	40.85	1.92	1.358	-0.88
2021-1-8	Head	1900 MHz	40.17	0.43	1.418	1.29
2021-1-9	Head	1900 MHz	40.02	0.05	1.41	0.71
2021-1-10	Head	2450 MHz	39.01	-0.48	1.797	-0.17
2021-1-11	Head	2600 MHz	38.96	-0.13	1.985	1.28
2021-1-12	Head	2600 MHz	38.4	-1.56	1.96	0.00
2021-1-13	Head	5250 MHz	35.52	-1.14	4.685	-0.53
2021-1-14	Head	5600 MHz	35.74	0.59	5.019	-1.01
2021-1-15	Head	5750 MHz	35.92	1.58	5.161	-1.13

Note: The liquid temperature is 22.0°C

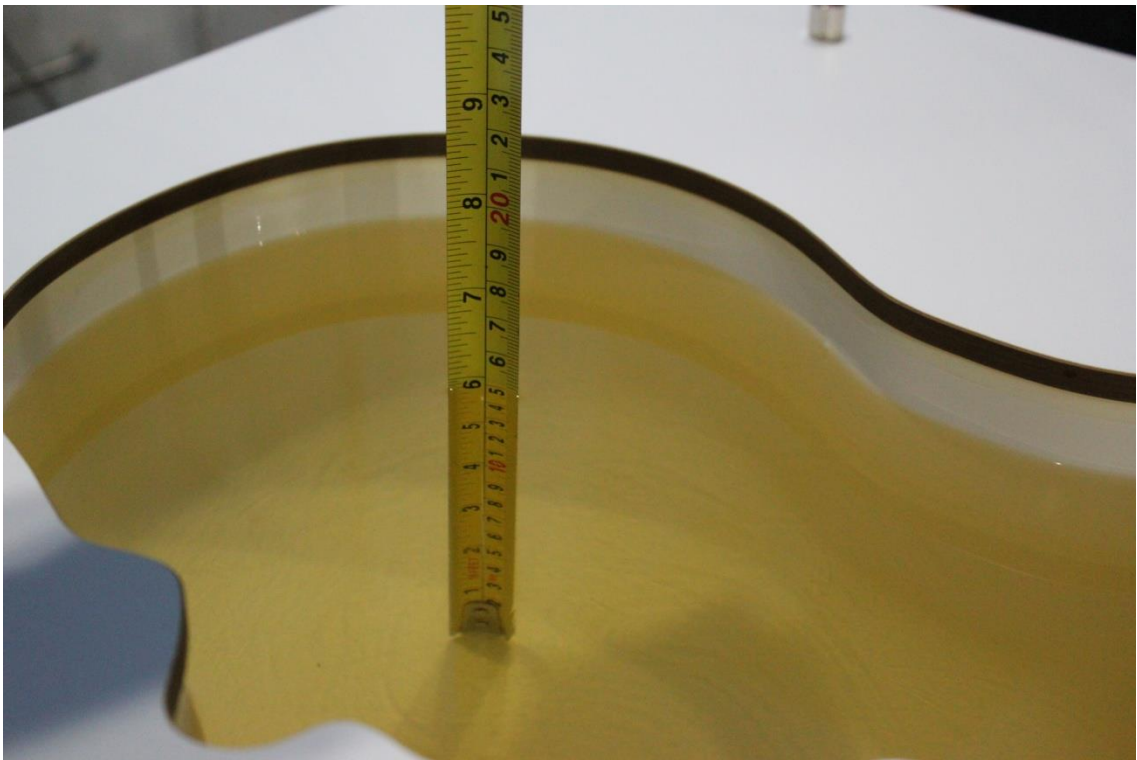

Picture 7-1 Liquid depth in the Head Phantom (750MHz)



Picture 7-2 Liquid depth in the Head Phantom (835 MHz)



Picture 7-3 Liquid depth in the Head Phantom (1750 MHz)



Picture 7-4 Liquid depth in the Head Phantom (1900 MHz)

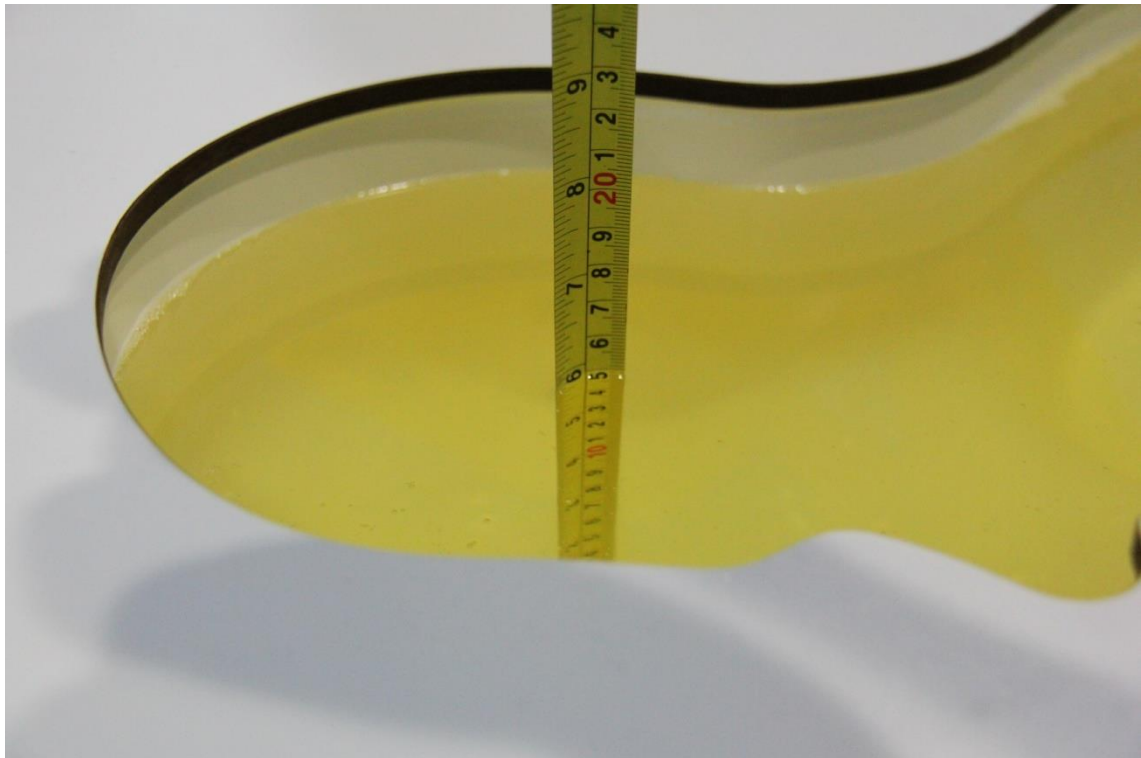

Picture 7-5 Liquid depth in the Head Phantom (2450MHz)



Picture 7-6 Liquid depth in the Head Phantom (2600 MHz)

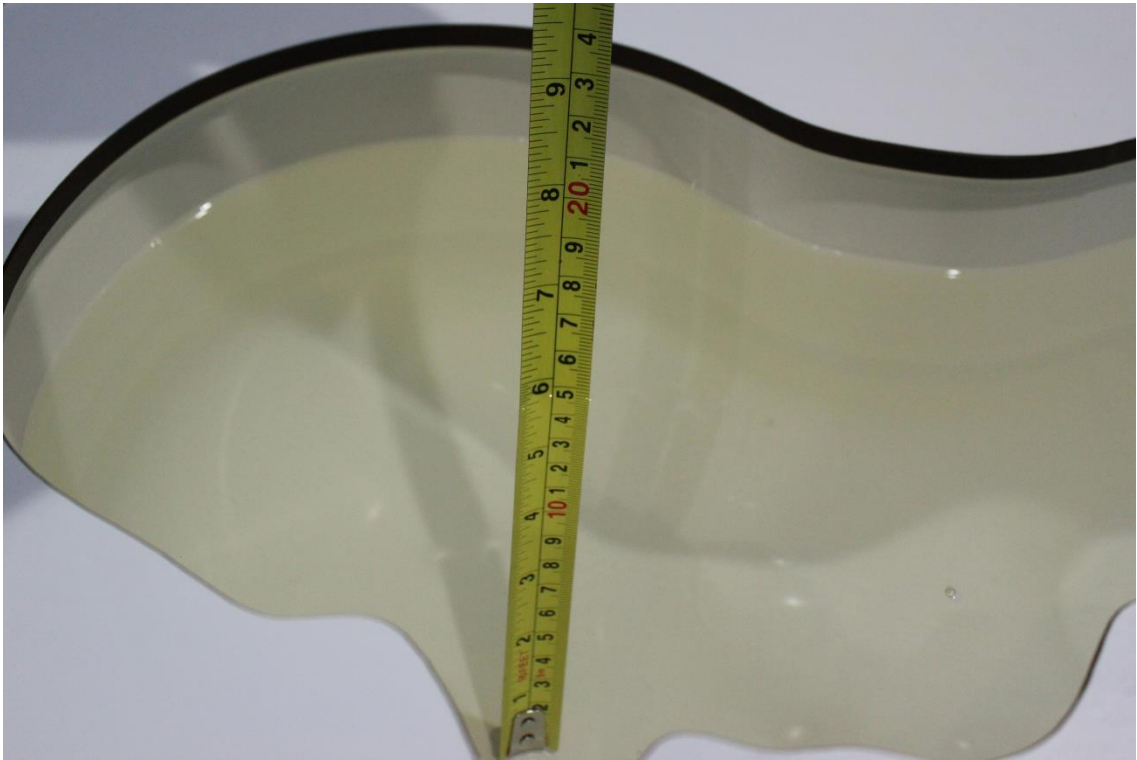

Picture 7-7 Liquid depth in the Head Phantom (5GHz)

8 System verification

8.1 System Setup

In the simplified setup for system evaluation, the DUT is replaced by a calibrated dipole and the power source is replaced by a continuous wave that comes from a signal generator. The calibrated dipole must be placed beneath the flat phantom section of the SAM twin phantom with the correct distance holder. The distance holder should touch the phantom surface with a light pressure at the reference marking and be oriented parallel to the long side of the phantom. The equipment setup is shown below:

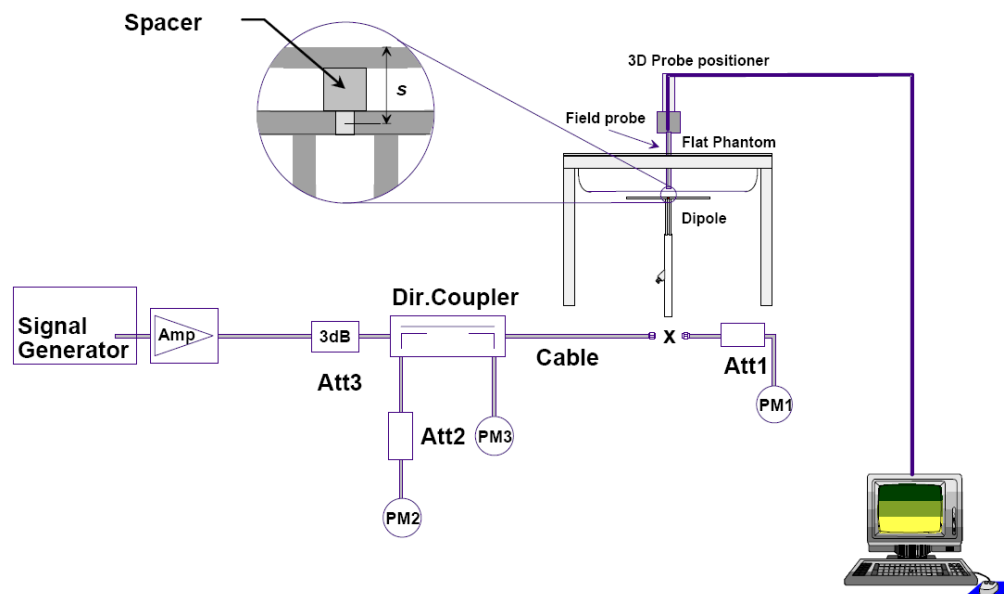

Picture 8.1 System Setup for System Evaluation



Picture 8.2 Photo of Dipole Setup

8.2 System Verification

SAR system verification is required to confirm measurement accuracy, according to the tissue dielectric media, probe calibration points and other system operating parameters required for measuring the SAR of a test device. The system verification must be performed for each frequency band and within the valid range of each probe calibration point required for testing the device.

The system verification results are required that the area scan estimated 1-g SAR is within 3% of the zoom scan 1-g SAR. The details are presented in annex B.

Table 8.1: System Verification of Head

Measurement Date (yyyy-mm-dd)	Frequency	Target value (W/kg)		Measured value(W/kg)		Deviation	
		10 g Average	1 g Average	10 g Average	1 g Average	10 g Average	1 g Average
2021-1-4	750 MHz	5.53	8.47	5.44	8.48	-1.63%	0.12%
2021-1-5	835 MHz	6.25	9.60	6.24	9.72	-0.16%	1.25%
2021-1-6	835 MHz	6.25	9.60	6.36	9.64	1.76%	0.42%
2021-1-7	1750 MHz	19.1	36.5	18.96	36.64	-0.73%	0.38%
2021-1-8	1900 MHz	20.6	39.6	20.44	39.6	-0.78%	0.00%
2021-1-9	1900 MHz	20.6	39.6	20.4	39.04	-0.97%	-1.41%
2021-1-10	2450 MHz	24.5	52.5	24.04	52.92	-1.88%	0.80%
2021-1-11	2600 MHz	25.3	57.0	24.84	57.48	-1.82%	0.84%
2021-1-12	2600 MHz	25.3	57.0	25.44	55.88	0.55%	-1.96%
2021-1-13	5250 MHz	22.9	80.5	22.7	80.2	-0.79%	-0.42%
2021-1-14	5600 MHz	23.6	83.3	23.4	83.0	-0.85%	-0.41%
2021-1-15	5750 MHz	22.7	80.4	22.7	80.0	0.09%	-0.55%

9 Measurement Procedures

9.1 Tests to be performed

In order to determine the highest value of the peak spatial-average SAR of a handset, all device positions, configurations and operational modes shall be tested for each frequency band according to steps 1 to 3 below. A flowchart of the test process is shown in picture 9.1.

Step 1: The tests described in 9.2 shall be performed at the channel that is closest to the centre of the transmit frequency band (f_c) for:

- a) all device positions (cheek and tilt, for both left and right sides of the SAM phantom, as described in annex D),
- b) all configurations for each device position in a), e.g., antenna extended and retracted, and
- c) all operational modes, e.g., analogue and digital, for each device position in a) and configuration in b) in each frequency band.

If more than three frequencies need to be tested according to 11.1 (i.e., $N_c > 3$), then all frequencies, configurations and modes shall be tested for all of the above test conditions.

Step 2: For the condition providing highest peak spatial-average SAR determined in Step 1, perform all tests described in 9.2 at all other test frequencies, i.e., lowest and highest frequencies. In addition, for all other conditions (device position, configuration and operational mode) where the peak spatial-average SAR value determined in Step 1 is within 3 dB of the applicable SAR limit, it is recommended that all other test frequencies shall be tested as well.

Step 3: Examine all data to determine the highest value of the peak spatial-average SAR found in Steps 1 to 2.

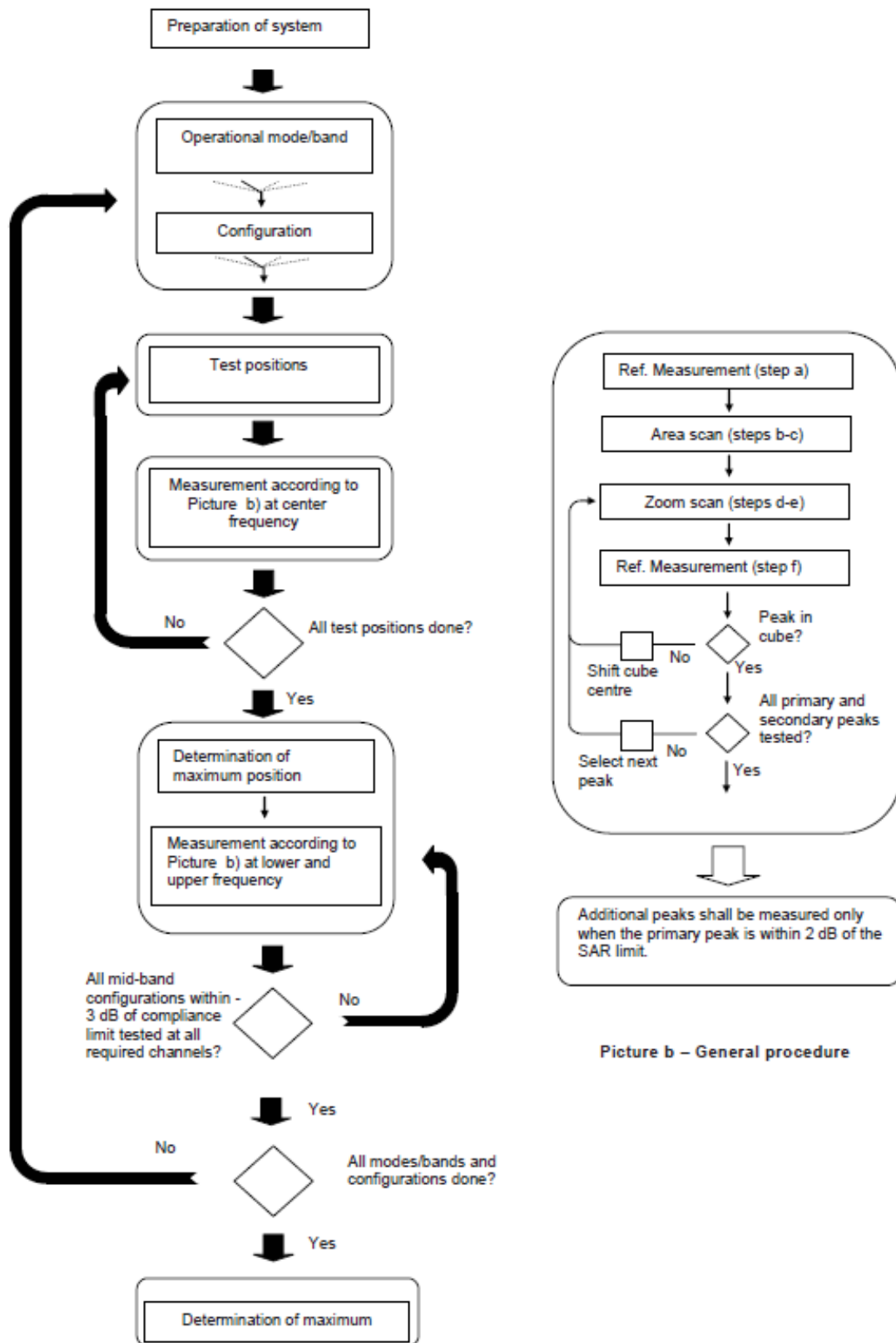

Picture a – Tests to be performed

Picture b – General procedure

Picture 9.1 Block diagram of the tests to be performed

9.2 General Measurement Procedure

The area and zoom scan resolutions specified in the table below must be applied to the SAR measurements and fully documented in SAR reports to qualify for TCB approval. Probe boundary effect error compensation is required for measurements with the probe tip closer than half a probe tip diameter to the phantom surface. Both the probe tip diameter and sensor offset distance must satisfy measurement protocols; to ensure probe boundary effect errors are minimized and the higher fields closest to the phantom surface can be correctly measured and extrapolated to the phantom surface for computing 1-g SAR. Tolerances of the post-processing algorithms must be verified by the test laboratory for the scan resolutions used in the SAR measurements, according to the reference distribution functions specified in IEEE Std 1528-2003. The results should be documented as part of the system validation records and may be requested to support test results when all the measurement parameters in the following table are not satisfied.

		≤ 3 GHz	> 3 GHz	
Maximum distance from closest measurement point (geometric center of probe sensors) to phantom surface		5 ± 1 mm	$\frac{1}{2} \cdot \delta \cdot \ln(2) \pm 0.5$ mm	
Maximum probe angle from probe axis to phantom surface normal at the measurement location		$30^\circ \pm 1^\circ$	$20^\circ \pm 1^\circ$	
Maximum area scan spatial resolution: Δx_{Area} , Δy_{Area}		≤ 2 GHz: ≤ 15 mm 2 – 3 GHz: ≤ 12 mm	3 – 4 GHz: ≤ 12 mm 4 – 6 GHz: ≤ 10 mm	
		When the x or y dimension of the test device, in the measurement plane orientation, is smaller than the above, the measurement resolution must be \leq the corresponding x or y dimension of the test device with at least one measurement point on the test device.		
Maximum zoom scan spatial resolution: Δx_{Zoom} , Δy_{Zoom}		≤ 2 GHz: ≤ 8 mm 2 – 3 GHz: ≤ 5 mm*	3 – 4 GHz: ≤ 5 mm* 4 – 6 GHz: ≤ 4 mm*	
Maximum zoom scan spatial resolution, normal to phantom surface	uniform grid: $\Delta z_{Zoom}(n)$	≤ 5 mm	3 – 4 GHz: ≤ 4 mm 4 – 5 GHz: ≤ 3 mm 5 – 6 GHz: ≤ 2 mm	
	graded grid	$\Delta z_{Zoom}(1)$: between 1 st two points closest to phantom surface	≤ 4 mm	3 – 4 GHz: ≤ 3 mm 4 – 5 GHz: ≤ 2.5 mm 5 – 6 GHz: ≤ 2 mm
		$\Delta z_{Zoom}(n>1)$: between subsequent points	$\leq 1.5 \cdot \Delta z_{Zoom}(n-1)$	
Minimum zoom scan volume	x, y, z	≥ 30 mm	3 – 4 GHz: ≥ 28 mm 4 – 5 GHz: ≥ 25 mm 5 – 6 GHz: ≥ 22 mm	
Note: δ is the penetration depth of a plane-wave at normal incidence to the tissue medium; see draft standard IEEE P1528-2011 for details. * When zoom scan is required and the <i>reported</i> SAR from the area scan based 1-g SAR estimation procedures of KDB 447498 is ≤ 1.4 W/kg, ≤ 8 mm, ≤ 7 mm and ≤ 5 mm zoom scan resolution may be applied, respectively, for 2 GHz to 3 GHz, 3 GHz to 4 GHz and 4 GHz to 6 GHz.				

9.3 WCDMA Measurement Procedures for SAR

The following procedures are applicable to WCDMA handsets operating under 3GPP Release99, Release 5 and Release 6. The default test configuration is to measure SAR with an established radio link between the DUT and a communication test set using a 12.2kbps RMC (reference measurement channel) configured in Test Loop Mode 1. SAR is selectively confirmed for other physical channel configurations (DPCCH & DPDCH_n), HSDPA and HSPA (HSUPA/HSDPA) modes according to output power, exposure conditions and device operating capabilities. Both uplink and downlink should be configured with the same RMC or AMR, when required. SAR for Release 5 HSDPA and Release 6 HSPA are measured using the applicable FRC (fixed reference channel) and E-DCH reference channel configurations. Maximum output power is verified according to applicable versions of 3GPP TS 34.121 and SAR must be measured according to these maximum output conditions. When Maximum Power Reduction (MPR) is not implemented according to Cubic Metric (CM) requirements for Release 6 HSPA, the following procedures do not apply.

For Release 5 HSDPA Data Devices:

Sub-test	β_c	β_d	β_d (SF)	β_c / β_d	β_{hs}	CM/dB
1	2/15	15/15	64	2/15	4/15	0.0
2	12/15	15/15	64	12/15	24/25	1.0
3	15/15	8/15	64	15/8	30/15	1.5
4	15/15	4/15	64	15/4	30/15	1.5

For Release 6 HSPA Data Devices

Sub-test	β_c	β_d	β_d (SF)	β_c / β_d	β_{hs}	β_{ec}	β_{ed}	β_{ed} (SF)	β_{ed} (codes)	CM (dB)	MPR (dB)	AG Index	E-TFCI
1	11/15	15/15	64	11/15	22/15	209/225	1039/225	4	1	1.5	1.5	20	75
2	6/15	15/15	64	6/15	12/15	12/15	12/15	4	1	1.5	1.5	12	67
3	15/15	9/15	64	15/9	30/15	30/15	$\beta_{ed1}:47/15$ $\beta_{ed2}:47/15$	4	2	1.5	1.5	15	92
4	2/15	15/15	64	2/15	4/15	4/15	56/75	4	1	1.5	1.5	17	71
5	15/15	15/15	64	15/15	24/15	30/15	134/15	4	1	1.5	1.5	21	81

Rel.8 DC-HSDPA (Cat 24)

SAR test exclusion for Rel.8 DC-HSDPA must satisfy the SAR test exclusion requirements of Rel.5 HSDPA. SAR test exclusion for DC-HSDPA devices is determined by power measurements according to the H-Set 12, Fixed Reference Channel (FRC) configuration in Table C.8.1.12 of 3GPP TS 34.121-1. A primary and a secondary serving HS-DSCH Cell are required to perform the power measurement and for the results to qualify for SAR test exclusion.

9.4 SAR Measurement for LTE

SAR tests for LTE are performed with a base station simulator, Rohde & Schwarz CMW500. Closed loop power control was used so the UE transmits with maximum output power during SAR testing. All powers were measured with the CMW 500.

It is performed for conducted power and SAR based on the KDB941225 D05.

SAR is evaluated separately according to the following procedures for the different test positions in each exposure condition – head, body, body-worn accessories and other use conditions. The procedures in the following subsections are applied separately to test each LTE frequency band.

1) QPSK with 1 RB allocation

Start with the largest channel bandwidth and measure SAR for QPSK with 1 RB allocation, using the RB offset and required test channel combination with the highest maximum output power among RB offsets at the upper edge, middle and lower edge of each required test channel. When the reported SAR is ≤ 0.8 W/kg, testing of the remaining RB offset configurations and required test channels is not required for 1 RB allocation; otherwise, SAR is required for the remaining required test channels and only for the RB offset configuration with the highest output power for that channel. When the reported SAR of a required test channel is > 1.45 W/kg, SAR is required for all three RB offset configurations for that required test channel.

2) QPSK with 50% RB allocation

The procedures required for 1 RB allocation in 1) are applied to measure the SAR for QPSK with 50% RB allocation.

3) QPSK with 100% RB allocation

For QPSK with 100% RB allocation, SAR is not required when the highest maximum output power for 100 % RB allocation is less than the highest maximum output power in 50% and 1 RB allocations and the highest reported SAR for 1 RB and 50% RB allocation in 1) and 2) are ≤ 0.8 W/kg. Otherwise, SAR is measured for the highest output power channel; and if the reported SAR is > 1.45 W/kg, the remaining required test channels must also be tested.

TDD test:

TDD testing is performed using guidance from FCC KDB 941225 D05 and the SAR test guidance provided in April 2013 TCB works hop notes. TDD is tested at the highest duty factor using UL-DL configuration 0 with special subframe configuration 6 and applying the FDD LTE procedures in KDB 941225 D05. SAR testing is performed using the extended cyclic prefix listed in 3GPP TS 36.211.

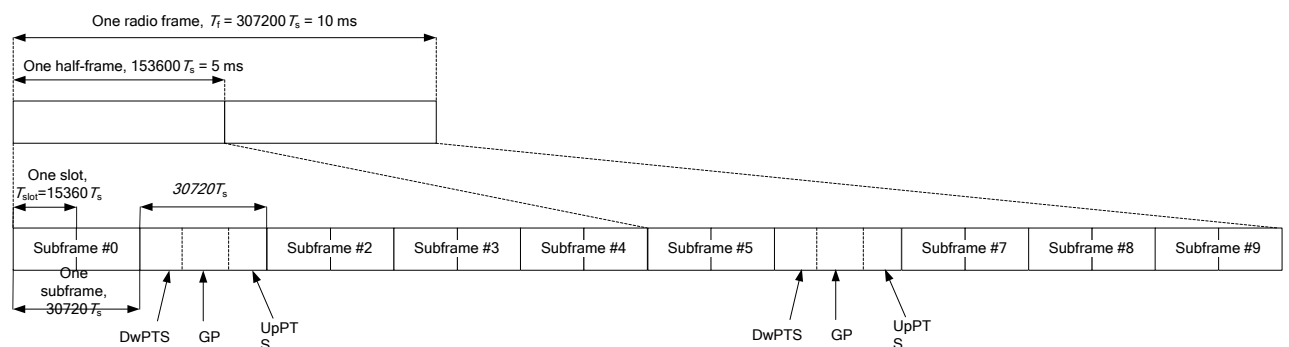

Figure 9.2: Frame structure type 2 (for 5 ms switch-point periodicity)

Table 9.1: Configuration of special subframe (lengths of DwPTS/GP/UpPTS)

Special subframe configuration	Normal cyclic prefix in downlink			Extended cyclic prefix in downlink		
	DwPTS	UpPTS		DwPTS	UpPTS	
		Normal cyclic prefix in uplink	Extended cyclic prefix in uplink		Normal cyclic prefix in uplink	Extended cyclic prefix in uplink
0	$6592 \cdot T_s$	$2192 \cdot T_s$	$2560 \cdot T_s$	$7680 \cdot T_s$	$2192 \cdot T_s$	$2560 \cdot T_s$
1	$19760 \cdot T_s$			$20480 \cdot T_s$		
2	$21952 \cdot T_s$			$23040 \cdot T_s$		
3	$24144 \cdot T_s$			$25600 \cdot T_s$		
4	$26336 \cdot T_s$	$4384 \cdot T_s$	$5120 \cdot T_s$	$7680 \cdot T_s$	$4384 \cdot T_s$	$5120 \cdot T_s$
5	$6592 \cdot T_s$			$20480 \cdot T_s$		
6	$19760 \cdot T_s$			$23040 \cdot T_s$		
7	$21952 \cdot T_s$			$12800 \cdot T_s$		
8	$24144 \cdot T_s$			-	-	-
9	$13168 \cdot T_s$			-	-	-

Table 9.2: Uplink-downlink configurations

Uplink-downlink configuration	Downlink-to-Uplink Switch-point periodicity	Subframe number										
		0	1	2	3	4	5	6	7	8	9	
0	5 ms	D	S	U	U	U	D	S	U	U	U	
1	5 ms	D	S	U	U	D	D	S	U	U	D	
2	5 ms	D	S	U	D	D	D	S	U	D	D	
3	10 ms	D	S	U	U	U	D	D	D	D	D	
4	10 ms	D	S	U	U	D	D	D	D	D	D	
5	10 ms	D	S	U	D	D	D	D	D	D	D	
6	5 ms	D	S	U	U	U	D	S	U	U	D	

Duty factor is calculated by:

Duty factor = uplink frame*6+UpPTS*2/one frame length

$$= (30720 \cdot T_s * 6 + 5120 \cdot T_s * 2) / 307200 \cdot T_s$$

$$= 0.633$$

9.5 Bluetooth & Wi-Fi Measurement Procedures for SAR

Normal network operating configurations are not suitable for measuring the SAR of 802.11 transmitters in general. Unpredictable fluctuations in network traffic and antenna diversity conditions can introduce undesirable variations in SAR results. The SAR for these devices should be measured using chipset based test mode software to ensure that the results are consistent and reliable.

Chipset based test mode software is hardware dependent and generally varies among manufacturers. The device operating parameters established in a test mode for SAR measurements must be identical to those programmed in production units, including output power levels, amplifier gain settings and other RF performance tuning parameters. The test frequencies should correspond to actual channel frequencies defined for domestic use. SAR for devices with switched diversity should be measured with only one antenna transmitting at a time during each SAR measurement, according to a fixed modulation and data rate. The same data pattern should be used for all measurements.

9.6 Power Drift

To control the output power stability during the SAR test, DASY4 system calculates the power drift by measuring the E-field at the same location at the beginning and at the end of the measurement for each test position. These drift values can be found in section14 labeled as: (Power Drift [dB]). This ensures that the power drift during one measurement is within 5%.

10 Area Scan Based 1-g SAR

10.1 Requirement of KDB

According to the KDB447498 D01 v06, when the implementation is based the specific polynomial fit algorithm as presented at the 29th Bioelectromagnetics Society meeting (2007) and the estimated 1-gSAR is ≤ 1.2 W/kg, a zoom scan measurement is not required provided it is also not needed for any other purpose; for example, if the peak SAR location required for simultaneous transmission SAR test exclusion can be determined accurately by the SAR system or manually to discriminate between distinctive peaks and scattered noisy SAR distributions from area scans.

There must not be any warning or alert messages due to various measurement concerns identified by the SAR system; for example, noise in measurements, peaks too close to scan boundary, peaks are too sharp, spatial resolution and uncertainty issues etc. The SAR system verification must also demonstrate that the area scan estimated 1-g SAR is within 3% of the zoom scan 1-g SAR (See Annex B). When all the SAR results for each exposure condition in a frequency band and wireless mode are based on estimated 1-g SAR, the 1-g SAR for the highest SAR configuration must be determined by a zoom scan.

10.2 Fast SAR Algorithms

The approach is based on the area scan measurement applying a frequency dependent attenuation parameter. This attenuation parameter was empirically determined by analyzing a large number of phones. The MOTOROLA FAST SAR was developed and validated by the MOTOROLA Research Group in Ft. Lauderdale.

In the initial study, an approximation algorithm based on Linear fit was developed. The accuracy of the algorithm has been demonstrated across a broad frequency range (136-2450 MHz) and for both 1- and 10-g averaged SAR using a sample of 264 SAR measurements from 55 wireless handsets. For the sample size studied, the root-mean-squared errors of the algorithm are 1.2% and 5.8% for 1- and 10-g averaged SAR, respectively. The paper describing the algorithm in detail is expected to be published in August 2004 within the Special Issue of Transactions on MTT.

In the second step, the same research group optimized the fitting algorithm to an Polynomial fit whereby the frequency validity was extended to cover the range 30-6000MHz. Details of this study can be found in the BEMS 2007 Proceedings.

Both algorithms are implemented in DASYS software.

11 Conducted Output Power

Table: Summary of Receiver detection mechanism

Antenna	Receiver on (head scenario)	Receiver off (Body scenario)	Sensor on (Body scenario)
Main antenna	Power Level A1	Power Level B1	Power Level C1

11.1 GSM Measurement result

During the process of testing, the EUT was controlled via Agilent Digital Radio Communication tester (E5515C) to ensure the maximum power transmission and proper modulation. This result contains conducted output power for the EUT. In all cases, the measured peak output power should be greater and within 5% than EMI measurement.

Table 11.1-1: The conducted power measurement results for GSM, GPRS and EGPRS- Level A1/B1/C1

GSM 850 Speech (GMSK)	Measured Power (dBm)			Tune up	calculation	Averaged Power (dBm)		
	251	190	128			251	190	128
1 Txslot	32.77	32.78	32.64	33.00	/	/	/	/
GSM 850 GPRS (GMSK)	Measured Power (dBm)				calculation	Averaged Power (dBm)		
	251	190	128			251	190	128
1 Txslot	32.77	32.75	32.60	33.00	-9.03	23.74	23.72	23.57
2 Txslots	30.89	30.88	31.20	32.00	-6.02	24.87	24.86	25.18
3Txslots	28.84	28.79	28.98	30.00	-4.26	24.58	24.53	24.72
4 Txslots	26.73	26.73	26.95	28.00	-3.01	23.72	23.72	23.94
GSM 850 EGPRS (GMSK)	Measured Power (dBm)				calculation	Averaged Power (dBm)		
	251	190	128			251	190	128
1 Txslot	32.79	32.73	32.64	34.00	-9.03	23.76	23.70	23.61
2 Txslots	30.90	30.85	31.18	32.00	-6.02	24.88	24.83	25.16
3Txslots	28.84	28.82	28.97	30.00	-4.26	24.58	24.56	24.71
4 Txslots	26.68	26.95	26.93	28.00	-3.01	23.67	23.94	23.92
GSM 850 EGPRS (8PSK)	Measured Power (dBm)				calculation	Averaged Power (dBm)		
	251	190	128			251	190	128
1 Txslot	26.76	26.58	26.62	27.50	-9.03	17.73	17.55	17.59
2 Txslots	25.33	25.30	25.35	26.50	-6.02	19.31	19.28	19.33
3Txslots	24.02	24.45	24.18	25.50	-4.26	19.76	20.19	19.92
4 Txslots	23.17	22.34	22.36	23.50	-3.01	20.16	19.33	19.35

NOTES:

1) Division Factors

To average the power, the division factor is as follows:

1TX-slot = 1 transmit time slot out of 8 time slots=> conducted power divided by (8/1) => -9.03dB

2TX-slots = 2 transmit time slots out of 8 time slots=> conducted power divided by (8/2) => -6.02dB

3TX-slots = 3 transmit time slots out of 8 time slots=> conducted power divided by (8/3) => -4.26dB

4TX-slots = 4 transmit time slots out of 8 time slots=> conducted power divided by (8/4) => -3.01dB

According to the conducted power as above, the body measurements are performed with 2Txslots for GSM850.

Table 11.1-2: The conducted power measurement results for GSM, GPRS and EGPRS- Level A1/C1

PCS1900 Speech (GMSK)	Measured Power (dBm)			Tune up	calculation	Averaged Power (dBm)		
	810	661	512			810	661	512
1 Txslot	22.01	22.15	22.35	23.50	/	/	/	/
PCS1900 GPRS (GMSK)	Measured Power (dBm)				calculation	Averaged Power (dBm)		
	810	661	512			810	661	512
1 Txslot	22.11	22.15	22.40	23.50	-9.03	13.08	13.12	13.37
2 Txslots	20.25	20.44	20.51	21.50	-6.02	14.23	14.42	14.49
3Txslots	17.86	18.11	18.30	19.00	-4.26	13.60	13.85	14.04
4 Txslots	15.47	15.73	15.97	16.50	-3.01	12.46	12.72	12.96
PCS1900 EGPRS (GMSK)	Measured Power (dBm)				calculation	Averaged Power (dBm)		
	810	661	512			810	661	512
1 Txslot	21.97	22.13	22.36	23.50	-9.03	12.94	13.10	13.33
2 Txslots	20.13	20.41	20.47	21.50	-6.02	14.11	14.39	14.45
3Txslots	17.89	18.18	18.27	19.00	-4.26	13.63	13.92	14.01
4 Txslots	15.49	15.68	15.82	16.50	-3.01	12.48	12.67	12.81
PCS1900 EGPRS (8PSK)	Measured Power (dBm)				calculation	Averaged Power (dBm)		
	810	661	512			810	661	512
1 Txslot	21.92	22.25	22.40	23.00	-9.03	12.89	13.22	13.37
2 Txslots	18.56	18.91	19.19	20.50	-6.02	12.54	12.89	13.17
3Txslots	18.29	18.70	18.85	20.00	-4.26	14.03	14.44	14.59
4 Txslots	17.02	17.23	17.31	18.00	-3.01	14.01	14.22	14.30

NOTES:

1) Division Factors

To average the power, the division factor is as follows:

1TX-slot = 1 transmit time slot out of 8 time slots=> conducted power divided by (8/1) => -9.03dB

2TX-slots = 2 transmit time slots out of 8 time slots=> conducted power divided by (8/2) => -6.02dB

3TX-slots = 3 transmit time slots out of 8 time slots=> conducted power divided by (8/3) => -4.26dB

4TX-slots = 4 transmit time slots out of 8 time slots=> conducted power divided by (8/4) => -3.01dB

According to the conducted power as above, the body measurements are performed with 2Txslots for GSM1900.

Table 11.1-3: The conducted power measurement results for GSM, GPRS and EGPRS- Level B1

PCS1900 Speech (GMSK)	Measured Power (dBm)			Tune up	calculation	Averaged Power (dBm)		
	810	661	512			810	661	512
1 Txslot	30.76	30.96	31.04	31.50	/	/	/	/
PCS1900 GPRS (GMSK)	Measured Power (dBm)				calculation	Averaged Power (dBm)		
	810	661	512			810	661	512
1 Txslot	30.77	30.93	31.43	31.50	-9.03	21.74	21.90	22.40
2 Txslots	28.57	28.79	28.84	29.50	-6.02	22.55	22.77	22.82
3Txslots	26.70	26.96	27.06	28.00	-4.26	22.44	22.70	22.80
4 Txslots	24.35	24.65	24.83	25.50	-3.01	21.34	21.64	21.82
PCS1900 EGPRS (GMSK)	Measured Power (dBm)				calculation	Averaged Power (dBm)		
	810	661	512			810	661	512
1 Txslot	31.24	31.42	31.45	31.50	-9.03	22.21	22.39	22.42
2 Txslots	28.51	28.80	28.87	29.50	-6.02	22.49	22.78	22.85
3Txslots	26.65	26.96	27.06	28.00	-4.26	22.39	22.70	22.80
4 Txslots	24.37	24.70	24.80	25.50	-3.01	21.36	21.69	21.79
PCS1900 EGPRS (8PSK)	Measured Power (dBm)				calculation	Averaged Power (dBm)		
	810	661	512			810	661	512
1 Txslot	26.00	26.35	26.61	27.00	-9.03	16.97	17.32	17.58
2 Txslots	24.30	24.80	24.85	25.50	-6.02	18.28	18.78	18.83
3Txslots	23.27	23.43	23.58	24.00	-4.26	19.01	19.17	19.32
4 Txslots	20.50	20.85	21.05	22.00	-3.01	17.49	17.84	18.04

NOTES:

1) Division Factors

To average the power, the division factor is as follows:

1TX-slot = 1 transmit time slot out of 8 time slots=> conducted power divided by (8/1) => -9.03dB

2TX-slots = 2 transmit time slots out of 8 time slots=> conducted power divided by (8/2) => -6.02dB

3TX-slots = 3 transmit time slots out of 8 time slots=> conducted power divided by (8/3) => -4.26dB

4TX-slots = 4 transmit time slots out of 8 time slots=> conducted power divided by (8/4) => -3.01dB

According to the conducted power as above, the body measurements are performed with 2Txslots for GSM1900.

11.2 WCDMA Measurement result

Table 11.2-1: The conducted Power for WCDMA- Level A1/B1/C1

Item	band	FDDV result			
	ARFCN	4233 (846.6MHz)	4182 (836.4MHz)	4132 (826.4MHz)	Tune up
WCDMA	\	24.06	24.09	23.76	25.00
HSUPA	1	22.97	22.98	22.46	24.00
	2	20.95	20.99	20.51	22.00
	3	21.95	21.99	21.52	23.00
	4	20.96	21.00	20.50	22.00
	5	23.05	23.02	22.48	24.00
DC-HSDPA	1	22.93	22.92	22.41	24.00
	2	22.94	22.90	22.43	24.00
	3	22.44	22.43	21.91	23.50
	4	22.43	22.42	21.88	23.50

Table 11.2-2: The conducted Power for WCDMA- Level A1

Item	band	FDDIV result			
	ARFCN	1513 (1752.6MHz)	1412(1732.4MHz)	1312 (1712.4MHz)	Tune up
WCDMA	\	18.51	18.54	18.39	19.50
HSUPA	1	17.53	17.64	17.44	18.50
	2	15.52	15.56	15.37	16.50
	3	16.51	16.59	16.35	17.50
	4	15.52	15.55	15.30	16.50
	5	17.43	17.56	17.33	18.50
DC-HSDPA	1	17.51	17.54	17.32	18.50
	2	17.55	17.55	17.34	18.50
	3	17.04	17.12	16.82	18.00
	4	17.03	17.09	16.80	18.00
Item	band	FDDII result			
	ARFCN	9538 (1907.6MHz)	9400 (1880MHz)	9262 (1852.4MHz)	Tune up
WCDMA	\	18.33	18.44	18.41	19.50
HSUPA	1	17.31	17.63	17.46	18.50
	2	15.37	15.58	15.42	16.50
	3	16.32	16.55	16.38	17.50
	4	15.38	15.51	15.34	16.50
	5	17.24	17.40	17.31	18.50
DC-HSDPA	1	17.42	17.55	17.37	18.50
	2	17.3	17.52	17.35	18.50
	3	16.77	17.01	16.84	18.00
	4	16.87	17.00	16.82	18.00

Table 11.2-3: The conducted Power for WCDMA- Level B1

Item	band	FDDIV result			
	ARFCN	1513 (1752.6MHz)	1412(1732.4MHz)	1312 (1712.4MHz)	Tune up
WCDMA	\	24.66	24.72	24.49	25.50
HSUPA	1	23.72	23.63	23.27	24.00
	2	21.69	21.54	21.28	22.00
	3	22.66	22.61	22.32	23.00
	4	21.66	21.57	21.29	22.00
	5	23.74	23.66	23.30	24.00
DC-HSDPA	1	23.61	23.63	23.40	24.00
	2	23.6	23.58	23.43	24.00
	3	23.09	23.08	22.94	23.50
	4	23.08	23.06	22.91	23.50
Item	band	FDDII result			
	ARFCN	9538 (1907.6MHz)	9400 (1880MHz)	9262 (1852.4MHz)	Tune up
WCDMA	\	24.47	24.73	24.57	25.50
HSUPA	1	23.46	23.72	23.44	24.00
	2	21.44	21.71	21.40	22.00
	3	22.33	22.65	22.42	23.00
	4	21.39	21.59	21.41	22.00
	5	23.48	23.64	23.51	24.00
DC-HSDPA	1	23.48	23.66	23.50	24.00
	2	23.34	23.66	23.55	24.00
	3	22.92	23.14	23.00	23.50
	4	23	23.14	22.99	23.50

Table 11.2-3: The conducted Power for WCDMA- Level C1

Item	band	FDDIV result			
	ARFCN	1513 (1752.6MHz)	1412(1732.4MHz)	1312 (1712.4MHz)	Tune up
WCDMA	\	21.49	21.51	21.42	22.50
HSUPA	1	20.63	20.66	20.31	21.50
	2	18.63	18.64	18.43	19.50
	3	19.71	19.64	19.34	20.50
	4	18.53	18.55	18.32	19.50
	5	20.66	20.68	20.52	21.50
DC-HSDPA	1	20.48	20.60	20.38	21.50
	2	20.5	20.60	20.42	21.50
	3	19.99	20.08	19.86	21.00
	4	20.02	20.06	19.92	21.00
Item	band	FDDII result			
	ARFCN	9538 (1907.6MHz)	9400 (1880MHz)	9262 (1852.4MHz)	Tune up
WCDMA	\	20.82	20.98	21.05	22.00
HSUPA	1	19.83	20.06	19.89	21.00

	2	17.74	18.01	17.83	19.00
	3	18.8	18.95	18.91	20.00
	4	17.76	17.98	17.89	19.00
	5	19.77	20.06	19.92	21.00
DC-HSDPA	1	19.79	19.97	19.93	21.00
	2	19.81	20.00	19.95	21.00
	3	19.37	19.43	19.47	20.50
	4	19.35	19.41	19.43	20.50

11.3 CDMA Measurement result

Table 11.3-1: The conducted Power for CDMA- Level A1/B1/C1

Mode	CDMA BC0			
	777 (848.31MHz)	384 (836.52MHz)	1013 (824.7MHz)	Tune up
SO55/RC3	24.95	24.98	25.05	25.50
SO55/RC1	24.97	25.01	25.06	25.50
SO32/RC3(FCH only)	24.94	24.96	25.01	25.50
SO32/RC3(FCH+SCH _n)	24.92	24.95	25.02	25.50
EVDO Rev.0	23.83	23.81	23.92	25.50
EVDO Rev.A	23.78	23.80	23.89	25.50
Mode	CDMA BC10			
	684 (823.1MHz)	580 (820.5MHz)	476(817.9MHz)	Tune up
SO55/RC3	24.94	25.08	25.07	25.50
SO55/RC1	24.98	25.12	25.09	25.50
SO32/RC3(FCH only)	24.97	25.10	25.03	25.50
SO32/RC3(FCH+SCH _n)	24.93	25.05	25.00	25.50
EVDO Rev.0	23.87	23.84	23.92	25.50
EVDO Rev.A	23.82	23.83	23.87	25.50

Table 11.3-2: The conducted Power for CDMA- Level A1/C1

Mode	CDMA BC1			Tune up
	1175 (1908.75MHz)	600 (1880MHz)	25 (1851.25MHz)	
SO55/RC3	19.17	19.26	19.29	19.50
SO55/RC1	19.23	19.35	19.34	19.50
SO32/RC3(FCH only)	19.13	19.27	19.28	19.50
SO32/RC3(FCH+SCH _n)	19.15	19.30	19.25	19.50
EVDO Rev.0	18.27	18.22	18.21	19.50
EVDO Rev.A	18.36	18.27	18.31	19.50

Table 11.3-3: The conducted Power for CDMA- Level B1

Mode	CDMA BC1			
	1175 (1908.75MHz)	600 (1880MHz)	25 (1851.25MHz)	Tune up
SO55/RC3	25.04	25.17	25.16	25.50
SO55/RC1	25.11	25.21	25.22	25.50
SO32/RC3(FCH only)	25.03	25.16	25.20	25.50
SO32/RC3(FCH+SCH _n)	25.02	25.15	25.16	25.50
EVDO Rev.0	23.78	23.81	23.85	25.50
EVDO Rev.A	23.73	23.83	23.81	25.50

Table 11.3-4: The conducted Power for CDMA- Level A1/B1

Mode	CDMA BC10			
	684 (823.1MHz)	580 (820.5MHz)	476(817.9MHz)	Tune up
SO55/RC3	24.94	25.08	25.07	25.50
SO55/RC1	24.98	25.12	25.09	25.50
SO32/RC3(FCH only)	24.97	25.10	25.03	25.50
SO32/RC3(FCH+SCH _n)	24.93	25.05	25.00	25.50
EVDO Rev.0	23.87	23.84	23.92	25.50
EVDO Rev.A	23.82	23.83	23.87	25.50

Table 11.3-5: The conducted Power for CDMA- Level C1

Mode	CDMA BC10			
	684 (823.1MHz)	580 (820.5MHz)	476(817.9MHz)	Tune up
SO55/RC3	24.07	24.23	24.15	24.50
SO55/RC1	24.06	24.24	24.12	24.50
SO32/RC3(FCH only)	24.04	24.20	24.13	24.50
SO32/RC3(FCH+SCH _n)	24.01	24.19	24.17	24.50
EVDO Rev.0	24.02	24.09	24.10	24.50
EVDO Rev.A	24.01	24.04	24.02	24.50

11.4 LTE Measurement result

Table 13.3-1: Maximum Power Reduction (MPR) for LTE

Modulation	Channel bandwidth / Transmission bandwidth configuration [RB]						MPR (dB)
	1.4 MHz	3 MHz	5 MHz	10 MHz	15 MHz	20 MHz	
QPSK	> 5	> 4	> 8	> 12	> 16	> 18	1
16 QAM	≤ 5	≤ 4	≤ 8	≤ 12	≤ 16	≤ 18	1
16 QAM	> 5	> 4	> 8	> 12	> 16	> 18	2
64 QAM	≤ 5	≤ 4	≤ 8	≤ 12	≤ 16	≤ 18	2
64 QAM	> 5	> 4	> 8	> 12	> 16	> 18	3

Table 13.3-2: The tune up for LTE –Level A1/C1

Band	Tune up
LTE Band 7	24
LTE Band 71	25.5

Table 13.3-3: The tune up for LTE –Level B1

Band	Tune up
LTE Band 7	22
LTE Band 71	23.5

Table 13.3-4: The tune up for LTE – Level A1

Band	Tune up
LTE Band 25	20
LTE Band 41(PC2)	18
LTE Band 41(PC3)	18
LTE Band 66	19.5

Table 13.3-5: The tune up for LTE – Level B1

Band	Tune up
LTE Band 25	25.5
LTE Band 41(PC2)	28.7
LTE Band 41(PC3)	25
LTE Band 66	25.5

Table 13.3-6: The tune up for LTE – Level C1

Band	Tune up
LTE Band 25	21.5
LTE Band 41(PC2)	22
LTE Band 41(PC3)	22
LTE Band 66	22.5

Table 13.3-2: The tune up for LTE – Normal Power

Band	Tune up
LTE Band 12	25.5
LTE Band 13	25.5
LTE Band 26	25.5

Power Level A1/C1

Band 7						
Bandwidth (MHz)	RB allocation	Frequency (MHz)	QPSK	16QAM	64QAM	
	RB offset (Start RB)		Actual output power (dBm)	Actual output power (dBm)	Actual output power (dBm)	
5 MHz	1RB High (24)	2567.5	20.99	20.16	19.16	
		2535	21.08	20.15	19.21	
		2502.5	20.94	20.54	19.22	
	1RB Middle (12)	2567.5	20.95	20.13	19.02	
		2535	21.08	20.11	19.11	
		2502.5	20.78	20.54	19.16	
	1RB Low (0)	2567.5	21.07	20.22	19.28	
		2535	21.13	20.18	19.37	
		2502.5	21.13	20.68	19.53	
	12RB High (13)	2567.5	19.99	18.97	17.88	
		2535	20.02	19.11	18.18	
		2502.5	20.13	19.26	18.29	
	12RB Middle (6)	2567.5	20.02	19.05	17.97	
		2535	19.99	19.09	18.18	
		2502.5	20.07	19.24	18.23	
	12RB Low (0)	2567.5	20.06	19.10	18.00	
		2535	20.08	19.14	18.32	
		2502.5	20.18	19.31	18.27	
	25RB (0)	2567.5	20.01	18.96	17.95	
		2535	19.98	19.05	18.23	
		2502.5	20.11	19.18	18.16	
	10 MHz	1RB High (49)	2565	21.06	19.98	19.51
			2535	21.08	19.96	19.42
			2505	21.21	20.57	19.42
1RB Middle (24)		2565	20.93	19.90	19.17	
		2535	20.94	19.82	19.14	
		2505	21.06	20.43	19.31	
1RB Low (0)		2565	21.19	20.16	19.52	
		2535	21.18	20.10	19.62	
		2505	21.34	20.74	19.59	
25RB High (25)		2565	19.87	19.02	17.95	
		2535	19.87	18.94	18.02	
		2505	20.01	19.09	18.17	
25RB Middle		2565	20.00	19.08	17.86	
		2535	19.98	19.01	18.12	

	(12)	2505	20.09	19.11	18.13	
	25RB Low (0)	2565	20.00	19.12	18.01	
		2535	20.02	18.98	18.08	
		2505	20.15	19.22	18.18	
	50RB (0)	2565	20.04	19.09	17.94	
		2535	20.01	19.00	18.13	
2505		20.11	19.13	18.17		
15 MHz	1RB High (74)	2562.5	20.91	20.32	19.05	
		2535	21.10	20.44	19.41	
		2507.5	21.24	20.15	19.56	
	1RB Middle (37)	2562.5	21.01	20.42	19.16	
		2535	21.19	20.52	19.47	
		2507.5	21.39	20.21	19.57	
	1RB Low (0)	2562.5	21.07	20.47	19.29	
		2535	21.15	20.46	19.49	
		2507.5	21.31	20.17	19.51	
	36RB High (38)	2562.5	20.09	19.11	17.87	
		2535	20.24	19.21	18.37	
		2507.5	20.42	19.44	18.49	
	36RB Middle (19)	2562.5	20.08	19.13	17.98	
		2535	20.20	19.23	18.35	
		2507.5	20.39	19.43	18.50	
	36RB Low (0)	2562.5	20.06	19.08	18.02	
		2535	20.23	19.17	18.45	
		2507.5	20.36	19.35	18.43	
	75RB (0)	2562.5	20.01	19.09	17.96	
		2535	20.26	19.22	18.36	
		2507.5	20.33	19.32	18.43	
	20 MHz	1RB High (99)	2560	20.68	20.36	19.91
			2535	21.01	20.52	19.84
			2510	21.18	20.59	19.79
1RB Middle (50)		2560	20.86	20.59	19.92	
		2535	21.08	20.46	19.77	
		2510	21.29	20.77	19.72	
1RB Low (0)		2560	20.78	20.50	19.93	
		2535	21.05	20.55	19.94	
		2510	21.21	20.70	19.85	
50RB High (50)		2560	20.01	19.06	18.89	
		2535	20.21	19.26	18.94	
		2510	20.33	19.32	18.94	
50RB Middle (25)		2560	20.10	19.15	19.00	
		2535	20.13	19.21	18.92	
		2510	20.37	19.38	18.95	
50RB Low (0)		2560	20.12	19.18	18.82	
		2535	20.16	19.23	18.86	
		2510	20.33	19.33	18.74	
100RB (0)		2560	20.09	19.09	18.99	
		2535	20.19	19.23	18.92	

		2510	20.31	19.35	18.94
--	--	------	-------	-------	-------

Power Level B1

Band 7						
Bandwidth (MHz)	RB allocation	Frequency (MHz)	QPSK	16QAM	64QAM	
	RB offset (Start RB)		Actual output power (dBm)	Actual output power (dBm)	Actual output power (dBm)	
5 MHz	1RB High (24)	2567.5	23.12	22.27	21.33	
		2535	23.25	22.29	21.44	
		2502.5	23.31	22.75	21.52	
	1RB Middle (12)	2567.5	23.16	22.24	21.17	
		2535	23.21	22.26	21.55	
		2502.5	23.16	22.70	21.44	
	1RB Low (0)	2567.5	23.24	22.30	21.44	
		2535	23.34	22.38	21.63	
		2502.5	23.45	22.87	21.69	
	12RB High (13)	2567.5	22.14	21.14	20.07	
		2535	22.18	21.27	20.47	
		2502.5	22.33	21.51	20.47	
	12RB Middle (6)	2567.5	22.16	21.18	20.17	
		2535	22.16	21.24	20.42	
		2502.5	22.28	21.45	20.41	
	12RB Low (0)	2567.5	22.19	21.23	20.22	
		2535	22.25	21.27	20.45	
		2502.5	22.37	21.51	20.58	
	25RB (0)	2567.5	22.11	21.07	20.16	
		2535	22.20	21.23	20.35	
		2502.5	22.31	21.35	20.01	
	10 MHz	1RB High (49)	2565	23.19	22.17	21.45
			2535	23.32	22.19	21.61
			2505	23.32	22.73	21.81
1RB Middle (24)		2565	23.08	22.08	21.23	
		2535	23.11	21.99	21.39	
		2505	23.16	22.58	21.56	
1RB Low (0)		2565	23.36	22.37	21.60	
		2535	23.43	22.38	21.99	
		2505	23.58	22.82	21.92	
25RB High (25)		2565	22.17	21.20	20.11	
		2535	22.08	21.14	20.29	
		2505	22.23	21.31	20.41	
25RB Middle (12)		2565	22.13	21.20	20.13	
		2535	22.19	21.21	20.39	
		2505	22.32	21.34	20.42	
25RB Low (0)		2565	22.13	21.26	20.09	
		2535	22.30	21.23	20.49	
		2505	22.36	21.37	20.42	
50RB		2565	22.19	21.17	20.13	

	(0)	2535	22.19	21.16	20.35
		2505	22.30	21.38	20.44
15 MHz	1RB High (74)	2562.5	23.11	22.50	21.18
		2535	23.30	22.52	21.58
		2507.5	23.47	22.41	21.88
	1RB Middle (37)	2562.5	23.19	22.55	21.34
		2535	23.35	22.58	21.71
		2507.5	23.54	22.47	21.92
	1RB Low (0)	2562.5	23.18	22.54	21.49
		2535	23.28	22.49	21.73
		2507.5	23.51	22.47	21.86
	36RB High (38)	2562.5	22.23	21.23	20.10
		2535	22.36	21.32	20.64
		2507.5	22.70	21.64	20.87
	36RB Middle (19)	2562.5	22.21	21.28	20.11
		2535	22.40	21.34	20.62
		2507.5	22.62	21.65	20.85
	36RB Low (0)	2562.5	22.25	21.20	20.26
		2535	22.33	21.27	20.67
		2507.5	22.64	21.61	20.77
	75RB (0)	2562.5	22.22	21.20	20.18
		2535	22.32	21.28	20.66
		2507.5	22.61	21.57	20.77
20 MHz	1RB High (99)	2560	23.16	22.64	21.84
		2535	23.42	22.80	22.00
		2510	23.43	22.91	21.94
	1RB Middle (50)	2560	23.19	22.74	21.94
		2535	23.51	22.82	21.93
		2510	23.62	22.89	21.95
	1RB Low (0)	2560	23.29	22.72	21.92
		2535	23.48	22.78	21.98
		2510	23.52	22.91	21.95
	50RB High (50)	2560	22.34	21.33	20.53
		2535	22.43	21.41	20.61
		2510	22.64	21.67	20.87
	50RB Middle (25)	2560	22.41	21.39	20.59
		2535	22.55	21.54	20.74
		2510	22.75	21.77	20.97
	50RB Low (0)	2560	22.32	21.32	20.52
		2535	22.55	21.53	20.73
		2510	22.74	21.71	20.91
	100RB (0)	2560	22.29	21.26	20.46
		2535	22.51	21.52	20.72
		2510	22.70	21.72	20.92

Power Level A1/B1/C1

Band 12						
Bandwidth (MHz)	RB allocation	Frequency (MHz)	QPSK	16QAM	64QAM	
	RB offset (Start RB)		Actual output power (dBm)	Actual output power (dBm)	Actual output power (dBm)	
1.4 MHz	1RB High (5)	715.3	23.77	23.33	23.06	
		707.5	23.73	23.32	22.80	
		699.7	23.56	23.48	22.47	
	1RB Middle (3)	715.3	23.88	23.34	23.02	
		707.5	23.73	23.31	22.60	
		699.7	23.65	23.45	22.46	
	1RB Low (0)	715.3	23.66	23.29	23.12	
		707.5	23.71	23.28	22.78	
		699.7	23.55	23.46	22.62	
	3RB High (3)	715.3	23.86	23.54	22.83	
		707.5	23.74	23.28	22.68	
		699.7	23.58	23.13	22.32	
	3RB Middle (1)	715.3	23.76	23.47	22.93	
		707.5	23.66	23.29	22.63	
		699.7	23.52	23.25	22.60	
	3RB Low (0)	715.3	23.76	23.52	22.87	
		707.5	23.61	23.21	22.59	
		699.7	23.54	23.17	22.30	
	6RB (0)	715.3	23.42	22.56	21.75	
		707.5	23.20	22.34	21.58	
		699.7	22.98	21.96	21.41	
	3 MHz	1RB High (14)	714.5	23.74	23.38	22.87
			707.5	23.78	23.14	22.72
			700.5	23.60	23.53	22.67
		1RB Middle (7)	714.5	23.74	23.44	22.94
			707.5	23.73	23.17	22.77
			700.5	23.63	23.49	22.56
1RB Low (0)		714.5	23.78	23.45	22.96	
		707.5	23.61	23.05	22.81	
		700.5	23.56	23.49	22.58	
8RB High (7)		714.5	23.41	22.43	21.87	
		707.5	23.29	22.37	21.68	
		700.5	23.12	22.21	21.45	
8RB Middle (4)		714.5	23.41	22.49	21.90	
		707.5	23.25	22.35	21.66	
		700.5	23.14	22.29	21.48	
8RB Low (0)		714.5	23.35	22.44	21.88	
		707.5	23.26	22.38	21.75	
		700.5	23.07	22.22	21.50	
15RB (0)		714.5	23.38	22.38	22.01	
		707.5	23.34	22.38	21.69	
		700.5	23.12	22.17	21.51	

5 MHz	1RB High (24)	713.5	23.93	23.52	22.90	
		707.5	23.78	23.38	22.79	
		701.5	23.66	23.67	22.66	
	1RB Middle (12)	713.5	23.83	23.55	22.97	
		707.5	23.73	23.28	22.81	
		701.5	23.62	23.67	22.76	
	1RB Low (0)	713.5	23.87	23.46	22.98	
		707.5	23.76	23.29	22.76	
		701.5	23.64	23.61	22.68	
	12RB High (13)	713.5	23.43	22.25	21.70	
		707.5	23.20	22.25	21.59	
		701.5	23.27	22.46	21.63	
	12RB Middle (6)	713.5	23.38	22.44	21.79	
		707.5	23.26	22.30	21.70	
		701.5	23.24	22.47	21.69	
	12RB Low (0)	713.5	23.39	22.39	21.88	
		707.5	23.26	22.30	21.71	
		701.5	23.20	22.43	21.64	
	25RB (0)	713.5	23.38	22.32	21.88	
		707.5	23.31	22.31	21.75	
		701.5	23.30	22.35	21.56	
	10 MHz	1RB High (49)	711	24.00	23.35	23.15
			707.5	23.81	23.25	22.84
			704	23.77	23.79	22.84
1RB Middle (24)		711	23.70	23.21	22.86	
		707.5	23.56	23.01	22.65	
		704	23.63	23.59	22.74	
1RB Low (0)		711	23.99	23.45	23.08	
		707.5	23.98	23.34	23.04	
		704	23.82	23.78	23.33	
25RB High (25)		711	23.29	22.48	21.91	
		707.5	23.16	22.26	21.64	
		704	23.31	22.37	21.71	
25RB Middle (12)		711	23.32	22.56	21.84	
		707.5	23.36	22.28	21.71	
		704	23.27	22.32	21.63	
25RB Low (0)		711	23.34	22.49	21.78	
		707.5	23.37	22.23	21.57	
		704	23.30	22.41	21.74	
50RB (0)		711	23.34	22.46	21.80	
		707.5	23.32	22.24	21.74	
		704	23.35	22.43	21.73	

Power Level A1/B1/C1

Band 13					
Bandwidth (MHz)	RB allocation	Frequency (MHz)	QPSK	16QAM	64QAM
	RB offset (Start RB)		Actual output power (dBm)	Actual output power (dBm)	Actual output power (dBm)
5 MHz	1RB High (24)	784.5	24.61	23.55	22.88
		782	24.39	23.43	22.73
		779.5	24.48	23.86	22.71
	1RB Middle (12)	784.5	24.37	23.58	22.86
		782	24.40	23.47	22.87
		779.5	24.38	23.69	22.78
	1RB Low (0)	784.5	24.59	23.63	23.17
		782	24.44	23.55	22.85
		779.5	24.57	23.69	22.68
	12RB High (13)	784.5	23.64	22.67	21.94
		782	23.44	22.57	21.79
		779.5	23.41	22.60	21.70
	12RB Middle (6)	784.5	23.63	22.69	21.93
		782	23.44	22.62	21.80
		779.5	23.42	22.61	21.68
	12RB Low (0)	784.5	23.65	22.68	21.94
		782	23.46	22.60	21.76
		779.5	23.44	22.58	21.62
	25RB (0)	784.5	23.62	22.59	21.91
		782	23.42	22.50	21.80
		779.5	23.39	22.49	21.63
10 MHz	1RB High (49)	782	24.63	23.52	22.92
	1RB Middle (24)	782	24.46	23.31	22.86
	1RB Low (0)	782	24.73	23.51	22.99
	25RB High (25)	782	23.48	22.43	21.64
	25RB Middle (12)	782	23.48	22.52	21.72
	25RB Low (0)	782	23.69	22.55	21.88
	50RB (0)	782	23.52	22.51	21.90

Power Level A1

Band 25						
Bandwidth (MHz)	RB allocation	Frequency (MHz)	QPSK	16QAM	64QAM	
	RB offset (Start RB)		Actual output power (dBm)	Actual output power (dBm)	Actual output power (dBm)	
1.4 MHz	1RB High (5)	1914.3	18.79	17.82	16.98	
		1882.5	18.95	18.02	17.08	
		1850.7	19.10	18.47	17.22	
	1RB Middle (3)	1914.3	18.78	17.78	17.04	
		1882.5	18.98	18.02	16.96	
		1850.7	19.13	18.53	17.12	
	1RB Low (0)	1914.3	18.75	17.76	16.96	
		1882.5	18.95	18.01	17.01	
		1850.7	19.09	18.57	17.22	
	3RB High (3)	1914.3	18.81	18.03	16.89	
		1882.5	18.91	17.99	16.80	
		1850.7	19.06	18.16	17.00	
	3RB Middle (1)	1914.3	18.78	18.03	16.94	
		1882.5	18.94	17.97	16.97	
		1850.7	19.12	18.26	17.13	
	3RB Low (0)	1914.3	18.74	18.04	16.95	
		1882.5	18.88	17.92	16.92	
		1850.7	19.09	18.21	17.03	
	6RB (0)	1914.3	17.80	16.95	15.77	
		1882.5	17.93	17.04	15.86	
		1850.7	18.01	16.94	16.01	
	3 MHz	1RB High (14)	1913.5	18.77	17.84	17.14
			1882.5	19.01	17.85	16.99
			1851.5	19.05	18.42	17.15
		1RB Middle (7)	1913.5	18.84	17.95	17.03
			1882.5	19.03	17.96	17.05
			1851.5	19.07	18.49	17.31
1RB Low (0)		1913.5	18.94	18.05	17.15	
		1882.5	19.13	17.97	17.21	
		1851.5	19.13	18.57	17.24	
8RB High (7)		1913.5	17.94	16.84	15.86	
		1882.5	17.91	17.06	15.98	
		1851.5	18.02	17.06	15.97	
8RB Middle (4)		1913.5	17.92	16.90	15.95	
		1882.5	17.97	17.05	15.96	
		1851.5	17.99	17.14	16.05	
8RB Low (0)		1913.5	17.89	16.92	15.87	
		1882.5	17.93	17.02	15.90	
		1851.5	18.08	17.21	16.19	
15RB (0)		1913.5	17.85	16.80	15.87	
		1882.5	17.94	16.98	15.90	

5 MHz	1RB High (24)	1851.5	17.97	17.06	15.97	
		1912.5	18.86	18.00	17.04	
		1882.5	19.11	18.22	17.07	
	1RB Middle (12)	1852.5	18.84	18.42	16.89	
		1912.5	18.92	18.09	17.20	
		1882.5	19.09	18.16	17.11	
	1RB Low (0)	1852.5	18.74	18.43	17.00	
		1912.5	19.02	18.20	17.23	
		1882.5	19.25	18.32	17.41	
	12RB High (13)	1852.5	19.02	18.59	17.24	
		1912.5	17.68	16.73	15.81	
		1882.5	17.91	17.00	15.94	
	12RB Middle (6)	1852.5	17.96	17.10	15.91	
		1912.5	17.82	16.84	15.91	
		1882.5	18.00	17.09	15.94	
	12RB Low (0)	1852.5	17.99	17.12	15.90	
		1912.5	17.99	17.08	16.05	
		1882.5	17.97	17.06	15.97	
	25RB (0)	1852.5	17.95	17.10	15.82	
		1912.5	18.05	16.90	15.93	
		1882.5	17.97	17.01	15.94	
	10 MHz	1RB High (49)	1852.5	17.93	17.01	15.80
			1910	18.96	18.03	17.39
			1882.5	19.13	18.08	17.22
1RB Middle (24)		1855	19.24	18.60	17.25	
		1910	18.89	17.90	17.11	
		1882.5	18.89	17.83	17.08	
1RB Low (0)		1855	18.95	18.27	16.94	
		1910	19.12	18.07	17.41	
		1882.5	19.18	18.16	17.28	
25RB High (25)		1855	19.25	18.60	17.24	
		1910	17.95	17.05	16.03	
		1882.5	18.04	17.09	15.98	
25RB Middle (12)		1855	17.91	16.94	15.85	
		1910	17.89	17.11	15.98	
		1882.5	18.01	17.04	15.92	
25RB Low (0)		1855	17.97	17.03	15.72	
		1910	17.91	17.11	15.90	
		1882.5	18.08	17.04	15.93	
50RB (0)		1855	17.94	16.94	15.74	
		1910	18.06	17.11	16.02	
		1882.5	18.01	17.02	15.91	
15 MHz		1RB High (74)	1855	18.04	17.01	15.91
			1907.5	19.32	18.31	17.57
			1882.5	19.15	18.66	17.31
	1RB Middle (37)	1857.5	19.17	18.61	17.30	
		1907.5	19.28	18.17	17.39	
		1882.5	19.10	18.51	17.22	

	1RB Low (0)	1857.5	19.12	18.43	17.15
		1907.5	19.52	18.45	17.65
		1882.5	19.26	18.59	17.26
		1857.5	19.32	18.67	17.39
	36RB High (38)	1907.5	18.45	17.32	16.37
		1882.5	18.23	17.35	16.22
		1857.5	18.21	17.23	16.11
	36RB Middle (19)	1907.5	18.38	17.41	16.29
		1882.5	18.08	17.21	16.04
		1857.5	18.18	17.21	16.03
	36RB Low (0)	1907.5	18.38	17.34	16.30
		1882.5	18.20	17.22	16.09
		1857.5	18.18	17.21	16.13
	75RB (0)	1907.5	18.41	17.45	16.40
		1882.5	18.16	17.26	16.07
1857.5		18.18	17.19	16.04	
20 MHz	1RB High (99)	1905	19.14	18.57	17.36
		1882.5	18.83	18.38	17.13
		1860	18.92	18.50	17.18
	1RB Middle (50)	1905	19.25	18.75	17.41
		1882.5	19.11	18.60	17.31
		1860	18.87	18.54	17.03
	1RB Low (0)	1905	19.47	19.00	17.54
		1882.5	19.12	18.58	17.30
		1860	19.16	18.78	17.32
	50RB High (50)	1905	18.34	17.37	16.28
		1882.5	18.08	17.04	15.97
		1860	18.14	17.24	16.02
	50RB Middle (25)	1905	18.35	17.46	16.28
		1882.5	18.14	17.18	16.09
		1860	18.07	17.08	15.94
	50RB Low (0)	1905	18.33	17.53	16.29
		1882.5	18.11	17.15	16.03
		1860	18.14	17.19	16.00
	100RB (0)	1905	18.41	17.42	16.17
		1882.5	18.13	17.19	16.05
		1860	18.06	17.11	15.89

Power Level B1

Band 25						
Bandwidth (MHz)	RB allocation	Frequency (MHz)	QPSK	16QAM	64QAM	
	RB offset (Start RB)		Actual output power (dBm)	Actual output power (dBm)	Actual output power (dBm)	
1.4 MHz	1RB High (5)	1914.3	24.41	23.51	23.08	
		1882.5	24.40	23.58	23.11	
		1850.7	24.57	23.68	23.13	
	1RB Middle (3)	1914.3	24.48	23.59	23.12	
		1882.5	24.43	23.55	23.08	
		1850.7	24.65	23.65	23.24	
	1RB Low (0)	1914.3	24.33	23.42	23.08	
		1882.5	24.42	23.46	22.91	
		1850.7	24.59	23.70	23.05	
	3RB High (3)	1914.3	24.41	23.51	22.95	
		1882.5	24.41	23.65	23.07	
		1850.7	24.56	23.59	23.10	
	3RB Middle (1)	1914.3	24.39	23.51	22.98	
		1882.5	24.40	23.69	22.95	
		1850.7	24.60	23.64	23.07	
	3RB Low (0)	1914.3	24.43	23.53	23.10	
		1882.5	24.34	23.64	23.00	
		1850.7	24.58	23.61	23.01	
	6RB (0)	1914.3	23.43	22.49	21.97	
		1882.5	23.47	22.63	22.35	
		1850.7	23.59	22.70	21.93	
	3 MHz	1RB High (14)	1913.5	24.32	23.45	23.22
			1882.5	24.52	23.35	23.12
			1851.5	24.54	23.95	23.10
		1RB Middle (7)	1913.5	24.42	23.38	23.01
			1882.5	24.50	23.48	23.07
			1851.5	24.68	24.03	23.21
1RB Low (0)		1913.5	24.46	23.55	23.28	
		1882.5	24.65	23.53	23.32	
		1851.5	24.66	24.08	23.27	
8RB High (7)		1913.5	23.52	22.47	21.98	
		1882.5	23.43	22.62	21.95	
		1851.5	23.65	22.68	22.04	
8RB Middle (4)		1913.5	23.51	22.60	22.02	
		1882.5	23.51	22.60	21.91	
		1851.5	23.61	22.66	22.00	
8RB Low (0)		1913.5	23.39	22.41	21.87	
		1882.5	23.47	22.60	21.94	
		1851.5	23.63	22.67	22.00	
15RB (0)		1913.5	23.44	22.41	21.97	
		1882.5	23.48	22.50	21.87	

5 MHz	1RB High (24)	1851.5	23.58	22.65	21.98	
		1912.5	24.57	23.90	23.28	
		1882.5	24.56	23.71	23.14	
	1RB Middle (12)	1852.5	24.50	23.65	22.92	
		1912.5	24.52	23.99	23.21	
		1882.5	24.46	23.69	23.09	
	1RB Low (0)	1852.5	24.48	23.59	23.05	
		1912.5	24.74	24.02	23.26	
		1882.5	24.69	23.81	23.21	
	12RB High (13)	1852.5	24.72	23.77	23.20	
		1912.5	23.42	22.59	22.05	
		1882.5	23.44	22.46	21.92	
	12RB Middle (6)	1852.5	23.41	22.47	21.86	
		1912.5	23.53	22.59	21.97	
		1882.5	23.56	22.56	21.92	
	12RB Low (0)	1852.5	23.42	22.54	21.84	
		1912.5	23.57	22.74	22.09	
		1882.5	23.52	22.62	21.97	
	25RB (0)	1852.5	23.60	22.66	21.93	
		1912.5	23.53	22.66	22.18	
		1882.5	23.51	22.50	21.92	
	10 MHz	1RB High (49)	1852.5	23.44	22.49	21.82
			1910	24.58	23.65	23.32
			1882.5	24.70	23.60	23.11
1RB Middle (24)		1855	24.67	24.07	23.10	
		1910	24.39	23.41	23.13	
		1882.5	24.45	23.41	23.06	
1RB Low (0)		1855	24.50	23.83	22.81	
		1910	24.61	23.60	23.35	
		1882.5	24.69	23.58	23.23	
25RB High (25)		1855	24.74	24.03	23.28	
		1910	23.61	22.61	22.22	
		1882.5	23.61	22.62	21.96	
25RB Middle (12)		1855	23.38	22.45	21.77	
		1910	23.41	22.54	22.00	
		1882.5	23.51	22.54	21.94	
25RB Low (0)		1855	23.46	22.53	21.80	
		1910	23.44	22.60	21.92	
		1882.5	23.59	22.54	21.94	
50RB (0)		1855	23.46	22.44	21.75	
		1910	23.58	22.57	22.01	
		1882.5	23.59	22.55	21.90	
15 MHz		1RB High (74)	1855	23.52	22.55	21.89
			1907.5	24.62	23.72	23.40
			1882.5	24.63	23.96	23.24
	1RB Middle (37)	1857.5	24.68	24.08	23.12	
1907.5		24.67	23.77	23.43		
		1882.5	24.65	24.00	23.19	

	1RB Low (0)	1857.5	24.67	24.01	23.10
		1907.5	24.74	23.85	23.30
		1882.5	24.78	24.16	23.28
		1857.5	24.77	24.14	23.19
	36RB High (38)	1907.5	23.71	22.79	22.42
		1882.5	23.72	22.77	22.10
		1857.5	23.71	22.67	21.99
	36RB Middle (19)	1907.5	23.67	23.00	22.42
		1882.5	23.69	22.70	22.07
		1857.5	23.70	22.73	22.04
	36RB Low (0)	1907.5	23.67	22.97	22.38
		1882.5	23.64	22.68	22.08
		1857.5	23.69	22.63	21.97
	75RB (0)	1907.5	23.67	23.01	22.44
		1882.5	23.69	22.76	22.05
1857.5		23.68	22.71	22.03	
20 MHz	1RB High (99)	1905	24.39	23.86	23.17
		1882.5	24.27	23.73	22.87
		1860	24.31	23.86	22.78
	1RB Middle (50)	1905	24.68	24.22	23.13
		1882.5	24.56	24.06	23.28
		1860	24.57	24.16	23.14
	1RB Low (0)	1905	24.74	24.21	23.48
		1882.5	24.60	24.00	23.18
		1860	24.66	24.20	23.18
	50RB High (50)	1905	23.74	22.90	22.23
		1882.5	23.49	22.49	21.86
		1860	23.55	22.59	21.94
	50RB Middle (25)	1905	23.80	22.87	22.29
		1882.5	23.56	22.60	21.95
		1860	23.59	22.68	22.00
	50RB Low (0)	1905	23.74	22.97	22.31
		1882.5	23.61	22.57	22.07
		1860	23.55	22.63	21.88
	100RB (0)	1905	23.75	22.92	22.27
		1882.5	23.50	22.56	21.94
		1860	23.59	22.62	21.92

Power Level C1

Band 25						
Bandwidth (MHz)	RB allocation	Frequency (MHz)	QPSK	16QAM	64QAM	
	RB offset (Start RB)		Actual output power (dBm)	Actual output power (dBm)	Actual output power (dBm)	
1.4 MHz	1RB High (5)	1914.3	20.54	19.68	18.39	
		1882.5	20.37	19.84	18.55	
		1850.7	20.59	19.69	18.40	
	1RB Middle (3)	1914.3	20.52	19.64	18.35	
		1882.5	20.45	19.76	18.47	
		1850.7	20.66	19.74	18.45	
	1RB Low (0)	1914.3	20.51	19.56	18.27	
		1882.5	20.39	19.79	18.50	
		1850.7	20.65	19.66	18.37	
	3RB High (3)	1914.3	20.63	19.59	18.30	
		1882.5	20.42	19.50	18.21	
		1850.7	20.64	19.84	18.55	
	3RB Middle (1)	1914.3	20.61	19.56	18.27	
		1882.5	20.50	19.62	18.33	
		1850.7	20.66	19.82	18.53	
	3RB Low (0)	1914.3	20.54	19.56	18.27	
		1882.5	20.41	19.56	18.27	
		1850.7	20.65	19.78	18.49	
	6RB (0)	1914.3	19.42	18.56	17.27	
		1882.5	19.40	18.31	17.02	
		1850.7	19.59	18.82	17.53	
	3 MHz	1RB High (14)	1913.5	20.53	19.41	18.12
			1882.5	20.39	19.72	18.43
			1851.5	20.56	19.66	18.37
		1RB Middle (7)	1913.5	20.51	19.43	18.14
			1882.5	20.51	19.85	18.56
			1851.5	20.70	19.73	18.44
1RB Low (0)		1913.5	20.53	19.47	18.18	
		1882.5	20.53	19.92	18.63	
		1851.5	20.70	19.79	18.50	
8RB High (7)		1913.5	19.54	18.65	17.36	
		1882.5	19.45	18.52	17.23	
		1851.5	19.62	18.69	17.40	
8RB Middle (4)		1913.5	19.47	18.64	17.35	
		1882.5	19.44	18.49	17.20	
		1851.5	19.65	18.77	17.48	
8RB Low (0)		1913.5	19.53	18.61	17.32	
		1882.5	19.40	18.51	17.22	
		1851.5	19.68	18.72	17.43	
15RB (0)		1913.5	19.58	18.54	17.25	
		1882.5	19.38	18.45	17.16	

5 MHz	1RB High (24)	1851.5	19.64	18.63	17.34	
		1912.5	20.63	19.75	18.46	
		1882.5	20.38	19.91	18.62	
	1RB Middle (12)	1852.5	20.52	19.61	18.32	
		1912.5	20.61	19.71	18.42	
		1882.5	20.29	19.90	18.61	
	1RB Low (0)	1852.5	20.51	19.56	18.27	
		1912.5	20.60	19.72	18.43	
		1882.5	20.59	20.06	18.77	
	12RB High (13)	1852.5	20.68	19.75	18.46	
		1912.5	19.49	18.53	17.24	
		1882.5	19.31	18.55	17.26	
	12RB Middle (6)	1852.5	19.48	18.48	17.19	
		1912.5	19.50	18.57	17.28	
		1882.5	19.42	18.58	17.29	
	12RB Low (0)	1852.5	19.47	18.52	17.23	
		1912.5	19.52	18.56	17.27	
		1882.5	19.43	18.62	17.33	
	25RB (0)	1852.5	19.50	18.56	17.27	
		1912.5	19.50	18.55	17.26	
		1882.5	19.38	18.55	17.26	
	10 MHz	1RB High (49)	1852.5	19.46	18.47	17.18
			1910	19.50	18.55	17.26
			1882.5	19.38	18.55	17.26
		1RB Middle (24)	1855	19.46	18.47	17.18
			1910	20.40	19.32	18.03
			1882.5	20.48	19.78	18.49
1RB Low (0)		1855	20.53	19.47	18.18	
		1910	20.69	19.65	18.36	
		1882.5	20.62	19.94	18.65	
25RB High (25)		1855	20.61	19.67	18.38	
		1910	19.46	18.59	17.30	
		1882.5	19.45	18.55	17.26	
25RB Middle (12)		1855	19.47	18.51	17.22	
		1910	19.45	18.43	17.14	
		1882.5	19.47	18.50	17.21	
25RB Low (0)		1855	19.46	18.56	17.27	
		1910	19.51	18.46	17.17	
		1882.5	19.49	18.57	17.28	
50RB (0)		1855	19.41	18.61	17.32	
		1910	19.56	18.52	17.23	
		1882.5	19.46	18.50	17.21	
15 MHz		1RB High (74)	1855	19.42	18.50	17.21
			1907.5	20.64	19.65	18.36
			1882.5	20.51	19.87	18.58
		1RB Middle (37)	1857.5	20.54	19.88	18.59
			1907.5	20.70	19.62	18.33
			1882.5	20.47	19.85	18.56

	1RB Low (0)	1857.5	20.55	19.90	18.61
		1907.5	20.81	19.69	18.40
		1882.5	20.62	19.94	18.65
		1857.5	20.67	20.01	18.72
	36RB High (38)	1907.5	19.89	18.81	17.52
		1882.5	19.57	18.61	17.32
		1857.5	19.64	18.64	17.35
	36RB Middle (19)	1907.5	19.71	18.74	17.45
		1882.5	19.58	18.63	17.34
		1857.5	19.60	18.58	17.29
	36RB Low (0)	1907.5	19.72	18.72	17.43
		1882.5	19.52	18.58	17.29
		1857.5	19.62	18.68	17.39
	75RB (0)	1907.5	19.81	18.78	17.49
		1882.5	19.54	18.61	17.32
1857.5		19.58	18.61	17.32	
20 MHz	1RB High (99)	1905	20.33	19.73	18.44
		1882.5	20.05	19.42	18.13
		1860	20.21	19.71	18.42
	1RB Middle (50)	1905	20.55	20.04	18.75
		1882.5	20.37	19.85	18.56
		1860	20.39	19.84	18.55
	1RB Low (0)	1905	20.64	20.10	18.81
		1882.5	20.55	19.89	18.60
		1860	20.56	20.04	18.75
	50RB High (50)	1905	19.60	18.65	17.36
		1882.5	19.47	18.42	17.13
		1860	19.45	18.47	17.18
	50RB Middle (25)	1905	19.68	18.73	17.44
		1882.5	19.48	18.48	17.19
		1860	19.47	18.52	17.23
	50RB Low (0)	1905	19.76	18.85	17.56
		1882.5	19.47	18.50	17.21
		1860	19.58	18.65	17.36
	100RB (0)	1905	19.73	18.80	17.51
		1882.5	19.46	18.49	17.20
		1860	19.50	18.53	17.24

Power Level A1/B1/C1

Band 26					
Bandwidth (MHz)	RB allocation	Frequency (MHz)	QPSK	16QAM	64QAM
	RB offset (Start RB)		Actual output power (dBm)	Actual output power (dBm)	Actual output power (dBm)
1.4 MHz	1RB High (5)	848.3	24.62	23.77	23.34
		831.5	24.58	23.66	23.13
		814.7	24.39	23.78	22.93
	1RB Middle (3)	848.3	24.67	23.93	23.31
		831.5	24.56	23.68	23.05
		814.7	24.50	23.85	22.92
	1RB Low (0)	848.3	24.59	23.70	23.34
		831.5	24.52	23.59	23.04
		814.7	24.47	23.90	22.89
	3RB High (3)	848.3	24.79	23.72	23.19
		831.5	24.56	23.58	22.93
		814.7	24.39	23.57	22.88
	3RB Middle (1)	848.3	24.88	23.76	23.27
		831.5	24.50	23.56	23.00
		814.7	24.38	23.62	22.84
	3RB Low (0)	848.3	24.78	23.67	23.21
		831.5	24.50	23.50	22.84
		814.7	24.35	23.56	22.77
	6RB (0)	848.3	23.61	22.79	21.62
		831.5	23.48	22.67	21.79
		814.7	23.40	22.34	21.59
3 MHz	1RB High (14)	847.5	25.00	23.88	23.32
		831.5	24.65	23.62	23.06
		815.5	24.62	23.68	22.26
	1RB Middle (7)	847.5	24.96	23.90	23.22
		831.5	24.55	23.66	23.00
		815.5	24.53	23.65	22.43
	1RB Low (0)	847.5	24.90	23.91	23.22
		831.5	24.54	23.63	22.94
		815.5	24.54	23.66	22.46
	8RB High (7)	847.5	23.75	22.74	22.17
		831.5	23.50	22.56	21.91
		815.5	23.48	22.54	21.11
	8RB Middle (4)	847.5	23.76	22.75	22.10
		831.5	23.60	22.64	21.95
		815.5	23.57	22.64	21.14
	8RB Low (0)	847.5	23.68	22.76	22.11
		831.5	23.53	22.56	21.84
		815.5	23.55	22.55	21.17
	15RB (0)	847.5	23.75	22.71	22.01
		831.5	23.59	22.56	22.05

5 MHz	1RB High (24)	815.5	23.58	22.55	21.09	
		846.5	24.74	23.73	22.89	
		831.5	24.73	23.79	23.09	
		816.5	24.65	23.97	22.21	
	1RB Middle (12)	846.5	24.79	23.68	23.14	
		831.5	24.62	23.64	23.12	
		816.5	24.72	23.99	22.30	
	1RB Low (0)	846.5	24.79	23.69	23.14	
		831.5	24.74	23.79	23.26	
		816.5	24.67	24.05	22.11	
	12RB High (13)	846.5	23.74	22.66	22.08	
		831.5	23.59	22.65	21.89	
		816.5	23.52	22.71	21.25	
	12RB Middle (6)	846.5	23.74	22.70	22.12	
		831.5	23.59	22.68	21.93	
		816.5	23.64	22.81	21.33	
	12RB Low (0)	846.5	23.78	22.83	22.14	
		831.5	23.58	22.63	21.79	
		816.5	23.55	22.74	21.16	
	25RB (0)	846.5	23.80	22.67	22.14	
		831.5	23.61	22.64	21.92	
		816.5	23.55	22.61	21.19	
	10 MHz	1RB High (49)	844	24.89	23.99	22.85
			831.5	24.97	23.83	23.32
820			24.94	24.39	21.61	
1RB Middle (24)		844	24.65	23.70	22.50	
		831.5	24.54	23.47	23.09	
		820	24.61	23.98	22.44	
1RB Low (0)		844	24.97	23.96	22.35	
		831.5	24.80	23.72	23.28	
		820	24.86	24.27	22.05	
25RB High (25)		844	23.86	22.87	22.17	
		831.5	23.72	22.67	21.96	
		820	23.64	22.71	21.10	
25RB Middle (12)		844	23.80	22.85	22.12	
		831.5	23.64	22.65	21.93	
		820	23.79	22.77	21.41	
25RB Low (0)		844	23.79	22.87	22.16	
		831.5	23.75	22.69	21.96	
		820	23.73	22.73	21.26	
50RB (0)		844	23.84	22.83	22.11	
		831.5	23.64	22.63	21.96	
		820	23.74	22.84	21.15	
15 MHz		1RB High (74)	841.5	25.15	24.34	23.41
			831.5	25.15	24.41	23.40
			822.5	24.93	24.32	21.82
	1RB Middle	1907.5	24.96	23.95	23.42	
		1882.5	24.88	24.16	23.31	



	(37)	1857.5	24.41	23.71	22.37
	1RB Low (0)	1907.5	25.30	24.33	23.28
		1882.5	24.91	24.22	23.34
		1857.5	24.70	24.04	22.19
	36RB High (38)	1907.5	23.96	22.90	22.20
		1882.5	23.81	22.79	22.04
		1857.5	23.37	22.40	20.97
	36RB Middle (19)	1907.5	24.10	23.11	22.31
		1882.5	23.96	22.96	22.36
		1857.5	23.48	22.55	21.27
	36RB Low (0)	1907.5	24.40	23.43	22.42
		1882.5	24.01	23.10	22.32
		1857.5	23.73	22.78	21.32
	75RB (0)	1907.5	24.21	23.27	22.35
		1882.5	23.91	22.91	22.13
		1857.5	23.55	22.57	21.17

Power Level A1

Band 41 – PC2					
Bandwidth (MHz)	RB allocation	Frequency (MHz)	QPSK	16QAM	64QAM
	RB offset (Start RB)		Actual output power (dBm)	Actual output power (dBm)	Actual output power (dBm)
5 MHz	1RB High (24)	2687.5	17.02	16.40	15.36
		2640.3	17.07	16.52	15.48
		2593	16.93	16.25	15.21
		2545.8	17.02	16.32	15.28
		2498.5	17.05	16.52	15.48
	1RB Middle (12)	2687.5	17.02	16.37	15.33
		2640.3	17.03	16.46	15.42
		2593	16.93	16.24	15.20
		2545.8	16.97	16.32	15.28
		2498.5	17.05	16.45	15.41
	1RB Low (0)	2687.5	17.06	16.40	15.36
		2640.3	17.19	16.62	15.58
		2593	17.06	16.30	15.26
		2545.8	17.11	16.51	15.47
		2498.5	17.18	16.57	15.53
	12RB High (13)	2687.5	16.08	15.17	14.13
		2640.3	16.14	15.26	14.22
		2593	16.01	15.11	14.07
		2545.8	16.11	15.12	14.08
		2498.5	16.18	15.30	14.26
	12RB Middle (6)	2687.5	16.17	15.21	14.17
		2640.3	16.13	15.25	14.21
		2593	16.08	15.18	14.14
		2545.8	16.07	15.09	14.05
		2498.5	16.17	15.27	14.23
	12RB Low (0)	2687.5	16.18	15.24	14.20
		2640.3	16.26	15.36	14.32
		2593	16.13	15.23	14.19
		2545.8	16.16	15.19	14.15
		2498.5	16.09	15.27	14.23
25RB (0)	2687.5	16.11	15.21	14.17	
	2640.3	16.17	15.22	14.18	
	2593	16.04	15.19	14.15	
	2545.8	16.06	15.12	14.08	
	2498.5	16.17	15.22	14.18	

10 MHz	1RB High (49)	2685	17.11	16.50	15.46
		2639	17.05	16.50	15.46
		2593	17.02	16.25	15.21
		2547	16.92	16.45	15.41
		2501	17.09	16.48	15.44
	1RB Middle (24)	2685	17.12	16.48	15.44
		2639	17.05	16.53	15.49
		2593	17.07	16.25	15.21
		2547	17.02	16.42	15.38
		2501	17.07	16.49	15.45
	1RB Low (0)	2685	17.08	16.41	15.37
		2639	17.00	16.46	15.42
		2593	16.97	16.23	15.19
		2547	17.01	16.44	15.40
		2501	17.05	16.53	15.49
	25RB High (25)	2685	16.22	15.18	14.14
		2639	16.17	15.24	14.20
		2593	16.04	15.16	14.12
		2547	16.10	15.13	14.09
		2501	16.09	15.14	14.10
	25RB Middle (12)	2685	16.23	15.18	14.14
		2639	16.24	15.30	14.26
		2593	16.07	15.18	14.14
		2547	16.06	15.10	14.06
		2501	16.18	15.24	14.20
25RB Low (0)	2685	16.23	15.18	14.14	
	2639	16.17	15.22	14.18	
	2593	15.97	15.07	14.03	
	2547	16.14	15.12	14.08	
	2501	16.07	15.09	14.05	
50RB (0)	2685	16.12	15.15	14.11	
	2639	16.22	15.30	14.26	
	2593	15.94	15.06	14.02	
	2547	16.14	15.16	14.12	
	2501	16.15	15.20	14.16	
15 MHz	1RB High (74)	2682.5	16.44	15.70	14.66
		2637.8	16.51	15.93	14.89
		2593	16.44	15.87	14.83
		2548.3	16.46	15.66	14.62
		2503.5	16.49	15.89	14.85
	1RB	2682.5	16.90	16.12	15.08

	Middle (37)	2637.8	17.01	16.38	15.34
		2593	16.92	16.33	15.29
		2548.3	16.87	16.04	15.00
		2503.5	16.95	16.28	15.24
	1RB Low (0)	2682.5	16.49	15.74	14.70
		2637.8	16.41	15.83	14.79
		2593	16.25	15.69	14.65
		2548.3	16.70	15.92	14.88
		2503.5	16.84	16.19	15.15
	36RB High (38)	2682.5	16.24	15.26	14.22
		2637.8	16.17	15.20	14.16
		2593	16.12	15.26	14.22
		2548.3	16.17	15.13	14.09
		2503.5	16.23	15.26	14.22
	36RB Middle (19)	2682.5	16.07	15.16	14.12
		2637.8	16.16	15.22	14.18
		2593	16.07	15.21	14.17
		2548.3	15.98	15.07	14.03
		2503.5	16.07	15.11	14.07
	36RB Low (0)	2682.5	16.05	15.05	14.01
2637.8		15.98	15.00	13.96	
2593		15.84	15.00	13.96	
2548.3		16.02	15.08	14.04	
2503.5		16.11	15.10	14.06	
75RB (0)	2682.5	16.18	15.20	14.16	
	2637.8	16.08	15.13	14.09	
	2593	16.04	15.14	14.10	
	2548.3	16.10	15.15	14.11	
	2503.5	16.14	15.18	14.14	
20 MHz	1RB High (99)	2680	16.66	15.88	14.84
		2636.5	16.57	15.81	14.77
		2593	16.61	16.09	15.05
		2549.5	16.58	15.80	14.76
		2506	16.55	15.76	14.72
	1RB Middle (50)	2680	17.14	16.41	15.37
		2636.5	17.07	16.31	15.27
		2593	17.05	16.48	15.44
		2549.5	16.98	16.25	15.21
		2506	16.97	16.19	15.15
	1RB Low (0)	2680	16.43	15.68	14.64
		2636.5	16.81	16.05	15.01
		2593	16.74	16.21	15.17

		2549.5	17.00	16.25	15.21
		2506	17.18	16.35	15.31
	50RB High (50)	2680	16.07	15.07	14.03
		2636.5	15.99	15.02	13.98
		2593	15.89	15.06	14.02
		2549.5	15.85	14.87	13.83
		2506	16.04	15.04	14.00
		2680	16.12	15.21	14.17
	50RB Middle (25)	2636.5	16.15	15.20	14.16
		2593	15.96	15.11	14.07
		2549.5	15.98	14.98	13.94
		2506	16.19	15.15	14.11
		2680	16.04	15.05	14.01
	50RB Low (0)	2636.5	16.08	15.07	14.03
		2593	15.98	15.09	14.05
		2549.5	15.94	14.93	13.89
		2506	16.14	15.09	14.05
		2680	16.13	15.12	14.08
	100RB (0)	2636.5	16.09	15.08	14.04
		2593	15.99	15.09	14.05
2549.5		15.94	14.97	13.93	
2506		16.09	15.07	14.03	

Power Level B1

Band 41 – PC2					
Bandwidth (MHz)	RB allocation	Frequency (MHz)	QPSK	16QAM	64QAM
	RB offset (Start RB)		Actual output power (dBm)	Actual output power (dBm)	Actual output power (dBm)
5 MHz	1RB High (24)	2687.5	28.04	27.20	26.28
		2640.3	28.17	27.55	26.56
		2593	28.03	27.31	26.52
		2545.8	27.94	27.28	26.33
		2498.5	27.74	27.19	26.29
	1RB Middle (12)	2687.5	28.01	27.16	26.14
		2640.3	28.21	27.49	26.67
		2593	27.97	27.20	26.53
		2545.8	27.96	27.28	26.37
		2498.5	27.70	27.11	26.18
	1RB Low (0)	2687.5	28.06	27.23	26.17
		2640.3	28.14	27.56	26.49
		2593	28.10	27.32	26.62
		2545.8	28.09	27.41	26.53
		2498.5	27.84	27.26	26.25
	12RB High (13)	2687.5	27.00	25.97	25.37
		2640.3	27.24	26.31	25.70
		2593	27.19	26.18	25.70
		2545.8	27.06	26.05	25.47
		2498.5	26.78	25.97	25.48
	12RB Middle (6)	2687.5	26.94	25.96	25.39
		2640.3	27.12	26.28	25.66
		2593	27.17	26.10	25.60
		2545.8	27.01	26.02	25.46
		2498.5	26.74	25.92	25.43
	12RB Low (0)	2687.5	27.03	25.99	25.35
		2640.3	27.17	26.28	25.68
		2593	27.24	26.18	25.41
		2545.8	27.12	26.10	25.61
		2498.5	26.89	26.02	25.58
25RB (0)	2687.5	26.94	26.00	25.31	
	2640.3	27.23	26.23	25.53	
	2593	27.04	26.11	25.67	
	2545.8	27.07	26.09	25.52	
	2498.5	26.83	25.86	25.48	

10 MHz	1RB High (49)	2685	27.73	27.15	26.23
		2639	28.20	27.60	26.62
		2593	28.17	27.36	26.62
		2547	27.91	27.33	26.18
		2501	27.67	26.99	26.21
	1RB Middle (24)	2685	27.75	27.16	26.04
		2639	28.05	27.62	26.62
		2593	28.11	27.27	26.53
		2547	28.00	27.39	26.30
		2501	27.72	27.05	26.41
	1RB Low (0)	2685	27.68	27.01	26.00
		2639	27.94	27.57	26.43
		2593	28.07	27.26	26.51
		2547	27.89	27.29	26.38
		2501	27.64	27.09	26.29
	25RB High (25)	2685	26.91	25.91	25.29
		2639	27.28	26.30	25.41
		2593	27.17	26.14	25.42
		2547	26.96	26.11	25.52
		2501	26.83	25.90	25.46
	25RB Middle (12)	2685	26.95	25.98	25.30
		2639	27.26	26.26	25.70
		2593	27.15	26.12	25.58
		2547	26.97	26.00	25.49
		2501	26.88	25.96	25.57
	25RB Low (0)	2685	26.92	25.93	25.25
		2639	27.11	26.10	25.68
		2593	27.01	26.02	25.59
		2547	27.03	26.07	25.59
		2501	26.80	25.90	25.41
50RB (0)	2685	26.88	25.96	25.24	
	2639	27.11	26.19	25.63	
	2593	27.07	26.12	25.61	
	2547	27.04	26.13	25.45	
	2501	26.85	25.88	25.42	
15 MHz	1RB High (74)	2682.5	27.37	26.40	25.42
		2637.8	27.31	26.69	25.80
		2593	27.14	26.49	25.78
		2548.3	27.18	26.27	25.56
		2503.5	27.17	26.55	25.67
	1RB	2682.5	28.00	26.96	26.00

	Middle (37)	2637.8	27.87	27.15	26.32
		2593	27.62	26.95	26.18
		2548.3	27.63	26.82	26.09
		2503.5	27.82	27.15	26.30
	1RB Low (0)	2682.5	27.49	26.42	25.44
		2637.8	27.26	26.49	25.80
		2593	26.96	26.29	25.56
		2548.3	27.38	26.50	25.77
		2503.5	27.57	26.80	25.92
	36RB High (38)	2682.5	27.01	25.95	25.28
		2637.8	27.03	26.06	25.35
		2593	26.95	25.95	25.44
		2548.3	26.90	25.85	25.25
		2503.5	27.01	26.03	25.56
	36RB Middle (19)	2682.5	26.96	25.96	25.26
		2637.8	26.84	25.96	25.31
		2593	26.82	25.90	25.34
		2548.3	26.78	25.70	25.22
		2503.5	26.89	26.04	25.60
	36RB Low (0)	2682.5	26.75	25.76	25.02
2637.8		26.67	25.78	25.16	
2593		26.64	25.63	25.03	
2548.3		26.78	25.73	25.27	
2503.5		26.85	25.86	25.52	
75RB (0)	2682.5	26.84	25.87	25.21	
	2637.8	26.81	25.85	25.28	
	2593	26.78	25.72	25.23	
	2548.3	26.74	25.76	25.00	
	2503.5	26.93	26.04	25.53	
20 MHz	1RB High (99)	2680	27.39	26.52	25.90
		2636.5	27.19	26.61	25.81
		2593	27.35	26.79	26.27
		2549.5	27.35	26.59	25.70
		2506	27.23	26.26	26.33
	1RB Middle (50)	2680	28.11	27.21	26.69
		2636.5	27.68	27.19	26.49
		2593	27.79	27.20	26.54
		2549.5	27.87	27.06	26.46
		2506	27.91	26.99	26.57
	1RB Low (0)	2680	27.22	26.36	25.90
		2636.5	27.55	26.82	26.43
		2593	27.32	26.88	26.51

		2549.5	27.70	26.90	26.45
		2506	27.83	26.86	26.64
	50RB High (50)	2680	26.75	25.78	25.65
		2636.5	26.80	25.83	25.30
		2593	26.71	25.79	25.54
		2549.5	26.56	25.55	25.27
		2506	26.72	25.81	25.65
		2680	26.91	25.94	25.53
	50RB Middle (25)	2636.5	26.88	25.85	25.43
		2593	26.87	25.89	25.62
		2549.5	26.78	25.81	25.51
		2506	26.90	25.96	25.43
		2680	26.72	25.78	25.52
	50RB Low (0)	2636.5	26.78	25.90	25.68
		2593	26.75	25.76	25.58
		2549.5	26.71	25.66	25.22
		2506	26.86	25.90	25.44
		2680	26.75	25.75	25.70
	100RB (0)	2636.5	26.81	25.79	25.67
		2593	26.70	25.75	25.42
2549.5		26.64	25.66	25.48	
2506		26.79	25.88	25.47	

Power Level C1

Band 41 – PC2					
Bandwidth (MHz)	RB allocation	Frequency (MHz)	QPSK	16QAM	64QAM
	RB offset (Start RB)		Actual output power (dBm)	Actual output power (dBm)	Actual output power (dBm)
5 MHz	1RB High (24)	2687.5	20.86	20.22	19.44
		2640.3	21.09	20.56	19.78
		2593	20.86	20.23	19.45
		2545.8	21.02	20.30	19.52
		2498.5	20.93	20.41	19.63
	1RB Middle (12)	2687.5	20.96	20.25	19.47
		2640.3	21.11	20.48	19.70
		2593	20.87	20.23	19.45
		2545.8	21.18	20.28	19.50
		2498.5	20.91	20.23	19.45
	1RB Low (0)	2687.5	21.00	20.36	19.58
		2640.3	21.16	20.60	19.82
		2593	20.98	20.28	19.50
		2545.8	21.14	20.33	19.55
		2498.5	21.01	20.45	19.67
	12RB High (13)	2687.5	20.00	19.02	18.24
		2640.3	20.14	19.24	18.46
		2593	20.03	19.04	18.26
		2545.8	20.07	19.07	18.29
		2498.5	19.94	19.06	18.28
	12RB Middle (6)	2687.5	20.04	19.07	18.29
		2640.3	20.16	19.28	18.50
		2593	20.04	19.05	18.27
		2545.8	20.07	19.07	18.29
		2498.5	19.93	19.06	18.28
	12RB Low (0)	2687.5	20.06	19.11	18.33
		2640.3	20.18	19.31	18.53
		2593	20.09	19.14	18.36
		2545.8	20.15	19.19	18.41
		2498.5	20.03	19.13	18.35
25RB (0)	2687.5	20.05	19.09	18.31	
	2640.3	20.16	19.22	18.44	
	2593	20.00	19.00	18.22	
	2545.8	20.02	19.11	18.33	
	2498.5	19.97	18.97	18.19	

10 MHz	1RB High (49)	2685	20.80	20.27	19.49
		2639	21.20	20.57	19.79
		2593	21.01	20.25	19.47
		2547	20.94	20.40	19.62
		2501	20.86	20.17	19.39
	1RB Middle (24)	2685	20.99	20.40	19.62
		2639	21.18	20.61	19.83
		2593	21.08	20.25	19.47
		2547	21.10	20.50	19.72
		2501	20.84	20.27	19.49
	1RB Low (0)	2685	20.86	20.19	19.41
		2639	21.00	20.54	19.76
		2593	20.98	20.16	19.38
		2547	21.04	20.42	19.64
		2501	20.78	20.27	19.49
	25RB High (25)	2685	20.01	19.04	18.26
		2639	20.31	19.30	18.52
		2593	20.10	19.12	18.34
		2547	20.11	19.13	18.35
		2501	19.88	18.92	18.14
	25RB Middle (12)	2685	20.07	19.10	18.32
		2639	20.31	19.36	18.58
		2593	20.12	19.11	18.33
		2547	20.12	19.14	18.36
		2501	19.90	19.02	18.24
	25RB Low (0)	2685	19.96	19.02	18.24
		2639	20.23	19.24	18.46
		2593	20.01	19.04	18.26
		2547	20.22	19.21	18.43
		2501	19.84	18.91	18.13
50RB (0)	2685	19.97	19.04	18.26	
	2639	20.23	19.31	18.53	
	2593	20.04	19.06	18.28	
	2547	20.14	19.20	18.42	
	2501	19.85	18.95	18.17	
15 MHz	1RB High (74)	2682.5	20.02	19.38	18.60
		2637.8	20.38	19.53	18.75
		2593	20.33	19.79	19.01
		2548.3	20.10	19.53	18.75
		2503.5	20.36	19.51	18.73
	1RB	2682.5	20.68	20.05	19.27

	Middle (37)	2637.8	20.98	20.16	19.38
		2593	20.94	20.27	19.49
		2548.3	20.84	20.25	19.47
		2503.5	21.02	20.14	19.36
	1RB Low (0)	2682.5	20.27	19.57	18.79
		2637.8	20.28	19.42	18.64
		2593	20.20	19.57	18.79
		2548.3	20.44	19.83	19.05
		2503.5	20.64	19.79	19.01
	36RB High (38)	2682.5	20.05	19.09	18.31
		2637.8	20.10	19.08	18.30
		2593	20.05	19.09	18.31
		2548.3	19.87	18.93	18.15
		2503.5	20.03	19.05	18.27
	36RB Middle (19)	2682.5	19.94	18.98	18.20
		2637.8	20.04	19.08	18.30
		2593	19.98	19.05	18.27
		2548.3	19.91	19.00	18.22
		2503.5	20.04	19.12	18.34
	36RB Low (0)	2682.5	19.85	18.90	18.12
2637.8		19.82	18.84	18.06	
2593		19.71	18.82	18.04	
2548.3		19.93	18.94	18.16	
2503.5		19.92	18.94	18.16	
75RB (0)	2682.5	19.93	18.95	18.17	
	2637.8	19.93	18.95	18.17	
	2593	19.95	19.00	18.22	
	2548.3	19.90	18.91	18.13	
	2503.5	20.03	19.04	18.26	
20 MHz	1RB High (99)	2680	20.23	19.34	18.56
		2636.5	20.36	19.81	19.03
		2593	20.57	19.83	19.05
		2549.5	20.17	19.53	18.75
		2506	20.34	19.76	18.98
	1RB Middle (50)	2680	20.95	20.08	19.30
		2636.5	21.05	20.36	19.58
		2593	21.12	20.34	19.56
		2549.5	20.70	20.16	19.38
		2506	21.13	20.38	19.60
	1RB Low (0)	2680	20.04	19.19	18.41
		2636.5	20.60	19.98	19.20
		2593	20.57	19.80	19.02

		2549.5	20.64	19.94	19.16
		2506	20.87	20.16	19.38
	50RB High (50)	2680	19.86	18.90	18.12
		2636.5	19.89	18.94	18.16
		2593	19.83	18.81	18.03
		2549.5	19.76	18.79	18.01
		2506	19.84	18.90	18.12
		2680	20.04	19.09	18.31
	50RB Middle (25)	2636.5	20.02	19.09	18.31
		2593	19.90	18.94	18.16
		2549.5	19.83	18.90	18.12
		2506	20.07	19.11	18.33
		2680	19.89	18.94	18.16
	50RB Low (0)	2636.5	19.90	18.92	18.14
		2593	19.83	18.88	18.10
		2549.5	19.81	18.89	18.11
		2506	19.93	18.98	18.20
		2680	19.88	18.93	18.15
	100RB (0)	2636.5	19.88	18.91	18.13
		2593	19.84	18.87	18.09
2549.5		19.79	18.81	18.03	
2506		19.97	18.94	18.16	

Power Level A1

Band 41 – PC3					
Bandwidth (MHz)	RB allocation	Frequency (MHz)	QPSK	16QAM	64QAM
	RB offset (Start RB)		Actual output power (dBm)	Actual output power (dBm)	Actual output power (dBm)
5 MHz	1RB High (24)	2687.5	17.02	16.10	15.11
		2640.3	17.18	16.26	15.27
		2593	17.02	15.89	14.90
		2545.8	16.99	16.04	15.05
		2498.5	17.13	16.26	15.27
	1RB Middle (12)	2687.5	16.98	16.11	15.12
		2640.3	17.18	16.24	15.25
		2593	17.31	15.95	14.96
		2545.8	17.03	15.97	14.98
		2498.5	17.10	16.20	15.21
	1RB Low (0)	2687.5	17.06	16.18	15.19
		2640.3	17.30	16.40	15.41
		2593	17.14	16.00	15.01
		2545.8	17.11	16.19	15.20
		2498.5	17.21	16.35	15.36
	12RB High (13)	2687.5	16.14	15.13	14.14
		2640.3	16.23	15.21	14.22
		2593	16.01	15.07	14.08
		2545.8	16.10	15.12	14.13
		2498.5	16.24	15.24	14.25
	12RB Middle (6)	2687.5	16.14	15.15	14.16
		2640.3	16.15	15.20	14.21
		2593	16.05	15.11	14.12
		2545.8	16.09	15.07	14.08
		2498.5	16.17	15.20	14.21
	12RB Low (0)	2687.5	16.20	15.22	14.23
		2640.3	16.29	15.37	14.38
		2593	16.14	15.19	14.20
		2545.8	16.21	15.13	14.14
		2498.5	16.14	15.19	14.20
25RB (0)	2687.5	16.16	15.20	14.21	
	2640.3	16.14	15.19	14.20	
	2593	16.08	15.12	14.13	
	2545.8	16.11	15.11	14.12	
	2498.5	16.20	15.19	14.20	

10 MHz	1RB High (49)	2685	17.10	16.04	15.05
		2639	17.09	16.26	15.27
		2593	16.97	15.94	14.95
		2547	17.02	15.98	14.99
		2501	17.10	16.21	15.22
	1RB Middle (24)	2685	17.07	16.09	15.10
		2639	17.12	16.29	15.30
		2593	16.99	15.89	14.90
		2547	17.03	16.02	15.03
		2501	17.08	16.23	15.24
	1RB Low (0)	2685	17.03	16.03	15.04
		2639	17.02	16.21	15.22
		2593	16.95	15.90	14.91
		2547	17.08	16.00	15.01
		2501	17.10	16.28	15.29
	25RB High (25)	2685	16.18	15.17	14.18
		2639	16.18	15.20	14.21
		2593	16.02	15.06	14.07
		2547	16.09	15.10	14.11
		2501	16.09	15.10	14.11
	25RB Middle (12)	2685	16.16	15.17	14.18
		2639	16.26	15.26	14.27
		2593	16.08	15.17	14.18
		2547	16.04	15.07	14.08
		2501	16.19	15.19	14.20
	25RB Low (0)	2685	16.18	15.17	14.18
		2639	16.17	15.20	14.21
		2593	15.98	15.01	14.02
		2547	16.18	15.12	14.13
		2501	16.09	15.10	14.11
	50RB (0)	2685	16.13	15.13	14.14
		2639	16.23	15.27	14.28
		2593	15.95	14.99	14.00
		2547	16.09	15.16	14.17
		2501	16.13	15.21	14.22
15 MHz	1RB High (74)	2682.5	16.38	15.49	14.50
		2637.8	16.37	15.56	14.57
		2593	16.52	15.43	14.44
		2548.3	16.43	15.49	14.50
		2503.5	16.39	15.55	14.56
	1RB	2682.5	16.82	15.89	14.90

	Middle (37)	2637.8	16.90	16.10	15.11
		2593	16.98	15.90	14.91
		2548.3	16.79	15.85	14.86
		2503.5	16.83	15.95	14.96
	1RB Low (0)	2682.5	16.43	15.46	14.47
		2637.8	16.33	15.52	14.53
		2593	16.32	15.25	14.26
		2548.3	16.64	15.63	14.64
		2503.5	16.74	15.86	14.87
	36RB High (38)	2682.5	16.22	15.24	14.25
		2637.8	16.21	15.21	14.22
		2593	16.11	15.14	14.15
		2548.3	16.15	15.20	14.21
		2503.5	16.27	15.23	14.24
	36RB Middle (19)	2682.5	16.03	15.15	14.16
		2637.8	16.17	15.21	14.22
		2593	16.06	15.18	14.19
		2548.3	16.02	15.05	14.06
		2503.5	16.08	15.14	14.15
	36RB Low (0)	2682.5	16.02	15.07	14.08
2637.8		15.97	14.99	14.00	
2593		15.86	14.93	13.94	
2548.3		16.04	15.07	14.08	
2503.5		16.12	15.12	14.13	
75RB (0)	2682.5	16.10	15.23	14.24	
	2637.8	16.12	15.13	14.14	
	2593	15.99	15.05	14.06	
	2548.3	16.11	15.15	14.16	
	2503.5	16.13	15.10	14.11	
20 MHz	1RB High (99)	2680	16.72	15.66	14.67
		2636.5	16.66	15.60	14.61
		2593	16.61	15.82	14.83
		2549.5	16.64	15.55	14.56
		2506	16.64	15.54	14.55
	1RB Middle (50)	2680	17.15	16.19	15.20
		2636.5	17.16	16.14	15.15
		2593	17.11	16.23	15.24
		2549.5	17.06	16.02	15.03
		2506	16.99	15.94	14.95
	1RB Low (0)	2680	16.57	15.46	14.47
		2636.5	16.91	15.91	14.92
		2593	16.82	15.97	14.98



		2549.5	17.07	16.05	15.06
		2506	17.18	16.07	15.08
	50RB High (50)	2680	16.17	15.11	14.12
		2636.5	16.07	15.09	14.10
		2593	15.95	15.08	14.09
		2549.5	15.95	14.95	13.96
		2506	16.07	15.03	14.04
		2680	16.22	15.20	14.21
	50RB Middle (25)	2636.5	16.19	15.28	14.29
		2593	16.01	15.15	14.16
		2549.5	16.02	15.01	14.02
		2506	16.25	15.17	14.18
		2680	16.14	15.08	14.09
	50RB Low (0)	2636.5	16.12	15.22	14.23
		2593	16.03	15.15	14.16
		2549.5	16.00	15.00	14.01
		2506	16.12	15.12	14.13
		2680	16.26	15.19	14.20
	100RB (0)	2636.5	16.13	15.21	14.22
		2593	15.99	15.12	14.13
2549.5		15.98	14.94	13.95	
2506		16.08	15.11	14.12	

Power Level B1

Band 41 – PC3					
Bandwidth (MHz)	RB allocation	Frequency (MHz)	QPSK	16QAM	64QAM
	RB offset (Start RB)		Actual output power (dBm)	Actual output power (dBm)	Actual output power (dBm)
5 MHz	1RB High (24)	2687.5	23.99	23.23	22.46
		2640.3	24.40	23.60	22.67
		2593	24.24	23.36	22.61
		2545.8	24.25	23.31	22.48
		2498.5	24.03	23.19	22.38
	1RB Middle (12)	2687.5	23.96	23.20	22.28
		2640.3	24.42	23.46	22.77
		2593	24.16	23.28	22.67
		2545.8	24.22	23.26	22.39
		2498.5	23.94	23.06	22.33
	1RB Low (0)	2687.5	23.99	23.31	22.37
		2640.3	24.39	23.58	22.90
		2593	24.33	23.37	22.67
		2545.8	24.32	23.47	22.60
		2498.5	24.08	23.23	22.45
	12RB High (13)	2687.5	23.10	22.21	21.73
		2640.3	23.48	22.51	21.94
		2593	23.47	22.43	21.96
		2545.8	23.40	22.34	21.74
		2498.5	23.10	22.18	21.75
	12RB Middle (6)	2687.5	23.10	22.19	21.81
		2640.3	23.41	22.43	21.94
		2593	23.38	22.34	21.87
		2545.8	23.39	22.35	21.76
		2498.5	23.10	22.18	21.69
	12RB Low (0)	2687.5	23.13	22.26	21.93
		2640.3	23.42	22.51	21.97
		2593	23.47	22.47	21.94
		2545.8	23.42	22.40	21.87
		2498.5	23.21	22.27	21.77
25RB (0)	2687.5	23.09	22.27	21.94	
	2640.3	23.58	22.51	21.95	
	2593	23.34	22.40	21.95	
	2545.8	23.32	22.35	21.78	
	2498.5	23.11	22.09	21.75	

10 MHz	1RB High (49)	2685	23.86	23.14	22.15
		2639	24.32	23.68	22.62
		2593	24.32	23.36	22.61
		2547	24.29	23.24	22.41
		2501	24.00	23.19	22.38
	1RB Middle (24)	2685	23.99	23.18	22.20
		2639	24.38	23.50	22.67
		2593	24.27	23.20	22.55
		2547	24.29	23.32	22.46
		2501	24.04	23.21	22.33
	1RB Low (0)	2685	23.86	23.06	22.21
		2639	24.34	23.53	22.68
		2593	24.21	23.20	22.67
		2547	24.26	23.29	22.47
		2501	23.99	23.24	22.35
	25RB High (25)	2685	23.07	22.22	21.61
		2639	23.55	22.54	21.95
		2593	23.42	22.40	21.99
		2547	23.38	22.35	21.76
		2501	23.16	22.19	21.83
	25RB Middle (12)	2685	23.09	22.28	21.67
		2639	23.48	22.48	21.95
		2593	23.40	22.36	22.00
		2547	23.33	22.35	21.76
		2501	23.22	22.25	21.81
	25RB Low (0)	2685	23.02	22.20	21.65
		2639	23.41	22.42	21.93
		2593	23.31	22.29	21.84
		2547	23.39	22.39	21.84
		2501	23.14	22.15	21.65
50RB (0)	2685	22.99	22.20	21.58	
	2639	23.45	22.44	21.90	
	2593	23.31	22.37	21.88	
	2547	23.35	22.41	21.75	
	2501	23.19	22.16	21.68	
15 MHz	1RB High (74)	2682.5	23.53	22.54	21.53
		2637.8	23.63	22.58	21.79
		2593	23.61	22.52	21.97
		2548.3	23.40	22.45	21.50
		2503.5	23.51	22.51	21.81
	1RB	2682.5	24.17	23.15	22.05

	Middle (37)	2637.8	24.12	23.08	22.33
		2593	24.02	22.95	22.30
		2548.3	23.91	23.00	22.25
		2503.5	24.09	23.09	22.54
	1RB Low (0)	2682.5	23.71	22.64	21.56
		2637.8	23.51	22.45	21.82
		2593	23.39	22.34	21.72
		2548.3	23.68	22.77	21.88
		2503.5	23.78	22.78	22.09
	36RB High (38)	2682.5	23.36	22.26	21.60
		2637.8	23.26	22.25	21.61
		2593	23.24	22.26	21.70
		2548.3	23.21	22.28	21.59
		2503.5	23.35	22.33	21.88
	36RB Middle (19)	2682.5	23.34	22.24	21.56
		2637.8	23.16	22.22	21.56
		2593	23.10	22.19	21.61
		2548.3	23.08	22.12	21.46
		2503.5	23.30	22.33	21.85
	36RB Low (0)	2682.5	23.21	22.09	21.44
2637.8		22.99	22.01	21.50	
2593		22.91	21.98	21.47	
2548.3		23.14	22.09	21.52	
2503.5		23.23	22.21	21.78	
75RB (0)	2682.5	23.24	22.15	21.62	
	2637.8	23.07	22.11	21.60	
	2593	23.04	22.12	21.60	
	2548.3	23.11	22.12	21.48	
	2503.5	23.25	22.30	21.87	
20 MHz	1RB High (99)	2680	23.67	22.66	22.03
		2636.5	23.81	22.73	21.92
		2593	23.63	22.76	22.09
		2549.5	23.50	22.60	21.87
		2506	23.67	22.59	22.27
	1RB Middle (50)	2680	24.37	23.10	22.72
		2636.5	24.36	23.28	22.59
		2593	24.05	23.12	22.61
		2549.5	24.05	23.18	22.61
		2506	24.26	23.19	23.00
	1RB Low (0)	2680	23.36	22.47	21.98
		2636.5	24.00	22.90	22.33
		2593	23.77	22.74	22.33

		2549.5	23.95	23.07	22.64
		2506	24.09	23.13	22.87
	50RB High (50)	2680	23.11	22.11	21.88
		2636.5	23.10	22.06	21.78
		2593	23.02	22.06	21.80
		2549.5	22.87	21.92	21.54
		2506	23.10	22.09	21.91
		2680	23.29	22.27	21.95
	50RB Middle (25)	2636.5	23.20	22.17	21.93
		2593	23.16	22.15	21.99
		2549.5	23.13	22.11	21.78
		2506	23.23	22.25	21.94
		2680	23.08	22.11	21.97
	50RB Low (0)	2636.5	23.07	22.11	21.99
		2593	23.05	22.10	21.88
		2549.5	23.04	22.09	21.76
		2506	23.19	22.16	21.93
		2680	23.14	22.03	22.00
	100RB (0)	2636.5	23.06	22.03	21.95
		2593	23.01	21.99	21.94
2549.5		23.06	22.03	21.84	
2506		23.16	22.13	21.93	

Power Level C1

Band 41 – PC3					
Bandwidth (MHz)	RB allocation	Frequency (MHz)	QPSK	16QAM	64QAM
	RB offset (Start RB)		Actual output power (dBm)	Actual output power (dBm)	Actual output power (dBm)
5 MHz	1RB High (24)	2687.5	20.92	19.99	18.94
		2640.3	21.09	20.28	19.23
		2593	20.89	19.96	18.91
		2545.8	21.07	19.97	18.92
		2498.5	20.94	20.10	19.05
	1RB Middle (12)	2687.5	20.96	20.01	18.96
		2640.3	21.03	20.24	19.19
		2593	20.94	19.91	18.86
		2545.8	21.14	19.97	18.92
		2498.5	20.82	20.00	18.95
	1RB Low (0)	2687.5	21.08	20.17	19.12
		2640.3	21.21	20.35	19.30
		2593	20.96	20.12	19.07
		2545.8	21.10	20.10	19.05
		2498.5	21.01	20.20	19.15
	12RB High (13)	2687.5	20.03	19.01	17.96
		2640.3	20.19	19.21	18.16
		2593	20.06	19.03	17.98
		2545.8	20.11	19.09	18.04
		2498.5	19.96	18.98	17.93
	12RB Middle (6)	2687.5	20.07	19.04	17.99
		2640.3	20.20	19.25	18.20
		2593	20.04	19.05	18.00
		2545.8	20.11	19.07	18.02
		2498.5	19.96	19.03	17.98
	12RB Low (0)	2687.5	20.13	19.08	18.03
		2640.3	20.22	19.25	18.20
		2593	20.14	19.09	18.04
		2545.8	20.18	19.13	18.08
		2498.5	20.08	19.12	18.07
25RB (0)	2687.5	20.06	19.07	18.02	
	2640.3	20.23	19.19	18.14	
	2593	20.01	19.01	17.96	
	2545.8	20.05	19.14	18.09	
	2498.5	19.98	19.02	17.97	

10 MHz	1RB High (49)	2685	20.90	19.96	18.91
		2639	21.06	20.04	18.99
		2593	20.88	19.85	18.80
		2547	20.98	20.08	19.03
		2501	20.91	19.85	18.80
	1RB Middle (24)	2685	21.02	20.11	19.06
		2639	21.09	20.09	19.04
		2593	20.90	19.91	18.86
		2547	21.07	20.16	19.11
		2501	20.93	19.90	18.85
	1RB Low (0)	2685	20.83	19.89	18.84
		2639	20.99	20.00	18.95
		2593	20.82	19.84	18.79
		2547	20.98	20.16	19.11
		2501	20.90	19.83	18.78
	25RB High (25)	2685	20.11	19.05	18.00
		2639	20.16	19.15	18.10
		2593	20.01	19.01	17.96
		2547	20.04	19.05	18.00
		2501	20.00	19.00	17.95
	25RB Middle (12)	2685	20.14	19.09	18.04
		2639	20.21	19.20	18.15
		2593	20.03	19.00	17.95
		2547	20.05	19.05	18.00
		2501	20.03	19.03	17.98
	25RB Low (0)	2685	20.00	19.00	17.95
		2639	20.14	19.12	18.07
		2593	19.93	18.94	17.89
		2547	20.14	19.12	18.07
		2501	19.97	18.90	17.85
50RB (0)	2685	20.04	19.05	18.00	
	2639	20.15	19.17	18.12	
	2593	19.96	18.99	17.94	
	2547	20.09	19.12	18.07	
	2501	19.97	19.00	17.95	
15 MHz	1RB High (74)	2682.5	20.14	19.21	18.16
		2637.8	20.39	19.35	18.30
		2593	20.47	19.44	18.39
		2548.3	20.28	19.35	18.30
		2503.5	20.32	19.25	18.20
	1RB	2682.5	20.84	19.92	18.87

	Middle (37)	2637.8	20.96	19.95	18.90
		2593	21.07	19.99	18.94
		2548.3	20.98	20.08	19.03
		2503.5	20.99	19.85	18.80
	1RB Low (0)	2682.5	20.37	19.41	18.36
		2637.8	20.27	19.25	18.20
		2593	20.28	19.24	18.19
		2548.3	20.62	19.66	18.61
		2503.5	20.65	19.51	18.46
	36RB High (38)	2682.5	20.17	19.25	18.20
		2637.8	20.20	19.16	18.11
		2593	20.13	19.15	18.10
		2548.3	20.03	19.02	17.97
		2503.5	20.08	19.07	18.02
	36RB Middle (19)	2682.5	20.05	19.11	18.06
		2637.8	20.14	19.17	18.12
		2593	20.11	19.17	18.12
		2548.3	20.05	19.08	18.03
		2503.5	20.06	19.10	18.05
	36RB Low (0)	2682.5	19.95	18.99	17.94
		2637.8	19.92	18.94	17.89
		2593	19.88	18.91	17.86
		2548.3	20.05	19.02	17.97
		2503.5	19.97	18.99	17.94
	75RB (0)	2682.5	20.03	19.07	18.02
		2637.8	20.04	19.03	17.98
		2593	20.07	19.08	18.03
		2548.3	20.05	18.95	17.90
2503.5		20.02	19.08	18.03	
20 MHz	1RB High (99)	2680	20.36	19.28	18.23
		2636.5	20.45	19.46	18.41
		2593	20.58	19.67	18.62
		2549.5	20.48	19.38	18.33
		2506	20.39	19.31	18.26
	1RB Middle (50)	2680	21.18	20.05	19.00
		2636.5	20.99	20.09	19.04
		2593	21.11	20.17	19.12
		2549.5	21.17	20.05	19.00
		2506	20.95	20.10	19.05
	1RB Low (0)	2680	20.19	19.15	18.10
		2636.5	20.65	19.63	18.58
		2593	20.61	19.71	18.66



		2549.5	20.90	19.83	18.78
		2506	20.78	19.80	18.75
	50RB High (50)	2680	19.93	18.92	17.87
		2636.5	19.99	18.98	17.93
		2593	19.94	19.01	17.96
		2549.5	19.87	18.84	17.79
		2506	19.85	18.89	17.84
		2680	20.11	19.09	18.04
	50RB Middle (25)	2636.5	20.13	19.16	18.11
		2593	20.03	19.07	18.02
		2549.5	19.95	18.99	17.94
		2506	20.08	19.11	18.06
		2680	20.02	19.06	18.01
	50RB Low (0)	2636.5	19.97	19.00	17.95
		2593	19.99	19.03	17.98
		2549.5	19.97	18.98	17.93
		2506	19.89	18.94	17.89
		2680	20.02	18.96	17.91
	100RB (0)	2636.5	20.01	19.03	17.98
		2593	19.97	18.95	17.90
2549.5		19.87	18.89	17.84	
2506		19.95	18.98	17.93	

Power Level A1

Band 66					
Bandwidth (MHz)	RB allocation	Frequency (MHz)	QPSK	16QAM	64QAM
	RB offset (Start RB)		Actual output power (dBm)	Actual output power (dBm)	Actual output power (dBm)
1.4 MHz	1RB High (5)	1779.3	18.59	18.03	17.23
		1745	18.59	17.67	16.89
		1710.7	18.46	17.58	17.23
	1RB Middle (3)	1779.3	18.71	18.05	17.22
		1745	18.71	17.54	17.29
		1710.7	18.48	17.61	17.01
	1RB Low (0)	1779.3	18.61	18.11	17.31
		1745	18.64	17.60	17.32
		1710.7	18.51	17.60	17.20
	3RB High (3)	1779.3	18.56	17.64	17.05
		1745	18.58	17.91	17.11
		1710.7	18.48	17.56	16.98
	3RB Middle (1)	1779.3	18.61	17.75	17.20
		1745	18.57	17.96	17.08
		1710.7	18.56	17.59	17.03
	3RB Low (0)	1779.3	18.58	17.67	17.14
		1745	18.52	17.90	17.03
		1710.7	18.45	17.56	16.99
	6RB (0)	1779.3	17.59	16.36	15.97
		1745	17.61	16.81	16.09
		1710.7	17.53	16.53	16.03
3 MHz	1RB High (14)	1778.5	18.58	17.66	17.43
		1745	18.75	17.56	16.66
		1711.5	18.58	17.98	16.58
	1RB Middle (7)	1778.5	18.61	17.66	17.45
		1745	18.87	17.72	16.87
		1711.5	18.63	18.13	16.63
	1RB Low (0)	1778.5	18.65	17.76	17.46
		1745	18.91	17.75	16.67
		1711.5	18.61	18.09	16.61
	8RB High (7)	1778.5	17.65	16.67	15.52
		1745	17.67	16.71	15.50
		1711.5	17.55	16.59	15.36
	8RB Middle (4)	1778.5	17.55	16.71	15.52
		1745	17.67	16.73	15.56
		1711.5	17.56	16.68	15.57
	8RB Low (0)	1778.5	17.63	16.68	15.55
		1745	17.64	16.76	15.54
		1711.5	17.56	16.61	15.52
15RB	1778.5	17.60	16.53	15.40	

	(0)	1745	17.64	16.69	15.61
		1711.5	17.53	16.55	15.39
5 MHz	1RB High (24)	1777.5	18.68	17.90	17.43
		1745	18.82	17.96	17.23
		1712.5	18.48	18.11	17.46
	1RB Middle (12)	1777.5	18.62	17.78	17.46
		1745	18.82	17.93	17.29
		1712.5	18.27	18.12	17.12
	1RB Low (0)	1777.5	18.79	17.95	17.45
		1745	19.02	18.11	17.37
		1712.5	18.57	18.17	17.27
	12RB High (13)	1777.5	17.56	16.59	15.95
		1745	17.72	16.73	16.15
		1712.5	17.57	16.64	15.99
	12RB Middle (6)	1777.5	17.76	16.76	16.14
		1745	17.74	16.77	16.17
		1712.5	17.57	16.71	16.02
	12RB Low (0)	1777.5	17.66	16.75	16.04
		1745	17.76	16.76	16.11
		1712.5	17.65	16.72	16.08
	25RB (0)	1777.5	17.65	16.57	16.06
		1745	17.73	16.74	16.12
		1712.5	17.59	16.64	16.08
10 MHz	1RB High (49)	1775	19.20	18.43	17.36
		1745	19.23	18.26	17.34
		1715	19.19	18.07	17.22
	1RB Middle (24)	1775	18.70	18.03	17.41
		1745	18.72	17.71	16.84
		1715	18.62	17.57	16.49
	1RB Low (0)	1775	18.20	17.57	16.95
		1745	18.19	17.20	16.33
		1715	18.04	16.96	16.14
	25RB High (25)	1775	17.92	16.82	15.67
		1745	17.88	16.89	15.73
		1715	17.69	16.77	15.58
	25RB Middle (12)	1775	17.82	16.77	15.52
		1745	17.79	16.85	15.68
		1715	17.65	16.65	15.50
	25RB Low (0)	1775	17.76	16.62	15.49
		1745	17.78	16.88	15.63
		1715	17.56	16.53	15.44
	50RB (0)	1775	17.79	16.72	15.52
		1745	17.82	16.78	15.51
		1715	17.67	16.57	15.40
15 MHz	1RB High (74)	1772.5	19.14	18.42	17.42
		1745	19.10	18.48	17.50
		1717.5	19.26	18.06	17.22
	1RB	1772.5	18.85	18.25	17.32

	Middle (37)	1745	18.83	18.20	17.22	
		1717.5	18.93	17.69	17.38	
		1772.5	19.16	18.50	17.36	
	1RB Low (0)	1745	19.21	18.45	17.19	
		1717.5	19.29	18.11	17.31	
		1772.5	17.77	16.85	16.08	
	36RB High (38)	1745	17.77	16.76	16.01	
		1717.5	17.84	16.75	16.12	
		1772.5	17.78	16.84	16.01	
	36RB Middle (19)	1745	17.78	16.73	16.08	
		1717.5	17.87	16.79	16.18	
		1772.5	17.87	16.88	16.11	
	36RB Low (0)	1745	17.87	16.86	16.23	
		1717.5	17.97	16.88	16.30	
		1772.5	17.74	16.86	16.09	
	75RB (0)	1745	17.78	16.75	16.15	
		1717.5	17.90	16.91	16.23	
		1770	19.10	18.37	17.39	
	20 MHz	1RB High (99)	1745	18.99	18.21	17.47
			1720	19.09	18.40	17.44
			1770	18.49	17.96	16.74
1RB Middle (50)		1745	18.49	17.98	16.63	
		1720	18.47	18.10	16.75	
		1770	18.42	17.95	16.79	
1RB Low (0)		1745	18.48	17.94	16.88	
		1720	18.44	18.13	16.80	
		1770	17.53	16.74	15.67	
50RB High (50)		1745	17.59	16.55	15.58	
		1720	17.84	16.85	15.81	
		1770	17.46	16.61	15.60	
50RB Middle (25)		1745	17.49	16.44	15.57	
		1720	17.72	16.78	15.72	
		1770	17.42	16.52	15.55	
50RB Low (0)		1745	17.44	16.41	15.51	
		1720	17.66	16.69	15.73	
		1770	17.66	16.64	15.73	
100RB (0)		1745	17.54	16.54	15.55	
		1720	17.73	16.76	15.69	

Power Level B1

Band 66					
Bandwidth (MHz)	RB allocation	Frequency (MHz)	QPSK	16QAM	64QAM
	RB offset (Start RB)		Actual output power (dBm)	Actual output power (dBm)	Actual output power (dBm)
1.4 MHz	1RB High (5)	1779.3	24.38	23.59	22.95
		1745	24.53	23.63	23.15
		1710.7	24.50	23.90	23.14
	1RB Middle (3)	1779.3	24.39	23.63	23.10
		1745	24.51	23.67	23.20
		1710.7	24.58	23.96	23.26
	1RB Low (0)	1779.3	24.43	23.65	23.06
		1745	24.50	23.61	23.14
		1710.7	24.51	23.91	23.22
	3RB High (3)	1779.3	24.76	23.55	22.93
		1745	24.52	23.56	23.03
		1710.7	24.54	23.65	23.15
	3RB Middle (1)	1779.3	24.71	23.65	23.31
		1745	24.56	23.57	23.03
		1710.7	24.56	23.74	23.08
	3RB Low (0)	1779.3	24.73	23.64	22.81
		1745	24.51	23.57	23.11
		1710.7	24.53	23.65	23.06
	6RB (0)	1779.3	23.47	22.61	21.91
		1745	23.51	22.63	21.93
		1710.7	23.51	22.42	22.06
3 MHz	1RB High (14)	1778.5	24.35	23.56	23.37
		1745	24.63	23.41	23.23
		1711.5	24.47	23.86	23.10
	1RB Middle (7)	1778.5	24.43	23.53	23.05
		1745	24.62	23.51	23.21
		1711.5	24.56	23.99	23.15
	1RB Low (0)	1778.5	24.41	23.62	23.16
		1745	24.63	23.54	23.32
		1711.5	24.58	24.03	23.27
	8RB High (7)	1778.5	23.50	22.54	22.01
		1745	23.50	22.65	22.06
		1711.5	23.52	22.53	22.06
	8RB Middle (4)	1778.5	23.48	22.53	22.02
		1745	23.55	22.64	22.12
		1711.5	23.57	22.60	22.13
8RB Low (0)	1778.5	23.57	22.59	22.08	
	1745	23.50	22.59	22.14	
	1711.5	23.60	22.61	22.17	
15RB	1778.5	23.44	22.45	21.99	

	(0)	1745	23.55	22.55	22.25
		1711.5	23.54	22.59	22.07
5 MHz	1RB High (24)	1777.5	24.59	23.64	23.24
		1745	24.68	23.81	23.20
		1712.5	24.67	24.08	23.16
	1RB Middle (12)	1777.5	24.27	23.58	23.05
		1745	24.72	23.75	23.13
		1712.5	24.63	23.99	23.12
	1RB Low (0)	1777.5	24.64	23.69	23.24
		1745	24.85	23.90	23.31
		1712.5	24.83	24.16	23.38
	12RB High (13)	1777.5	23.46	22.41	22.01
		1745	23.56	22.62	22.17
		1712.5	23.55	22.67	22.16
	12RB Middle (6)	1777.5	23.62	22.61	22.12
		1745	23.61	22.64	22.13
		1712.5	23.57	22.72	22.11
	12RB Low (0)	1777.5	23.57	22.60	21.99
		1745	23.59	22.63	22.09
		1712.5	23.62	22.75	22.19
	25RB (0)	1777.5	23.61	22.46	21.99
		1745	23.59	22.58	22.08
		1712.5	23.50	22.59	22.04
10 MHz	1RB High (49)	1775	25.02	24.30	23.47
		1745	24.99	24.04	23.44
		1715	25.10	23.95	23.46
	1RB Middle (24)	1775	24.58	23.92	23.07
		1745	24.56	23.60	23.09
		1715	24.53	23.48	23.06
	1RB Low (0)	1775	23.91	23.30	22.48
		1745	23.90	22.94	22.61
		1715	24.03	22.94	22.71
	25RB High (25)	1775	23.79	22.69	22.18
		1745	23.76	22.81	22.18
		1715	23.65	22.71	22.20
	25RB Middle (12)	1775	23.62	22.65	22.08
		1745	23.66	22.74	22.03
		1715	23.60	22.61	22.13
	25RB Low (0)	1775	23.53	22.51	21.89
		1745	23.53	22.59	21.98
		1715	23.46	22.49	21.95
	50RB (0)	1775	23.62	22.61	21.93
		1745	23.59	22.60	22.06
		1715	23.62	22.56	22.03
15 MHz	1RB High (74)	1772.5	24.99	24.27	23.30
		1745	24.90	24.21	23.30
		1717.5	25.11	23.94	23.39
	1RB	1772.5	24.86	23.99	23.09

	Middle (37)	1745	24.75	24.03	23.17	
		1717.5	24.82	23.70	23.31	
		1772.5	25.11	24.32	23.34	
	1RB Low (0)	1745	25.09	24.35	23.46	
		1717.5	24.98	23.97	23.39	
		1772.5	23.64	22.69	21.91	
	36RB High (38)	1745	23.59	22.59	22.01	
		1717.5	23.77	22.70	22.00	
		1772.5	23.64	22.63	21.87	
	36RB Middle (19)	1745	23.59	22.58	22.05	
		1717.5	23.83	22.79	22.13	
		1772.5	23.68	22.77	22.04	
	36RB Low (0)	1745	23.66	22.64	22.13	
		1717.5	23.90	22.82	22.32	
		1772.5	23.69	22.73	22.02	
	75RB (0)	1745	23.58	22.60	22.05	
		1717.5	23.78	22.79	22.23	
		1770	24.91	24.41	23.24	
	20 MHz	1RB High (99)	1745	25.10	24.44	23.34
			1720	25.15	24.37	23.42
			1770	24.45	23.87	23.04
		1RB Middle (50)	1745	24.51	24.06	22.98
			1720	24.68	24.06	23.45
			1770	24.35	23.72	23.05
		1RB Low (0)	1745	24.19	23.84	23.01
			1720	24.49	23.95	23.15
			1770	23.67	22.65	22.01
50RB High (50)		1745	23.66	22.59	22.12	
		1720	23.82	22.91	22.28	
		1770	23.60	22.58	22.10	
50RB Middle (25)		1745	23.55	22.56	21.97	
		1720	23.74	22.85	22.24	
		1770	23.53	22.52	22.03	
50RB Low (0)		1745	23.50	22.53	22.03	
		1720	23.66	22.74	22.17	
		1770	23.58	22.57	21.96	
100RB (0)		1745	23.54	22.55	21.98	
		1720	23.71	22.72	22.13	

Power Level C1

Band 66					
Bandwidth (MHz)	RB allocation	Frequency (MHz)	QPSK	16QAM	64QAM
	RB offset (Start RB)		Actual output power (dBm)	Actual output power (dBm)	Actual output power (dBm)
1.4 MHz	1RB High (5)	1779.3	21.39	20.46	19.33
		1745	21.48	20.61	19.63
		1710.7	21.61	21.02	19.99
	1RB Middle (3)	1779.3	21.47	20.55	19.49
		1745	21.51	20.68	19.71
		1710.7	21.71	21.06	19.78
	1RB Low (0)	1779.3	21.43	20.50	19.56
		1745	21.51	20.66	19.65
		1710.7	21.64	21.04	19.69
	3RB High (3)	1779.3	21.54	20.60	19.52
		1745	21.52	20.58	19.49
		1710.7	21.59	20.78	19.83
	3RB Middle (1)	1779.3	21.55	20.65	19.60
		1745	21.55	20.69	19.53
		1710.7	21.63	20.83	19.84
	3RB Low (0)	1779.3	21.51	20.63	19.54
		1745	21.47	20.58	19.53
		1710.7	21.62	20.81	19.80
	6RB (0)	1779.3	20.40	19.61	18.43
		1745	20.48	19.63	18.45
		1710.7	20.61	19.55	18.71
3 MHz	1RB High (14)	1778.5	21.41	20.44	19.90
		1745	21.51	20.49	19.70
		1711.5	21.64	20.96	19.96
	1RB Middle (7)	1778.5	21.54	20.52	19.59
		1745	21.51	20.52	19.70
		1711.5	21.74	21.07	19.82
	1RB Low (0)	1778.5	21.49	20.55	19.61
		1745	21.55	20.54	19.58
		1711.5	21.72	21.08	20.02
	8RB High (7)	1778.5	20.50	19.54	18.46
		1745	20.59	19.64	18.53
		1711.5	20.61	19.66	18.45
	8RB Middle (4)	1778.5	20.50	19.61	18.50
		1745	20.55	19.72	18.52
		1711.5	20.72	19.76	18.70
8RB Low (0)	1778.5	20.51	19.53	18.32	
	1745	20.51	19.65	18.50	
	1711.5	20.72	19.76	18.63	
15RB	1778.5	20.51	19.47	18.43	

	(0)	1745	20.49	19.57	18.37	
		1711.5	20.69	19.69	18.67	
5 MHz	1RB High (24)	1777.5	21.51	20.60	19.82	
		1745	21.54	20.68	19.70	
		1712.5	21.65	21.13	19.72	
	1RB Middle (12)	1777.5	21.61	20.58	19.63	
		1745	21.62	20.71	19.86	
		1712.5	21.63	21.09	19.98	
	1RB Low (0)	1777.5	21.64	20.77	19.63	
		1745	21.84	20.92	19.90	
		1712.5	21.81	21.29	19.99	
	12RB High (13)	1777.5	20.47	19.49	18.48	
		1745	20.60	19.65	18.63	
		1712.5	20.63	19.84	18.50	
	12RB Middle (6)	1777.5	20.48	19.58	18.48	
		1745	20.62	19.65	18.55	
		1712.5	20.65	19.82	18.58	
	12RB Low (0)	1777.5	20.62	19.67	18.58	
		1745	20.66	19.71	18.66	
		1712.5	20.77	19.93	18.72	
	25RB (0)	1777.5	20.68	19.60	18.53	
		1745	20.54	19.59	18.52	
		1712.5	20.78	19.81	18.67	
	10 MHz	1RB High (49)	1775	21.84	20.88	19.99
			1745	22.11	20.97	19.99
			1715	22.03	21.38	20.00
1RB Middle (24)		1775	21.51	20.55	19.50	
		1745	21.48	20.44	19.68	
		1715	21.62	20.95	19.59	
1RB Low (0)		1775	20.91	19.98	18.99	
		1745	20.89	19.84	19.06	
		1715	21.05	20.39	19.27	
25RB High (25)		1775	20.61	19.70	18.61	
		1745	20.60	19.71	18.57	
		1715	20.61	19.70	18.68	
25RB Middle (12)		1775	20.60	19.67	18.58	
		1745	20.61	19.59	18.53	
		1715	20.62	19.73	18.64	
25RB Low (0)		1775	20.50	19.58	18.54	
		1745	20.49	19.51	18.51	
		1715	20.56	19.61	18.60	
50RB (0)		1775	20.63	19.67	18.48	
		1745	20.69	19.65	18.58	
		1715	20.61	19.69	18.64	
15 MHz		1RB High (74)	1772.5	21.69	21.03	19.68
			1745	21.64	21.01	19.72
			1717.5	21.87	20.81	19.96
	1RB	1772.5	21.61	20.88	19.67	

	Middle (37)	1745	21.61	20.96	19.80	
		1717.5	21.62	20.64	19.92	
		1772.5	21.74	20.97	19.78	
	1RB Low (0)	1745	21.86	21.16	20.01	
		1717.5	21.86	20.77	20.05	
		1772.5	20.43	19.58	18.45	
	36RB High (38)	1745	20.47	19.48	18.30	
		1717.5	20.61	19.63	18.49	
		1772.5	20.54	19.65	18.53	
	36RB Middle (19)	1745	20.65	19.58	18.57	
		1717.5	20.73	19.71	18.59	
		1772.5	20.61	19.65	18.61	
	36RB Low (0)	1745	20.62	19.64	18.64	
		1717.5	20.76	19.71	18.68	
		1772.5	20.52	19.60	18.43	
	75RB (0)	1745	20.50	19.56	18.51	
		1717.5	20.61	19.70	18.61	
		1770	21.86	21.37	20.39	
	20 MHz	1RB High (99)	1745	21.82	21.32	20.35
			1720	21.91	21.36	20.29
			1770	21.60	20.97	20.33
		1RB Middle (50)	1745	21.50	20.96	20.41
			1720	21.63	21.03	20.35
			1770	21.28	20.73	19.97
		1RB Low (0)	1745	21.20	20.79	20.18
			1720	21.36	20.75	20.30
			1770	20.50	19.54	19.23
50RB High (50)		1745	20.52	19.63	19.24	
		1720	20.78	19.77	19.33	
		1770	20.51	19.52	19.23	
50RB Middle (25)		1745	20.61	19.61	19.38	
		1720	20.65	19.72	19.27	
		1770	20.38	19.38	19.13	
50RB Low (0)		1745	20.44	19.48	19.15	
		1720	20.61	19.62	19.42	
		1770	20.49	19.50	19.17	
100RB (0)		1745	20.57	19.55	19.24	
		1720	20.64	19.70	19.38	

Power Level A1/ C1

Band 71						
Bandwidth (MHz)	RB allocation	Frequency (MHz)	QPSK	16QAM	64QAM	
	RB offset (Start RB)		Actual output power (dBm)	Actual output power (dBm)	Actual output power (dBm)	
5 MHz	1RB High (24)	695.5	21.89	21.45	20.17	
		680.5	21.66	21.62	20.34	
		665.5	21.98	21.54	20.26	
	1RB Middle (12)	695.5	21.79	21.34	20.06	
		680.5	21.66	21.66	20.38	
		665.5	21.97	21.41	20.13	
	1RB Low (0)	695.5	21.89	21.49	20.21	
		680.5	21.60	21.60	20.32	
		665.5	21.91	21.52	20.24	
	12RB High (13)	695.5	21.35	20.32	19.04	
		680.5	21.15	20.24	18.96	
		665.5	21.24	20.25	18.97	
	12RB Middle (6)	695.5	21.29	20.27	18.99	
		680.5	21.17	20.33	19.05	
		665.5	21.30	20.30	19.02	
	12RB Low (0)	695.5	21.24	20.27	18.99	
		680.5	21.13	20.26	18.98	
		665.5	21.24	20.39	19.11	
	25RB (0)	695.5	21.25	20.26	18.98	
		680.5	21.15	20.15	18.87	
		665.5	21.35	20.33	19.05	
	10 MHz	1RB High (49)	693	21.69	21.32	20.04
			680.5	21.82	21.22	19.94
			668	21.58	21.67	20.39
1RB Middle (24)		693	21.80	21.37	20.09	
		680.5	21.72	21.16	19.88	
		668	21.72	21.65	20.37	
1RB Low (0)		693	21.78	21.43	20.15	
		680.5	21.81	21.19	19.91	
		668	21.75	21.74	20.46	
25RB High (25)		693	21.26	20.33	19.05	
		680.5	21.15	20.23	18.95	
		668	21.25	20.34	19.06	
25RB Middle (12)		693	21.31	20.39	19.11	
		680.5	21.19	20.20	18.92	
		668	21.31	20.37	19.09	
25RB Low (0)		693	21.32	20.39	19.11	
		680.5	21.17	20.18	18.90	
		668	21.25	20.31	19.03	
50RB		693	21.36	20.39	19.11	

	(0)	680.5	21.26	20.26	18.98
		668	21.38	20.39	19.11
15 MHz	1RB High (74)	690.5	22.22	21.67	20.39
		680.5	21.94	21.76	20.48
		670.5	22.14	22.01	20.73
	1RB Middle (37)	690.5	22.15	21.53	20.25
		680.5	21.98	21.83	20.55
		670.5	22.25	22.06	20.78
	1RB Low (0)	690.5	22.25	21.65	20.37
		680.5	22.12	21.91	20.63
		670.5	22.32	22.23	20.95
	36RB High (38)	690.5	21.68	20.56	19.28
		680.5	21.55	20.55	19.27
		670.5	21.67	20.60	19.32
	36RB Middle (19)	690.5	21.64	20.64	19.36
		680.5	21.50	20.51	19.23
		670.5	21.72	20.66	19.38
	36RB Low (0)	690.5	21.54	20.49	19.21
		680.5	21.64	20.61	19.33
		670.5	21.82	20.81	19.53
	75RB (0)	690.5	21.70	20.60	19.32
		680.5	21.55	20.58	19.30
		670.5	21.76	20.71	19.43
20 MHz	1RB High (99)	688	22.16	22.20	20.92
		683	22.01	22.02	20.74
		673	22.22	22.21	20.93
	1RB Middle (50)	688	22.08	22.07	20.79
		683	21.90	21.85	20.57
		673	22.15	22.00	20.72
	1RB Low (0)	688	22.19	22.21	20.93
		683	22.20	22.22	20.94
		673	22.46	22.44	21.16
	50RB High (50)	688	21.48	20.47	19.19
		683	21.52	20.49	19.21
		673	21.59	20.60	19.32
	50RB Middle (25)	688	21.44	20.44	19.16
		683	21.48	20.50	19.22
		673	21.74	20.73	19.45
	50RB Low (0)	688	21.57	20.52	19.24
		683	21.59	20.51	19.23
		673	21.78	20.81	19.53
	100RB (0)	688	21.56	20.56	19.28
		683	21.53	20.50	19.22
		673	21.68	20.80	19.52

Power Level B1

Band 71						
Bandwidth (MHz)	RB allocation	Frequency (MHz)	QPSK	16QAM	64QAM	
	RB offset (Start RB)		Actual output power (dBm)	Actual output power (dBm)	Actual output power (dBm)	
5 MHz	1RB High (24)	695.5	24.49	23.34	22.75	
		680.5	24.18	23.27	22.40	
		665.5	24.22	23.63	22.67	
	1RB Middle (12)	695.5	24.30	23.31	22.64	
		680.5	24.12	23.26	22.73	
		665.5	24.52	23.70	22.74	
	1RB Low (0)	695.5	24.41	23.41	22.57	
		680.5	24.36	23.40	22.53	
		665.5	24.32	23.72	22.43	
	12RB High (13)	695.5	23.18	22.16	21.51	
		680.5	23.19	22.27	21.43	
		665.5	23.19	22.31	21.36	
	12RB Middle (6)	695.5	23.17	22.23	21.50	
		680.5	23.18	22.22	21.38	
		665.5	23.28	22.41	21.53	
	12RB Low (0)	695.5	23.32	22.33	21.54	
		680.5	23.18	22.25	21.39	
		665.5	23.31	22.42	21.47	
	25RB (0)	695.5	23.23	22.15	21.40	
		680.5	23.21	22.28	21.73	
		665.5	23.21	22.26	21.44	
	10 MHz	1RB High (49)	693	24.09	23.25	23.29
			680.5	24.22	23.16	23.08
			668	24.23	23.57	22.76
1RB Middle (24)		693	24.02	23.26	22.93	
		680.5	24.21	23.16	22.70	
		668	24.59	23.73	22.91	
1RB Low (0)		693	24.13	23.28	22.30	
		680.5	24.34	23.25	22.83	
		668	24.72	23.81	22.74	
25RB High (25)		693	23.10	22.22	21.81	
		680.5	23.20	22.13	21.65	
		668	23.06	22.15	21.53	
25RB Middle (12)		693	23.15	22.35	21.89	
		680.5	23.34	22.26	21.77	
		668	23.19	22.34	21.82	
25RB Low (0)		693	23.29	22.40	21.70	
		680.5	23.27	22.26	21.82	
		668	23.21	22.33	21.80	
50RB		693	23.19	22.11	21.75	

	(0)	680.5	23.16	22.13	21.68
		668	23.18	22.07	21.72
15 MHz	1RB High (74)	690.5	24.57	23.75	22.24
		680.5	24.31	23.10	22.15
		670.5	24.32	23.74	23.10
	1RB Middle (37)	690.5	24.49	23.66	21.91
		680.5	24.18	23.10	21.89
		670.5	24.32	23.88	23.12
	1RB Low (0)	690.5	24.57	23.85	22.59
		680.5	24.44	23.29	22.57
		670.5	24.55	23.88	23.44
	36RB High (38)	690.5	23.36	22.25	20.91
		680.5	23.22	22.15	20.73
		670.5	23.43	22.48	21.93
	36RB Middle (19)	690.5	23.39	22.32	20.87
		680.5	23.26	22.22	20.81
		670.5	23.39	22.43	21.96
	36RB Low (0)	690.5	23.40	22.30	20.97
		680.5	23.42	22.35	20.98
		670.5	23.34	22.48	22.03
	75RB (0)	690.5	23.34	22.28	20.83
		680.5	23.30	22.26	20.83
		670.5	23.43	22.45	21.94
20 MHz	1RB High (99)	688	24.51	23.87	23.11
		683	24.41	24.07	22.14
		673	24.43	24.06	22.04
	1RB Middle (50)	688	24.42	23.78	22.99
		683	24.33	23.86	22.12
		673	24.55	24.03	22.41
	1RB Low (0)	688	24.56	23.97	23.29
		683	24.60	24.37	22.37
		673	24.59	24.09	22.58
	50RB High (50)	688	23.38	22.31	21.81
		683	23.42	22.51	20.76
		673	23.49	22.49	20.96
	50RB Middle (25)	688	23.42	22.42	21.88
		683	23.34	22.46	20.79
		673	23.52	22.46	21.05
	50RB Low (0)	688	23.50	22.44	21.99
		683	23.49	22.48	20.99
		673	23.59	22.61	21.16
	100RB (0)	688	23.44	22.41	21.93
		683	23.46	22.53	21.03
		673	23.47	22.61	21.03

11.5 Wi-Fi and BT Measurement result

The maximum output power of BT is 8.87dBm.

The maximum tune up of BT is 9dBm.

Low power for WLAN by Simultaneous transmission.

The average conducted power for Wi-Fi is as following:

Normal Power

802.11b(dBm)									
Channel\data rate	1Mbps	2Mbps	5.5Mbps	11Mbps					
11(2462MHz)	17.68								
6(2437MHz)	18.12	17.88	16.83	15.70					
1(2412MHz)	17.96								
Tune up	19.00	19.00	18.00	17.00					
802.11g(dBm)									
Channel\data rate	6Mbps	9Mbps	12Mbps	18Mbps	24Mbps	36Mbps	48Mbps	54Mbps	
11(2462MHz)	16.84	17.41							
6(2437MHz)	17.21	17.88	16.66	16.62	16.56	16.05	15.53	14.97	
1(2412MHz)	17.03	17.66							
Tune up	18.00	18.00	17.50	17.50	17.50	17.00	16.50	16.00	
802.11n(dBm)-20MHz									
Channel\data rate	MCS0	MCS1	MCS2	MCS3	MCS4	MCS5	MCS6	MCS7	
11(2462MHz)	16.35								
6(2437MHz)	16.63	16.61	16.62	16.61	16.08	16.11	15.48	15.45	
1(2412MHz)	16.46								
Tune up	17.00	17.00	17.00	17.00	17.00	17.00	16.50	16.50	
802.11n(dBm)-40MHz									
Channel\data rate	MCS0	MCS1	MCS2	MCS3	MCS4	MCS5	MCS6	MCS7	
9(2452MHz)	16.40								
6(2437MHz)	16.30								
3(2422MHz)	16.45	15.42	15.33	15.26	15.21	14.11	13.51	13.48	
Tune up	17.00	16.50	15.50	15.50	15.50	14.50	14.00	14.00	

802.11ac(dBm)-80MHz										
Channel\data rate	MCS0	MCS1	MCS2	MCS3	MCS4	MCS5	MCS6	MCS7	MCS8	MCS9
42(5210 MHz)	13.84	13.71	13.59	12.97	12.83	12.41	12.32	11.27	11.26	11.21
58(5290 MHz)	13.40	13.24	13.14	12.62	12.49	11.99	11.90	10.91	10.86	10.84
Tune up	15.00	14.50	14.50	14.00	14.00	13.50	13.50	12.50	12.50	12.50
106(5530 MHz)	13.76									
122(5610 MHz)	13.96	13.75	13.69	13.02	12.88	12.43	12.31	11.30	11.27	11.16
138(5690 MHz)	13.71									
155(5775 MHz)	14.30	14.20	14.03	13.41	13.25	12.75	12.72	11.65	11.64	11.61
Tune up	15.00	15.00	15.00	14.50	14.50	14.00	14.00	13.00	13.00	13.00



Low Power

802.11b(dBm)									
Channel\data rate	1Mbps	2Mbps	5.5Mbps	11Mbps					
11(2462MHz)	12.36								
6(2437MHz)	12.67	12.63	12.64	12.64					
1(2412MHz)	12.50								
Tune up	13.00	13.00	13.00	13.00					

802.11g(dBm)								
Channel\data rate	6Mbps	9Mbps	12Mbps	18Mbps	24Mbps	36Mbps	48Mbps	54Mbps
11(2462MHz)	12.86							
6(2437MHz)	13.14	13.10	13.12	13.11	13.03	13.05	13.02	13.01
1(2412MHz)	12.92							
Tune up	13.30	13.30	13.30	13.30	13.30	13.30	13.30	13.30

802.11n(dBm)-20MHz								
Channel\data rate	MCS0	MCS1	MCS2	MCS3	MCS4	MCS5	MCS6	MCS7
11(2462MHz)	12.89							
6(2437MHz)	13.18	13.14	13.17	13.13	13.11	13.09	13.05	13.02
1(2412MHz)	12.97							
Tune up	13.30	13.30	13.30	13.30	13.30	13.30	13.30	13.30

802.11n(dBm)-40MHz								
Channel\data rate	MCS0	MCS1	MCS2	MCS3	MCS4	MCS5	MCS6	MCS7
9(2452MHz)	12.05							
6(2437MHz)	11.97							
3(2422MHz)	12.09	12.04	12.08	12.01	11.97	11.93	11.92	11.89
Tune up	12.50	12.50	12.50	12.50	12.50	12.50	12.50	12.50

802.11ac(dBm)-80MHz										
Channel\data rate	MCS0	MCS1	MCS2	MCS3	MCS4	MCS5	MCS6	MCS7	MCS8	MCS9
42(5210 MHz)	10.22	10.04	9.95	9.86	9.63	9.67	9.56	9.62	9.55	9.57
58(5290 MHz)	9.73	9.56	9.45	9.38	9.22	9.23	9.17	9.14	9.15	9.10
106(5530 MHz)	10.00									
122(5610 MHz)	10.19	9.97	9.96	9.89	9.67	9.70	9.59	9.58	9.53	9.49
138(5690 MHz)	10.05									
155(5775 MHz)	10.56	10.40	10.25	10.23	10.06	10.10	10.02	10.00	9.98	9.97
Tune up	11.00	11.00	11.00	11.00	11.00	11.00	11.00	11.00	11.00	11.00

12 Simultaneous TX SAR Considerations

12.1 Introduction

The following procedures adopted from “FCC SAR Considerations for Cell Phones with Multiple Transmitters” are applicable to handsets with built-in unlicensed transmitters such as 802.11 a/b/g and Bluetooth devices which may simultaneously transmit with the licensed transmitter. For this device, the BT and Wi-Fi can transmit simultaneous with other transmitters.

12.2 Transmit Antenna Separation Distances

Please refer to the picture of antenna locations in the document: “The Photos of SAR test-I20Z70377”

12.3 SAR Measurement Positions

According to the KDB941225 D06 Hot Spot SAR v01, the edges with less than 2.5 cm distance to the antennas need to be tested for SAR.

SAR measurement positions						
Mode	Front	Rear	Left edge	Right edge	Top edge	Bottom edge
Main ANT	Yes	Yes	Yes	Yes	No	Yes
Diversity ANT	Yes	Yes	Yes	No	Yes	No
WIFI ANT	Yes	Yes	No	Yes	Yes	No

12.4 Standalone SAR Test Exclusion Considerations

Standalone 1-g head or body SAR evaluation by measurement or numerical simulation is not required when the corresponding SAR Exclusion Threshold condition, listed below, is satisfied. The 1-g SAR test exclusion threshold for 100 MHz to 6 GHz at test separation distances ≤ 50 mm are determined by:

$$\left[\frac{\text{(max. power of channel, including tune-up tolerance, mW)}}{\text{(min. test separation distance, mm)}} \right] \cdot \sqrt{f(\text{GHz})} \leq 3.0$$
 for 1-g SAR, where

- $f(\text{GHz})$ is the RF channel transmit frequency in GHz
- Power and distance are rounded to the nearest mW and mm before calculation
- The result is rounded to one decimal place for comparison

Table 12.1: Standalone SAR test exclusion considerations

Band/Mode	F(GHz)	Position	SAR test exclusion threshold(mW)	RF output power		SAR test exclusion
				dBm	mW	
Bluetooth	2.441	Head	9.60	9	7.94	Yes
		Body	19.20	9	7.94	Yes
2.4GHz WLAN	2.45	Head	9.58	19	79.43	No
		Body	19.17	19	79.43	No
5GHz WLAN	5.2	Head	6.58	15	31.62	No
		Body	13.16	15	31.62	No
	5.3	Head	6.52	15	31.62	No
		Body	13.03	15	31.62	No
	5.6	Head	6.34	15.5	35.48	No
		Body	12.68	15.5	35.48	No
5.8	Head	6.23	15.5	35.48	No	
	Body	12.46	15.5	35.48	No	

13 Evaluation of Simultaneous

Table 13.1: The sum of SAR values for Main antenna + WiFi-2.4G

	Position	Band	Cellular antenna	WiFi-2.4G	Sum
Highest reported SAR value for Head	Right hand, Cheek	LTE Band25	1.00	0.05	1.05
Highest SAR value for Body	Right 10mm	LTE Band71	0.66	0.36	1.02

Table 13.2: The sum of SAR values for Main antenna + WiFi-5G

	Position	Band	Cellular antenna	WiFi-5G	Sum
Highest SAR value for Head	Right hand, Cheek	LTE Band25	1.00	0.26	1.26
Maximum reported SAR value for Body	Rear 10mm	GSM850	0.66	0.74	1.40

Table 13.3: The sum of SAR values for Main antenna + WiFi-5G +BT

	Position	Band	Cellular antenna	WiFi-5G	BT	Sum
Highest SAR value for Head	Right hand, Cheek	LTE Band25	1.00	0.26	<0.01	1.26
Maximum reported SAR value for Body	Rear 10mm	GSM850	0.66	0.74	<0.01	1.40

Note1: the test positions of above tables are for the worse case that have been evaluated.

[1] – The SAR of BT is too low to get it, so the “<0.01” is used to indicate the head SAR of BT.

14 SAR Test Result

It is determined by user manual for the distance between the EUT and the phantom bottom. The distance is 10 mm or 15mm and just applied to the condition of body worn accessory.

It is performed for all SAR measurements with area scan based 1-g SAR estimation (Fast SAR). A zoom scan measurement is added when the estimated 1-gSAR is the highest measured SAR in each exposure configuration, wireless mode and frequency band combination or more than 1.2W/kg.

The calculated SAR is obtained by the following formula:

$$\text{Reported SAR} = \text{Measured SAR} \times 10^{(P_{\text{Target}} - P_{\text{Measured}})/10}$$

Where P_{Target} is the power of manufacturing upper limit;

P_{Measured} is the measured power in chapter 11.

Table 14.1: Duty Cycle

Mode	Duty Cycle
Speech for GSM850/1900	1:4
GPRS&EGPRS for GSM850/1900	1:4
WCDMA<E FDD	1:1
LTE B41 PC2	1:2.309
LTE B41 PC3	1:1.58

14.1 SAR results for Fast SAR

Table 14.1-1: SAR Values (GSM 850 MHz Band - Head)

Frequency		Side	Test Position	Figure No.	Conducted Power (dBm)	Max. tune-up Power (dBm)	Measured SAR(10g) (W/kg)	Reported SAR(10g) (W/kg)	Measured SAR(1g) (W/kg)	Reported SAR(1g) (W/kg)	Power Drift (dB)
Ch.	MHz										
Ambient Temperature: 22.9 °C Liquid Temperature: 22.5 °C											
190	836.6	Left	Touch	/	30.88	32.00	0.114	0.15	0.171	0.22	-0.03
190	836.6	Left	Tilt	/	30.88	32.00	0.072	0.09	0.105	0.14	-0.02
251	848.8	Right	Touch	Fig.1	30.89	32.00	0.182	0.24	0.281	0.36	0.03
190	836.6	Right	Touch	/	30.88	32.00	0.137	0.18	0.212	0.27	-0.04
128	824.2	Right	Touch	/	31.20	32.00	0.121	0.15	0.189	0.23	0.10
190	836.6	Right	Tilt	/	30.88	32.00	0.088	0.11	0.132	0.17	0.13

Note: the head SAR of GSM850 is tested with GPRS (2Txslots) mode because of VoIP.

Table 14.1-2: SAR Values (GSM 850 MHz Band - Body)

Frequency		Mode (number of timeslots)	Test Position	Figure No.	Conducted Power (dBm)	Max. tune-up Power (dBm)	Measured SAR(10g) (W/kg)	Reported SAR(10g) (W/kg)	Measured SAR(1g) (W/kg)	Reported SAR(1g) (W/kg)	Power Drift (dB)
Ch.	MHz										
Ambient Temperature: 22.9 °C Liquid Temperature: 22.5 °C											
190	836.6	GPRS (2)	Front	/	30.88	32.00	0.133	0.17	0.280	0.36	0.09
251	848.8	GPRS (2)	Rear	Fig.2	30.89	32.00	0.242	0.31	0.513	0.66	0.08
190	836.6	GPRS (2)	Rear		30.88	32.00	0.227	0.29	0.498	0.64	0.02
128	824.2	GPRS (2)	Rear		31.20	32.00	0.208	0.25	0.426	0.51	0.09
190	836.6	GPRS (2)	Left	/	30.88	32.00	0.110	0.14	0.247	0.32	0.06
190	836.6	GPRS (2)	Right	/	30.88	32.00	0.132	0.17	0.295	0.38	0.10
190	836.6	GPRS (2)	Bottom	/	30.88	32.00	<0.01	<0.01	<0.01	<0.01	/
251	848.8	EGPRS (2)	Rear	/	30.90	32.00	0.231	0.30	0.504	0.65	-0.12

Note: The distance between the EUT and the phantom bottom is 10mm.

Table 14.1-3: SAR Values (GSM 1900 MHz Band - Head)

Frequency		Side	Test Position	Figure No.	Conducted Power (dBm)	Max. tune-up Power (dBm)	Measured SAR(10g) (W/kg)	Reported SAR(10g) (W/kg)	Measured SAR(1g) (W/kg)	Reported SAR(1g) (W/kg)	Power Drift (dB)
Ch.	MHz										
Ambient Temperature: 22.9 °C Liquid Temperature: 22.5 °C											
661	1880	Left	Touch		20.44	21.50	0.096	0.12	0.194	0.25	-0.10
661	1880	Left	Tilt	/	20.44	21.50	0.078	0.10	0.144	0.18	0.09
810	1909.8	Right	Touch	/	20.25	21.50	0.160	0.21	0.313	0.42	0.08
661	1880	Right	Touch		20.44	21.50	0.145	0.19	0.286	0.37	-0.12
512	1850.2	Right	Touch	Fig.3	20.51	21.50	0.182	0.23	0.362	0.45	0.02
661	1880	Right	Tilt	/	20.44	21.50	0.143	0.18	0.282	0.36	0.04

Note: the head SAR of GSM1900 is tested with GPRS (2Txslots) mode because of VoIP.

Table 14.1-4: SAR Values (GSM 1900 MHz Band - Body)

Frequency		Mode (number of timeslots)	Test Position	Figure No./ Note	Conducted Power (dBm)	Max. tune-up Power (dBm)	Measured SAR(10g) (W/kg)	Reported SAR(10g) (W/kg)	Measured SAR(1g) (W/kg)	Reported SAR(1g) (W/kg)	Power Drift (dB)
Ch.	MHz										
Ambient Temperature: 22.9 °C Liquid Temperature: 22.5 °C											
810	1909.8	GPRS (2)	Front	Note1 Fig.4	28.57	29.50	0.204	0.25	0.442	0.55	-0.08
661	1880	GPRS (2)	Front	Note1	28.79	29.50	0.170	0.20	0.376	0.44	0.00
512	1850.2	GPRS (2)	Front	Note1	28.84	29.50	0.191	0.22	0.421	0.49	0.05
661	1880	GPRS (2)	Rear	Note2	28.79	29.50	0.158	0.19	0.346	0.41	-0.10
661	1880	GPRS (2)	Left	/	28.79	29.50	0.171	0.20	0.358	0.42	0.13
661	1880	GPRS (2)	Top	Note3	28.79	29.50	0.109	0.13	0.234	0.28	0.13
661	1880	GPRS (2)	Front	/	20.44	21.50	0.038	0.05	0.072	0.09	-0.12
661	1880	GPRS (2)	Rear	/	20.44	21.50	0.059	0.08	0.115	0.15	-0.07
661	1880	GPRS (2)	Top	/	20.44	21.50	0.035	0.04	0.066	0.08	0.11
810	1909.8	EGPRS (2)	Front	Note2	28.51	29.50	0.192	0.24	0.418	0.53	0.03

Note: The distance between the EUT and the phantom bottom is 10mm.

Note1: The distance between the EUT and the phantom bottom is 12mm.

Note2: The distance between the EUT and the phantom bottom is 19mm.

Note3: The distance between the EUT and the phantom bottom is 17mm.

Table 14.1-5: SAR Values (WCDMA 1900 MHz Band - Head)

Frequency		Side	Test Position	Figure No.	Conducted Power (dBm)	Max. tune-up Power (dBm)	Measured SAR(10g) (W/kg)	Reported SAR(10g) (W/kg)	Measured SAR(1g) (W/kg)	Reported SAR(1g) (W/kg)	Power Drift (dB)
Ch.	MHz										
Ambient Temperature: 22.9 °C Liquid Temperature: 22.5 °C											
9938	1907.6	Left	Touch	/	18.33	19.50	0.200	0.26	0.333	0.44	-0.08
9800	1880	Left	Touch	/	18.44	19.50	0.144	0.18	0.193	0.25	-0.08
9662	1852.4	Left	Touch	Fig.5	18.41	19.50	0.201	0.26	0.342	0.44	-0.12
9800	1880	Left	Tilt	/	18.44	19.50	0.110	0.14	0.158	0.20	-0.07
9800	1880	Right	Touch	/	18.44	19.50	0.088	0.11	0.129	0.16	-0.12
9800	1880	Right	Tilt	/	18.44	19.50	0.145	0.19	0.231	0.29	-0.04

Table 14.1-6: SAR Values (WCDMA 1900 MHz Band - Body)

Frequency		Test Position	Figure No./ Note	Conducted Power (dBm)	Max. tune-up Power (dBm)	Measured SAR(10g) (W/kg)	Reported SAR(10g) (W/kg)	Measured SAR(1g) (W/kg)	Reported SAR(1g) (W/kg)	Power Drift (dB)
Ch.	MHz									
Ambient Temperature: 22.9 °C Liquid Temperature: 22.5 °C										
9938	1907.6	Front	Note1	24.47	25.50	0.288	0.37	0.502	0.64	0.04
9800	1880	Front	Note1	24.73	25.50	0.274	0.33	0.509	0.61	-0.12
9662	1852.4	Front	Note1 Fig.6	24.57	25.50	0.311	0.39	0.547	0.68	-0.10
9800	1880	Rear	Note2	24.73	25.50	0.183	0.22	0.337	0.40	-0.08
9800	1880	Left	/	24.73	25.50	0.191	0.23	0.346	0.41	0.08
9800	1880	Top	Note3	24.73	25.50	0.177	0.21	0.315	0.38	0.08
9800	1880	Front	/	20.98	22.00	0.111	0.14	0.182	0.23	0.05
9800	1880	Rear	/	20.98	22.00	0.175	0.22	0.307	0.39	0.07
9800	1880	Top	/	18.44	19.50	0.087	0.11	0.156	0.20	0.03

Note: The distance between the EUT and the phantom bottom is 10mm.

Note1: The distance between the EUT and the phantom bottom is 12mm.

Note2: The distance between the EUT and the phantom bottom is 19mm.

Note3: The distance between the EUT and the phantom bottom is 17mm.

Table 14.1-7: SAR Values (WCDMA 1700 MHz Band - Head)

Frequency		Side	Test Position	Figure No.	Conducted Power (dBm)	Max. tune-up Power (dBm)	Measured SAR(10g) (W/kg)	Reported SAR(10g) (W/kg)	Measured SAR(1g) (W/kg)	Reported SAR(1g) (W/kg)	Power Drift (dB)
Ch.	MHz										
Ambient Temperature: 22.9 °C Liquid Temperature: 22.5°C											
1412	1732.4	Left	Touch	/	18.54	19.50	0.302	0.38	0.505	0.63	0.01
1412	1732.4	Left	Tilt	/	18.54	19.50	0.302	0.38	0.446	0.56	-0.12
1412	1732.4	Right	Touch	/	18.54	19.50	0.261	0.33	0.480	0.60	0.09
1513	1752.6	Right	Tilt	Fig.7	18.51	19.50	0.269	0.34	0.553	0.69	0.10
1412	1732.4	Right	Tilt	/	18.54	19.50	0.268	0.33	0.528	0.66	-0.08
1312	1712.4	Right	Tilt	/	18.39	19.50	0.259	0.33	0.482	0.62	-0.07

Table 14.1-8: SAR Values (WCDMA 1700 MHz Band - Body)

Frequency		Test Position	Figure No./ Note	Conducted Power (dBm)	Max. tune-up Power (dBm)	Measured SAR(10g) (W/kg)	Reported SAR(10g) (W/kg)	Measured SAR(1g) (W/kg)	Reported SAR(1g) (W/kg)	Power Drift (dB)
Ch.	MHz									
Ambient Temperature: 22.9 °C Liquid Temperature: 22.5°C										
9800	1880	Front	Note1	24.72	25.50	0.125	0.15	0.223	0.27	0.08
9800	1880	Rear	Note2	24.72	25.50	0.095	0.11	0.174	0.21	-0.06
9800	1880	Left	/	24.72	25.50	0.107	0.13	0.201	0.24	0.06
9800	1880	Top	Note3	24.72	25.50	0.068	0.08	0.108	0.13	0.01
9800	1880	Front	/	21.51	22.50	0.115	0.14	0.212	0.27	0.09
9938	1907.6	Rear	Fig.8	21.49	22.50	0.225	0.28	0.480	0.61	-0.13
9800	1880	Rear	/	21.51	22.50	0.189	0.24	0.384	0.48	-0.07
9662	1852.4	Rear	/	21.42	22.50	0.180	0.23	0.373	0.48	0.04
9800	1880	Top	/	18.54	19.50	0.081	0.10	0.145	0.18	0.13

Note: The distance between the EUT and the phantom bottom is 10mm.

Note1: The distance between the EUT and the phantom bottom is 12mm.

Note2: The distance between the EUT and the phantom bottom is 19mm.

Note3: The distance between the EUT and the phantom bottom is 17mm.

Table 14.1-9: SAR Values (WCDMA 850 MHz Band - Head)

Ambient Temperature: 22.9 °C						Liquid Temperature: 22.5 °C					
Frequency		Side	Test Position	Figure No.	Conducted Power (dBm)	Max. tune-up Power (dBm)	Measured SAR(10g) (W/kg)	Reported SAR(10g) (W/kg)	Measured SAR(1g) (W/kg)	Reported SAR(1g) (W/kg)	Power Drift (dB)
Ch.	MHz										
4233	846.6	Left	Touch	/	24.06	25.00	0.192	0.24	0.252	0.31	-0.11
4182	836.4	Left	Touch	Fig.9	24.09	25.00	0.225	0.28	0.294	0.36	-0.02
4132	826.4	Left	Touch	/	23.76	25.00	0.127	0.17	0.167	0.22	-0.12
4182	836.4	Left	Tilt	/	24.09	25.00	0.116	0.14	0.147	0.18	0.07
4182	836.4	Right	Touch	/	24.09	25.00	0.203	0.25	0.260	0.32	-0.01
4182	836.4	Right	Tilt	/	24.09	25.00	0.134	0.17	0.168	0.21	0.01

Table 14.1-10: SAR Values (WCDMA 850 MHz Band - Body)

Ambient Temperature: 22.9 °C						Liquid Temperature: 22.5 °C					
Frequency		Test Position	Figure No.	Conducted Power (dBm)	Max. tune-up Power (dBm)	Measured SAR(10g) (W/kg)	Reported SAR(10g) (W/kg)	Measured SAR(1g) (W/kg)	Reported SAR(1g) (W/kg)	Power Drift (dB)	
Ch.	MHz										
4182	836.4	Front	/	24.09	25.00	0.226	0.28	0.294	0.36	-0.03	
4233	846.6	Rear	/	24.06	25.00	0.297	0.37	0.396	0.49	-0.09	
4182	836.4	Rear	Fig.10	24.09	25.00	0.361	0.45	0.479	0.59	-0.04	
4132	826.4	Rear	/	23.76	25.00	0.279	0.37	0.370	0.49	-0.07	
4182	836.4	Left	/	24.09	25.00	0.212	0.26	0.305	0.38	0.00	
4182	836.4	Right	/	24.09	25.00	0.223	0.27	0.320	0.39	0.12	
4182	836.4	Bottom	/	24.09	25.00	0.060	0.07	0.118	0.15	-0.13	

Note: The distance between the EUT and the phantom bottom is 10mm.

Table 14.1-11: SAR Values (CDMA BC0 MHz Band - Head)

Ambient Temperature: 22.5 °C						Liquid Temperature: 22.0 °C					
Frequency		Side	Test Position	Figure No./ Note	Conducted Power (dBm)	Max. tune-up Power (dBm)	Measured SAR(10g) (W/kg)	Reported SAR(10g) (W/kg)	Measured SAR(1g) (W/kg)	Reported SAR(1g) (W/kg)	Power Drift (dB)
Ch.	MHz										
384	836.52	Left	Touch	/	24.98	25.50	0.244	0.28	0.320	0.36	0.07
384	836.52	Left	Tilt	/	24.98	25.50	0.121	0.14	0.154	0.17	0.01
777	848.31	Right	Touch		24.95	25.50	0.225	0.26	0.298	0.34	0.06
384	836.52	Right	Touch	Fig.11	24.98	25.50	0.268	0.30	0.354	0.40	-0.12
1013	824.7	Right	Touch		25.05	25.50	0.176	0.20	0.233	0.26	0.01
384	836.52	Right	Tilt	/	24.98	25.50	0.263	0.30	0.347	0.39	-0.1

Table 14.1-12: SAR Values (CDMA BC0 MHz Band - Body)

Frequency		Test Position	Figure No./Note	Ambient Temperature: 22.5°C		Liquid Temperature: 22.0°C		Reported SAR(1g) (W/kg)	Reported SAR(1g) (W/kg)	Power Drift (dB)
Ch.	MHz			Conducted Power (dBm)	Max. tune-up Power (dBm)	Measured SAR(10g) (W/kg)	Reported SAR(10g) (W/kg)			
384	836.52	Front	/	24.96	25.50	0.270	0.31	0.359	0.41	0.08
777	848.31	Rear	/	24.94	25.50	0.292	0.33	0.463	0.53	0.1
384	836.52	Rear	Fig.12	24.96	25.50	0.411	0.47	0.552	0.63	-0.05
1013	824.7	Rear	/	25.01	25.50	0.385	0.43	0.517	0.58	0.05
384	836.52	Left	/	24.96	25.50	0.193	0.22	0.286	0.32	0.11
384	836.52	Right	/	24.96	25.50	0.245	0.28	0.358	0.41	-0.13
384	836.52	Bottom	/	24.96	25.50	0.057	0.06	0.097	0.11	-0.05

Note: The distance between the EUT and the phantom bottom is 10mm.

Table 14.1-13: SAR Values (CDMA BC1 MHz Band - Head)

Frequency		Side	Test Position	Figure No./Note	Ambient Temperature: 22.5°C		Liquid Temperature: 22.0°C		Reported SAR(1g) (W/kg)	Reported SAR(1g) (W/kg)	Power Drift (dB)
Ch.	MHz				Conducted Power (dBm)	Max. tune-up Power (dBm)	Measured SAR(10g) (W/kg)	Reported SAR(10g) (W/kg)			
600	1880	Left	Touch		19.26	19.50	0.210	0.22	0.298	0.31	-0.03
600	1880	Left	Tilt	/	19.26	19.50	0.203	0.21	0.301	0.32	0.07
1175	1908.75	Right	Touch		19.17	19.50	0.371	0.40	0.589	0.64	0.04
600	1880	Right	Touch	Fig.13	19.26	19.50	0.307	0.32	0.641	0.68	-0.09
25	1851.25	Right	Touch		19.29	19.50	0.379	0.40	0.606	0.64	0.04
600	1880	Right	Tilt	/	19.26	19.50	0.330	0.35	0.584	0.62	-0.11

Table 14.1-14: SAR Values (CDMA BC1 MHz Band - Body)

Frequency		Test Position	Figure No./Note	Ambient Temperature: 22.5°C		Liquid Temperature: 22.0°C		Reported SAR(1g) (W/kg)	Reported SAR(1g) (W/kg)	Power Drift (dB)
Ch.	MHz			Conducted Power (dBm)	Max. tune-up Power (dBm)	Measured SAR(10g) (W/kg)	Reported SAR(10g) (W/kg)			
1175	1908.75	Front	Note1	25.03	25.50	0.251	0.28	0.430	0.48	0.13
600	1880	Front	Note1 Fig.14	25.16	25.50	0.281	0.30	0.485	0.52	0.06
25	1851.25	Front	Note1	25.20	25.50	0.258	0.28	0.457	0.49	-0.01
600	1880	Rear	Note2	25.16	25.50	0.227	0.25	0.396	0.43	-0.13
600	1880	Left	/	25.16	25.50	0.197	0.21	0.345	0.37	0.19
600	1880	Top	Note3	25.16	25.50	0.192	0.21	0.328	0.35	0.03
600	1880	Front	/	19.27	19.50	0.088	0.09	0.148	0.16	0.12
600	1880	Rear	/	19.27	19.50	0.141	0.15	0.263	0.28	-0.05
600	1880	Top	/	19.27	19.50	0.086	0.09	0.158	0.17	0.13

Note: The distance between the EUT and the phantom bottom is 10mm.

Note1: The distance between the EUT and the phantom bottom is 12mm.

Note2: The distance between the EUT and the phantom bottom is 19mm.

Note3: The distance between the EUT and the phantom bottom is 17mm.

Table 14.1-15: SAR Values (CDMA BC10 MHz Band - Head)

Frequency		Side	Test Position	Figure No./ Note	Conducted Power (dBm)	Max. tune-up Power (dBm)	Measured SAR(10g) (W/kg)	Reported SAR(10g) (W/kg)	Measured SAR(1g) (W/kg)	Reported SAR(1g) (W/kg)	Power Drift (dB)
Ch.	MHz										
Ambient Temperature: 22.5°C Liquid Temperature: 22.0°C											
684	823.1	Left	Touch	/	24.94	25.50	0.162	0.18	0.214	0.24	0.05
580	820.5	Left	Touch	/	25.08	25.50	0.175	0.19	0.230	0.25	-0.12
476	817.9	Left	Touch	Fig.15	25.07	25.50	0.221	0.24	0.291	0.32	-0.04
580	820.5	Left	Tilt	/	25.08	25.50	0.121	0.13	0.153	0.17	0.00
580	820.5	Right	Touch	/	25.08	25.50	0.147	0.16	0.191	0.21	0.01
580	820.5	Right	Tilt	/	25.08	25.50	0.075	0.08	0.099	0.11	-0.08

Table 14.1-16: SAR Values (CDMA BC10 MHz Band - Body)

Frequency		Test Position	Figure No./Note	Conducted Power (dBm)	Max. tune-up Power (dBm)	Measured SAR(10g) (W/kg)	Reported SAR(10g) (W/kg)	Measured SAR(1g) (W/kg)	Reported SAR(1g) (W/kg)	Power Drift (dB)
Ch.	MHz									
Ambient Temperature: 22.5°C Liquid Temperature: 22.0°C										
580	820.5	Front	Note1	25.10	25.50	0.169	0.19	0.235	0.26	0.03
580	820.5	Rear	Note2	25.10	25.50	0.254	0.28	0.340	0.37	0.17
580	820.5	Left	/	25.10	25.50	0.179	0.20	0.264	0.29	0.08
580	820.5	Right	/	25.10	25.50	0.225	0.25	0.331	0.36	0.13
580	820.5	Bottom	/	25.10	25.50	0.048	0.05	0.093	0.10	0.06
580	820.5	Front	/	24.20	24.50	0.262	0.28	0.354	0.38	0.02
684	823.1	Rear	/	24.04	24.50	0.372	0.41	0.495	0.55	0.16
580	820.5	Rear	/	24.20	24.50	0.373	0.40	0.496	0.53	0.02
476	817.9	Rear	Fig.16	24.13	24.50	0.386	0.42	0.513	0.56	0.14

Note: The distance between the EUT and the phantom bottom is 10mm.

Note1: The distance between the EUT and the phantom bottom is 12mm.

Note2: The distance between the EUT and the phantom bottom is 19mm.

Table 14.1-17: SAR Values (LTE Band7 - Head)

Ambient Temperature: 22.9°C						Liquid Temperature: 22.5°C						
Frequency		Mode	Side	Test Position	Figure No.	Conducted Power (dBm)	Max. tune-up Power (dBm)	Measured SAR(10g) (W/kg)	Reported SAR(10g) (W/kg)	Measured SAR(1g) (W/kg)	Reported SAR(1g) (W/kg)	Power Drift (dB)
Ch.	MHz											
20850	2510	1RB_Mid	Left	Touch	/	23.62	24.00	0.023	0.03	0.053	0.06	-0.07
20850	2510	1RB_Mid	Left	Tilt	/	23.62	24.00	0.018	0.02	0.041	0.04	-0.12
20850	2510	1RB_Mid	Right	Touch	/	23.62	24.00	0.019	0.02	0.048	0.05	-0.11
20850	2510	1RB_Mid	Right	Tilt	Fig.17	23.62	24.00	0.025	0.03	0.063	0.07	0.00
20850	2510	50RB_Mid	Left	Touch	/	22.75	23.00	0.021	0.02	0.048	0.05	-0.08
20850	2510	50RB_Mid	Left	Tilt	/	22.75	23.00	0.018	0.02	0.046	0.05	0.00
20850	2510	50RB_Mid	Right	Touch	/	22.75	23.00	0.023	0.02	0.058	0.06	0.03
20850	2510	50RB_Mid	Right	Tilt	/	22.75	23.00	0.023	0.02	0.057	0.06	0.11

Note1: The LTE mode is QPSK_20MHz.

Table 14.1-18: SAR Values (LTE Band7 - Body)

Ambient Temperature: 22.9°C						Liquid Temperature: 22.5°C						
Frequency		Mode	Test Position	Figure No.	Conducted Power (dBm)	Max. tune-up Power (dBm)	Measured SAR(10g) (W/kg)	Reported SAR(10g) (W/kg)	Measured SAR(1g) (W/kg)	Reported SAR(1g) (W/kg)	Power Drift (dB)	
Ch.	MHz											
20850	2510	1RB_Mid	Front	Note1	23.62	24.00	0.094	0.10	0.177	0.19	-0.04	
20850	2510	1RB_Mid	Rear	Note2	23.62	24.00	0.083	0.09	0.158	0.17	-0.06	
20850	2510	1RB_Mid	Left	/	23.62	24.00	0.042	0.05	0.075	0.08	0.05	
20850	2510	1RB_Mid	Right	/	23.62	24.00	0.039	0.04	0.075	0.08	0.05	
20850	2510	1RB_Mid	Bottom	Note3	23.62	24.00	0.134	0.15	0.072	0.08	-0.07	
20850	2510	50RB_Mid	Front	Note1	22.75	23.00	0.074	0.08	0.141	0.15	0.07	
20850	2510	50RB_Mid	Rear	Note2	22.75	23.00	0.068	0.07	0.129	0.14	-0.08	
20850	2510	50RB_Mid	Left	/	22.75	23.00	0.035	0.04	0.062	0.07	0.10	
20850	2510	50RB_Mid	Right	/	22.75	23.00	0.027	0.03	0.050	0.05	0.06	
20850	2510	50RB_Mid	Bottom	Note3	22.75	23.00	0.105	0.11	0.057	0.06	-0.03	
20850	2510	1RB_Mid	Front	/	21.29	22.00	0.079	0.09	0.150	0.18	0.11	
20850	2510	1RB_Mid	Rear	/	21.29	22.00	0.156	0.18	0.330	0.39	0.11	
20850	2510	1RB_Mid	Bottom	Fig.18	21.29	22.00	0.207	0.24	0.424	0.50	-0.03	
20850	2510	50RB_Mid	Front	/	20.37	21.00	0.067	0.08	0.128	0.15	0.07	
20850	2510	50RB_Mid	Rear	/	20.37	21.00	0.128	0.15	0.264	0.31	0.07	
20850	2510	50RB_Mid	Bottom	/	20.37	21.00	0.176	0.20	0.360	0.42	0.13	

Note: The distance between the EUT and the phantom bottom is 10mm.

Note1: The distance between the EUT and the phantom bottom is 12mm.

Note2: The distance between the EUT and the phantom bottom is 19mm.

Note3: The distance between the EUT and the phantom bottom is 17mm.

Note4: The LTE mode is QPSK_20MHz.

Table 14.1-19: SAR Values (LTE Band12 - Head)

Ambient Temperature: 22.9 °C						Liquid Temperature: 22.5 °C						
Frequency		Mode	Side	Test Position	Figure No.	Conducted Power (dBm)	Max. tune-up Power (dBm)	Measured SAR(10g) (W/kg)	Reported SAR(10g) (W/kg)	Measured SAR(1g) (W/kg)	Reported SAR(1g) (W/kg)	Power Drift (dB)
Ch.	MHz											
23130	711	1RB_High	Left	Touch	Fig.19	24.00	25.50	0.153	0.22	0.194	0.27	0.09
23130	711	1RB_High	Left	Tilt	/	24.00	25.50	0.094	0.13	0.124	0.18	-0.03
23130	711	1RB_High	Right	Touch	/	24.00	25.50	0.126	0.18	0.161	0.23	-0.08
23130	711	1RB_High	Right	Tilt	/	24.00	25.50	0.100	0.14	0.128	0.18	0.02
23095	707.5	25RB_Low	Left	Touch	/	23.37	24.50	0.067	0.09	0.084	0.11	0.06
23095	707.5	25RB_Low	Left	Tilt	/	23.37	24.50	0.058	0.08	0.071	0.09	-0.05
23095	707.5	25RB_Low	Right	Touch	/	23.37	24.50	0.109	0.14	0.137	0.18	-0.07
23095	707.5	25RB_Low	Right	Tilt	/	23.37	24.50	0.065	0.08	0.084	0.11	0.00

Note1: The LTE mode is QPSK_10MHz.

Table 14.1-20: SAR Values (LTE Band12 - Body)

Ambient Temperature: 22.9 °C						Liquid Temperature: 22.5 °C					
Frequency		Mode	Test Position	Figure No.	Conducted Power (dBm)	Max. tune-up Power (dBm)	Measured SAR(10g) (W/kg)	Reported SAR(10g) (W/kg)	Measured SAR(1g) (W/kg)	Reported SAR(1g) (W/kg)	Power Drift (dB)
Ch.	MHz										
23130	711	1RB_Mid	Front	/	24.00	25.50	0.199	0.28	0.264	0.37	0.12
23130	711	1RB_Mid	Rear	Fig.20	24.00	25.50	0.334	0.47	0.436	0.62	0.06
23130	711	1RB_Mid	Left	/	24.00	25.50	0.181	0.26	0.269	0.38	-0.11
23130	711	1RB_Mid	Right	/	24.00	25.50	0.210	0.30	0.317	0.45	0.11
23130	711	1RB_Mid	Bottom	/	24.00	25.50	0.043	0.06	0.088	0.12	-0.13
23095	707.5	25RB_Low	Front	/	23.37	24.50	0.154	0.20	0.204	0.26	0.11
23095	707.5	25RB_Low	Rear	/	23.37	24.50	0.285	0.37	0.379	0.49	-0.11
23095	707.5	25RB_Low	Left	/	23.37	24.50	0.160	0.21	0.233	0.30	0.01
23095	707.5	25RB_Low	Right	/	23.37	24.50	0.170	0.22	0.248	0.32	0.04
23095	707.5	25RB_Low	Bottom	/	23.37	24.50	0.038	0.05	0.085	0.11	0.02

Note1: The distance between the EUT and the phantom bottom is 10mm

Note2: The LTE mode is QPSK_10MHz.

Table 14.1-21: SAR Values (LTE Band13- Head)

Ambient Temperature: 22.9 °C						Liquid Temperature: 22.5 °C						
Frequency		Mode	Side	Test Position	Figure No.	Conducted Power (dBm)	Max. tune-up Power (dBm)	Measured SAR(10g) (W/kg)	Reported SAR(10g) (W/kg)	Measured SAR(1g) (W/kg)	Reported SAR(1g) (W/kg)	Power Drift (dB)
Ch.	MHz											
23230	782	1RB_Low	Left	Touch	/	24.73	25.50	0.133	0.16	0.172	0.21	0.09
23230	782	1RB_Low	Left	Tilt	/	24.73	25.50	0.080	0.10	0.100	0.12	0.13
23230	782	1RB_Low	Right	Touch	Fig.21	24.73	25.50	0.206	0.25	0.265	0.32	-0.08
23230	782	1RB_Low	Right	Tilt	/	24.73	25.50	0.170	0.20	0.217	0.26	0.11
23230	782	25RB_Low	Left	Touch	/	23.69	24.50	0.127	0.15	0.164	0.20	0.08
23230	782	25RB_Low	Left	Tilt	/	23.69	24.50	0.077	0.09	0.095	0.11	-0.1
23230	782	25RB_Low	Right	Touch	/	23.69	24.50	0.191	0.23	0.245	0.30	-0.04
23230	782	25RB_Low	Right	Tilt	/	23.69	24.50	0.162	0.20	0.206	0.25	-0.01

Note1: The LTE mode is QPSK_10MHz.

Table 14.1-22: SAR Values (LTE Band13 - Body)

Ambient Temperature: 22.9 °C						Liquid Temperature: 22.5 °C					
Frequency		Mode	Test Position	Figure No.	Conducted Power (dBm)	Max. tune-up Power (dBm)	Measured SAR(10g) (W/kg)	Reported SAR(10g) (W/kg)	Measured SAR(1g) (W/kg)	Reported SAR(1g) (W/kg)	Power Drift (dB)
Ch.	MHz										
23230	782	1RB_Low	Front	/	24.73	25.50	0.198	0.24	0.275	0.33	-0.09
23230	782	1RB_Low	Rear	Fig.22	24.73	25.50	0.343	0.41	0.451	0.54	0.1
23230	782	1RB_Low	Left	/	24.73	25.50	0.201	0.24	0.306	0.37	-0.11
23230	782	1RB_Low	Right	/	24.73	25.50	0.232	0.28	0.354	0.42	-0.04
23230	782	1RB_Low	Bottom	/	24.73	25.50	0.054	0.06	0.128	0.15	-0.05
23230	782	25RB_Low	Front	/	23.69	24.50	0.185	0.22	0.257	0.31	0.01
23230	782	25RB_Low	Rear	/	23.69	24.50	0.305	0.37	0.424	0.51	-0.03
23230	782	25RB_Low	Left	/	23.69	24.50	0.192	0.23	0.295	0.36	-0.01
23230	782	25RB_Low	Right	/	23.69	24.50	0.217	0.26	0.331	0.40	-0.12
23230	782	25RB_Low	Bottom	/	23.69	24.50	0.052	0.06	0.123	0.15	0.00

Note1: The distance between the EUT and the phantom bottom is 10mm

Note2: The LTE mode is QPSK_10MHz.

Table 14.1-23: SAR Values (LTE Band25 - Head)

Ambient Temperature: 22.9°C						Liquid Temperature: 22.5°C						
Frequency		Mode	Side	Test Position	Figure No.	Conducted Power (dBm)	Max. tune-up Power (dBm)	Measured SAR(10g) (W/kg)	Reported SAR(10g) (W/kg)	Measured SAR(1g) (W/kg)	Reported SAR(1g) (W/kg)	Power Drift (dB)
Ch.	MHz											
26590	1905	1RB_Low	Left	Touch	/	19.47	20.00	0.261	0.29	0.412	0.47	0.05
26590	1905	1RB_Low	Left	Tilt	/	19.47	20.00	0.267	0.30	0.469	0.53	0.10
26590	1905	1RB_Low	Right	Touch	/	19.47	20.00	0.447	0.51	0.832	0.94	0.10
26365	1882.5	1RB_Low	Right	Touch	/	19.12	20.00	0.419	0.51	0.811	0.99	0.09
26140	1860	1RB_Low	Right	Touch	Fig.23	19.16	20.00	0.432	0.52	0.824	1.00	-0.12
26590	1905	1RB_Low	Right	Tilt	/	19.47	20.00	0.360	0.41	0.684	0.77	-0.01
26590	1905	50RB_Mid	Left	Touch	/	18.35	19.00	0.204	0.24	0.317	0.37	-0.11
26590	1905	50RB_Mid	Left	Tilt	/	18.35	19.00	0.214	0.25	0.374	0.43	0.07
26590	1905	50RB_Mid	Right	Touch	/	18.35	19.00	0.300	0.35	0.551	0.64	0.10
26590	1905	50RB_Mid	Right	Tilt	/	18.35	19.00	0.268	0.31	0.506	0.59	0.12
26590	1905	100RB	Right	Touch	/	18.41	19.00	0.253	0.29	0.437	0.50	0.03

Note1: The LTE mode is QPSK_20MHz.

Table 14.1-24: SAR Values (LTE Band25 - Body)

Ambient Temperature: 22.9°C						Liquid Temperature: 22.5°C					
Frequency		Mode	Test Position	Figure No.	Conducted Power (dBm)	Max. tune-up Power (dBm)	Measured SAR(10g) (W/kg)	Reported SAR(10g) (W/kg)	Measured SAR(1g) (W/kg)	Reported SAR(1g) (W/kg)	Power Drift (dB)
Ch.	MHz										
26590	1905	1RB_Low	Front	Note1	24.74	25.50	0.160	0.19	0.278	0.33	0.13
26590	1905	1RB_Low	Rear	Note2	24.74	25.50	0.102	0.12	0.175	0.21	-0.13
26590	1905	1RB_Low	Left	/	24.74	25.50	0.134	0.16	0.231	0.28	0.06
26590	1905	1RB_Low	Top	Note3	24.74	25.50	0.193	0.23	0.326	0.39	-0.02
26590	1905	50RB_Mid	Front	Note1	23.80	24.50	0.141	0.17	0.242	0.28	0.07
26590	1905	50RB_Mid	Rear	Note2	23.80	24.50	0.091	0.11	0.154	0.18	0.00
26590	1905	50RB_Mid	Left	/	23.80	24.50	0.103	0.12	0.201	0.24	0.09
26590	1905	50RB_Mid	Top	Note3	23.80	24.50	0.166	0.20	0.279	0.33	0.12
26590	1905	1RB_Low	Front	/	20.64	21.50	0.097	0.12	0.152	0.19	0.06
26590	1905	1RB_Low	Rear	Fig.24	20.64	21.50	0.183	0.22	0.320	0.39	0.08
26590	1905	1RB_Low	Top	/	20.64	21.50	0.105	0.13	0.201	0.25	0.10
26590	1905	50RB_Low	Front	/	19.76	20.50	0.083	0.10	0.133	0.16	0.05
26590	1905	50RB_Low	Rear	/	19.76	20.50	0.149	0.18	0.265	0.31	-0.11
26590	1905	50RB_Low	Top	/	19.76	20.50	0.082	0.10	0.158	0.19	0.13

Note: The distance between the EUT and the phantom bottom is 10mm.

Note1: The distance between the EUT and the phantom bottom is 12mm.

Note2: The distance between the EUT and the phantom bottom is 19mm.

Note3: The distance between the EUT and the phantom bottom is 17mm.

Note4: The LTE mode is QPSK_20MHz.

Table 14.1-25: SAR Values (LTE Band26 - Head)

Ambient Temperature: 22.9 °C						Liquid Temperature: 22.5 °C						
Frequency		Mode	Side	Test Position	Figure No.	Conducted Power (dBm)	Max. tune-up Power (dBm)	Measured SAR(10g) (W/kg)	Reported SAR(10g) (W/kg)	Measured SAR(1g) (W/kg)	Reported SAR(1g) (W/kg)	Power Drift (dB)
Ch.	MHz											
26965	841.5	1RB_Low	Left	Touch	Fig.25	25.30	25.50	0.247	0.26	0.322	0.34	-0.08
26965	841.5	1RB_Low	Left	Tilt	/	25.30	25.50	0.120	0.13	0.150	0.16	-0.04
26965	841.5	1RB_Low	Right	Touch	/	25.30	25.50	0.229	0.24	0.295	0.31	0.07
26965	841.5	1RB_Low	Right	Tilt	/	25.30	25.50	0.148	0.15	0.184	0.19	0.08
26965	841.5	36RB_Low	Left	Touch	/	24.40	24.50	0.226	0.23	0.293	0.30	0.11
26965	841.5	36RB_Low	Left	Tilt	/	24.40	24.50	0.109	0.11	0.136	0.14	0.11
26965	841.5	36RB_Low	Right	Touch	/	24.40	24.50	0.206	0.21	0.266	0.27	0.09
26965	841.5	36RB_Low	Right	Tilt	/	24.40	24.50	0.131	0.13	0.162	0.17	-0.13

Note1: The LTE mode is QPSK_15MHz.

Table 14.1-26: SAR Values (LTE Band26 - Body)

Ambient Temperature: 22.9 °C						Liquid Temperature: 22.5 °C					
Frequency		Mode	Test Position	Figure No.	Conducted Power (dBm)	Max. tune-up Power (dBm)	Measured SAR(10g) (W/kg)	Reported SAR(10g) (W/kg)	Measured SAR(1g) (W/kg)	Reported SAR(1g) (W/kg)	Power Drift (dB)
Ch.	MHz										
26965	841.5	1RB_Low	Front	/	25.30	25.50	0.261	0.27	0.349	0.37	0.01
26965	841.5	1RB_Low	Rear	Fig.26	25.30	25.50	0.421	0.44	0.557	0.58	0.02
26965	841.5	1RB_Low	Left	/	25.30	25.50	0.239	0.25	0.349	0.37	0.11
26965	841.5	1RB_Low	Right	/	25.30	25.50	0.248	0.26	0.364	0.38	-0.03
26965	841.5	1RB_Low	Bottom	/	25.30	25.50	0.048	0.05	0.084	0.09	-0.02
26965	841.5	36RB_Low	Front	/	24.40	24.50	0.237	0.24	0.317	0.32	-0.02
26965	841.5	36RB_Low	Rear	/	24.40	24.50	0.390	0.40	0.517	0.53	0.08
26965	841.5	36RB_Low	Left	/	24.40	24.50	0.208	0.21	0.304	0.31	-0.06
26965	841.5	36RB_Low	Right	/	24.40	24.50	0.216	0.22	0.316	0.32	0.01
26965	841.5	36RB_Low	Bottom	/	24.40	24.50	0.045	0.05	0.077	0.08	-0.08

Note1: The distance between the EUT and the phantom bottom is 10mm

Note2: The LTE mode is QPSK_15MHz.

Table 14.1-27: SAR Values (LTE Band41 PC2 - Head)

Frequency		Mode	Side	Test Position	Figure No.	Conducted Power (dBm)	tune-up Power (dBm)	Measured SAR(10g) (W/kg)	Reported SAR(10g) (W/kg)	Measured SAR(1g) (W/kg)	Reported SAR(1g) (W/kg)	Power Drift (dB)
Ch.	MHz											
39750	2506	1RB_Low	Left	Touch	/	17.18	18.00	0.042	0.05	0.106	0.13	0.02
39750	2506	1RB_Low	Left	Tilt	/	17.18	18.00	0.053	0.06	0.139	0.17	0.07
39750	2506	1RB_Low	Right	Touch	/	17.18	18.00	0.061	0.07	0.177	0.21	-0.12
39750	2506	1RB_Low	Right	Tilt	Fig.27	17.18	18.00	0.077	0.09	0.208	0.25	0.06
39750	2506	50RB_Mid	Left	Touch	/	16.19	17.00	0.032	0.04	0.084	0.10	0.00
39750	2506	50RB_Mid	Left	Tilt	/	16.19	17.00	0.043	0.05	0.110	0.13	0.05
39750	2506	50RB_Mid	Right	Touch	/	16.19	17.00	0.050	0.06	0.145	0.17	0.06
39750	2506	50RB_Mid	Right	Tilt	/	16.19	17.00	0.058	0.07	0.162	0.20	-0.01

Note1: The LTE mode is QPSK_20MHz.

Table 14.1-28: SAR Values (LTE Band41 PC2 - Body)

Frequency		Mode	Test Position	Figure No.	Conducted Power (dBm)	tune-up Power (dBm)	Measured SAR(10g) (W/kg)	Reported SAR(10g) (W/kg)	Measured SAR(1g) (W/kg)	Reported SAR(1g) (W/kg)	Power Drift (dB)
Ch.	MHz										
41490	2680	1RB_Mid	Front	Note1/	28.11	28.70	0.162	0.19	0.317	0.36	-0.12
41490	2680	1RB_Mid	Rear	Note2	28.11	28.70	0.235	0.27	0.448	0.51	0.09
41490	2680	1RB_Mid	Left	/	28.11	28.70	0.133	0.15	0.278	0.32	0.11
41490	2680	1RB_Mid	Top	Note3	28.11	28.70	0.346	0.40	0.698	0.80	0.04
41055	2636.5	1RB_Mid	Top	Note3	27.68	28.70	0.269	0.34	0.552	0.70	0.05
40620	2593	1RB_Mid	Top	Note3	27.79	28.70	0.225	0.28	0.464	0.57	0.06
40185	2549.5	1RB_Mid	Top	Note3	27.87	28.70	0.172	0.21	0.354	0.43	0.02
39750	2506	1RB_Mid	Top	Note3	27.91	28.70	0.170	0.20	0.343	0.41	0.18
41490	2680	50RB_Mid	Front	Note1	26.91	27.70	0.166	0.20	0.323	0.39	0.03
41490	2680	50RB_Mid	Rear	Note2	26.91	27.70	0.236	0.28	0.451	0.54	-0.13
41490	2680	50RB_Mid	Left	/	26.91	27.70	0.106	0.13	0.223	0.27	0.16
41490	2680	50RB_Mid	Top	Note3 Fig.28	26.91	27.70	0.347	0.42	0.709	0.85	0.06
41055	2636.5	50RB_Mid	Top	Note3	26.88	27.70	0.266	0.32	0.554	0.67	0.13
40620	2593	50RB_Mid	Top	Note3	26.87	27.70	0.225	0.27	0.467	0.57	0.09
40185	2549.5	50RB_Mid	Top	Note3	26.78	27.70	0.173	0.21	0.354	0.44	0.05
39750	2506	50RB_Mid	Top	Note3	26.90	27.70	0.173	0.21	0.350	0.42	0.14
39750	2506	1RB_Mid	Front	/	21.13	22.00	0.054	0.07	0.120	0.15	-0.03
39750	2506	1RB_Mid	Rear	/	21.13	22.00	0.137	0.17	0.310	0.38	-0.05
39750	2506	1RB_Low	Top	/	17.18	18.00	0.098	0.12	0.234	0.28	0.10
39750	2506	50RB_Mid	Front	/	20.07	21.00	0.044	0.05	0.097	0.12	-0.05

39750	2506	50RB_Mid	Rear	/	20.07	21.00	0.095	0.12	0.206	0.26	0.05
39750	2506	50RB_Mid	Top	/	16.19	17.00	0.083	0.10	0.199	0.24	0.12
41490	2680	100RB	Top	Note3	26.81	27.70	0.268	0.33	0.552	0.68	0.02

Note: The distance between the EUT and the phantom bottom is 10mm.

Note1: The distance between the EUT and the phantom bottom is 12mm.

Note2: The distance between the EUT and the phantom bottom is 19mm.

Note3: The distance between the EUT and the phantom bottom is 17mm.

Note4: The LTE mode is QPSK_20MHz.

Table 14.1-29: SAR Values (LTE Band41 PC3 - Head)

Ambient Temperature: 22.9 °C						Liquid Temperature: 22.5 °C						
Frequency		Mode	Side	Test Position	Figure No.	Conducted Power (dBm)	tune-up Power (dBm)	Measured SAR(10g) (W/kg)	Reported SAR(10g) (W/kg)	Measured SAR(1g) (W/kg)	Reported SAR(1g) (W/kg)	Power Drift (dB)
Ch.	MHz											
39750	2506	1RB_Low	Left	Touch	/	17.18	18.00	0.060	0.07	0.143	0.17	0.12
39750	2506	1RB_Low	Left	Tilt	/	17.18	18.00	0.081	0.10	0.206	0.25	-0.13
39750	2506	1RB_Low	Right	Touch	/	17.18	18.00	0.100	0.12	0.233	0.28	-0.09
39750	2506	1RB_Low	Right	Tilt	/	17.18	18.00	0.131	0.16	0.312	0.38	-0.07
39750	2506	50RB_Mid	Left	Touch	/	16.25	17.00	0.042	0.05	0.101	0.12	-0.13
39750	2506	50RB_Mid	Left	Tilt	/	16.25	17.00	0.047	0.06	0.113	0.13	0.04
39750	2506	50RB_Mid	Right	Touch	/	16.25	17.00	0.064	0.08	0.163	0.19	-0.06
39750	2506	50RB_Mid	Right	Tilt	Fig.29	16.25	17.00	0.140	0.17	0.368	0.44	0.11

Note1: The LTE mode is QPSK_20MHz.

Table 14.1-30: SAR Values (LTE Band41 PC2 - Body)

Ambient Temperature: 22.9 °C						Liquid Temperature: 22.5 °C					
Frequency		Mode	Test Position	Figure No.	Conducted Power (dBm)	tune-up Power (dBm)	Measured SAR(10g) (W/kg)	Reported SAR(10g) (W/kg)	Measured SAR(1g) (W/kg)	Reported SAR(1g) (W/kg)	Power Drift (dB)
Ch.	MHz										
41490	2680	1RB_Mid	Front	Note1/	24.37	25.00	0.060	0.07	0.122	0.14	0.06
41490	2680	1RB_Mid	Rear	Note2	24.37	25.00	0.089	0.10	0.169	0.20	-0.13
41490	2680	1RB_Mid	Left	/	24.37	25.00	0.095	0.11	0.182	0.21	-0.05
41490	2680	1RB_Mid	Top	Note3	24.37	25.00	0.120	0.14	0.243	0.28	0.03
41490	2680	50RB_Mid	Front	Note1	23.29	24.00	0.058	0.07	0.118	0.14	-0.12
41490	2680	50RB_Mid	Rear	Note2	23.29	24.00	0.071	0.08	0.133	0.16	-0.12
41490	2680	50RB_Mid	Left	/	23.29	24.00	0.078	0.09	0.149	0.18	0.06
41490	2680	50RB_Mid	Top	Note3	23.29	24.00	0.098	0.12	0.197	0.23	0.09
41490	2680	1RB_Mid	Front	/	21.18	22.00	0.076	0.09	0.164	0.20	-0.08
41490	2680	1RB_Mid	Rear	Fig.30	21.18	22.00	0.205	0.25	0.461	0.56	-0.03
39750	2506	1RB_Low	Top	/	17.18	18.00	0.164	0.20	0.401	0.48	-0.11
41055	2636.5	50RB_Mid	Front	/	20.13	21.00	0.055	0.07	0.119	0.15	0.12

41055	2636.5	50RB_Mid	Rear	/	20.13	21.00	0.146	0.18	0.316	0.39	-0.11
39750	2506	50RB_Mid	Top	/	16.25	17.00	0.135	0.16	0.332	0.39	0.09

Note: The distance between the EUT and the phantom bottom is 10mm.

Note1: The distance between the EUT and the phantom bottom is 12mm.

Note2: The distance between the EUT and the phantom bottom is 19mm.

Note3: The distance between the EUT and the phantom bottom is 17mm.

Note4: The LTE mode is QPSK_20MHz.

Table 14.1-31: SAR Values (LTE Band66 - Head)

Ambient Temperature: 22.9°C						Liquid Temperature: 22.5°C						
Frequency		Mode	Side	Test Position	Figure No.	Conducted Power (dBm)	Max. tune-up Power (dBm)	Measured SAR(10g) (W/kg)	Reported SAR(10g) (W/kg)	Measured SAR(1g) (W/kg)	Reported SAR(1g) (W/kg)	Power Drift (dB)
Ch.	MHz											
132572	1770	1RB_High	Left	Touch	/	19.10	19.50	0.210	0.23	0.331	0.36	0.01
132572	1770	1RB_High	Left	Tilt	/	19.10	19.50	0.216	0.24	0.376	0.41	0.04
132572	1770	1RB_High	Right	Touch	Fig.31	19.10	19.50	0.406	0.45	0.762	0.84	0.01
132322	1745	1RB_High	Right	Touch	/	18.99	19.50	0.384	0.43	0.755	0.85	0.11
132072	1720	1RB_High	Right	Touch	/	19.09	19.50	0.391	0.43	0.761	0.84	0.05
132572	1770	1RB_High	Right	Tilt	/	19.10	19.50	0.326	0.36	0.641	0.70	0.13
132072	1720	50RB_High	Left	Touch	/	17.84	18.50	0.169	0.20	0.282	0.33	0.11
132072	1720	50RB_High	Left	Tilt	/	17.84	18.50	0.153	0.18	0.257	0.30	-0.12
132072	1720	50RB_High	Right	Touch	/	17.84	18.50	0.163	0.19	0.296	0.34	0.03
132072	1720	50RB_High	Right	Tilt	/	17.84	18.50	0.125	0.15	0.225	0.26	0.11
132072	1720	100RB	Right	Touch	/	17.73	18.50	0.125	0.15	0.225	0.27	0.08

Note1: The LTE mode is QPSK_20MHz.

Table 14.1-32: SAR Values (LTE Band66 - Body)

Ambient Temperature: 22.9°C						Liquid Temperature: 22.5°C					
Frequency		Mode	Test Position	Figure No.	Conducted Power (dBm)	Max. tune-up Power (dBm)	Measured SAR(10g) (W/kg)	Reported SAR(10g) (W/kg)	Measured SAR(1g) (W/kg)	Reported SAR(1g) (W/kg)	Power Drift (dB)
Ch.	MHz										
132072	1720	1RB_High	Front	Note1	25.15	25.50	0.222	0.24	0.413	0.45	0.10
132072	1720	1RB_High	Rear	Note2	25.15	25.50	0.168	0.18	0.293	0.32	-0.02
132072	1720	1RB_High	Left	/	25.15	25.50	0.194	0.21	0.324	0.35	0.03
132072	1720	1RB_High	Top	Note3	25.15	25.50	0.148	0.16	0.249	0.27	0.13
132072	1720	50RB_High	Front	Note1	23.82	24.50	0.204	0.24	0.348	0.41	-0.13
132072	1720	50RB_High	Rear	Note2	23.82	24.50	0.153	0.18	0.267	0.31	0.03
132072	1720	50RB_High	Left	/	23.82	24.50	0.127	0.15	0.211	0.25	0.11
132072	1720	50RB_High	Top	Note3	23.82	24.50	0.120	0.14	0.196	0.23	-0.09
132072	1720	1RB_High	Front	/	21.91	22.50	0.128	0.15	0.210	0.24	0.03
132072	1720	1RB_High	Rear	Fig.32	21.91	22.50	0.235	0.27	0.452	0.52	0.11

132072	1720	1RB_High	Top	/	19.10	19.50	0.081	0.09	0.147	0.16	0.05
132072	1720	50RB_High	Front	/	20.78	21.50	0.098	0.12	0.156	0.18	0.02
132072	1720	50RB_High	Rear	/	20.78	21.50	0.178	0.21	0.325	0.38	0.03
132072	1720	50RB_High	Top	/	17.84	18.50	0.062	0.07	0.111	0.13	-0.04

Note: The distance between the EUT and the phantom bottom is 10mm.

Note1: The distance between the EUT and the phantom bottom is 12mm.

Note2: The distance between the EUT and the phantom bottom is 19mm.

Note3: The distance between the EUT and the phantom bottom is 17mm.

Note4: The LTE mode is QPSK_20MHz.

Table 14.1-33: SAR Values (LTE Band71 - Head)

Ambient Temperature: 22.9 °C												Liquid Temperature: 22.5°C	
Frequency		Mode	Side	Test Position	Figure No.	Conducted Power (dBm)	tune-up Power (dBm)	Measured SAR(10g) (W/kg)	Reported SAR(10g) (W/kg)	Measured SAR(1g) (W/kg)	Reported SAR(1g) (W/kg)	Power Drift (dB)	
Ch.	MHz												
133322	683	1RB_Low	Left	Touch	Fig.33	24.60	25.50	0.177	0.22	0.220	0.27	0.08	
133322	683	1RB_Low	Left	Tilt	/	24.60	25.50	0.079	0.10	0.097	0.12	0.00	
133322	683	1RB_Low	Right	Touch	/	24.60	25.50	0.153	0.19	0.188	0.23	0.11	
133322	683	1RB_Low	Right	Tilt	/	24.60	25.50	0.105	0.13	0.125	0.15	0.03	
133222	673	50RB_Low	Left	Touch	/	23.59	24.50	0.144	0.18	0.180	0.22	0.03	
133222	673	50RB_Low	Left	Tilt	/	23.59	24.50	0.069	0.09	0.082	0.10	-0.06	
133222	673	50RB_Low	Right	Touch	/	23.59	24.50	0.132	0.16	0.162	0.20	-0.05	
133222	673	50RB_Low	Right	Tilt	/	23.59	24.50	0.084	0.10	0.100	0.12	-0.06	

Note1: The LTE mode is QPSK_20MHz.

Table 14.1-34: SAR Values (LTE Band71 - Body)

Ambient Temperature: 22.9 °C												Liquid Temperature: 22.5°C	
Frequency		Mode	Test Position	Figure No.	Conducted Power (dBm)	tune-up Power (dBm)	Measured SAR(10g) (W/kg)	Reported SAR(10g) (W/kg)	Measured SAR(1g) (W/kg)	Reported SAR(1g) (W/kg)	Power Drift (dB)		
Ch.	MHz												
133322	683	1RB_Low	Front	Note1	24.60	25.50	0.309	0.38	0.405	0.50	0.13		
133322	683	1RB_Low	Rear	Note2	24.60	25.50	0.276	0.34	0.363	0.45	0.09		
133322	683	1RB_Low	Left	/	24.60	25.50	0.332	0.41	0.477	0.59	-0.04		
133322	683	1RB_Low	Right	Fig.34	24.60	25.50	0.374	0.46	0.538	0.66	0.07		
133322	683	1RB_Low	Bottom	/	24.60	25.50	0.061	0.08	0.133	0.16	-0.12		
133222	673	50RB_Low	Front	Note1	23.59	24.50	0.220	0.27	0.287	0.35	0.02		
133222	673	50RB_Low	Rear	Note2	23.59	24.50	0.199	0.25	0.263	0.32	0.08		
133222	673	50RB_Low	Left	/	23.59	24.50	0.282	0.35	0.404	0.50	-0.04		
133222	673	50RB_Low	Right	/	23.59	24.50	0.330	0.41	0.473	0.58	-0.03		
133222	673	50RB_Low	Bottom	/	23.59	24.50	0.049	0.06	0.107	0.13	-0.02		
133222	673	1RB_Low	Front	/	22.46	23.50	0.203	0.26	0.260	0.33	0.13		
133222	673	1RB_Low	Rear	/	22.46	23.50	0.304	0.39	0.399	0.51	0.04		

133222	673	50RB_Low	Front	/	21.78	22.50	0.135	0.16	0.174	0.21	-0.07
133222	673	50RB_Low	Rear	/	21.78	22.50	0.222	0.26	0.290	0.34	0.08

Note: The distance between the EUT and the phantom bottom is 10mm.

Note1: The distance between the EUT and the phantom bottom is 12mm.

Note2: The distance between the EUT and the phantom bottom is 19mm.

Note3: The LTE mode is QPSK_10MHz.

14.2 SAR results for Standard procedure

There is zoom scan measurement to be added for the highest measured SAR in each exposure configuration/band.

Table 14.2-1: SAR Values (GSM 850 MHz Band - Head)

Frequency		Side	Test Position	Figure No.	Conducted Power (dBm)	Max. tune-up Power (dBm)	Measured SAR(10g) (W/kg)	Reported SAR(10g) (W/kg)	Measured SAR(1g) (W/kg)	Reported SAR(1g) (W/kg)	Power Drift (dB)
Ch.	MHz										
251	848.8	Right	Touch	Fig.1	30.89	32.00	0.182	0.24	0.281	0.36	0.03

Note: the head SAR of GSM850 is tested with GPRS (2Txslots) mode because of VoIP.

Table 14.2-2: SAR Values (GSM 850 MHz Band - Body)

Frequency		Mode (number of timeslots)	Test Position	Figure No.	Conducted Power (dBm)	Max. tune-up Power (dBm)	Measured SAR(10g) (W/kg)	Reported SAR(10g) (W/kg)	Measured SAR(1g) (W/kg)	Reported SAR(1g) (W/kg)	Power Drift (dB)
Ch.	MHz										
251	848.8	GPRS (2)	Rear	Fig.2	30.89	32.00	0.242	0.31	0.513	0.66	0.08

Note: The distance between the EUT and the phantom bottom is 10mm.

Table 14.2-3: SAR Values (GSM 1900 MHz Band - Head)

Frequency		Side	Test Position	Figure No.	Conducted Power (dBm)	Max. tune-up Power (dBm)	Measured SAR(10g) (W/kg)	Reported SAR(10g) (W/kg)	Measured SAR(1g) (W/kg)	Reported SAR(1g) (W/kg)	Power Drift (dB)
Ch.	MHz										
512	1850.2	Right	Touch	Fig.3	20.51	21.50	0.182	0.23	0.362	0.45	0.02

Note: the head SAR of GSM1900 is tested with GPRS (2Txslots) mode because of VoIP.

Table 14.2-4: SAR Values (GSM 1900 MHz Band - Body)

Frequency		Mode (number of timeslots)	Test Position	Figure No./ Note	Conducted Power (dBm)	Max. tune-up Power (dBm)	Measured SAR(10g) (W/kg)	Reported SAR(10g) (W/kg)	Measured SAR(1g) (W/kg)	Reported SAR(1g) (W/kg)	Power Drift (dB)
Ch.	MHz										
810	1909.8	GPRS (2)	Front	Note1 Fig.4	28.57	29.50	0.204	0.25	0.442	0.55	-0.08

Note1: The distance between the EUT and the phantom bottom is 12mm.

Table 14.2-5: SAR Values (WCDMA 1900 MHz Band - Head)

Frequency		Side	Test Position	Figure No.	Conducted Power (dBm)	Max. tune-up Power (dBm)	Measured SAR(10g) (W/kg)	Reported SAR(10g) (W/kg)	Measured SAR(1g) (W/kg)	Reported SAR(1g) (W/kg)	Power Drift (dB)
Ch.	MHz										
9662	1852.4	Left	Touch	Fig.5	18.41	19.50	0.201	0.26	0.342	0.44	-0.12

Table 14.2-6: SAR Values (WCDMA 1900 MHz Band - Body)

Frequency		Test Position	Figure No./ Note	Conducted Power (dBm)	Max. tune-up Power (dBm)	Measured SAR(10g) (W/kg)	Reported SAR(10g) (W/kg)	Measured SAR(1g) (W/kg)	Reported SAR(1g) (W/kg)	Power Drift (dB)
Ch.	MHz									
9662	1852.4	Front	Note1 Fig.6	24.57	25.50	0.311	0.39	0.547	0.68	-0.10

Note1: The distance between the EUT and the phantom bottom is 12mm.

Table 14.2-7: SAR Values (WCDMA 1700 MHz Band - Head)

Frequency		Side	Test Position	Figure No.	Conducted Power (dBm)	Max. tune-up Power (dBm)	Measured SAR(10g) (W/kg)	Reported SAR(10g) (W/kg)	Measured SAR(1g) (W/kg)	Reported SAR(1g) (W/kg)	Power Drift (dB)
Ch.	MHz										
1513	1752.6	Right	Tilt	Fig.7	18.51	19.50	0.269	0.34	0.553	0.69	0.10

Table 14.2-8: SAR Values (WCDMA 1700 MHz Band - Body)

Frequency		Test Position	Figure No./ Note	Conducted Power (dBm)	Max. tune-up Power (dBm)	Measured SAR(10g) (W/kg)	Reported SAR(10g) (W/kg)	Measured SAR(1g) (W/kg)	Reported SAR(1g) (W/kg)	Power Drift (dB)
Ch.	MHz									
9938	1907.6	Rear	Fig.8	21.49	22.50	0.225	0.28	0.480	0.61	-0.13

Note: The distance between the EUT and the phantom bottom is 10mm.

Table 14.2-9: SAR Values (WCDMA 850 MHz Band - Head)

Ambient Temperature: 22.9 °C						Liquid Temperature: 22.5 °C					
Frequency		Side	Test Position	Figure No.	Conducted Power (dBm)	Max. tune-up Power (dBm)	Measured SAR(10g) (W/kg)	Reported SAR(10g) (W/kg)	Measured SAR(1g) (W/kg)	Reported SAR(1g) (W/kg)	Power Drift (dB)
Ch.	MHz										
4182	836.4	Left	Touch	Fig.9	24.09	25.00	0.225	0.28	0.294	0.36	-0.02

Table 14.2-10: SAR Values (WCDMA 850 MHz Band - Body)

Ambient Temperature: 22.9 °C					Liquid Temperature: 22.5 °C					
Frequency		Test Position	Figure No.	Conducted Power (dBm)	Max. tune-up Power (dBm)	Measured SAR(10g) (W/kg)	Reported SAR(10g) (W/kg)	Measured SAR(1g) (W/kg)	Reported SAR(1g) (W/kg)	Power Drift (dB)
Ch.	MHz									
4182	836.4	Rear	Fig.10	24.09	25.00	0.361	0.45	0.479	0.59	-0.04

Note: The distance between the EUT and the phantom bottom is 10mm.

Table 14.2-11: SAR Values (CDMA BC0 MHz Band - Head)

Ambient Temperature: 22.5 °C						Liquid Temperature: 22.0 °C					
Frequency		Side	Test Position	Figure No./ Note	Conducted Power (dBm)	Max. tune-up Power (dBm)	Measured SAR(10g) (W/kg)	Reported SAR(10g) (W/kg)	Measured SAR(1g) (W/kg)	Reported SAR(1g) (W/kg)	Power Drift (dB)
Ch.	MHz										
384	836.52	Right	Touch	Fig.11	24.98	25.50	0.268	0.30	0.354	0.40	-0.12

Table 14.2-12: SAR Values (CDMA BC0 MHz Band - Body)

Ambient Temperature: 22.5 °C					Liquid Temperature: 22.0 °C					
Frequency		Test Position	Figure No./ Note	Conducted Power (dBm)	Max. tune-up Power (dBm)	Measured SAR(10g) (W/kg)	Reported SAR(10g) (W/kg)	Measured SAR(1g) (W/kg)	Reported SAR(1g) (W/kg)	Power Drift (dB)
Ch.	MHz									
384	836.52	Rear	Fig.12	24.96	25.50	0.411	0.47	0.552	0.63	-0.05

Note: The distance between the EUT and the phantom bottom is 10mm.

Table 14.2-13: SAR Values (CDMA BC1 MHz Band - Head)

Ambient Temperature: 22.5 °C						Liquid Temperature: 22.0 °C					
Frequency		Side	Test Position	Figure No./ Note	Conducted Power (dBm)	Max. tune-up Power (dBm)	Measured SAR(10g) (W/kg)	Reported SAR(10g) (W/kg)	Measured SAR(1g) (W/kg)	Reported SAR(1g) (W/kg)	Power Drift (dB)
Ch.	MHz										
600	1880	Right	Touch	Fig.13	19.26	19.50	0.307	0.32	0.641	0.68	-0.09

Table 14.2-14: SAR Values (CDMA BC1 MHz Band - Body)

Ambient Temperature: 22.5°C					Liquid Temperature: 22.0°C					
Frequency		Test Position	Figure No./Note	Conducted Power (dBm)	Max. tune-up Power (dBm)	Measured SAR(10g) (W/kg)	Reported SAR(10g) (W/kg)	Measured SAR(1g) (W/kg)	Reported SAR(1g) (W/kg)	Power Drift (dB)
Ch.	MHz									
600	1880	Front	Note1 Fig.14	25.16	25.50	0.281	0.30	0.485	0.52	0.06

Note1: The distance between the EUT and the phantom bottom is 12mm.

Table 14.2-15: SAR Values (CDMA BC10 MHz Band - Head)

Ambient Temperature: 22.5°C					Liquid Temperature: 22.0°C						
Frequency		Side	Test Position	Figure No./Note	Conducted Power (dBm)	Max. tune-up Power (dBm)	Measured SAR(10g) (W/kg)	Reported SAR(10g) (W/kg)	Measured SAR(1g) (W/kg)	Reported SAR(1g) (W/kg)	Power Drift (dB)
Ch.	MHz										
476	817.9	Left	Touch	Fig.15	25.07	25.50	0.221	0.24	0.291	0.32	-0.04

Table 14.2-16: SAR Values (CDMA BC10 MHz Band - Body)

Ambient Temperature: 22.5°C					Liquid Temperature: 22.0°C					
Frequency		Test Position	Figure No./Note	Conducted Power (dBm)	Max. tune-up Power (dBm)	Measured SAR(10g) (W/kg)	Reported SAR(10g) (W/kg)	Measured SAR(1g) (W/kg)	Reported SAR(1g) (W/kg)	Power Drift (dB)
Ch.	MHz									
476	817.9	Rear	Fig.16	24.13	24.50	0.386	0.42	0.513	0.56	0.14

Note: The distance between the EUT and the phantom bottom is 10mm.

Table 14.2-17: SAR Values (LTE Band7 - Head)

Ambient Temperature: 22.9 °C					Liquid Temperature: 22.5°C							
Frequency		Mode	Side	Test Position	Figure No.	Conducted Power (dBm)	Max. tune-up Power (dBm)	Measured SAR(10g) (W/kg)	Reported SAR(10g) (W/kg)	Measured SAR(1g) (W/kg)	Reported SAR(1g) (W/kg)	Power Drift (dB)
Ch.	MHz											
20850	2510	1RB_Mid	Right	Tilt	Fig.17	23.62	24.00	0.025	0.03	0.063	0.07	0.00

Note1: The LTE mode is QPSK_20MHz.

Table 14.2-18: SAR Values (LTE Band7 - Body)

Ambient Temperature: 22.9 °C					Liquid Temperature: 22.5°C						
Frequency		Mode	Test Position	Figure No.	Conducted Power (dBm)	Max. tune-up Power (dBm)	Measured SAR(10g) (W/kg)	Reported SAR(10g) (W/kg)	Measured SAR(1g) (W/kg)	Reported SAR(1g) (W/kg)	Power Drift (dB)
Ch.	MHz										
20850	2510	1RB_Mid	Bottom	Fig.18	21.29	22.00	0.207	0.24	0.424	0.50	-0.03

Note: The distance between the EUT and the phantom bottom is 10mm.

Table 14.2-19: SAR Values (LTE Band12 - Head)

Ambient Temperature: 22.9 °C						Liquid Temperature: 22.5 °C						
Frequency		Mode	Side	Test Position	Figure No.	Conducted Power (dBm)	Max. tune-up Power (dBm)	Measured SAR(10g) (W/kg)	Reported SAR(10g) (W/kg)	Measured SAR(1g) (W/kg)	Reported SAR(1g) (W/kg)	Power Drift (dB)
Ch.	MHz											
23130	711	1RB_High	Left	Touch	Fig.19	24.00	25.50	0.153	0.22	0.194	0.27	0.09

Note1: The LTE mode is QPSK_10MHz.

Table 14.2-20: SAR Values (LTE Band12 - Body)

Ambient Temperature: 22.9 °C						Liquid Temperature: 22.5 °C					
Frequency		Mode	Test Position	Figure No.	Conducted Power (dBm)	Max. tune-up Power (dBm)	Measured SAR(10g) (W/kg)	Reported SAR(10g) (W/kg)	Measured SAR(1g) (W/kg)	Reported SAR(1g) (W/kg)	Power Drift (dB)
Ch.	MHz										
23130	711	1RB_Mid	Rear	Fig.20	24.00	25.50	0.334	0.47	0.436	0.62	0.06

Note1: The distance between the EUT and the phantom bottom is 10mm

Note2: The LTE mode is QPSK_10MHz.

Table 14.2-21: SAR Values (LTE Band13- Head)

Ambient Temperature: 22.9 °C						Liquid Temperature: 22.5 °C						
Frequency		Mode	Side	Test Position	Figure No.	Conducted Power (dBm)	Max. tune-up Power (dBm)	Measured SAR(10g) (W/kg)	Reported SAR(10g) (W/kg)	Measured SAR(1g) (W/kg)	Reported SAR(1g) (W/kg)	Power Drift (dB)
Ch.	MHz											
23230	782	1RB_Low	Right	Touch	Fig.21	24.73	25.50	0.206	0.25	0.265	0.32	-0.08

Note1: The LTE mode is QPSK_10MHz.

Table 14.2-22: SAR Values (LTE Band13 - Body)

Ambient Temperature: 22.9 °C						Liquid Temperature: 22.5 °C					
Frequency		Mode	Test Position	Figure No.	Conducted Power (dBm)	Max. tune-up Power (dBm)	Measured SAR(10g) (W/kg)	Reported SAR(10g) (W/kg)	Measured SAR(1g) (W/kg)	Reported SAR(1g) (W/kg)	Power Drift (dB)
Ch.	MHz										
23230	782	1RB_Low	Rear	Fig.22	24.73	25.50	0.343	0.41	0.451	0.54	0.1

Note1: The distance between the EUT and the phantom bottom is 10mm

Note2: The LTE mode is QPSK_10MHz.

Table 14.2-23: SAR Values (LTE Band25 - Head)

Ambient Temperature: 22.9°C						Liquid Temperature: 22.5°C						
Frequency		Mode	Side	Test Position	Figure No.	Conducted Power (dBm)	Max. tune-up Power (dBm)	Measured SAR(10g) (W/kg)	Reported SAR(10g) (W/kg)	Measured SAR(1g) (W/kg)	Reported SAR(1g) (W/kg)	Power Drift (dB)
Ch.	MHz											
26140	1860	1RB_Low	Right	Touch	Fig.23	19.16	20.00	0.432	0.52	0.824	1.00	-0.12

Note1: The LTE mode is QPSK_20MHz.

Table 14.2-24: SAR Values (LTE Band25 - Body)

Ambient Temperature: 22.9°C						Liquid Temperature: 22.5°C					
Frequency		Mode	Test Position	Figure No.	Conducted Power (dBm)	Max. tune-up Power (dBm)	Measured SAR(10g) (W/kg)	Reported SAR(10g) (W/kg)	Measured SAR(1g) (W/kg)	Reported SAR(1g) (W/kg)	Power Drift (dB)
Ch.	MHz										
26590	1905	1RB_Low	Rear	Fig.24	20.64	21.50	0.183	0.22	0.320	0.39	0.08

Note: The distance between the EUT and the phantom bottom is 10mm.

Note2: The LTE mode is QPSK_20MHz.

Table 14.2-25: SAR Values (LTE Band26 - Head)

Ambient Temperature: 22.9°C						Liquid Temperature: 22.5°C						
Frequency		Mode	Side	Test Position	Figure No.	Conducted Power (dBm)	Max. tune-up Power (dBm)	Measured SAR(10g) (W/kg)	Reported SAR(10g) (W/kg)	Measured SAR(1g) (W/kg)	Reported SAR(1g) (W/kg)	Power Drift (dB)
Ch.	MHz											
26965	841.5	1RB_Low	Left	Touch	Fig.25	25.30	25.50	0.247	0.26	0.322	0.34	-0.08

Note1: The LTE mode is QPSK_15MHz.

Table 14.2-26: SAR Values (LTE Band26 - Body)

Ambient Temperature: 22.9°C						Liquid Temperature: 22.5°C					
Frequency		Mode	Test Position	Figure No.	Conducted Power (dBm)	Max. tune-up Power (dBm)	Measured SAR(10g) (W/kg)	Reported SAR(10g) (W/kg)	Measured SAR(1g) (W/kg)	Reported SAR(1g) (W/kg)	Power Drift (dB)
Ch.	MHz										
26965	841.5	1RB_Low	Rear	Fig.26	25.30	25.50	0.421	0.44	0.557	0.58	0.02

Note1: The distance between the EUT and the phantom bottom is 10mm

Note2: The LTE mode is QPSK_15MHz.

Table 14.2-27: SAR Values (LTE Band41 PC2 - Head)

Ambient Temperature: 22.9 °C						Liquid Temperature: 22.5 °C						
Frequency		Mode	Side	Test Position	Figure No.	Conducted Power (dBm)	tune-up Power (dBm)	Measured SAR(10g) (W/kg)	Reported SAR(10g) (W/kg)	Measured SAR(1g) (W/kg)	Reported SAR(1g) (W/kg)	Power Drift (dB)
Ch.	MHz											
39750	2506	1RB_Low	Right	Tilt	Fig.27	17.18	18.00	0.077	0.09	0.208	0.25	0.06

Note1: The LTE mode is QPSK_20MHz.

Table 14.2-28: SAR Values (LTE Band41 PC2 - Body)

Ambient Temperature: 22.9 °C						Liquid Temperature: 22.5 °C					
Frequency		Mode	Test Position	Figure No.	Conducted Power (dBm)	tune-up Power (dBm)	Measured SAR(10g) (W/kg)	Reported SAR(10g) (W/kg)	Measured SAR(1g) (W/kg)	Reported SAR(1g) (W/kg)	Power Drift (dB)
Ch.	MHz										
41490	2680	50RB_Mid	Top	Note3 Fig.28	26.91	27.70	0.347	0.42	0.709	0.85	0.06

Note1: The distance between the EUT and the phantom bottom is 12mm.

Note2: The LTE mode is QPSK_20MHz.

Table 14.2-29: SAR Values (LTE Band41 PC3 - Head)

Ambient Temperature: 22.9 °C						Liquid Temperature: 22.5 °C						
Frequency		Mode	Side	Test Position	Figure No.	Conducted Power (dBm)	tune-up Power (dBm)	Measured SAR(10g) (W/kg)	Reported SAR(10g) (W/kg)	Measured SAR(1g) (W/kg)	Reported SAR(1g) (W/kg)	Power Drift (dB)
Ch.	MHz											
39750	2506	50RB_Mid	Right	Tilt	Fig.29	16.25	17.00	0.140	0.17	0.368	0.44	0.11

Note1: The LTE mode is QPSK_20MHz.

Table 14.2-30: SAR Values (LTE Band41 PC2 - Body)

Ambient Temperature: 22.9 °C						Liquid Temperature: 22.5 °C					
Frequency		Mode	Test Position	Figure No.	Conducted Power (dBm)	tune-up Power (dBm)	Measured SAR(10g) (W/kg)	Reported SAR(10g) (W/kg)	Measured SAR(1g) (W/kg)	Reported SAR(1g) (W/kg)	Power Drift (dB)
Ch.	MHz										
41490	2680	1RB_Mid	Rear	Fig.30	21.18	22.00	0.205	0.25	0.461	0.56	-0.03

Note: The distance between the EUT and the phantom bottom is 10mm.

Note2: The LTE mode is QPSK_20MHz.

Table 14.2-31: SAR Values (LTE Band66 - Head)

Ambient Temperature: 22.9 °C						Liquid Temperature: 22.5 °C						
Frequency		Mode	Side	Test Position	Figure No.	Conducted Power (dBm)	Max. tune-up Power (dBm)	Measured SAR(10g) (W/kg)	Reported SAR(10g) (W/kg)	Measured SAR(1g) (W/kg)	Reported SAR(1g) (W/kg)	Power Drift (dB)
Ch.	MHz											
132572	1770	1RB_High	Right	Touch	Fig.31	19.10	19.50	0.406	0.45	0.762	0.84	0.01

Note1: The LTE mode is QPSK_20MHz.

Table 14.2-32: SAR Values (LTE Band66 - Body)

Ambient Temperature: 22.9 °C						Liquid Temperature: 22.5 °C					
Frequency		Mode	Test Position	Figure No.	Conducted Power (dBm)	Max. tune-up Power (dBm)	Measured SAR(10g) (W/kg)	Reported SAR(10g) (W/kg)	Measured SAR(1g) (W/kg)	Reported SAR(1g) (W/kg)	Power Drift (dB)
Ch.	MHz										
132072	1720	1RB_High	Rear	Fig.32	21.91	22.50	0.235	0.27	0.452	0.52	0.11

Note: The distance between the EUT and the phantom bottom is 10mm.

Note2: The LTE mode is QPSK_20MHz.

Table 14.2-33: SAR Values (LTE Band71 - Head)

Ambient Temperature: 22.9 °C						Liquid Temperature: 22.5 °C						
Frequency		Mode	Side	Test Position	Figure No.	Conducted Power (dBm)	tune-up Power (dBm)	Measured SAR(10g) (W/kg)	Reported SAR(10g) (W/kg)	Measured SAR(1g) (W/kg)	Reported SAR(1g) (W/kg)	Power Drift (dB)
Ch.	MHz											
133322	683	1RB_Low	Left	Touch	Fig.33	24.60	25.50	0.177	0.22	0.220	0.27	0.08

Note1: The LTE mode is QPSK_20MHz.

Table 14.2-34: SAR Values (LTE Band71 - Body)

Ambient Temperature: 22.9 °C						Liquid Temperature: 22.5 °C					
Frequency		Mode	Test Position	Figure No.	Conducted Power (dBm)	tune-up Power (dBm)	Measured SAR(10g) (W/kg)	Reported SAR(10g) (W/kg)	Measured SAR(1g) (W/kg)	Reported SAR(1g) (W/kg)	Power Drift (dB)
Ch.	MHz										
133322	683	1RB_Low	Right	Fig.34	24.60	25.50	0.374	0.46	0.538	0.66	0.07

Note: The distance between the EUT and the phantom bottom is 10mm.

Note3: The LTE mode is QPSK_10MHz.

14.3 WLAN Evaluation for 2.4G

According to the KDB248227 D01, SAR is measured for 2.4GHz 802.11b DSSS using the initial test position procedure.

Head Evaluation

Table 14.3-1: SAR Values (WLAN - Head)– 802.11b (Fast SAR) Normal Power

Ambient Temperature: 22.9 °C						Liquid Temperature: 22.5 °C					
Frequency		Side	Test Position	Figure No.	Conducted Power (dBm)	Max. tune-up Power (dBm)	Measured SAR(10g) (W/kg)	Reported SAR(10g) (W/kg)	Measured SAR(1g) (W/kg)	Reported SAR(1g)(W/kg)	Power Drift (dB)
MHz	Ch.										
2437	6	Left	Touch	/	18.12	19.00	0.294	0.36	0.540	0.66	0.16
2437	6	Left	Tilt	/	18.12	19.00	0.243	0.30	0.470	0.58	0.10
2437	6	Right	Touch	/	18.12	19.00	0.138	0.17	0.217	0.27	0.03
2437	6	Right	Tilt	/	18.12	19.00	0.089	0.11	0.156	0.19	0.04

As shown above table, the initial test position for head is “Left Touch”. So the head SAR of WLAN is presented as below:

Table 14.3-2: SAR Values (WLAN - Head)– 802.11b (Full SAR) Normal Power

Ambient Temperature: 22.9 °C						Liquid Temperature: 22.5 °C					
Frequency		Side	Test Position	Figure No.	Conducted Power (dBm)	Max. tune-up Power (dBm)	Measured SAR(10g) (W/kg)	Reported SAR(10g) (W/kg)	Measured SAR(1g) (W/kg)	Reported SAR(1g)(W/kg)	Power Drift (dB)
MHz	Ch.										
2437	6	Left	Touch	Fig.35	18.12	19.00	0.276	0.34	0.500	0.61	0.16
2437	6	Left	Tilt	/	18.12	19.00	0.216	0.26	0.436	0.53	0.10

Note1: When the reported SAR of the initial test position is > 0.4 W/kg, SAR is repeated for the 802.11 transmission mode configuration tested in the initial test position using subsequent highest estimated 1-g SAR conditions determined by area scans, on the highest maximum output power channel, until the reported SAR is ≤ 0.8 W/kg.

Note2: For all positions/configurations tested using the initial test position and subsequent test positions, when the reported SAR is > 0.8 W/kg, SAR is measured for these test positions/configurations on the subsequent next highest measured output power channel until the reported SAR is ≤ 1.2 W/kg or all required channels are tested.

According to the KDB248227 D01, The reported SAR must be scaled to 100% transmission duty factor to determine compliance at the maximum tune-up tolerance limit. The scaled reported SAR is presented as below.

Table 14.3-3: SAR Values (WLAN - Head) – 802.11b (Scaled Reported SAR)

Ambient Temperature: 22.9 °C						Liquid Temperature: 22.5 °C	
Frequency		Side	Test Position	Actual duty factor	maximum duty factor	Reported SAR (1g)(W/kg)	Scaled reported SAR (1g)(W/kg)
MHz	Ch.						
2437	6	Left	Touch	100%	100%	0.61	0.61

SAR is not required for OFDM because the 802.11b adjusted SAR ≤ 1.2 W/kg.

Body Evaluation

Table 14.3-4: SAR Values (WLAN - Body)– 802.11b (Fast SAR)

Frequency		Test Position	Figure No.	Ambient Temperature: 22.9 °C		Liquid Temperature: 22.5 °C		Measured SAR(1g) (W/kg)	Reported SAR(1g)(W/kg)	Power Drift (dB)
MHz	Ch.			Conducted Power (dBm)	Max. tune-up Power (dBm)	Measured SAR(10g) (W/kg)	Reported SAR(10g) (W/kg)			
2437	6	Front	/	18.12	19.00	0.065	0.08	0.131	0.16	0.07
2437	6	Rear	/	18.12	19.00	0.105	0.13	0.222	0.27	0.06
2437	6	Right	/	18.12	19.00	0.140	0.17	0.271	0.33	0.04
2437	6	Top	/	18.12	19.00	0.065	0.08	0.163	0.20	-0.05

As shown above table, the initial test position for body is “Right”. So the body SAR of WLAN is presented as below:

Table 14.3-5: SAR Values (WLAN - Body)– 802.11b (Full SAR)

Frequency		Test Position	Figure No.	Ambient Temperature: 22.9 °C		Liquid Temperature: 22.5 °C		Measured SAR(1g) (W/kg)	Reported SAR(1g)(W/kg)	Power Drift (dB)
MHz	Ch.			Conducted Power (dBm)	Max. tune-up Power (dBm)	Measured SAR(10g) (W/kg)	Reported SAR(10g) (W/kg)			
2437	6	Rear	/	18.12	19.00	0.105	0.13	0.211	0.26	0.06
2437	6	Right	Fig.36	18.12	19.00	0.148	0.18	0.290	0.36	0.04
2437	6	Rear	Note3	18.12	19.00	0.026	0.03	0.050	0.06	-0.04

Note1: When the reported SAR of the initial test position is > 0.4 W/kg, SAR is repeated for the 802.11 transmission mode configuration tested in the initial test position using subsequent highest estimated 1-g SAR conditions determined by area scans, on the highest maximum output power channel, until the reported SAR is \leq 0.8 W/kg.

Note2: For all positions/configurations tested using the initial test position and subsequent test positions, when the reported SAR is > 0.8 W/kg, SAR is measured for these test positions/configurations on the subsequent next highest measured output power channel until the reported SAR is \leq 1.2 W/kg or all required channels are tested.

Note3: he distance between the EUT and the phantom bottom is 17mm.

According to the KDB248227 D01, The reported SAR must be scaled to 100% transmission duty factor to determine compliance at the maximum tune-up tolerance limit. The scaled reported SAR is presented as below.

Table 14.3-6: SAR Values (WLAN - Body) – 802.11b (Scaled Reported SAR)

Frequency		Test Position	Ambient Temperature: 22.9 °C		Liquid Temperature: 22.5 °C	
MHz	Ch.		Actual duty factor	maximum duty factor	Reported SAR (1g)(W/kg)	Scaled reported SAR (1g)(W/kg)
2437	6	Right	100%	100%	0.36	0.36

SAR is not required for OFDM because the 802.11b adjusted SAR \leq 1.2 W/kg.

Head Evaluation

Table 14.3-7: SAR Values (WLAN - Head)– 802.11b (Fast SAR) Low Power

Frequency		Side	Test Position	Figure No.	Ambient Temperature: 22.9 °C		Liquid Temperature: 22.5°C				
MHz	Ch.				Conducted Power (dBm)	Max. tune-up Power (dBm)	Measured SAR(10g) (W/kg)	Reported SAR(10g) (W/kg)	Measured SAR(1g) (W/kg)	Reported SAR(1g)(W/kg)	Power Drift (dB)
2437	6	Left	Touch	/	12.67	13.00	0.064	0.07	0.116	0.13	0.02
2437	6	Left	Tilt	/	12.67	13.00	0.053	0.06	0.101	0.11	0.16
2437	6	Right	Touch	/	12.67	13.00	0.030	0.03	0.047	0.05	0.07
2437	6	Right	Tilt	/	12.67	13.00	0.019	0.02	0.034	0.04	0.01

As shown above table, the initial test position for head is “Left Touch”. So the head SAR of WLAN is presented as below:

Table 14.3-8: SAR Values (WLAN - Head)– 802.11b (Full SAR) Low Power

Frequency		Side	Test Position	Figure No.	Ambient Temperature: 22.9 °C		Liquid Temperature: 22.5°C				
MHz	Ch.				Conducted Power (dBm)	Max. tune-up Power (dBm)	Measured SAR(10g) (W/kg)	Reported SAR(10g) (W/kg)	Measured SAR(1g) (W/kg)	Reported SAR(1g)(W/kg)	Power Drift (dB)
2437	6	Left	Touch	/	12.67	13.00	0.057	0.06	0.103	0.11	0.02

Note1: When the reported SAR of the initial test position is > 0.4 W/kg, SAR is repeated for the 802.11 transmission mode configuration tested in the initial test position using subsequent highest estimated 1-g SAR conditions determined by area scans, on the highest maximum output power channel, until the reported SAR is ≤ 0.8 W/kg.

Note2: For all positions/configurations tested using the initial test position and subsequent test positions, when the reported SAR is > 0.8 W/kg, SAR is measured for these test positions/configurations on the subsequent next highest measured output power channel until the reported SAR is ≤ 1.2 W/kg or all required channels are tested.

According to the KDB248227 D01, The reported SAR must be scaled to 100% transmission duty factor to determine compliance at the maximum tune-up tolerance limit. The scaled reported SAR is presented as below.

Table 14.3-9: SAR Values (WLAN - Head) – 802.11b (Scaled Reported SAR)

Frequency		Side	Test Position	Ambient Temperature: 22.9 °C		Liquid Temperature: 22.5°C	
MHz	Ch.			Actual duty factor	maximum duty factor	Reported SAR (1g)(W/kg)	Scaled reported SAR (1g)(W/kg)
2437	6	Left	Touch	100%	100%	0.11	0.11

SAR is not required for OFDM because the 802.11b adjusted SAR ≤ 1.2 W/kg.

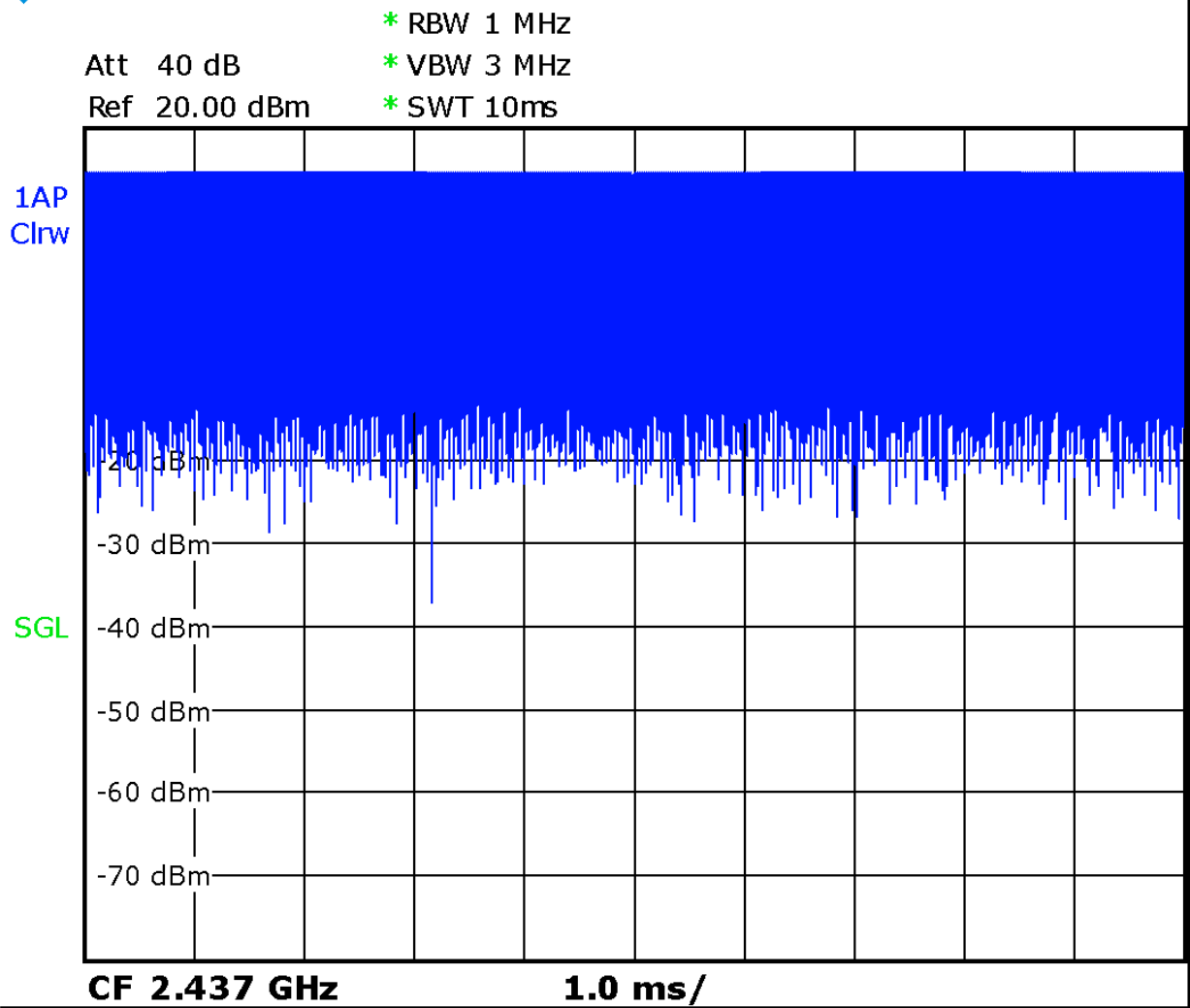

Picture 14.1 Duty factor plot

14.4 WLAN Evaluation For 5G

Table 14.4-1: OFDM mode specified maximum output power of WLAN antenna

802.11 mode	a	g	n		ac			
Ch. BW(MHz)	20	20	20	40	20	40	80	160
U-NII-1	X		X	X	X	X	X	
U-NII-2A	X		X	X	X	X	X	
U-NII-2C	X		X	X	X	X	X	
U-NII-3	X		X	X	X	X	X	
§ 15.247 (5.8 GHz)								

X: maximum(conducted) output power(mW), including tolerance, specified for production units

Table 14.4-2: Maximum output power specified of WLAN antenna for Normal Power

802.11 mode	a	g	n		ac			
Ch. BW(MHz)	20	20	20	40	20	40	80	160
U-NII-1	32		32	32	32	32	32	
U-NII-2A	32		32	32	32	32	32	
U-NII-2C	32		32	32	32	32	32	
U-NII-3	32		32	32	32	32	32	
§ 15.247 (5.8 GHz)								

- The maximum output power specified for production units is the same for all channels, modulations and data rates in each channel bandwidth configuration of the 802.11a/g/n/ac modes.
- The **blue highlighted** cells represent highest output configurations in each standalone or aggregated frequency band, with tune-up tolerance included.

Table 14.4-3: Maximum output power specified of WLAN antenna for Low Power

802.11 mode	a	g	n		ac			
Ch. BW(MHz)	20	20	20	40	20	40	80	160
U-NII-1	13		13	13	13	13	13	
U-NII-2A	13		13	13	13	13	13	
U-NII-2C	13		13	13	13	13	13	
U-NII-3	13		13	13	13	13	13	
§ 15.247 (5.8 GHz)								

- The maximum output power specified for production units is the same for all channels, modulations and data rates in each channel bandwidth configuration of the 802.11a/g/n/ac modes.
- The **blue highlighted** cells represent highest output configurations in each standalone or aggregated frequency band, with tune-up tolerance included.

Table 14.4-4: Maximum output power measured of WLAN antenna, for the applicable OFDM configurations according to the default power measurement procedures for selection initial test configurations - Normal Power

802.11 mode	a	n		ac		
BW(MHz)	20	20	40	20	40	80
U-NII-1	36/40/44/48 Lower power	36/40/44/48 Lower power	38/46 Lower power	36/40/44/48 Lower power	38/46 Lower power	42 24
U-NII-2A	52/56/60/64 Lower power	52/56/60/64 Lower power	54/62 Lower power	52/56/60/64 Lower power	54/62 Lower power	58 22
U-NII-2C	100/104/108/112 116/120/124/128 132/136/140/144 Lower power	100/104/108/112 116/132/136/140 Lower power	102/110/134 Lower power	100/104/108 /112 116/132/136/ 140 Lower power	102/110/134 Lower power	106/ 122 /138 24/25/24
U-NII-3	149/153/157/161/165 Lower power	149/153/157/16 1/165 Lower power	151/159 Lower power	149/153/157 /161/165 Lower power	151/159 Lower power	155 27

- The **bold numbers** is the maximum output measured power (mW).
- Channels with measured maximum power within 0.25dB are considered to have the same measured output. Channels selected for initial test configuration are **highlighted in yellow**.

Table 14.4-5: Maximum output power measured of WLAN antenna, for the applicable OFDM configurations according to the default power measurement procedures for selection initial test configurations – Low Power

802.11 mode	a	n		ac		
BW(MHz)	20	20	40	20	40	80
U-NII-1	36/40/44/48 Lower power	36/40/44/48 Lower power	38/46 Lower power	36/40/44/48 Lower power	38/46 Lower power	42 24
U-NII-2A	52/56/60/64 Lower power	52/56/60/64 Lower power	54/62 Lower power	52/56/60/64 Lower power	54/62 Lower power	58 22
U-NII-2C	100/104/108/112 116/120/124/128 132/136/140/144 Lower power	100/104/108/112 116/132/136/140 Lower power	102/110/134 Lower power	100/104/108 /112 116/132/136/ 140 Lower power	102/110/134 Lower power	106/ 122 /138 24/25/24
U-NII-3	149/153/157/161/165 Lower power	149/153/157/16 1/165 Lower power	151/159 Lower power	149/153/157 /161/165 Lower power	151/159 Lower power	155 27

- The **bold numbers** is the maximum output measured power (mW).
- Channels with measured maximum power within 0.25dB are considered to have the same measured output. Channels selected for initial test configuration are **highlighted in yellow**.

Table 14.4-6: Reported SAR of initial test configuration for Normal Power Head

802.11 mode	a	n		ac		
BW(MHz)	20	20	40	20	40	80
U-NII-1	36/40/44/48	36/40/44/48	38/46	36/40/44/48	38/46	42 UNII-2A exclusion applied
U-NII-2A	52/56/60/64	52/56/60/64	54/62	52/56/60/64	54/62	58 0.74
U-NII-2C	100/104/108/112/1 16/120/124/128/13 2/136/140/144	100/104/108/112 116/132/136/140	102/110/11 8/126/134	100/104/108/112 116/132/136/140	102/110/ 134	106/122/138 0.74
U-NII-3	149/153/157/161/1 65	149/153/157/161/1 65	151/159	149/153/157/161 /165	151/159	155 0.63

Highest measured output power channel tested initially are in **yellow highlight**.

The tune up of UNII-1 is less than UNII-2A. SAR is measured for UNII-2A band first. Adjusted SAR of UNII-2A band is ≤ 1.2 W/kg. SAR is not required for UNII-1 band.

Table 14.4-7: Reported SAR of initial test configuration for Low Power Head

802.11 mode	a	n		ac		
BW(MHz)	20	20	40	20	40	80
U-NII-1	36/40/44/48	36/40/44/48	38/46	36/40/44/48	38/46	42 UNII-2A exclusion applied
U-NII-2A	52/56/60/64	52/56/60/64	54/62	52/56/60/64	54/62	58 0.30
U-NII-2C	100/104/108/112/1 16/120/124/128/13 2/136/140/144	100/104/108/112 116/132/136/140	102/110/11 8/126/134	100/104/108/112 116/132/136/140	102/110/ 134	106/122/138 0.30
U-NII-3	149/153/157/161/1 65	149/153/157/161/1 65	151/159	149/153/157/161 /165	151/159	155 0.26

Highest measured output power channel tested initially are in **yellow highlight**.

The tune up of UNII-1 is less than UNII-2A. SAR is measured for UNII-2A band first. Adjusted SAR of UNII-2A band is ≤ 1.2 W/kg. SAR is not required for UNII-1 band.

Table 14.4-8: Reported SAR of initial test configuration for Body

802.11 mode	a	n		ac		
BW(MHz)	20	20	40	20	40	80
U-NII-1	36/40/44/48	36/40/44/48	38/46	36/40/44/48	38/46	42 UNII-2A exclusion applied
U-NII-2A	52/56/60/64	52/56/60/64	54/62	52/56/60/64	54/62	58 0.69
U-NII-2C	100/104/108/112/116/120/124/128/132/136/140/144	100/104/108/112/116/132/136/140	102/110/118/126/134	100/104/108/112/116/132/136/140	102/110/134	106/122/138 0.69
U-NII-3	149/153/157/161/165	149/153/157/161/165	151/159	149/153/157/161/165	151/159	155 0.65

Highest measured output power channel tested initially are in **yellow highlight**.
 The tune up of UNII-1 is less than UNII-2A. SAR is measured for UNII-2A band first. Adjusted SAR of UNII-2A band is ≤ 1.2 W/kg. SAR is not required for UNII-1 band.

Table 14.4-10: SAR Values (WLAN - Normal Power Head)

Frequency		Side	Test Position	Figure No.	Conducted Power (dBm)	Max. tune-up Power (dBm)	Measured SAR(10g) (W/kg)	Reported SAR(10g) (W/kg)	Measured SAR(1g) (W/kg)	Reported SAR(1g) (W/kg)	Power Drift (dB)
MHz	Ch.										
58	5290	Left	Touch	/	13.40	15.00	0.146	0.21	0.457	0.66	0.09
58	5290	Left	Tilt	/	13.40	15.00	0.158	0.23	0.514	0.74	0.10
58	5290	Right	Touch	/	13.40	15.00	0.131	0.19	0.415	0.60	-0.05
58	5290	Right	Tilt	/	13.40	15.00	0.158	0.23	0.487	0.70	-0.12
122	5610	Left	Touch	/	13.96	15.00	0.168	0.21	0.574	0.73	-0.09
122	5610	Left	Tilt	Fig.37	13.96	15.00	0.171	0.22	0.581	0.74	-0.07
122	5610	Right	Touch	/	13.96	15.00	0.126	0.16	0.456	0.58	0.03
122	5610	Right	Tilt	/	13.96	15.00	0.198	0.25	0.544	0.69	-0.03
155	5775	Left	Touch	/	14.30	15.00	0.144	0.17	0.511	0.60	0.13
155	5775	Left	Tilt	/	14.30	15.00	0.146	0.17	0.534	0.63	-0.03
155	5775	Right	Touch	/	14.30	15.00	0.104	0.12	0.389	0.46	0.07
155	5775	Right	Tilt	/	14.30	15.00	0.125	0.15	0.518	0.61	0.04

Table 14.4-10: SAR Values (WLAN - Body)

Frequency		Test Position	Figure No.	Conducted Power (dBm)	Max. tune-up Power (dBm)	Measured SAR(10g) (W/kg)	Reported SAR(10g) (W/kg)	Measured SAR(1g) (W/kg)	Reported SAR(1g) (W/kg)	Power Drift (dB)
MHz	Ch.									
58	5290	Front	/	13.40	15.00	0.057	0.08	0.163	0.24	-0.09
58	5290	Rear		13.40	15.00	0.169	0.24	0.477	0.69	0.07
58	5290	Right	/	13.40	15.00	0.052	0.08	0.125	0.18	0.07
58	5290	Top	/	13.40	15.00	0.158	0.23	0.397	0.57	-0.12
122	5610	Front	/	13.96	15.00	0.068	0.09	0.186	0.24	-0.13
122	5610	Rear	Fig.38	13.96	15.00	0.189	0.24	0.541	0.69	-0.06
122	5610	Right	/	13.96	15.00	0.059	0.07	0.145	0.18	0.03
122	5610	Top	/	13.96	15.00	0.142	0.18	0.356	0.45	0.13
155	5775	Front	/	14.30	15.00	0.095	0.11	0.252	0.30	-0.1
155	5775	Rear	/	14.30	15.00	0.193	0.23	0.556	0.65	-0.09
155	5775	Right	/	14.30	15.00	0.140	0.16	0.338	0.40	0.01
155	5775	Top	/	14.30	15.00	0.199	0.23	0.484	0.57	-0.08
155	5775	Rear	Note2	14.30	15.00	0.034	0.04	0.061	0.07	0.05

Note1: The distance between the EUT and the phantom bottom is 10mm.

Note2: The distance between the EUT and the phantom bottom is 17mm.

Table 14.4-11: SAR Values (WLAN - Low Power Head)

Frequency		Side	Test Position	Figure No.	Conducted Power (dBm)	Max. tune-up Power (dBm)	Measured SAR(10g) (W/kg)	Reported SAR(10g) (W/kg)	Measured SAR(1g) (W/kg)	Reported SAR(1g) (W/kg)	Power Drift (dB)
MHz	Ch.										
58	5290	Left	Touch	/	9.73	11.00	0.065	0.09	0.198	0.27	-0.12
58	5290	Left	Tilt	/	9.73	11.00	0.074	0.10	0.226	0.30	0.00
58	5290	Right	Touch	/	9.73	11.00	0.058	0.08	0.180	0.24	0.00
58	5290	Right	Tilt	/	9.73	11.00	0.070	0.09	0.211	0.28	0.02
122	5610	Left	Touch	/	10.19	11.00	0.075	0.09	0.249	0.30	0.06
122	5610	Left	Tilt	/	10.19	11.00	0.076	0.09	0.252	0.30	-0.03
122	5610	Right	Touch	/	10.19	11.00	0.056	0.07	0.198	0.24	-0.11
122	5610	Right	Tilt	/	10.19	11.00	0.088	0.11	0.236	0.28	0.06
155	5775	Left	Touch		10.56	11.00	0.064	0.07	0.222	0.25	0.11
155	5775	Left	Tilt	/	10.56	11.00	0.065	0.07	0.232	0.26	-0.09
155	5775	Right	Touch	/	10.56	11.00	0.046	0.05	0.169	0.19	-0.12
155	5775	Right	Tilt	/	10.56	11.00	0.056	0.06	0.225	0.25	-0.11

According to the KDB248227 D01, The reported SAR must be scaled to 100% transmission duty factor to determine compliance at the maximum tune-up tolerance limit. The scaled reported SAR is presented as below.

Table 14.4-12: SAR Values (WLAN - Normal Power Head) - Scaled Reported SAR

Frequency		Side	Test Position	Actual duty factor	maximum duty factor	Reported SAR (1g) (W/kg)	Scaled reported SAR (1g) (W/kg)
MHz	Ch.						
122	5610	Left	Tilt	92.31%	100%	0.74	0.79

Table 14.4-13: SAR Values (WLAN - Normal Power Body) – Scaled Reported SAR

Frequency		Test Position	D (mm)	Actual duty factor	maximum duty factor	Reported SAR (1g) (W/kg)	Scaled reported SAR (1g) (W/kg)
MHz	Ch.						
122	5610	Rear	10	92.31%	100%	0.69	0.74

Table 14.4-12: SAR Values (WLAN - Low Power Head) - Scaled Reported SAR

Frequency		Side	Test Position	Actual duty factor	maximum duty factor	Reported SAR (1g) (W/kg)	Scaled reported SAR (1g) (W/kg)
MHz	Ch.						
122	5610	Left	Tilt	92.31%	100%	0.30	0.33
122	5610	Right	Touch	92.31%	100%	0.24	0.26

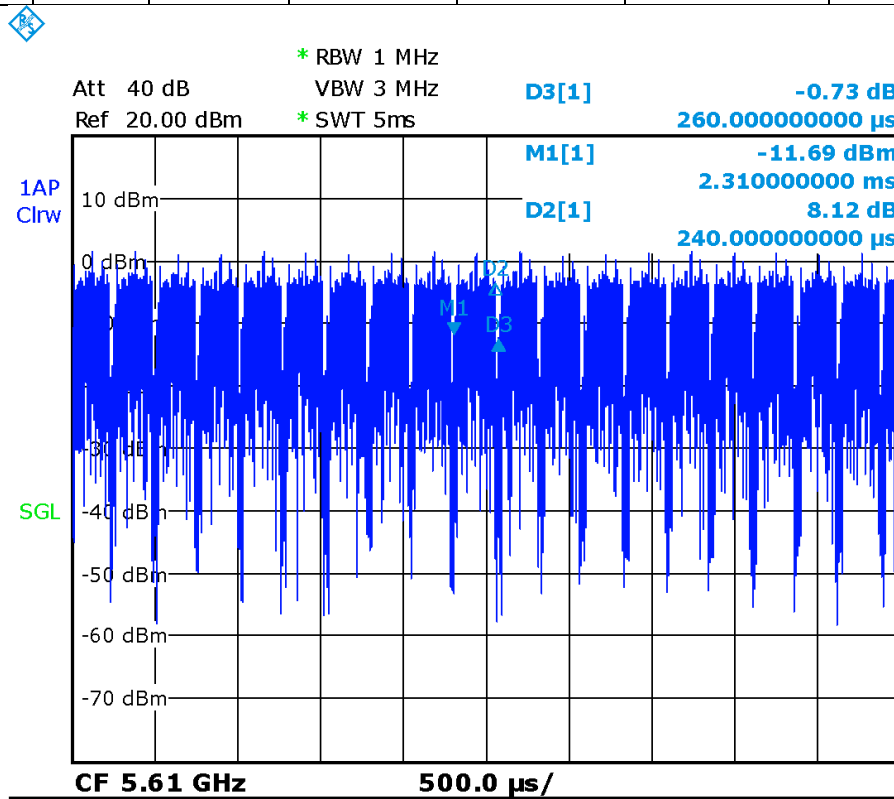

Picture 14.4 The plot of duty factor

15 SAR Measurement Variability

SAR measurement variability must be assessed for each frequency band, which is determined by the SAR probe calibration point and tissue-equivalent medium used for the device measurements. When both head and body tissue-equivalent media are required for SAR measurements in a frequency band, the variability measurement procedures should be applied to the tissue medium with the highest measured SAR, using the highest measured SAR configuration for that tissue-equivalent medium.

The following procedures are applied to determine if repeated measurements are required.

- 1) Repeated measurement is not required when the original highest measured SAR is < 0.80 W/kg; steps 2) through 4) do not apply.
- 2) When the original highest measured SAR is ≥ 0.80 W/kg, repeat that measurement once.
- 3) Perform a second repeated measurement only if the ratio of largest to smallest SAR for the original and first repeated measurements is > 1.20 or when the original or repeated measurement is ≥ 1.45 W/kg ($\sim 10\%$ from the 1-g SAR limit).
- 4) Perform a third repeated measurement only if the original, first or second repeated measurement is ≥ 1.5 W/kg and the ratio of largest to smallest SAR for the original, first and second repeated measurements is > 1.20 .

Table 15.1: SAR Measurement Variability for Head LTE B25(1g)

Frequency		Mode	Side	Test Position	Original SAR (W/kg)	First Repeated SAR (W/kg)	The Ratio	Second Repeated SAR (W/kg)
Ch.	MHz							
26140	1860	1RB_Low	Right	Touch	0.824	0.803	1.03	/

16 Measurement Uncertainty

16.1 Measurement Uncertainty for Normal SAR Tests (300MHz~3GHz)

No.	Error Description	Type	Uncertainty value	Probably Distribution	Div.	(Ci) 1g	(Ci) 10g	Std. Unc. (1g)	Std. Unc. (10g)	Degree of freedom
Measurement system										
1	Probe calibration	B	6.0	N	1	1	1	6.0	6.0	∞
2	Isotropy	B	4.7	R	$\sqrt{3}$	0.7	0.7	1.9	1.9	∞
3	Boundary effect	B	1.0	R	$\sqrt{3}$	1	1	0.6	0.6	∞
4	Linearity	B	4.7	R	$\sqrt{3}$	1	1	2.7	2.7	∞
5	Detection limit	B	1.0	N	1	1	1	0.6	0.6	∞
6	Readout electronics	B	0.3	R	$\sqrt{3}$	1	1	0.3	0.3	∞
7	Response time	B	0.8	R	$\sqrt{3}$	1	1	0.5	0.5	∞
8	Integration time	B	2.6	R	$\sqrt{3}$	1	1	1.5	1.5	∞
9	RF ambient conditions-noise	B	0	R	$\sqrt{3}$	1	1	0	0	∞
10	RFambient conditions-reflection	B	0	R	$\sqrt{3}$	1	1	0	0	∞
11	Probe positioned mech. restrictions	B	0.4	R	$\sqrt{3}$	1	1	0.2	0.2	∞
12	Probe positioning with respect to phantom shell	B	2.9	R	$\sqrt{3}$	1	1	1.7	1.7	∞
13	Post-processing	B	1.0	R	$\sqrt{3}$	1	1	0.6	0.6	∞
Test sample related										
14	Test sample positioning	A	3.3	N	1	1	1	3.3	3.3	71
15	Device holder uncertainty	A	3.4	N	1	1	1	3.4	3.4	5
16	Drift of output power	B	5.0	R	$\sqrt{3}$	1	1	2.9	2.9	∞
Phantom and set-up										
17	Phantom uncertainty	B	4.0	R	$\sqrt{3}$	1	1	2.3	2.3	∞
18	Liquid conductivity (target)	B	5.0	R	$\sqrt{3}$	0.64	0.43	1.8	1.2	∞
19	Liquid conductivity (meas.)	A	2.06	N	1	0.64	0.43	1.32	0.89	43
20	Liquid permittivity (target)	B	5.0	R	$\sqrt{3}$	0.6	0.49	1.7	1.4	∞
21	Liquid permittivity (meas.)	A	1.6	N	1	0.6	0.49	1.0	0.8	521

Combined standard uncertainty	$u_c = \sqrt{\sum_{i=1}^{21} c_i^2 u_i^2}$							9.55	9.43	257
Expanded uncertainty (confidence interval of 95 %)	$u_e = 2u_c$							19.1	18.9	

16.2 Measurement Uncertainty for Normal SAR Tests (3~6GHz)

No.	Error Description	Type	Uncertainty value	Probably Distribution	Div.	(Ci) 1g	(Ci) 10g	Std. Unc. (1g)	Std. Unc. (10g)	Degree of freedom
Measurement system										
1	Probe calibration	B	6.55	N	1	1	1	6.55	6.55	∞
2	Isotropy	B	4.7	R	$\sqrt{3}$	0.7	0.7	1.9	1.9	∞
3	Boundary effect	B	2.0	R	$\sqrt{3}$	1	1	1.2	1.2	∞
4	Linearity	B	4.7	R	$\sqrt{3}$	1	1	2.7	2.7	∞
5	Detection limit	B	1.0	R	$\sqrt{3}$	1	1	0.6	0.6	∞
6	Readout electronics	B	0.3	R	$\sqrt{3}$	1	1	0.3	0.3	∞
7	Response time	B	0.8	R	$\sqrt{3}$	1	1	0.5	0.5	∞
8	Integration time	B	2.6	R	$\sqrt{3}$	1	1	1.5	1.5	∞
9	RF ambient conditions-noise	B	0	R	$\sqrt{3}$	1	1	0	0	∞
10	RFambient conditions-reflection	B	0	R	$\sqrt{3}$	1	1	0	0	∞
11	Probe positioned mech. restrictions	B	0.8	R	$\sqrt{3}$	1	1	0.5	0.5	∞
12	Probe positioning with respect to phantom shell	B	6.7	R	$\sqrt{3}$	1	1	3.9	3.9	∞
13	Post-processing	B	4.0	R	$\sqrt{3}$	1	1	2.3	2.3	∞
Test sample related										
14	Test sample positioning	A	3.3	N	1	1	1	3.3	3.3	71
15	Device holder uncertainty	A	3.4	N	1	1	1	3.4	3.4	5
16	Drift of output power	B	5.0	R	$\sqrt{3}$	1	1	2.9	2.9	∞
Phantom and set-up										
17	Phantom uncertainty	B	4.0	R	$\sqrt{3}$	1	1	2.3	2.3	∞
18	Liquid conductivity (target)	B	5.0	R	$\sqrt{3}$	0.64	0.43	1.8	1.2	∞
19	Liquid conductivity (meas.)	A	2.06	N	1	0.64	0.43	1.32	0.89	43
20	Liquid permittivity	B	5.0	R	$\sqrt{3}$	0.6	0.49	1.7	1.4	∞

	(target)									
21	Liquid permittivity (meas.)	A	1.6	N	1	0.6	0.49	1.0	0.8	521
Combined standard uncertainty		$u_c = \sqrt{\sum_{i=1}^{21} c_i^2 u_i^2}$						10.7	10.6	257
Expanded uncertainty (confidence interval of 95 %)		$u_e = 2u_c$						21.4	21.1	

16.3 Measurement Uncertainty for Fast SAR Tests (300MHz~3GHz)

No.	Error Description	Type	Uncertainty value	Probably Distribution	Div.	(Ci) 1g	(Ci) 10g	Std. Unc. (1g)	Std. Unc. (10g)	Degree of freedom
Measurement system										
1	Probe calibration	B	6.0	N	1	1	1	6.0	6.0	∞
2	Isotropy	B	4.7	R	$\sqrt{3}$	0.7	0.7	1.9	1.9	∞
3	Boundary effect	B	1.0	R	$\sqrt{3}$	1	1	0.6	0.6	∞
4	Linearity	B	4.7	R	$\sqrt{3}$	1	1	2.7	2.7	∞
5	Detection limit	B	1.0	R	$\sqrt{3}$	1	1	0.6	0.6	∞
6	Readout electronics	B	0.3	R	$\sqrt{3}$	1	1	0.3	0.3	∞
7	Response time	B	0.8	R	$\sqrt{3}$	1	1	0.5	0.5	∞
8	Integration time	B	2.6	R	$\sqrt{3}$	1	1	1.5	1.5	∞
9	RF ambient conditions-noise	B	0	R	$\sqrt{3}$	1	1	0	0	∞
10	RFambient conditions-reflection	B	0	R	$\sqrt{3}$	1	1	0	0	∞
11	Probe positioned mech. Restrictions	B	0.4	R	$\sqrt{3}$	1	1	0.2	0.2	∞
12	Probe positioning with respect to phantom shell	B	2.9	R	$\sqrt{3}$	1	1	1.7	1.7	∞
13	Post-processing	B	1.0	R	$\sqrt{3}$	1	1	0.6	0.6	∞
14	Fast SAR z-Approximation	B	7.0	R	$\sqrt{3}$	1	1	4.0	4.0	∞
Test sample related										
15	Test sample positioning	A	3.3	N	1	1	1	3.3	3.3	71
16	Device holder uncertainty	A	3.4	N	1	1	1	3.4	3.4	5
17	Drift of output power	B	5.0	R	$\sqrt{3}$	1	1	2.9	2.9	∞
Phantom and set-up										
18	Phantom uncertainty	B	4.0	R	$\sqrt{3}$	1	1	2.3	2.3	∞

19	Liquid conductivity (target)	B	5.0	R	$\sqrt{3}$	0.64	0.43	1.8	1.2	∞
20	Liquid conductivity (meas.)	A	2.06	N	1	0.64	0.43	1.32	0.89	43
21	Liquid permittivity (target)	B	5.0	R	$\sqrt{3}$	0.6	0.49	1.7	1.4	∞
22	Liquid permittivity (meas.)	A	1.6	N	1	0.6	0.49	1.0	0.8	521
Combined standard uncertainty		$u_c = \sqrt{\sum_{i=1}^{22} c_i^2 u_i^2}$						10.4	10.3	257
Expanded uncertainty (confidence interval of 95 %)		$u_e = 2u_c$						20.8	20.6	

16.4 Measurement Uncertainty for Fast SAR Tests (3~6GHz)

No.	Error Description	Type	Uncertainty value	Probably Distribution	Div.	(Ci) 1g	(Ci) 10g	Std. Unc. (1g)	Std. Unc. (10g)	Degree of freedom
Measurement system										
1	Probe calibration	B	6.55	N	1	1	1	6.55	6.55	∞
2	Isotropy	B	4.7	R	$\sqrt{3}$	0.7	0.7	1.9	1.9	∞
3	Boundary effect	B	2.0	R	$\sqrt{3}$	1	1	1.2	1.2	∞
4	Linearity	B	4.7	R	$\sqrt{3}$	1	1	2.7	2.7	∞
5	Detection limit	B	1.0	R	$\sqrt{3}$	1	1	0.6	0.6	∞
6	Readout electronics	B	0.3	R	$\sqrt{3}$	1	1	0.3	0.3	∞
7	Response time	B	0.8	R	$\sqrt{3}$	1	1	0.5	0.5	∞
8	Integration time	B	2.6	R	$\sqrt{3}$	1	1	1.5	1.5	∞
9	RF ambient conditions-noise	B	0	R	$\sqrt{3}$	1	1	0	0	∞
10	RF ambient conditions-reflection	B	0	R	$\sqrt{3}$	1	1	0	0	∞
11	Probe positioned mech. Restrictions	B	0.8	R	$\sqrt{3}$	1	1	0.5	0.5	∞
12	Probe positioning with respect to phantom shell	B	6.7	R	$\sqrt{3}$	1	1	3.9	3.9	∞
13	Post-processing	B	1.0	R	$\sqrt{3}$	1	1	0.6	0.6	∞
14	Fast SAR z-Approximation	B	14.0	R	$\sqrt{3}$	1	1	8.1	8.1	∞
Test sample related										
15	Test sample positioning	A	3.3	N	1	1	1	3.3	3.3	71

16	Device holder uncertainty	A	3.4	N	1	1	1	3.4	3.4	5
17	Drift of output power	B	5.0	R	$\sqrt{3}$	1	1	2.9	2.9	∞
Phantom and set-up										
18	Phantom uncertainty	B	4.0	R	$\sqrt{3}$	1	1	2.3	2.3	∞
19	Liquid conductivity (target)	B	5.0	R	$\sqrt{3}$	0.64	0.43	1.8	1.2	∞
20	Liquid conductivity (meas.)	A	2.06	N	1	0.64	0.43	1.32	0.89	43
21	Liquid permittivity (target)	B	5.0	R	$\sqrt{3}$	0.6	0.49	1.7	1.4	∞
22	Liquid permittivity (meas.)	A	1.6	N	1	0.6	0.49	1.0	0.8	521
Combined standard uncertainty		$u_c = \sqrt{\sum_{i=1}^{22} c_i^2 u_i^2}$						13.5	13.4	257
Expanded uncertainty (confidence interval of 95 %)		$u_e = 2u_c$						27.0	26.8	

17 MAIN TEST INSTRUMENTS

Table 17.1: List of Main Instruments

No.	Name	Type	Serial Number	Calibration Date	Valid Period
01	Network analyzer	N5239A	MY46110673	January 24, 2020	One year
02	Power meter	NRP2	101919	May 12, 2020	One year
03	Power sensor	NRP-Z91	101547		
04	Signal Generator	E4438C	MY49071430	February 25, 2020	One Year
05	Amplifier	60S1G4	0331848	No Calibration Requested	
06	BTS	CMW500	129942	February 10, 2020	One year
07	E-field Probe	SPEAG EX3DV4	3617	Jan 30, 2020	One year
08	DAE	SPEAG DAE4	536	November 6, 2020	One year
09	Dipole Validation Kit	SPEAG D750V3	1017	July 24,2020	One year
10	Dipole Validation Kit	SPEAG D835V2	4d069	July 24,,2020	One year
11	Dipole Validation Kit	SPEAG D1750V2	1003	July 24, 2020	One year
12	Dipole Validation Kit	SPEAG D1900V2	5d101	July 28,2020	One year
13	Dipole Validation Kit	SPEAG D2450V2	853	July 21,2020	One year
14	Dipole Validation Kit	SPEAG D2600V2	1012	July 21,2020	One year
15	Dipole Validation Kit	SPEAG D5GHzV2	1060	July 27,2020	One year

END OF REPORT BODY

ANNEX A Graph Results

GSM850_CH251 Right Cheek

Date: 1/5/2020

Electronics: DAE4 Sn536

Medium: head 835 MHz

Medium parameters used: $f = 848.8$; $\sigma = 0.902$ mho/m; $\epsilon_r = 42.27$; $\rho = 1000$ kg/m³

Ambient Temperature: 22.5°C, Liquid Temperature: 22.3°C

Communication System: GSM850 848.8 Duty Cycle: 1: 4

Probe: EX3DV4 – SN3617 ConvF(9.66,9.66,9.66)

Area Scan (71x121x1): Interpolated grid: dx=1.000 mm, dy=1.000 mm

Maximum value of SAR (interpolated) = 0.287 W/kg

Zoom Scan (7x7x7)/Cube 0: Measurement grid: dx=5mm, dy=5mm, dz=5mm

Reference Value = 5.68 V/m; Power Drift = 0.03 dB

Peak SAR (extrapolated) = 0.539 W/kg

SAR(1 g) = 0.281 W/kg; SAR(10 g) = 0.182 W/kg

Maximum value of SAR (measured) = 0.277 W/kg

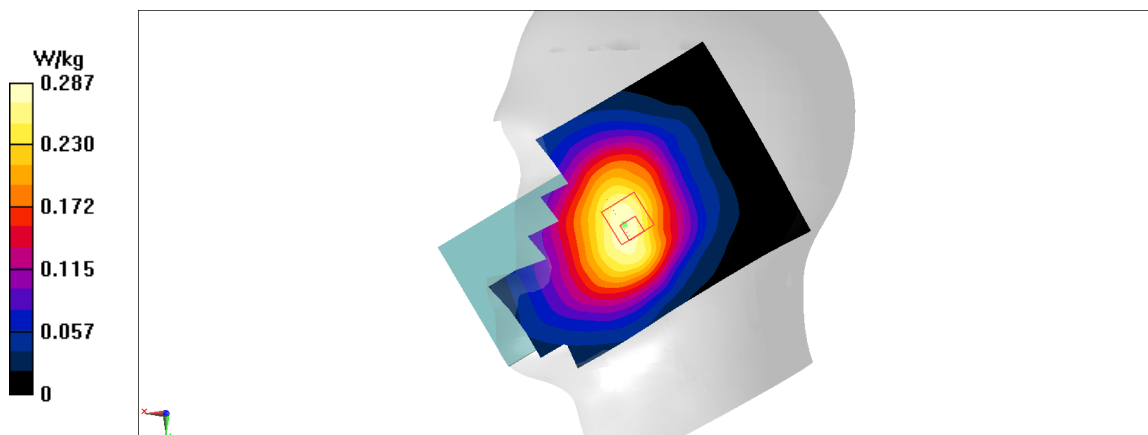

Fig A.1

GSM850_CH251 Rear

Date: 1/5/2020

Electronics: DAE4 Sn536

Medium: head 835 MHz

Medium parameters used: $f = 848.8$; $\sigma = 0.902$ mho/m; $\epsilon_r = 42.27$; $\rho = 1000$ kg/m³

Ambient Temperature: 22.5°C, Liquid Temperature: 22.3°C

Communication System: GSM850 848.8 Duty Cycle: 1: 4

Probe: EX3DV4 – SN3617 ConvF(9.66,9.66,9.66)

Area Scan (71x121x1): Interpolated grid: dx=1.000 mm, dy=1.000 mm

Maximum value of SAR (interpolated) = 0.485 W/kg

Zoom Scan (7x7x7)/Cube 0: Measurement grid: dx=5mm, dy=5mm, dz=5mm

Reference Value = 24.43 V/m; Power Drift = 0.08 dB

Peak SAR (extrapolated) = 1.39 W/kg

SAR(1 g) = 0.513 W/kg; SAR(10 g) = 0.242 W/kg

Maximum value of SAR (measured) = 0.453 W/kg

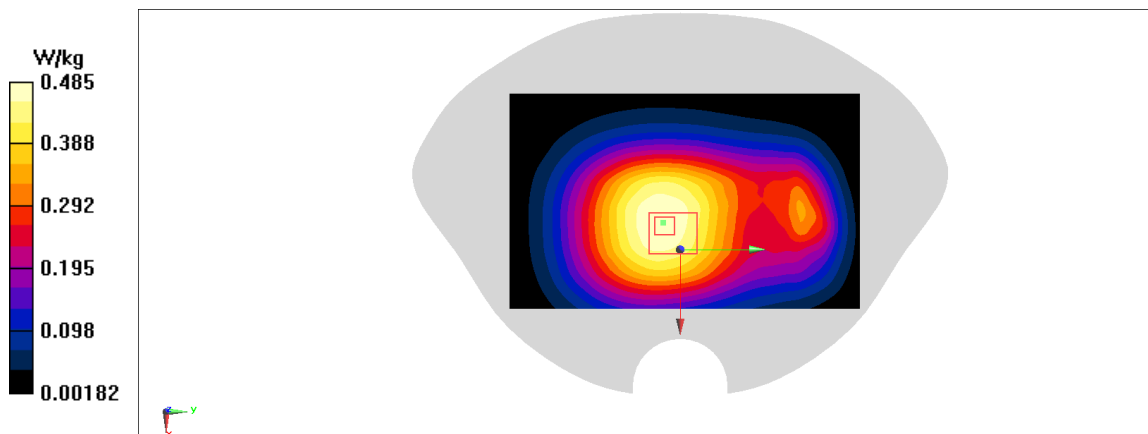
**Fig A.2**

PCS1900_CH512 Right Cheek

Date: 1/8/2020

Electronics: DAE4 Sn536

Medium: head 1900 MHz

Medium parameters used: $f = 1850.2$; $\sigma = 1.37$ mho/m; $\epsilon_r = 40.23$; $\rho = 1000$ kg/m³

Ambient Temperature: 22.5°C, Liquid Temperature: 22.3°C

Communication System: PCS1900 1850.2 Duty Cycle: 1: 4

Probe: EX3DV4 – SN3617 ConvF(8.14,8.14,8.14)

Area Scan (71x121x1): Interpolated grid: dx=1.000 mm, dy=1.000 mm

Maximum value of SAR (interpolated) = 0.546 W/kg

Zoom Scan (7x7x7)/Cube 0: Measurement grid: dx=5mm, dy=5mm, dz=5mm

Reference Value = 11.08 V/m; Power Drift = 0.02 dB

Peak SAR (extrapolated) = 0.678 W/kg

SAR(1 g) = 0.362 W/kg; SAR(10 g) = 0.182 W/kg

Maximum value of SAR (measured) = 0.534 W/kg

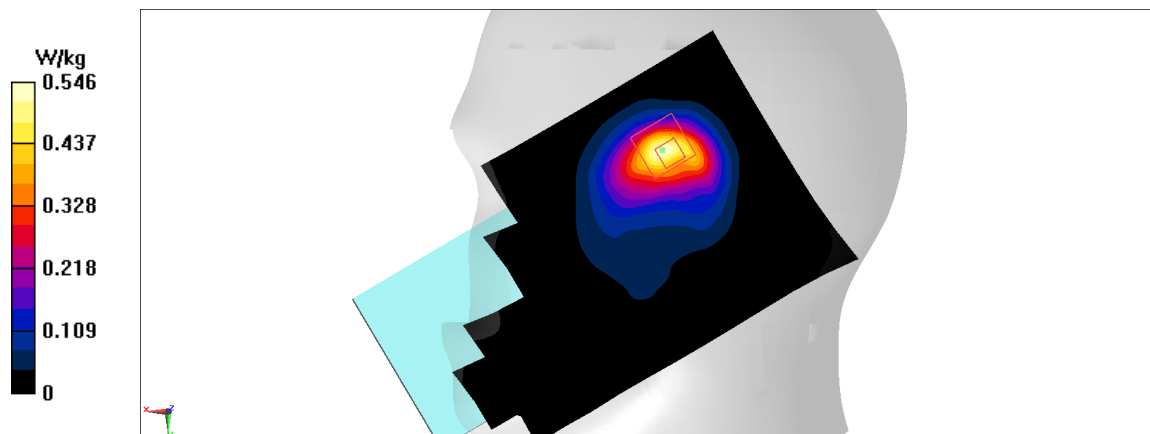
**Fig A.3**

PCS1900_CH810 Front

Date: 1/8/2020

Electronics: DAE4 Sn536

Medium: head 1900 MHz

Medium parameters used: $f = 1909.8$; $\sigma = 1.428$ mho/m; $\epsilon_r = 40.16$; $\rho = 1000$ kg/m³

Ambient Temperature: 22.5°C, Liquid Temperature: 22.3°C

Communication System: PCS1900 1909.8 Duty Cycle: 1: 4

Probe: EX3DV4 – SN3617 ConvF(8.14,8.14,8.14)

Area Scan (71x121x1): Interpolated grid: dx=1.000 mm, dy=1.000 mm

Maximum value of SAR (interpolated) = 0.502 W/kg

Zoom Scan (7x7x7)/Cube 0: Measurement grid: dx=5mm, dy=5mm, dz=5mm

Reference Value = 11.35 V/m; Power Drift = -0.08 dB

Peak SAR (extrapolated) = 1.18 W/kg

SAR(1 g) = 0.442 W/kg; SAR(10 g) = 0.204 W/kg

Maximum value of SAR (measured) = 0.489 W/kg

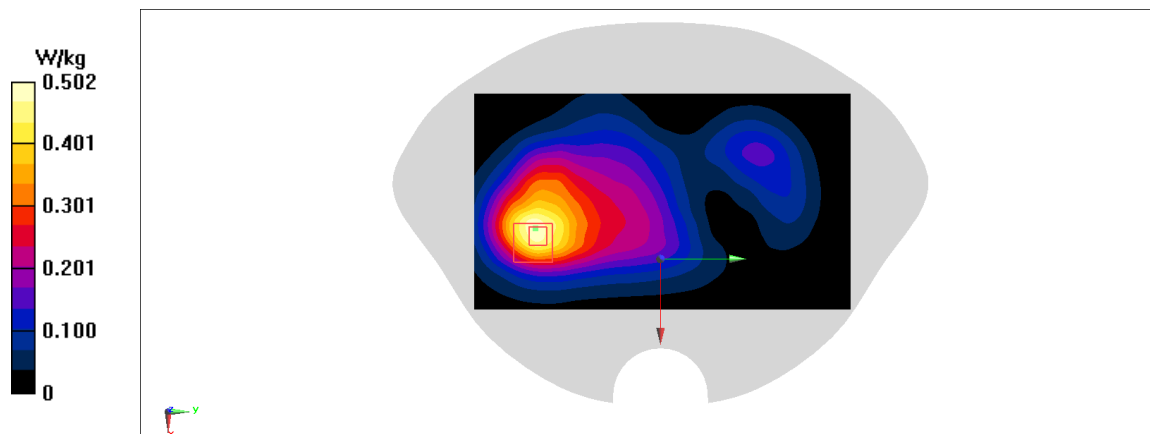
**Fig A.4**

WCDMA1900-BII_CH9262 Left Cheek

Date: 1/8/2020

Electronics: DAE4 Sn536

Medium: head 1900 MHz

Medium parameters used: $f = 1852.4$; $\sigma = 1.372$ mho/m; $\epsilon_r = 40.23$; $\rho = 1000$ kg/m³

Ambient Temperature: 22.5°C, Liquid Temperature: 22.3°C

Communication System: WCDMA1900-BII 1852.4 Duty Cycle: 1: 1

Probe: EX3DV4 – SN3617 ConvF(8.14,8.14,8.14)

Area Scan (71x121x1): Interpolated grid: dx=1.000 mm, dy=1.000 mm

Maximum value of SAR (interpolated) = 0.548 W/kg

Zoom Scan (7x7x7)/Cube 0: Measurement grid: dx=5mm, dy=5mm, dz=5mm

Reference Value = 17.39 V/m; Power Drift = -0.12 dB

Peak SAR (extrapolated) = 0.578 W/kg

SAR(1 g) = 0.342 W/kg; SAR(10 g) = 0.201 W/kg

Maximum value of SAR (measured) = 0.488 W/kg

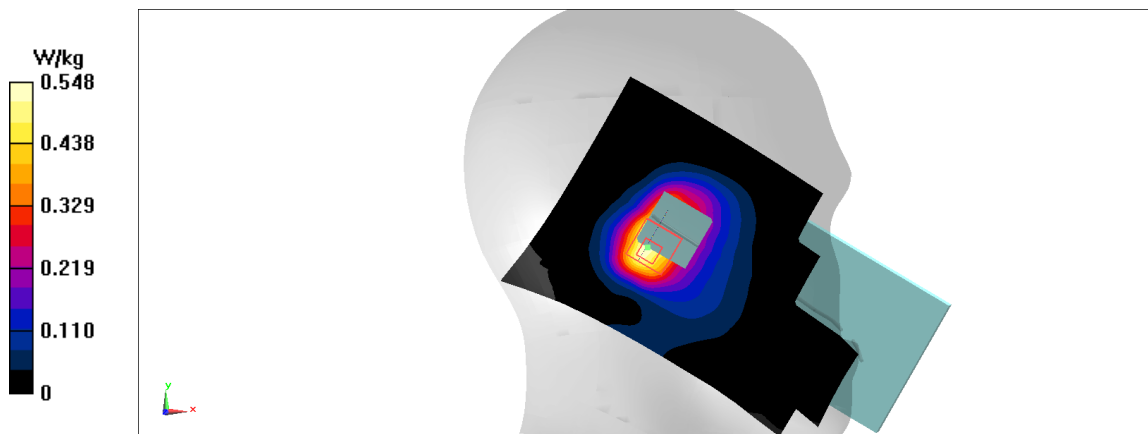

Fig A.5

WCDMA1900-BII_CH9538 Front

Date: 1/8/2020

Electronics: DAE4 Sn536

Medium: head 1900 MHz

Medium parameters used: $f = 1907.6$; $\sigma = 1.426$ mho/m; $\epsilon_r = 40.16$; $\rho = 1000$ kg/m³

Ambient Temperature: 22.5°C, Liquid Temperature: 22.3°C

Communication System: WCDMA1900-BII 1907.6 Duty Cycle: 1: 1

Probe: EX3DV4 – SN3617 ConvF(8.14,8.14,8.14)

Area Scan (71x121x1): Interpolated grid: dx=1.000 mm, dy=1.000 mm

Maximum value of SAR (interpolated) = 0.783 W/kg

Zoom Scan (7x7x7)/Cube 0: Measurement grid: dx=5mm, dy=5mm, dz=5mm

Reference Value = 14.54 V/m; Power Drift = -0.1 dB

Peak SAR (extrapolated) = 0.97 W/kg

SAR(1 g) = 0.547 W/kg; SAR(10 g) = 0.311 W/kg

Maximum value of SAR (measured) = 0.807 W/kg

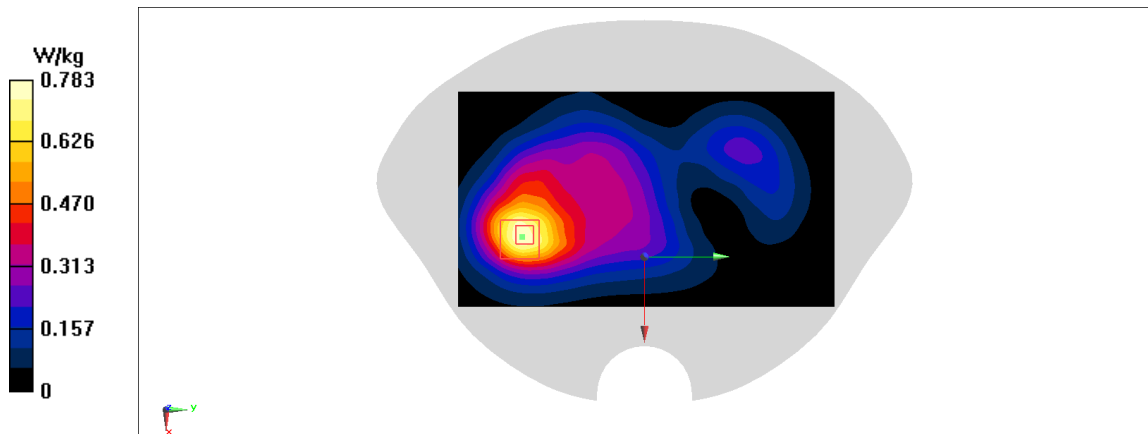
**Fig A.6**

WCDMA1700-BIV_CH1513 Right Tilt

Date: 1/7/2020

Electronics: DAE4 Sn536

Medium: head 1750 MHz

Medium parameters used: $f = 1752.6$; $\sigma = 1.361$ mho/m; $\epsilon_r = 40.85$; $\rho = 1000$ kg/m³

Ambient Temperature: 22.5°C, Liquid Temperature: 22.3°C

Communication System: WCDMA1700-BIV 1752.6 Duty Cycle: 1: 1

Probe: EX3DV4 – SN3617 ConvF(8.41,8.41,8.41)

Area Scan (71x121x1): Interpolated grid: dx=1.000 mm, dy=1.000 mm

Maximum value of SAR (interpolated) = 0.924 W/kg

Zoom Scan (7x7x7)/Cube 0: Measurement grid: dx=5mm, dy=5mm, dz=5mm

Reference Value = 19.81 V/m; Power Drift = 0.1 dB

Peak SAR (extrapolated) = 1.15 W/kg

SAR(1 g) = 0.553 W/kg; SAR(10 g) = 0.269 W/kg

Maximum value of SAR (measured) = 0.838 W/kg

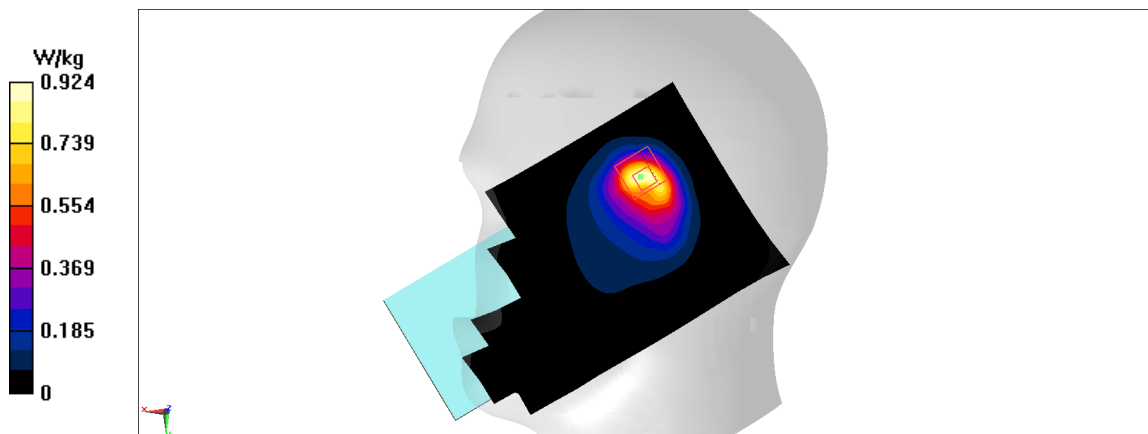
**Fig A.7**

WCDMA1700-BIV_CH1513 Rear

Date: 1/7/2020

Electronics: DAE4 Sn536

Medium: head 1750 MHz

Medium parameters used: $f = 1752.6$; $\sigma = 1.361$ mho/m; $\epsilon_r = 40.85$; $\rho = 1000$ kg/m³

Ambient Temperature: 22.5°C, Liquid Temperature: 22.3°C

Communication System: WCDMA1700-BIV 1752.6 Duty Cycle: 1: 1

Probe: EX3DV4 – SN3617 ConvF(8.41,8.41,8.41)

Area Scan (71x121x1): Interpolated grid: dx=1.000 mm, dy=1.000 mm

Maximum value of SAR (interpolated) = 0.739 W/kg

Zoom Scan (7x7x7)/Cube 0: Measurement grid: dx=5mm, dy=5mm, dz=5mm

Reference Value = 8.825 V/m; Power Drift = -0.13 dB

Peak SAR (extrapolated) = 0.996 W/kg

SAR(1 g) = 0.48 W/kg; SAR(10 g) = 0.225 W/kg

Maximum value of SAR (measured) = 0.76 W/kg

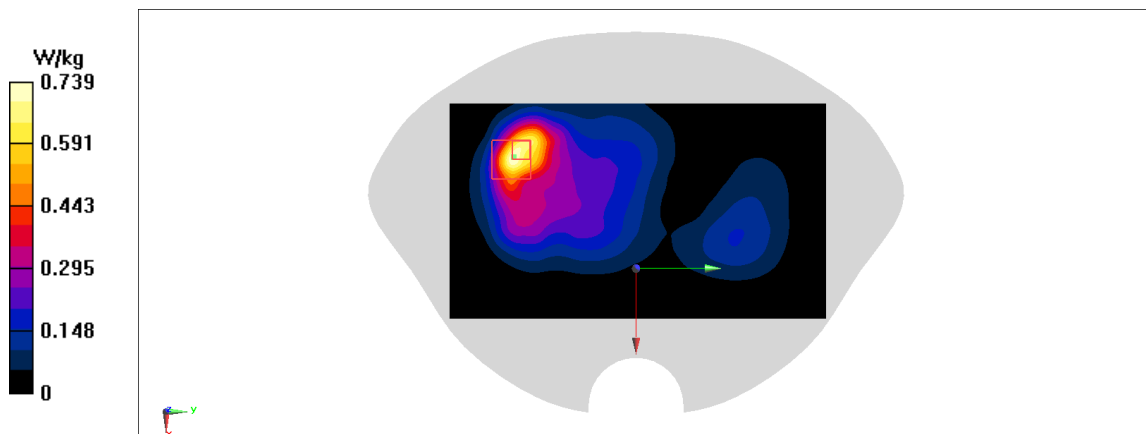
**Fig A.8**

WCDMA850-BV_CH4183 Left Cheek

Date: 1/5/2020

Electronics: DAE4 Sn536

Medium: head 835 MHz

Medium parameters used: $f = 836.6$; $\sigma = 0.891$ mho/m; $\epsilon_r = 42.29$; $\rho = 1000$ kg/m³

Ambient Temperature: 22.5°C, Liquid Temperature: 22.3°C

Communication System: WCDMA850-BV 836.6 Duty Cycle: 1: 1

Probe: EX3DV4 – SN3617 ConvF(9.66,9.66,9.66)

Area Scan (71x121x1): Interpolated grid: dx=1.000 mm, dy=1.000 mm

Maximum value of SAR (interpolated) = 0.361 W/kg

Zoom Scan (7x7x7)/Cube 0: Measurement grid: dx=5mm, dy=5mm, dz=5mm

Reference Value = 4.741 V/m; Power Drift = -0.02 dB

Peak SAR (extrapolated) = 0.402 W/kg

SAR(1 g) = 0.294 W/kg; SAR(10 g) = 0.225 W/kg

Maximum value of SAR (measured) = 0.359 W/kg

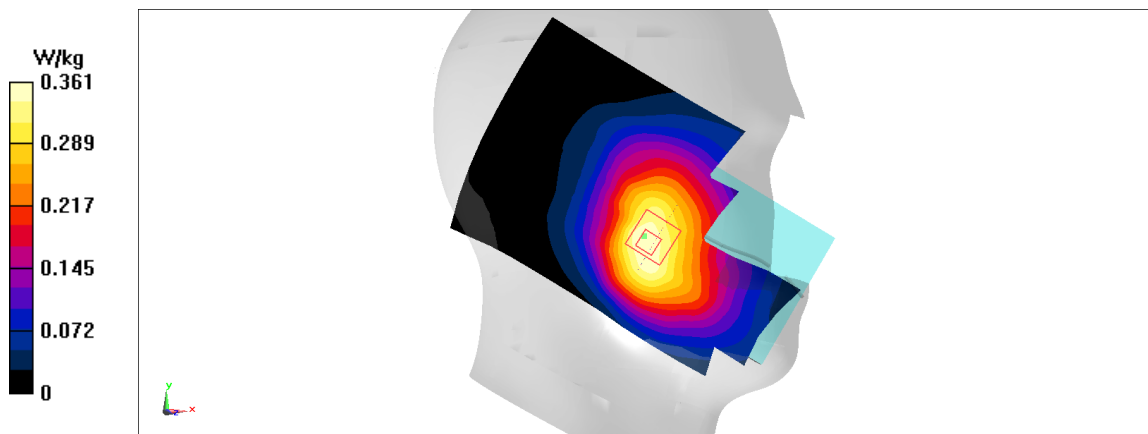
**Fig A.9**

WCDMA850-BV_CH4183 Rear

Date: 1/5/2020

Electronics: DAE4 Sn536

Medium: head 835 MHz

Medium parameters used: $f = 836.6$; $\sigma = 0.891$ mho/m; $\epsilon_r = 42.29$; $\rho = 1000$ kg/m³

Ambient Temperature: 22.5°C, Liquid Temperature: 22.3°C

Communication System: WCDMA850-BV 836.6 Duty Cycle: 1: 1

Probe: EX3DV4 – SN3617 ConvF(9.66,9.66,9.66)

Area Scan (71x121x1): Interpolated grid: dx=1.000 mm, dy=1.000 mm

Maximum value of SAR (interpolated) = 0.625 W/kg

Zoom Scan (7x7x7)/Cube 0: Measurement grid: dx=5mm, dy=5mm, dz=5mm

Reference Value = 27.29 V/m; Power Drift = -0.04 dB

Peak SAR (extrapolated) = 0.675 W/kg

SAR(1 g) = 0.479 W/kg; SAR(10 g) = 0.361 W/kg

Maximum value of SAR (measured) = 0.599 W/kg

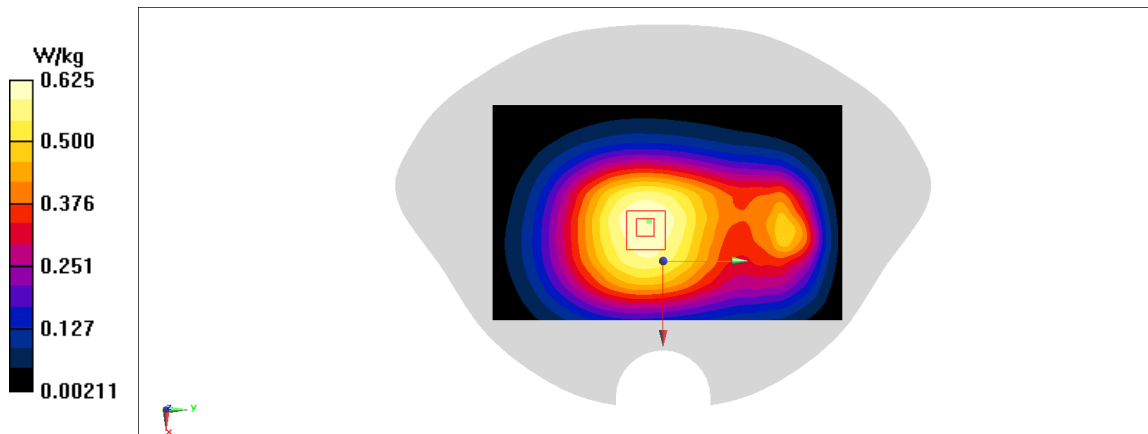

Fig A.10

CDMA800-BC0_CH384 Right Cheek

Date: 1/6/2021

Electronics: DAE4 Sn536

Medium: head 835 MHz

Medium parameters used: $f = 836.52$; $\sigma = 0.891$ mho/m; $\epsilon_r = 40.8$; $\rho = 1000$ kg/m³

Ambient Temperature: 22.5°C, Liquid Temperature: 22.3°C

Communication System: CDMA800-BC0 836.52 Duty Cycle: 1: 1

Probe: EX3DV4 – SN3617 ConvF(9.66,9.66,9.66)

Area Scan (71x121x1): Interpolated grid: dx=1.000 mm, dy=1.000 mm

Maximum value of SAR (interpolated) = 0.423 W/kg

Zoom Scan (7x7x7)/Cube 0: Measurement grid: dx=5mm, dy=5mm, dz=5mm

Reference Value = 7.002 V/m; Power Drift = -0.12 dB

Peak SAR (extrapolated) = 0.477 W/kg

SAR(1 g) = 0.354 W/kg; SAR(10 g) = 0.268 W/kg

Maximum value of SAR (measured) = 0.429 W/kg

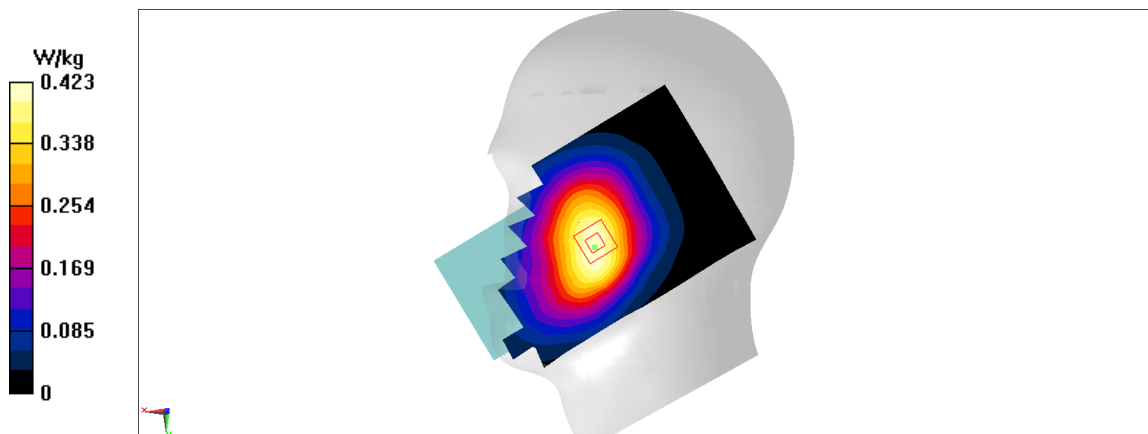
**Fig A.11**

CDMA800-BC0_CH384 Rear

Date: 1/6/2021

Electronics: DAE4 Sn536

Medium: head 835 MHz

Medium parameters used: $f = 836.52$; $\sigma = 0.891$ mho/m; $\epsilon_r = 40.8$; $\rho = 1000$ kg/m³

Ambient Temperature: 22.5°C, Liquid Temperature: 22.3°C

Communication System: CDMA800-BC0 836.52 Duty Cycle: 1: 1

Probe: EX3DV4 – SN3617 ConvF(9.66,9.66,9.66)

Area Scan (71x121x1): Interpolated grid: dx=1.000 mm, dy=1.000 mm

Maximum value of SAR (interpolated) = 0.692 W/kg

Zoom Scan (7x7x7)/Cube 0: Measurement grid: dx=5mm, dy=5mm, dz=5mm

Reference Value = 25.03 V/m; Power Drift = -0.05 dB

Peak SAR (extrapolated) = 0.782 W/kg

SAR(1 g) = 0.552 W/kg; SAR(10 g) = 0.411 W/kg

Maximum value of SAR (measured) = 0.694 W/kg

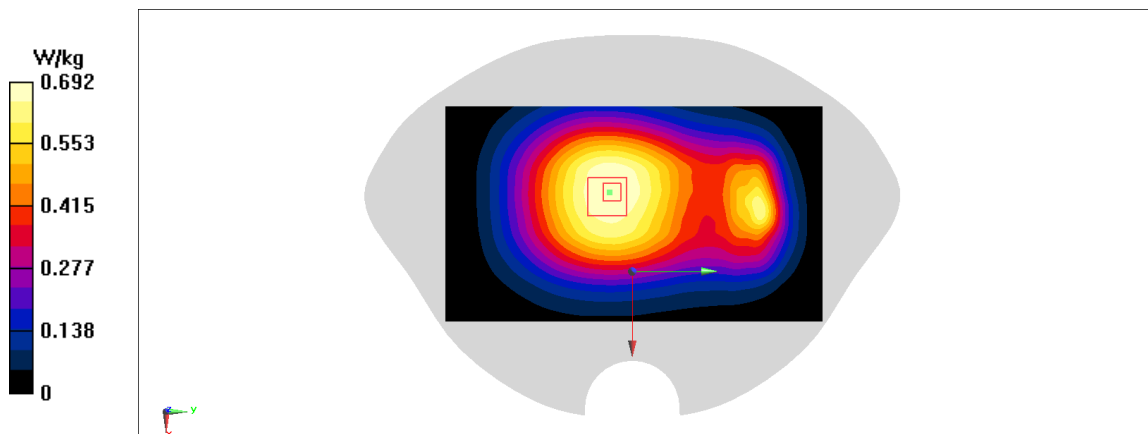
**Fig A.12**

CDMA1900-BC1_CH600 Right Cheek

Date: 1/9/2021

Electronics: DAE4 Sn536

Medium: head 1900 MHz

Medium parameters used: $f = 1880$; $\sigma = 1.391$ mho/m; $\epsilon_r = 40.04$; $\rho = 1000$ kg/m³

Ambient Temperature: 22.5°C, Liquid Temperature: 22.3°C

Communication System: CDMA1900-BC1 1880 Duty Cycle: 1: 1

Probe: EX3DV4 – SN3617 ConvF(8.14,8.14,8.14)

Area Scan (71x121x1): Interpolated grid: dx=1.000 mm, dy=1.000 mm

Maximum value of SAR (interpolated) = 1.18 W/kg

Zoom Scan (7x7x7)/Cube 0: Measurement grid: dx=5mm, dy=5mm, dz=5mm

Reference Value = 13.99 V/m; Power Drift = -0.09 dB

Peak SAR (extrapolated) = 1.17 W/kg

SAR(1 g) = 0.641 W/kg; SAR(10 g) = 0.307 W/kg

Maximum value of SAR (measured) = 0.949 W/kg

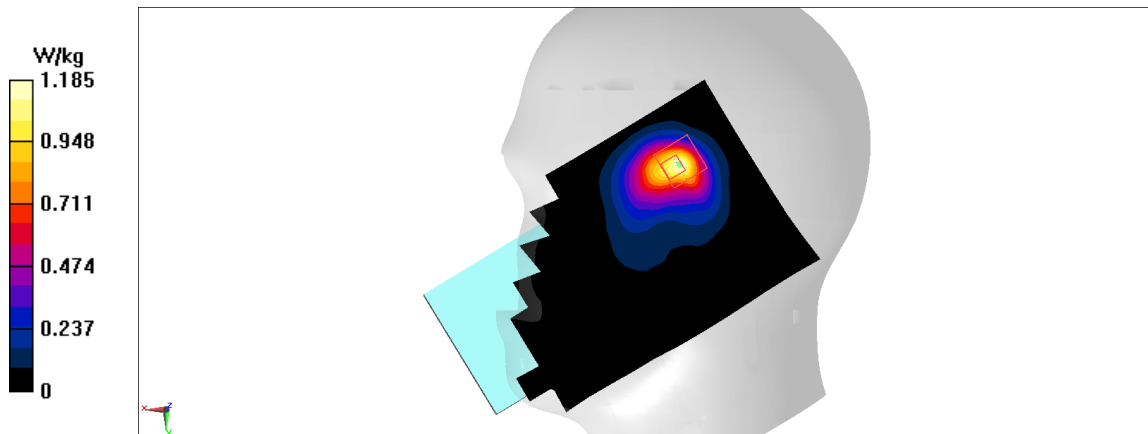

Fig A.13

CDMA1900-BC1_CH600 Front

Date: 1/9/2021

Electronics: DAE4 Sn536

Medium: head 1900 MHz

Medium parameters used: $f = 1880$; $\sigma = 1.391$ mho/m; $\epsilon_r = 40.04$; $\rho = 1000$ kg/m³

Ambient Temperature: 22.5°C, Liquid Temperature: 22.3°C

Communication System: CDMA1900-BC1 1880 Duty Cycle: 1: 1

Probe: EX3DV4 – SN3617 ConvF(8.14,8.14,8.14)

Area Scan (71x121x1): Interpolated grid: dx=1.000 mm, dy=1.000 mm

Maximum value of SAR (interpolated) = 0.722 W/kg

Zoom Scan (7x7x7)/Cube 0: Measurement grid: dx=5mm, dy=5mm, dz=5mm

Reference Value = 12.16 V/m; Power Drift = 0.06 dB

Peak SAR (extrapolated) = 0.848 W/kg

SAR(1 g) = 0.485 W/kg; SAR(10 g) = 0.281 W/kg

Maximum value of SAR (measured) = 0.702 W/kg

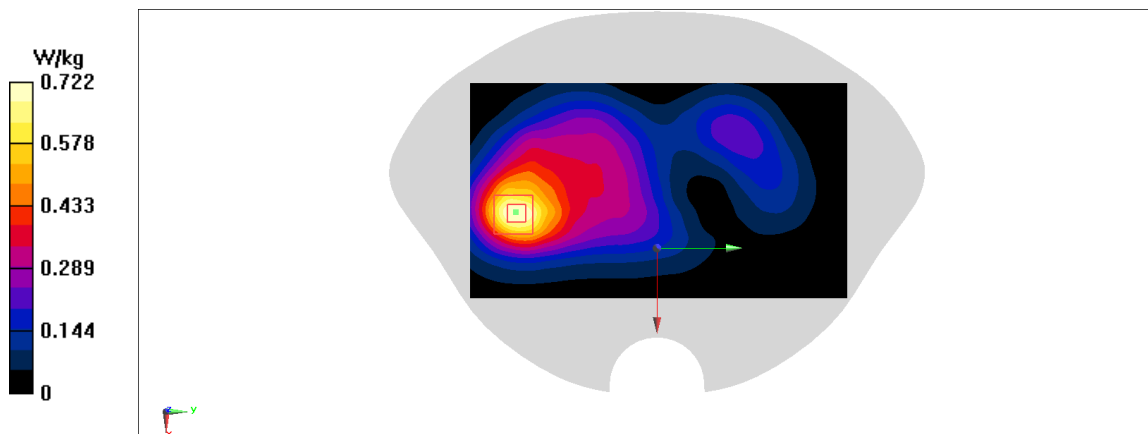
**Fig A.14**

CDMA800-BC10_CH476 Left Cheek

Date: 1/6/2021

Electronics: DAE4 Sn536

Medium: head 835 MHz

Medium parameters used: $f = 817.9$; $\sigma = 0.873$ mho/m; $\epsilon_r = 40.82$; $\rho = 1000$ kg/m³

Ambient Temperature: 22.5°C, Liquid Temperature: 22.3°C

Communication System: CDMA800-BC10 817.9 Duty Cycle: 1: 1

Probe: EX3DV4 – SN3617 ConvF(9.66,9.66,9.66)

Area Scan (71x121x1): Interpolated grid: dx=1.000 mm, dy=1.000 mm

Maximum value of SAR (interpolated) = 0.351 W/kg

Zoom Scan (7x7x7)/Cube 0: Measurement grid: dx=5mm, dy=5mm, dz=5mm

Reference Value = 6.395 V/m; Power Drift = -0.04 dB

Peak SAR (extrapolated) = 0.387 W/kg

SAR(1 g) = 0.291 W/kg; SAR(10 g) = 0.221 W/kg

Maximum value of SAR (measured) = 0.352 W/kg

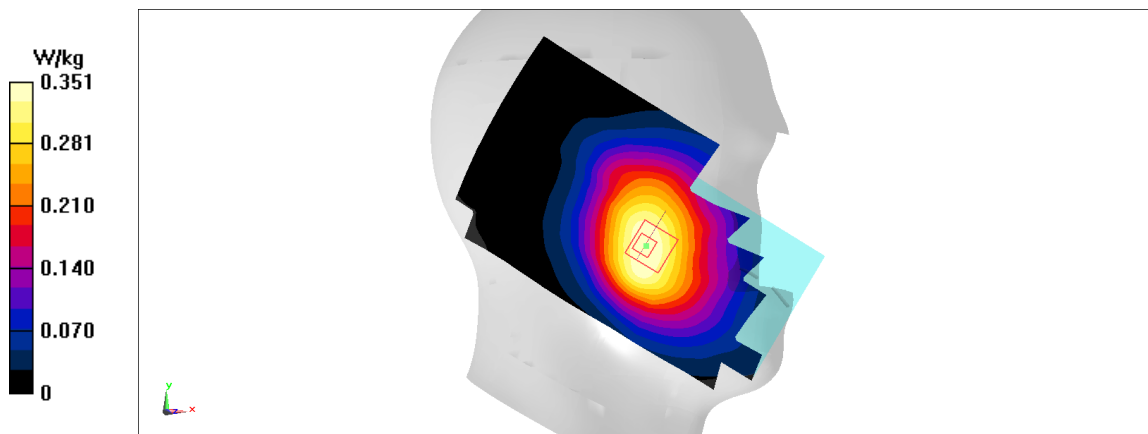

Fig A.15

CDMA800-BC10_CH476 Rear

Date: 1/6/2021

Electronics: DAE4 Sn536

Medium: head 835 MHz

Medium parameters used: $f = 817.9$; $\sigma = 0.873$ mho/m; $\epsilon_r = 40.82$; $\rho = 1000$ kg/m³

Ambient Temperature: 22.5°C, Liquid Temperature: 22.3°C

Communication System: CDMA800-BC10 817.9 Duty Cycle: 1: 1

Probe: EX3DV4 – SN3617 ConvF(9.66,9.66,9.66)

Area Scan (71x121x1): Interpolated grid: dx=1.000 mm, dy=1.000 mm

Maximum value of SAR (interpolated) = 0.645 W/kg

Zoom Scan (7x7x7)/Cube 0: Measurement grid: dx=5mm, dy=5mm, dz=5mm

Reference Value = 26.25 V/m; Power Drift = 0.14 dB

Peak SAR (extrapolated) = 0.72 W/kg

SAR(1 g) = 0.513 W/kg; SAR(10 g) = 0.386 W/kg

Maximum value of SAR (measured) = 0.641 W/kg

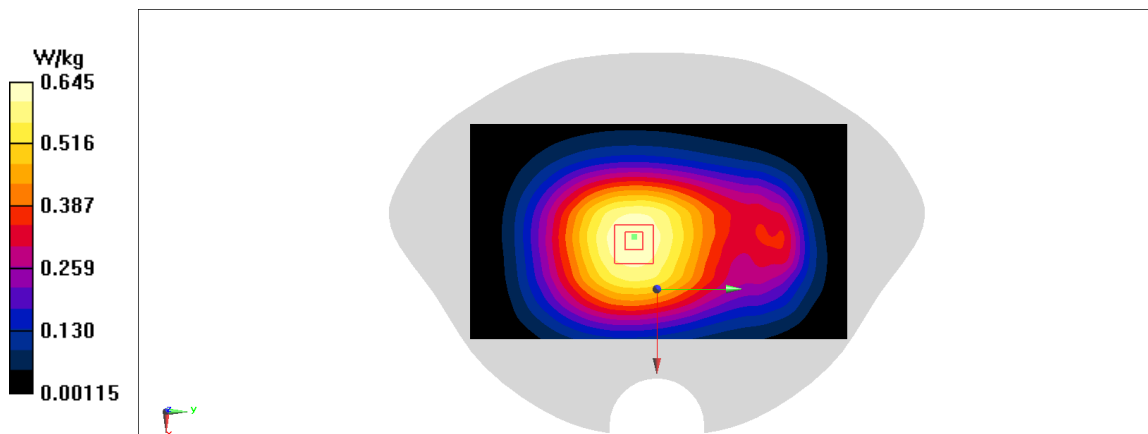
**Fig A.16**

LTE2500-FDD7_CH20850 Right Tilt

Date: 1/11/2020

Electronics: DAE4 Sn536

Medium: head 2600 MHz

Medium parameters used: $f = 2510$ MHz; $\sigma = 1.9$ mho/m; $\epsilon_r = 39.07$; $\rho = 1000$ kg/m³

Ambient Temperature: 22.5°C, Liquid Temperature: 22.3°C

Communication System: LTE2500-FDD7 2510 MHz Duty Cycle: 1: 1

Probe: EX3DV4 – SN3617 ConvF(7.52,7.52,7.52)

Area Scan (71x121x1): Interpolated grid: dx=1.000 mm, dy=1.000 mm

Maximum value of SAR (interpolated) = 0.119 W/kg

Zoom Scan (7x7x7)/Cube 0: Measurement grid: dx=5mm, dy=5mm, dz=5mm

Reference Value = 4.731 V/m; Power Drift = 0 dB

Peak SAR (extrapolated) = 0.148 W/kg

SAR(1 g) = 0.063 W/kg; SAR(10 g) = 0.025 W/kg

Maximum value of SAR (measured) = 0.113 W/kg

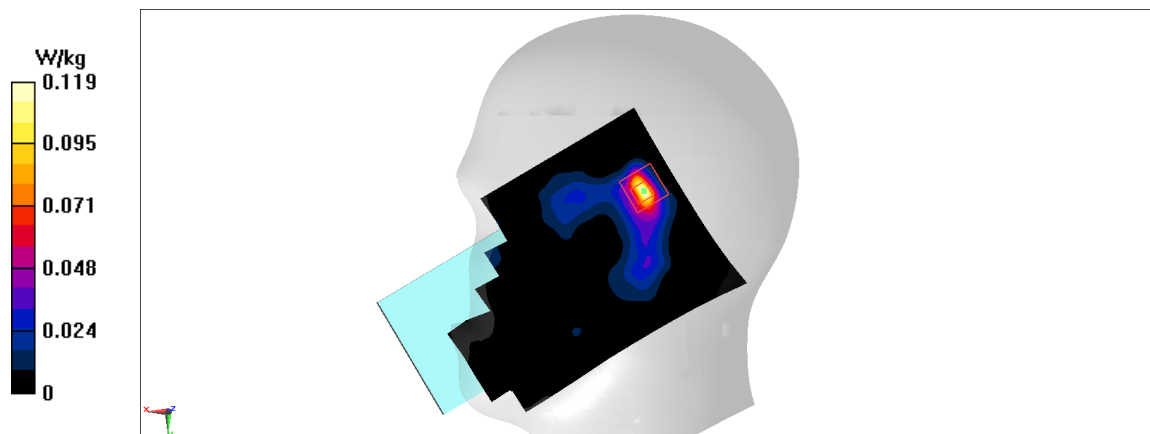

Fig A.17

LTE2500-FDD7_CH20850 Bottom

Date: 1/11/2020

Electronics: DAE4 Sn536

Medium: head 2600 MHz

Medium parameters used: $f = 2510$ MHz; $\sigma = 1.9$ mho/m; $\epsilon_r = 39.07$; $\rho = 1000$ kg/m³

Ambient Temperature: 22.5°C, Liquid Temperature: 22.3°C

Communication System: LTE2500-FDD7 2510 MHz Duty Cycle: 1: 1

Probe: EX3DV4 – SN3617 ConvF(7.65,7.65,7.65)

Area Scan (71x121x1): Interpolated grid: dx=1.000 mm, dy=1.000 mm

Maximum value of SAR (interpolated) = 0.663 W/kg

Zoom Scan (7x7x7)/Cube 0: Measurement grid: dx=5mm, dy=5mm, dz=5mm

Reference Value = 4.183 V/m; Power Drift = -0.03 dB

Peak SAR (extrapolated) = 0.88 W/kg

SAR(1 g) = 0.424 W/kg; SAR(10 g) = 0.207 W/kg

Maximum value of SAR (measured) = 0.679 W/kg

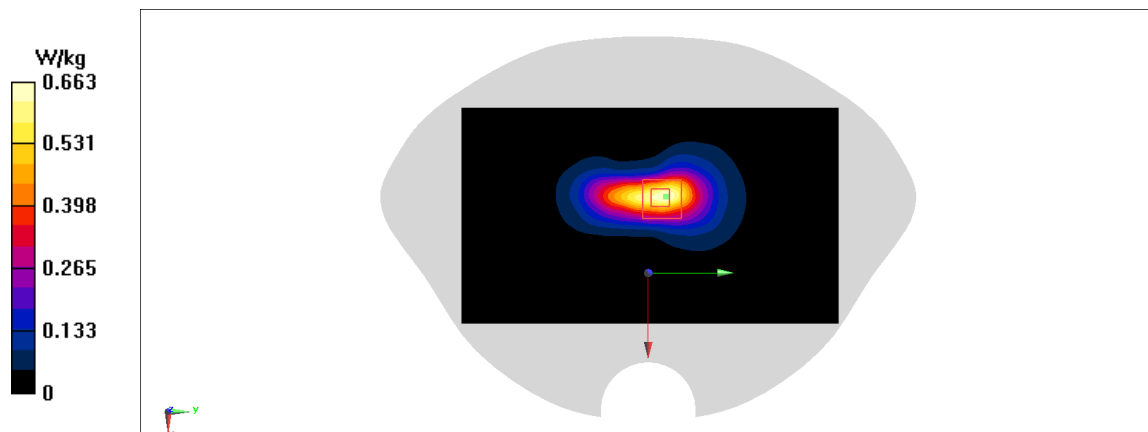

Fig A.18

LTE700-FDD12_CH23130 Left Cheek

Date: 1/4/2020

Electronics: DAE4 Sn536

Medium: head 750 MHz

Medium parameters used: $f = 711$ MHz; $\sigma = 0.844$ mho/m; $\epsilon_r = 42.27$; $\rho = 1000$ kg/m³

Ambient Temperature: 22.5°C, Liquid Temperature: 22.3°C

Communication System: LTE700-FDD12 711 MHz Duty Cycle: 1: 1

Probe: EX3DV4 – SN3617 ConvF(10.07,10.07,10.07)

Area Scan (71x121x1): Interpolated grid: dx=1.000 mm, dy=1.000 mm

Maximum value of SAR (interpolated) = 0.229 W/kg

Zoom Scan (7x7x7)/Cube 0: Measurement grid: dx=5mm, dy=5mm, dz=5mm

Reference Value = 5.713 V/m; Power Drift = 0.09 dB

Peak SAR (extrapolated) = 0.256 W/kg

SAR(1 g) = 0.194 W/kg; SAR(10 g) = 0.153 W/kg

Maximum value of SAR (measured) = 0.231 W/kg

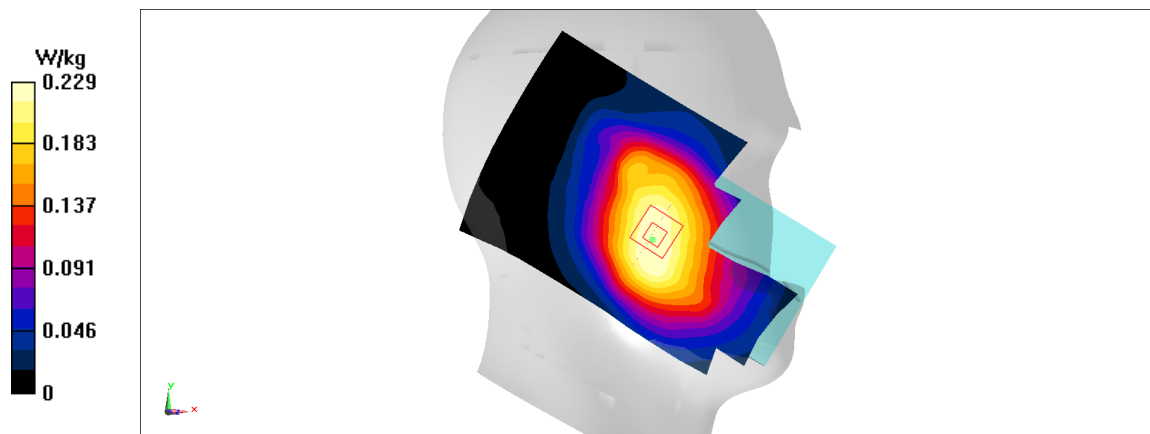
**Fig A.19**

LTE700-FDD12_CH23130 Rear

Date: 1/4/2020

Electronics: DAE4 Sn536

Medium: head 750 MHz

Medium parameters used: $f = 711$ MHz; $\sigma = 0.844$ mho/m; $\epsilon_r = 42.27$; $\rho = 1000$ kg/m³

Ambient Temperature: 22.5°C, Liquid Temperature: 22.3°C

Communication System: LTE700-FDD12 711 MHz Duty Cycle: 1: 1

Probe: EX3DV4 – SN3617 ConvF(10.07,10.07,10.07)

Area Scan (71x121x1): Interpolated grid: dx=1.000 mm, dy=1.000 mm

Maximum value of SAR (interpolated) = 0.543 W/kg

Zoom Scan (7x7x7)/Cube 0: Measurement grid: dx=5mm, dy=5mm, dz=5mm

Reference Value = 23.07 V/m; Power Drift = 0.06 dB

Peak SAR (extrapolated) = 0.601 W/kg

SAR(1 g) = 0.436 W/kg; SAR(10 g) = 0.334 W/kg

Maximum value of SAR (measured) = 0.536 W/kg

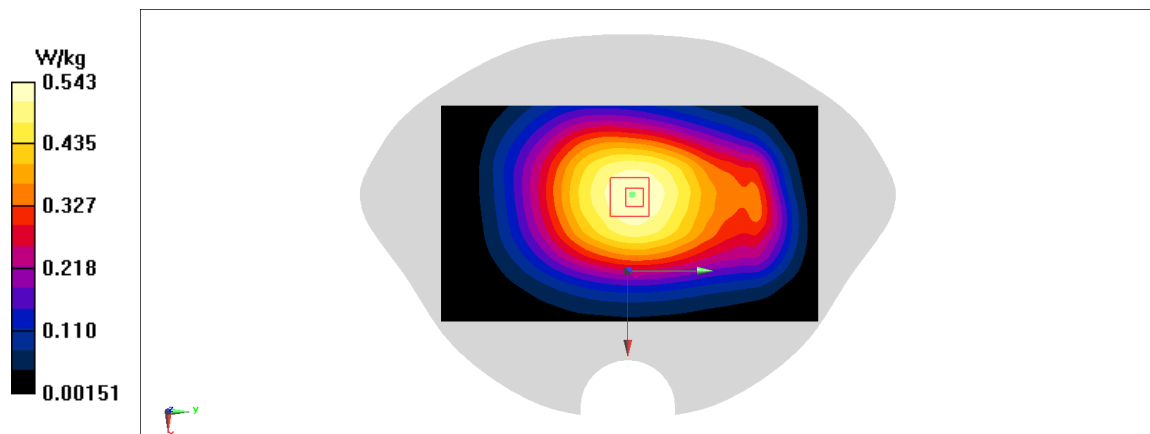
**Fig A.20**

LTE750-FDD13_CH23230 Right Cheek

Date: 1/4/2020

Electronics: DAE4 Sn536

Medium: head 750 MHz

Medium parameters used: $f = 782 \text{ MHz}$; $\sigma = 0.911 \text{ mho/m}$; $\epsilon_r = 42.18$; $\rho = 1000 \text{ kg/m}^3$

Ambient Temperature: 22.5°C , Liquid Temperature: 22.3°C

Communication System: LTE750-FDD13 782 MHz Duty Cycle: 1: 1

Probe: EX3DV4 – SN3617 ConvF(10.07,10.07,10.07)

Area Scan (71x121x1): Interpolated grid: $dx=1.000 \text{ mm}$, $dy=1.000 \text{ mm}$

Maximum value of SAR (interpolated) = 0.315 W/kg

Zoom Scan (7x7x7)/Cube 0: Measurement grid: $dx=5\text{mm}$, $dy=5\text{mm}$, $dz=5\text{mm}$

Reference Value = 5.373 V/m ; Power Drift = -0.08 dB

Peak SAR (extrapolated) = 0.343 W/kg

SAR(1 g) = 0.265 W/kg ; SAR(10 g) = 0.206 W/kg

Maximum value of SAR (measured) = 0.314 W/kg

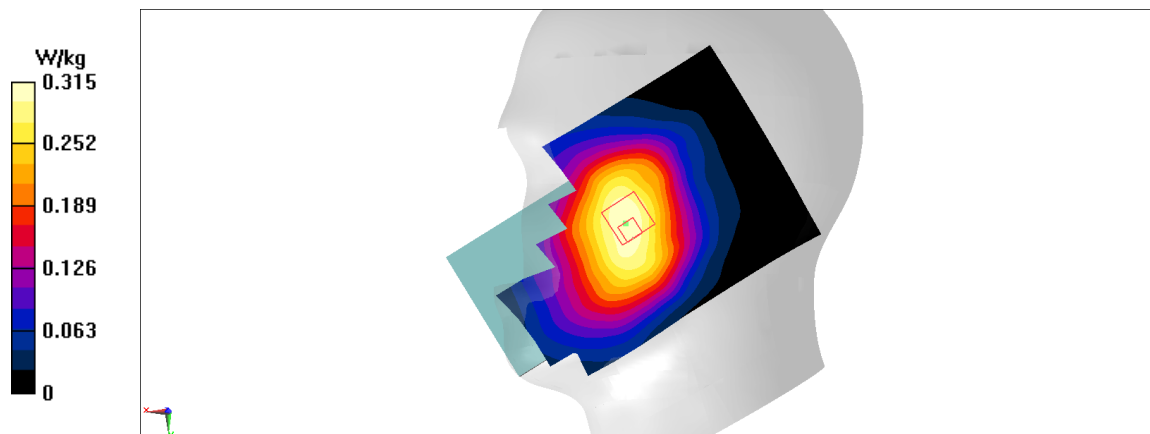

Fig A.21

LTE750-FDD13_CH23230 Rear

Date: 1/4/2020

Electronics: DAE4 Sn536

Medium: head 750 MHz

Medium parameters used: $f = 782 \text{ MHz}$; $\sigma = 0.911 \text{ mho/m}$; $\epsilon_r = 42.18$; $\rho = 1000 \text{ kg/m}^3$

Ambient Temperature: 22.5°C , Liquid Temperature: 22.3°C

Communication System: LTE750-FDD13 782 MHz Duty Cycle: 1: 1

Probe: EX3DV4 – SN3617 ConvF(10.07,10.07,10.07)

Area Scan (71x121x1): Interpolated grid: $dx=1.000 \text{ mm}$, $dy=1.000 \text{ mm}$

Maximum value of SAR (interpolated) = 0.56 W/kg

Zoom Scan (7x7x7)/Cube 0: Measurement grid: $dx=5\text{mm}$, $dy=5\text{mm}$, $dz=5\text{mm}$

Reference Value = 23.88 V/m ; Power Drift = 0.1 dB

Peak SAR (extrapolated) = 0.623 W/kg

SAR(1 g) = 0.451 W/kg ; SAR(10 g) = 0.343 W/kg

Maximum value of SAR (measured) = 0.557 W/kg

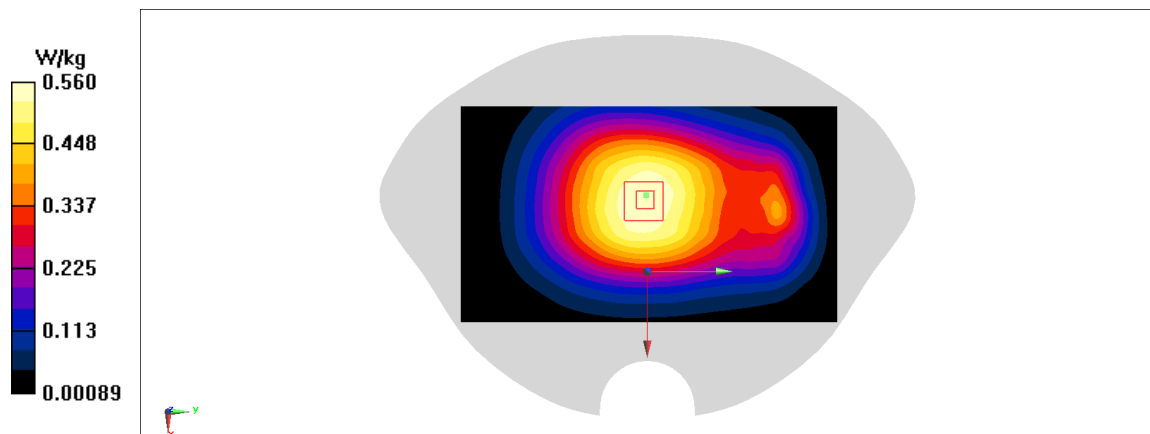

Fig A.22

LTE1900-FDD25_CH26140 Right Cheek

Date: 1/9/2021

Electronics: DAE4 Sn536

Medium: head 1900 MHz

Medium parameters used: $f = 1860$ MHz; $\sigma = 1.372$ mho/m; $\epsilon_r = 40.07$; $\rho = 1000$ kg/m³

Ambient Temperature: 22.5°C, Liquid Temperature: 22.3°C

Communication System: LTE1900-FDD25 1860 MHz Duty Cycle: 1: 1

Probe: EX3DV4 – SN3617 ConvF(8.14,8.14,8.14)

Area Scan (71x121x1): Interpolated grid: dx=1.000 mm, dy=1.000 mm

Maximum value of SAR (interpolated) = 1.25 W/kg

Zoom Scan (7x7x7)/Cube 0: Measurement grid: dx=5mm, dy=5mm, dz=5mm

Reference Value = 16.88 V/m; Power Drift = -0.12 dB

Peak SAR (extrapolated) = 1.56 W/kg

SAR(1 g) = 0.824 W/kg; SAR(10 g) = 0.432 W/kg

Maximum value of SAR (measured) = 1.23 W/kg

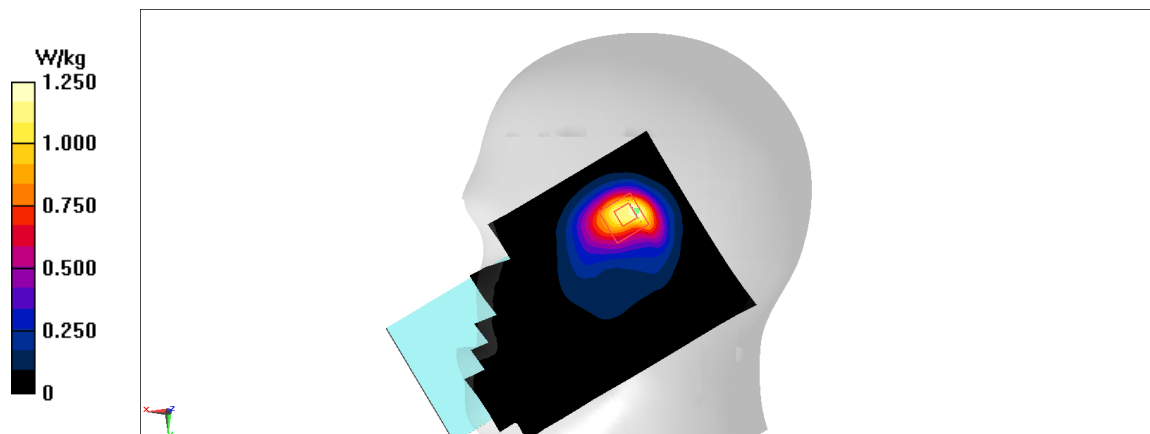

Fig A.23

LTE1900-FDD25_CH26590 Rear

Date: 1/9/2021

Electronics: DAE4 Sn536

Medium: head 1900 MHz

Medium parameters used: $f = 1905$ MHz; $\sigma = 1.415$ mho/m; $\epsilon_r = 40.01$; $\rho = 1000$ kg/m³

Ambient Temperature: 22.5°C, Liquid Temperature: 22.3°C

Communication System: LTE1900-FDD25 1905 MHz Duty Cycle: 1: 1

Probe: EX3DV4 – SN3617 ConvF(8.14,8.14,8.14)

Area Scan (71x121x1): Interpolated grid: dx=1.000 mm, dy=1.000 mm

Maximum value of SAR (interpolated) = 0.53 W/kg

Zoom Scan (7x7x7)/Cube 0: Measurement grid: dx=5mm, dy=5mm, dz=5mm

Reference Value = 11.53 V/m; Power Drift = 0.08 dB

Peak SAR (extrapolated) = 0.585 W/kg

SAR(1 g) = 0.320 W/kg; SAR(10 g) = 0.183 W/kg

Maximum value of SAR (measured) = 0.481 W/kg

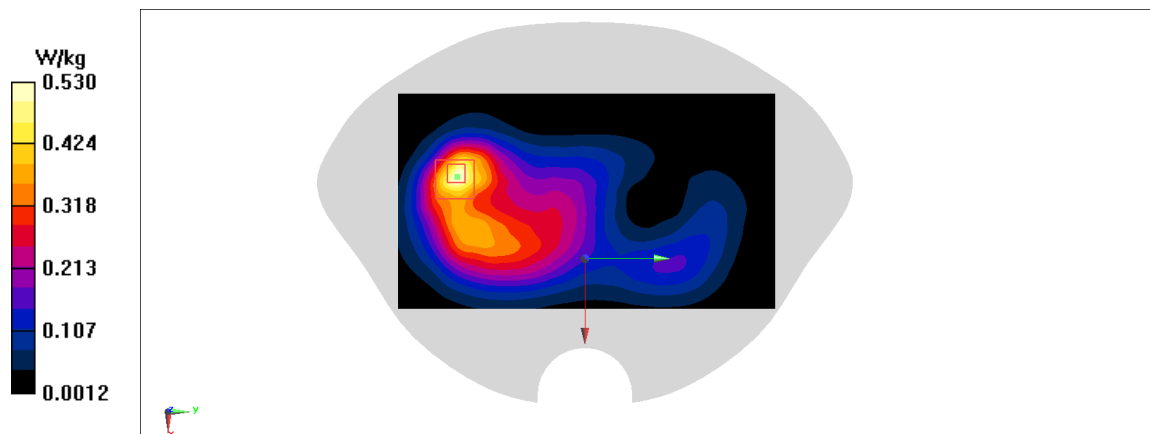

Fig A.24

LTE850-FDD26_CH26965 Left Cheek

Date: 1/6/2021

Electronics: DAE4 Sn536

Medium: head 835 MHz

Medium parameters used: $f = 841.5$ MHz; $\sigma = 0.896$ mho/m; $\epsilon_r = 40.79$; $\rho = 1000$ kg/m³

Ambient Temperature: 22.5°C, Liquid Temperature: 22.3°C

Communication System: LTE850-FDD26 841.5 MHz Duty Cycle: 1: 1

Probe: EX3DV4 – SN3617 ConvF(9.66,9.66,9.66)

Area Scan (71x121x1): Interpolated grid: dx=1.000 mm, dy=1.000 mm

Maximum value of SAR (interpolated) = 0.385 W/kg

Zoom Scan (7x7x7)/Cube 0: Measurement grid: dx=5mm, dy=5mm, dz=5mm

Reference Value = 6.303 V/m; Power Drift = -0.08 dB

Peak SAR (extrapolated) = 0.436 W/kg

SAR(1 g) = 0.322 W/kg; SAR(10 g) = 0.247 W/kg

Maximum value of SAR (measured) = 0.392 W/kg

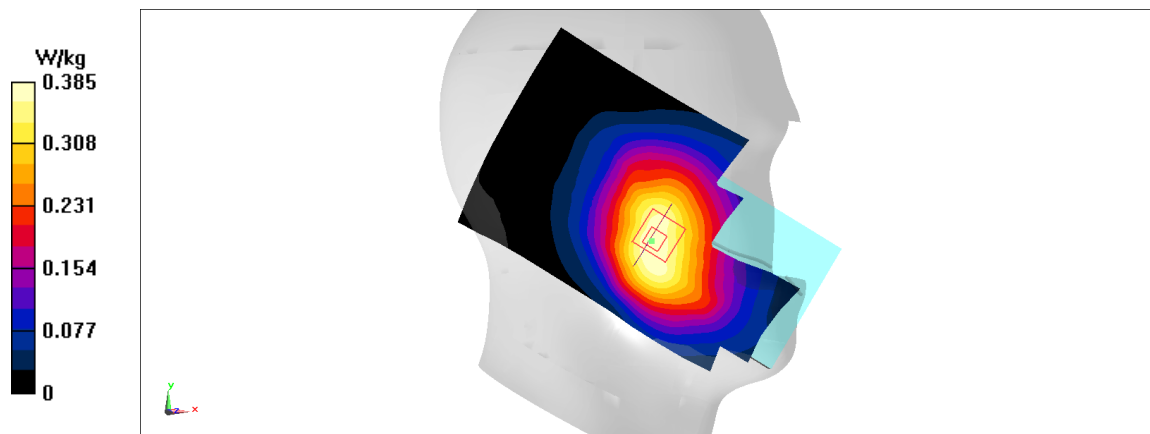

Fig A.25

LTE850-FDD26_CH26965 Rear

Date: 1/6/2021

Electronics: DAE4 Sn536

Medium: head 835 MHz

Medium parameters used: $f = 841.5$ MHz; $\sigma = 0.896$ mho/m; $\epsilon_r = 40.79$; $\rho = 1000$ kg/m³

Ambient Temperature: 22.5°C, Liquid Temperature: 22.3°C

Communication System: LTE850-FDD26 841.5 MHz Duty Cycle: 1: 1

Probe: EX3DV4 – SN3617 ConvF(9.66,9.66,9.66)

Area Scan (71x121x1): Interpolated grid: dx=1.000 mm, dy=1.000 mm

Maximum value of SAR (interpolated) = 0.694 W/kg

Zoom Scan (7x7x7)/Cube 0: Measurement grid: dx=5mm, dy=5mm, dz=5mm

Reference Value = 25.9 V/m; Power Drift = 0.02 dB

Peak SAR (extrapolated) = 0.776 W/kg

SAR(1 g) = 0.557 W/kg; SAR(10 g) = 0.421 W/kg

Maximum value of SAR (measured) = 0.693 W/kg

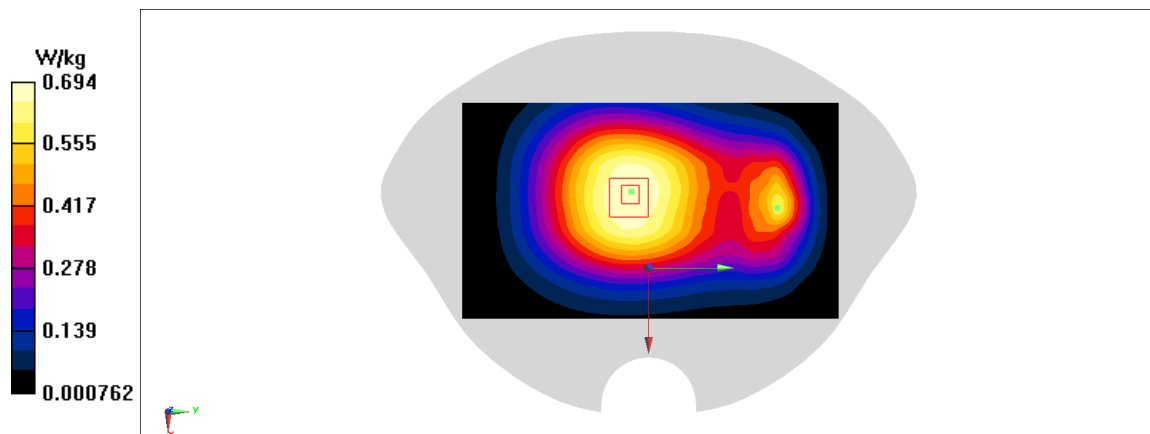

Fig A.26

LTE2600-TDD41_CH39750 Right Tilt

Date: 1/12/2021

Electronics: DAE4 Sn536

Medium: head 2600 MHz

Medium parameters used: $f = 2506$; $\sigma = 1.57$ mho/m; $\epsilon_r = 38.8$; $\rho = 1000$ kg/m³

Ambient Temperature: 22.5°C, Liquid Temperature: 22.3°C

Communication System: LTE2600-TDD41 2506 Duty Cycle: 1: 2.309

Probe: EX3DV4 – SN3617 ConvF(7.45,7.45,7.45)

Area Scan (71x121x1): Interpolated grid: dx=1.000 mm, dy=1.000 mm

Maximum value of SAR (interpolated) = 0.214 W/kg

Zoom Scan (7x7x7)/Cube 0: Measurement grid: dx=5mm, dy=5mm, dz=5mm

Reference Value = 2.683 V/m; Power Drift = 0.06 dB

Peak SAR (extrapolated) = 0.542 W/kg

SAR(1 g) = 0.208 W/kg; SAR(10 g) = 0.077 W/kg

Maximum value of SAR (measured) = 0.324 W/kg

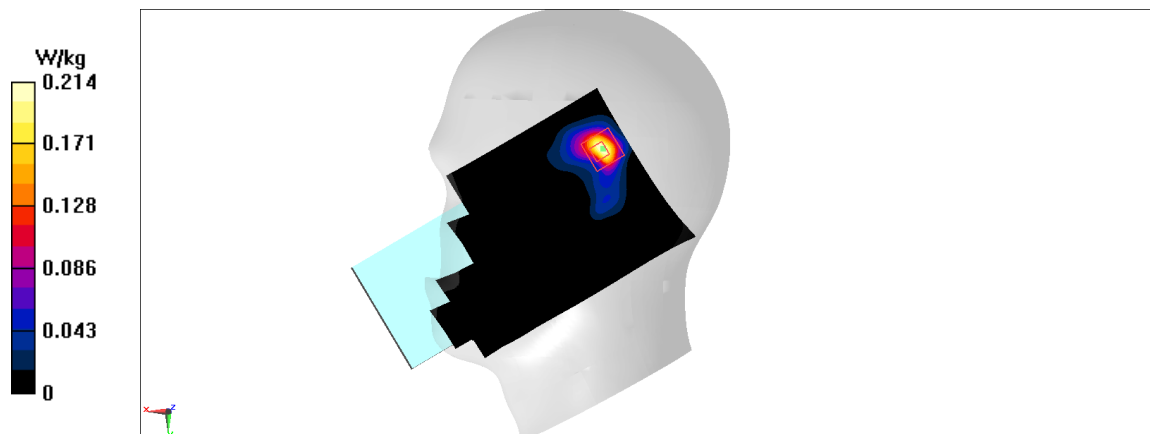

Fig A.27

LTE2600-TDD41_CH41490 Top

Date: 1/12/2021

Electronics: DAE4 Sn536

Medium: head 2600 MHz

Medium parameters used: $f = 2680$; $\sigma = 2.05$ mho/m; $\epsilon_r = 38.17$; $\rho = 1000$ kg/m³

Ambient Temperature: 22.5°C, Liquid Temperature: 22.3°C

Communication System: LTE2600-TDD41 2680 Duty Cycle: 1: 2.309

Probe: EX3DV4 – SN3617 ConvF(7.45,7.45,7.45)

Area Scan (71x121x1): Interpolated grid: dx=1.000 mm, dy=1.000 mm

Maximum value of SAR (interpolated) = 0.914 W/kg

Zoom Scan (7x7x7)/Cube 0: Measurement grid: dx=5mm, dy=5mm, dz=5mm

Reference Value = 5.741 V/m; Power Drift = 0.06 dB

Peak SAR (extrapolated) = 1.12 W/kg

SAR(1 g) = 0.709 W/kg; SAR(10 g) = 0.347 W/kg

Maximum value of SAR (measured) = 0.904 W/kg

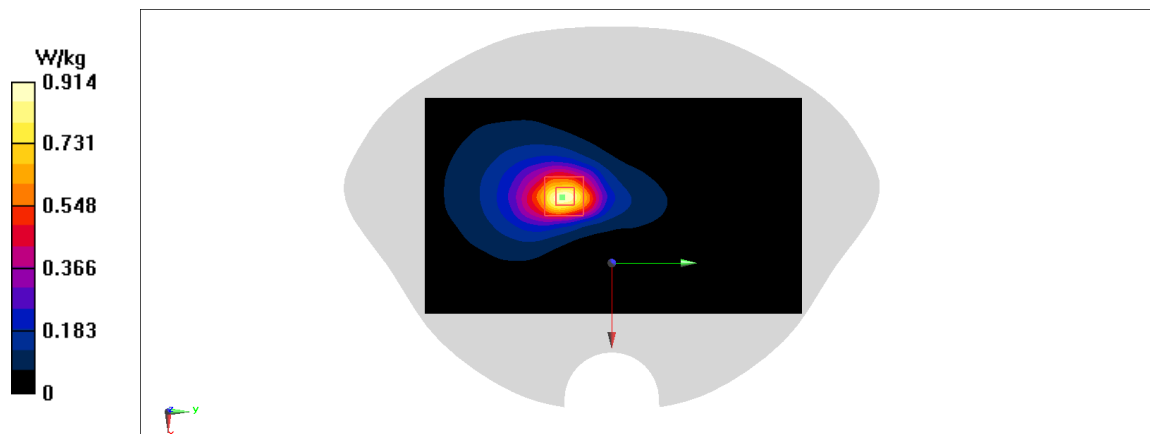

Fig A.28

LTE2600-TDD41_CH39750 Right Tilt

Date: 1/12/2021

Electronics: DAE4 Sn536

Medium: head 2600 MHz

Medium parameters used: $f = 2506$; $\sigma = 1.57$ mho/m; $\epsilon_r = 38.8$; $\rho = 1000$ kg/m³

Ambient Temperature: 22.5°C, Liquid Temperature: 22.3°C

Communication System: LTE2600-TDD41 2506 Duty Cycle: 1: 1.58

Probe: EX3DV4 – SN3617 ConvF(7.45,7.45,7.45)

Area Scan (71x121x1): Interpolated grid: dx=1.000 mm, dy=1.000 mm

Maximum value of SAR (interpolated) = 0.488 W/kg

Zoom Scan (7x7x7)/Cube 0: Measurement grid: dx=5mm, dy=5mm, dz=5mm

Reference Value = 2.506 V/m; Power Drift = 0.11 dB

Peak SAR (extrapolated) = 0.867 W/kg

SAR(1 g) = 0.368 W/kg; SAR(10 g) = 0.14 W/kg

Maximum value of SAR (measured) = 0.671 W/kg

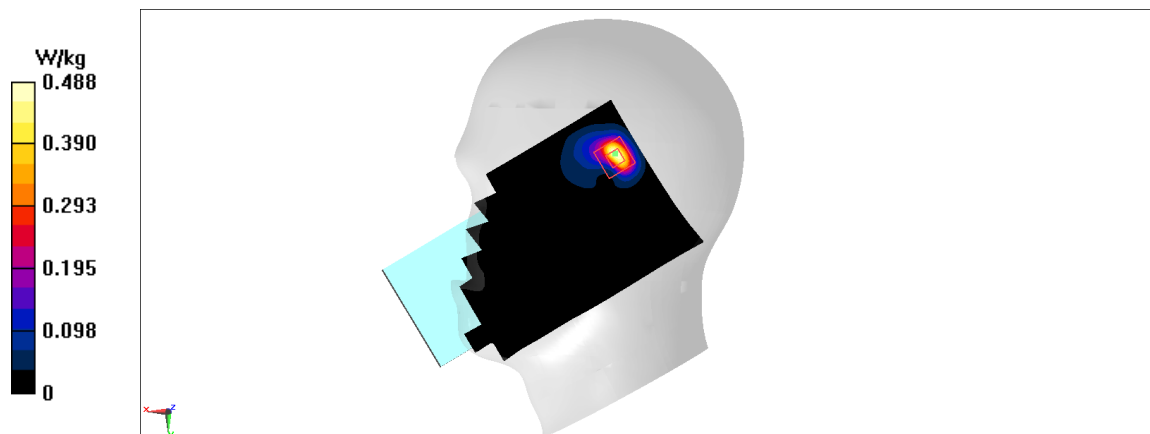

Fig A.29

LTE2600-TDD41_CH41490 Rear

Date: 1/12/2021

Electronics: DAE4 Sn536

Medium: head 2600 MHz

Medium parameters used: $f = 2680$; $\sigma = 2.05$ mho/m; $\epsilon_r = 38.17$; $\rho = 1000$ kg/m³

Ambient Temperature: 22.5°C, Liquid Temperature: 22.3°C

Communication System: LTE2600-TDD41 2680 Duty Cycle: 1: 1.58

Probe: EX3DV4 – SN3617 ConvF(7.45,7.45,7.45)

Area Scan (71x121x1): Interpolated grid: dx=1.000 mm, dy=1.000 mm

Maximum value of SAR (interpolated) = 0.609 W/kg

Zoom Scan (7x7x7)/Cube 0: Measurement grid: dx=5mm, dy=5mm, dz=5mm

Reference Value = 1.375 V/m; Power Drift = -0.03 dB

Peak SAR (extrapolated) = 0.979 W/kg

SAR(1 g) = 0.461 W/kg; SAR(10 g) = 0.205 W/kg

Maximum value of SAR (measured) = 0.749 W/kg

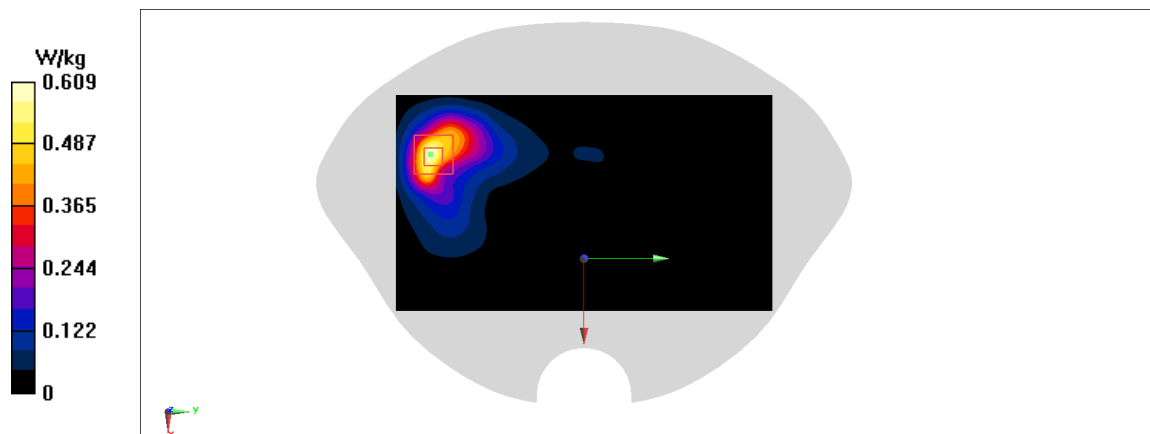
**Fig A.30**

LTE1700-FDD66_CH132572 Right Cheek

Date: 1/7/2020

Electronics: DAE4 Sn536

Medium: head 1750 MHz

Medium parameters used: $f = 1770$ MHz; $\sigma = 1.377$ mho/m; $\epsilon_r = 40.79$; $\rho = 1000$ kg/m³

Ambient Temperature: 22.5°C, Liquid Temperature: 22.3°C

Communication System: LTE1700-FDD66 1770 MHz Duty Cycle: 1: 1

Probe: EX3DV4 – SN3617 ConvF(8.41,8.41,8.41)

Area Scan (71x121x1): Interpolated grid: dx=1.000 mm, dy=1.000 mm

Maximum value of SAR (interpolated) = 1.21 W/kg

Zoom Scan (7x7x7)/Cube 0: Measurement grid: dx=5mm, dy=5mm, dz=5mm

Reference Value = 15.53 V/m; Power Drift = 0.01 dB

Peak SAR (extrapolated) = 1.42 W/kg

SAR(1 g) = 0.762 W/kg; SAR(10 g) = 0.406 W/kg

Maximum value of SAR (measured) = 1.12 W/kg

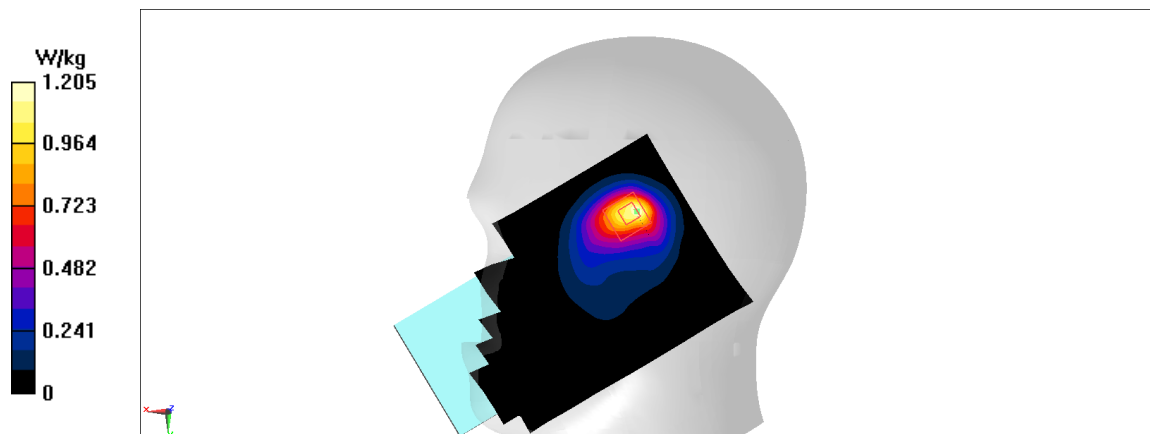

Fig A.31

LTE1700-FDD66_CH132072 Rear

Date: 1/7/2020

Electronics: DAE4 Sn536

Medium: head 1750 MHz

Medium parameters used: $f = 1720$ MHz; $\sigma = 1.342$ mho/m; $\epsilon_r = 40.92$; $\rho = 1000$ kg/m³

Ambient Temperature: 22.5°C, Liquid Temperature: 22.3°C

Communication System: LTE1700-FDD66 1720 MHz Duty Cycle: 1: 1

Probe: EX3DV4 – SN3617 ConvF(8.41,8.41,8.41)

Area Scan (71x121x1): Interpolated grid: dx=1.000 mm, dy=1.000 mm

Maximum value of SAR (interpolated) = 0.649 W/kg

Zoom Scan (7x7x7)/Cube 0: Measurement grid: dx=5mm, dy=5mm, dz=5mm

Reference Value = 6.717 V/m; Power Drift = 0.11 dB

Peak SAR (extrapolated) = 0.898 W/kg

SAR(1 g) = 0.452 W/kg; SAR(10 g) = 0.235 W/kg

Maximum value of SAR (measured) = 0.689 W/kg

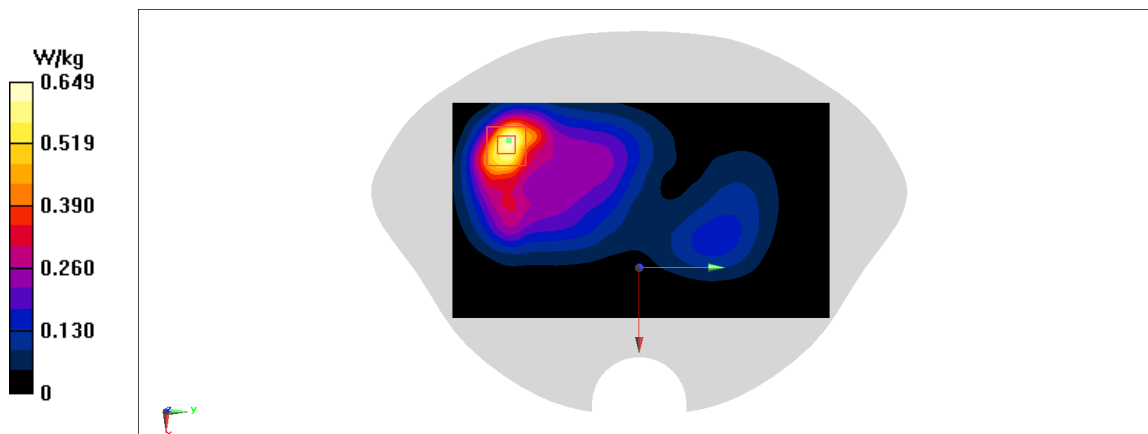

Fig A.32

LTE700-FDD71_CH133322 Left Cheek

Date: 1/4/2020

Electronics: DAE4 Sn536

Medium: head 750 MHz

Medium parameters used: $f = 782 \text{ MHz}$; $\sigma = 0.911 \text{ mho/m}$; $\epsilon_r = 42.18$; $\rho = 1000 \text{ kg/m}^3$

Ambient Temperature: 22.5°C , Liquid Temperature: 22.3°C

Communication System: LTE700-FDD71 782 MHz Duty Cycle: 1: 1

Probe: EX3DV4 – SN3617 ConvF(10.07,10.07,10.07)

Area Scan (71x121x1): Interpolated grid: $dx=1.000 \text{ mm}$, $dy=1.000 \text{ mm}$

Maximum value of SAR (interpolated) = 0.264 W/kg

Zoom Scan (7x7x7)/Cube 0: Measurement grid: $dx=5\text{mm}$, $dy=5\text{mm}$, $dz=5\text{mm}$

Reference Value = 5.947 V/m ; Power Drift = 0.08 dB

Peak SAR (extrapolated) = 0.303 W/kg

SAR(1 g) = 0.22 W/kg ; SAR(10 g) = 0.177 W/kg

Maximum value of SAR (measured) = 0.263 W/kg

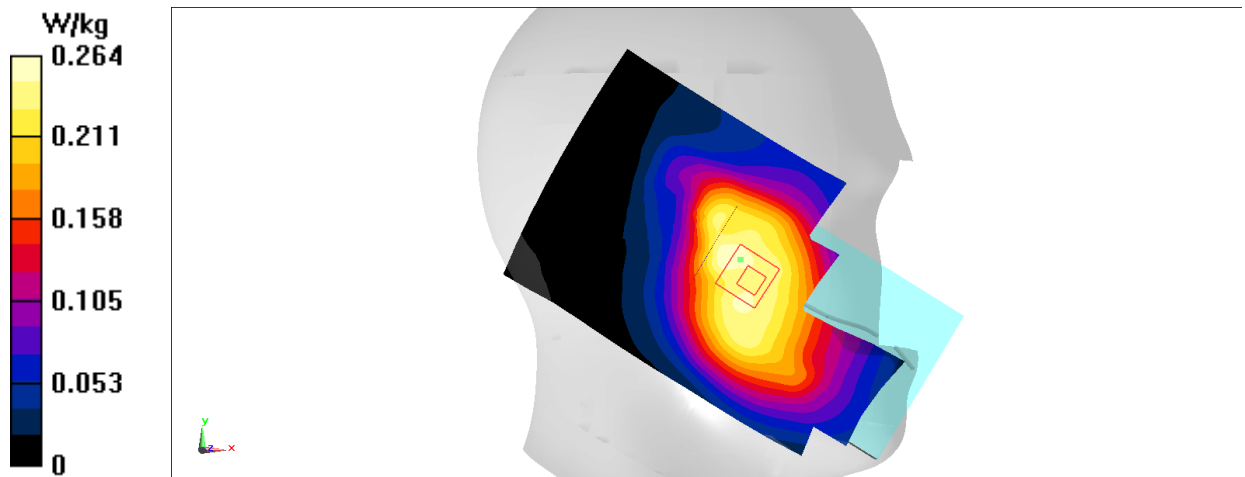

Fig A.33

LTE700-FDD71_CH133322 Right

Date: 1/4/2020

Electronics: DAE4 Sn536

Medium: head 750 MHz

Medium parameters used: $f = 782 \text{ MHz}$; $\sigma = 0.911 \text{ mho/m}$; $\epsilon_r = 42.18$; $\rho = 1000 \text{ kg/m}^3$ Ambient Temperature: 22.5°C , Liquid Temperature: 22.3°C

Communication System: LTE700-FDD71 782 MHz Duty Cycle: 1: 1

Probe: EX3DV4 – SN3617 ConvF(10.07,10.07,10.07)

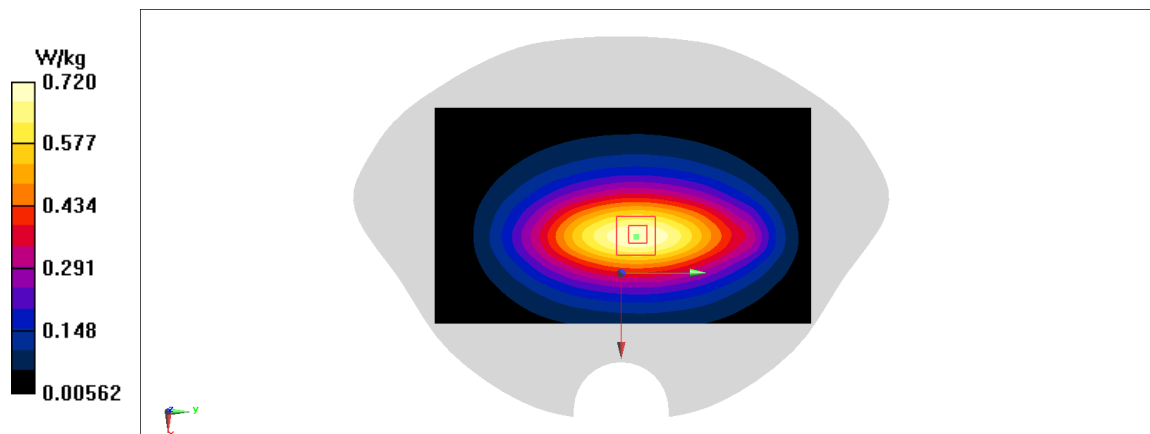
Area Scan (71x121x1): Interpolated grid: $dx=1.000 \text{ mm}$, $dy=1.000 \text{ mm}$ Maximum value of SAR (interpolated) = 0.72 W/kg **Zoom Scan (7x7x7)/Cube 0:** Measurement grid: $dx=5\text{mm}$, $dy=5\text{mm}$, $dz=5\text{mm}$ Reference Value = 29.16 V/m ; Power Drift = 0.07 dB Peak SAR (extrapolated) = 0.838 W/kg **SAR(1 g) = 0.538 W/kg ; SAR(10 g) = 0.374 W/kg** Maximum value of SAR (measured) = 0.723 W/kg **Fig A.34**

WLAN2450_CH6 Left Cheek

Date: 1/10/2020

Electronics: DAE4 Sn536

Medium: head 2450 MHz

Medium parameters used: $f = 2437$; $\sigma = 1.785$ mho/m; $\epsilon_r = 39.03$; $\rho = 1000$ kg/m³

Ambient Temperature: 22.5°C, Liquid Temperature: 22.3°C

Communication System: WLAN2450 2437 Duty Cycle: 1: 1

Probe: EX3DV4 – SN3617 ConvF(7.65,7.65,7.65)

Area Scan (71x121x1): Interpolated grid: dx=1.000 mm, dy=1.000 mm

Maximum value of SAR (interpolated) = 0.91 W/kg

Zoom Scan (7x7x7)/Cube 0: Measurement grid: dx=5mm, dy=5mm, dz=5mm

Reference Value = 10.75 V/m; Power Drift = 0.16 dB

Peak SAR (extrapolated) = 0.971 W/kg

SAR(1 g) = 0.5 W/kg; SAR(10 g) = 0.276 W/kg

Maximum value of SAR (measured) = 0.776 W/kg

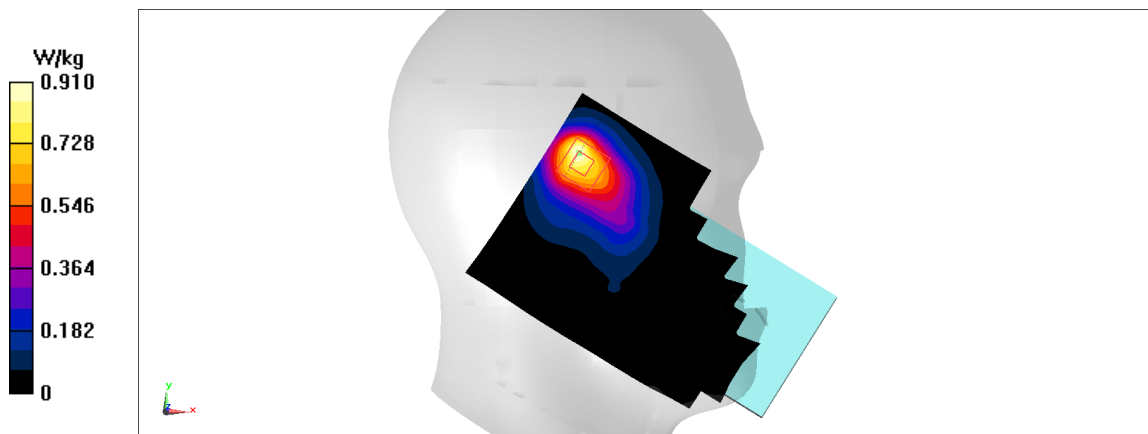

Fig A.35

WLAN2450_CH6 Right

Date: 1/10/2020

Electronics: DAE4 Sn536

Medium: head 2450 MHz

Medium parameters used: $f = 2437$; $\sigma = 1.785$ mho/m; $\epsilon_r = 39.03$; $\rho = 1000$ kg/m³

Ambient Temperature: 22.5°C, Liquid Temperature: 22.3°C

Communication System: WLAN2450 2437 Duty Cycle: 1: 1

Probe: EX3DV4 – SN3617 ConvF(7.65,7.65,7.65)

Area Scan (71x121x1): Interpolated grid: dx=1.000 mm, dy=1.000 mm

Maximum value of SAR (interpolated) = 0.418 W/kg

Zoom Scan (7x7x7)/Cube 0: Measurement grid: dx=5mm, dy=5mm, dz=5mm

Reference Value = 9.64 V/m; Power Drift = 0.04 dB

Peak SAR (extrapolated) = 0.605 W/kg

SAR(1 g) = 0.29 W/kg; SAR(10 g) = 0.148 W/kg

Maximum value of SAR (measured) = 0.473 W/kg

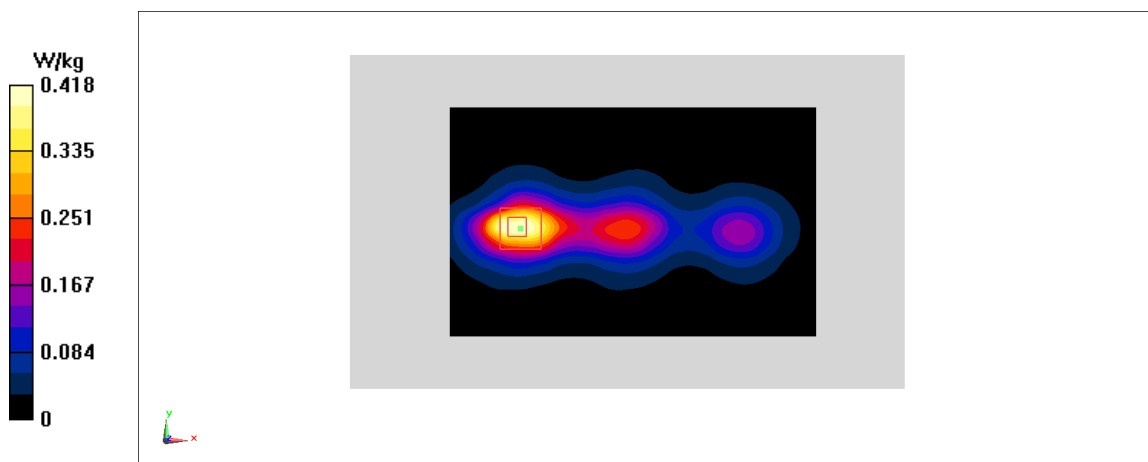

Fig A.36

WLAN5G_CH122 Left Tilt

Date: 1/14/2020

Electronics: DAE4 Sn536

Medium: head 5600 MHz

Medium parameters used: $f = 5610$; $\sigma = 5.029$ mho/m; $\epsilon_r = 3573$; $\rho = 1000$ kg/m³

Ambient Temperature: 22.5°C, Liquid Temperature: 22.3°C

Communication System: WLAN5G 5610 Duty Cycle: 1: 1

Probe: EX3DV4 – SN3617 ConvF(4.99,4.99,4.99)

Area Scan (71x121x1): Interpolated grid: dx=1.000 mm, dy=1.000 mm

Maximum value of SAR (interpolated) = 1.48 W/kg

Zoom Scan (7x7x7)/Cube 0: Measurement grid: dx=5mm, dy=5mm, dz=5mm

Reference Value = 2.669 V/m; Power Drift = -0.07 dB

Peak SAR (extrapolated) = 2.89 W/kg

SAR(1 g) = 0.581 W/kg; SAR(10 g) = 0.171 W/kg

Maximum value of SAR (measured) = 1.73 W/kg

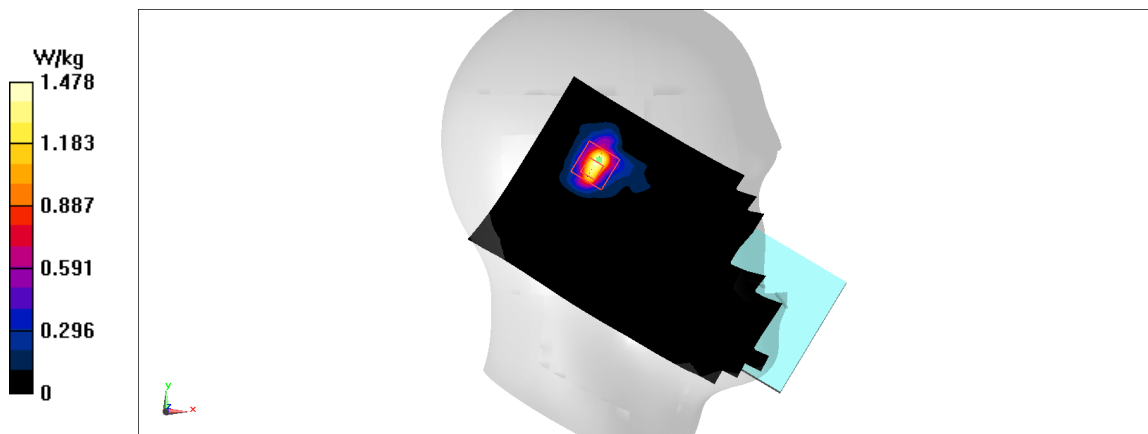

Fig A.37

WLAN5G_CH122 Rear

Date: 1/14/2020

Electronics: DAE4 Sn536

Medium: head 5600 MHz

Medium parameters used: $f = 5610$; $\sigma = 5.029$ mho/m; $\epsilon_r = 3573$; $\rho = 1000$ kg/m³

Ambient Temperature: 22.5°C, Liquid Temperature: 22.3°C

Communication System: WLAN5G 5610 Duty Cycle: 1: 1

Probe: EX3DV4 – SN3617 ConvF(4.99,4.99,4.99)

Area Scan (71x121x1): Interpolated grid: dx=1.000 mm, dy=1.000 mm

Maximum value of SAR (interpolated) = 1.2 W/kg

Zoom Scan (7x7x7)/Cube 0: Measurement grid: dx=5mm, dy=5mm, dz=5mm

Reference Value = 0.526 V/m; Power Drift = -0.06 dB

Peak SAR (extrapolated) = 2.68 W/kg

SAR(1 g) = 0.541 W/kg; SAR(10 g) = 0.189 W/kg

Maximum value of SAR (measured) = 1.31 W/kg

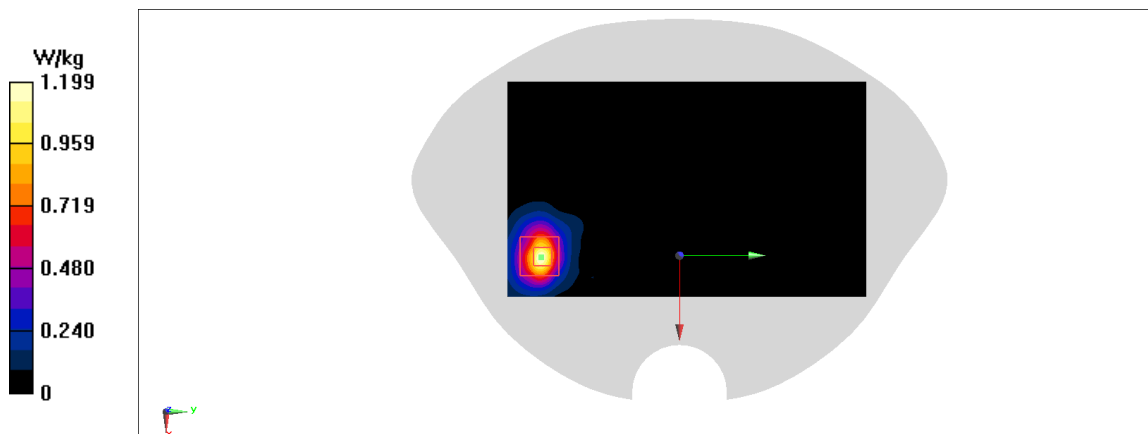

Fig A.38

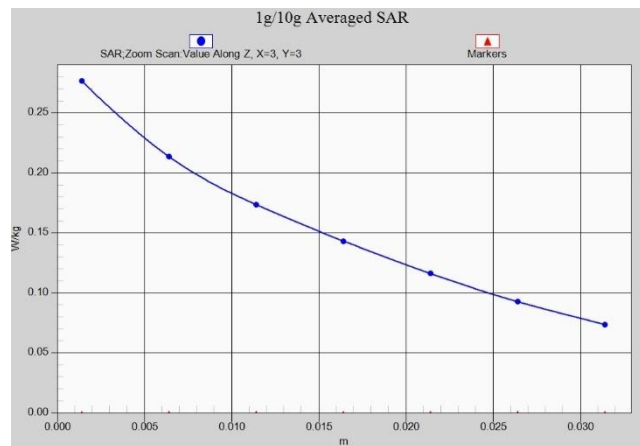

Fig. 1-1 Z-Scan at power reference point (GSM850)

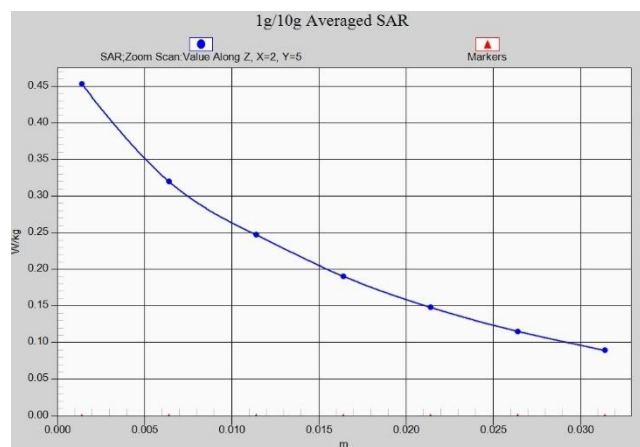

Fig. 1-2 Z-Scan at power reference point (GSM850)

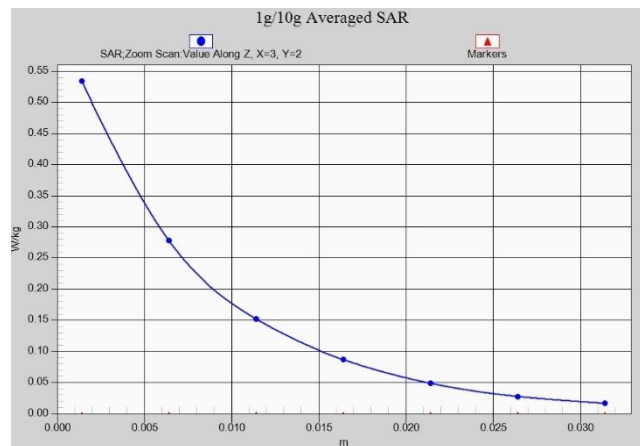

Fig. 1-3 Z-Scan at power reference point (PCS1900)

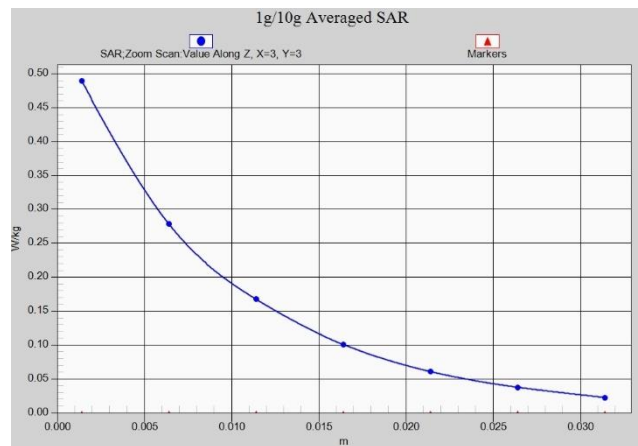

Fig. 1-4 Z-Scan at power reference point (PCS1900)

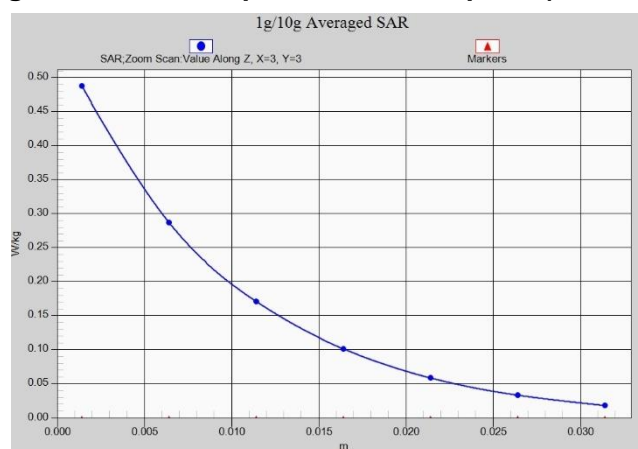

Fig. 1-5 Z-Scan at power reference point (WCDMA1900)

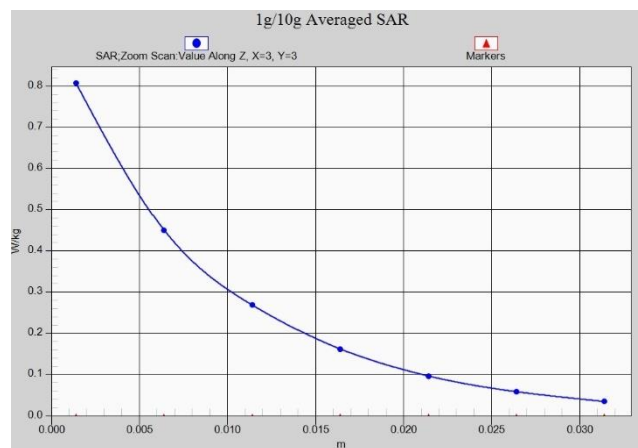

Fig. 1-6 Z-Scan at power reference point (WCDMA1900)

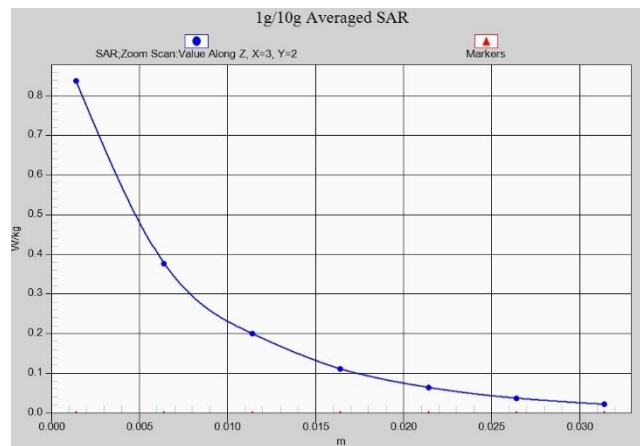

Fig. 1-7 Z-Scan at power reference point (WCDMA1700)

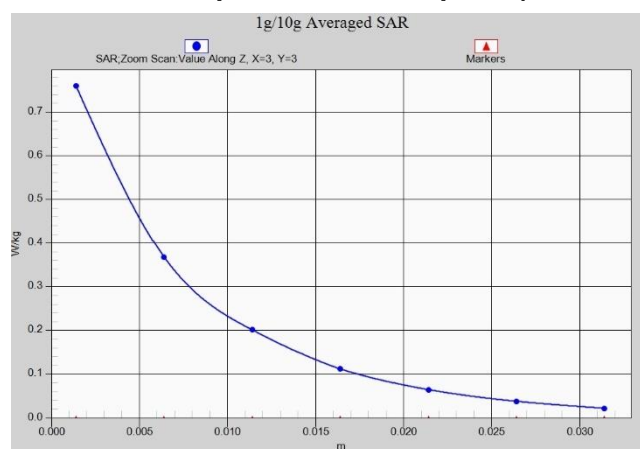

Fig. 1-8 Z-Scan at power reference point (WCDMA1700)

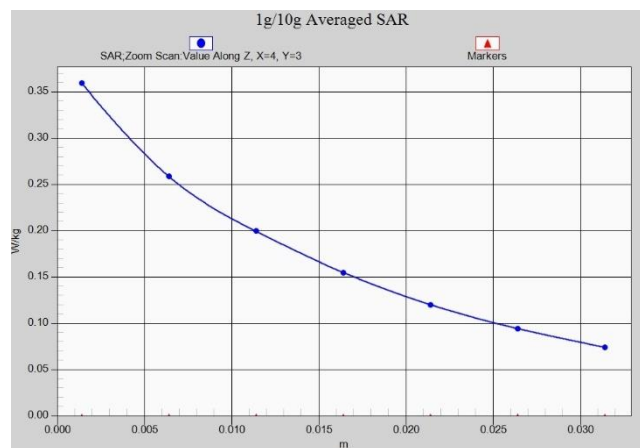

Fig. 1-9 Z-Scan at power reference point (WCDMA850)

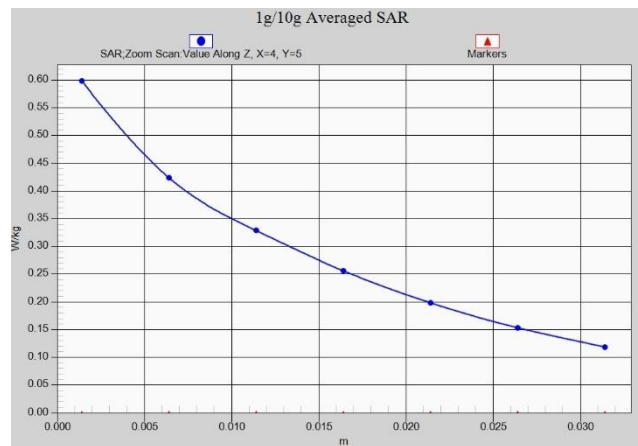

Fig. 1-10 Z-Scan at power reference point (WCDMA850)



Fig. 1-11 Z-Scan at power reference point (CDMA BC0)

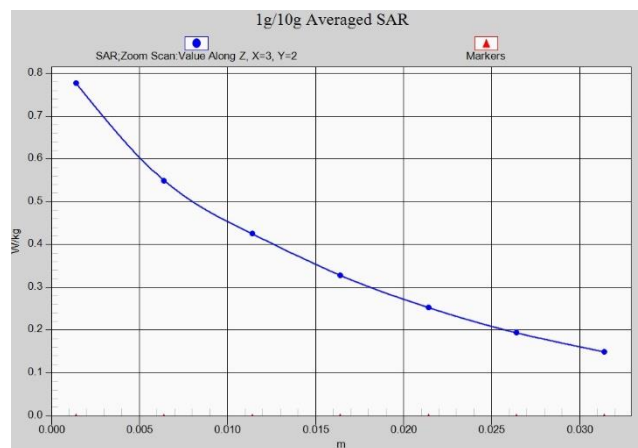

Fig. 1-12 Z-Scan at power reference point (CDMA BC0)

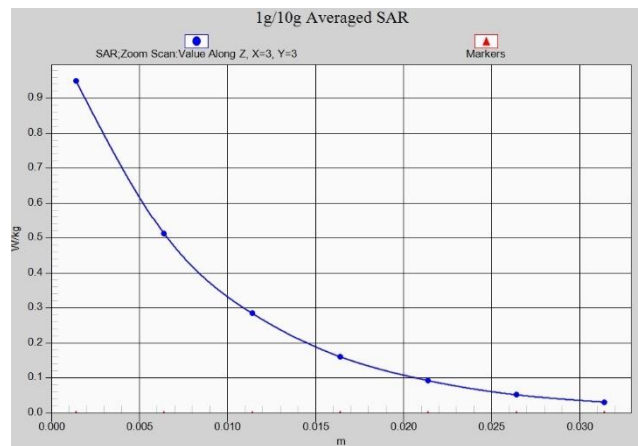

Fig. 1-13 Z-Scan at power reference point (CDMA BC1)

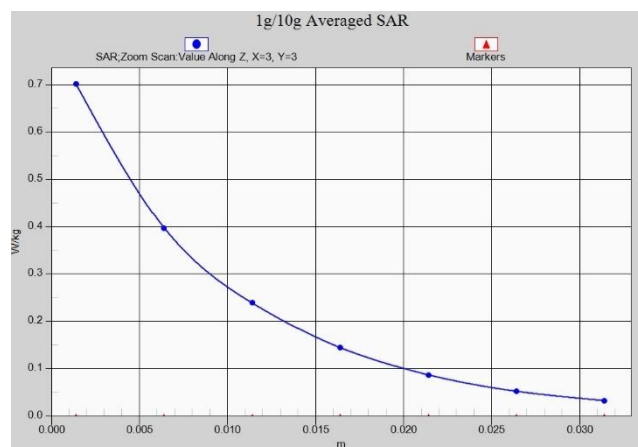

Fig. 1-14 Z-Scan at power reference point (CDMA BC1)

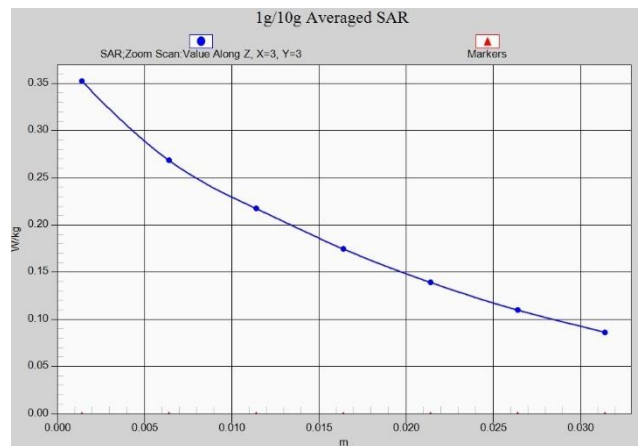

Fig. 1-15 Z-Scan at power reference point (CDMA BC10)

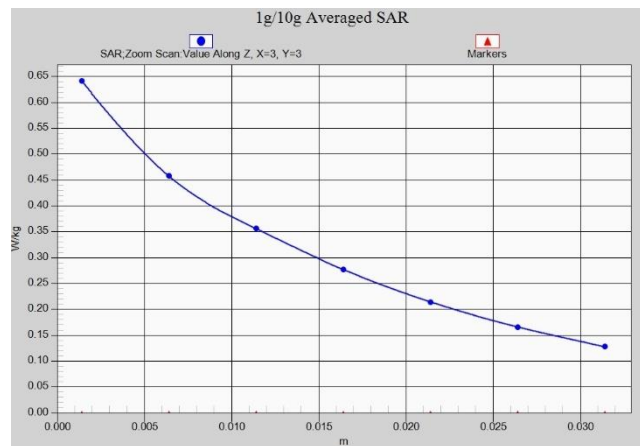

Fig. 1-16 Z-Scan at power reference point (CDMA BC10)

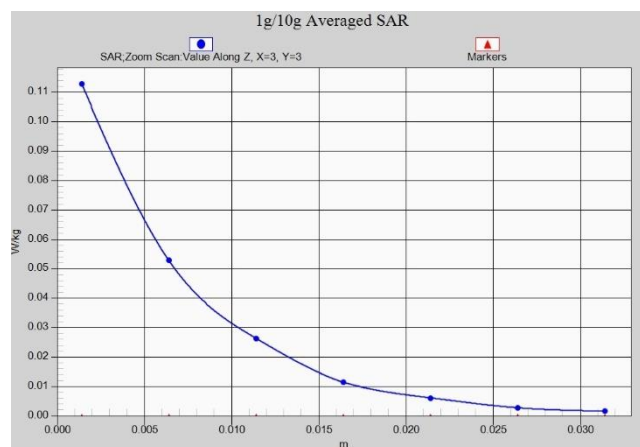

Fig. 1-17 Z-Scan at power reference point (LTE Band7)

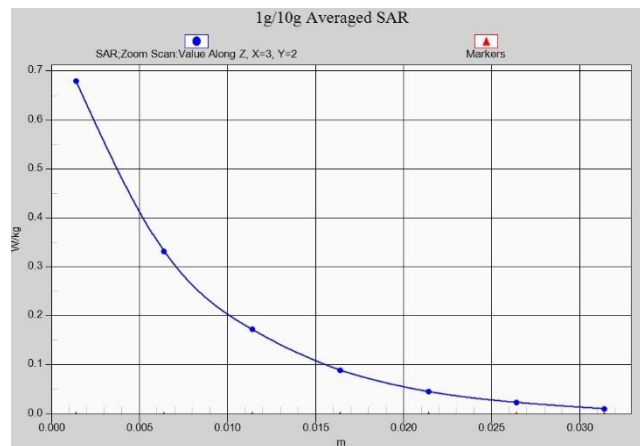

Fig. 1-18 Z-Scan at power reference point (LTE Band7)

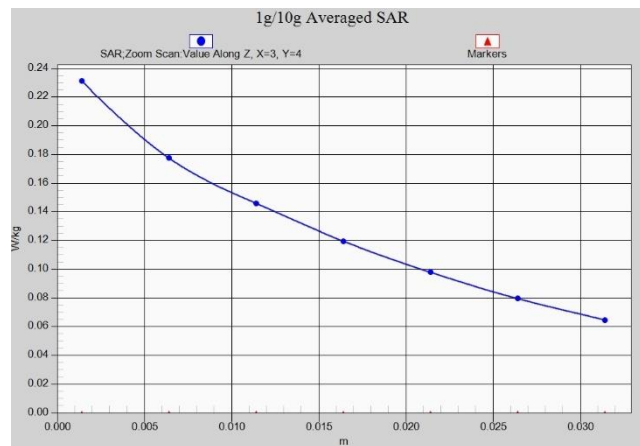

Fig. 1-19 Z-Scan at power reference point (LTE Band12)

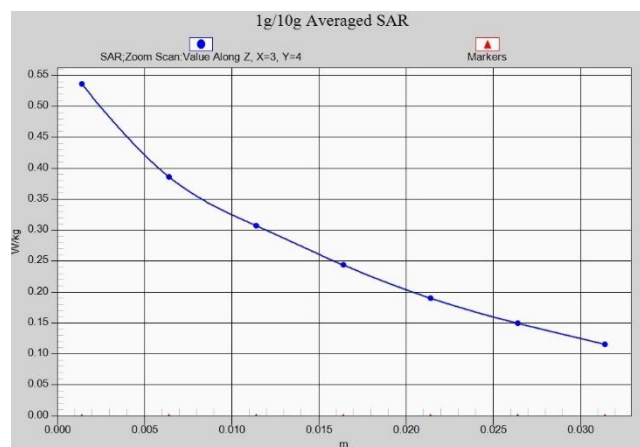

Fig. 1-20 Z-Scan at power reference point (LTE Band12)

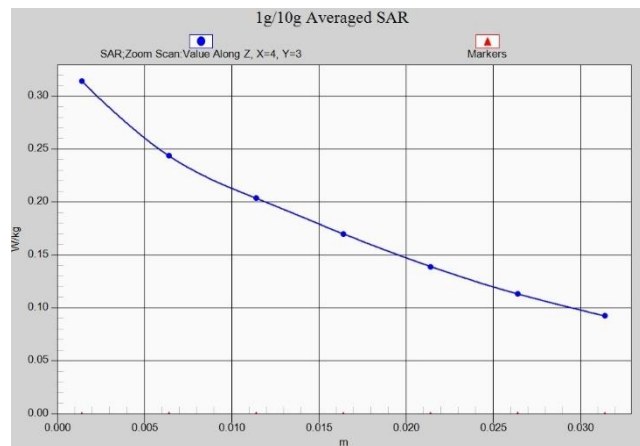

Fig. 1-21 Z-Scan at power reference point (LTE Band13)

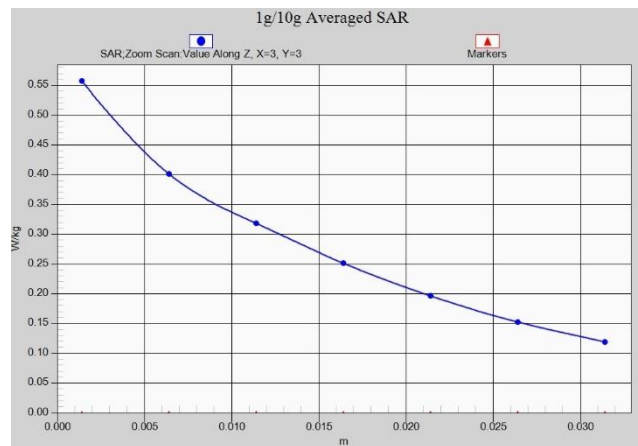

Fig. 1-22 Z-Scan at power reference point (LTE Band13)

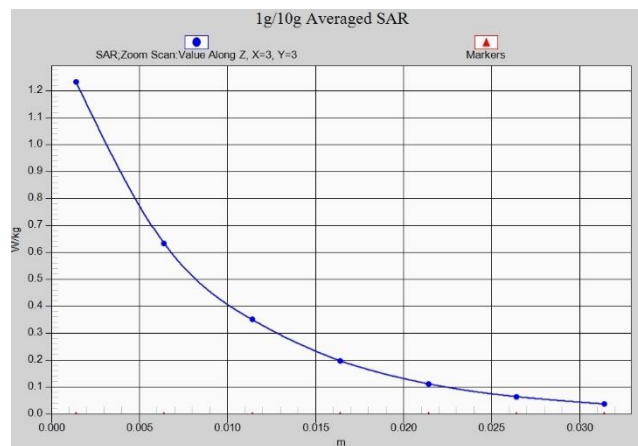

Fig. 1-23 Z-Scan at power reference point (LTE Band25)

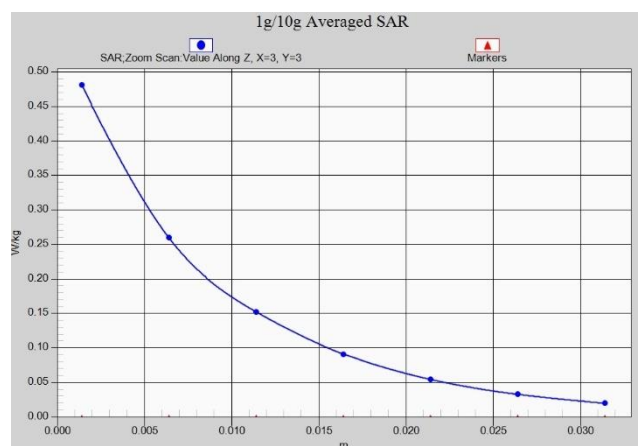

Fig. 1-24 Z-Scan at power reference point (LTE Band25)

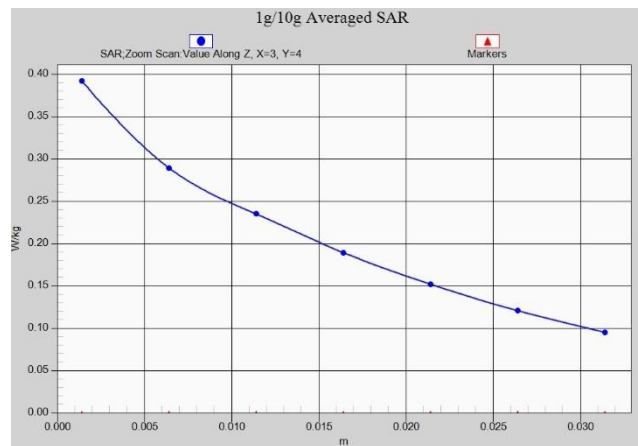

Fig. 1-25 Z-Scan at power reference point (LTE Band26)

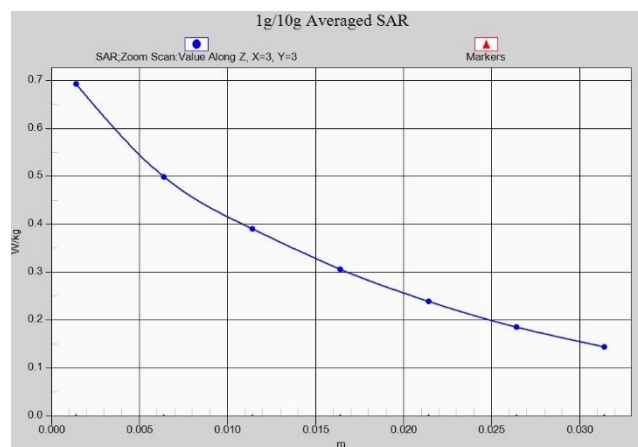

Fig. 1-26 Z-Scan at power reference point (LTE Band26)

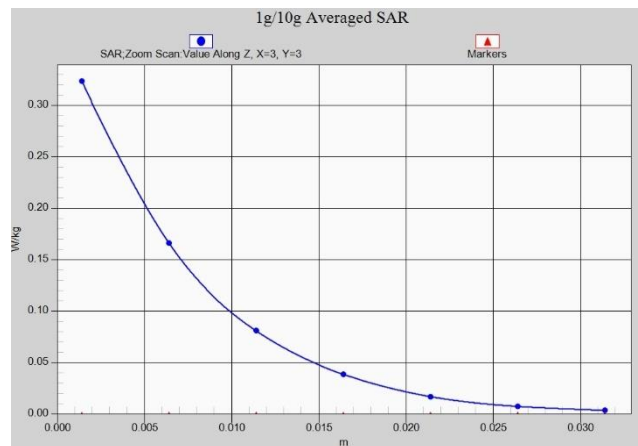

Fig. 1-27 Z-Scan at power reference point (LTE Band41 PC2)

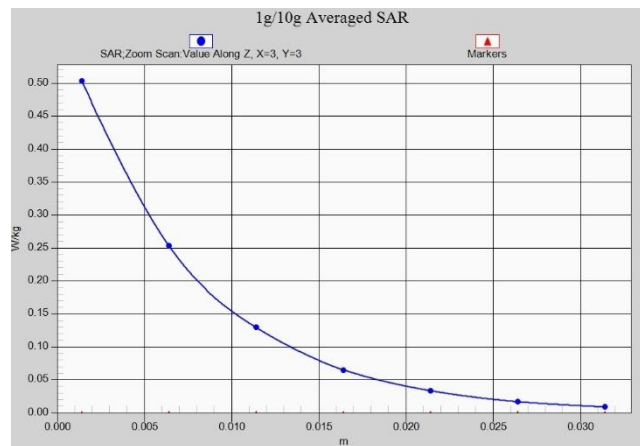

Fig. 1-28 Z-Scan at power reference point (LTE Band41 PC2)

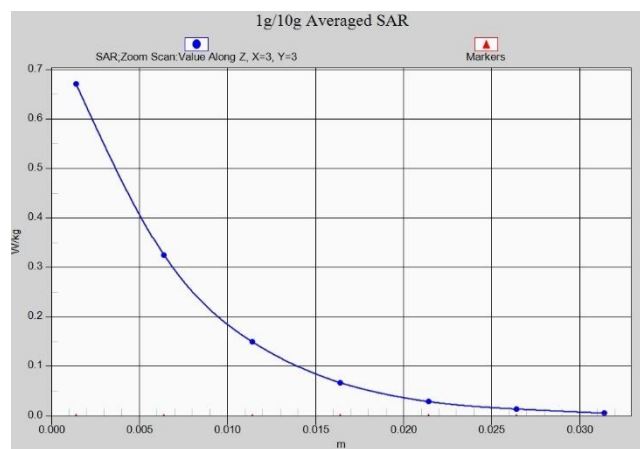

Fig. 1-29 Z-Scan at power reference point (LTE Band41 PC3)

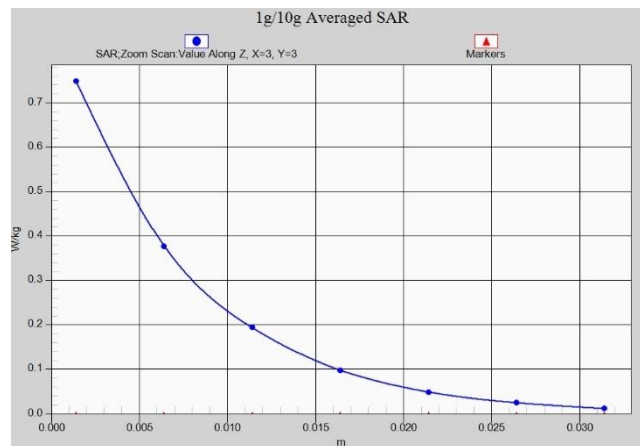

Fig. 1-30 Z-Scan at power reference point (LTE Band41 PC3)

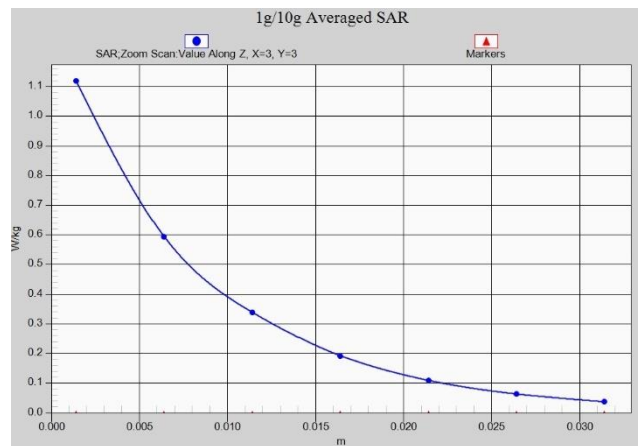

Fig. 1-31 Z-Scan at power reference point (LTE Band66)

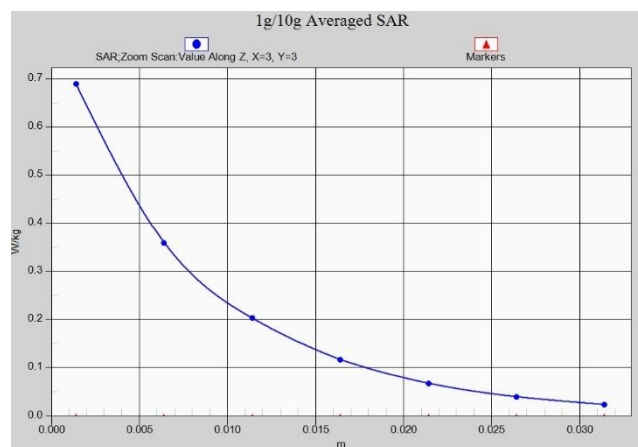

Fig. 1-32 Z-Scan at power reference point (LTE Band66)

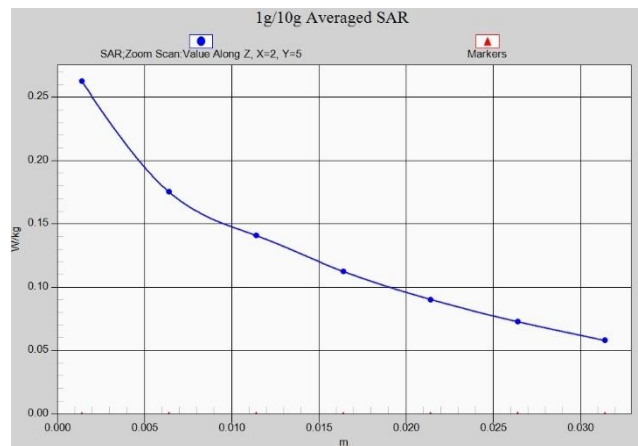

Fig. 1-33 Z-Scan at power reference point (LTE Band71)

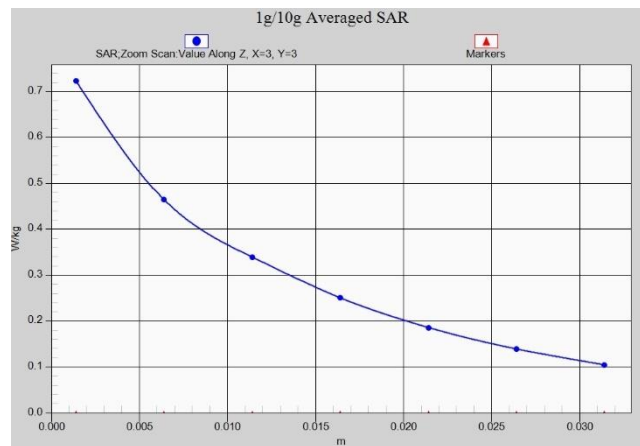

Fig. 1-34 Z-Scan at power reference point (LTE Band71)

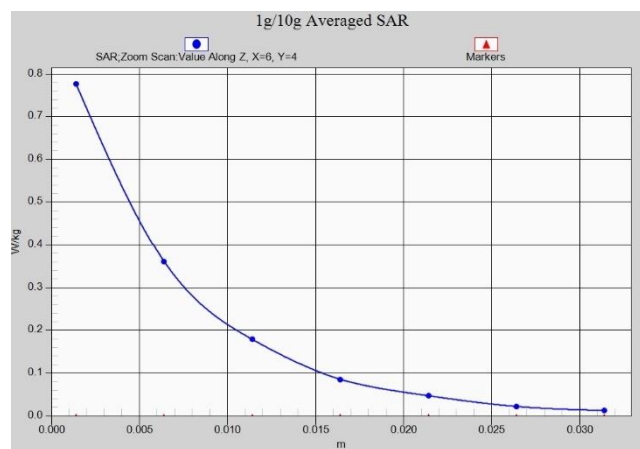

Fig. 1-35 Z-Scan at power reference point (wifi2450)

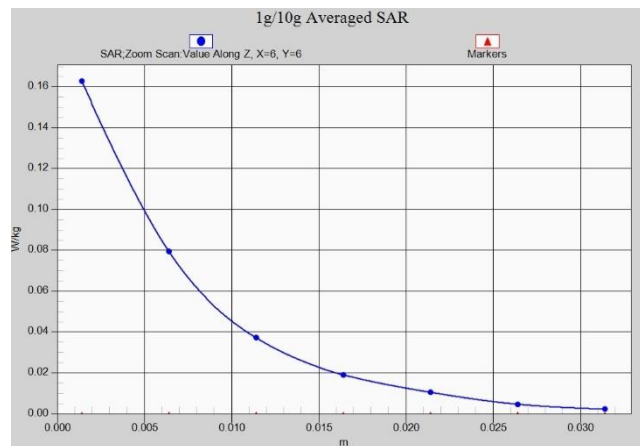

Fig. 1-36 Z-Scan at power reference point (wifi2450)

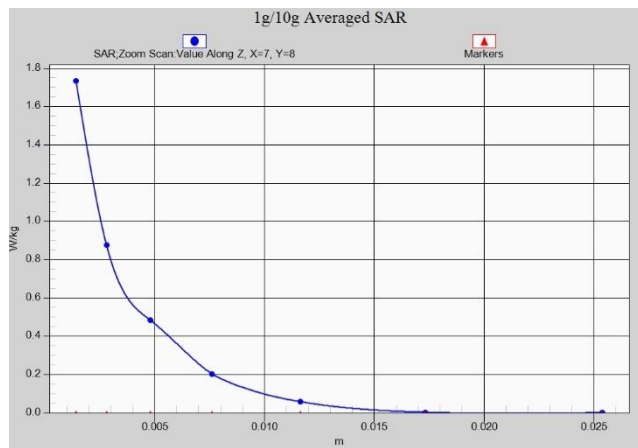

Fig. 1-37 Z-Scan at power reference point (wifi5G)

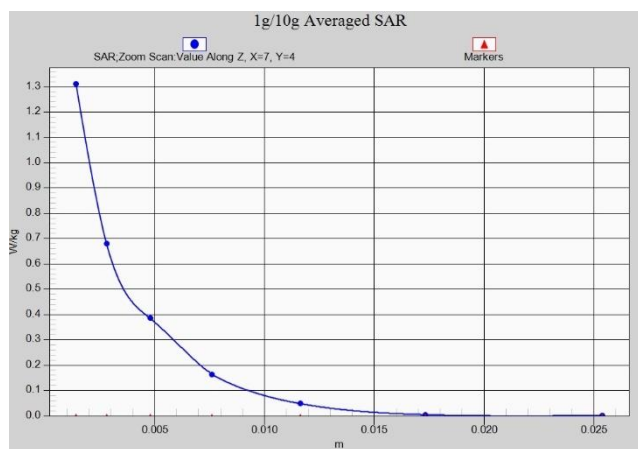

Fig. 1-38 Z-Scan at power reference point (wifi5G)

ANNEX B System Verification Results

750 MHz

Date: 1/4/2021

Electronics: DAE4 Sn536

Medium: Head 750 MHz

Medium parameters used: $f = 750 \text{ MHz}$; $\sigma = 0.881 \text{ mho/m}$; $\epsilon_r = 42.22$; $\rho = 1000 \text{ kg/m}^3$

Ambient Temperature: 22.5°C Liquid Temperature: 22.3°C

Communication System: CW Frequency: 750 MHz Duty Cycle: 1:1

Probe: EX3DV4 – SN3617 ConvF(10.07,10.07,10.07)

System Validation /Area Scan (81x191x1): Interpolated grid: $dx=1.000 \text{ mm}$, $dy=1.000 \text{ mm}$

Reference Value = 60.08 V/m ; Power Drift = 0.06

Fast SAR: SAR(1 g) = 2.11 W/kg ; SAR(10 g) = 1.37 W/kg

Maximum value of SAR (interpolated) = 2.83 W/kg

System Validation /Zoom Scan (7x7x7)/Cube 0: Measurement grid: $dx=5\text{mm}$, $dy=5\text{mm}$, $dz=5\text{mm}$

Reference Value = 60.08 V/m ; Power Drift = 0.06 dB

Peak SAR (extrapolated) = 3.31 W/kg

SAR(1 g) = 2.12 W/kg ; SAR(10 g) = 1.36 W/kg

Maximum value of SAR (measured) = 2.89 W/kg

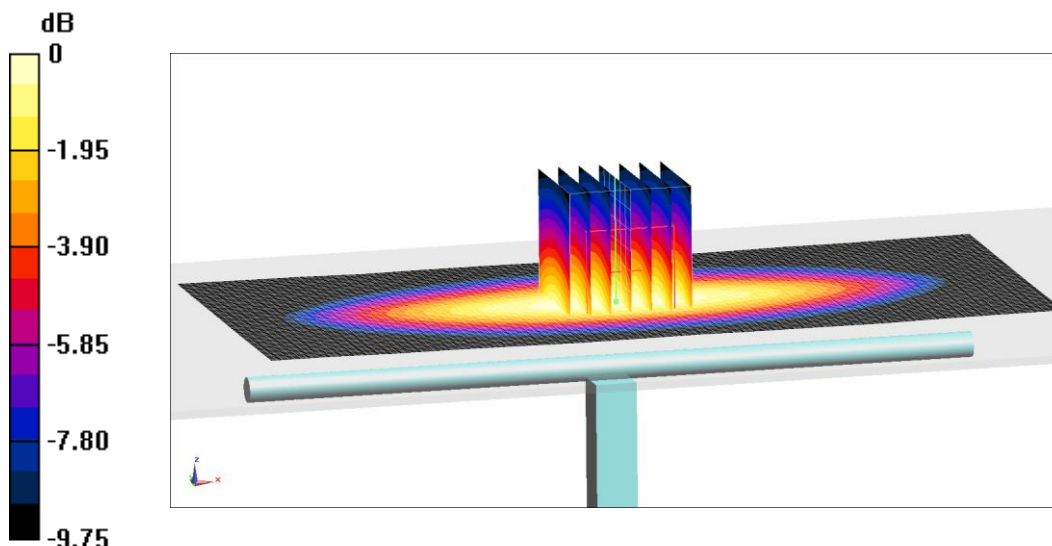

0 dB = 2.89 W/kg = 4.61 dB W/kg

Fig.B.1 validation 750 MHz 250mW

835 MHz

Date: 1/5/2021

Electronics: DAE4 Sn536

Medium: Head 835 MHz

Medium parameters used: $f = 835 \text{ MHz}$; $\sigma = 0.889 \text{ mho/m}$; $\epsilon_r = 42.29$; $\rho = 1000 \text{ kg/m}^3$

Ambient Temperature: 22.5°C Liquid Temperature: 22.3°C

Communication System: CW Frequency: 835 MHz Duty Cycle: 1:1

Probe: EX3DV4 – SN3617 ConvF(9.66,9.66,9.66)

System Validation /Area Scan (81x191x1): Interpolated grid: $dx=1.000 \text{ mm}$, $dy=1.000 \text{ mm}$

Reference Value = 62.84 V/m; Power Drift = 0.01

Fast SAR: SAR(1 g) = 2.44 W/kg; SAR(10 g) = 1.54 W/kg

Maximum value of SAR (interpolated) = 3.18 W/kg

System Validation /Zoom Scan (7x7x7)/Cube 0: Measurement grid: $dx=5\text{mm}$, $dy=5\text{mm}$, $dz=5\text{mm}$

Reference Value = 62.84 V/m; Power Drift = 0.01 dB

Peak SAR (extrapolated) = 3.58 W/kg

SAR(1 g) = 2.43 W/kg; SAR(10 g) = 1.56 W/kg

Maximum value of SAR (measured) = 3.25 W/kg

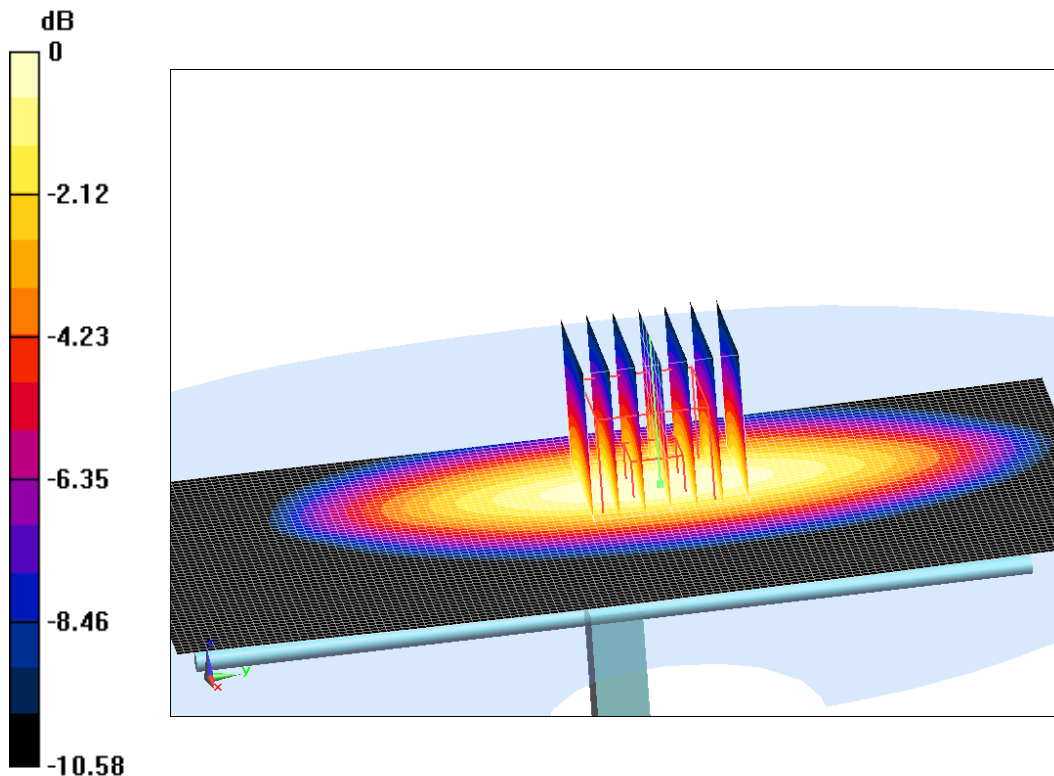

0 dB = 3.25 W/kg = 5.12 dB W/kg

Fig.B.2 validation 835 MHz 250mW

835 MHz

Date: 1/6/2021

Electronics: DAE4 Sn536

Medium: Head 835 MHz

Medium parameters used: $f = 835 \text{ MHz}$; $\sigma = 0.889 \text{ mho/m}$; $\epsilon_r = 40.8$; $\rho = 1000 \text{ kg/m}^3$

Ambient Temperature: 22.5°C Liquid Temperature: 22.3°C

Communication System: CW Frequency: 835 MHz Duty Cycle: 1:1

Probe: EX3DV4 – SN3617 ConvF(9.66,9.66,9.66)

System Validation /Area Scan (81x191x1): Interpolated grid: $dx=1.000 \text{ mm}$, $dy=1.000 \text{ mm}$

Reference Value = 64.16 V/m; Power Drift = 0.06

Fast SAR: SAR(1 g) = 2.41 W/kg; SAR(10 g) = 1.56 W/kg

Maximum value of SAR (interpolated) = 3.23 W/kg

System Validation /Zoom Scan (7x7x7)/Cube 0: Measurement grid: $dx=5\text{mm}$, $dy=5\text{mm}$, $dz=5\text{mm}$

Reference Value = 64.16 V/m; Power Drift = 0.06 dB

Peak SAR (extrapolated) = 3.62 W/kg

SAR(1 g) = 2.41 W/kg; SAR(10 g) = 1.59 W/kg

Maximum value of SAR (measured) = 3.2 W/kg

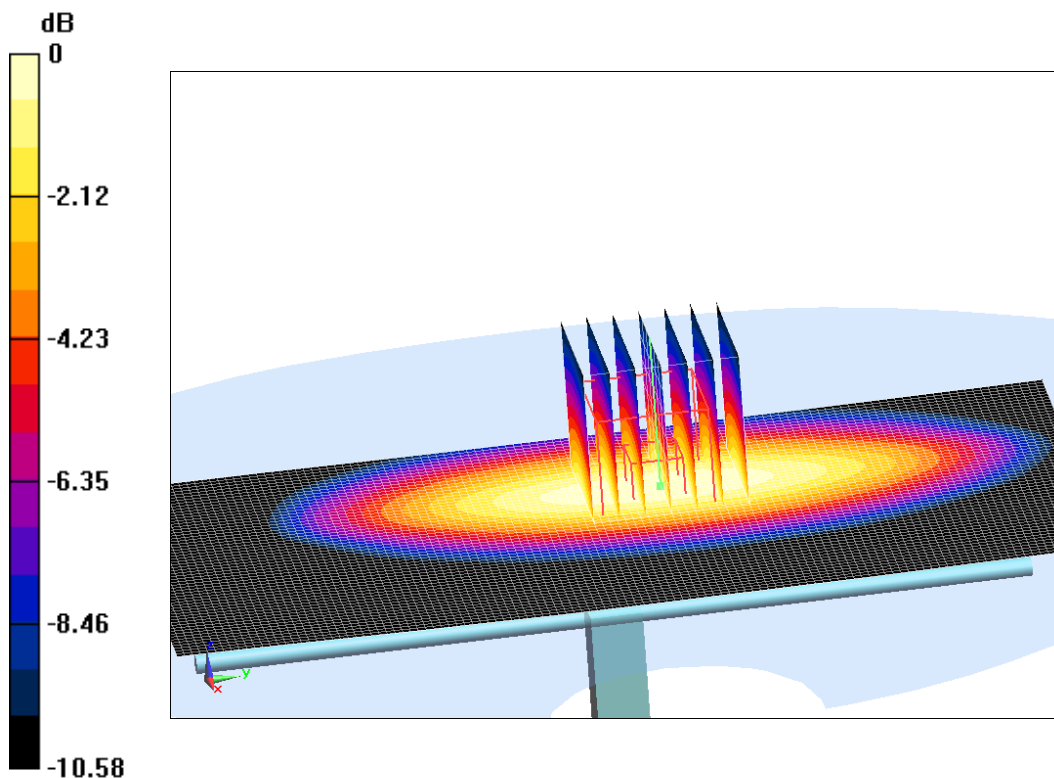

0 dB = 3.2 W/kg = 5.05 dB W/kg

Fig.B.3 validation 835 MHz 250mW

1750 MHz

Date: 1/7/2021

Electronics: DAE4 Sn536

Medium: Head 1750 MHz

Medium parameters used: $f = 1750$ MHz; $\sigma = 1.358$ mho/m; $\epsilon_r = 40.85$; $\rho = 1000$ kg/m³

Ambient Temperature: 22.5°C Liquid Temperature: 22.3°C

Communication System: CW Frequency: 1750 MHz Duty Cycle: 1:1

Probe: EX3DV4 – SN3617 ConvF(8.41,8.41,8.41)

System Validation /Area Scan (81x191x1): Interpolated grid: dx=1.000 mm, dy=1.000 mm

Reference Value = 106.6 V/m; Power Drift = 0.07

Fast SAR: SAR(1 g) = 9.05 W/kg; SAR(10 g) = 4.77 W/kg

Maximum value of SAR (interpolated) = 14.12 W/kg

System Validation /Zoom Scan (7x7x7)/Cube 0: Measurement grid: dx=5mm, dy=5mm, dz=5mm

Reference Value = 106.6 V/m; Power Drift = 0.07 dB

Peak SAR (extrapolated) = 17 W/kg

SAR(1 g) = 9.16 W/kg; SAR(10 g) = 4.74 W/kg

Maximum value of SAR (measured) = 14 W/kg

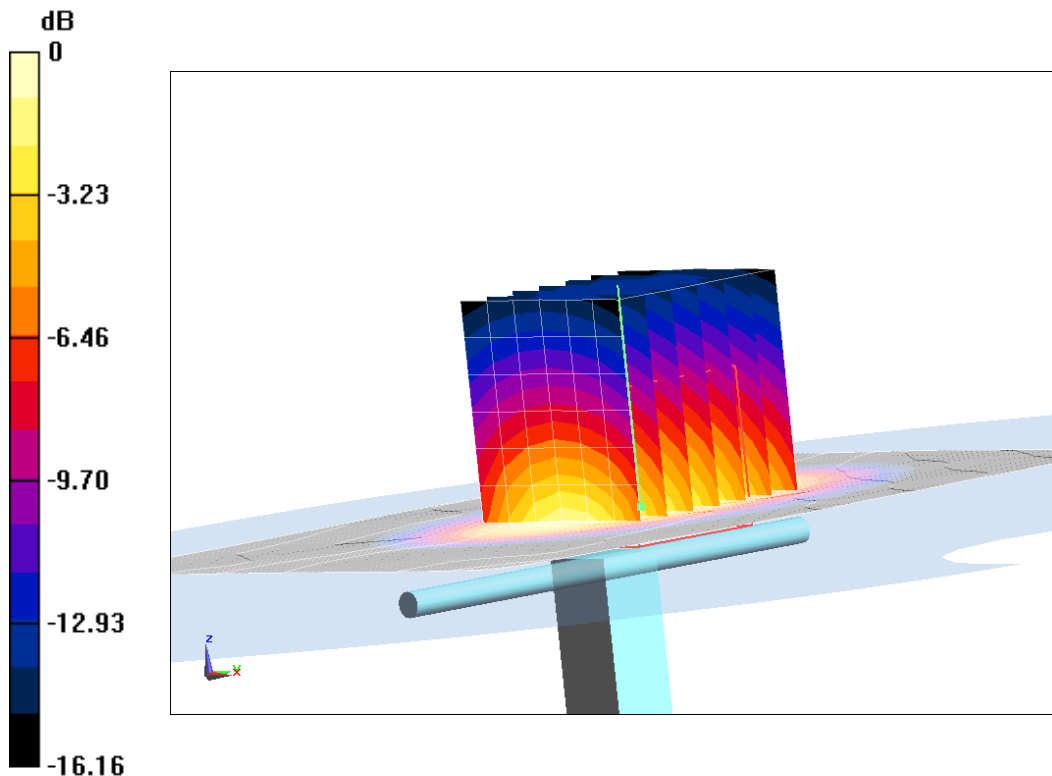

0 dB = 14 W/kg = 11.46 dB W/kg

Fig.B.4 validation 1750 MHz 250mW

1900 MHz

Date: 1/8/2021

Electronics: DAE4 Sn536

Medium: Head 1900 MHz

Medium parameters used: $f = 1900$ MHz; $\sigma = 1.418$ mho/m; $\epsilon_r = 40.17$; $\rho = 1000$ kg/m³

Ambient Temperature: 22.5°C Liquid Temperature: 22.3°C

Communication System: CW Frequency: 1900 MHz Duty Cycle: 1:1

Probe: EX3DV4 – SN3617 ConvF(8.14,8.14,8.14)

System Validation /Area Scan (81x191x1): Interpolated grid: dx=1.000 mm, dy=1.000 mm

Reference Value = 110.65 V/m; Power Drift = 0.02

Fast SAR: SAR(1 g) = 9.97 W/kg; SAR(10 g) = 5.1 W/kg

Maximum value of SAR (interpolated) = 15.17 W/kg

System Validation /Zoom Scan (7x7x7)/Cube 0: Measurement grid: dx=5mm, dy=5mm, dz=5mm

Reference Value = 110.65 V/m; Power Drift = 0.02 dB

Peak SAR (extrapolated) = 18.39 W/kg

SAR(1 g) = 9.9 W/kg; SAR(10 g) = 5.11 W/kg

Maximum value of SAR (measured) = 15.11 W/kg

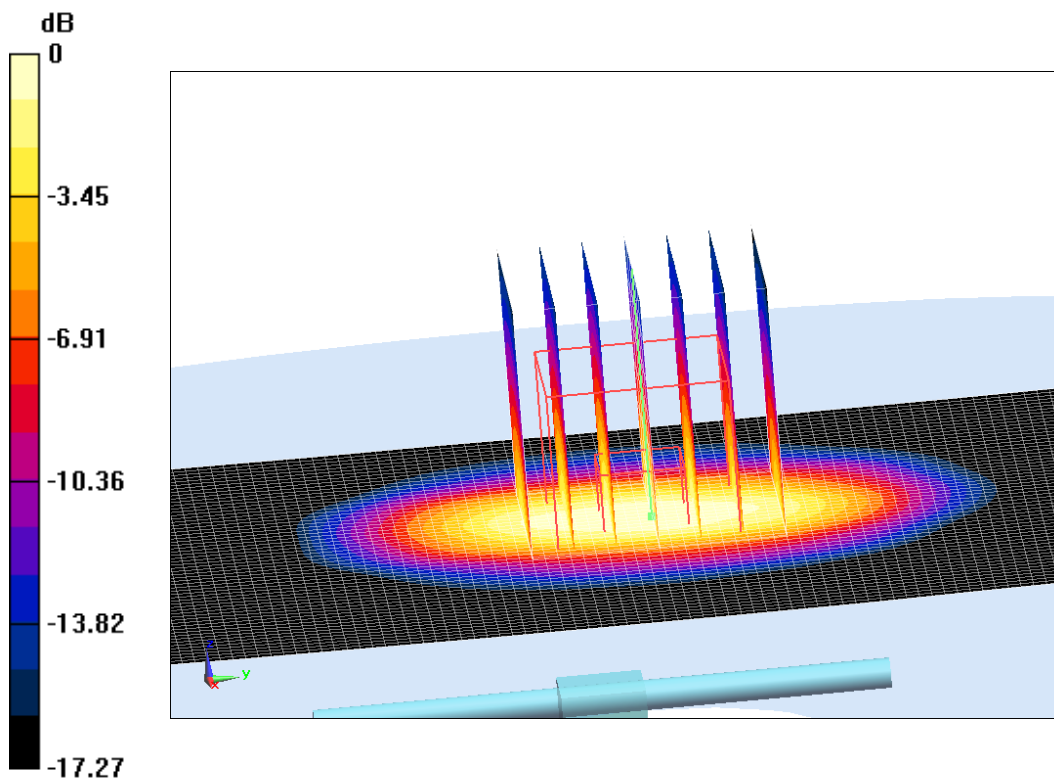

0 dB = 15.11 W/kg = 11.79 dB W/kg

Fig.B.5 validation 1900 MHz 250mW

1900 MHz

Date: 1/9/2021

Electronics: DAE4 Sn536

Medium: Head 1900 MHz

Medium parameters used: $f = 1900$ MHz; $\sigma = 1.41$ mho/m; $\epsilon_r = 40.02$; $\rho = 1000$ kg/m³

Ambient Temperature: 22.5°C Liquid Temperature: 22.3°C

Communication System: CW Frequency: 1900 MHz Duty Cycle: 1:1

Probe: EX3DV4 – SN3617 ConvF(8.14,8.14,8.14)

System Validation /Area Scan (81x191x1): Interpolated grid: dx=1.000 mm, dy=1.000 mm

Reference Value = 108.26 V/m; Power Drift = -0.05

Fast SAR: SAR(1 g) = 9.73 W/kg; SAR(10 g) = 5.12 W/kg

Maximum value of SAR (interpolated) = 15.43 W/kg

System Validation /Zoom Scan (7x7x7)/Cube 0: Measurement grid: dx=5mm, dy=5mm, dz=5mm

Reference Value = 108.26 V/m; Power Drift = -0.05 dB

Peak SAR (extrapolated) = 18.01 W/kg

SAR(1 g) = 9.76 W/kg; SAR(10 g) = 5.1 W/kg

Maximum value of SAR (measured) = 15.23 W/kg

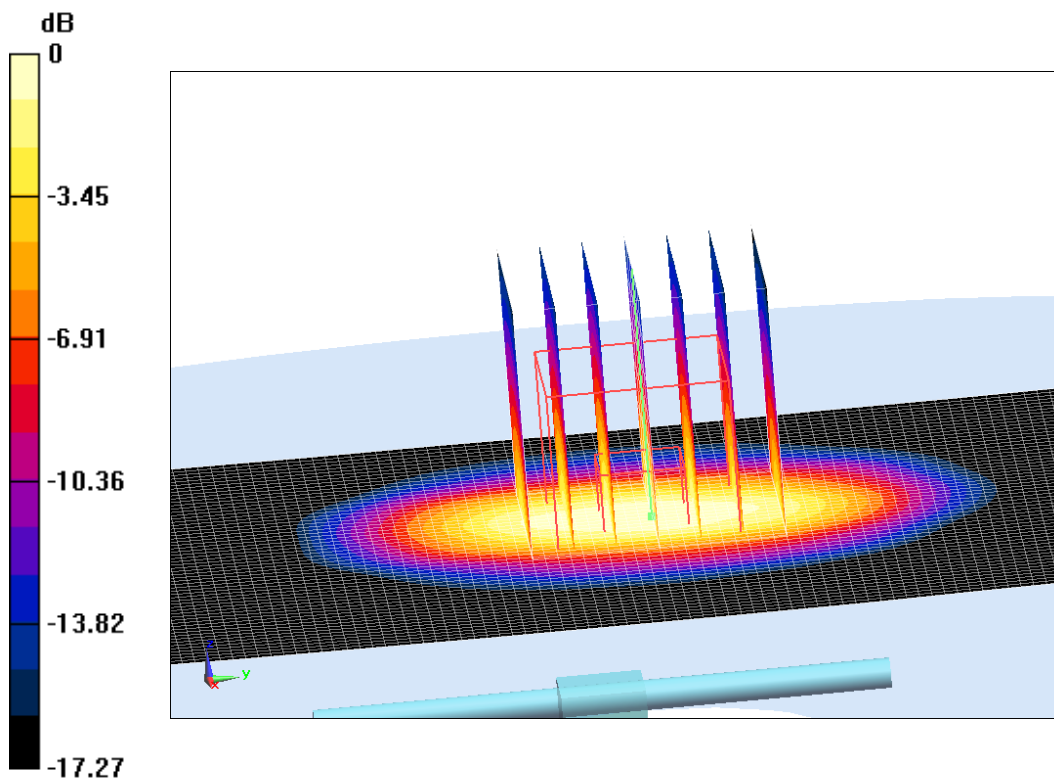

0 dB = 15.23 W/kg = 11.83 dB W/kg

Fig.B.6 validation 1900 MHz 250mW

2450 MHz

Date: 1/10/2021

Electronics: DAE4 Sn536

Medium: Head 2450 MHz

Medium parameters used: $f = 2450$ MHz; $\sigma = 1.797$ mho/m; $\epsilon_r = 39.01$; $\rho = 1000$ kg/m³

Ambient Temperature: 22.5°C Liquid Temperature: 22.3°C

Communication System: CW Frequency: 2450 MHz Duty Cycle: 1:1

Probe: EX3DV4 – SN3617 ConvF(7.65,7.65,7.65)

System Validation /Area Scan (81x191x1): Interpolated grid: dx=1.000 mm, dy=1.000 mm

Reference Value = 118.93 V/m; Power Drift = -0.06

Fast SAR: SAR(1 g) = 13.23 W/kg; SAR(10 g) = 6.11 W/kg

Maximum value of SAR (interpolated) = 21.92 W/kg

System Validation /Zoom Scan (7x7x7)/Cube 0: Measurement grid: dx=5mm, dy=5mm, dz=5mm

Reference Value = 118.93 V/m; Power Drift = -0.06 dB

Peak SAR (extrapolated) = 25.78 W/kg

SAR(1 g) = 13.23 W/kg; SAR(10 g) = 6.01 W/kg

Maximum value of SAR (measured) = 21.4 W/kg

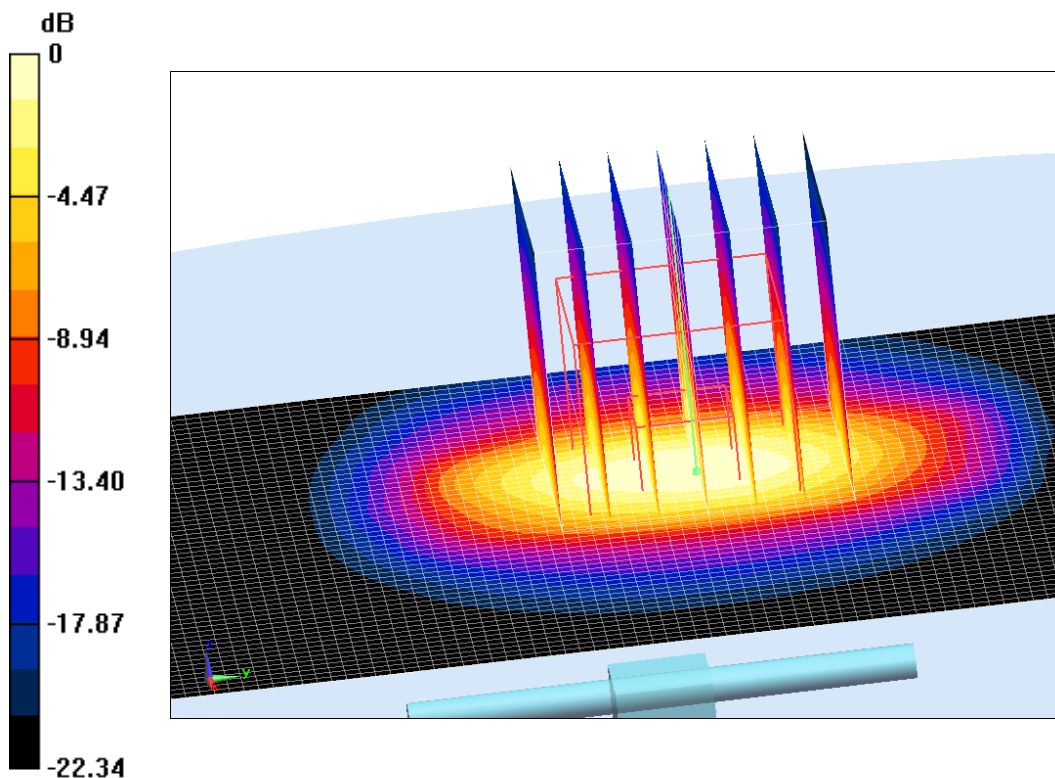

0 dB = 21.4 W/kg = 13.3 dB W/kg

Fig.B.7 validation 2450 MHz 250mW

2600 MHz

Date: 1/11/2021

Electronics: DAE4 Sn536

Medium: Head 2600 MHz

Medium parameters used: $f = 2600$ MHz; $\sigma = 1.985$ mho/m; $\epsilon_r = 38.96$; $\rho = 1000$ kg/m³

Ambient Temperature: 22.5°C Liquid Temperature: 22.3°C

Communication System: CW Frequency: 2600 MHz Duty Cycle: 1:1

Probe: EX3DV4 – SN3617 ConvF(7.52,7.52,7.52)

System Validation /Area Scan (81x191x1): Interpolated grid: dx=1.000 mm, dy=1.000 mm

Reference Value = 122.79 V/m; Power Drift = -0.01

Fast SAR: SAR(1 g) = 14.28 W/kg; SAR(10 g) = 6.36 W/kg

Maximum value of SAR (interpolated) = 24.45 W/kg

System Validation /Zoom Scan (7x7x7)/Cube 0: Measurement grid: dx=5mm, dy=5mm, dz=5mm

Reference Value = 122.79 V/m; Power Drift = -0.01 dB

Peak SAR (extrapolated) = 29.01 W/kg

SAR(1 g) = 14.37 W/kg; SAR(10 g) = 6.21 W/kg

Maximum value of SAR (measured) = 24.85 W/kg

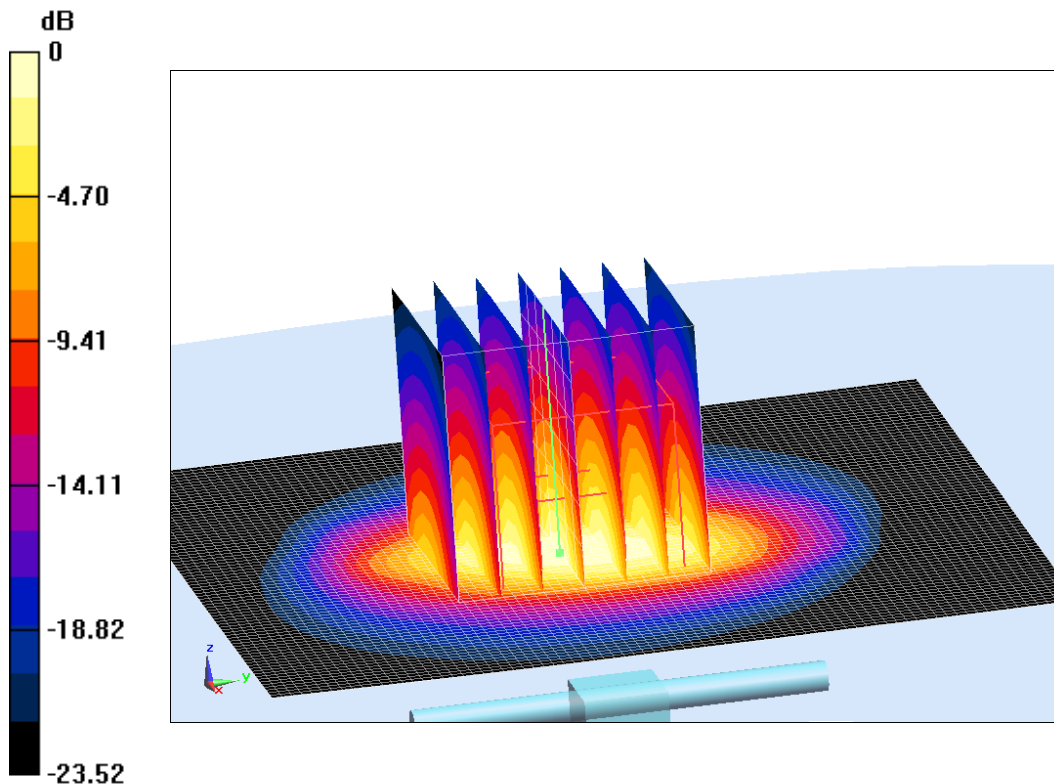

0 dB = 24.85 W/kg = 13.95 dB W/kg

Fig.B.8 validation 2600 MHz 250mW

2600 MHz

Date: 1/12/2021

Electronics: DAE4 Sn536

Medium: Head 2600 MHz

Medium parameters used: $f = 2600$ MHz; $\sigma = 1.96$ mho/m; $\epsilon_r = 38.4$; $\rho = 1000$ kg/m³

Ambient Temperature: 22.5°C Liquid Temperature: 22.3°C

Communication System: CW Frequency: 2600 MHz Duty Cycle: 1:1

Probe: EX3DV4 – SN3617 ConvF(7.52,7.52,7.52)

System Validation /Area Scan (81x191x1): Interpolated grid: dx=1.000 mm, dy=1.000 mm

Reference Value = 121 V/m; Power Drift = 0.02

Fast SAR: SAR(1 g) = 14.01 W/kg; SAR(10 g) = 6.28 W/kg

Maximum value of SAR (interpolated) = 24.01 W/kg

System Validation /Zoom Scan (7x7x7)/Cube 0: Measurement grid: dx=5mm, dy=5mm, dz=5mm

Reference Value = 121 V/m; Power Drift = 0.02 dB

Peak SAR (extrapolated) = 28.74 W/kg

SAR(1 g) = 13.97 W/kg; SAR(10 g) = 6.36 W/kg

Maximum value of SAR (measured) = 24.72 W/kg

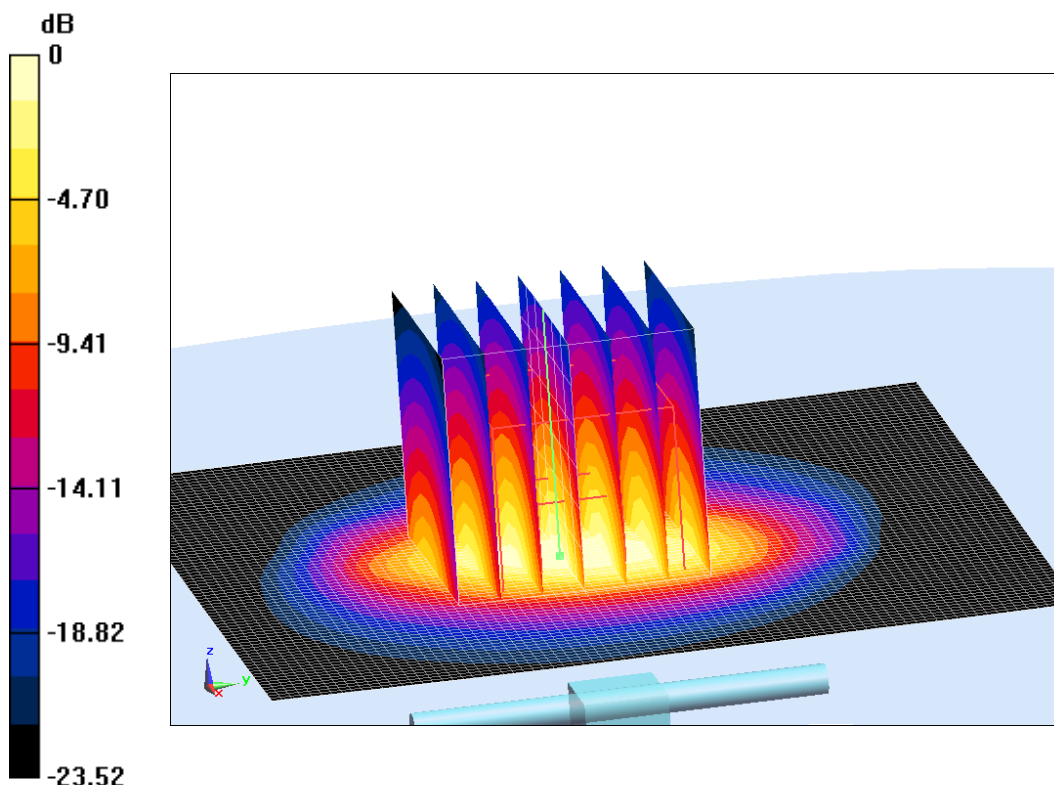

0 dB = 24.72 W/kg = 13.93 dB W/kg

Fig.B.9 validation 2600 MHz 250mW

5250 MHz

Date: 1/13/2021

Electronics: DAE4 Sn536

Medium: Head 5250 MHz

Medium parameters used: $f = 5250$ MHz; $\sigma = 4.685$ mho/m; $\epsilon_r = 35.52$; $\rho = 1000$ kg/m³

Ambient Temperature: 22.5°C Liquid Temperature: 22.3°C

Communication System: CW Frequency: 5250 MHz Duty Cycle: 1:1

Probe: EX3DV4 – SN3617 ConvF(5.39,5.39,5.39)

System Validation /Area Scan (81x191x1): Interpolated grid: dx=1.000 mm, dy=1.000 mm

Maximum value of SAR (interpolated) = 18.19 W/kg

System Validation /Zoom Scan (7x7x7)/Cube 0: Measurement grid: dx=5mm, dy=5mm, dz=5mm

Reference Value =78.83 V/m; Power Drift = -0.05 dB

Peak SAR (extrapolated) = 28.3 W/kg

SAR(1 g) = 20.04 W/kg; SAR(10 g) = 5.68 W/kg

Maximum value of SAR (measured) = 18.69 W/kg

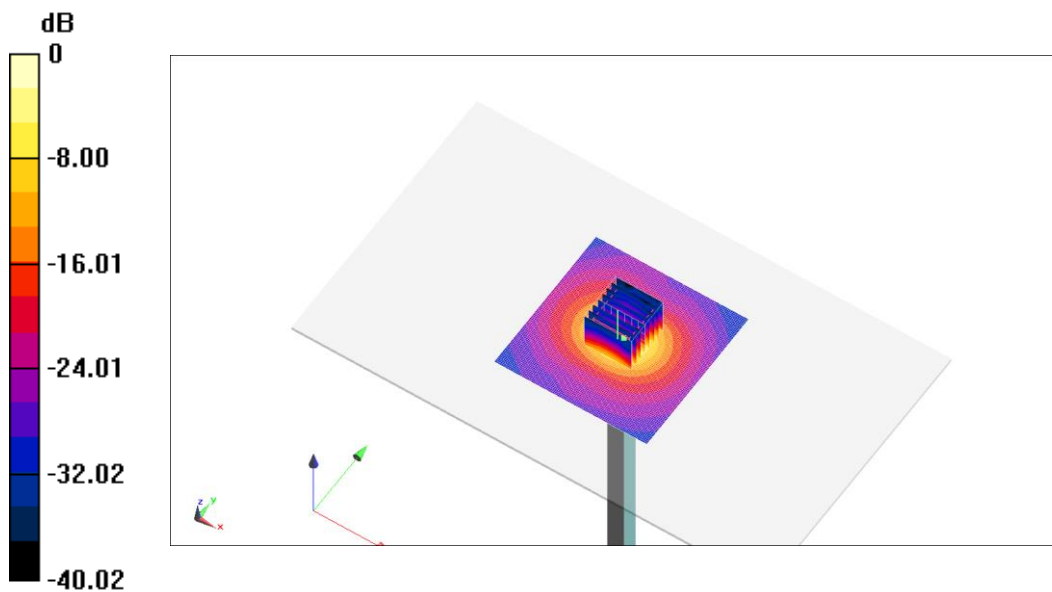

0 dB = 18.69 W/kg = 12.72 dB W/kg

Fig.B.10 validation 5250 MHz 250mW

5600 MHz

Date: 1/14/2021

Electronics: DAE4 Sn536

Medium: Head 5600 MHz

Medium parameters used: $f = 5600$ MHz; $\sigma = 5.019$ mho/m; $\epsilon_r = 35.74$; $\rho = 1000$ kg/m³

Ambient Temperature: 22.5°C Liquid Temperature: 22.3°C

Communication System: CW Frequency: 5600 MHz Duty Cycle: 1:1

Probe: EX3DV4 – SN3617 ConvF(4.99,4.99,4.99)

System Validation /Area Scan (81x191x1): Interpolated grid: dx=1.000 mm, dy=1.000 mm

Maximum value of SAR (interpolated) = 19.93 W/kg

System Validation /Zoom Scan (7x7x7)/Cube 0: Measurement grid: dx=5mm, dy=5mm, dz=5mm

Reference Value =78.3 V/m; Power Drift = 0.08 dB

Peak SAR (extrapolated) = 31.69 W/kg

SAR(1 g) = 20.74 W/kg; SAR(10 g) = 5.85 W/kg

Maximum value of SAR (measured) = 20.12 W/kg

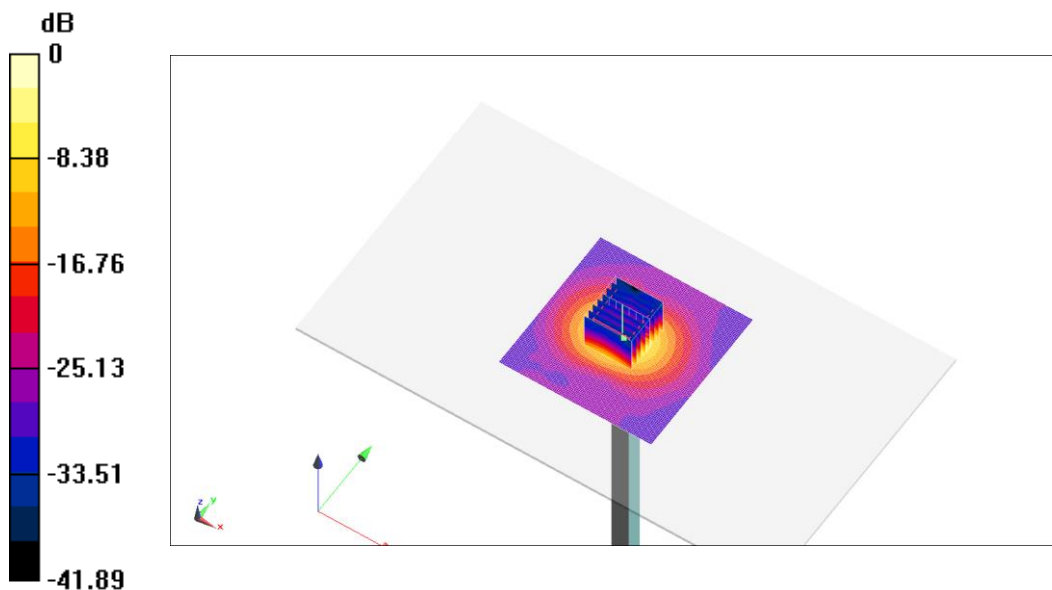

0 dB = 20.12 W/kg = 13.04 dB W/kg

Fig.B.11 validation 5600 MHz 250mW

5750 MHz

Date: 1/15/2021

Electronics: DAE4 Sn536

Medium: Head 5750 MHz

Medium parameters used: $f = 5750$ MHz; $\sigma = 5.161$ mho/m; $\epsilon_r = 35.92$; $\rho = 1000$ kg/m³

Ambient Temperature: 22.5°C Liquid Temperature: 22.3°C

Communication System: CW Frequency: 5750 MHz Duty Cycle: 1:1

Probe: EX3DV4 – SN3617 ConvF(5.10,5.10,5.10)

System Validation /Area Scan (81x191x1): Interpolated grid: dx=1.000 mm, dy=1.000 mm

Maximum value of SAR (interpolated) = 19.66 W/kg

System Validation /Zoom Scan (7x7x7)/Cube 0: Measurement grid: dx=5mm, dy=5mm, dz=5mm

Reference Value =77.15 V/m; Power Drift = 0.07 dB

Peak SAR (extrapolated) = 32.29 W/kg

SAR(1 g) = 19.99 W/kg; SAR(10 g) = 5.68 W/kg

Maximum value of SAR (measured) = 19.8 W/kg

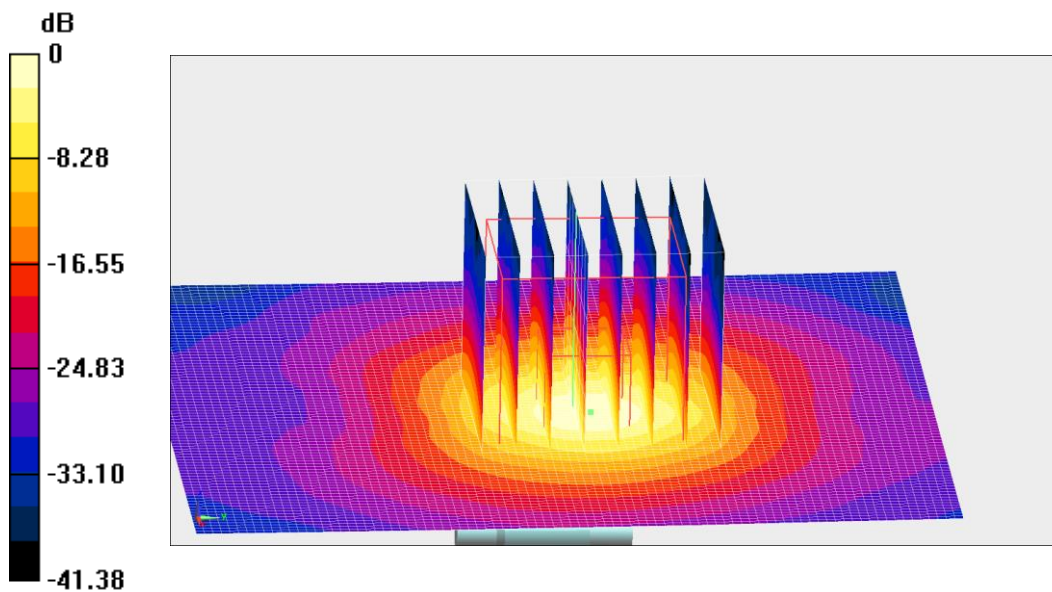

0 dB = 19.8 W/kg = 12.97 dB W/kg

Fig.B.12 validation 5750 MHz 250mW

The SAR system verification must be required that the area scan estimated 1-g SAR is within 3% of the zoom scan 1-g SAR.

Table B.1 Comparison between area scan and zoom scan for system verification

Date	Band	Position	Area scan (1g)	Zoom scan (1g)	Drift (%)
2021-1-4	750 MHz	Head	2.11	2.12	-0.47
2021-1-5	835 MHz	Head	2.44	2.43	0.41
2021-1-6	835 MHz	Head	2.41	2.41	0.00
2021-1-7	1750 MHz	Head	9.05	9.16	-1.20
2021-1-8	1900 MHz	Head	9.97	9.9	0.71
2021-1-9	1900 MHz	Head	9.73	9.76	-0.31
2021-1-10	2450 MHz	Head	13.23	13.23	0.00
2021-1-11	2600 MHz	Head	14.28	14.37	-0.63
2021-1-12	2600 MHz	Head	14.01	13.97	0.29

ANNEX C SAR Measurement Setup

C.1 Measurement Set-up

The Dasy4 or DASY5 system for performing compliance tests is illustrated above graphically. This system consists of the following items:

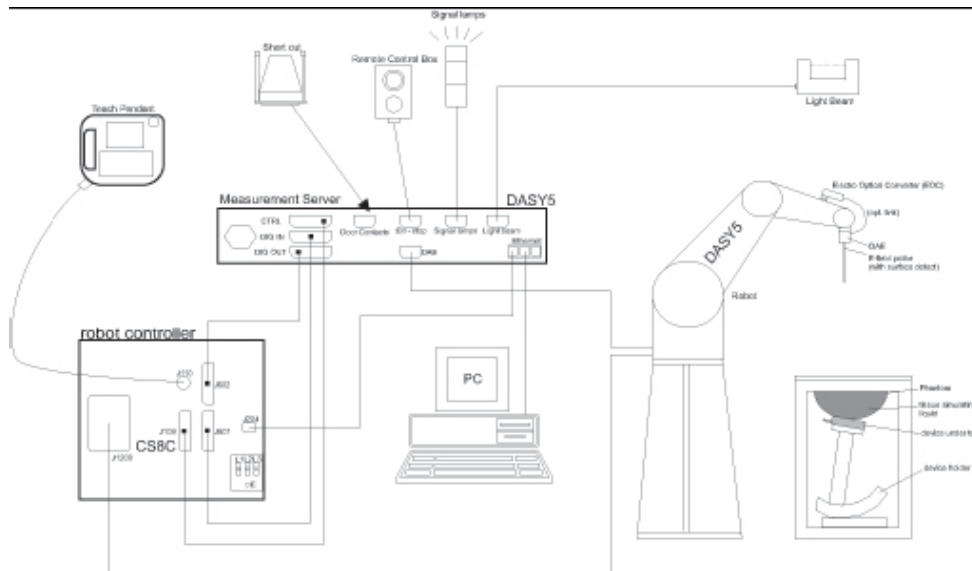

Picture C.1 SAR Lab Test Measurement Set-up

- A standard high precision 6-axis robot (StäubliTX=RX family) with controller, teach pendant and software. An arm extension for accommodating the data acquisition electronics (DAE).
- An isotropic field probe optimized and calibrated for the targeted measurement.
- A data acquisition electronics (DAE) which performs the signal amplification, signal multiplexing, AD-conversion, offset measurements, mechanical surface detection, collision detection, etc. The unit is battery powered with standard or rechargeable batteries. The signal is optically transmitted to the EOC.
- The Electro-optical converter (EOC) performs the conversion from optical to electrical signals for the digital communication to the DAE. To use optical surface detection, a special version of the EOC is required. The EOC signal is transmitted to the measurement server.
- The function of the measurement server is to perform the time critical tasks such as signal filtering, control of the robot operation and fast movement interrupts.
- The Light Beam used is for probe alignment. This improves the (absolute) accuracy of the probe positioning.
- A computer running WinXP and the DASY4 or DASY5 software.
- Remote control and teach pendant as well as additional circuitry for robot safety such as
- warning lamps, etc.
- The phantom, the device holder and other accessories according to the targeted measurement.