



FCC PART 15 TEST REPORT No.I19Z70303-IOT08

for

Client name: Samsung Electronics. Co., Ltd.

Product name: Mobile phone

Model name: SM-A015V

With

FCC ID: ZCASMA115V

Hardware Version: REV3.0

Software Version: A015V.001(A015VVRE0ASJ3)

Issued Date: 2020-01-06

Note:

The test results in this test report relate only to the devices specified in this report. This report shall not be reproduced except in full without the written approval of CTTL.

The report must not be used by the client to claim product certification, approval, or endorsement by NVLAP, NIST, or any agency of the U.S.Government.

Test Laboratory:

CTTL-Telecommunication Technology Labs, CAICT

No. 52, Huayuan North Road, Haidian District, Beijing, P. R. China 100191.

Tel:+86(0)10-62304633-2512, Fax:+86(0)10-62304633-2504

Email: ctl_terminals@caict.ac.cn, website: www.caict.ac.cn



REPORT HISTORY

Report Number	Revision	Description	Issue Date
I19Z70303-IOT08	Rev.0	1st edition	2020-01-06

CONTENTS

CONTENTS	3
1. TEST LATORATORY.....	4
1.1. INTRODUCTION & ACCREDITATION	4
1.2. TESTING LOCATION	4
1.3. TESTING ENVIRONMENT.....	4
1.4. PROJECT DATE	4
1.5. SIGNATURE	4
2. CLIENT INFORMATION.....	5
2.1. APPLICANT INFORMATION	5
2.2. MANUFACTURER INFORMATION	5
3. EQUIPMENT UNDER TEST (EUT) AND ANCILLARY EQUIPMENT(AE)	6
3.1. ABOUT EUT	6
3.2. INTERNAL IDENTIFICATION OF EUT USED DURING THE TEST	6
3.3. GENERAL DESCRIPTION.....	6
4. REFERENCE DOCUMENTS	7
4.1. DOCUMENTS SUPPLIED BY APPLICANT	7
4.2. REFERENCE DOCUMENTS FOR TESTING.....	7
5. LABORATORY ENVIRONMENT.....	7
6. SUMMARY OF TEST RESULTS	7
6.1. SUMMARY OF TEST RESULTS.....	7
6.2. STATEMENTS.....	7
7. TEST EQUIPMENTS UTILIZED	8
ANNEX A: MEASUREMENT RESULTS.....	9
A.1. MEASUREMENT METHOD	9
A.2. CHANNEL MOVE TIME AND CHANNEL CLOSING TRANSMISSION TIME	11
A.3. NON-OCCUPANCY PERIOD.....	15
A3.1 ASSOCIATED TEST	15
ANNEX B: ACCREDITATION CERTIFICATE.....	17

1. TEST LABORATORY

1.1. Introduction & Accreditation

Telecommunication Technology Labs, CAICT is an ISO/IEC 17025:2005 accredited test laboratory under NATIONAL VOLUNTARY LABORATORY ACCREDITATION PROGRAM (NVLAP) with lab code 600118-0, and is also an FCC accredited test laboratory (CN5017), and ISED accredited test laboratory (CN0066). The detail accreditation scope can be found on NVLAP website.

1.2. Testing Location

Location 1:CTTL(huayuan North Road)

Address: No. 52, Huayuan North Road, Haidian District, Beijing,
P. R. China100191

1.3. Testing Environment

Normal Temperature: 15-35°C

Relative Humidity: 20-75%

1.4. Project date

Testing Start Date: 2019-10-18

Testing End Date: 2019-12-13

1.5. Signature



Xie Xiuzhen

(Prepared this test report)

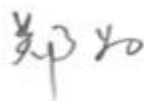

Zheng Wei

(Reviewed this test report)



Hu Xiaoyu

(Approved this test report)



2. CLIENT INFORMATION

2.1. Applicant Information

Company Name: Samsung Electronics. Co., Ltd.
Address: R5, A Tower 22 Floor A-1,(Maetan dong) 129,Samsung-ro,Yeongtong-gu,
Suwon-Si, Gyeonggi-do 16677, Korea
City: /
Postal Code: /
Country: Korea
Telephone: +82-10-4376-0326
Fax: /

2.2. Manufacturer Information

Company Name: Samsung Electronics. Co., Ltd.
Address: R5, A Tower 22 Floor A-1,(Maetan dong) 129,Samsung-ro,Yeongtong-gu,
Suwon-Si, Gyeonggi-do 16677, Korea
City: /
Postal Code: /
Country: Korea
Telephone: +82-10-4376-0326
Fax: /

3. EQUIPMENT UNDER TEST (EUT) AND ANCILLARY

EQUIPMENT(AE)

3.1. About EUT

Description	Mobile phone
Model name	SM-A015V
FCC ID	ZCASMA115V
WLAN Frequency Range	ISM Band: -5250MHz~5350MHz -5470MHz~5725MHz
Type of modulation	OFDM
Antenna	Integral Antenna
Extreme vol. Limits	3.85V
Device Type (DFS)	Client without radar detection(only support client mode)
TPC mechanism	Not support
Antenna gain	-1dBi

3.2. Internal Identification of EUT used during the test

EUT ID*	S/N	HW Version	SW Version
EUT1	351765110000273	REV3.0	A015V.001(A015VVRE0ASJ3)

*EUT ID: is used to identify the test sample in the lab internally.

3.3. General Description

The Equipment Under Test (EUT) is a model of Mobile phone with integrated antenna. It consists of normal options: lithium battery, charger. Manual and specifications of the EUT were provided to fulfil the test.

4. REFERENCE DOCUMENTS

4.1. Documents supplied by applicant

EUT feature information is supplied by the applicant or manufacturer, which is the basis of testing.

4.2. Reference Documents for testing

The following documents listed in this section are referred for testing.

FCC Part15	FCC CFR 47, Part 15, Subpart E: 15.407 General technical requirements.	2018
KDB 905642 D02	UNII DFS Compliance Procedures New Rules v02	2016
KDB 905462 D03	UNII Clients Without Radar Detection New Rules v01r02	2016

5. LABORATORY ENVIRONMENT

Measurement is performed in shielding room.

6. SUMMARY OF TEST RESULTS

6.1. Summary of Test Results

SUMMARY OF MEASUREMENT RESULTS	Sub-clause of Part15E	Verdict
Channel move time and channel closing transmission time	15.407 (h)(2)(iii)	P
Non-Occupancy Period	15.407 (h)(2) (iv)	P

Please refer to **ANNEX A** for detail.

Terms used in Verdict column

P	Pass, The EUT complies with the essential requirements in the standard.
NM	Not measured, The test was not measured by CTTL
NA	Not Applicable, The test was not applicable
F	Fail, The EUT does not comply with the essential requirements in the standard

6.2. Statements

CTTL has evaluated the test cases requested by the client/manufacturer as listed in section 6.1 of this report for the EUT specified in section 3 according to the standards or reference documents listed in section 4.1.

This report only deal with the UNII DFS functions among the features described in section 3, and The EUT met all requirements of the reference documents.

The end user is not available to get and modify the parameters of the detected Radar Waveforms in this product.

Test Conditions

T nom	Normal Temperature
T min	Low Temperature
T max	High Temperature
V nom	Normal Voltage
V min	Low Voltage

V max	High Voltage
H nom	Norm Humidity
A nom	Norm Air Pressure

For this report, all the test case listed above is tested under Normal Temperature and Normal Voltage, and also under norm humidity, the specific conditions as following:

Temperature	T nom	26°C
Voltage	V nom	3.8V(By battery)
Humidity	H nom	44%
Air Pressure	A nom	1010hPa

7. TEST EQUIPMENTS UTILIZED

Conducted test system

No.	Equipment	Model	Serial Number	Manufacturer	Calibration Period	Calibration Due Date
1	Vector Signal Analyzer	FSQ40	200089	Rohde & Schwarz	1 year	2020-05-15
2	Vector Signal General	SMU200A	103752	Rohde & Schwarz	1 year	2020-05-14
3	Shielding Room	S81	/	ETS-Lindgren	/	/

ANNEX A: MEASUREMENT RESULTS

A.1. Measurement Method

A.1.1. Conducted Measurements

The below figure shows the DFS setup, where the EUT is a WLAN device operating in slave mode, without Radar Interference Detection function. This setup also contains a device operating in master mode. The radar test signals are injected into the master device. The EUT (slave device) is associated with the master device. WLAN traffic is generated by streaming the mpeg file from the master to the slave in full monitor video mode using the media player.

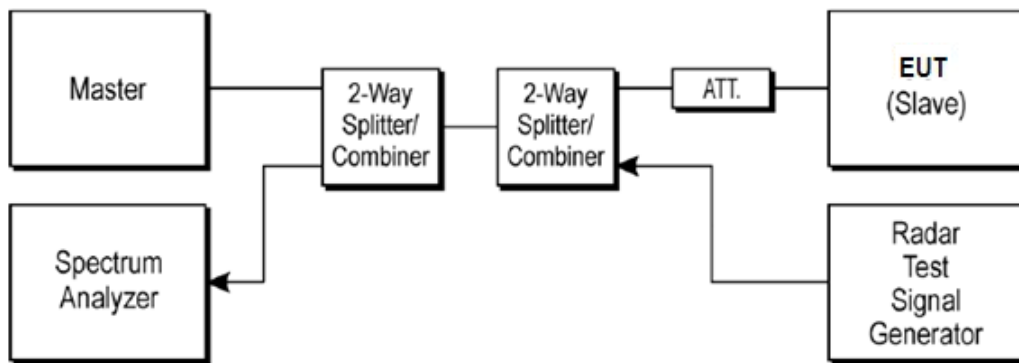

Note:

- 1) All Measurements are performed with the EUT's narrowest channel bandwidth.
- 2) The master device information is as follows
 Vendor: RUCKUS
 Model: R600
 FCC ID: S9GR600
- 3) The software of radar signal generator (R&S SMU200A) is completely designed based on FCC-06-96A1/NTIA requirement.

A.1.2. Parameters of DFS test signal

1). Interference threshold values, master or client incorporation in service monitoring. For device power less than 23dBm (E.I.R.P.), the threshold level is -62 dBm at the antenna port after correction for antenna gain and procedural adjustments.

Because of conducted measurement performed, the calibration power from radar signal generator to antenna port of DFS test equipment is -62 dBm.

Maximum Transmit Power	Value
> 200 mW	-64 dBm
< 200 mW	-62 dBm

The radar Detection Threshold, lowest antenna gain is the parameter of interference radar DFS detection threshold.

One 10 Second plot bee reported for the short Pulse Radar type 1-4, the type 0 was be used, which was selected by auto test software.

Timing plots are required with calculations demonstrating a minimum channel loading of approximately 17% or greater.

Radar Waveform Calibration Result:

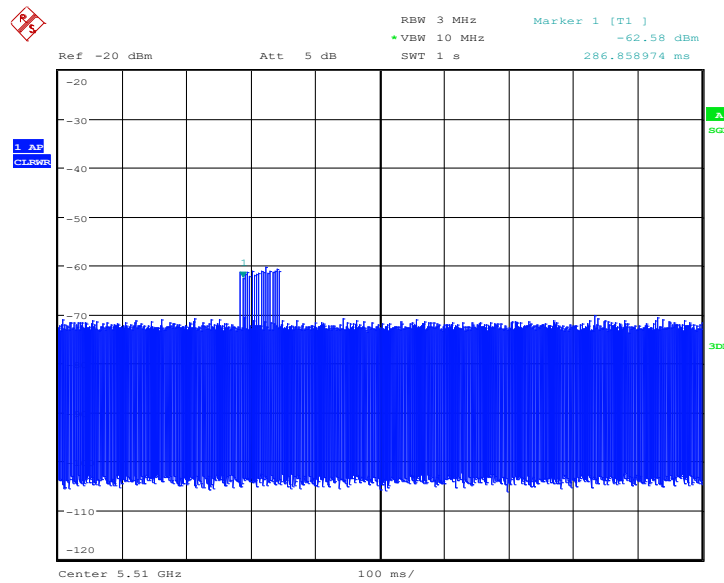

Date: 4.JUN.2018 10:03:04

Fig.A.1 40M Calibration Result

2). DFS requirement values

The required values are as the following table.

Parameter	Value
Non-occupancy	> 1800 s
Channel Availability Check Time	60 s
Channel Move Time	10 s
Channel Closing Transmission Time	200 ms + 60 ms
U-NII Detection Bandwidth	Minimum 80% of the 99% transmission power bandwidth

As the EUT is IP based system, the MPEG video file from NTIA website is used to steam to EUT via the Master device.

A.1.3. Measurement Uncertainty

Item	Measurement Uncertainty
Time	0.70 ms
Power	0.75 dBm

A.2. Channel move time and channel closing transmission time

Measurement Limit:

Test Items	Limit
channel closing transmission time	< 200 ms + 60 ms
Channel move time	< 10 s

Measurement Results:

Frequency Band: 5250MHz ~ 5350MHz

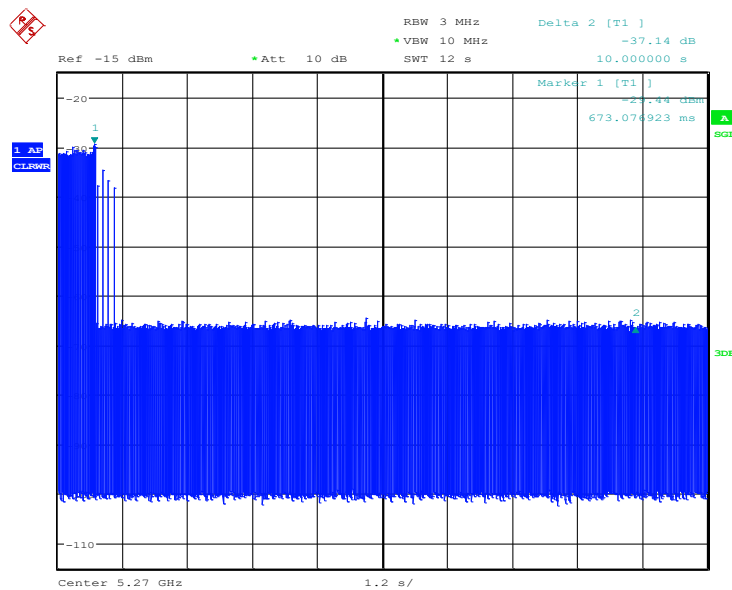

Date: 26.OCT.2019 10:20:18

Fig.A.2 Channel move time

The channel move time is as the figure. It shows the time of the radar and the client pulses. The figure shows that the client stops transmission within 10 seconds, and no transmissions occur after 10 seconds later of the radar burst signal.

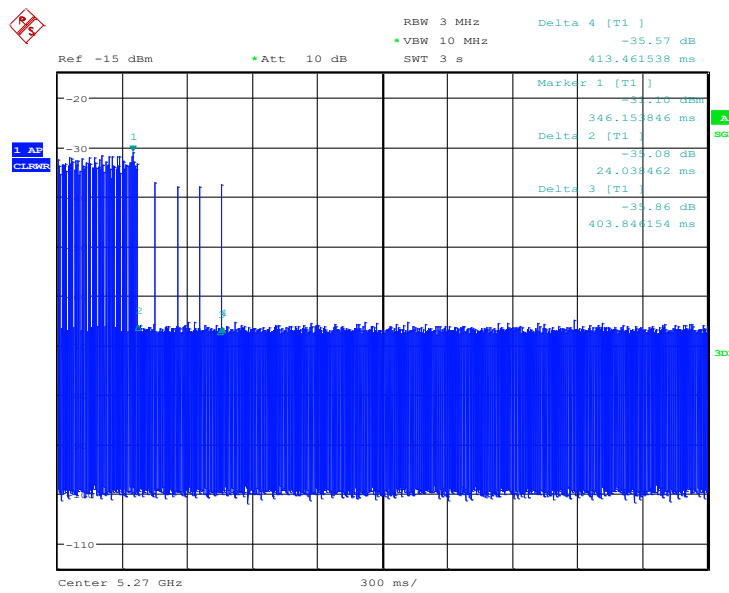

Date: 26.OCT.2019 10:12:12

Fig.A.3 channel closing transmission time

The closing transmission time is as the figure, and the result $62.50\text{ms} = \text{Delta}2 + (\text{Delta}4 - \text{Delta}3) * 4$.

Conclusion: PASS

Frequency Band 5470MHz ~ 5725MHz

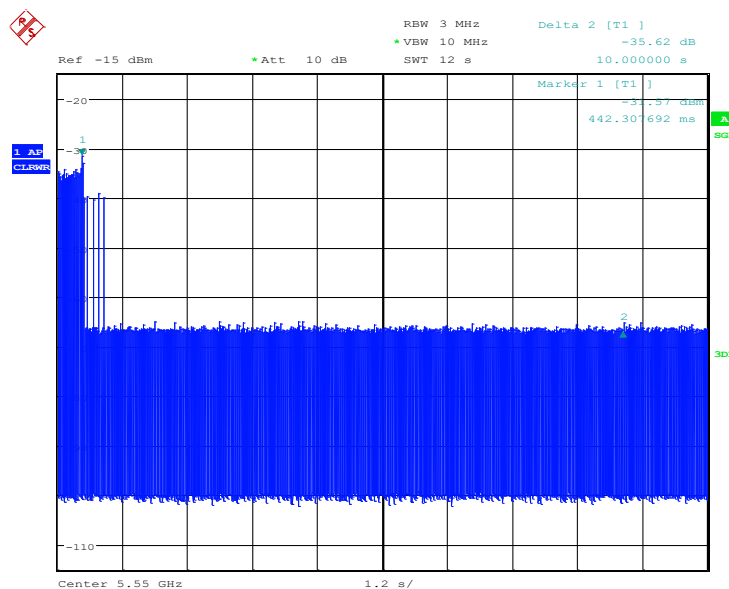

Date: 26.OCT.2019 13:57:21

Fig.A.4 Channel move time

The channel move time is as the figure. It shows the time of the radar and the client pulses. The figure shows that the client stops transmission within 10 seconds, and no transmissions occur after 10 seconds later of the radar burst signal.

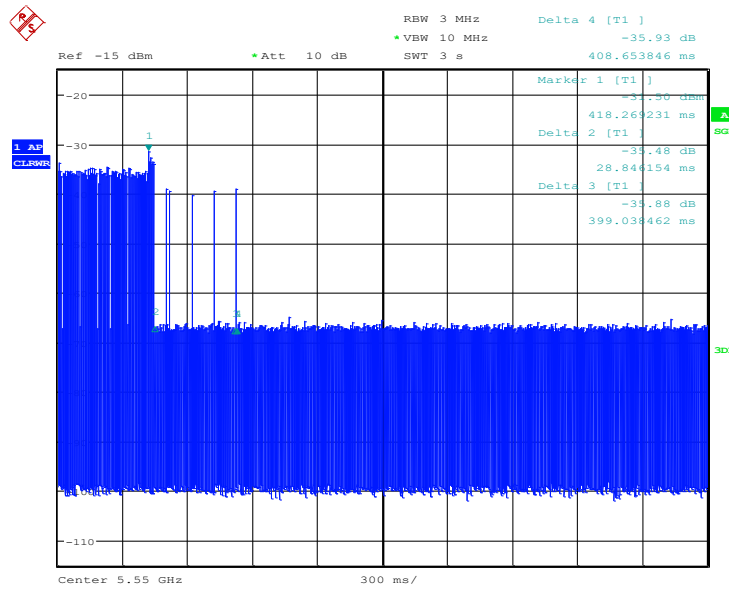

Date: 26.OCT.2019 14:15:36

Fig.A.5 channel closing transmission time

The closing transmission time is as the figure, and the result $76.92\text{ms} = \text{Delta}2 + (\text{Delta}4 - \text{Delta}3) * 5$.

Conclusion: PASS

Frequency Band 5600MHz ~ 5650MHz

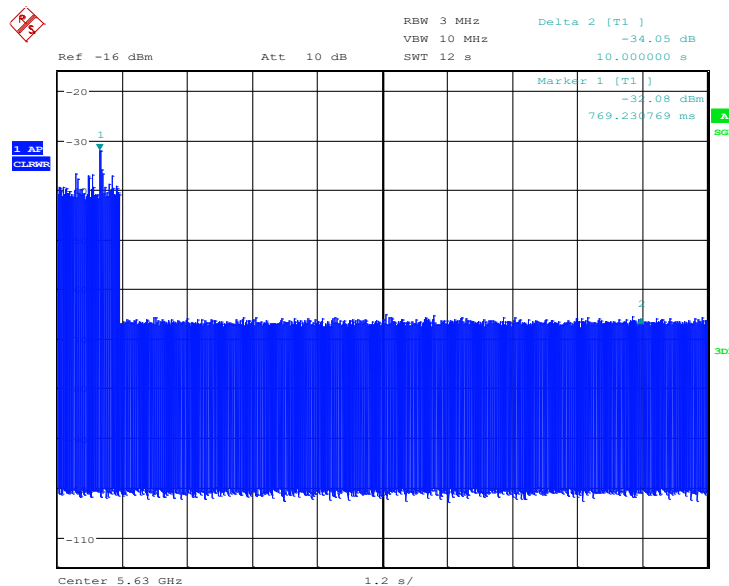

Date: 26.OCT.2019 16:29:44

Fig.A.6 Channel move time

The channel move time is as the figure. It shows the time of the radar and the client pulses. The figure shows that the client stops transmission within 10 seconds, and no transmissions occur after 10 seconds later of the radar burst signal.

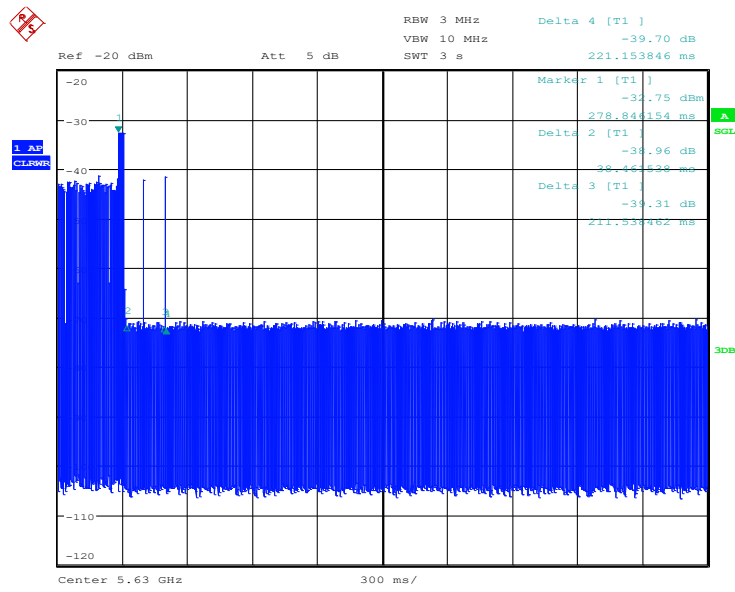

Date: 28.OCT.2019 09:30:50

Fig.A.7 Channel closing transmission time

The closing transmission time is as the figure, and the result $57.69\text{ms} = \text{Delta}2 + (\text{Delta}4 - \text{Delta}3) * 2$.

A.3.Non-Occupancy Period

Measurement Limit:

Test Items	Limit
Non-Occupancy Period	> 1800 s

A3.1 Associated test

Associate the master and client, transmit specified stream between the master and client; monitor the analyzer on the operating frequency to make sure no beacons have been transmitted for 1800 seconds.

Frequency Band: 5150MHz ~ 5350MHz

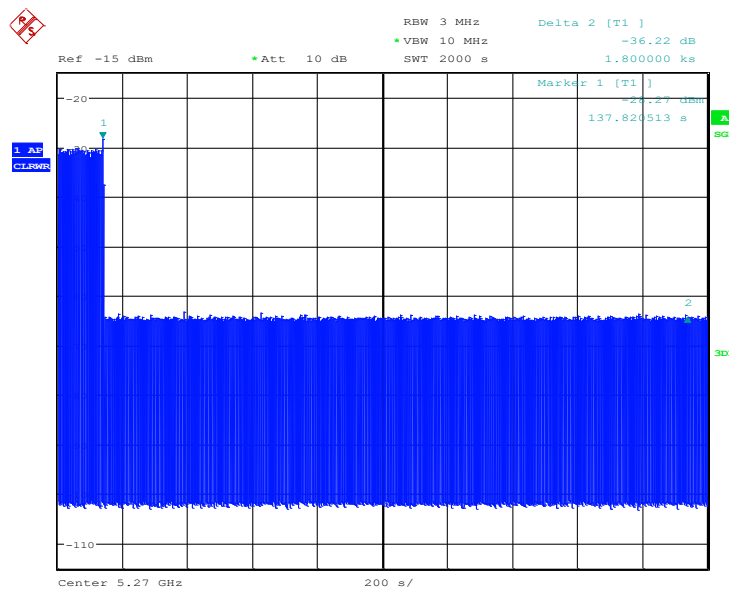

Date: 26.OCT.2019 11:25:58

Fig.A.8 Non-Occupancy Period

The figure above shows that the client does not transmit any emission within 1800 seconds after getting the order of “stop transmits” from the DFS master (access point).

Frequency Band: 5470MHz ~ 5725MHz

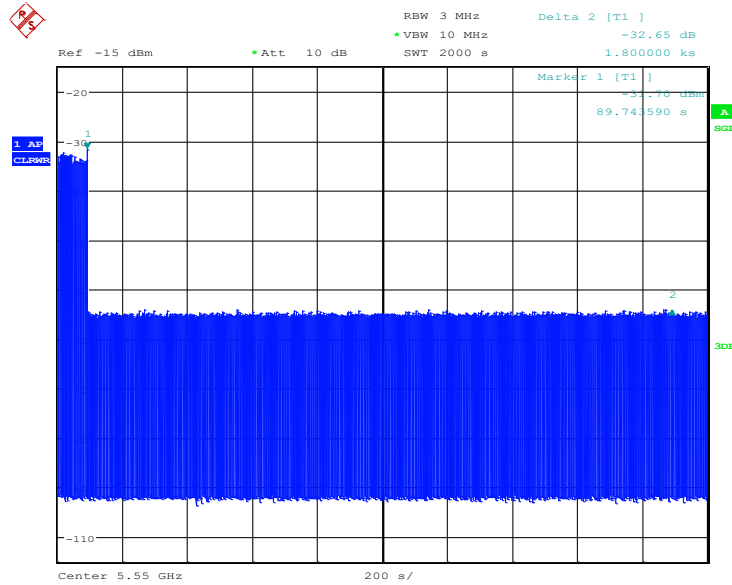

Date: 26.OCT.2019 12:48:50

Fig.A.9 Non-Occupancy Period

The figure above shows that the client does not transmit any emission within 1800 seconds after getting the order of “stop transmits” from the DFS master (access point).

Conclusion: PASS

ANNEX B: Accreditation Certificate

<p>United States Department of Commerce National Institute of Standards and Technology</p> 	
<hr/> <p>Certificate of Accreditation to ISO/IEC 17025:2005</p> <hr/>	
<p>NVLAP LAB CODE: 600118-0</p>	
<p>Telecommunication Technology Labs, CAICT Beijing China</p>	
<p><i>is accredited by the National Voluntary Laboratory Accreditation Program for specific services, listed on the Scope of Accreditation, for:</i></p>	
<p>Electromagnetic Compatibility & Telecommunications</p>	
<p><i>This laboratory is accredited in accordance with the recognized International Standard ISO/IEC 17025:2005. This accreditation demonstrates technical competence for a defined scope and the operation of a laboratory quality management system (refer to joint ISO-ILAC-IAF Communique dated January 2009).</i></p>	
<hr/> <p>2019-09-26 through 2020-09-30 <i>Effective Dates</i></p>	 <hr/> <p><i>[Signature]</i> For the National Voluntary Laboratory Accreditation Program</p>

*** END OF REPORT BODY ***