



# SAR TEST REPORT

No. I21Z70160-SEM02

For

**Samsung Electronics Co., Ltd.**

**Notebook PC**

**Model name: NP760XDA, NP762XDA**

With

**Hardware Version: REV1.0**

**Software Version: Windows10-Pro**

**FCC ID: ZCANP760XDA**

**Issued Date: 2021-6-2**

**Note:**

The test results in this test report relate only to the devices specified in this report. This report shall not be reproduced except in full without the written approval of CTTL.

The report must not be used by the client to claim product certification, approval, or endorsement by NVLAP, NIST, or any agency of the U.S.Government.

**Test Laboratory:**

CTTL, Telecommunication Technology Labs, CAICT

No. 51, Xueyuan Road, Haidian District, Beijing, P. R. China 100191.

Tel:+86(0)10-62304633-2512, Fax:+86(0)10-62304633-2504

Email: [ctl\\_terminals@caict.ac.cn](mailto:ctl_terminals@caict.ac.cn), website: [www.caict.ac.cn](http://www.caict.ac.cn)



## **REPORT HISTORY**

<b>Report Number</b>	<b>Revision</b>	<b>Issue Date</b>	<b>Description</b>
I21Z70160-SEM02	Rev.0	2021-6-2	Initial creation of test report

## TABLE OF CONTENT

<b>1 TEST LABORATORY</b> .....	<b>5</b>
1.1 TESTING LOCATION .....	5
1.2 TESTING ENVIRONMENT.....	5
1.3 PROJECT DATA .....	5
1.4 SIGNATURE.....	5
<b>2 STATEMENT OF COMPLIANCE</b> .....	<b>6</b>
<b>3 CLIENT INFORMATION</b> .....	<b>8</b>
3.1 APPLICANT INFORMATION .....	8
3.2 MANUFACTURER INFORMATION .....	8
<b>4 EQUIPMENT UNDER TEST (EUT) AND ANCILLARY EQUIPMENT (AE)</b> .....	<b>9</b>
4.1 ABOUT EUT.....	9
4.2INTERNAL IDENTIFICATION OF EUT USED DURING THE TEST.....	9
4.3 INTERNAL IDENTIFICATION OF AE USED DURING THE TEST .....	9
<b>5 TEST METHODOLOGY</b> .....	<b>10</b>
5.1 APPLICABLE LIMIT REGULATIONS.....	10
5.2 APPLICABLE MEASUREMENT STANDARDS .....	10
<b>6 SPECIFIC ABSORPTION RATE (SAR)</b> .....	<b>11</b>
6.1 INTRODUCTION.....	11
6.2 SAR DEFINITION.....	11
<b>7 TISSUE SIMULATING LIQUIDS</b> .....	<b>12</b>
7.1 TARGETS FOR TISSUE SIMULATING LIQUID.....	12
7.2 DIELECTRIC PERFORMANCE .....	12
<b>8 SYSTEM VERIFICATION</b> .....	<b>14</b>
8.1 SYSTEM SETUP.....	14
8.2 SYSTEM VERIFICATION.....	15
<b>9 MEASUREMENT PROCEDURES</b> .....	<b>16</b>
9.1 TESTS TO BE PERFORMED .....	16
9.2 GENERAL MEASUREMENT PROCEDURE.....	18
9.3 BLUETOOTH & WI-FI MEASUREMENT PROCEDURES FOR SAR .....	19
9.4 POWER DRIFT.....	19
<b>10 CONDUCTED OUTPUT POWER</b> .....	<b>20</b>
10.1 WI-FI AND BT MEASUREMENT RESULT .....	20
<b>11 SIMULTANEOUS TX SAR CONSIDERATIONS</b> .....	<b>23</b>
11.1 TRANSMIT ANTENNA SEPARATION DISTANCES.....	23
11.2 SAR MEASUREMENT POSITIONS .....	23



11.3 STANDALONE SAR TEST EXCLUSION CONSIDERATIONS .....	23
<b>12 EVALUATION OF SIMULTANEOUS.....</b>	<b>24</b>
<b>13 SAR TEST RESULT .....</b>	<b>25</b>
13.1 WLAN EVALUATION FOR 2.4G .....	26
13.2 WLAN EVALUATION FOR 5G.....	29
13.3 SAR RESULTS FOR BT .....	39
<b>14 SAR MEASUREMENT VARIABILITY.....</b>	<b>40</b>
<b>15 MEASUREMENT UNCERTAINTY .....</b>	<b>41</b>
15.1 MEASUREMENT UNCERTAINTY FOR NORMAL SAR TESTS (300MHZ~3GHZ).....	41
15.2 MEASUREMENT UNCERTAINTY FOR NORMAL SAR TESTS (3~6GHZ) .....	42
<b>16 MAIN TEST INSTRUMENTS.....</b>	<b>43</b>
<b>ANNEX A GRAPH RESULTS.....</b>	<b>44</b>
<b>ANNEX B SYSTEM VERIFICATION RESULTS .....</b>	<b>54</b>
<b>ANNEX C SAR MEASUREMENT SETUP .....</b>	<b>58</b>
<b>ANNEX D POSITION OF THE WIRELESS DEVICE IN RELATION TO THE PHANTOM .....</b>	<b>64</b>
<b>ANNEX E EQUIVALENT MEDIA RECIPES .....</b>	<b>65</b>
<b>ANNEX F SYSTEM VALIDATION .....</b>	<b>66</b>
<b>ANNEX G PROBE CALIBRATION CERTIFICATE.....</b>	<b>67</b>
<b>ANNEX H DIPOLE CALIBRATION CERTIFICATE .....</b>	<b>76</b>
<b>ANNEX I ACCREDITATION CERTIFICATE.....</b>	<b>107</b>

## 1 Test Laboratory

### 1.1 Testing Location

Company Name:	CTTL(Shouxiang)
Address:	No. 51 Shouxiang Science Building, Xueyuan Road, Haidian District, Beijing, P. R. China100191

### 1.2 Testing Environment

Temperature:	18°C~25°C,
Relative humidity:	30%~ 70%
Ground system resistance:	< 0.5 $\Omega$
Ambient noise & Reflection:	< 0.012 W/kg

### 1.3 Project Data

Project Leader:	Qi Dianyuan
Test Engineer:	Lin Xiaojun
Testing Start Date:	May 18, 2021
Testing End Date:	June 1, 2021

### 1.4 Signature



---

Lin Xiaojun  
(Prepared this test report)

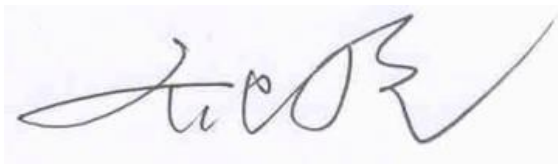

---

Qi Dianyuan  
(Reviewed this test report)

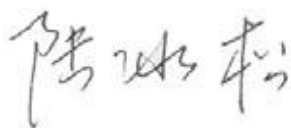

---

Lu Bingsong  
Deputy Director of the laboratory  
(Approved this test report)

## 2 Statement of Compliance

The maximum results of SAR found during testing for Samsung Electronics Co., Ltd. Notebook PC NP760XDA, NP762XDA are as follows:

**Table 2.1: Highest Reported SAR (1g)**

Exposure Configuration	Technology Band	Highest Reported SAR 1g(W/kg)	Equipment Class
Body	WLAN 2.4 GHz Main. Antenna	0.77	DTS
	WLAN 2.4 GHz Aux Antenna	0.71	
	WLAN 2.4 GHz MIMO Antenna	0.47	
	WLAN 5 GHz Main. Antenna	1.14	NII
	WLAN 5 GHz Aux Antenna	<b>1.16</b>	
	WLAN 5 GHz MIMO Antenna	0.54	
	BT	0.12	DSS

The SAR values found for the Mobile Phone are below the maximum recommended levels of 1.6 W/Kg as averaged over any 1g tissue according to the ANSI C95.1-1992.

For body operation, this device has been tested and meets FCC RF exposure guidelines when used with any accessory that contains no metal and which provides a minimum separation distance of 0mm between this device and the body of the user. Use of other accessories may not ensure compliance with FCC RF exposure guidelines.

The EUT battery must be fully charged and checked periodically during the test to ascertain uniform power output.

The measurement together with the test system set-up is described in annex C of this test report. A detailed description of the equipment under test can be found in chapter 4 of this test report. The highest reported SAR value is obtained at the case of (**Table 2.1**), and the values is: **Body SAR 1.16 W/kg (1g)**.

**Table 2.2: The sum of reported SAR values for WIFI2.4GHz (Main Antenna) and BT**

	Position	WIFI2.4GHz	BT	Sum
<b>Maximum reported SAR value for Body</b>	Rear 0mm	0.77	0.12	<b>0.89</b>

**Table 2.3: The sum of reported SAR values for WIFI5GHz (Aux Antenna) and BT**

	Position	WIFI5GHz	BT	Sum
<b>Maximum reported SAR value for Body</b>	Rear 0mm	1.16	0.12	<b>1.28</b>

**Table 2.4: The sum of reported SAR values for WIFI5GHz (MIMO Antenna) and BT**

	Position	WIFI5GHz	BT	Sum
<b>Maximum reported SAR value for Body</b>	Rear 0mm	0.54	0.12	<b>0.66</b>

According to the above tables, the highest sum of reported SAR values is **1.28 W/kg (1g)**. The detail for simultaneous transmission consideration is described in chapter 13.

### 3 Client Information

#### 3.1 Applicant Information

Company Name:	Samsung Electronics Co., Ltd.
Address/Post:	Samsung R5, Maetan dong 129, Samsung ro Youngtong gu, Suwon city 443 742, Korea
Contact Person:	Sunghoon Cho
E-mail:	ggobi.cho@samsung.com
Telephone:	+82-10-2722-4159
Fax:	/

#### 3.2 Manufacturer Information

Company Name:	Samsung Electronics Co., Ltd.
Address/Post:	Samsung R5, Maetan dong 129, Samsung ro Youngtong gu, Suwon city 443 742, Korea
Contact Person:	Sunghoon Cho
E-mail:	ggobi.cho@samsung.com
Telephone:	+82-10-2722-4159
Fax:	/



## 4 Equipment Under Test (EUT) and Ancillary Equipment (AE)

### 4.1 About EUT

Description:	Notebook PC
Model name:	NP760XDA, NP762XDA
Operating mode(s):	BT, Wi-Fi2.4G/5G
Tested Tx Frequency:	2412 – 2462 MHz (Wi-Fi 2.4G)
	5150-5825 MHz (Wi-Fi 5G)
	2400 – 2483.5 MHz (Bluetooth)
Test device Production information:	Production unit
Device type:	Portable device
Antenna type:	Integrated antenna

### 4.2 Internal Identification of EUT used during the test

EUT ID*	IMEI	HW	SW Version
EUT1	I21Z70160UT12a	REV1.0	Windows10-Pro
EUT2	I21Z70160UT23a	REV1.0	Windows10-Pro
EUT3	I21Z70160UT31a	REV1.0	Windows10-Pro
EUT4	I21Z70160UT11a	REV1.0	Windows10-Pro

\*EUT ID: is used to identify the test sample in the lab internally.

**Note:** It is performed to test SAR with the EUT1~3 and conducted power with the EUT4.

### 4.3 Internal Identification of AE used during the test

AE ID*	Description	Model	SN	Manufacturer
AE1	Battery	AA-PBAN6TI	/	SAMSUNG SDI CO., LTD

\*AE ID: is used to identify the test sample in the lab internally.

## 5 TEST METHODOLOGY

### 5.1 Applicable Limit Regulations

**ANSI C95.1–1992:**IEEE Standard for Safety Levels with Respect to Human Exposure to Radio Frequency Electromagnetic Fields, 3 kHz to 300 GHz.

It specifies the maximum exposure limit of **1.6 W/kg** as averaged over any 1 gram of tissue for portable devices being used within 20 cm of the user in the uncontrolled environment.

### 5.2 Applicable Measurement Standards

**IEEE 1528–2013:** Recommended Practice for Determining the Peak Spatial-Average Specific Absorption Rate (SAR) in the Human Head from Wireless Communications Devices: Measurement Techniques.

**KDB616217 D04 SAR for laptop and tablets v01r02** SAR Evaluation Considerations for Laptop, Notebook, Notebook and Tablet Computers.

**KDB648474 D04 Handset SAR v01r03:** SAR Evaluation Considerations for Wireless Handsets.

**KDB248227 D01 802.11 Wi-Fi SAR v02r02:** SAR GUIDANCE FOR IEEE 802.11 (Wi-Fi) TRANSMITTERS

**KDB865664 D01 SAR measurement 100 MHz to 6 GHz v01r04:** SAR Measurement Requirements for 100 MHz to 6 GHz.

**KDB865664 D02 RF Exposure Reporting v01r02:** RF Exposure Compliance Reporting and Documentation Considerations

## 6 Specific Absorption Rate (SAR)

### 6.1 Introduction

SAR is related to the rate at which energy is absorbed per unit mass in an object exposed to a radio field. The SAR distribution in a biological body is complicated and is usually carried out by experimental techniques or numerical modeling. The standard recommends limits for two tiers of groups, occupational/controlled and general population/uncontrolled, based on a person's awareness and ability to exercise control over his or her exposure. In general, occupational/controlled exposure limits are higher than the limits for general population/uncontrolled.

### 6.2 SAR Definition

The SAR definition is the time derivative (rate) of the incremental energy ( $dW$ ) absorbed by (dissipated in) an incremental mass ( $dm$ ) contained in a volume element ( $dv$ ) of a given density ( $\rho$ ). The equation description is as below:

$$SAR = \frac{d}{dt} \left( \frac{dW}{dm} \right) = \frac{d}{dt} \left( \frac{dW}{\rho dv} \right)$$

SAR is expressed in units of Watts per kilogram (W/kg)

SAR measurement can be either related to the temperature elevation in tissue by

$$SAR = c \left( \frac{\delta T}{\delta t} \right)$$

Where:  $C$  is the specific heat capacity,  $\delta T$  is the temperature rise and  $\delta t$  is the exposure duration, or related to the electrical field in the tissue by

$$SAR = \frac{\sigma |E|^2}{\rho}$$

Where:  $\sigma$  is the conductivity of the tissue,  $\rho$  is the mass density of tissue and  $E$  is the RMS electrical field strength.

However for evaluating SAR of low power transmitter, electrical field measurement is typically applied.

## 7 Tissue Simulating Liquids

### 7.1 Targets for tissue simulating liquid

**Table 7.1: Targets for tissue simulating liquid**

Frequency(MHz)	Liquid Type	Conductivity( $\sigma$ )	$\pm 10\%$ Range	Permittivity( $\epsilon$ )	$\pm 10\%$ Range
2450	Head	1.80	1.62~1.98	39.2	35.28~43.12

**Table 7.2: Targets for tissue simulating liquid**

Frequency(MHz)	Liquid Type	Conductivity( $\sigma$ )	$\pm 5\%$ Range	Permittivity( $\epsilon$ )	$\pm 5\%$ Range
5250	Head	4.71	4.47~4.95	35.93	34.13~37.73
5600	Head	5.07	4.82~5.32	35.53	33.8~37.3

### 7.2 Dielectric Performance

**Table 7.3: Dielectric Performance of Tissue Simulating Liquid**

Measurement Date (yyyy-mm-dd)	Type	Frequency	Permittivity $\epsilon$	Drift (%)	Conductivity $\sigma$ (S/m)	Drift (%)
2021-5-19	Head	2450 MHz	40.74	3.93	1.921	6.72
2021-5-18	Head	5250 MHz	34.78	-3.20	4.765	1.17
2021-5-18	Head	5600 MHz	34.09	-4.05	5.149	1.56
2021-6-1	Head	5750 MHz	33.98	-3.90	5.47	4.79

Note: The liquid temperature is 22.0°C

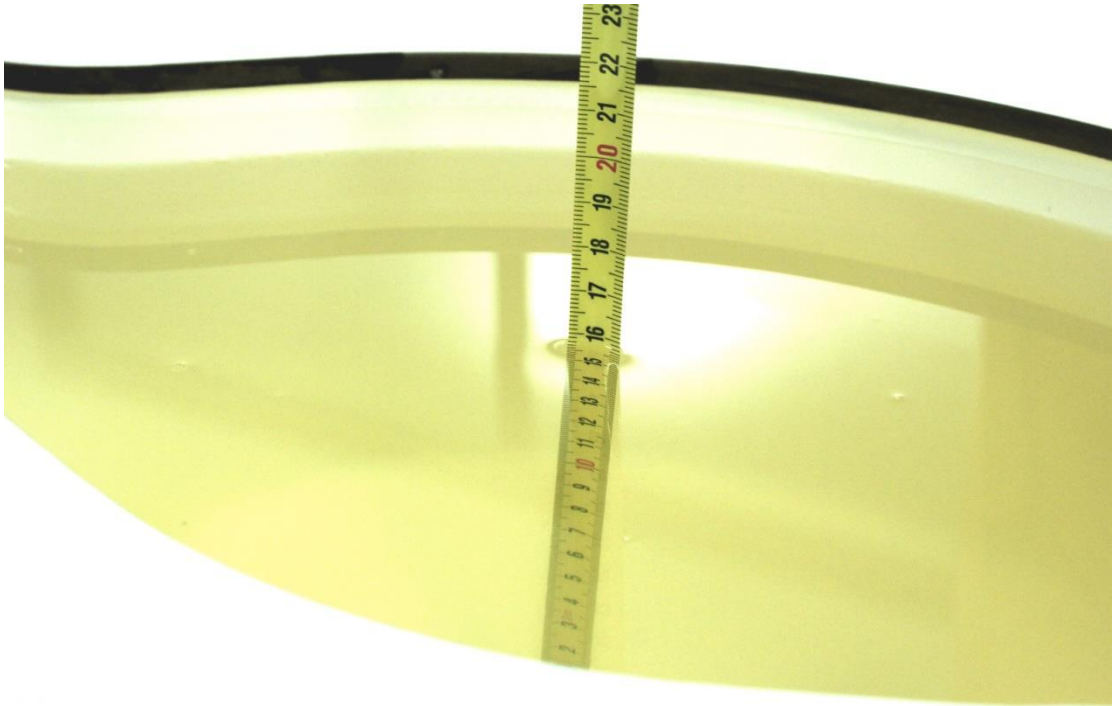

Picture 7-1 Liquid depth in the Flat Phantom (2450MHz)

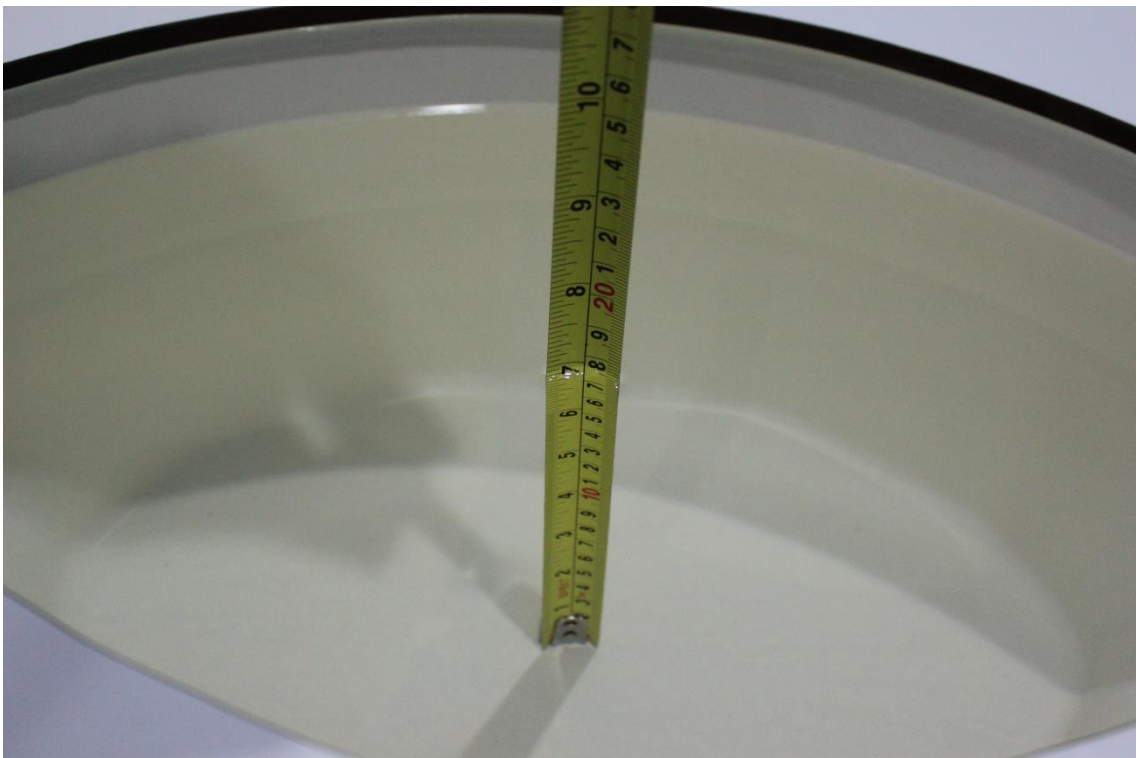

Picture 7-2 Liquid depth in the Flat Phantom (5GHz)

## 8 System verification

### 8.1 System Setup

In the simplified setup for system evaluation, the DUT is replaced by a calibrated dipole and the power source is replaced by a continuous wave that comes from a signal generator. The calibrated dipole must be placed beneath the flat phantom section of the SAM twin phantom with the correct distance holder. The distance holder should touch the phantom surface with a light pressure at the reference marking and be oriented parallel to the long side of the phantom. The equipment setup is shown below:

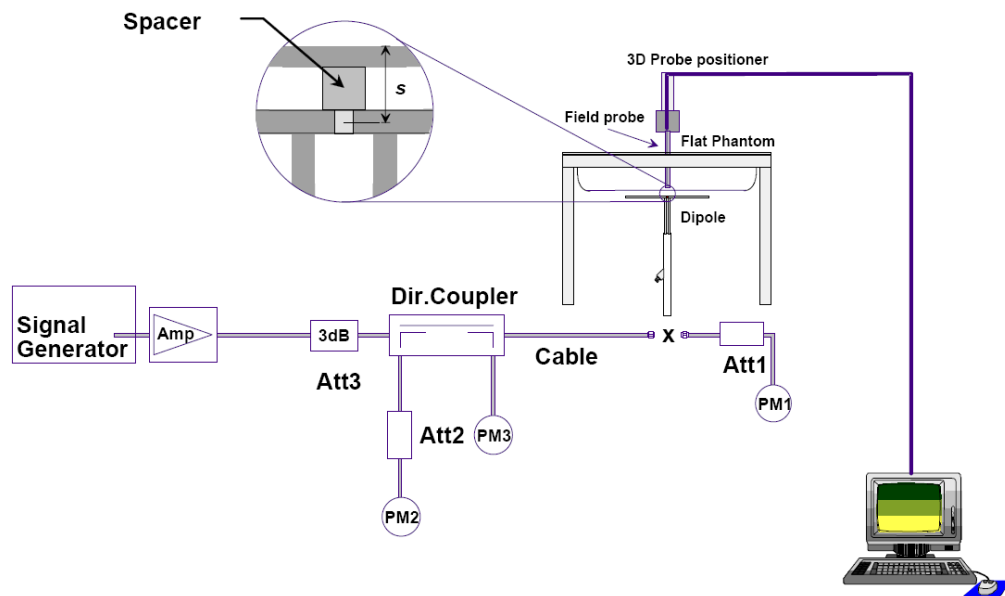

Picture 8.1 System Setup for System Evaluation



Picture 8.2 Photo of Dipole Setup

## 8.2 System Verification

SAR system verification is required to confirm measurement accuracy, according to the tissue dielectric media, probe calibration points and other system operating parameters required for measuring the SAR of a test device. The system verification must be performed for each frequency band and within the valid range of each probe calibration point required for testing the device.

**Table 8.1: System Verification of Head**

Measurement Date (yyyy-mm-dd)	Frequency	Target value (W/kg)		Measured value (W/kg)		Deviation	
		10 g Average	1 g Average	10 g Average	1 g Average	10 g Average	1 g Average
2021-5-19	2450 MHz	24.5	52.5	24.3	52.4	-0.73%	-0.19%
2021-5-18	5250 MHz	22.9	80.5	23.0	81.1	0.44%	0.75%
2021-5-18	5600 MHz	23.6	83.3	21.4	75.5	-9.32%	-9.36%
2021-6-1	5750 MHz	22.7	80.4	23.9	84.2	5.29%	4.73%

## 9 Measurement Procedures

### 9.1 Tests to be performed

In order to determine the highest value of the peak spatial-average SAR of a handset, all device positions, configurations and operational modes shall be tested for each frequency band according to steps 1 to 3 below. A flowchart of the test process is shown in picture 9.1.

**Step 1:** The tests described in 9.2 shall be performed at the channel that is closest to the centre of the transmit frequency band ( $f_c$ ) for:

- a) all device positions (cheek and tilt, for both left and right sides of the SAM phantom, as described in annex D),
- b) all configurations for each device position in a), e.g., antenna extended and retracted, and
- c) all operational modes, e.g., analogue and digital, for each device position in a) and configuration in b) in each frequency band.

If more than three frequencies need to be tested according to 11.1 (i.e.,  $N_c > 3$ ), then all frequencies, configurations and modes shall be tested for all of the above test conditions.

**Step 2:** For the condition providing highest peak spatial-average SAR determined in Step 1, perform all tests described in 9.2 at all other test frequencies, i.e., lowest and highest frequencies. In addition, for all other conditions (device position, configuration and operational mode) where the peak spatial-average SAR value determined in Step 1 is within 3 dB of the applicable SAR limit, it is recommended that all other test frequencies shall be tested as well.

**Step 3:** Examine all data to determine the highest value of the peak spatial-average SAR found in Steps 1 to 2.



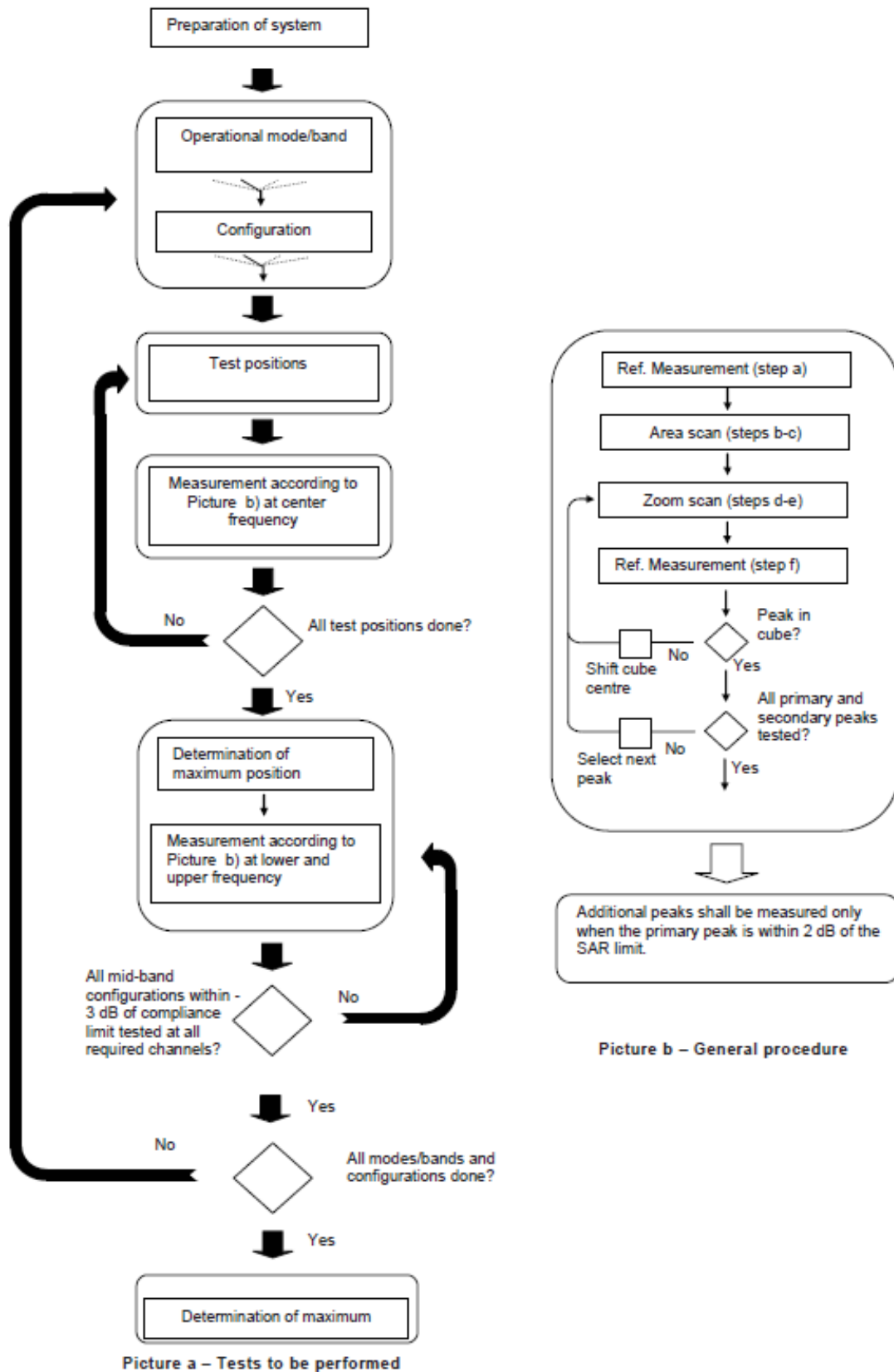

Picture 9.1 Block diagram of the tests to be performed

## 9.2 General Measurement Procedure

The area and zoom scan resolutions specified in the table below must be applied to the SAR measurements and fully documented in SAR reports to qualify for TCB approval. Probe boundary effect error compensation is required for measurements with the probe tip closer than half a probe tip diameter to the phantom surface. Both the probe tip diameter and sensor offset distance must satisfy measurement protocols; to ensure probe boundary effect errors are minimized and the higher fields closest to the phantom surface can be correctly measured and extrapolated to the phantom surface for computing 1-g SAR. Tolerances of the post-processing algorithms must be verified by the test laboratory for the scan resolutions used in the SAR measurements, according to the reference distribution functions specified in IEEE Std 1528-2013. The results should be documented as part of the system validation records and may be requested to support test results when all the measurement parameters in the following table are not satisfied.

		$\leq 3$ GHz	$> 3$ GHz
Maximum distance from closest measurement point (geometric center of probe sensors) to phantom surface		$5 \pm 1$ mm	$\frac{\delta}{2} \cdot \ln(2) \pm 0.5$ mm
Maximum probe angle from probe axis to phantom surface normal at the measurement location		$30^\circ \pm 1^\circ$	$20^\circ \pm 1^\circ$
Maximum area scan spatial resolution: $\Delta x_{Area}$ , $\Delta y_{Area}$		$\leq 2$ GHz: $\leq 15$ mm 2 – 3 GHz: $\leq 12$ mm	3 – 4 GHz: $\leq 12$ mm 4 – 6 GHz: $\leq 10$ mm
		When the x or y dimension of the test device, in the measurement plane orientation, is smaller than the above, the measurement resolution must be $\leq$ the corresponding x or y dimension of the test device with at least one measurement point on the test device.	
Maximum zoom scan spatial resolution: $\Delta x_{Zoom}$ , $\Delta y_{Zoom}$		$\leq 2$ GHz: $\leq 8$ mm 2 – 3 GHz: $\leq 5$ mm*	3 – 4 GHz: $\leq 5$ mm* 4 – 6 GHz: $\leq 4$ mm*
Maximum zoom scan spatial resolution, normal to phantom surface	uniform grid: $\Delta z_{Zoom}(n)$	$\leq 5$ mm	3 – 4 GHz: $\leq 4$ mm 4 – 5 GHz: $\leq 3$ mm 5 – 6 GHz: $\leq 2$ mm
	graded grid	$\Delta z_{Zoom}(1)$ : between 1 <sup>st</sup> two points closest to phantom surface	$\leq 4$ mm
		$\Delta z_{Zoom}(n>1)$ : between subsequent points	$\leq 1.5 \cdot \Delta z_{Zoom}(n-1)$
Minimum zoom scan volume	x, y, z	$\geq 30$ mm	3 – 4 GHz: $\geq 28$ mm 4 – 5 GHz: $\geq 25$ mm 5 – 6 GHz: $\geq 22$ mm
Note: $\delta$ is the penetration depth of a plane-wave at normal incidence to the tissue medium; see draft standard IEEE P1528-2011 for details. * When zoom scan is required and the <i>reported</i> SAR from the area scan based 1-g SAR estimation procedures of KDB 447498 is $\leq 1.4$ W/kg, $\leq 8$ mm, $\leq 7$ mm and $\leq 5$ mm zoom scan resolution may be applied, respectively, for 2 GHz to 3 GHz, 3 GHz to 4 GHz and 4 GHz to 6 GHz.			

### **9.3 Bluetooth & Wi-Fi Measurement Procedures for SAR**

Normal network operating configurations are not suitable for measuring the SAR of 802.11 transmitters in general. Unpredictable fluctuations in network traffic and antenna diversity conditions can introduce undesirable variations in SAR results. The SAR for these devices should be measured using chipset based test mode software to ensure that the results are consistent and reliable.

Chipset based test mode software is hardware dependent and generally varies among manufacturers. The device operating parameters established in a test mode for SAR measurements must be identical to those programmed in production units, including output power levels, amplifier gain settings and other RF performance tuning parameters. The test frequencies should correspond to actual channel frequencies defined for domestic use. SAR for devices with switched diversity should be measured with only one antenna transmitting at a time during each SAR measurement, according to a fixed modulation and data rate. The same data pattern should be used for all measurements.

### **9.4 Power Drift**

To control the output power stability during the SAR test, DASY5 system calculates the power drift by measuring the E-field at the same location at the beginning and at the end of the measurement for each test position. These drift values can be found in section 14 labeled as: (Power Drift [dB]). This ensures that the power drift during one measurement is within 5%.

## 10 Conducted Output Power

### 10.1 Wi-Fi and BT Measurement result

The maximum output power of BT antenna is 10.4dBm.

The maximum tune up of BT antenna is 10.5dBm.

Main Antenna WIFI 2.4G conducted power:

802.11b	Channeldata	1Mbps	2Mbps	5.5Mbps	11Mbps				
WLAN2450	11(2462MHz)	16.70							
	6(2437(MHz)	16.90	16.84	16.74	16.59				
	1(2412MHz)	16.77							
	Tune up	17.00	17.00	17.00	17.00				
802.11g	Channeldata	6Mbps	9Mbps	12Mbps	18Mbps	24Mbps	36Mbps	48Mbps	54Mbps
WLAN2450	11(2462MHz)	14.57		14.91					
	Tune up	16.00		15.00					
	6(2437(MHz)	16.64	16.49	16.72	16.62	16.48	16.17	15.93	15.91
	Tune up	17.00	17.00	17.00	17.00	17.00	17.00	16.00	16.00
	1(2412MHz)	14.64		15.22					
	Tune up	16.00		17.00					
802.11n-20MHz	Channeldata	MCS0	MCS1	MCS2	MCS3	MCS4	MCS5	MCS6	MCS7
WLAN2450	11(2462MHz)	14.46			14.72				
	Tune up	16.00			16.00				
	6(2437(MHz)	16.55	16.87	16.90	16.97	16.86	16.85	16.91	16.90
	Tune up	17.00	17.00	17.00	17.00	17.00	17.00	17.00	17.00
	1(2412MHz)	14.65			14.94				
	Tune up	16.00			16.00				
802.11n-40MHz	Channeldata	MCS0	MCS1	MCS2	MCS3	MCS4	MCS5	MCS6	MCS7
WLAN2450	9(2452MHz)	12.83							
	Tune up	14.00							
	6(2437MHz)	16.71	16.65	16.66	16.70	16.68	16.67	16.70	16.69
	Tune up	17.00	17.00	17.00	17.00	17.00	17.00	17.00	17.00
	3(2422MHz)	12.91							
	Tune up	14.00							
802.11ax-20MHz	Channeldata	MCS0	MCS1	MCS2	MCS3	MCS4	MCS5	MCS6	MCS7
WLAN2450	11(2462MHz)	14.31			14.45				
	Tune up	16.00			16.00				
	6(2437(MHz)	16.42	16.75	16.78	16.88	16.76	16.78	16.83	16.80
	Tune up	17.00	17.00	17.00	17.00	17.00	17.00	17.00	17.00
	1(2412MHz)	14.63			14.83				
	Tune up	16.00			16.00				
802.11ax-40MHz	Channeldata	MCS0	MCS1	MCS2	MCS3	MCS4	MCS5	MCS6	MCS7
WLAN2450	9(2452MHz)	12.61			12.93				
	Tune up	14.00							
	6(2437MHz)	16.37	16.44	16.38	16.57	16.56	16.55	16.58	16.57
	Tune up	17.00	17.00	17.00	17.00	17.00	17.00	17.00	17.00
	3(2422MHz)	12.58			13.18				
	Tune up	14.00							



Aux. Antenna WIFI 2.4G conducted power:

802.11b	Channel\data	1Mbps	2Mbps	5.5Mbps	11Mbps				
WLAN2450	11(2462MHz)	15.90	15.83	15.69	15.63				
	6(2437(MHz)	15.69							
	1(2412MHz)	16.02							
	tune up	17.00	17.00	17.00	17.00				
802.11g	Channel\data	6Mbps	9Mbps	12Mbps	18Mbps	24Mbps	36Mbps	48Mbps	54Mbps
WLAN2450	11(2462MHz)	14.53							
	tune up	16.00							
	6(2437(MHz)	15.58	15.47	15.54	15.49	15.33	14.92	14.62	14.57
	tune up	17.00	17.00	17.00	17.00	17.00	16.00	16.00	16.00
	1(2412MHz)	14.61							
tune up	16.00								
802.11n-20MHz	Channel\data	MCS0	MCS1	MCS2	MCS3	MCS4	MCS5	MCS6	MCS7
WLAN2450	11(2462MHz)	14.49			14.87				
	tune up	16.00							
	6(2437(MHz)	15.48	15.74	15.82	15.91	15.77	15.74	15.81	15.75
	tune up	17.00	17.00	17.00	17.00	17.00	17.00	17.00	17.00
	1(2412MHz)	14.47			14.80				
tune up	16.00								
802.11n-40MHz	Channel\data	MCS0	MCS1	MCS2	MCS3	MCS4	MCS5	MCS6	MCS7
WLAN2450	9(2452MHz)	13.32				13.55			
	tune up	14.00				14.00			
	6(2437MHz)	15.90	15.96	15.92	15.90	16.00	15.94	15.97	15.96
	tune up	17.00	17.00	17.00	17.00	17.00	17.00	17.00	17.00
	3(2422MHz)	13.19				13.61			
tune up	14.00				14.00				
802.11ax-20MHz	Channel\data	MCS0	MCS1	MCS2	MCS3	MCS4	MCS5	MCS6	MCS7
WLAN2450	11(2462MHz)	14.72							15.04
	tune up	16.00							17.00
	6(2437(MHz)	15.55	15.87	15.93	15.95	15.94	15.97	16.00	16.03
	tune up	17.00	17.00	17.00	17.00	17.00	17.00	17.00	17.00
	1(2412MHz)	14.67							15.08
tune up	16.00							17.00	
802.11ax-40MHz	Channel\data	MCS0	MCS1	MCS2	MCS3	MCS4	MCS5	MCS6	MCS7
WLAN2450	9(2452MHz)	13.07							13.16
	tune up	14.00							14.00
	6(2437MHz)	15.65	15.66	15.63	15.85	15.88	15.89	15.94	15.95
	tune up	17.00	17.00	17.00	17.00	17.00	17.00	17.00	17.00
	3(2422MHz)	12.02							13.26
tune up	14.00							14.00	

MIMO WIFI2.4G conducted power:

802.11g	Channel\data	6Mbps	9Mbps	12Mbps	18Mbps	24Mbps	36Mbps	48Mbps	54Mbps
WLAN2450	11(2462MHz)	16.68		16.89					
	tune up	17.50		17.50					
	6(2437(MHz)	16.82	16.77	17.05	17.01	16.97	16.75	16.63	16.62
	tune up	17.50	17.50	17.50	17.50	17.50	17.50	17.50	17.50
	1(2412MHz)	16.79		17.00					
tune up	17.50		17.50						
802.11n-20MHz	Channel\data	MCS0	MCS1	MCS2	MCS3	MCS4	MCS5	MCS6	MCS7
WLAN2450	11(2462MHz)	16.61							
	tune up	17.50							
	6(2437(MHz)	17.02	16.98	17.02	17.01	17.01	17.00	17.05	17.03
	tune up	17.50	17.50	17.50	17.50	17.50	17.50	17.50	17.50
	1(2412MHz)	16.72							
tune up	17.50								
802.11n-40MHz	Channel\data	MCS0	MCS1	MCS2	MCS3	MCS4	MCS5	MCS6	MCS7
WLAN2450	9(2452MHz)	16.49							16.82
	tune up	17.50							17.50
	6(2437MHz)	16.58	16.84	16.90	16.95	16.87	16.89	16.92	16.99
	tune up	17.50	17.50	17.50	17.50	17.50	17.50	17.50	17.50
	3(2422MHz)	16.53							16.91
tune up	17.50							17.50	
802.11ax-20MHz	Channel\data	MCS0	MCS1	MCS2	MCS3	MCS4	MCS5	MCS6	MCS7
WLAN2450	11(2462MHz)	16.89		17.09					
	tune up	17.50		17.50					
	6(2437(MHz)	16.81		17.05					
	tune up	17.50		17.50					
	1(2412MHz)	16.88	17.15	17.17	17.10	16.93	16.82	16.80	16.78
tune up	17.50	17.50	17.50	17.50	17.50	17.50	17.50	17.50	
802.11ax-40MHz	Channel\data	MCS0	MCS1	MCS2	MCS3	MCS4	MCS5	MCS6	MCS7
WLAN2450	9(2452MHz)	16.70	16.73	16.77	16.94	16.89	16.88	16.89	16.86
	tune up	17.50			17.50				
	6(2437MHz)	16.64			16.91				
	tune up	17.50			17.50				
	3(2422MHz)	16.55			16.33				
tune up	17.50	17.50	17.50	17.50	17.50	17.50	17.50	17.50	



Main Antenna WIFI 5G conducted power:

802.11ac(dBm)-160MHz										
Channel\data rate	MCS0	MCS1	MCS2	MCS3	MCS4	MCS5	MCS6	MCS7	MCS8	MCS9
50(5250 MHz)	<b>13.02</b>	12.89	12.81	12.77	12.76	12.69	12.65	12.64	12.60	12.57
Tune up	15.00	14.00	14.00	14.00	14.00	14.00	14.00	14.00	14.00	14.00
114(5570 MHz)	<b>13.85</b>	13.74	13.69	13.64	13.63	13.61	13.59	13.54	13.47	13.46
Tune up	15.00	14.00	14.00	14.00	14.00	14.00	14.00	14.00	14.00	14.00

802.11ac(dBm)-80MHz										
Channel\data rate	MCS0	MCS1	MCS2	MCS3	MCS4	MCS5	MCS6	MCS7	MCS8	MCS9
42(5210 MHz)	<b>11.09</b>	11.00	11.00	11.08	11.06	11.04	11.06	11.03	11.06	11.07
155(5775 MHz)	<b>12.08</b>	11.97	12.07	12.02	12.04	12.01	12.05	12.08	11.93	11.92
Tune up	13	13	13	13	13	13	13	13	13	13

Aux. Antenna WIFI 5G conducted power:

802.11ac(dBm)-160MHz										
Channel\data rate	MCS0	MCS1	MCS2	MCS3	MCS4	MCS5	MCS6	MCS7	MCS8	MCS9
50(5250 MHz)	13.57	13.47	13.43	13.37	13.35	13.29	13.28	13.27	13.24	13.20
Tune up	15.00	14.00	14.00	14.00	14.00	14.00	14.00	14.00	14.00	14.00
114(5570 MHz)	<b>14.29</b>	14.16	14.05	13.99	13.96	13.94	13.93	13.90	13.89	13.77
Tune up	15.00	15.00	15.00	14.00	14.00	14.00	14.00	14.00	14.00	14.00

802.11ac(dBm)-80MHz										
Channel\data rate	MCS0	MCS1	MCS2	MCS3	MCS4	MCS5	MCS6	MCS7	MCS8	MCS9
42(5210 MHz)	<b>11.22</b>	11.20	11.21	11.21	11.17	11.13	11.17	11.19	11.16	11.17
155(5775 MHz)	<b>12.14</b>	12.12	12.11	12.09	12.08	12.10	12.11	12.12	12.02	11.98
Tune up	13	13	13	13	13	13	13	13	13	13

MIMO WIFI5G conducted power:

802.11ac(dBm)-160MHz MIMO										
Channel\data rate	MCS0	MCS1	MCS2	MCS3	MCS4	MCS5	MCS6	MCS7	MCS8	MCS9
50(5250 MHz)	<b>12.82</b>	12.63	12.60	12.60	12.54	12.47	12.44	12.38	12.27	12.22
Tune up	14.00	14.00	14.00	14.00	14.00	13.00	13.00	13.00	13.00	13.00
114(5570 MHz)	<b>13.73</b>	13.49	13.42	13.39	13.31	13.27	13.23	13.18	13.12	13.07
Tune up	14.00	14.00	14.00	14.00	14.00	14.00	14.00	14.00	14.00	14.00

802.11ac(dBm)-80MHz										
Channel\data rate	MCS0	MCS1	MCS2	MCS3	MCS4	MCS5	MCS6	MCS7	MCS8	MCS9
42(5210 MHz)	<b>11.25</b>	11.11	11.09	11.16	11.16	11.17	11.15	11.18	11.15	11.16
155(5775 MHz)	<b>12.09</b>	12.04	12.07	12.05	12.06	12.04	12.05	12.04	12.00	12.00
Tune up	13	13	13	13	13	13	13	13	13	13

## 11 Simultaneous TX SAR Considerations

### 11.1 Transmit Antenna Separation Distances

Please refer to the picture of antenna locations in the document: “The Photos of SAR test-I21Z70160”

### 11.2 SAR Measurement Positions

According to the KDB616217 D04, the edges with less than 2.5 cm distance to the antennas need to be tested for SAR.

SAR measurement positions						
Mode	Front	Rear	Left edge	Right edge	Top edge	Bottom edge
WLAN	Yes	Yes	No	No	No	No

### 11.3 Standalone SAR Test Exclusion Considerations

Standalone 1-g head or body SAR evaluation by measurement or numerical simulation is not required when the corresponding SAR Exclusion Threshold condition, listed below, is satisfied. The 1-g SAR test exclusion threshold for 100 MHz to 6 GHz at test separation distances  $\leq 50$  mm are determined by:

$[(\text{max. power of channel, including tune-up tolerance, mW}) / (\text{min. test separation distance, mm})] \cdot [\sqrt{f(\text{GHz})}] \leq 3.0$  for 1-g SAR, where

- $f(\text{GHz})$  is the RF channel transmit frequency in GHz
- Power and distance are rounded to the nearest mW and mm before calculation
- The result is rounded to one decimal place for comparison

**Table 11.1: Standalone SAR test exclusion considerations**

Band/Mode	F(GHz)	Position	SAR test exclusion threshold(mW)	RF output power		SAR test exclusion
				dBm	mW	
Bluetooth	2.441	Body	19.20	10.5	11.22	Yes
2.4GHz WLAN	2.45	Body	19.17	17.5	56.23	No
5GHz WLAN	5.2	Body	13.16	15	31.62	No
	5.3	Body	13.03	15	31.62	No
	5.6	Body	13.03	15	31.62	No
	5.8	Body	13.03	15	31.62	No

## 12 Evaluation of Simultaneous

**Table 12.1: The sum of reported SAR values for WIFI2.4GHz (Main Antenna) and BT**

	Position	WIFI2.4GHz	BT	Sum
<b>Maximum reported SAR value for Body</b>	Rear 0mm	0.77	0.12	<b>0.89</b>

**Table 12.2: The sum of reported SAR values for WIFI5GHz (Aux Antenna) and BT**

	Position	WIFI5GHz	BT	Sum
<b>Maximum reported SAR value for Body</b>	Rear 0mm	1.16	0.12	<b>1.28</b>

**Table 12.3: The sum of reported SAR values for WIFI5GHz (MIMO Antenna) and BT**

	Position	WIFI5GHz	BT	Sum
<b>Maximum reported SAR value for Body</b>	Rear 0mm	0.54	0.12	<b>0.66</b>

### Conclusion:

According to the above tables, the sum of reported SAR values is <math>1.6\text{W/kg}</math>. So the simultaneous transmission SAR with volume scans is not required.



### 13 SAR Test Result

It is determined by user manual for the distance between the EUT and the phantom bottom.  
The distance are 0mm, and just applied to the condition of body worn accessory.

The calculated SAR is obtained by the following formula:

$$\text{Reported SAR} = \text{Measured SAR} \times 10^{(P_{\text{Target}} - P_{\text{Measured}})/10}$$

Where  $P_{\text{Target}}$  is the power of manufacturing upper limit;

$P_{\text{Measured}}$  is the measured power in chapter 11.

### 13.1 WLAN Evaluation for 2.4G

Note: SKU1,SKU2 and SKU3 are different SKUs with different configurations or different suppliers; SKU1 is the highest configuration, and it is used for full testing, and others do the spot check in the highest value point of SKU1.

Main antenna:

**Table 13.1-1: SAR Values (WiFi 802.11b – Body)**

Ambient Temperature: 23.1 °C					Liquid Temperature: 22.2 °C					
Frequency		Test Position	Figure No./ Note	Conducted Power (dBm)	Max. tune-up Power (dBm)	Measured SAR(10g) (W/kg)	Reported SAR(10g) (W/kg)	Measured SAR(1g) (W/kg)	Reported SAR(1g)(W/kg)	Power Drift (dB)
MHz	Ch.									
2437	6	Front	/	16.90	17.00	0.108	<b>0.11</b>	0.231	<b>0.24</b>	0.13
2462	11	Rear	/	16.70	17.00	0.310	<b>0.33</b>	0.721	<b>0.77</b>	0.09
2437	6	Rear	Fig.1	16.90	17.00	0.322	<b>0.33</b>	0.753	<b>0.77</b>	0.13
2412	1	Rear	/	16.77	17.00	0.276	<b>0.29</b>	0.637	<b>0.67</b>	0.00

Note: The distance between the EUT and the phantom bottom is 0mm.

According to the KDB248227 D01, The reported SAR must be scaled to 100% transmission duty factor to determine compliance at the maximum tune-up tolerance limit. The scaled reported SAR is presented as below.

**Table 13.1-2: SAR Values (WLAN - Body) – 802.11b (Scaled Reported SAR)**

Ambient Temperature: 23.1 °C			Liquid Temperature: 22.2 °C			
Frequency		Test Position	Actual duty factor	maximum duty factor	Reported SAR (1g)(W/kg)	Scaled reported SAR (1g)(W/kg)
MHz	Ch.					
2437	6	Rear	100%	100%	<b>0.77</b>	<b>0.77</b>

SAR is not required for OFDM because the 802.11b adjusted SAR  $\leq$  1.2 W/kg.

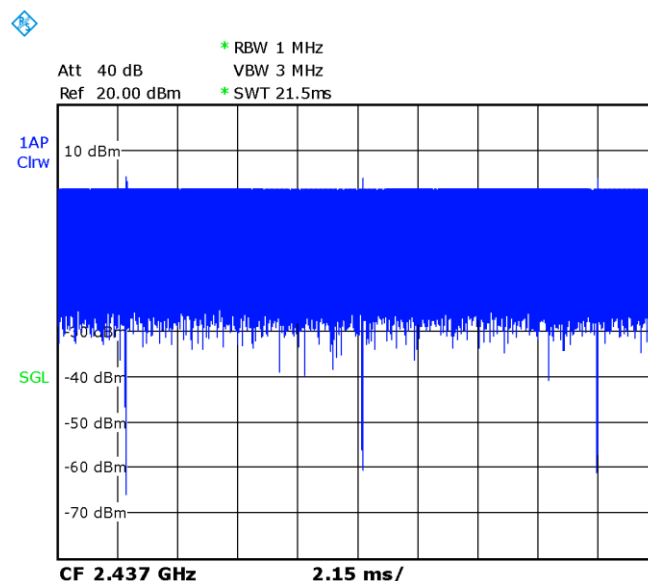

**Picture 13.1 Duty factor plot for 2.4G**

Aux. antenna:

**Table 13.1-3: SAR Values (WiFi 802.11b – Body)**

Frequency		Test Position	Figure No./ Note	Conducted Power (dBm)	Max. tune-up Power (dBm)	Ambient Temperature: 23.1 °C		Liquid Temperature: 22.2°C		Power Drift (dB)
MHz	Ch.					Measured SAR(10g) (W/kg)	Reported SAR(10g) (W/kg)	Measured SAR(1g) (W/kg)	Reported SAR(1g) (W/kg)	
2412	1	Front	/	16.02	17.00	0.083	<b>0.10</b>	0.169	<b>0.21</b>	-0.17
2462	11	Rear	/	15.90	17.00	0.201	<b>0.26</b>	0.484	<b>0.62</b>	0.15
2437	6	Rear	/	15.69	17.00	0.194	<b>0.26</b>	0.459	<b>0.62</b>	-0.07
2412	1	Rear	Fig.2	16.02	17.00	0.226	<b>0.28</b>	0.564	<b>0.71</b>	-0.14

Note: The distance between the EUT and the phantom bottom is 0mm.

According to the KDB248227 D01, The reported SAR must be scaled to 100% transmission duty factor to determine compliance at the maximum tune-up tolerance limit. The scaled reported SAR is presented as below.

**Table 13.1-4: SAR Values (WLAN - Body) – 802.11b (Scaled Reported SAR)**

Frequency		Test Position	Actual duty factor	maximum duty factor	Ambient Temperature: 23.1 °C		Liquid Temperature: 22.2°C	
MHz	Ch.				Reported SAR (1g)(W/kg)	Scaled reported SAR (1g)(W/kg)		
2412	1	Rear	99.43%	100%	<b>0.71</b>	<b>0.71</b>		

SAR is not required for OFDM because the 802.11b adjusted SAR  $\leq$  1.2 W/kg.

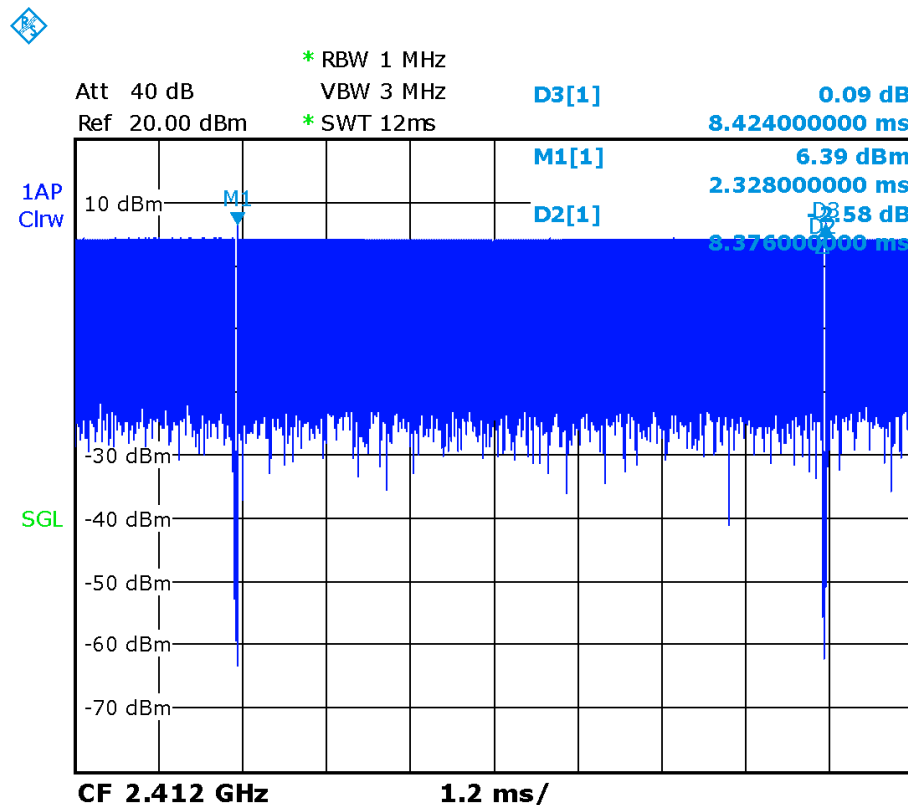
**Picture 13.2 Duty factor plot for 2.4G**

**MIMO**
**Table 13.1-5: SAR Values (WiFi 802.11n-20M – Body)**

Frequency		Test Position	Figure No./ Note	Ambient Temperature: 23.1 °C		Liquid Temperature: 22.2°C		Reported SAR(1g) (W/kg)	Reported SAR(1g)( W/kg)	Power Drift (dB)
MHz	Ch.			Conducted Power (dBm)	Max. tune-up Power (dBm)	Measured SAR(10g) (W/kg)	Measured SAR(1g) (W/kg)			
2437	6	Front	/	17.02	17.50	0.040	<b>0.04</b>	0.081	<b>0.09</b>	0.13
2462	11	Rear	/	16.61	17.50	0.116	<b>0.14</b>	0.249	<b>0.31</b>	0.02
2437	6	Rear	Fig.3	17.02	17.50	0.178	<b>0.20</b>	0.416	<b>0.46</b>	-0.04
2412	1	Rear	/	16.72	17.50	0.084	<b>0.10</b>	0.182	<b>0.22</b>	0.18

Note: The distance between the EUT and the phantom bottom is 0mm.

According to the KDB248227 D01, The reported SAR must be scaled to 100% transmission duty factor to determine compliance at the maximum tune-up tolerance limit. The scaled reported SAR is presented as below.

**Table 13.1-6: SAR Values (WLAN - Body) – 802.11b (Scaled Reported SAR)**

Frequency		Test Position	Ambient Temperature: 23.1 °C		Liquid Temperature: 22.2°C	
MHz	Ch.		Actual duty factor	maximum duty factor	Reported SAR (1g)(W/kg)	Scaled reported SAR (1g)(W/kg)
2437	6	Rear	98.92%	100%	<b>0.46</b>	<b>0.47</b>

SAR is not required for OFDM because the 802.11b adjusted SAR  $\leq$  1.2 W/kg.

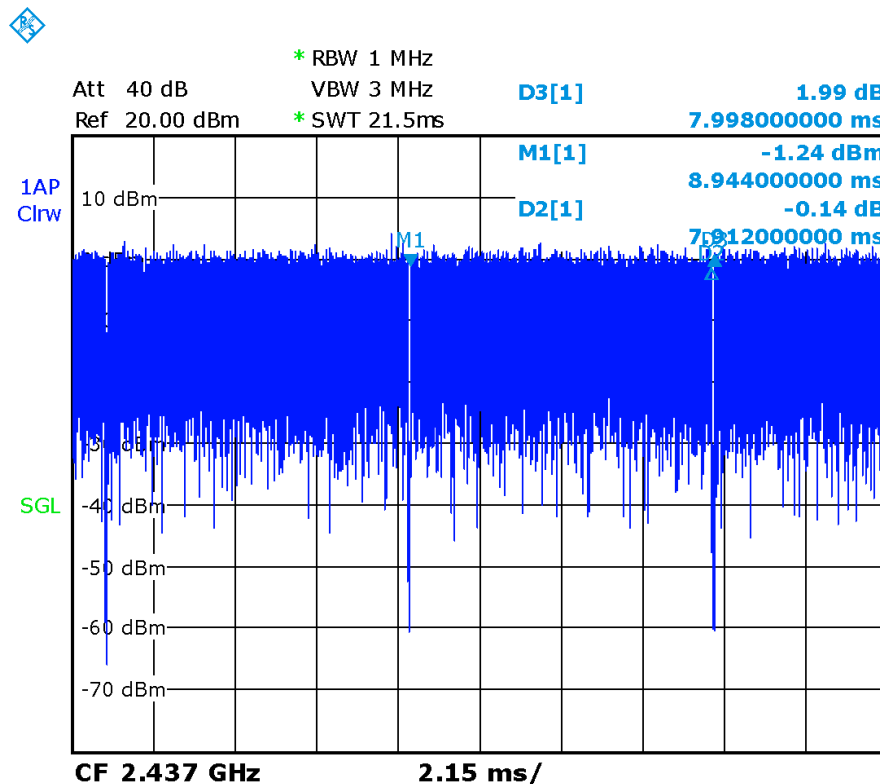
**Picture 13.3 Duty factor plot for 2.4G**

### 13.2 WLAN Evaluation For 5G

**Table 13.2-1: OFDM mode specified maximum output power of WLAN Main/Aux antenna**

802.11 mode	a	g	n		ac				ax			
Ch. BW(MHz)	20	20	20	40	20	40	80	160	20	40	80	160
U-NII-1	X		X	X	X	X	X		X	X	X	
U-NII-2A	X		X	X	X	X	X	X	X	X	X	X
U-NII-2C	X		X	X	X	X	X	X	X	X	X	X
U-NII-3	X		X	X	X	X	X		X	X	X	
§ 15.247 (5.8 GHz)												

X: maximum(conducted) output power(mW), including tolerance, specified for production units

**Table 13.2-1: OFDM mode specified maximum output power of WLAN MIMO antenna**

802.11 mode	a	g	n		ac				ax			
Ch. BW(MHz)	20	20	20	40	20	40	80	160	20	40	80	160
U-NII-1			X	X	X	X	X		X	X	X	
U-NII-2A			X	X	X	X	X	X	X	X	X	X
U-NII-2C			X	X	X	X	X	X	X	X	X	X
U-NII-3			X	X	X	X	X		X	X	X	
§ 15.247 (5.8 GHz)												

X: maximum(conducted) output power(mW), including tolerance, specified for production units

**Table 13.2-3: Maximum output power specified of WLAN Main/Aux antenna**

802.11 mode	a	g	n		ac				ax			
Ch. BW(MHz)	20	20	20	20	20	40	80	160	20	40	80	160
U-NII-1	20	20	20	20	20	20	20		20	20	20	
U-NII-2A	32	32	32	32	32	32	32	32	32	32	32	32
U-NII-2C	32	32	32	32	32	32	32	32	32	32	32	32
U-NII-3	20	20	20	20	20	20	20		20	20	20	
§ 15.247 (5.8 GHz)												

- The maximum output power specified for production units is the same for all channels, modulations and data rates in each channel bandwidth configuration of the 802.11a/g/n/ac modes.
- The blue highlighted cells represent highest output configurations in each standalone or aggregated frequency band, with tune-up tolerance included.

**Table 13.2-4: Maximum output power specified of WLAN MIMO antenna**

802.11 mode	a	g	n		ac				ax			
Ch. BW(MHz)	20	20	20	20	20	40	80	160	20	40	80	160
U-NII-1		20	20	20	20	20	20		20	20	20	
U-NII-2A		25	25	25	25	25	25	25	25	25	25	25
U-NII-2C		25	25	25	25	25	25	25	25	25	25	25
U-NII-3		20	20	20	20	20	20		20	20	20	
§ 15.247 (5.8 GHz)												

- The maximum output power specified for production units is the same for all channels, modulations and data rates in each channel bandwidth configuration of the 802.11a/g/n/ac modes.
- The blue highlighted cells represent highest output configurations in each standalone or aggregated frequency band, with tune-up tolerance included.

**Table 13.2-5: Maximum output power measured of WLAN antenna, for the applicable OFDM configurations according to the default power measurement procedures for selection initial test configurations – Main antenna**

802.11 mode	a	n		ac				ax			
BW(MHz)	20	20	40	20	40	80	160	20	40	80	160
U-NII-1	36/40/44/48 Lower power	36/40/44/48 Lower power	38/46 Lower power	36/40/44/48 Lower power	38/46 Lower power	42 13	/	36/40/44/48 Lower power	38/46 Lower power	42 Lower power	/
U-NII-2A	52/56/60/64 Lower power	52/56/60/64 Lower power	54/62 Lower power	52/56/60/64 Lower power	54/62 Lower power	58 Lower power	50 20	52/56/60/64 Lower power	54/62 Lower power	58 Lower power	50 Lower power
U-NII-2C	100/104/108/112/116/120/124/128/132/136/140/144 Lower power	100/104/108/112/116/140 Lower power	102/110/134 Lower power	100/104/108/112/116/132/134/140 Lower power	102/110/134 Lower power	106 Lower power	114 24	100/104/108/112/116/132/134/140 Lower power	102/110/134 Lower power	106 Lower power	114 Lower power
U-NII-3	149/153/157/161/165 Lower power	149/153/165 Lower power	151/159 Lower power	149/153/157/161/165 Lower power	151/159 Lower power	155 16	/	149/153/157/161/165 Lower power	151/159 Lower power	155 Lower power	/

		power									
<ul style="list-style-type: none"> <li>● The <b>bold numbers</b> is the maximum output measured power (mW).</li> <li>● Channels with measured maximum power within 0.25dB are considered to have the same measured output.</li> <li>● Channels selected for initial test configuration are <b>highlighted in yellow</b>.</li> </ul>											

**Table 13.2-6: Maximum output power measured of WLAN antenna, for the applicable OFDM configurations according to the default power measurement procedures for selection initial test configurations –Aux antenna**

802.11 mode	a		n		ac				ax			
BW(M Hz)	20	20	40	20	40	80	160	20	40	80	160	
<b>U-NII-1</b>	36/40/44/48 Lower power	36/40/44/48 Lower power	38/46 Lower power	36/40/44/48 Lower power	38/46 Lower power	<b>42</b> <b>13</b>	/	36/40/44/48 Lower power	38/46 Lower power	42 Lower power	/	
<b>U-NII-2A</b>	52/56/60/64 Lower power	52/56/60/64 Lower power	54/62 Lower power	52/56/60/64 Lower power	54/62 Lower power	58 Lower power	<b>50</b> <b>23</b>	52/56/60/64 Lower power	54/62 Lower power	58 Lower power	50 Lower power	
<b>U-NII-2C</b>	100/104/108/112/116/120/124/128/132/136/140/144 Lower power	100/104/112/116/132/136/140/144 Lower power	102/110/113/4 Lower power	100/104/108/112/116/132/136/140/144 Lower power	102/110/134 Lower power	106 Lower power	<b>114</b> <b>27</b>	100/104/108/112/116/132/136/140/144 Lower power	102/110/113/134 Lower power	106 Lower power	114 Lower power	
<b>U-NII-3</b>	149/153/157/161/165 Lower power	149/153/157/161/165 Lower power	151/159 Lower power	149/153/157/161/165 Lower power	151/159 Lower power	<b>155</b> <b>16</b>	/	149/153/157/161/165 Lower power	151/159 Lower power	155 Lower power	/	

<ul style="list-style-type: none"> <li>● The <b>bold numbers</b> is the maximum output measured power (mW).</li> <li>● Channels with measured maximum power within 0.25dB are considered to have the same measured output.</li> <li>● Channels selected for initial test configuration are <b>highlighted in yellow</b>.</li> </ul>											
---	--	--	--	--	--	--	--	--	--	--	--

**Table 13.2-7: Maximum output power measured of WLAN antenna, for the applicable OFDM configurations according to the default power measurement procedures for selection initial test configurations –MIMO antenna**

802.11 mode	a	n		ac				ax			
BW(M Hz)	20	20	40	20	40	80	160	20	40	80	160
U-NII-1	/	36/40/44/4 8 Lower power	38/46 Lower power	36/40/44/48 Lower power	38/46 Lower power	42 13	/	36/40/4 4/48 Lower power	38/46 Lower power	42 Lower power	/
U-NII-2A	/	52/56/60/6 4 Lower power	54/62 Lower power	52/56/60/64 Lower power	54/62 Lower power	58 Lower power	50 19	52/56/6 0/64 Lower power	54/62 Lower power	58 Lower power	50 Lower power
U-NII-2C	/	100/104/1 08/112 116/132/1 36/140 Lower power	102/1 10/13 4 Lower power	100/104/10 8/112 116/132/13 6/140 Lower power	102/11 0/134 Lower power	106 Lower power	114 24	100/10 4/108/1 12 116/132 /136/14 0 Lower power	102/110/ 134 Lower power	106 Lower power	114 Lower power
U-NII-3	/	149/153/1 57/161/16 5 Lower power	151/1 59 Lower power	149/153/15 7/161/165 Lower power	151/15 9 Lower power	155 16	/	149/15 3/157/1 61/165 Lower power	151/159 Lower power	155 Lower power	/

- The **bold numbers** is the maximum output measured power (mW).
- Channels with measured maximum power within 0.25dB are considered to have the same measured output.
- Channels selected for initial test configuration are **highlighted in yellow**.



Table 13.2-8: Reported SAR of initial test configuration for Body – Main antenna

802.11 mode	a	n		ac				ax			
BW(M Hz)	20	20	40	20	40	80	160	20	40	80	160
U-NII-1	/	36/40/44/48 8 Lower power	38/46 Lower power	36/40/44/48 Lower power	38/46 Lower power	42 UNII-2A exclusion applied	/	36/40/44/48 4/48 Lower power	38/46 Lower power	42 Lower power	/
U-NII-2A	/	52/56/60/64 4 Lower power	54/62 Lower power	52/56/60/64 Lower power	54/62 Lower power	58 Lower power	<b>50</b> <b>1.14</b>	52/56/60/64 0/64 Lower power	54/62 Lower power	58 Lower power	50 Lower power
U-NII-2C	/	100/104/108/112/116/132/136/140 Lower power	102/110/113/14 Lower power	100/104/108/112/116/132/136/140 Lower power	102/110/134 Lower power	106 Lower power	<b>114</b> <b>0.92</b>	100/104/108/112/116/132/136/140 0 Lower power	102/110/113/134 Lower power	106 Lower power	114 Lower power
U-NII-3	/	149/153/157/161/165 5 Lower power	151/159 Lower power	149/153/157/161/165 Lower power	151/159 Lower power	<b>155</b> <b>1.07</b>	/	149/153/157/161/165 61/165 Lower power	151/159 Lower power	155 Lower power	/

- The **bold numbers** is the maximum output measured power (mW).
- Channels with measured maximum power within 0.25dB are considered to have the same measured output.
- Channels selected for initial test configuration are **highlighted in yellow**.

**Table 13.2-9: Reported SAR of initial test configuration for Body – Aux antenna**

802.11 mode	a	n		ac				ax			
BW(M Hz)	20	20	40	20	40	80	160	20	40	80	160
U-NII-1	/	36/40/44/48 8 Lower power	38/46 Lower power	36/40/44/48 Lower power	38/46 Lower power	42 UNII-2A exclusion applied	/	36/40/44/48 Lower power	38/46 Lower power	42 Lower power	/
U-NII-2A	/	52/56/60/64 4 Lower power	54/62 Lower power	52/56/60/64 Lower power	54/62 Lower power	58 Lower power	<b>50</b> <b>1.16</b>	52/56/60/64 Lower power	54/62 Lower power	58 Lower power	50 Lower power
U-NII-2C	/	100/104/108/112/116/132/136/140 Lower power	102/110/113/14 Lower power	100/104/108/112/116/132/136/140 Lower power	102/110/134 Lower power	106 Lower power	<b>114</b> <b>0.87</b>	100/104/108/112/116/132/136/140 Lower power	102/110/113/134 Lower power	106 Lower power	114 Lower power
U-NII-3	/	149/153/157/161/165 5 Lower power	151/159 Lower power	149/153/157/161/165 Lower power	151/159 Lower power	<b>155</b> <b>0.79</b>	/	149/153/157/161/165 Lower power	151/159 Lower power	155 Lower power	/

- The **bold numbers** is the maximum output measured power (mW).
- Channels with measured maximum power within 0.25dB are considered to have the same measured output.
- Channels selected for initial test configuration are **highlighted in yellow**.

Table 13.2-10: Reported SAR of initial test configuration for Body – MIMO antenna

802.11 mode	a	n		ac				ax			
BW(M Hz)	20	20	40	20	40	80	160	20	40	80	160
U-NII-1	/	36/40/44/48 8 Lower power	38/46 Lower power	36/40/44/48 Lower power	38/46 Lower power	42 UNII-2A exclusion applied	/	36/40/44/48 Lower power	38/46 Lower power	42 Lower power	/
U-NII-2A	/	52/56/60/64 4 Lower power	54/62 Lower power	52/56/60/64 Lower power	54/62 Lower power	58 Lower power	<b>50</b> <b>0.54</b>	52/56/60/64 Lower power	54/62 Lower power	58 Lower power	50 Lower power
U-NII-2C	/	100/104/108/112/116/132/136/140 Lower power	102/110/113/114 Lower power	100/104/108/112/116/132/136/140 Lower power	102/110/113/114 Lower power	106 Lower power	<b>114</b> <b>0.39</b>	100/104/108/112/116/132/136/140 Lower power	102/110/113/114 Lower power	106 Lower power	114 Lower power
U-NII-3	/	149/153/157/161/165 5 Lower power	151/159 Lower power	149/153/157/161/165 Lower power	151/159 Lower power	<b>155</b> <b>0.45</b>	/	149/153/157/161/165 Lower power	151/159 Lower power	155 Lower power	/

- The **bold numbers** is the maximum output measured power (mW).
- Channels with measured maximum power within 0.25dB are considered to have the same measured output.
- Channels selected for initial test configuration are **highlighted in yellow**.

**Table 13.2-11: SAR Values (WLAN - Body) – Main antenna**

Frequency		Test Position	Figure No.	Conducted Power (dBm)	Max. tune-up Power (dBm)	Measured SAR(10g) (W/kg)	Reported SAR(10g) (W/kg)	Measured SAR(1g) (W/kg)	Reported SAR(1g) (W/kg)	Power Drift (dB)
Ch.	MHz									
50	5250	Front	/	13.02	15.00	0.143	<b>0.23</b>	0.394	<b>0.62</b>	-0.09
50	5250	Rear	Fig.4	13.02	15.00	0.221	<b>0.35</b>	0.713	<b>1.12</b>	0.09
114	5570	Front	/	13.85	15.00	0.139	<b>0.18</b>	0.399	<b>0.52</b>	0.15
114	5570	Rear	/	13.85	15.00	0.214	<b>0.28</b>	0.706	<b>0.92</b>	0.04
155	5775	Front	/	11.76	13.00	0.101	<b>0.13</b>	0.291	<b>0.39</b>	0.16
155	5775	Rear	/	11.76	13.00	0.239	<b>0.32</b>	0.807	<b>1.07</b>	0.13

Note1: The distance between the EUT and the phantom bottom is 0mm.

According to the KDB248227 D01, The reported SAR must be scaled to 100% transmission duty factor to determine compliance at the maximum tune-up tolerance limit. The scaled reported SAR is presented as below.

**Table 13.2-12: SAR Values (WLAN - Body) – 802.11a (Scaled Reported SAR)**

Frequency		Test Position	D (mm)	Actual duty factor	maximum duty factor	Reported SAR (1g) (W/kg)	Scaled reported SAR (1g) (W/kg)
Ch.	MHz						
50	5250	Rear	0	99%	100%	<b>1.12</b>	<b>1.14</b>

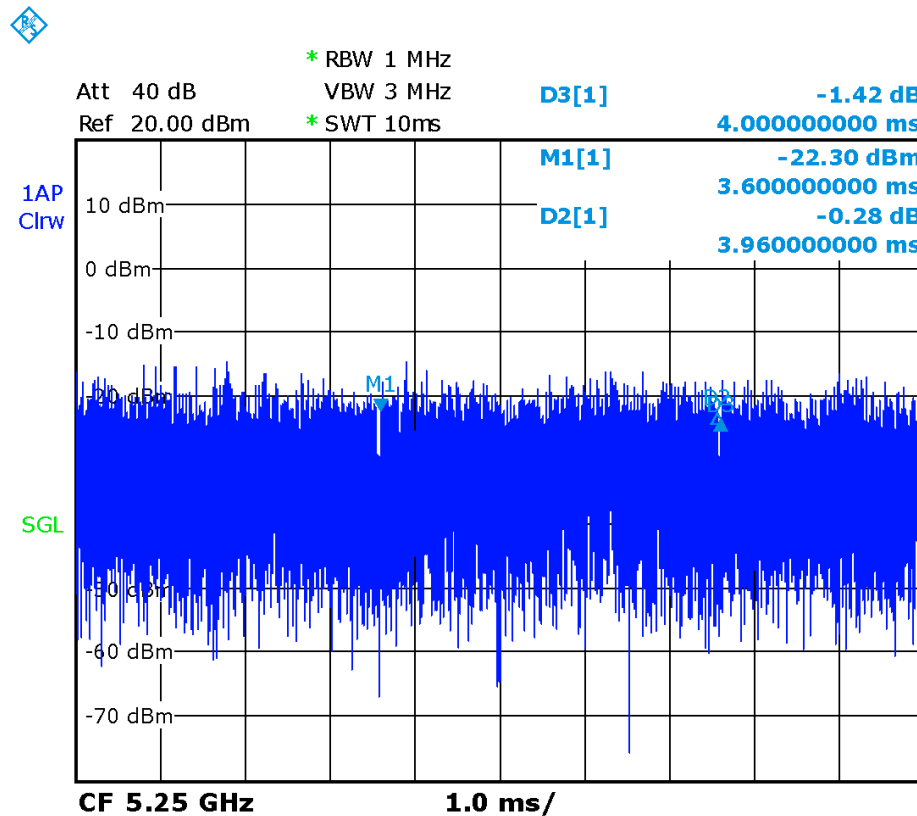
**Picture 13.4 Duty factor plot for 5G**

**Table 13.2-13: SAR Values (WLAN - Body) – Aux antenna**

Frequency		Test Position	Figure No.	Conducted Power (dBm)	Max. tune-up Power (dBm)	Measured SAR(10g) (W/kg)	Reported SAR(10g) (W/kg)	Measured SAR(1g) (W/kg)	Reported SAR(1g) (W/kg)	Power Drift (dB)
Ch.	MHz									
50	5250	Front	/	13.57	15.00	0.137	<b>0.19</b>	0.370	<b>0.51</b>	0.16
50	5250	Rear	Fig.5	13.57	15.00	0.247	<b>0.34</b>	0.825	<b>1.15</b>	-0.09
114	5570	Front	/	14.29	15.00	0.147	<b>0.17</b>	0.416	<b>0.49</b>	0.17
114	5570	Rear	/	14.29	15.00	0.225	<b>0.26</b>	0.740	<b>0.87</b>	0.00
155	5775	Front	/	11.74	13.00	0.145	<b>0.19</b>	0.431	<b>0.58</b>	0.19
155	5775	Rear	/	11.74	13.00	0.197	<b>0.26</b>	0.591	<b>0.79</b>	-0.15
50	5250	Rear	SKU2	13.57	15.00	0.134	<b>0.19</b>	0.393	<b>0.55</b>	0.00
50	5250	Rear	SKU3	13.57	15.00	0.231	<b>0.32</b>	0.816	<b>1.13</b>	-0.07

Note1: The distance between the EUT and the phantom bottom is 0mm.

According to the KDB248227 D01, The reported SAR must be scaled to 100% transmission duty factor to determine compliance at the maximum tune-up tolerance limit. The scaled reported SAR is presented as below.

**Table 13.2-14: SAR Values (WLAN - Body) – 802.11a (Scaled Reported SAR)**

Frequency		Test Position	D (mm)	Actual duty factor	maximum duty factor	Reported SAR (1g) (W/kg)	Scaled reported SAR (1g) (W/kg)
Ch.	MHz						
50	5250	Rear	0	98.80%	100%	<b>1.15</b>	<b>1.16</b>

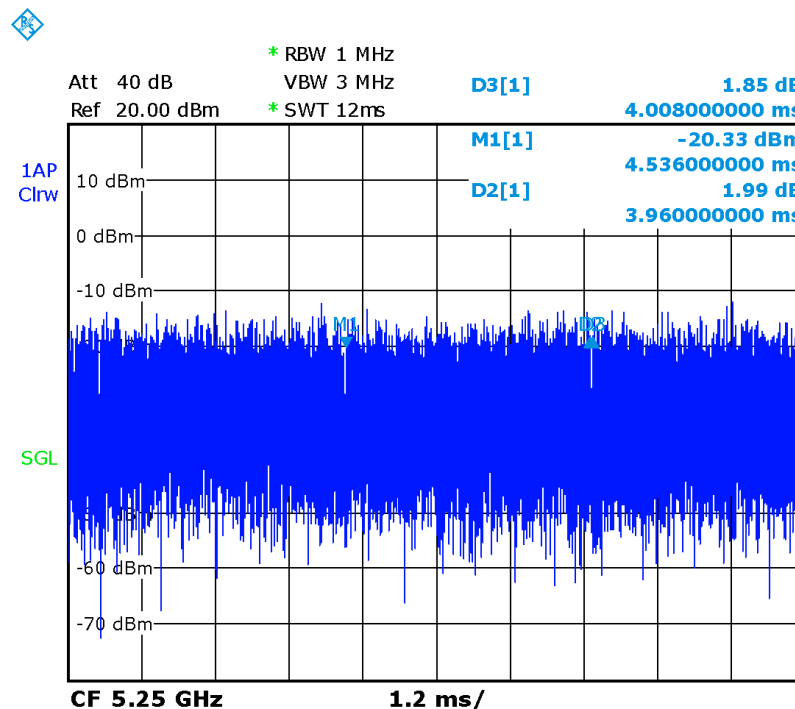
**Picture 13.5 Duty factor plot for 5G**

**Table 13.2-15: SAR Values (WLAN - Body) – MIMO antenna**

Frequency		Test Position	Figure No.	Conducted Power (dBm)	Max. tune-up Power (dBm)	Measured SAR(10g) (W/kg)	Reported SAR(10g) (W/kg)	Measured SAR(1g) (W/kg)	Reported SAR(1g) (W/kg)	Power Drift (dB)
Ch.	MHz									
50	5250	Front	/	12.82	14.00	0.080	<b>0.10</b>	0.227	<b>0.30</b>	0.13
50	5250	Rear	Fig.6	12.82	14.00	0.128	<b>0.17</b>	0.402	<b>0.53</b>	0.13
114	5570	Front	/	13.73	14.00	0.074	<b>0.08</b>	0.194	<b>0.21</b>	0.09
114	5570	Rear	/	13.73	14.00	0.116	<b>0.12</b>	0.365	<b>0.39</b>	0.00
155	5775	Front	/	11.55	13.00	0.076	<b>0.11</b>	0.196	<b>0.27</b>	0.13
155	5775	Rear	/	11.55	13.00	0.113	<b>0.16</b>	0.325	<b>0.45</b>	0.15

Note1: The distance between the EUT and the phantom bottom is 0mm.

According to the KDB248227 D01, The reported SAR must be scaled to 100% transmission duty factor to determine compliance at the maximum tune-up tolerance limit. The scaled reported SAR is presented as below.

**Table 13.2-16: SAR Values (WLAN - Body) – 802.11a (Scaled Reported SAR)**

Frequency		Test Position	D (mm)	Actual duty factor	maximum duty factor	Reported SAR (1g) (W/kg)	Scaled reported SAR (1g) (W/kg)
Ch.	MHz						
50	5250	Rear	0	98.31%	100%	<b>0.53</b>	<b>0.54</b>

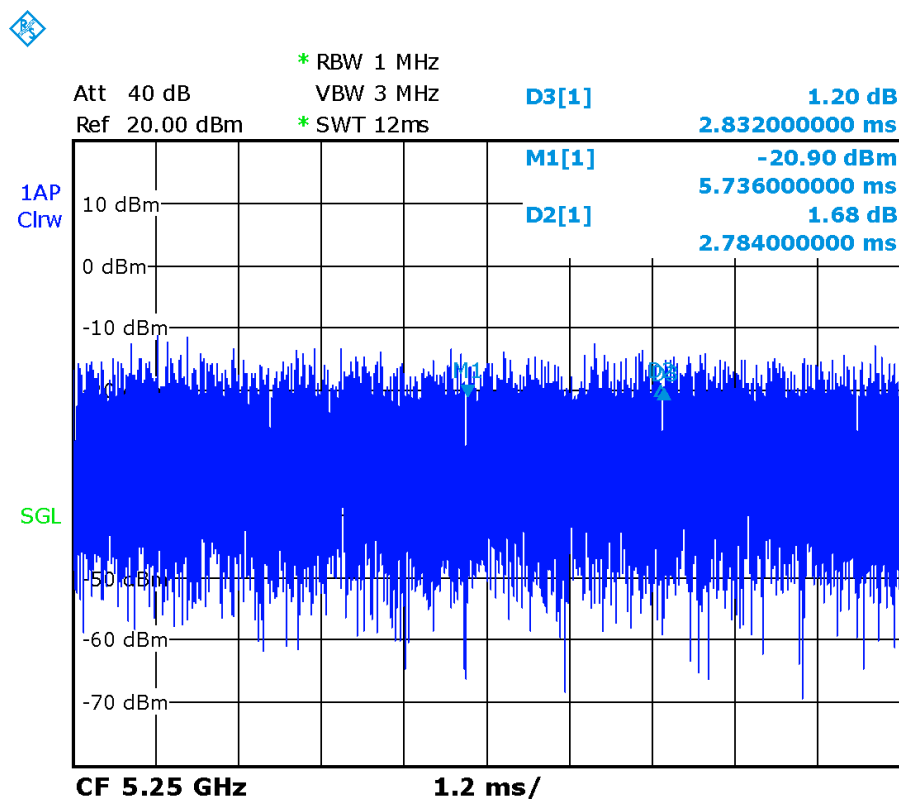
**Picture 13.6 Duty factor plot for 5G**

### 13.3 SAR Results for BT

**Table 13.3-1: SAR Values (Bluetooth - Body)**

Frequency		Test Position	Figure No.	Conducted Power (dBm)	Max. tune-up Power (dBm)	Ambient Temperature: 23.1 °C		Liquid Temperature: 22.2°C		Power Drift (dB)
Ch	MHz					Measured SAR(10g) (W/kg)	Reported SAR(10g) (W/kg)	Measured SAR(1g) (W/kg)	Reported SAR(1g) (W/kg)	
78	2480	Rear	/	10.40	10.50	0.013	<b>0.01</b>	0.031	<b>0.03</b>	0.00
78	2480	Front	Fig.7	10.40	10.50	0.051	<b>0.05</b>	0.121	<b>0.12</b>	0.11

Note1: The distance between the EUT and the phantom bottom is 0mm

## 14 SAR Measurement Variability

SAR measurement variability must be assessed for each frequency band, which is determined by the SAR probe calibration point and tissue-equivalent medium used for the device measurements. When both head and body tissue-equivalent media are required for SAR measurements in a frequency band, the variability measurement procedures should be applied to the tissue medium with the highest measured SAR, using the highest measured SAR configuration for that tissue-equivalent medium.

The following procedures are applied to determine if repeated measurements are required.

- 1) Repeated measurement is not required when the original highest measured SAR is  $< 0.80$  W/kg; steps 2) through 4) do not apply.
- 2) When the original highest measured SAR is  $\geq 0.80$  W/kg, repeat that measurement once.
- 3) Perform a second repeated measurement only if the ratio of largest to smallest SAR for the original and first repeated measurements is  $> 1.20$  or when the original or repeated measurement is  $\geq 1.45$  W/kg ( $\sim 10\%$  from the 1-g SAR limit).
- 4) Perform a third repeated measurement only if the original, first or second repeated measurement is  $\geq 1.5$  W/kg and the ratio of largest to smallest SAR for the original, first and second repeated measurements is  $> 1.20$ .

**Table 14.1: SAR Measurement Variability for Body WIFI5G (1g)**

Frequency		Test Position	Spacing (mm)	Original SAR (W/kg)	First Repeated SAR (W/kg)	The Ratio	Second Repeated SAR (W/kg)
Ch.	MHz						
50	5250	Rear	0	0.825	0.801	1.03	/



## 15 Measurement Uncertainty

### 15.1 Measurement Uncertainty for Normal SAR Tests (300MHz~3GHz)

No.	Error Description	Type	Uncertainty value	Probably Distribution	Div.	(Ci) 1g	(Ci) 10g	Std. Unc. (1g)	Std. Unc. (10g)	Degree of freedom
<b>Measurement system</b>										
1	Probe calibration	B	6.0	N	1	1	1	6.0	6.0	$\infty$
2	Isotropy	B	4.7	R	$\sqrt{3}$	0.7	0.7	1.9	1.9	$\infty$
3	Boundary effect	B	1.0	R	$\sqrt{3}$	1	1	0.6	0.6	$\infty$
4	Linearity	B	4.7	R	$\sqrt{3}$	1	1	2.7	2.7	$\infty$
5	Detection limit	B	1.0	N	1	1	1	0.6	0.6	$\infty$
6	Readout electronics	B	0.3	R	$\sqrt{3}$	1	1	0.3	0.3	$\infty$
7	Response time	B	0.8	R	$\sqrt{3}$	1	1	0.5	0.5	$\infty$
8	Integration time	B	2.6	R	$\sqrt{3}$	1	1	1.5	1.5	$\infty$
9	RF ambient conditions-noise	B	0	R	$\sqrt{3}$	1	1	0	0	$\infty$
10	RF ambient conditions-reflection	B	0	R	$\sqrt{3}$	1	1	0	0	$\infty$
11	Probe positioned mech. restrictions	B	0.4	R	$\sqrt{3}$	1	1	0.2	0.2	$\infty$
12	Probe positioning with respect to phantom shell	B	2.9	R	$\sqrt{3}$	1	1	1.7	1.7	$\infty$
13	Post-processing	B	1.0	R	$\sqrt{3}$	1	1	0.6	0.6	$\infty$
<b>Test sample related</b>										
14	Test sample positioning	A	3.3	N	1	1	1	3.3	3.3	71
15	Device holder uncertainty	A	3.4	N	1	1	1	3.4	3.4	5
16	Drift of output power	B	5.0	R	$\sqrt{3}$	1	1	2.9	2.9	$\infty$
<b>Phantom and set-up</b>										
17	Phantom uncertainty	B	4.0	R	$\sqrt{3}$	1	1	2.3	2.3	$\infty$
18	Liquid conductivity (target)	B	5.0	R	$\sqrt{3}$	0.64	0.43	1.8	1.2	$\infty$
19	Liquid conductivity (meas.)	A	2.06	N	1	0.64	0.43	1.32	0.89	43
20	Liquid permittivity (target)	B	5.0	R	$\sqrt{3}$	0.6	0.49	1.7	1.4	$\infty$
21	Liquid permittivity (meas.)	A	1.6	N	1	0.6	0.49	1.0	0.8	521

Combined standard uncertainty	$u_c' = \sqrt{\sum_{i=1}^{21} c_i^2 u_i^2}$							9.55	9.43	257
Expanded uncertainty (confidence interval of 95 %)	$u_e = 2u_c$							19.1	18.9	

**15.2 Measurement Uncertainty for Normal SAR Tests (3~6GHz)**

No.	Error Description	Type	Uncertainty value	Probably Distribution	Div.	(Ci) 1g	(Ci) 10g	Std. Unc. (1g)	Std. Unc. (10g)	Degree of freedom
<b>Measurement system</b>										
1	Probe calibration	B	6.55	N	1	1	1	6.55	6.55	$\infty$
2	Isotropy	B	4.7	R	$\sqrt{3}$	0.7	0.7	1.9	1.9	$\infty$
3	Boundary effect	B	2.0	R	$\sqrt{3}$	1	1	1.2	1.2	$\infty$
4	Linearity	B	4.7	R	$\sqrt{3}$	1	1	2.7	2.7	$\infty$
5	Detection limit	B	1.0	R	$\sqrt{3}$	1	1	0.6	0.6	$\infty$
6	Readout electronics	B	0.3	R	$\sqrt{3}$	1	1	0.3	0.3	$\infty$
7	Response time	B	0.8	R	$\sqrt{3}$	1	1	0.5	0.5	$\infty$
8	Integration time	B	2.6	R	$\sqrt{3}$	1	1	1.5	1.5	$\infty$
9	RF ambient conditions-noise	B	0	R	$\sqrt{3}$	1	1	0	0	$\infty$
10	RFambient conditions-reflection	B	0	R	$\sqrt{3}$	1	1	0	0	$\infty$
11	Probe positioned mech. restrictions	B	0.8	R	$\sqrt{3}$	1	1	0.5	0.5	$\infty$
12	Probe positioning with respect to phantom shell	B	6.7	R	$\sqrt{3}$	1	1	3.9	3.9	$\infty$
13	Post-processing	B	4.0	R	$\sqrt{3}$	1	1	2.3	2.3	$\infty$
<b>Test sample related</b>										
14	Test sample positioning	A	3.3	N	1	1	1	3.3	3.3	71
15	Device holder uncertainty	A	3.4	N	1	1	1	3.4	3.4	5
16	Drift of output power	B	5.0	R	$\sqrt{3}$	1	1	2.9	2.9	$\infty$
<b>Phantom and set-up</b>										
17	Phantom uncertainty	B	4.0	R	$\sqrt{3}$	1	1	2.3	2.3	$\infty$
18	Liquid conductivity (target)	B	5.0	R	$\sqrt{3}$	0.64	0.43	1.8	1.2	$\infty$
19	Liquid conductivity (meas.)	A	2.06	N	1	0.64	0.43	1.32	0.89	43
20	Liquid permittivity (target)	B	5.0	R	$\sqrt{3}$	0.6	0.49	1.7	1.4	$\infty$

21	Liquid permittivity (meas.)	A	1.6	N	1	0.6	0.49	1.0	0.8	521
Combined standard uncertainty		$u_c' = \sqrt{\sum_{i=1}^{21} c_i^2 u_i^2}$						10.7	10.6	257
Expanded uncertainty (confidence interval of 95 %)		$u_e = 2u_c$						21.4	21.1	

## 16 MAIN TEST INSTRUMENTS

**Table 17.1: List of Main Instruments**

No.	Name	Type	Serial Number	Calibration Date	Valid Period
01	Network analyzer	E5071C	MY46110673	January 14, 2021	One year
02	Power meter	NRVD	102083	October 23, 2020	One year
03	Power sensor	NRV-Z5	100542		
04	Signal Generator	E4438C	MY49071430	February 1, 2021	One Year
05	Amplifier	60S1G4	0331848	No Calibration Requested	
06	E-field Probe	SPEAG EX3DV4	7600	November 30, 2020	One year
07	DAE	SPEAG DAE4	1525	September 2, 2020	One year
08	Dipole Validation Kit	SPEAG D2450V2	853	July 21,2020	One year
09	Dipole Validation Kit	SPEAG D5GHzV2	1060	July 27,2020	One year

\*\*\*END OF REPORT BODY\*\*\*

## ANNEX A Graph Results

WLAN2450\_CH6 Rear

Date: 5/19/2021

Electronics: DAE4 Sn1525

Medium: H2450

Medium parameters used (interpolated):  $f = 2437$  MHz;  $\sigma = 1.911$  S/m;  $\epsilon_r = 40.758$ ;  $\rho = 1000$  kg/m<sup>3</sup>

Ambient Temperature: 23.1oC      Liquid Temperature: 22.2oC

Communication System: WIFI 2450 Frequency: 2437 MHz Duty Cycle: 1:1

Probe: EX3DV4 - SN7600 ConvF(7.79, 7.79, 7.79)

Area Scan (201x101x1): Interpolated grid: dx=1.200 mm, dy=1.200 mm

Maximum value of SAR (interpolated) = 1.29 W/kg

Zoom Scan (7x7x7)/Cube 0: Measurement grid: dx=5mm, dy=5mm, dz=5mm

Reference Value = 3.118 V/m; Power Drift = 0.13 dB

Peak SAR (extrapolated) = 1.70 W/kg

SAR(1 g) = 0.753 W/kg; SAR(10 g) = 0.322 W/kg

Maximum value of SAR (measured) = 1.33 W/kg

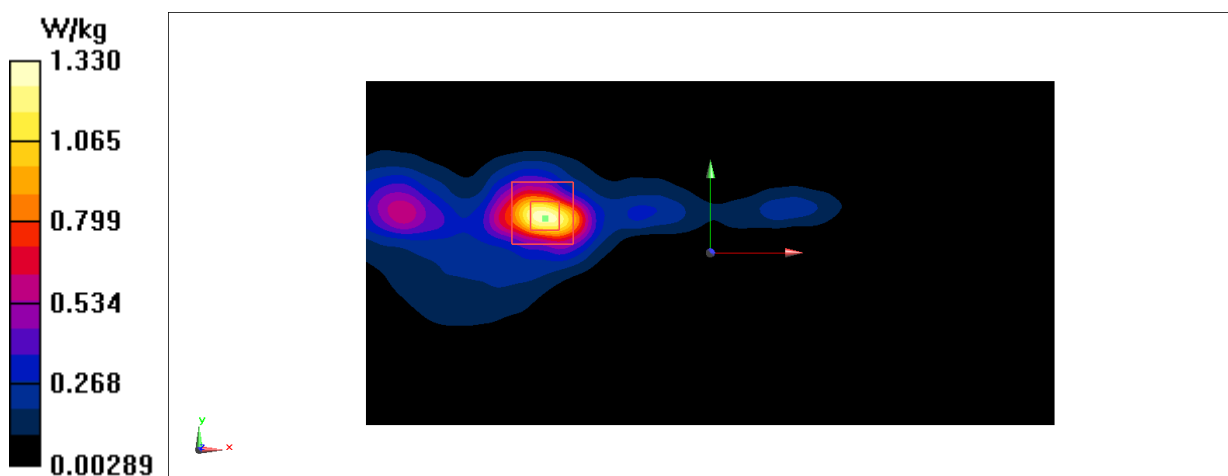

Fig A.1

**WLAN2450\_CH1 Rear**

Date: 5/19/2021

Electronics: DAE4 Sn1525

Medium: H2450

Medium parameters used (interpolated):  $f = 2412$  MHz;  $\sigma = 1.891$  S/m;  $\epsilon_r = 40.801$ ;  $\rho = 1000$  kg/m<sup>3</sup>

Ambient Temperature: 23.1oC      Liquid Temperature: 22.2oC

Communication System: WIFI 2450    Frequency: 2412 MHz Duty Cycle: 1:1

Probe: EX3DV4 - SN7600 ConvF(7.79, 7.79, 7.79)

Area Scan (241x131x1): Interpolated grid: dx=1.000 mm, dy=1.000 mm

Maximum value of SAR (interpolated) = 1.03 W/kg

Zoom Scan (7x7x7)/Cube 0: Measurement grid: dx=5mm, dy=5mm, dz=5mm

Reference Value = 7.291 V/m; Power Drift = -0.14 dB

Peak SAR (extrapolated) = 1.42 W/kg

SAR(1 g) = 0.564 W/kg; SAR(10 g) = 0.226 W/kg

Maximum value of SAR (measured) = 1.06 W/kg

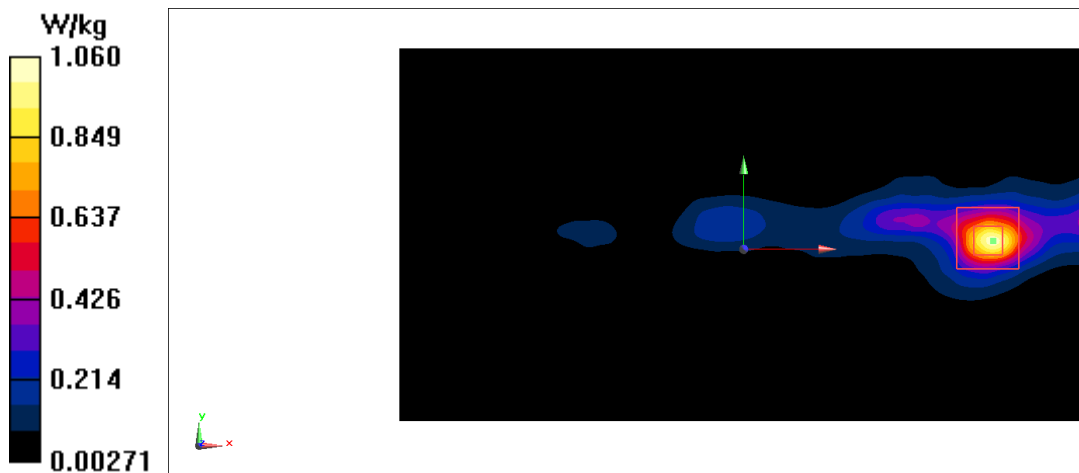
**Fig A.2**

**WLAN2450\_CH6 Rear**

Date: 5/19/2021

Electronics: DAE4 Sn1525

Medium: H2450

Medium parameters used (interpolated):  $f = 2437$  MHz;  $\sigma = 1.911$  S/m;  $\epsilon_r = 40.758$ ;  $\rho = 1000$  kg/m<sup>3</sup>

Ambient Temperature: 23.1oC      Liquid Temperature: 22.2oC

Communication System: WIFI 2450    Frequency: 2437 MHz Duty Cycle: 1:1

Probe: EX3DV4 - SN7600 ConvF(7.79, 7.79, 7.79)

Area Scan (201x101x1): Interpolated grid: dx=1.200 mm, dy=1.200 mm

Maximum value of SAR (interpolated) = 0.740 W/kg

Zoom Scan (7x7x7)/Cube 0: Measurement grid: dx=5mm, dy=5mm, dz=5mm

Reference Value = 14.35 V/m; Power Drift = -0.04 dB

Peak SAR (extrapolated) = 0.932 W/kg

SAR(1 g) = 0.416 W/kg; SAR(10 g) = 0.178 W/kg

Maximum value of SAR (measured) = 0.703 W/kg

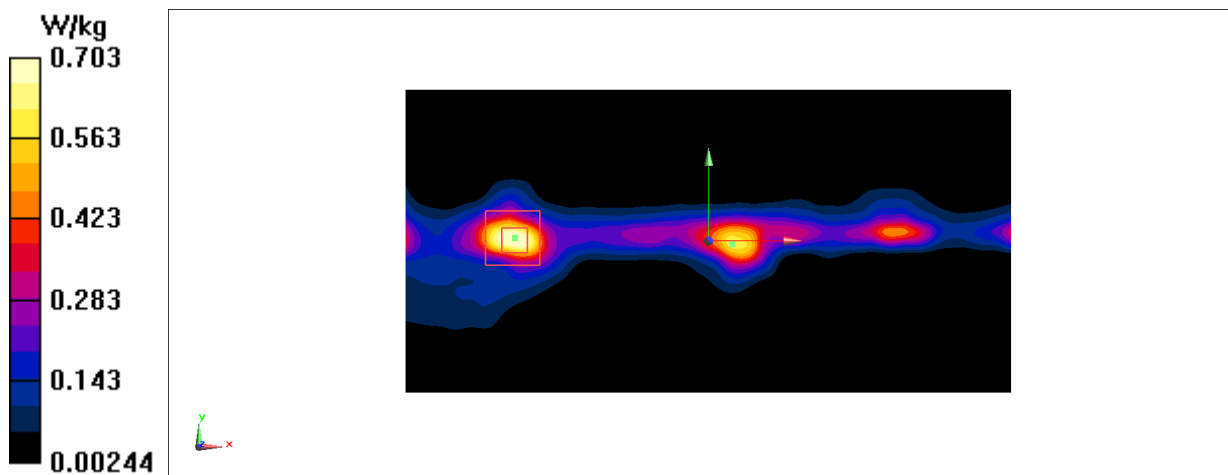
**Fig A.3**

**WLAN5G\_CH50 Rear**

Date: 5/18/2021

Electronics: DAE4 Sn1525

Medium: H5G

Medium parameters used:  $f = 5250$  MHz;  $\sigma = 4.765$  S/m;  $\epsilon_r = 34.779$ ;  $\rho = 1000$  kg/m<sup>3</sup>

Ambient Temperature: 22.8oC      Liquid Temperature: 22.3oC

Communication System: WLAN 11a    Frequency: 5250 MHz Duty Cycle: 1:1

Probe: EX3DV4 - SN7600 ConvF(5.68, 5.68, 5.68)

Area Scan (241x131x1): Interpolated grid: dx=1.000 mm, dy=1.000 mm

Maximum value of SAR (interpolated) = 1.66 W/kg

Zoom Scan (8x8x7)/Cube 0: Measurement grid: dx=4mm, dy=4mm, dz=1.4mm

Reference Value = 1.049 V/m; Power Drift = 0.09 dB

Peak SAR (extrapolated) = 3.00 W/kg

SAR(1 g) = 0.713 W/kg; SAR(10 g) = 0.221 W/kg

Maximum value of SAR (measured) = 1.69 W/kg

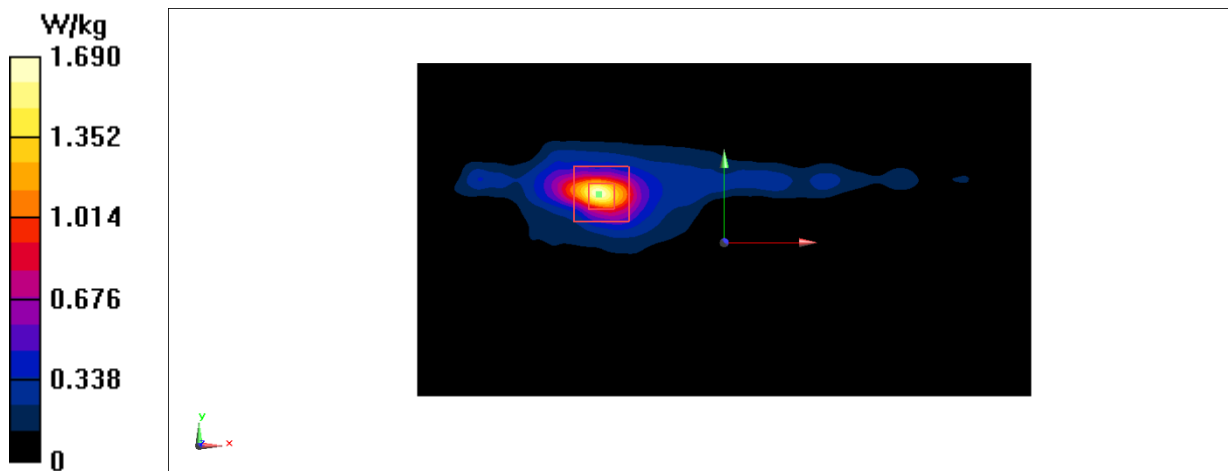
**Fig A.4**

**WLAN5G\_CH50 Rear**

Date: 5/18/2021

Electronics: DAE4 Sn1525

Medium: H5G

Medium parameters used:  $f = 5250$  MHz;  $\sigma = 4.765$  S/m;  $\epsilon_r = 34.779$ ;  $\rho = 1000$  kg/m<sup>3</sup>

Ambient Temperature: 22.8oC      Liquid Temperature: 22.3oC

Communication System: WLAN 11a    Frequency: 5250 MHz Duty Cycle: 1:1

Probe: EX3DV4 - SN7600 ConvF(5.68, 5.68, 5.68)

Area Scan (241x131x1): Interpolated grid: dx=1.000 mm, dy=1.000 mm

Maximum value of SAR (interpolated) = 1.86 W/kg

Zoom Scan (9x9x7)/Cube 0: Measurement grid: dx=4mm, dy=4mm, dz=1.4mm

Reference Value = 0.9650 V/m; Power Drift = -0.09 dB

Peak SAR (extrapolated) = 3.43 W/kg

SAR(1 g) = 0.825 W/kg; SAR(10 g) = 0.247 W/kg

Maximum value of SAR (measured) = 2.12 W/kg

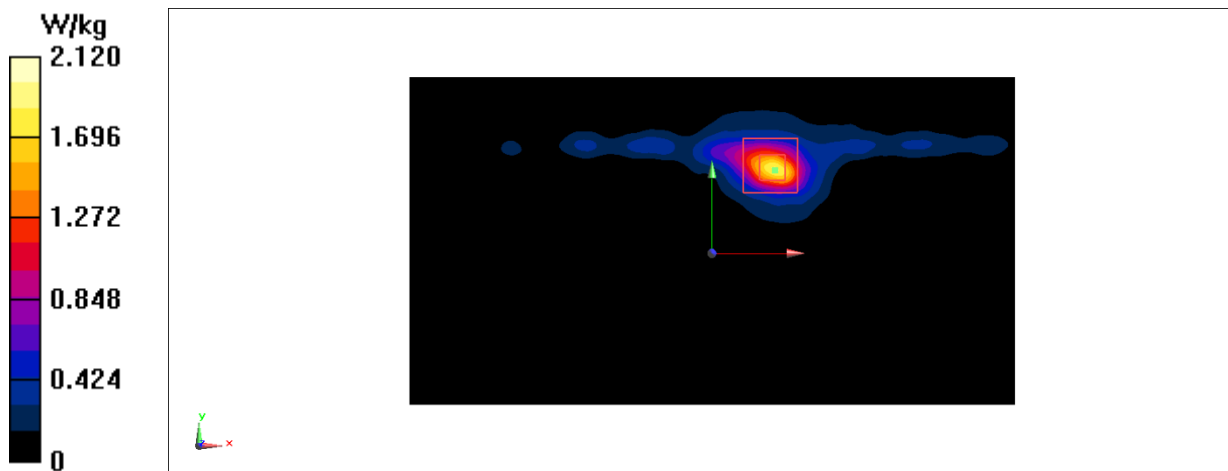
**Fig A.5**



**WLAN5G\_CH50 Rear**

Date: 5/18/2021

Electronics: DAE4 Sn1525

Medium: H5G

Medium parameters used:  $f = 5250$  MHz;  $\sigma = 4.765$  S/m;  $\epsilon_r = 34.779$ ;  $\rho = 1000$  kg/m<sup>3</sup>

Ambient Temperature: 22.8oC      Liquid Temperature: 22.3oC

Communication System: WLAN 11a    Frequency: 5250 MHz Duty Cycle: 1:1

Probe: EX3DV4 - SN7600 ConvF(5.68, 5.68, 5.68)

Area Scan (241x131x1): Interpolated grid: dx=1.000 mm, dy=1.000 mm

Maximum value of SAR (interpolated) = 0.859 W/kg

Zoom Scan (8x8x7)/Cube 0: Measurement grid: dx=4mm, dy=4mm, dz=1.4mm

Reference Value = 1.221 V/m; Power Drift = 0.13 dB

Peak SAR (extrapolated) = 1.62 W/kg

SAR(1 g) = 0.402 W/kg; SAR(10 g) = 0.128 W/kg

Maximum value of SAR (measured) = 0.952 W/kg

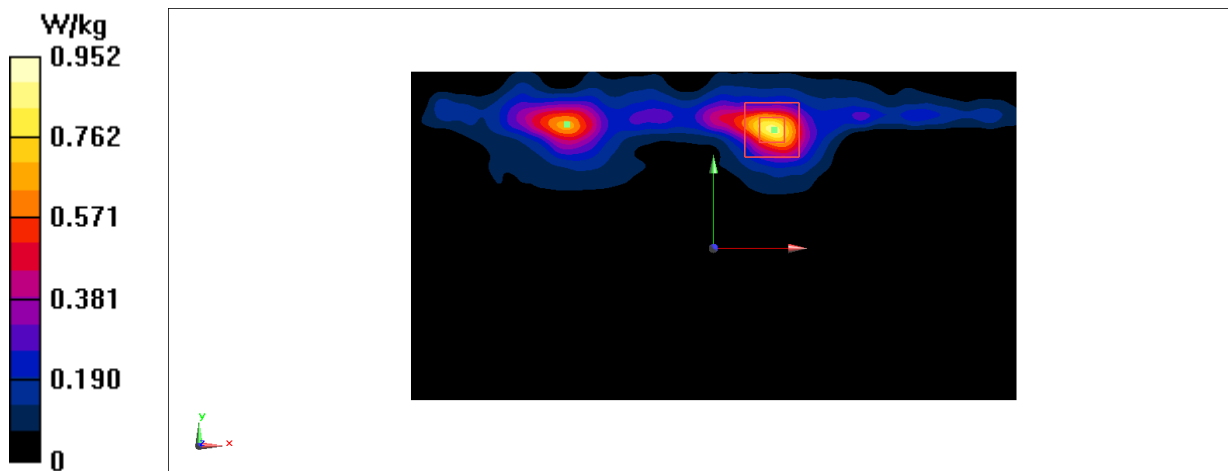
**Fig A.6**

**BT\_CH78 Rear**

Date: 5/19/2021

Electronics: DAE4 Sn1525

Medium: H2450

Medium parameters used:  $f = 2480$  MHz;  $\sigma = 1.944$  S/m;  $\epsilon_r = 40.684$ ;  $\rho = 1000$  kg/m<sup>3</sup>

Ambient Temperature: 23.3oC      Liquid Temperature: 22.5oC

Communication System: Bluetooth Frequency: 2480 MHz Duty Cycle: 1:1

Probe: EX3DV4 - SN7600 ConvF(7.79, 7.79, 7.79)

Area Scan (201x101x1): Interpolated grid: dx=1.200 mm, dy=1.200 mm

Maximum value of SAR (interpolated) = 0.261 W/kg

Zoom Scan (8x7x7)/Cube 0: Measurement grid: dx=5mm, dy=5mm, dz=5mm

Reference Value = 0.951 V/m; Power Drift = 0.11 dB

Peak SAR (extrapolated) = 0.274 W/kg

SAR(1 g) = 0.121 W/kg; SAR(10 g) = 0.051 W/kg

Maximum value of SAR (measured) = 0.207 W/kg

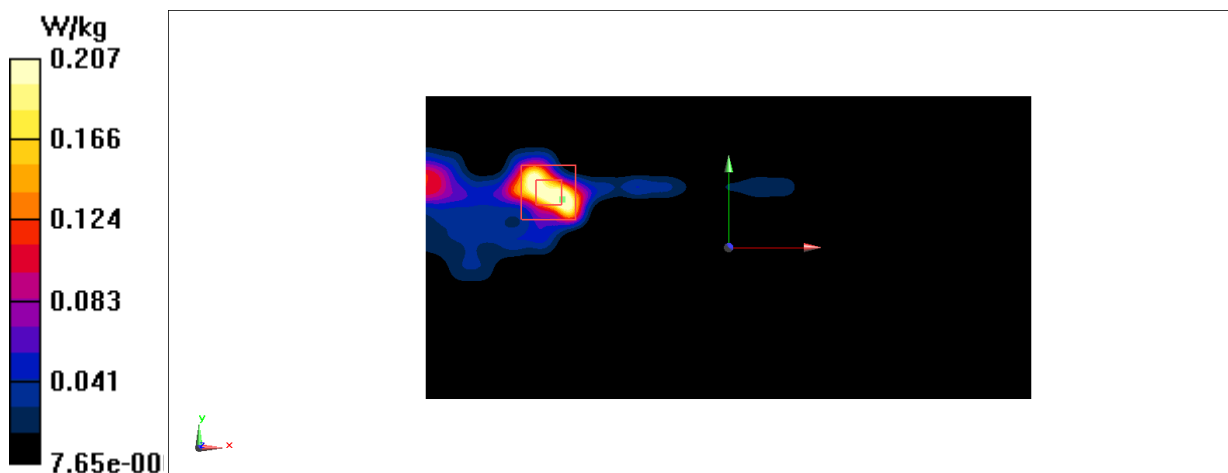
**Fig A.7**

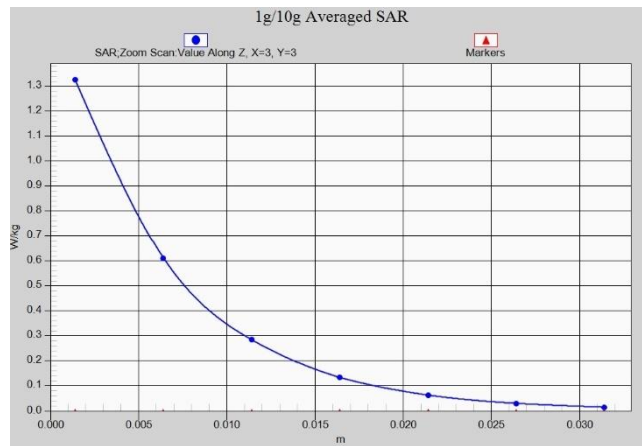

**Fig.15-1 Z-Scan at power reference point (WiFi 2.4G)**

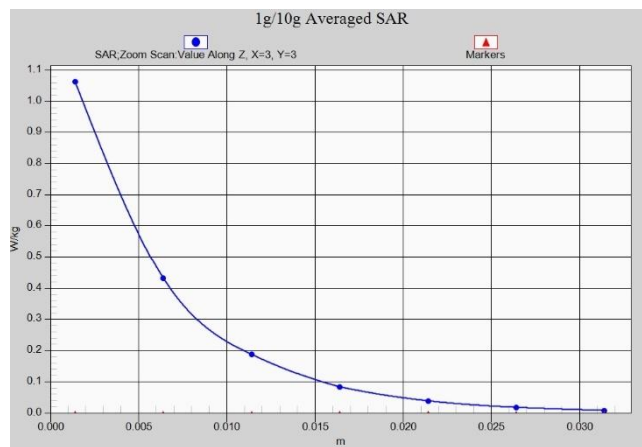

**Fig.15-2 Z-Scan at power reference point (WiFi 2.4G)**

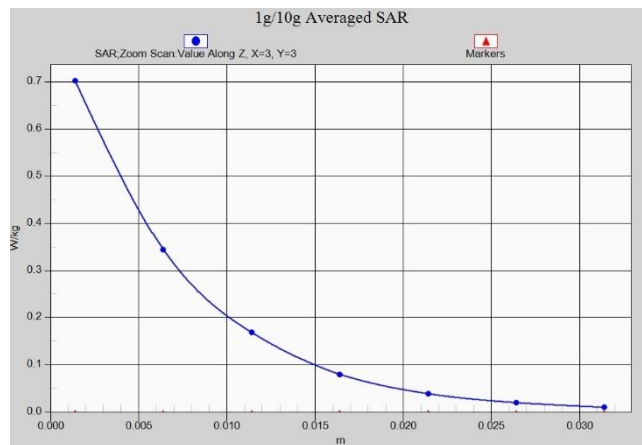

**Fig.15-3 Z-Scan at power reference point (WiFi 2.4G)**

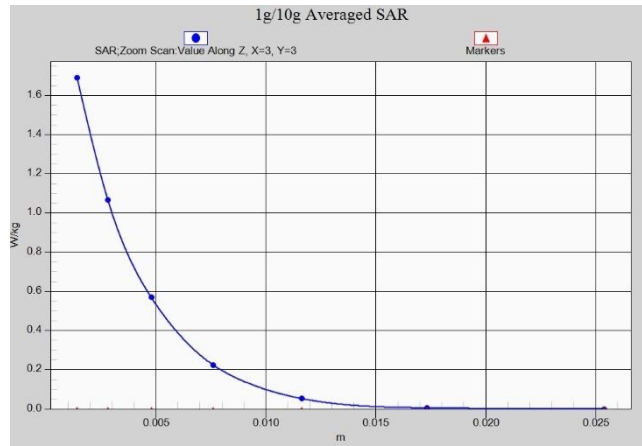

**Fig.15-4 Z-Scan at power reference point (WiFi 5G)**

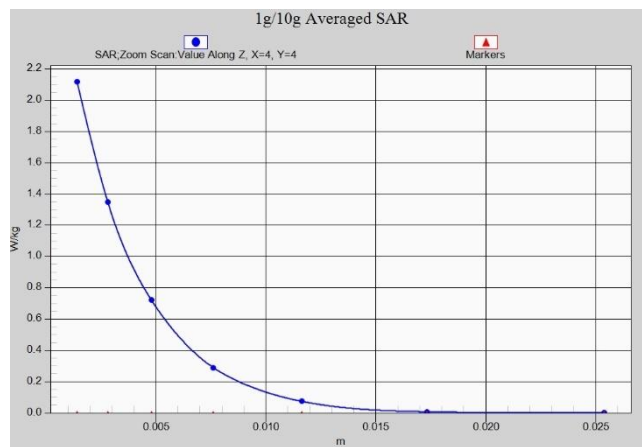

**Fig.15-5 Z-Scan at power reference point (WiFi 5G)**

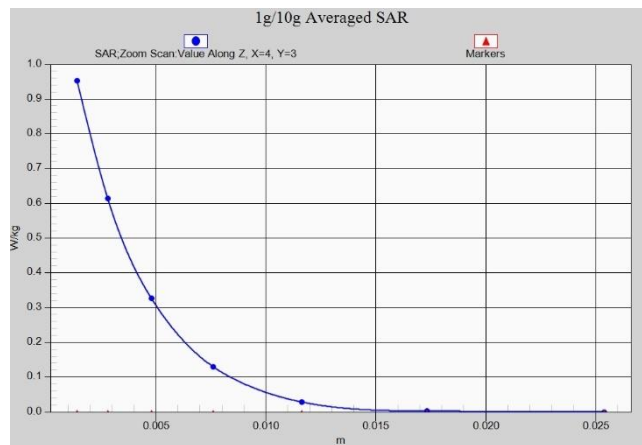

**Fig.15-6 Z-Scan at power reference point (WiFi 5G)**

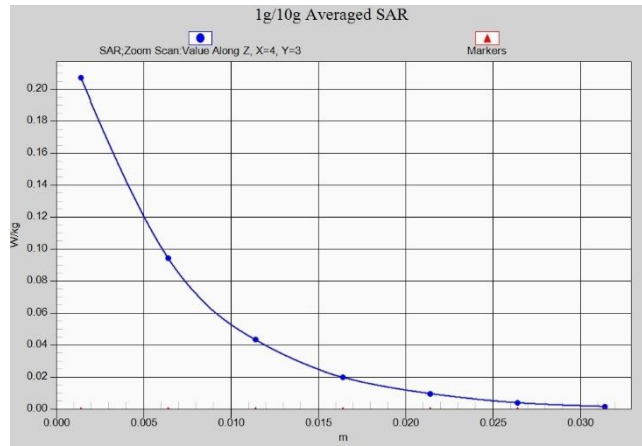

**Fig.15-7 Z-Scan at power reference point (BT)**

## ANNEX B System Verification Results

### 2450 MHz

Date: 5/19/2021

Electronics: DAE4 Sn1525

Medium: H2450

Medium parameters used:  $f = 2450$  MHz;  $\sigma = 1.921$  S/m;  $\epsilon_r = 40.738$ ;  $\rho = 1000$  kg/m<sup>3</sup>

Ambient Temperature: 23.1°C      Liquid Temperature: 22.2°C

Communication System: Frequency: 2450 MHz Duty Cycle: 1:1

Probe: EX3DV4 - SN7600 ConvF(7.79, 7.79, 7.79)

Area Scan 3 (61x81x1): Interpolated grid:  $dx=1.200$  mm,  $dy=1.200$  mm

Maximum value of SAR (interpolated) = 21.9 W/kg

Zoom Scan (7x7x7)/Cube 0: Measurement grid:  $dx=5$ mm,  $dy=5$ mm,  $dz=5$ mm

Reference Value = 58.46 V/m; Power Drift = -0.18 dB

Peak SAR (extrapolated) = 27.4 W/kg

SAR(1 g) = 13.1 W/kg; SAR(10 g) = 6.08 W/kg

Maximum value of SAR (measured) = 22.0 W/kg

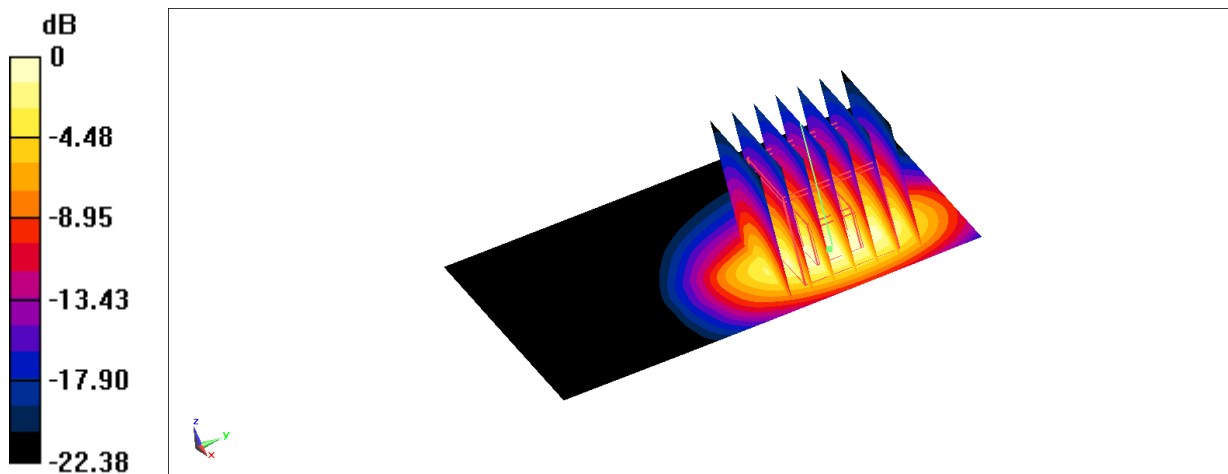

0 dB = 22.0 W/kg = 13.42 dBW/kg

**Fig.B.1 validation 2450 MHz 250mW**

## 5250 MHz

Date: 5/18/2021

Electronics: DAE4 Sn1525

Medium: H5G

Medium parameters used:  $f = 5250$  MHz;  $\sigma = 4.765$  S/m;  $\epsilon_r = 34.779$ ;  $\rho = 1000$  kg/m<sup>3</sup>

Ambient Temperature: 22.8°C      Liquid Temperature: 22.3°C

Communication System: Frequency: 5250 MHz Duty Cycle: 1:1

Probe: EX3DV4 - SN7600 ConvF(5.68, 5.68, 5.68)

Area Scan (101x101x1): Interpolated grid: dx=1.000 mm, dy=1.000 mm

Maximum value of SAR (interpolated) = 18.9 W/kg

Zoom Scan (4x4x1.4mm, graded), dist=1.4mm (7x7x7)/Cube 0: Measurement grid:  
dx=4mm, dy=4mm, dz=1.4mm

Reference Value = 59.38 V/m; Power Drift = 0.14 dB

Peak SAR (extrapolated) = 34.2 W/kg

SAR(1 g) = 8.11 W/kg; SAR(10 g) = 2.3 W/kg

Maximum value of SAR (measured) = 19.5 W/kg

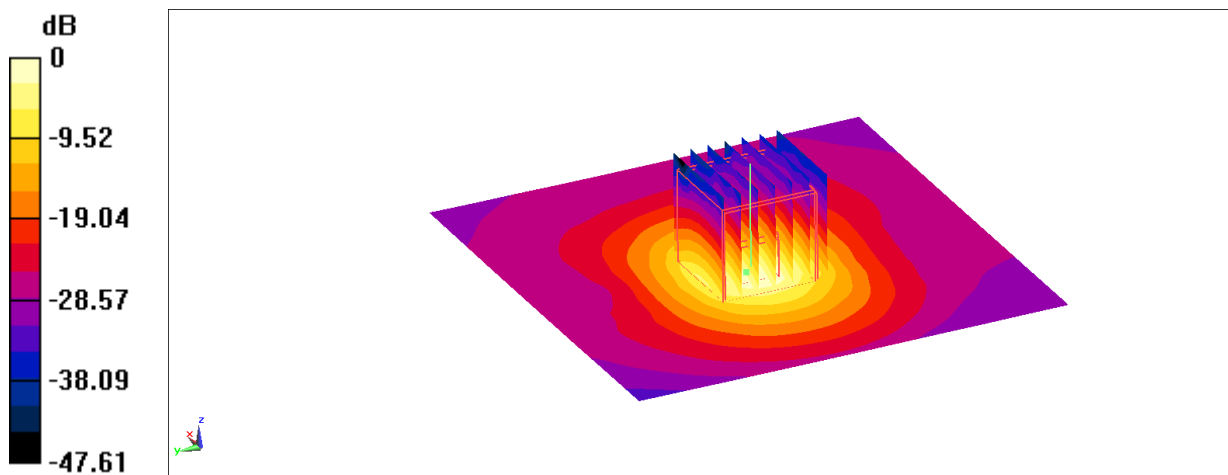

0 dB = 19.5 W/kg = 12.90 dBW/kg

**Fig.B.2 validation 5250 MHz 100mW**

## 5600 MHz

Date: 5/18/2021

Electronics: DAE4 Sn1525

Medium: H5G

Medium parameters used:  $f = 5600$  MHz;  $\sigma = 5.149$  S/m;  $\epsilon_r = 34.088$ ;  $\rho = 1000$  kg/m<sup>3</sup>

Ambient Temperature: 22.8°C      Liquid Temperature: 22.3°C

Communication System: Frequency: 5600 MHz Duty Cycle: 1:1

Probe: EX3DV4 - SN7600 ConvF(5.11, 5.11, 5.11)

Area Scan (101x101x1): Interpolated grid:  $dx=1.000$  mm,  $dy=1.000$  mm

Maximum value of SAR (interpolated) = 19.6 W/kg

Zoom Scan (4x4x1.4mm, graded),  $dist=1.4$ mm (8x8x7)/Cube 0: Measurement grid:  
 $dx=4$ mm,  $dy=4$ mm,  $dz=1.4$ mm

Reference Value = 66.24 V/m; Power Drift = -0.17 dB

Peak SAR (extrapolated) = 34.2 W/kg

SAR(1 g) = 7.55 W/kg; SAR(10 g) = 2.14 W/kg

Maximum value of SAR (measured) = 18.3 W/kg

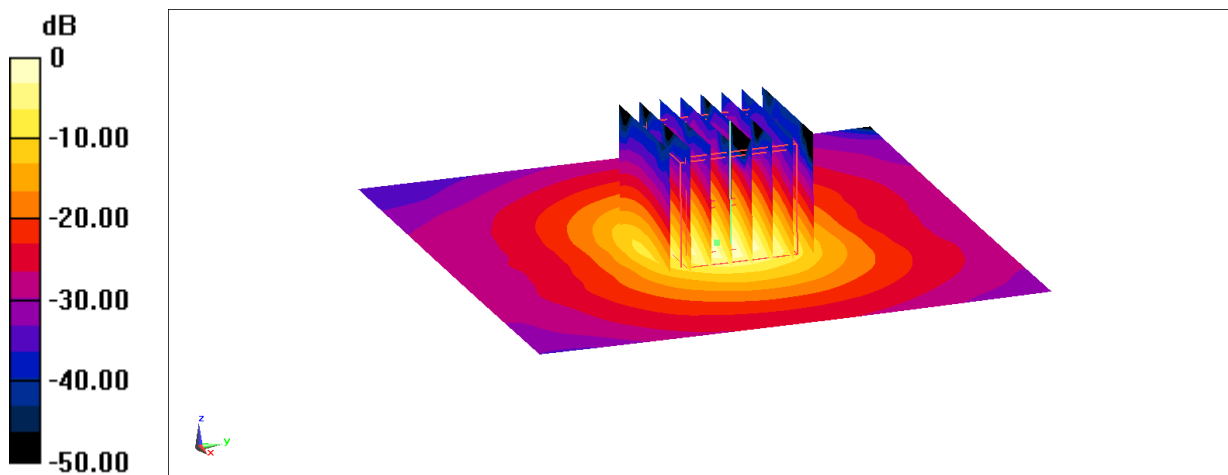

0 dB = 18.3 W/kg = 12.62 dBW/kg

**Fig.B.3 validation 5600 MHz 100Mw**



## 5750 MHz

Date: 6/1/2021

Electronics: DAE4 Sn1525

Medium: H5G

Medium parameters used:  $f = 5750$  MHz;  $\sigma = 5.47$  S/m;  $\epsilon_r = 33.984$ ;  $\rho = 1000$  kg/m<sup>3</sup>

Ambient Temperature: 23 °C      Liquid Temperature: 22.3 °C

Communication System: CW Frequency: 5750 MHz Duty Cycle: 1:1

Probe: EX3DV4 - SN7600 ConvF(5.07, 5.07, 5.07)

Area Scan (101x101x1): Interpolated grid: dx=1.000 mm, dy=1.000 mm

Maximum value of SAR (interpolated) = 19.9 W/kg

Zoom Scan (4x4x1.4mm, graded), dist=1.4mm (7x7x7)/Cube 0: Measurement grid:  
dx=4mm, dy=4mm, dz=1.4mm

Reference Value = 55.90 V/m; Power Drift = 0.17 dB

Peak SAR (extrapolated) = 40.5 W/kg

SAR(1 g) = 8.42 W/kg; SAR(10 g) = 2.39 W/kg

Maximum value of SAR (measured) = 20.8 W/kg

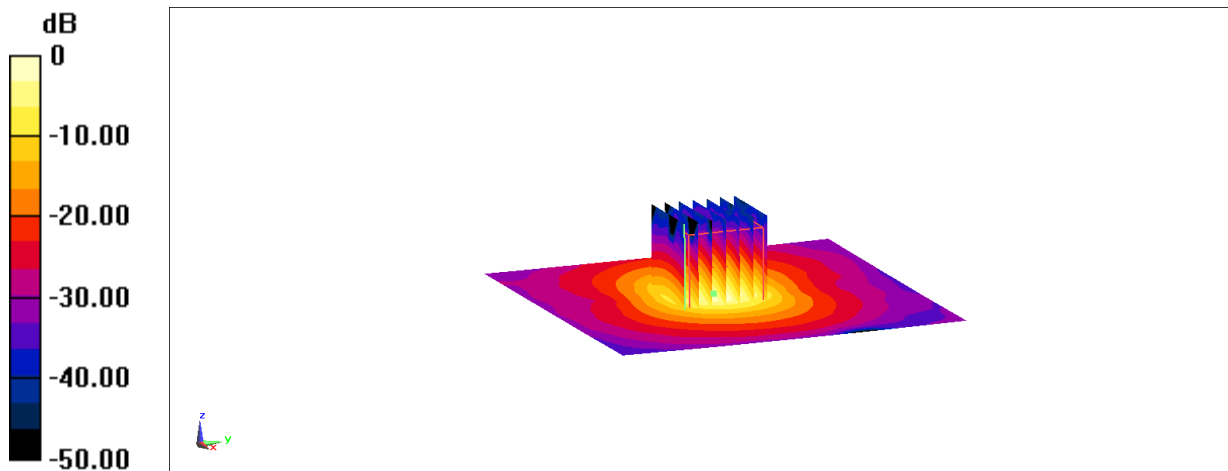

0 dB = 20.8 W/kg = 13.18 dBW/kg

**Fig.B.4 validation 5750 MHz 100Mw**

## ANNEX C SAR Measurement Setup

### C.1 Measurement Set-up

The Dasy4 or DASY5 system for performing compliance tests is illustrated above graphically. This system consists of the following items:

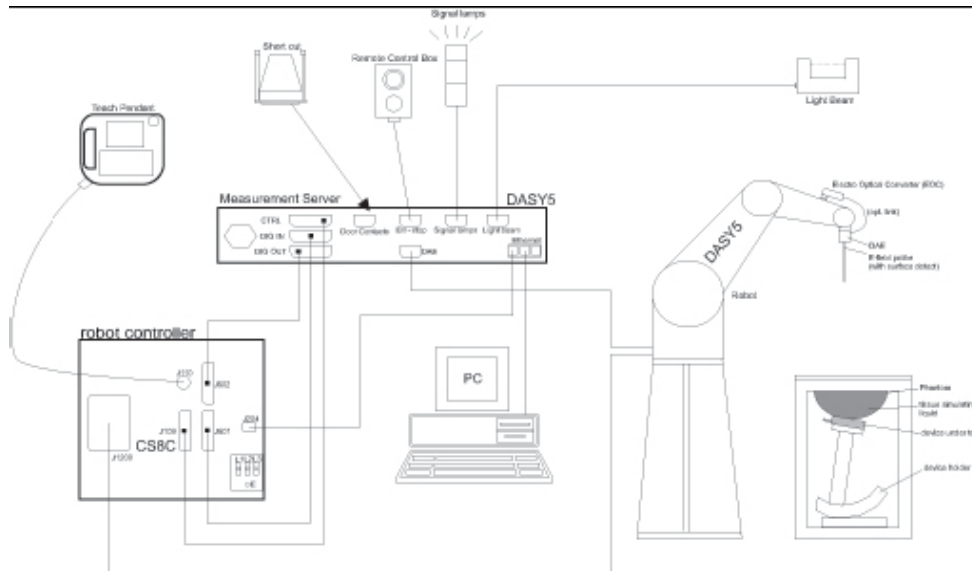

**Picture C.1 SAR Lab Test Measurement Set-up**

- A standard high precision 6-axis robot (StäubliTX=RX family) with controller, teach pendant and software. An arm extension for accommodating the data acquisition electronics (DAE).
- An isotropic field probe optimized and calibrated for the targeted measurement.
- A data acquisition electronics (DAE) which performs the signal amplification, signal multiplexing, AD-conversion, offset measurements, mechanical surface detection, collision detection, etc. The unit is battery powered with standard or rechargeable batteries. The signal is optically transmitted to the EOC.
- The Electro-optical converter (EOC) performs the conversion from optical to electrical signals for the digital communication to the DAE. To use optical surface detection, a special version of the EOC is required. The EOC signal is transmitted to the measurement server.
- The function of the measurement server is to perform the time critical tasks such as signal filtering, control of the robot operation and fast movement interrupts.
- The Light Beam used is for probe alignment. This improves the (absolute) accuracy of the probe positioning.
- A computer running WinXP and the DASY4 or DASY5 software.
- Remote control and teach pendant as well as additional circuitry for robot safety such as
- warning lamps, etc.
- The phantom, the device holder and other accessories according to the targeted measurement.

## C.2 Dasy4 or DASY5 E-field Probe System

The SAR measurements were conducted with the dosimetric probe designed in the classical triangular configuration and optimized for dosimetric evaluation. The probe is constructed using the thick film technique; with printed resistive lines on ceramic substrates. The probe is equipped with an optical multifiber line ending at the front of the probe tip. It is connected to the EOC box on the robot arm and provides an automatic detection of the phantom surface. Half of the fibers are connected to a pulsed infrared transmitter, the other half to a synchronized receiver. As the probe approaches the surface, the reflection from the surface produces a coupling from the transmitting to the receiving fibers. This reflection increases first during the approach, reaches maximum and then decreases. If the probe is flatly touching the surface, the coupling is zero. The distance of the coupling maximum to the surface is independent of the surface reflectivity and largely independent of the surface to probe angle. The DASY4 or DASY5 software reads the reflection during a software approach and looks for the maximum using 2<sup>nd</sup> ord curve fitting. The approach is stopped at reaching the maximum.

### Probe Specifications:

<b>Model:</b>	<b>ES3DV3, EX3DV4</b>
<b>Frequency</b>	<b>10MHz — 6.0GHz(EX3DV4)</b>
<b>Range:</b>	<b>10MHz — 4GHz(ES3DV3)</b>
<b>Calibration:</b>	<b>In head and body simulating tissue at Frequencies from 835 up to 5800MHz</b>
<b>Linearity:</b>	<b>± 0.2 dB(30 MHz to 6 GHz) for EX3DV4 ± 0.2 dB(30 MHz to 4 GHz) for ES3DV3</b>
<b>DynamicRange:</b>	<b>10 mW/kg — 100W/kg</b>
<b>Probe Length:</b>	<b>330 mm</b>
<b>Probe Tip</b>	
<b>Length:</b>	<b>20 mm</b>
<b>Body Diameter:</b>	<b>12 mm</b>
<b>Tip Diameter:</b>	<b>2.5 mm (3.9 mm for ES3DV3)</b>
<b>Tip-Center:</b>	<b>1 mm (2.0mm for ES3DV3)</b>
<b>Application:</b>	<b>SAR Dosimetry Testing Compliance tests of mobile phones Dosimetry in strong gradient fields</b>



Picture C.2Near-field Probe



Picture C.3E-field Probe

## C.3 E-field Probe Calibration

Each E-Probe/Probe Amplifier combination has unique calibration parameters. A TEM cell calibration procedure is conducted to determine the proper amplifier settings to enter in the probe parameters. The amplifier settings are determined for a given frequency by subjecting the probe to a known E-field density (1 mW/cm<sup>2</sup>) using an RF Signal generator, TEM cell, and RF Power Meter.

The free space E-field from amplified probe outputs is determined in a test chamber. This calibration can be performed in a TEM cell if the frequency is below 1 GHz and in a waveguide or other methodologies above 1 GHz for free space. For the free space calibration, the probe is placed

in the volumetric center of the cavity and at the proper orientation with the field. The probe is then rotated 360 degrees until the three channels show the maximum reading. The power density readings equates to 1 mW/cm<sup>2</sup>.

E-field temperature correlation calibration is performed in a flat phantom filled with the appropriate simulated brain tissue. The E-field in the medium correlates with the temperature rise in the dielectric medium. For temperature correlation calibration a RF transparent thermistor-based temperature probe is used in conjunction with the E-field probe.

$$SAR = C \frac{\Delta T}{\Delta t}$$

Where:

$\Delta t$  = Exposure time (30 seconds),

C = Heat capacity of tissue (brain or muscle),

$\Delta T$  = Temperature increase due to RF exposure.

$$SAR = \frac{|E|^2 \cdot \sigma}{\rho}$$

Where:

$\sigma$  = Simulated tissue conductivity,

$\rho$  = Tissue density (kg/m<sup>3</sup>).

## C.4 Other Test Equipment

### C.4.1 Data Acquisition Electronics(DAE)

The data acquisition electronics consist of a highly sensitive electrometer-grade preamplifier with auto-zeroing, a channel and gain-switching multiplexer, a fast 16 bit AD-converter and a command decoder with a control logic unit. Transmission to the measurement server is accomplished through an optical downlink for data and status information, as well as an optical uplink for commands and the clock.

The mechanical probe mounting device includes two different sensor systems for frontal and sideways probe contacts. They are used for mechanical surface detection and probe collision detection.

The input impedance of the DAE is 200 MOhm; the inputs are symmetrical and floating. Common mode rejection is above 80 dB.



PictureC.4: DAE

### C.4.2 Robot

The SPEAG DASY system uses the high precision robots (DASY4: RX90XL; DASY5: RX160L) type from Stäubli SA (France). For the 6-axis controller system, the robot controller version from Stäubli is used. The Stäubli robot series have many features that are important for our application:

- High precision (repeatability 0.02mm)
- High reliability (industrial design)
- Low maintenance costs (virtually maintenance free due to direct drive gears; no belt drives)
- Jerk-free straight movements (brushless synchron motors; no stepper motors)
- Low ELF interference (motor control fields shielded via the closed metallic construction shields)



Picture C.5 DASY 4



Picture C.6 DASY 5

### C.4.3 Measurement Server

The Measurement server is based on a PC/104 CPU board with CPU (dasy4: 166 MHz, Intel Pentium; DASY5: 400 MHz, Intel Celeron), chipdisk (DASY4: 32 MB; DASY5: 128MB), RAM (DASY4: 64 MB, DASY5: 128MB). The necessary circuits for communication with the DAE electronic box, as well as the 16 bit AD converter system for optical detection and digital I/O interface are contained on the DASY I/O board, which is directly connected to the PC/104 bus of the CPU board.

The measurement server performs all real-time data evaluation of field measurements and surface detection, controls robot movements and handles safety operation. The PC operating system cannot interfere with these time critical processes. All connections are supervised by a watchdog, and disconnection of any of the cables to the measurement server will automatically disarm the robot and disable all program-controlled robot movements. Furthermore, the measurement server is equipped with an expansion port which is reserved for future applications. Please note that this expansion port does not have a standardized pinout, and therefore only devices provided by SPEAG can be connected. Devices from any other supplier could seriously damage the measurement server.



Picture C.7 Server for DASY 4



Picture C.8 Server for DASY 5

#### C.4.4 Device Holder for Phantom

The SAR in the phantom is approximately inversely proportional to the square of the distance between the source and the liquid surface. For a source at 5mm distance, a positioning uncertainty of  $\pm 0.5\text{mm}$  would produce a SAR uncertainty of  $\pm 20\%$ . Accurate device positioning is therefore crucial for accurate and repeatable measurements. The positions in which the devices must be measured are defined by the standards.

The DASY device holder is designed to cope with the different positions given in the standard. It has two scales for device rotation (with respect to the body axis) and device inclination (with respect to the line between the ear reference points). The rotation centers for both scales are the ear reference point (ERP). Thus the device needs no repositioning when changing the angles. The DASY device holder is constructed of low-loss POM material having the following dielectric parameters: relative permittivity  $\epsilon = 3$  and loss tangent  $\delta = 0.02$ . The amount of dielectric material has been reduced in the closest vicinity of the device, since measurements have suggested that the influence of the clamp on the test results could thus be lowered.

<Laptop Extension Kit>

The extension is lightweight and made of POM, acrylic glass and foam. It fits easily on the upper part of the Mounting Device in place of the phone positioner. The extension is fully compatible with the Twin-SAM and ELI phantoms.



Picture C.9-1: Device Holder

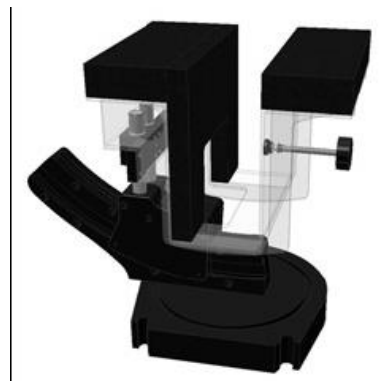

Picture C.9-2: Laptop Extension Kit

#### C.4.5 Phantom

The SAM Twin Phantom V4.0 is constructed of a fiberglass shell integrated in a table. The shape of the shell is based on data from an anatomical study designed to

Represent the 90<sup>th</sup> percentile of the population. The phantom enables the dissymmetric evaluation of SAR for both left and right handed handset usage, as well as body-worn usage using the flat phantom region. Reference markings on the Phantom allow the complete setup of all predefined phantom positions and measurement grids by manually teaching three points in the robot. The shell phantom has a 2mm shell thickness (except the ear region where shell thickness increases to 6 mm).

Shell Thickness:  $2 \pm 0.2$  mm

Filling Volume: Approx. 25 liters

Dimensions: 810 x 1000 x 500 mm (H x L x W)

Available: Special



**Picture C.10: SAM Twin Phantom**

## ANNEX D Position of the wireless device in relation to the phantom

### D.1 Body-supported device

Other devices that fall into this category include tablet type portable computers and credit card transaction authorisation terminals, point-of-sale and/or inventory terminals. Where these devices may be torso or limb-supported, the same principles for body-supported devices are applied. The example in Picture D.1 shows a tablet form factor portable computer for which SAR should be separately assessed with

- a) each surface and
- b) the separation distances

positioned against the flat phantom that correspond to the intended use as specified by the manufacturer. If the intended use is not specified in the user instructions, the device shall be tested directly against the flat phantom in all usable orientations.

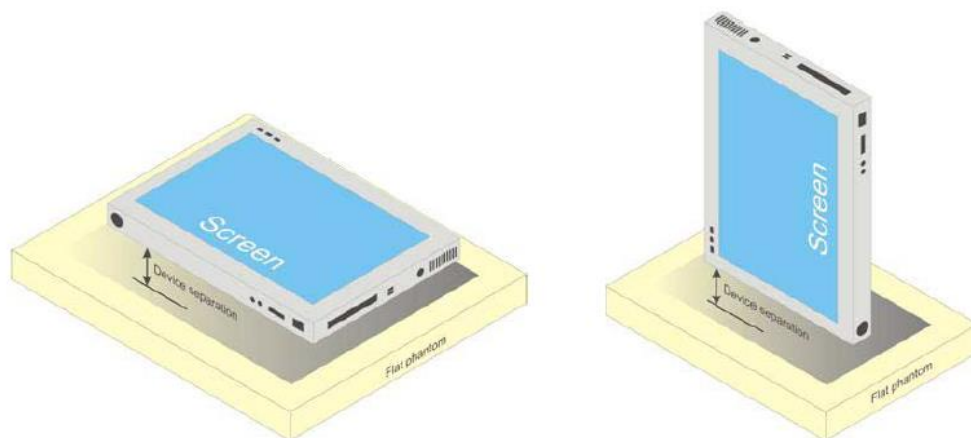

Picture D.1 Tablet form factor portable computer

### D.2 DUT Setup Photos



Picture D.2



## ANNEX E Equivalent Media Recipes

The liquid used for the frequency range of 800-3000 MHz consisted of water, sugar, salt, preventol, glycol monobutyl and Cellulose. The liquid has been previously proven to be suited for worst-case. The Table E.1 shows the detail solution. It's satisfying the latest tissue dielectric parameters requirements proposed by the IEEE 1528 and IEC 62209.

**TableE.1: Composition of the Tissue Equivalent Matter**

Frequency (MHz)	835Head	835Body	1900 Head	1900 Body	2450 Head	2450 Body	5800 Head	5800 Body
Ingredients (% by weight)								
Water	41.45	52.5	55.242	69.91	58.79	72.60	65.53	65.53
Sugar	56.0	45.0	\	\	\	\	\	\
Salt	1.45	1.4	0.306	0.13	0.06	0.18	\	\
Preventol	0.1	0.1	\	\	\	\	\	\
Cellulose	1.0	1.0	\	\	\	\	\	\
Glycol Monobutyl	\	\	44.452	29.96	41.15	27.22	\	\
Diethylenglycol monohexylether	\	\	\	\	\	\	17.24	17.24
Triton X-100	\	\	\	\	\	\	17.24	17.24
Dielectric Parameters	$\epsilon=41.5$	$\epsilon=55.2$	$\epsilon=40.0$	$\epsilon=53.3$	$\epsilon=39.2$	$\epsilon=52.7$	$\epsilon=35.3$	$\epsilon=48.2$
Target Value	$\sigma=0.90$	$\sigma=0.97$	$\sigma=1.40$	$\sigma=1.52$	$\sigma=1.80$	$\sigma=1.95$	$\sigma=5.27$	$\sigma=6.00$

**Note: There are a little adjustment respectively for 750, 1750, 2600, 5G based on the recipe of closest frequency in table E.1.**

## ANNEX F System Validation

The SAR system must be validated against its performance specifications before it is deployed. When SAR probes, system components or software are changed, upgraded or recalibrated, these must be validated with the SAR system(s) that operates with such components.

**Table F.1: System Validation for 7600**

Probe SN.	Liquid name	Validation date	Frequency point	Status (OK or Not)
7600	Head 750MHz	December 2, 2020	750 MHz	OK
7600	Head 900MHz	December 2, 2020	900 MHz	OK
7600	Head 1450MHz	December 3, 2020	1450 MHz	OK
7600	Head 1640MHz	December 3, 2020	1640 MHz	OK
7600	Head 1750MHz	December 3, 2020	1750 MHz	OK
7600	Head 1900MHz	December 4, 2020	1900 MHz	OK
7600	Head 2000MHz	December 4, 2020	2000 MHz	OK
7600	Head 2300MHz	December 4, 2020	2300 MHz	OK
7600	Head 2450MHz	December 5, 2020	2450 MHz	OK
7600	Head 2600MHz	December 5, 2020	2600 MHz	OK
7600	Head 3300MHz	December 6, 2020	3300 MHz	OK
7600	Head 3500MHz	December 6, 2020	3500 MHz	OK
7600	Head 3700MHz	December 6, 2020	3700 MHz	OK
7600	Head 3900MHz	December 7, 2020	3900 MHz	OK
7600	Head 4100MHz	December 7, 2020	4100MHz	OK
7600	Head 4200MHz	December 7, 2020	4200MHz	OK
7600	Head 4400MHz	December 8, 2020	4400MHz	OK
7600	Head 4600MHz	December 8, 2020	4600MHz	OK
7600	Head 4800MHz	December 8, 2020	4800MHz	OK
7600	Head 4950MHz	December 8, 2020	4950MHz	OK
7600	Head 5250MHz	December 9, 2020	5250MHz	OK
7600	Head 5600MHz	December 9, 2020	5600 MHz	OK
7600	Head 5750MHz	December 9, 2020	5750 MHz	OK



# ANNEX G Probe Calibration Certificate

## Probe 7600 Calibration Certificate



Add: No.51 Xueyuan Road, Haidian District, Beijing, 100191, China  
Tel: +86-10-62304633-2512 Fax: +86-10-62304633-2504  
E-mail: cttl@chinattl.com [Http://www.chinattl.cn](http://www.chinattl.cn)



中国认可  
国际互认  
校准  
CALIBRATION  
CNAS L0570

Client

CTTL

Certificate No: Z20-60421

CALIBRATION CERTIFICATE			
Object	EX3DV4 - SN : 7600		
Calibration Procedure(s)	FF-Z11-004-02 Calibration Procedures for Dosimetric E-field Probes		
Calibration date:	November 30, 2020		
This calibration Certificate documents the traceability to national standards, which realize the physical units of measurements(SI). The measurements and the uncertainties with confidence probability are given on the following pages and are part of the certificate.			
All calibrations have been conducted in the closed laboratory facility: environment temperature(22±3)°C and humidity<70%.			
Calibration Equipment used (M&TE critical for calibration)			
Primary Standards	ID #	Cal Date(Calibrated by, Certificate No.)	Scheduled Calibration
Power Meter NRP2	101919	16-Jun-20(CTTL, No.J20X04344)	Jun-21
Power sensor NRP-Z91	101547	16-Jun-20(CTTL, No.J20X04344)	Jun-21
Power sensor NRP-Z91	101548	16-Jun-20(CTTL, No.J20X04344)	Jun-21
Reference 10dBAttenuator	18N50W-10dB	10-Feb-20(CTTL, No.J20X00525)	Feb-22
Reference 20dBAttenuator	18N50W-20dB	10-Feb-20(CTTL, No.J20X00526)	Feb-22
Reference Probe EX3DV4	SN 7307	29-May-20(SPEAG, No.EX3-7307_May20)	May-21
DAE4	SN 1556	4-Feb-20(SPEAG, No.DAE4-1556_Feb20)	Feb-21
Secondary Standards	ID #	Cal Date(Calibrated by, Certificate No.)	Scheduled Calibration
SignalGenerator MG3700A	6201052605	23-Jun-20(CTTL, No.J20X04343)	Jun-21
Network Analyzer E5071C	MY46110673	10-Feb-20(CTTL, No.J20X00515)	Feb-21
Calibrated by:	Name Yu Zongying	Function SAR Test Engineer	Signature 
Reviewed by:	Name Lin Hao	Function SAR Test Engineer	Signature 
Approved by:	Name Qi Dianyuan	Function SAR Project Leader	Signature 
Issued: December 02, 2020			
This calibration certificate shall not be reproduced except in full without written approval of the laboratory.			

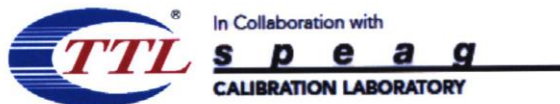

Add: No.51 Xueyuan Road, Haidian District, Beijing, 100191, China  
Tel: +86-10-62304633-2512 Fax: +86-10-62304633-2504  
E-mail: cttl@chinattl.com [Http://www.chinattl.cn](http://www.chinattl.cn)

### Glossary:

TSL	tissue simulating liquid
NORM <sub>x,y,z</sub>	sensitivity in free space
ConvF	sensitivity in TSL / NORM <sub>x,y,z</sub>
DCP	diode compression point
CF	crest factor (1/duty_cycle) of the RF signal
A,B,C,D	modulation dependent linearization parameters
Polarization $\Phi$	$\Phi$ rotation around probe axis
Polarization $\theta$	$\theta$ rotation around an axis that is in the plane normal to probe axis (at measurement center), $i$ $\theta=0$ is normal to probe axis
Connector Angle	information used in DASY system to align probe sensor X to the robot coordinate system

### Calibration is Performed According to the Following Standards:

- IEEE Std 1528-2013, "IEEE Recommended Practice for Determining the Peak Spatial-Averaged Specific Absorption Rate (SAR) in the Human Head from Wireless Communications Devices: Measurement Techniques", June 2013
- IEC 62209-1, "Measurement procedure for the assessment of Specific Absorption Rate (SAR) from hand-held and body-mounted devices used next to the ear (frequency range of 300 MHz to 6 GHz)", July 2016
- IEC 62209-2, "Procedure to determine the Specific Absorption Rate (SAR) for wireless communication devices used in close proximity to the human body (frequency range of 30 MHz to 6 GHz)", March 2010
- KDB 865664, "SAR Measurement Requirements for 100 MHz to 6 GHz"

### Methods Applied and Interpretation of Parameters:

- NORM<sub>x,y,z</sub>:** Assessed for E-field polarization  $\theta=0$  ( $f \leq 900$  MHz in TEM-cell;  $f > 1800$  MHz: waveguide). NORM<sub>x,y,z</sub> are only intermediate values, i.e., the uncertainties of NORM<sub>x,y,z</sub> does not effect the  $E^2$ -field uncertainty inside TSL (see below ConvF).
- NORM( $f$ )<sub>x,y,z</sub> = NORM<sub>x,y,z</sub> \* frequency\_response** (see Frequency Response Chart). This linearization is implemented in DASY4 software versions later than 4.2. The uncertainty of the frequency response is included in the stated uncertainty of ConvF.
- DCP<sub>x,y,z</sub>:** DCP are numerical linearization parameters assessed based on the data of power sweep (no uncertainty required). DCP does not depend on frequency nor media.
- PAR:** PAR is the Peak to Average Ratio that is not calibrated but determined based on the signal characteristics.
- A<sub>x,y,z</sub>; B<sub>x,y,z</sub>; C<sub>x,y,z</sub>; VR<sub>x,y,z</sub>; A,B,C** are numerical linearization parameters assessed based on the data of power sweep for specific modulation signal. The parameters do not depend on frequency nor media. VR is the maximum calibration range expressed in RMS voltage across the diode.
- ConvF and Boundary Effect Parameters:** Assessed in flat phantom using E-field (or Temperature Transfer Standard for  $f \leq 800$  MHz) and inside waveguide using analytical field distributions based on power measurements for  $f > 800$  MHz. The same setups are used for assessment of the parameters applied for boundary compensation (alpha, depth) of which typical uncertainty valued are given. These parameters are used in DASY4 software to improve probe accuracy close to the boundary. The sensitivity in TSL corresponds to NORM<sub>x,y,z</sub> \* ConvF whereby the uncertainty corresponds to that given for ConvF. A frequency dependent ConvF is used in DASY version 4.4 and higher which allows extending the validity from  $\pm 50$  MHz to  $\pm 100$  MHz.
- Spherical isotropy (3D deviation from isotropy):** in a field of low gradients realized using a flat phantom exposed by a patch antenna.
- Sensor Offset:** The sensor offset corresponds to the offset of virtual measurement center from the probe tip (on probe axis). No tolerance required.
- Connector Angle:** The angle is assessed using the information gained by determining the NORM<sub>x</sub> (no uncertainty required).

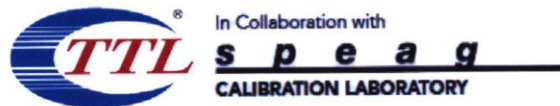

Add: No.51 Xueyuan Road, Haidian District, Beijing, 100191, China  
 Tel: +86-10-62304633-2512 Fax: +86-10-62304633-2504  
 E-mail: cttl@chinattl.com [Http://www.chinattl.cn](http://www.chinattl.cn)

## DASY/EASY – Parameters of Probe: EX3DV4 – SN:7600

### Basic Calibration Parameters

	Sensor X	Sensor Y	Sensor Z	Unc (k=2)
Norm( $\mu\text{V}/(\text{V}/\text{m})^2$ ) <sup>A</sup>	0.70	0.65	0.67	±10.0%
DCP(mV) <sup>B</sup>	109.4	109.2	108.7	

### Modulation Calibration Parameters

UID	Communication System Name		A dB	B dB/μV	C	D dB	VR mV	Unc <sup>E</sup> (k=2)
0	CW	X	0.0	0.0	1.0	0.00	225.0	±2.1%
		Y	0.0	0.0	1.0		206.5	
		Z	0.0	0.0	1.0		212.8	

The reported uncertainty of measurement is stated as the standard uncertainty of Measurement multiplied by the coverage factor  $k=2$ , which for a normal distribution Corresponds to a coverage probability of approximately 95%.

<sup>A</sup> The uncertainties of Norm X, Y, Z do not affect the E<sup>2</sup>-field uncertainty inside TSL (see Page 4).

<sup>B</sup> Numerical linearization parameter: uncertainty not required.

<sup>E</sup> Uncertainty is determined using the max. deviation from linear response applying rectangular distribution and is expressed for the square of the field value.



Add: No.51 Xueyuan Road, Haidian District, Beijing, 100191, China  
 Tel: +86-10-62304633-2512 Fax: +86-10-62304633-2504  
 E-mail: cttl@chinattl.com [Http://www.chinattl.cn](http://www.chinattl.cn)

## DASY/EASY – Parameters of Probe: EX3DV4 – SN:7600

### Calibration Parameter Determined in Head Tissue Simulating Media

f [MHz] <sup>C</sup>	Relative Permittivity <sup>F</sup>	Conductivity (S/m) <sup>F</sup>	ConvF X	ConvF Y	ConvF Z	Alpha <sup>G</sup>	Depth <sup>G</sup> (mm)	Unct. (k=2)
750	41.9	0.89	10.88	10.88	10.88	0.40	0.77	±12.1%
900	41.5	0.97	10.45	10.45	10.45	0.17	1.31	±12.1%
1450	40.5	1.20	9.28	9.28	9.28	0.10	1.40	±12.1%
1640	40.3	1.29	9.10	9.10	9.10	0.21	1.03	±12.1%
1750	40.1	1.37	9.01	9.01	9.01	0.20	1.11	±12.1%
1900	40.0	1.40	8.70	8.70	8.70	0.26	1.03	±12.1%
2000	40.0	1.40	8.68	8.68	8.68	0.21	1.16	±12.1%
2300	39.5	1.67	8.19	8.19	8.19	0.37	0.88	±12.1%
2450	39.2	1.80	7.79	7.79	7.79	0.35	1.00	±12.1%
2600	39.0	1.96	7.67	7.67	7.67	0.46	0.80	±12.1%
3300	38.2	2.71	7.35	7.35	7.35	0.43	0.95	±13.3%
3500	37.9	2.91	7.01	7.01	7.01	0.44	0.94	±13.3%
3700	37.7	3.12	6.77	6.77	6.77	0.42	1.02	±13.3%
3900	37.5	3.32	6.85	6.85	6.85	0.35	1.30	±13.3%
4100	37.2	3.53	6.75	6.75	6.75	0.40	1.15	±13.3%
4200	37.1	3.63	6.65	6.65	6.65	0.35	1.35	±13.3%
4400	36.9	3.84	6.54	6.54	6.54	0.35	1.35	±13.3%
4600	36.7	4.04	6.39	6.39	6.39	0.45	1.25	±13.3%
4800	36.4	4.25	6.34	6.34	6.34	0.40	1.42	±13.3%
4950	36.3	4.40	6.01	6.01	6.01	0.45	1.30	±13.3%
5250	35.9	4.71	5.68	5.68	5.68	0.45	1.30	±13.3%
5600	35.5	5.07	5.11	5.11	5.11	0.50	1.25	±13.3%
5750	35.4	5.22	5.07	5.07	5.07	0.50	1.25	±13.3%

<sup>C</sup> Frequency validity above 300 MHz of ±100MHz only applies for DASY v4.4 and higher (Page 2), else it is restricted to ±50MHz. The uncertainty is the RSS of ConvF uncertainty at calibration frequency and the uncertainty for the indicated frequency band. Frequency validity below 300 MHz is ± 10, 25, 40, 50 and 70 MHz for ConvF assessments at 30, 64, 128, 150 and 220 MHz respectively. Above 5 GHz frequency validity can be extended to ± 110 MHz.

<sup>F</sup> At frequency below 3 GHz, the validity of tissue parameters ( $\epsilon$  and  $\sigma$ ) can be relaxed to ±10% if liquid compensation formula is applied to measured SAR values. At frequencies above 3 GHz, the validity of tissue parameters ( $\epsilon$  and  $\sigma$ ) is restricted to ±5%. The uncertainty is the RSS of the ConvF uncertainty for indicated target tissue parameters.

<sup>G</sup> Alpha/Depth are determined during calibration. SPEAG warrants that the remaining deviation due to the boundary effect after compensation is always less than ± 1% for frequencies below 3 GHz and below ± 2% for the frequencies between 3-6 GHz at any distance larger than half the probe tip diameter from the boundary.

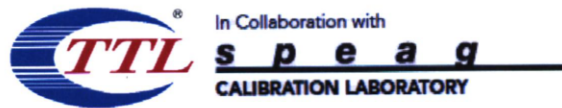

Add: No.51 Xueyuan Road, Haidian District, Beijing, 100191, China  
Tel: +86-10-62304633-2512 Fax: +86-10-62304633-2504  
E-mail: cttl@chinattl.com [Http://www.chinattl.cn](http://www.chinattl.cn)

### Frequency Response of E-Field (TEM-Cell: ifi110 EXX, Waveguide: R22)

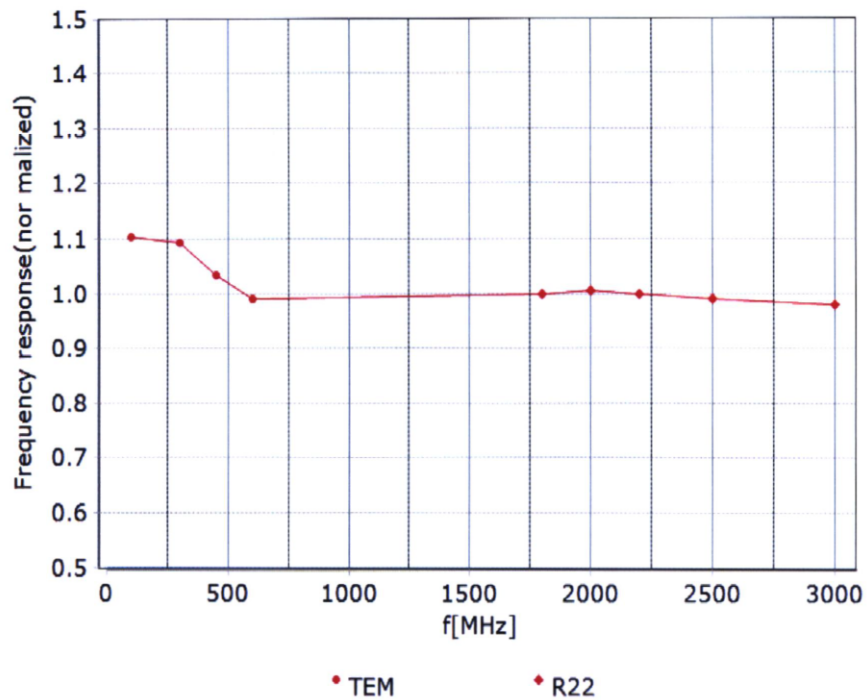

Uncertainty of Frequency Response of E-field:  $\pm 7.4\%$  ( $k=2$ )



Add: No.51 Xueyuan Road, Haidian District, Beijing, 100191, China  
 Tel: +86-10-62304633-2512 Fax: +86-10-62304633-2504  
 E-mail: cttl@chinattl.com [Http://www.chinattl.cn](http://www.chinattl.cn)

### Receiving Pattern ( $\Phi$ ), $\theta=0^\circ$

**f=600 MHz, TEM**

**f=1800 MHz, R22**

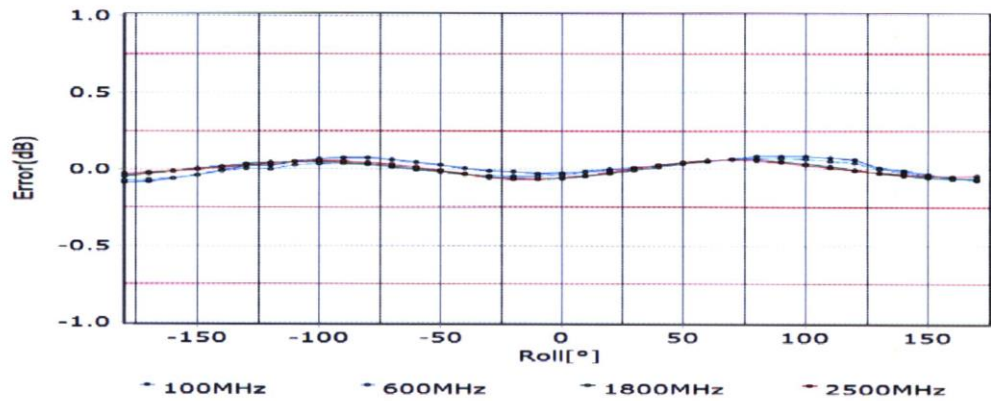
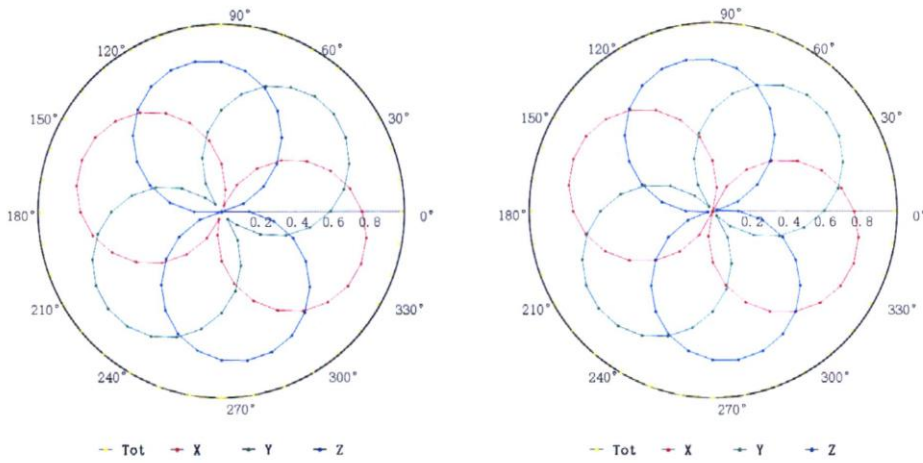

Uncertainty of Axial Isotropy Assessment:  $\pm 1.2\%$  ( $k=2$ )





Add: No.51 Xueyuan Road, Haidian District, Beijing, 100191, China  
 Tel: +86-10-62304633-2512 Fax: +86-10-62304633-2504  
 E-mail: cttl@chinattl.com [Http://www.chinattl.cn](http://www.chinattl.cn)

### Dynamic Range f(SAR<sub>head</sub>) (TEM cell, f = 900 MHz)

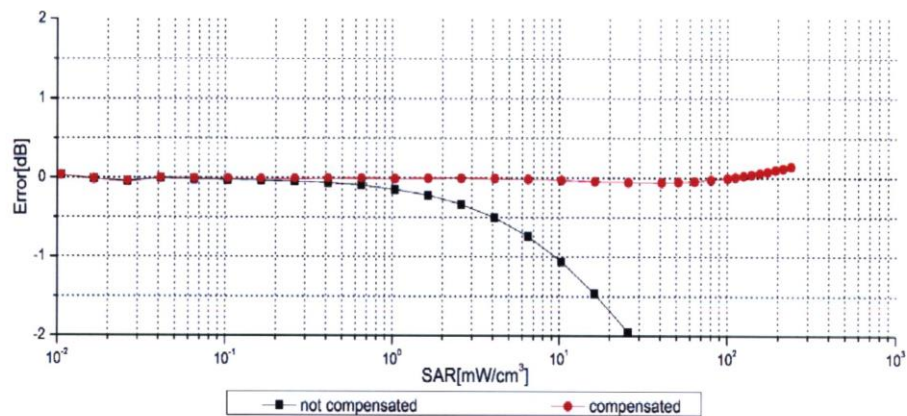
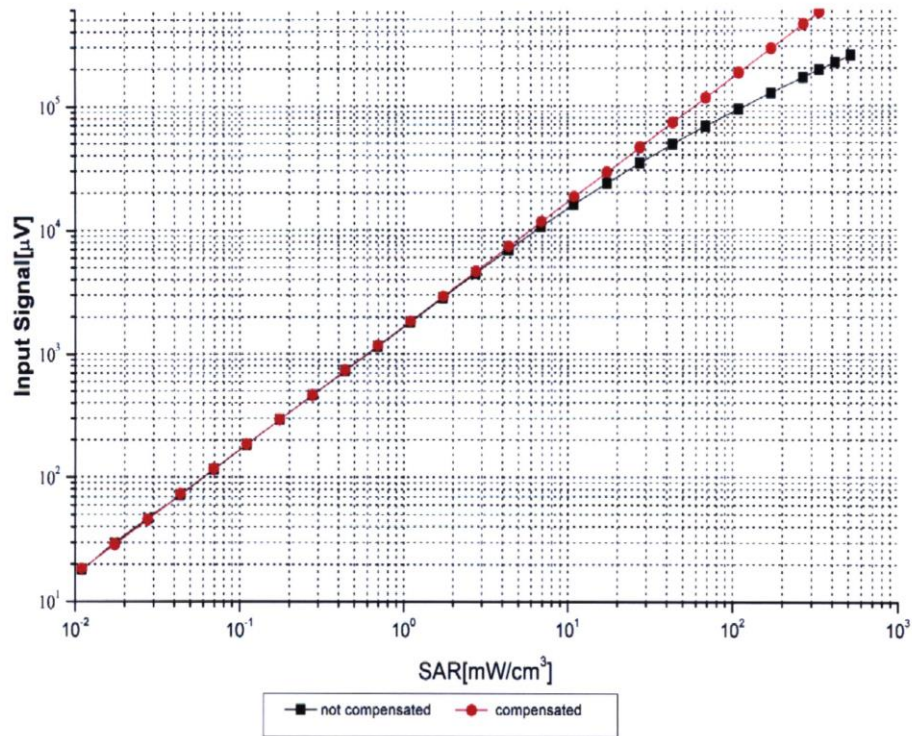

Uncertainty of Linearity Assessment:  $\pm 0.9\%$  ( $k=2$ )

## Conversion Factor Assessment

f=750 MHz,WGLS R9(H\_convF)

f=1750 MHz,WGLS R22(H\_convF)

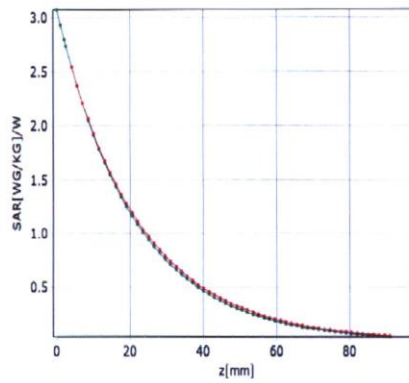

\* analytical \* measured

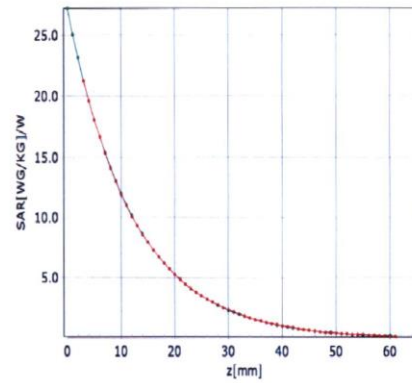

\* analytical \* measured

## Deviation from Isotropy in Liquid

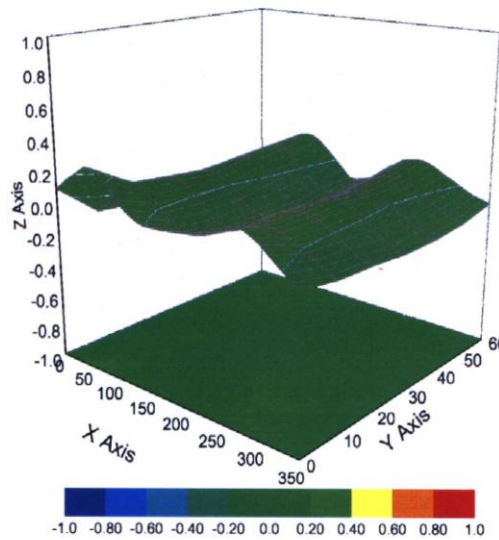

Uncertainty of Spherical Isotropy Assessment:  $\pm 3.2\%$  ( $k=2$ )



Add: No.51 Xueyuan Road, Haidian District, Beijing, 100191, China  
Tel: +86-10-62304633-2512 Fax: +86-10-62304633-2504  
E-mail: [cttl@chinattl.com](mailto:cttl@chinattl.com) [Http://www.chinattl.cn](http://www.chinattl.cn)

## DASY/EASY – Parameters of Probe: EX3DV4 – SN:7600

### Other Probe Parameters

Sensor Arrangement	Triangular
Connector Angle (°)	40.7
Mechanical Surface Detection Mode	enabled
Optical Surface Detection Mode	disable
Probe Overall Length	337mm
Probe Body Diameter	10mm
Tip Length	10mm
Tip Diameter	2.5mm
Probe Tip to Sensor X Calibration Point	1mm
Probe Tip to Sensor Y Calibration Point	1mm
Probe Tip to Sensor Z Calibration Point	1mm
Recommended Measurement Distance from Surface	1.4mm



# ANNEX H Dipole Calibration Certificate

## 2450 MHz Dipole Calibration Certificate

Calibration Laboratory of  
Schmid & Partner  
Engineering AG  
Zeughausstrasse 43, 8004 Zurich, Switzerland



S Schweizerischer Kalibrierdienst  
C Service suisse d'étalonnage  
S Servizio svizzero di taratura  
S Swiss Calibration Service

Accredited by the Swiss Accreditation Service (SAS)  
The Swiss Accreditation Service is one of the signatories to the EA  
Multilateral Agreement for the recognition of calibration certificates

Accreditation No.: SCS 0108

Client **CTTL-BJ (Auden)**

Certificate No: **D2450V2-853\_Jul20**

### CALIBRATION CERTIFICATE

Object: **D2450V2 - SN:853**

Calibration procedure(s): **QA CAL-05.v11  
Calibration Procedure for SAR Validation Sources between 0.7-3 GHz**

Calibration date: **July 21, 2020**

This calibration certificate documents the traceability to national standards, which realize the physical units of measurements (SI). The measurements and the uncertainties with confidence probability are given on the following pages and are part of the certificate.

All calibrations have been conducted in the closed laboratory facility: environment temperature (22 ± 3)°C and humidity < 70%.

Calibration Equipment used (M&TE critical for calibration)

Primary Standards	ID #	Cal Date (Certificate No.)	Scheduled Calibration
Power meter NRP	SN: 104778	01-Apr-20 (No. 217-03100/03101)	Apr-21
Power sensor NRP-Z91	SN: 103244	01-Apr-20 (No. 217-03100)	Apr-21
Power sensor NRP-Z91	SN: 103245	01-Apr-20 (No. 217-03101)	Apr-21
Reference 20 dB Attenuator	SN: BH9394 (20k)	31-Mar-20 (No. 217-03106)	Apr-21
Type-N mismatch combination	SN: 310982 / 06327	31-Mar-20 (No. 217-03104)	Apr-21
Reference Probe EX3DV4	SN: 7349	29-Jun-20 (No. EX3-7349_Jun20)	Jun-21
DAE4	SN: 601	27-Dec-19 (No. DAE4-601_Dec19)	Dec-20

Secondary Standards	ID #	Check Date (in house)	Scheduled Check
Power meter E4419B	SN: GB39512475	30-Oct-14 (in house check Feb-19)	In house check: Oct-20
Power sensor HP 8481A	SN: US37292783	07-Oct-15 (in house check Oct-18)	In house check: Oct-20
Power sensor HP 8481A	SN: MY41092317	07-Oct-15 (in house check Oct-18)	In house check: Oct-20
RF generator R&S SMT-06	SN: 100972	15-Jun-15 (in house check Oct-18)	In house check: Oct-20
Network Analyzer Agilent E8358A	SN: US41080477	31-Mar-14 (in house check Oct-19)	In house check: Oct-20

Calibrated by:	Name <b>Jeffrey Katzman</b>	Function Laboratory Technician	Signature 
Approved by:	Name <b>Katja Pokovic</b>	Technical Manager	

Issued: July 23, 2020

This calibration certificate shall not be reproduced except in full without written approval of the laboratory.

**Calibration Laboratory of**  
Schmid & Partner  
Engineering AG  
Zeughausstrasse 43, 8004 Zurich, Switzerland



**S** Schweizerischer Kalibrierdienst  
**C** Service suisse d'étalonnage  
**S** Servizio svizzero di taratura  
**S** Swiss Calibration Service

Accredited by the Swiss Accreditation Service (SAS)  
The Swiss Accreditation Service is one of the signatories to the EA  
Multilateral Agreement for the recognition of calibration certificates

Accreditation No.: **SCS 0108**

**Glossary:**

TSL	tissue simulating liquid
ConvF	sensitivity in TSL / NORM x,y,z
N/A	not applicable or not measured

**Calibration is Performed According to the Following Standards:**

- IEEE Std 1528-2013, "IEEE Recommended Practice for Determining the Peak Spatial-Averaged Specific Absorption Rate (SAR) in the Human Head from Wireless Communications Devices: Measurement Techniques", June 2013
- IEC 62209-1, "Measurement procedure for the assessment of Specific Absorption Rate (SAR) from hand-held and body-mounted devices used next to the ear (frequency range of 300 MHz to 6 GHz)", July 2016
- IEC 62209-2, "Procedure to determine the Specific Absorption Rate (SAR) for wireless communication devices used in close proximity to the human body (frequency range of 30 MHz to 6 GHz)", March 2010
- KDB 865664, "SAR Measurement Requirements for 100 MHz to 6 GHz"

**Additional Documentation:**

- DASY4/5 System Handbook

**Methods Applied and Interpretation of Parameters:**

- Measurement Conditions:** Further details are available from the Validation Report at the end of the certificate. All figures stated in the certificate are valid at the frequency indicated.
- Antenna Parameters with TSL:** The dipole is mounted with the spacer to position its feed point exactly below the center marking of the flat phantom section, with the arms oriented parallel to the body axis.
- Feed Point Impedance and Return Loss:** These parameters are measured with the dipole positioned under the liquid filled phantom. The impedance stated is transformed from the measurement at the SMA connector to the feed point. The Return Loss ensures low reflected power. No uncertainty required.
- Electrical Delay:** One-way delay between the SMA connector and the antenna feed point. No uncertainty required.
- SAR measured:** SAR measured at the stated antenna input power.
- SAR normalized:** SAR as measured, normalized to an input power of 1 W at the antenna connector.
- SAR for nominal TSL parameters:** The measured TSL parameters are used to calculate the nominal SAR result.

The reported uncertainty of measurement is stated as the standard uncertainty of measurement multiplied by the coverage factor  $k=2$ , which for a normal distribution corresponds to a coverage probability of approximately 95%.

**Measurement Conditions**

DASY system configuration, as far as not given on page 1.

<b>DASY Version</b>	DASY5	V52.10.4
<b>Extrapolation</b>	Advanced Extrapolation	
<b>Phantom</b>	Modular Flat Phantom	
<b>Distance Dipole Center - TSL</b>	10 mm	with Spacer
<b>Zoom Scan Resolution</b>	dx, dy, dz = 5 mm	
<b>Frequency</b>	2450 MHz ± 1 MHz	

**Head TSL parameters**

The following parameters and calculations were applied.

	Temperature	Permittivity	Conductivity
<b>Nominal Head TSL parameters</b>	22.0 °C	39.2	1.80 mho/m
<b>Measured Head TSL parameters</b>	(22.0 ± 0.2) °C	38.5 ± 6 %	1.84 mho/m ± 6 %
<b>Head TSL temperature change during test</b>	< 0.5 °C	----	----

**SAR result with Head TSL**

<b>SAR averaged over 1 cm<sup>3</sup> (1 g) of Head TSL</b>	Condition	
SAR measured	250 mW input power	13.3 W/kg
SAR for nominal Head TSL parameters	normalized to 1W	<b>52.5 W/kg ± 17.0 % (k=2)</b>

<b>SAR averaged over 10 cm<sup>3</sup> (10 g) of Head TSL</b>	condition	
SAR measured	250 mW input power	6.17 W/kg
SAR for nominal Head TSL parameters	normalized to 1W	<b>24.5 W/kg ± 16.5 % (k=2)</b>

**Body TSL parameters**

The following parameters and calculations were applied.

	Temperature	Permittivity	Conductivity
<b>Nominal Body TSL parameters</b>	22.0 °C	52.7	1.95 mho/m
<b>Measured Body TSL parameters</b>	(22.0 ± 0.2) °C	51.4 ± 6 %	2.02 mho/m ± 6 %
<b>Body TSL temperature change during test</b>	< 0.5 °C	----	----

**SAR result with Body TSL**

<b>SAR averaged over 1 cm<sup>3</sup> (1 g) of Body TSL</b>	Condition	
SAR measured	250 mW input power	13.4 W/kg
SAR for nominal Body TSL parameters	normalized to 1W	<b>52.4 W/kg ± 17.0 % (k=2)</b>

<b>SAR averaged over 10 cm<sup>3</sup> (10 g) of Body TSL</b>	condition	
SAR measured	250 mW input power	6.22 W/kg
SAR for nominal Body TSL parameters	normalized to 1W	<b>24.6 W/kg ± 16.5 % (k=2)</b>

**Appendix (Additional assessments outside the scope of SCS 0108)****Antenna Parameters with Head TSL**

Impedance, transformed to feed point	54.6 $\Omega$ + 4.9 j $\Omega$
Return Loss	- 23.9 dB

**Antenna Parameters with Body TSL**

Impedance, transformed to feed point	49.9 $\Omega$ + 5.6 j $\Omega$
Return Loss	- 25.0 dB

**General Antenna Parameters and Design**

Electrical Delay (one direction)	1.162 ns
----------------------------------	----------

After long term use with 100W radiated power, only a slight warming of the dipole near the feedpoint can be measured.

The dipole is made of standard semirigid coaxial cable. The center conductor of the feeding line is directly connected to the second arm of the dipole. The antenna is therefore short-circuited for DC-signals. On some of the dipoles, small end caps are added to the dipole arms in order to improve matching when loaded according to the position as explained in the "Measurement Conditions" paragraph. The SAR data are not affected by this change. The overall dipole length is still according to the Standard.

No excessive force must be applied to the dipole arms, because they might bend or the soldered connections near the feedpoint may be damaged.

**Additional EUT Data**

Manufactured by	SPEAG
-----------------	-------

**DASY5 Validation Report for Head TSL**

Date: 21.07.2020

Test Laboratory: SPEAG, Zurich, Switzerland

**DUT: Dipole 2450 MHz; Type: D2450V2; Serial: D2450V2 - SN:853**

Communication System: UID 0 - CW; Frequency: 2450 MHz  
 Medium parameters used:  $f = 2450$  MHz;  $\sigma = 1.84$  S/m;  $\epsilon_r = 38.5$ ;  $\rho = 1000$  kg/m<sup>3</sup>  
 Phantom section: Flat Section  
 Measurement Standard: DASY5 (IEEE/IEC/ANSI C63.19-2011)

DASY52 Configuration:

- Probe: EX3DV4 - SN7349; ConvF(7.74, 7.74, 7.74) @ 2450 MHz; Calibrated: 29.06.2020
- Sensor-Surface: 1.4mm (Mechanical Surface Detection)
- Electronics: DAE4 Sn601; Calibrated: 27.12.2019
- Phantom: Flat Phantom 5.0 (front); Type: QD 000 P50 AA; Serial: 1001
- DASY52 52.10.4(1527); SEMCAD X 14.6.14(7483)

**Dipole Calibration for Head Tissue/Pin=250 mW, d=10mm/Zoom Scan (7x7x7)/Cube 0:**

Measurement grid: dx=5mm, dy=5mm, dz=5mm  
 Reference Value = 118.2 V/m; Power Drift = -0.05 dB  
 Peak SAR (extrapolated) = 26.2 W/kg  
**SAR(1 g) = 13.3 W/kg; SAR(10 g) = 6.17 W/kg**  
 Smallest distance from peaks to all points 3 dB below = 9 mm  
 Ratio of SAR at M2 to SAR at M1 = 51.1%  
 Maximum value of SAR (measured) = 21.8 W/kg

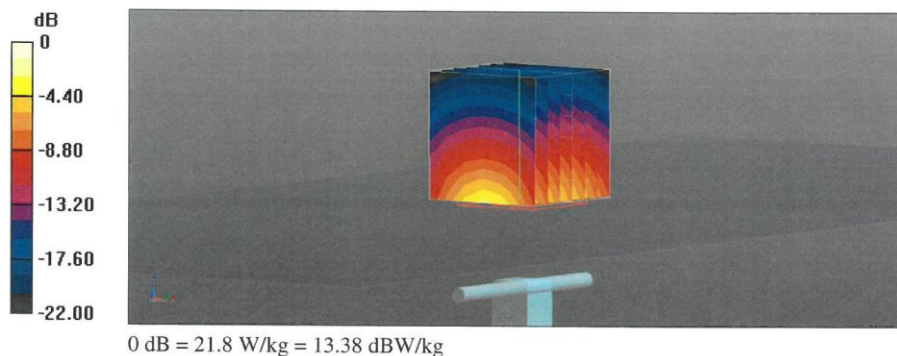



**Impedance Measurement Plot for Head TSL**

