

# Test report

**250150-1TRFWL**

Date of issue: April 23, 2014

Applicant:

**Seagate Technology LLC**

Product:

**Wireless External Hard Disk Drive**

Model:

**1AYBA4**

Model variant:

**Wireless Plus**

FCC ID:

**ZC9001AYBA4**

IC Registration number:

**9580A-1AYBA4**

Specifications:

◆ **FCC 47 CFR Part 15 Subpart C, §15.247**

Operation in the 902–928 MHz, 2400–2483.5 MHz, 5725–5850 MHz

◆ **RSS-210, Issue 8, December 2010, Annex 8**

Frequency Hopping and Digital Modulation Systems Operating in the 902–928 MHz, 2400–2483.5 MHz, and 5725–5850 MHz Bands

#### Test location

---

Company name:	Nemko Canada Inc.
Address:	303 River Road
City:	Ottawa
Province:	Ontario
Postal code:	K1V 1H2
Country:	Canada
Telephone:	+1 613 737 9680
Facsimile:	+1 613 737 9691
Toll free:	+1 800 563 6336
Website:	www.nemko.com
Site number:	FCC: 176392; IC: 2040A-4 (3 m semi anechoic chamber)

Tested by:	Andrey Adelberg, Senior Wireless/EMC Specialist
Reviewed by:	Kevin Rose, Wireless/EMC Specialist
Date:	April 23, 2014
Signature:	

#### Limits of responsibility

---

Note that the results contained in this report relate only to the items tested and were obtained in the period between the date of initial receipt of samples and the date of issue of the report.

This test report has been completed in accordance with the requirements of ISO/IEC 17025. All results contain in this report are within Nemko Canada's ISO/IEC 17025 accreditation.

#### Copyright notification

---

Nemko Canada Inc. authorizes the applicant to reproduce this report provided it is reproduced in its entirety and for use by the company's employees only. Any use which a third party makes of this report, or any reliance on or decisions to be made based on it, are the responsibility of such third parties. Nemko Canada Inc. accepts no responsibility for damages, if any, suffered by any third party as a result of decisions made or actions based on this report. © Nemko Canada Inc.

## Table of contents

<b>Table of contents</b> .....	<b>3</b>
<b>Section 1. Report summary</b> .....	<b>4</b>
1.1 Applicant and manufacturer .....	4
1.2 Test specifications .....	4
1.3 Test methods.....	4
1.4 Statement of compliance .....	4
1.5 Exclusions.....	4
1.6 Test report revision history .....	4
<b>Section 2. Summary of test results</b> .....	<b>5</b>
2.1 FCC Part 15 Subpart C, general requirements test results.....	5
2.2 FCC Part 15 Subpart C, intentional radiators test results.....	5
2.3 IC RSS-GEN, Issue 3, test results .....	5
2.4 IC RSS-210, Issue 8, test results .....	6
<b>Section 3. Equipment under test (EUT) details</b> .....	<b>7</b>
3.1 Sample information.....	7
3.2 EUT information .....	7
3.3 Technical information .....	7
3.4 Product description and theory of operation .....	7
3.5 EUT exercise details.....	7
3.6 EUT setup diagram .....	8
3.7 EUT sub assemblies .....	8
<b>Section 4. Engineering considerations</b> .....	<b>9</b>
4.1 Modifications incorporated in the EUT.....	9
4.2 Technical judgment .....	9
4.3 Deviations from laboratory tests procedures .....	9
<b>Section 5. Test conditions</b> .....	<b>10</b>
5.1 Atmospheric conditions .....	10
5.2 Power supply range.....	10
<b>Section 6. Measurement uncertainty</b> .....	<b>11</b>
6.1 Uncertainty of measurement .....	11
<b>Section 7. Test equipment</b> .....	<b>12</b>
7.1 Test equipment list.....	12
<b>Section 8. Testing data</b> .....	<b>13</b>
8.1 FCC 15.207(a) and RSS-Gen 7.2.4 AC power line conducted emissions limits .....	13
8.2 FCC 15.247(a)(2) and RSS-210 A8.2(a) Minimum 6 dB bandwidth for systems using digital modulation techniques .....	16
8.3 RSS-Gen 4.6.1 Occupied bandwidth .....	19
8.4 FCC 15.247(b) and RSS-210 A8.4 (4) Transmitter output power and e.i.r.p. requirements .....	22
8.5 FCC 15.247(d) and RSS-210 A8.5 Spurious (out-of-band) emissions.....	25
8.6 FCC 15.247(e) and RSS-210 A8.2(b) Power spectral density for digitally modulated devices .....	40
<b>Section 9. Block diagrams of test set-ups</b> .....	<b>43</b>
9.1 Radiated emissions set-up.....	43
9.2 Conducted emissions set-up .....	43

## Section 1. Report summary

---

### 1.1 Applicant and manufacturer

---

Company name	Seagate Technology LLC
Address	10200 S. DeAnza Blvd
City	Cupertino
Province/State	CA
Postal/Zip code	95014
Country	United States of America

### 1.2 Test specifications

---

FCC 47 CFR Part 15, Subpart C, Clause 15.247	Operation in the 902–928 MHz, 2400–2483.5 MHz, 5725–5850 MHz
RSS-210, Issue 8 Annex 8	Frequency Hopping and Digital Modulation Systems Operating in the 902–928 MHz, 2400–2483.5 MHz, and 5725–5850 MHz Bands

### 1.3 Test methods

---

Guidance for compliance measurements on DTS operating under 15.247	558074 D01 Meas Guidance v03r01 (April 9, 2013)
ANSI C64.3 v 2003	American National Standard for Methods of Measurement of Radio- Noise Emissions from Low-Voltage Electrical and Electronic Equipment in the Range of 9 kHz to 40 GHz

### 1.4 Statement of compliance

---

In the configuration tested, the EUT was found compliant.

Testing was completed against all relevant requirements of the test standard. Results obtained indicate that the product under test complies in full with the requirements tested. The test results relate only to the items tested.

See “Summary of test results” for full details.

In addition compliance with these standards provides a means of demonstrating conformity with the requirements of the Israeli Ministry of Communications. Units in Israel will only operate on channels 3 to 9 (2422 MHz to 2452 MHz).

### 1.5 Exclusions

---

None

### 1.6 Test report revision history

---

Revision #	Details of changes made to test report
TRF	Original report issued

## Section 2. Summary of test results

### 2.1 FCC Part 15 Subpart C, general requirements test results

Part	Test description	Verdict
§15.207(a)	Conducted limits	Pass
§15.31(e)	Variation of power source	Pass <sup>1</sup>
§15.203	Antenna requirement	Pass <sup>2</sup>

Notes: <sup>1</sup> Measurements of the variation of the input power or the radiated signal level of the fundamental frequency component of the emission, as appropriate, was performed with the supply voltage varied between 85 % and 115 % of the nominal rated supply voltage. No noticeable output power variation was observed

<sup>2</sup> The Antennas are located within the enclosure of EUT and not user accessible.

### 2.2 FCC Part 15 Subpart C, intentional radiators test results

Part	Test description	Verdict
§15.247(a)(1)(i)	Frequency hopping systems operating in the 902–928 MHz band	Not applicable
§15.247(a)(1)(ii)	Frequency hopping systems operating in the 5725–5850 MHz band	Not applicable
§15.247(a)(1)(iii)	Frequency hopping systems operating in the 2400–2483.5 MHz band	Not applicable
§15.247(a)(2)	Minimum 6 dB bandwidth for systems using digital modulation techniques	Pass
§15.247(b)(1)	Maximum peak output power of frequency hopping systems operating in the 2400–2483.5 MHz band and 5725–5850 MHz band	Not applicable
§15.247(b)(2)	Maximum peak output power of Frequency hopping systems operating in the 902–928 MHz band	Not applicable
§15.247(b)(3)	Maximum peak output power of systems using digital modulation in the 902–928 MHz, 2400–2483.5 MHz, and 5725–5850 MHz bands	Pass
§15.247(c)(1)	Fixed point-to-point operation with directional antenna gains greater than 6 dBi	Not applicable
§15.247(c)(2)	Transmitters operating in the 2400–2483.5 MHz band that emit multiple directional beams	Not applicable
§15.247(d)	Spurious emissions	Pass
§15.247(e)	Power spectral density for digitally modulated devices	Pass
§15.247(f)	Time of occupancy for hybrid systems	Not applicable

### 2.3 IC RSS-GEN, Issue 3, test results

Part	Test description	Verdict
4.6.1	Occupied bandwidth	Pass
4.7	Transmitter frequency stability	Not applicable
6.1	Receiver spurious emissions limits (radiated)	Not applicable
6.2	Receiver spurious emissions limits (antenna conducted)	Not applicable
7.2.4	AC power lines conducted emission limits	Pass

Notes: <sup>1</sup> According to Notice 2012-DRS0126 (from January 2012) section 2.2 of RSS-Gen, Issue 3 has been revised. The EUT does not have a stand-alone receiver neither scanner receiver, therefore exempt from receiver requirements.

## 2.4 IC RSS-210, Issue 8, test results

Part	Test description	Verdict
A8.1	Frequency hopping systems	
A8.1 (a)	Bandwidth of a frequency hopping channel	Not applicable
A8.1 (b)	Minimum channel spacing for frequency hopping systems	Not applicable
A8.1 (c)	Frequency hopping systems operating in the 902–928 MHz band	Not applicable
A8.1 (d)	Frequency hopping systems operating in the 2400–2483.5 MHz band	Not applicable
A8.1 (e)	Frequency hopping systems operating in the 5725–5850 MHz band	Not applicable
A8.2	Digital modulation systems	
A8.2 (a)	Minimum 6 dB bandwidth	Pass
A8.2 (b)	Maximum power spectral density	Pass
A8.3	Hybrid systems	
A8.3 (1)	Digital modulation turned off	Not applicable
A8.3 (2)	Frequency hopping turned off	Not applicable
A8.4	Transmitter output power and e.i.r.p. requirements	
A8.4 (1)	Frequency hopping systems operating in the 902–928 MHz band	Not applicable
A8.4 (2)	Frequency hopping systems operating in the 2400–2483.5 MHz band	Not applicable
A8.4 (3)	Frequency hopping systems operating in the 5725–5850 MHz	Not applicable
A8.4 (4)	Systems employing digital modulation techniques	Pass
A8.4 (5)	Point-to-point systems in 2400–2483.5 MHz and 5725–5850 MHz band	Not applicable
A8.4 (6)	Transmitters which operate in the 2400–2483.5 MHz band with multiple directional beams	Not applicable
A8.5	Out-of-band emissions	Pass

Notes: None

## Section 3. Equipment under test (EUT) details

---

### 3.1 Sample information

---

Receipt date	February 4, 2014
Nemko sample ID number	1

### 3.2 EUT information

---

Product name	Wireless External Hard Disk Drive
Model	1AYBA4
Model variant	Wireless Plus (marketing model name)
Serial number	NA302088

### 3.3 Technical information

---

Operating band	2400–2483.5 MHz
Operating frequency (FCC/IC)	2412–2462 MHz
Operating frequency (Israel)	2422–2452 MHz
Modulation type	802.11b/g/n
Occupied bandwidth (99 %)	13.89 MHz (802.11b), 16.89 MHz (802.11g), 18.00 MHz (802.11n)
Emission designator	W7D
Power requirements	3.8 V <sub>DC</sub> from battery or 5 V <sub>DC</sub> via 100–240 V <sub>AC</sub> , 50/60 Hz power supply
Antenna information	Galtronics Corporation Ltd. internal monopole antenna 3.71 dBi gain, MN: 5496 The EUT uses a unique antenna coupling/ non-detachable antenna to the intentional radiator.

### 3.4 Product description and theory of operation

---

EUT is an external hard drive with wireless 802.11b/g/n transmitter using 2.4 GHz ISM band Wi-Fi communication.

### 3.5 EUT exercise details

---

EUT was connected to UART interface board and was controlled via test computer using Teraterm session.

### 3.6 EUT setup diagram

---

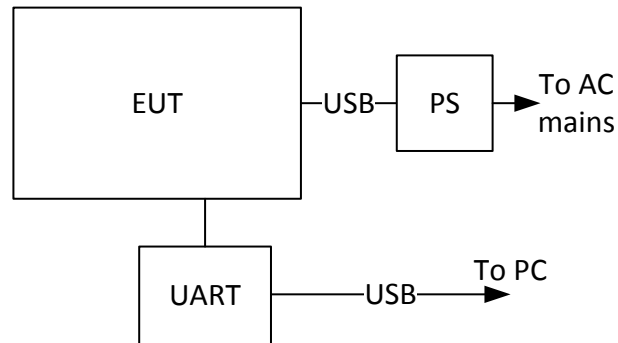

*Figure 3.6-1: Setup diagram*

### 3.7 EUT sub assemblies

---

*Table 3.7-1: EUT sub assemblies*

Description	Brand name	Model/Part number	Serial number
UART interface board	–	–	–
Power supply	Asian Power Devices Inc.	WA-10L05RC	399008425
PC / Laptop	Dell Latitude	D630C	FA002359



## Section 4. Engineering considerations

---

### 4.1 Modifications incorporated in the EUT

---

There were no modifications performed to the EUT during this assessment.

### 4.2 Technical judgment

---

None

### 4.3 Deviations from laboratory tests procedures

---

No deviations were made from laboratory procedures.

## Section 5. Test conditions

---

### 5.1 Atmospheric conditions

---

Temperature	15–30 °C
Relative humidity	20–75 %
Air pressure	860–1060 mbar

When it is impracticable to carry out tests under these conditions, a note to this effect stating the ambient temperature and relative humidity during the tests shall be recorded and stated.

### 5.2 Power supply range

---

The normal test voltage for equipment to be connected to the mains shall be the nominal mains voltage. For the purpose of the present document, the nominal voltage shall be the declared voltage, or any of the declared voltages  $\pm 5\%$ , for which the equipment was designed.

## Section 6. Measurement uncertainty

---

### 6.1 Uncertainty of measurement

---

Nemko Canada Inc. has calculated measurement uncertainty and is documented in EMC/MUC/001 "Uncertainty in EMC measurements." Measurement uncertainty was calculated using the methods described in CISPR 16-4 Specification for radio disturbance and immunity measuring apparatus and methods – Part 4: Uncertainty in EMC measurements; as well as described in UKAS LAB34: The expression of Uncertainty in EMC Testing. Measurement uncertainty calculations assume a coverage factor of  $k=2$  with 95% certainty.

## Section 7. Test equipment

---

### 7.1 Test equipment list

---

*Table 7.1-1: Equipment list*

Equipment	Manufacturer	Model no.	Asset no.	Cal cycle	Next cal.
3 m EMI test chamber	TDK	SAC-3	FA002047	1 year	Mar. 09/14
Flush mount turntable	Sunol	FM2022	FA002082	—	NCR
Controller	Sunol	SC104V	FA002060	—	NCR
Antenna mast	Sunol	TLT2	FA002061	—	NCR
Power source	California Instruments	3001i	FA001021	1 year	June 04/14
Receiver/spectrum analyzer	Rohde & Schwarz	ESU 26	FA002043	1 year	Oct. 24/14
Receiver/spectrum analyzer	Rohde & Schwarz	ESU 40	FA002071	1 year	Feb. 28/14
Horn antenna (1–18 GHz)	EMCO	3115	FA000825	1 year	Feb. 21/14
Horn antenna (18–40 GHz)	EMCO	3116	FA001847	2 year	Sept. 06/14
Pre-amplifier (1–18 GHz)	JCA	JCA118-503	FA002091	1 year	June 21/14
Pre-amplifier (18–26 GHz)	Narda	BBS-1826N612	FA001550	—	VOU
LISN	Rohde & Schwarz	ENV216	FA002023	1 year	Oct. 28/14
50 Ω coax cable	Huber + Suhner	None	FA002394	1 year	June 27/14
50 Ω coax cable	C.C.A.	None	FA002556	1 year	Oct. 07/14

Note: NCR - no calibration required, VOU - verify on use

## Section 8. Testing data

### 8.1 FCC 15.207(a) and RSS-Gen 7.2.4 AC power line conducted emissions limits

#### 8.1.1 Definitions and limits

**FCC:**  
 Except as shown in paragraphs (b) and (c) of this section, for an intentional radiator that is designed to be connected to the public utility (AC) power line, the radio frequency voltage that is conducted back onto the AC power line on any frequency or frequencies, within the band 150 kHz to 30 MHz, shall not exceed the limits in the following table, as measured using a 50  $\mu$ H/50  $\Omega$  line impedance stabilization network (LISN). Compliance with the provisions of this paragraph shall be based on the measurement of the radio frequency voltage between each power line and ground at the power terminal. The lower limit applies at the boundary between the frequency ranges.

**IC:**  
 The purpose of this test is to measure unwanted radio frequency currents induced in any AC conductor external to the equipment which could conduct interference to other equipment via the AC electrical network.

Except when the requirements applicable to a given device state otherwise, for any licence-exempt radiocommunication device equipped to operate from the public utility AC power supply, either directly or indirectly, the radio frequency voltage that is conducted back onto the AC power lines in the frequency range of 0.15 MHz to 30 MHz shall not exceed the limits shown in Table 2. The tighter limit applies at the frequency range boundaries.

The conducted emissions shall be measured with a 50  $\Omega$ /50  $\mu$ H line impedance stabilization network (LISN).

*Table 8.1-1: Conducted emissions limit*

Frequency of emission, MHz	Conducted limit, dB $\mu$ V	
	Quasi-peak	Average
0.15–0.5	66 to 56*	56 to 46*
0.5–5	56	46
5–30	60	50

Note: \* - Decreases with the logarithm of the frequency.

#### 8.1.2 Test summary

Test date:	February 7, 2014	Temperature:	23 °C
Test engineer:	Andrey Adelberg	Air pressure:	1007 mbar
Verdict:	Pass	Relative humidity:	33 %

### 8.1.3 Observations, settings and special notes

---

The EUT was set up as tabletop configuration.

The spectral scan has been corrected with transducer factors (i.e. cable loss, LISN factors, and attenuators) for determination of compliance.

A preview measurement was generated with the receiver in continuous scan mode. Emissions detected within 6 dB or above limit were re-measured with the appropriate detector against the correlating limit and recorded as the final measurement.

Receiver settings for preview measurements:

Resolution bandwidth:	9 kHz
Video bandwidth:	30 kHz
Detector mode:	Peak and Average
Trace mode:	Max Hold
Measurement time:	1000 ms

Receiver settings for final measurements:

Resolution bandwidth:	9 kHz
Video bandwidth:	30 kHz
Detector mode:	Quasi-Peak and Average
Trace mode:	Max Hold
Measurement time:	1000 ms

8.1.4 Test data

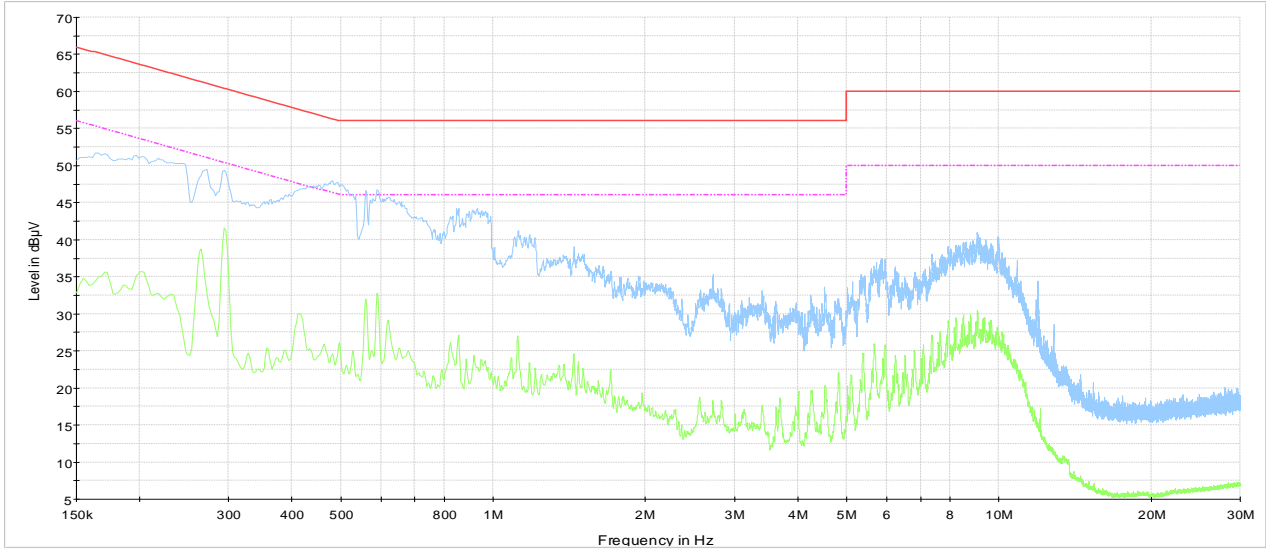

Conducted emissions on phase line  
 — CISPR 22 Mains QP Class B  
 - - - CISPR 22 Mains AV Class B  
 — Preview Result 1-PK+  
 — Preview Result 2-AVG

**Plot 8.1-1: Conducted emissions on phase line**

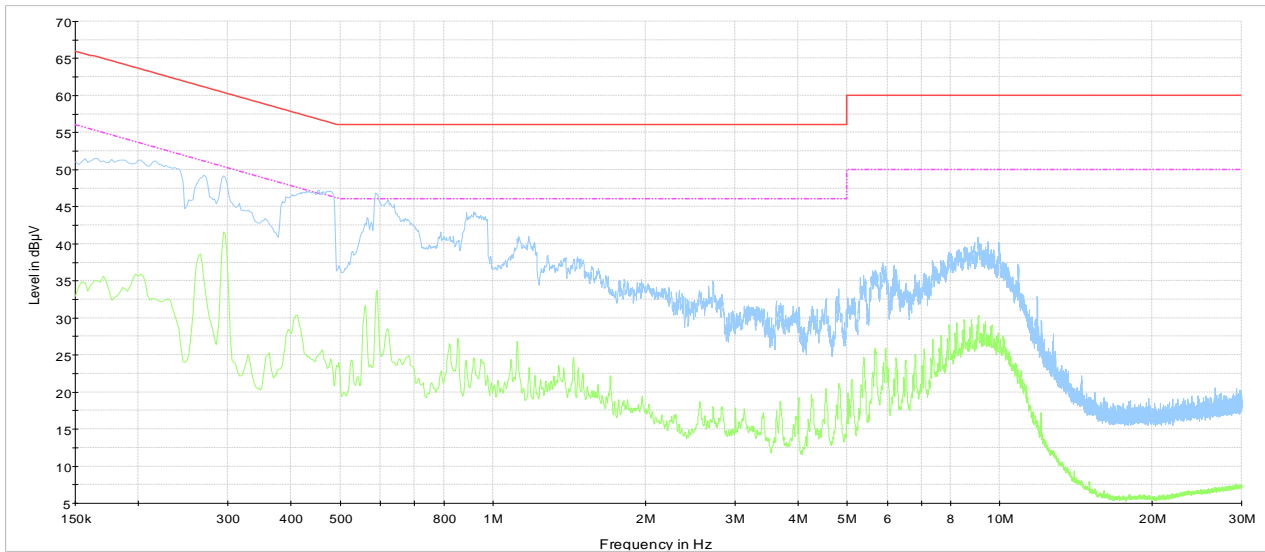

Conducted emissions on neutral line  
 — CISPR 22 Mains QP Class B  
 - - - CISPR 22 Mains AV Class B  
 — Preview Result 1-PK+  
 — Preview Result 2-AVG

**Plot 8.1-2: Conducted emissions on neutral line**

## 8.2 FCC 15.247(a)(2) and RSS-210 A8.2(a) Minimum 6 dB bandwidth for systems using digital modulation techniques

### 8.2.1 Definitions and limits

#### FCC and IC:

- (a) Operation under the provisions of this Section is limited to frequency hopping and digitally modulated intentional radiators that comply with the following provisions:
- (2) Systems using digital modulation techniques may operate in the 902–928 MHz, 2400–2483.5 MHz and 5725–5850 MHz bands. The minimum 6 dB bandwidth shall be at least 500 kHz.

### 8.2.2 Test summary

Test date:	February 4, 2014	Temperature:	23 °C
Test engineer:	Andrey Adelberg	Air pressure:	1008 mbar
Verdict:	Pass	Relative humidity:	31 %

### 8.2.3 Observations, settings and special notes

Spectrum analyser settings:

Resolution bandwidth:	1–5 % of DTS BW (no wider than 100 kHz)
Video bandwidth:	≥3 × RBW
Frequency span:	30 MHz
Detector mode:	Peak
Trace mode:	Max Hold

### 8.2.4 Test data

**Table 8.2-1: 6 dB bandwidth results for FCC/IC**

Modulation	Frequency, MHz	6 dB bandwidth (max rate), MHz	6 dB bandwidth (min rate), MHz	Limit, MHz	Margin, MHz
802.11b	2412	8.76	10.20	0.50	8.26
	2437	8.76	10.20	0.50	8.26
	2462	8.76	10.20	0.50	8.26
802.11g	2412	16.56	16.20	0.50	15.70
	2437	16.56	16.44	0.50	15.94
	2462	16.56	16.44	0.50	15.94
802.11n	2412	17.70	17.52	0.50	17.02
	2437	17.58	17.64	0.50	17.08
	2462	17.76	17.52	0.50	17.02

Note: The margin was calculated as follows: minimum [6 dB BW (max rate), 6 dB BW (max rate)] – Limit



8.2.4 Test data, continued

Table 8.2-2: 6 dB bandwidth results for Israel

Modulation	Frequency, MHz	6 dB bandwidth (max rate), MHz	6 dB bandwidth (min rate), MHz	Limit, MHz	Margin, MHz
802.11b	2422	8.70	10.22	0.50	8.20
	2452	8.70	10.20	0.50	8.20
802.11g	2422	16.56	16.44	0.50	15.94
	2452	16.56	16.44	0.50	15.94
802.11n	2422	17.70	17.64	0.50	17.14
	2452	17.70	17.64	0.50	17.14

Note: The margin was calculated as follows: minimum [6 dB BW (max rate) , 6 dB BW (max rate)] – Limit

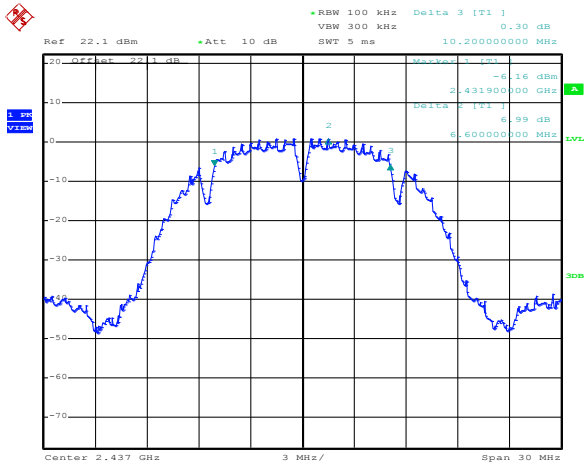

Date: 4.FEB.2014 11:25:01

Figure 8.2-1: 6 dB bandwidth on 802.11b, min rate, sample plot

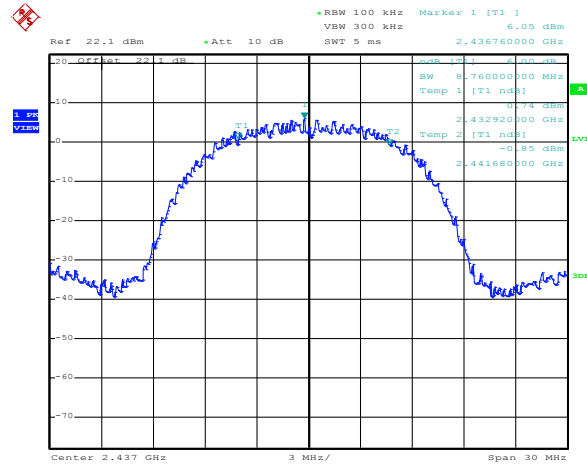

Date: 4.FEB.2014 11:11:32

Figure 8.2-2: 6 dB bandwidth on 802.11b, max rate, sample plot

8.2.4 Test data, continued

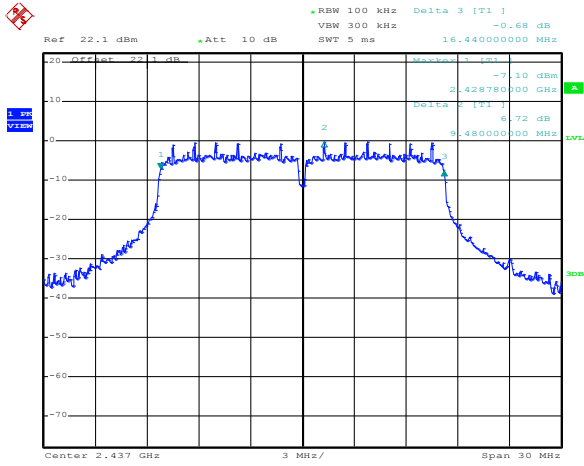

Date: 4.FEB.2014 11:31:16

Figure 8.2-3: 6 dB bandwidth on 802.11g, min rate, sample plot

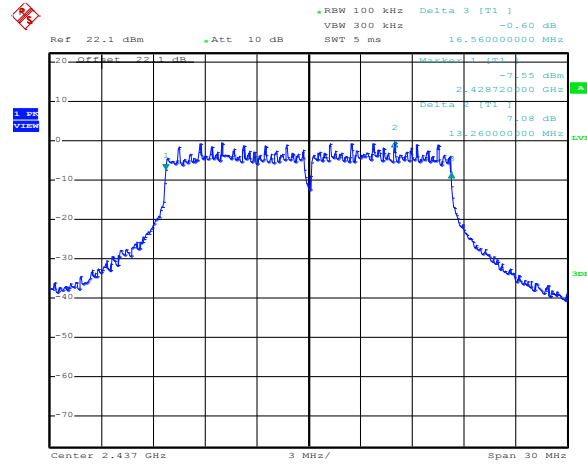

Date: 4.FEB.2014 11:30:19

Figure 8.2-4: 6 dB bandwidth on 802.11g, max rate, sample plot

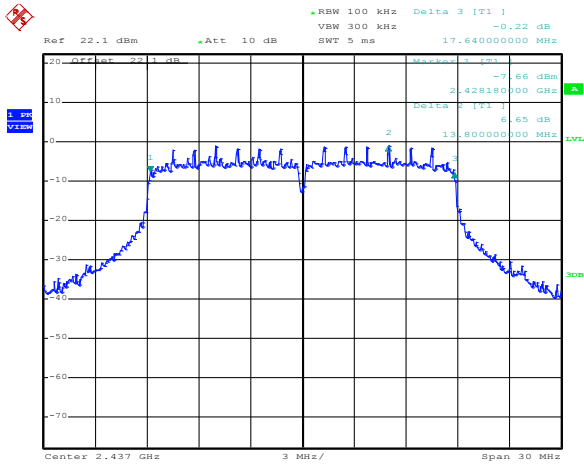

Date: 4.FEB.2014 11:50:52

Figure 8.2-5: 6 dB bandwidth on 802.11n, min rate, sample plot

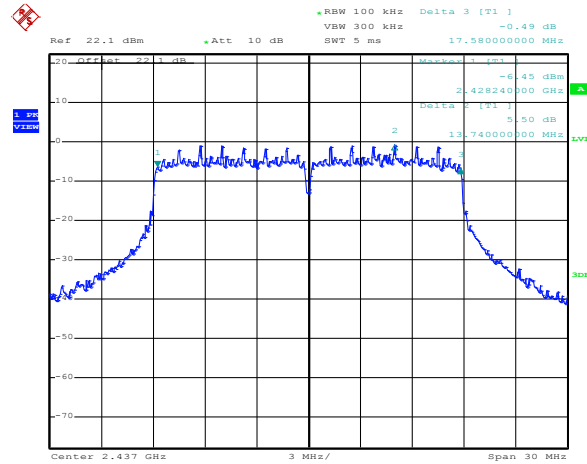

Date: 4.FEB.2014 11:49:13

Figure 8.2-6: 6 dB bandwidth on 802.11n, max rate, sample plot

## 8.3 RSS-Gen 4.6.1 Occupied bandwidth

### 8.3.1 Definitions and limits

When an occupied bandwidth value is not specified in the applicable RSS, the transmitted signal bandwidth to be reported is to be its 99 percent emission bandwidth, as calculated or measured.

The transmitter shall be operated at its maximum carrier power measured under normal test conditions.

The span of the analyzer shall be set to capture all products of the modulation process, including the emission skirts. The resolution bandwidth shall be set to as close to 1 percent of the selected span as is possible without being below 1 percent. The video bandwidth shall be set to 3 times the resolution bandwidth. Video averaging is not permitted. Where practical, a sampling detector shall be used since a peak or, peak hold, may produce a wider bandwidth than actual.

The trace data points are recovered and are directly summed in linear terms. The recovered amplitude data points, beginning at the lowest frequency, are placed in a running sum until 0.5 percent of the total is reached and that frequency recorded. The process is repeated for the highest frequency data points. This frequency is recorded.

The span between the two recorded frequencies is the occupied bandwidth.

### 8.3.2 Test summary

Test date:	February 4, 2014	Temperature:	22 °C
Test engineer:	Andrey Adelberg	Air pressure:	1004 mbar
Verdict:	Pass	Relative humidity:	31 %

### 8.3.3 Observations, settings and special notes

Spectrum analyser settings:

Resolution bandwidth:	≥1 % of span
Video bandwidth:	≥3 × RBW
Detector mode:	Peak
Trace mode:	Max Hold

### 8.3.4 Test data

**Table 8.3-1: 99 % bandwidth results for IC**

Modulation	Frequency, MHz	99 % bandwidth (max rate), MHz	99 % bandwidth (min rate), MHz
802.11b	2412	13.68	13.98
	2437	13.68	13.98
	2462	13.68	13.98
802.11g	2412	16.86	16.98
	2437	16.80	16.98
	2462	16.86	16.98
802.11n	2412	17.88	18.00
	2437	17.88	18.00
	2462	17.88	18.00

8.3.4 Test data, continued

Table 8.3-2: 99 % bandwidth results for Israel

Modulation	Frequency, MHz	99 % bandwidth (max rate), MHz	99 % bandwidth (min rate), MHz
802.11b	2422	13.74	13.98
	2452	13.68	13.98
802.11g	2422	16.86	16.98
	2452	16.80	16.98
802.11n	2422	17.88	18.00
	2452	17.88	18.00

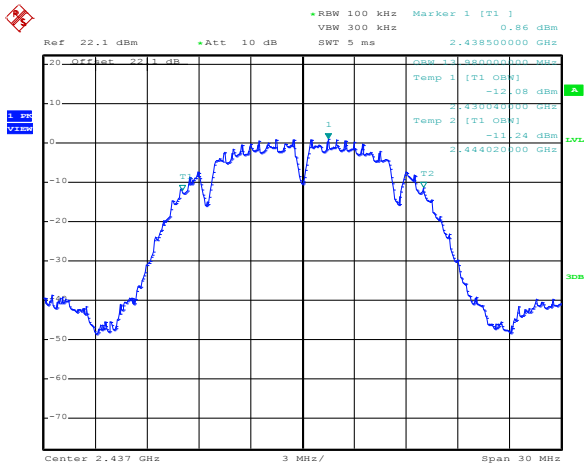

Date: 4.FEB.2014 11:17:25

Figure 8.3-1: 99 % bandwidth on 802.11b, min rate, sample plot

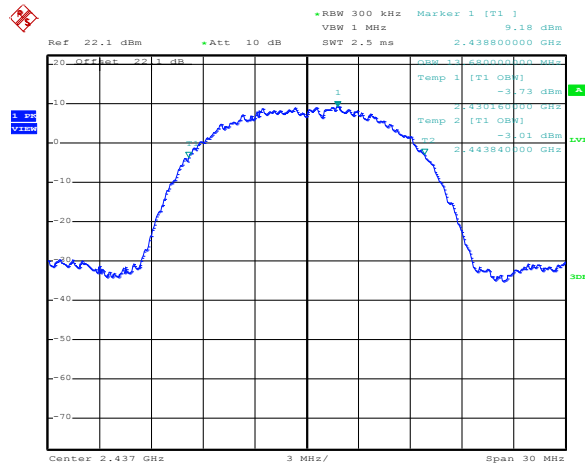

Date: 4.FEB.2014 11:10:42

Figure 8.3-2: 99 % bandwidth on 802.11b, max rate, sample plot

8.3.4 Test data, continued

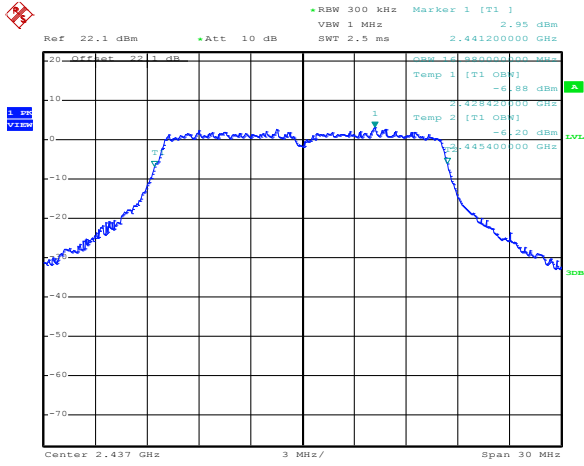

Date: 4.FEB.2014 11:38:11

Figure 8.3-3: 99 % bandwidth on 802.11g, min rate, sample plot

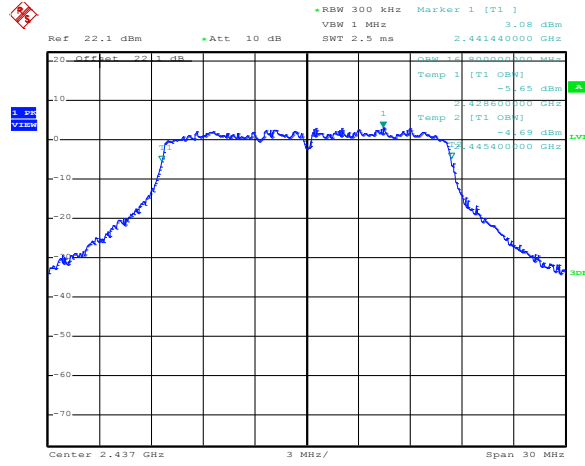

Date: 4.FEB.2014 11:38:57

Figure 8.3-4: 99 % bandwidth on 802.11g, max rate, sample plot

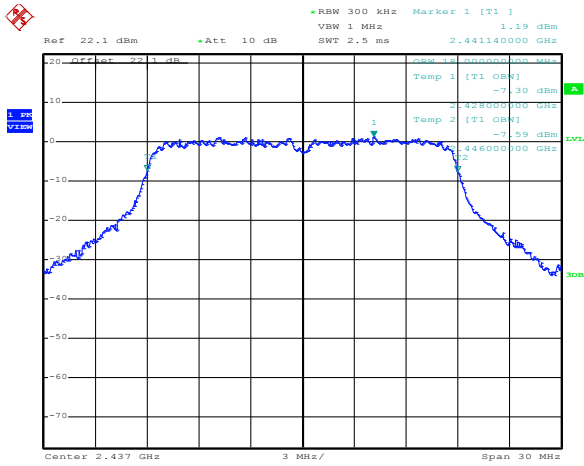

Date: 4.FEB.2014 11:43:10

Figure 8.3-5: 99 % bandwidth on 802.11n, min rate, sample plot

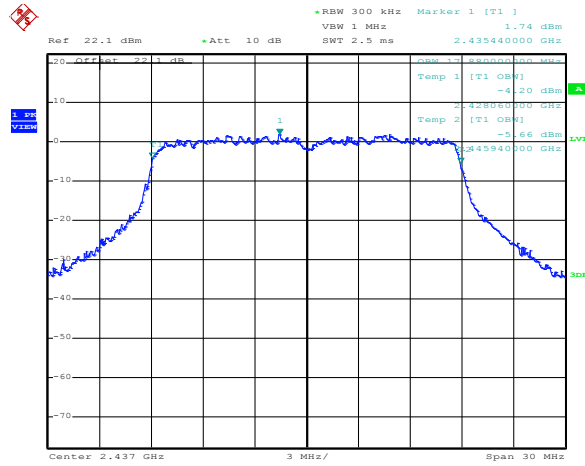

Date: 4.FEB.2014 11:43:51

Figure 8.3-6: 99 % bandwidth on 802.11n, max rate, sample plot

## 8.4 FCC 15.247(b) and RSS-210 A8.4 (4) Transmitter output power and e.i.r.p. requirements

### 8.4.1 Definitions and limits

**FCC:**

- (b) The maximum peak conducted output power of the intentional radiator shall not exceed the following:
- (3) For systems using digital modulation in the 902–928 MHz, 2400–2483.5 MHz, and 5725–5850 MHz bands: 1 W (30 dBm). As an alternative to a peak power measurement, compliance with the one Watt limit can be based on a measurement of the maximum conducted output power. Maximum Conducted Output Power is defined as the total transmit power delivered to all antennas and antenna elements averaged across all symbols in the signaling alphabet when the transmitter is operating at its maximum power control level. Power must be summed across all antennas and antenna elements. The average must not include any time intervals during which the transmitter is off or is transmitting at a reduced power level. If multiple modes of operation are possible (e.g., alternative modulation methods), the maximum conducted output power is the highest total transmit power occurring in any mode.
  - (4) The conducted output power limit specified in paragraph (b) of this section is based on the use of antennas with directional gains that do not exceed 6 dBi. Except as shown in paragraph (c) of this section, if transmitting antennas of directional gain greater than 6 dBi are used, the conducted output power from the intentional radiator shall be reduced below the stated values in paragraphs (b)(1), (b)(2), and (b)(3) of this section, as appropriate, by the amount in dB that the directional gain of the antenna exceeds 6 dBi.
    - (i) Systems operating in the 2400–2483.5 MHz band that are used exclusively for fixed, point-to-point operations may employ transmitting antennas with directional gain greater than 6 dBi provided the maximum peak output power of the intentional radiator is reduced by 1 dB for every 3 dB that the directional gain of the antenna exceeds 6 dBi.

Fixed, point-to-point operation, as used in paragraphs (b)(3)(i) and (b)(3)(ii) of this section, excludes the use of point-to-multipoint systems, omnidirectional applications, and multiple co-located intentional radiators transmitting the same information. The operator of the spread spectrum intentional radiator or, if the equipment is professionally installed, the installer is responsible for ensuring that the system is used exclusively for fixed, point-to-point operations. The instruction manual furnished with the intentional radiator shall contain language in the installation instructions informing the operator and the installer of this responsibility.

- (c) Operation with directional antenna gains greater than 6 dBi.
- (2) In addition to the provisions in paragraphs (b)(1), (b)(3), (b)(4) and (c)(1)(i) of this section, transmitters operating in the 2400–2483.5 MHz band that emit multiple directional beams, simultaneously or sequentially, for the purpose of directing signals to individual receivers or to groups of receivers provided the emissions comply with the following:
    - (i) Different information must be transmitted to each receiver.
    - (ii) If the transmitter employs an antenna system that emits multiple directional beams but does not do emit multiple directional beams simultaneously, the total output power conducted to the array or arrays that comprise the device, i.e., the sum of the power supplied to all antennas, antenna elements, staves, etc. and summed across all carriers or frequency channels, shall not exceed the limit specified in paragraph (b)(1) or (b)(3) of this section, as applicable. However, the total conducted output power shall be reduced by 1 dB below the specified limits for each 3 dB that the directional gain of the antenna/antenna array exceeds 6 dBi. The directional antenna gain shall be computed as follows:
      - (A) The directional gain shall be calculated as the sum of 10 log (number of array elements or staves) plus the directional gain of the element or staff having the highest gain.

**IC:**  
A8.4 (4) Transmitter Output Power and e.i.r.p. Requirements for systems employing digital modulation techniques operating in the bands 902–928 MHz, 2400–2483.5 MHz and 5725–5850 MHz bands

For systems employing digital modulation techniques operating in the bands 902–928 MHz, 2400–2483.5 MHz and 5725–5850 MHz, the maximum peak conducted output power shall not exceed 1 W. Except as provided in Section A8.4(5), the e.i.r.p. shall not exceed 4 W. As an alternative to a peak power measurement, compliance can be based on a measurement of the maximum conducted output power (see RSS-Gen).

### 8.4.2 Test summary

Test date:	February 4, 2014	Temperature:	23 °C
Test engineer:	Andrey Adelberg	Air pressure:	1005 mbar
Verdict:	Pass	Relative humidity:	31 %

### 8.4.3 Observations, settings and special notes

The test was performed according to DTS guidelines section 9.1.2: Integrated band power method. Spectrum analyzer settings were:

Resolution bandwidth:	1 MHz
Video bandwidth:	3 MHz
Detector mode:	Peak
Trace mode:	Max hold over 100 sweeps
Power integration BW:	20 MHz

### 8.4.4 Test data

**Table 8.4-1:** Output power measurements results at minimum data rate for FCC/IC

Modulation	Frequency, MHz	Conducted output power, dBm		Margin, dB	Antenna gain, dBi	EIRP, dBm	EIRP limit, dBm	EIRP margin, dB
		Measured	Limit					
802.11b	2412	16.67	30.00	13.33	3.71	20.38	36.00	15.62
	2437	16.13	30.00	13.87	3.71	19.84	36.00	16.16
	2462	15.99	30.00	14.01	3.71	19.70	36.00	16.30
802.11g	2412	19.80	30.00	10.20	3.71	23.51	36.00	12.49
	2437	20.24	30.00	9.76	3.71	23.95	36.00	12.05
	2462	20.20	30.00	9.80	3.71	23.91	36.00	12.09
802.11n	2412	19.53	30.00	10.47	3.71	23.24	36.00	12.76
	2437	19.54	30.00	10.46	3.71	23.25	36.00	12.75
	2462	19.40	30.00	10.60	3.71	23.11	36.00	12.89

**Table 8.4-2:** Output power measurements results at maximum data rate for FCC/IC

Modulation	Frequency, MHz	Conducted output power, dBm		Margin, dB	Antenna gain, dBi	EIRP, dBm	EIRP limit, dBm	EIRP margin, dB
		Measured	Limit					
802.11b	2412	22.95	30.00	7.05	3.71	26.66	36.00	9.34
	2437	22.55	30.00	7.45	3.71	26.26	36.00	9.74
	2462	22.55	30.00	7.45	3.71	26.26	36.00	9.74
802.11g	2412	20.50	30.00	9.50	3.71	24.21	36.00	11.79
	2437	20.17	30.00	9.83	3.71	23.88	36.00	12.12
	2462	20.02	30.00	9.98	3.71	23.73	36.00	12.27
802.11n	2412	19.29	30.00	10.71	3.71	23.00	36.00	13.00
	2437	19.29	30.00	10.71	3.71	23.00	36.00	13.00
	2462	18.67	30.00	11.33	3.71	22.38	36.00	13.62

**Table 8.4-3:** Output power measurements results at minimum data rate for Israel

Modulation	Frequency, MHz	Conducted output power, dBm		Margin, dB	Antenna gain, dBi	EIRP, dBm	EIRP limit, dBm	EIRP margin, dB
		Measured	Limit					
802.11b	2422	17.13	30.00	12.87	3.71	20.84	36.00	15.16
	2452	16.83	30.00	13.17	3.71	20.54	36.00	15.46
802.11g	2422	20.86	30.00	9.14	3.71	24.57	36.00	11.43
	2452	20.33	30.00	9.67	3.71	24.04	36.00	11.96
802.11n	2422	19.90	30.00	10.10	3.71	23.61	36.00	12.39
	2452	20.07	30.00	9.93	3.71	23.78	36.00	12.22

8.4.4 Test data, continued

**Table 8.4-4: Output power measurements results at maximum data rate for Israel**

Modulation	Frequency, MHz	Conducted output power, dBm		Margin, dB	Antenna gain, dBi	EIRP, dBm	EIRP limit, dBm	EIRP margin, dB
		Measured	Limit					
802.11b	2422	22.96	30.00	7.04	3.71	26.67	36.00	9.33
	2452	23.22	30.00	6.78	3.71	26.93	36.00	9.07
802.11g	2422	20.89	30.00	9.11	3.71	24.60	36.00	11.40
	2452	21.04	30.00	8.96	3.71	24.75	36.00	11.25
802.11n	2422	20.13	30.00	9.87	3.71	23.84	36.00	12.16
	2452	19.63	30.00	10.37	3.71	23.34	36.00	12.66

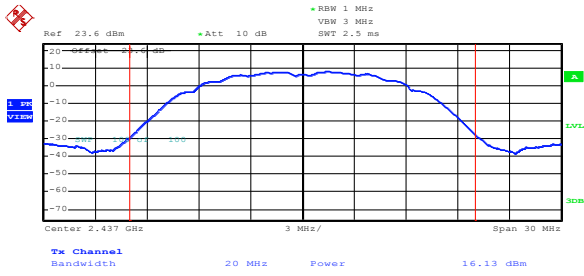

Figure 8.4-1: Output power on 802.11b, min rate, sample plot

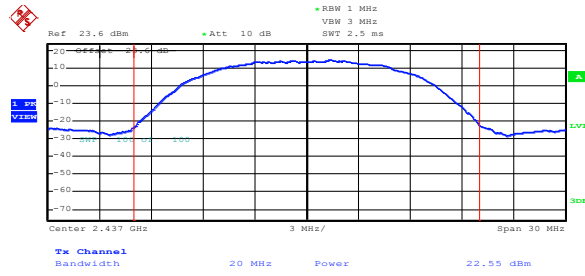

Figure 8.4-2: Output power on 802.11b, max rate, sample plot

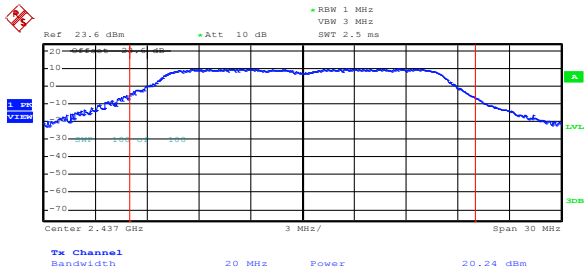

Figure 8.4-3: Output power on 802.11g, min rate, sample plot

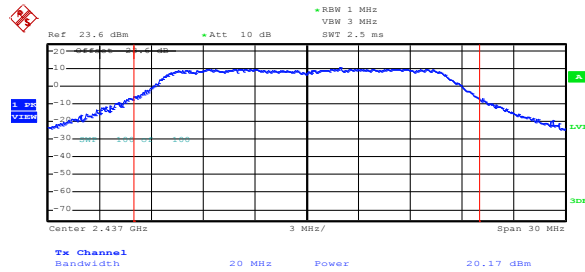

Figure 8.4-4: Output power on 802.11g, max rate, sample plot

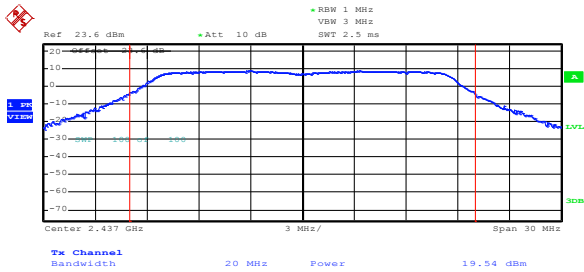

Figure 8.4-5: Output power on 802.11n, min rate, sample plot

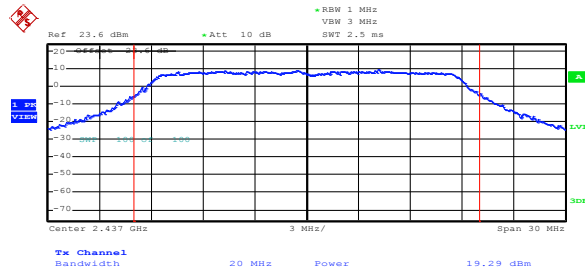

Figure 8.4-6: Output power on 802.11n, max rate, sample plot



## 8.5 FCC 15.247(d) and RSS-210 A8.5 Spurious (out-of-band) emissions

### 8.5.1 Definitions and limits

**FCC:**  
 In any 100 kHz bandwidth outside the frequency band in which the spread spectrum or digitally modulated intentional radiator is operating, the radio frequency power that is produced by the intentional radiator shall be at least 20 dB below that in the 100 kHz bandwidth within the band that contains the highest level of the desired power, based on either an RF conducted or a radiated measurement, provided the transmitter demonstrates compliance with the peak conducted power limits. If the transmitter complies with the conducted power limits based on the use of RMS averaging over a time interval, as permitted under paragraph (b)(3) of this section, the attenuation required under this paragraph shall be 30 dB instead of 20 dB. Attenuation below the general limits specified in §15.209(a) is not required. In addition, radiated emissions which fall in the restricted bands, as defined in §15.205(a), must also comply with the radiated emission limits specified in §15.209(a) (see §15.205(c)).

**IC:**  
 In any 100 kHz bandwidth outside the frequency band in which the spread spectrum or digitally modulated device is operating, the radio frequency power that is produced shall be at least 20 dB below that in the 100 kHz bandwidth within the band that contains the highest level of the desired power, based on either an RF conducted or a radiated measurement, provided the transmitter demonstrates compliance with the peak conducted power limits. If the transmitter complies with the conducted power limits based on the use of RMS averaging over a time interval, as permitted under Section A8.4(4), the attenuation required shall be 30 dB instead of 20 dB. Attenuation below the general limits specified in Tables 2 and 3 is not required.

**Table 8.5-1: FCC §15.209 and RSS-Gen – Radiated emission limits**

Frequency, MHz	Field strength of emissions		Measurement distance, m
	µV/m	dBµV/m	
0.009–0.490	2400/F	$67.6 - 20 \times \log_{10}(F)$	300
0.490–1.705	24000/F	$87.6 - 20 \times \log_{10}(F)$	30
1.705–30.0	30	29.5	30
30–88	100	40.0	3
88–216	150	43.5	3
216–960	200	46.0	3
above 960	500	54.0	3

Notes: In the emission table above, the tighter limit applies at the band edges.

For frequencies above 1 GHz the limit on peak RF emissions is 20 dB above the maximum permitted average emission limit applicable to the equipment under test

**Table 8.5-2: IC restricted frequency bands**

MHz	MHz	MHz	GHz
0.090–0.110	12.51975–12.52025	399.9–410	5.35–5.46
2.1735–2.1905	12.57675–12.57725	608–614	7.25–7.75
3.020–3.026	13.36–13.41	960–1427	8.025–8.5
4.125–4.128	16.42–16.423	1435–1626.5	9.0–9.2
4.17725–4.17775	16.69475–16.69525	1645.5–1646.5	9.3–9.5
4.20725–4.20775	16.80425–16.80475	1660–1710	10.6–12.7
5.677–5.683	25.5–25.67	1718.8–1722.2	13.25–13.4
6.215–6.218	37.5–38.25	2200–2300	14.47–14.5
6.26775–6.26825	73–74.6	2310–2390	15.35–16.2
6.31175–6.31225	74.8–75.2	2655–2900	17.7–21.4
8.291–8.294	108–138	3260–3267	22.01–23.12
8.362–8.366	156.52475–156.52525	3332–3339	23.6–24.0
8.37625–8.38675	156.7–156.9	3345.8–3358	31.2–31.8
8.41425–8.41475	240–285	3500–4400	36.43–36.5
12.29–12.293	322–335.4	4500–5150	Above 38.6

Note: Certain frequency bands listed in Table 8.5-2 and above 38.6 GHz are designated for low-power licence-exempt applications. These frequency bands and the requirements that apply to the devices are set out in this Standard

### 8.5.1 Definitions and limits, continued

**Table 8.5-3: FCC restricted frequency bands**

MHz	MHz	MHz	GHz
0.090–0.110	16.42–16.423	399.9–410	4.5–5.15
0.495–0.505	16.69475–16.69525	608–614	5.35–5.46
2.1735–2.1905	16.80425–16.80475	960–1240	7.25–7.75
4.125–4.128	25.5–25.67	1300–1427	8.025–8.5
4.17725–4.17775	37.5–38.25	1435–1626.5	9.0–9.2
4.20725–4.20775	73–74.6	1645.5–1646.5	9.3–9.5
6.215–6.218	74.8–75.2	1660–1710	10.6–12.7
6.26775–6.26825	108–121.94	1718.8–1722.2	13.25–13.4
6.31175–6.31225	123–138	2200–2300	14.47–14.5
8.291–8.294	149.9–150.05	2310–2390	15.35–16.2
8.362–8.366	156.52475–156.52525	2483.5–2500	17.7–21.4
8.37625–8.38675	156.7–156.9	2690–2900	22.01–23.12
8.41425–8.41475	162.0125–167.17	3260–3267	23.6–24.0
12.29–12.293	167.72–173.2	3332–3339	31.2–31.8
12.51975–12.52025	240–285	3345.8–3358	36.43–36.5
12.57675–12.57725	322–335.4	3600–4400	Above 38.6
13.36–13.41			

### 8.5.2 Test summary

Test date:	February 5, 2014	Temperature:	22 °C
Test engineer:	Andrey Adelberg	Air pressure:	1006 mbar
Verdict:	Pass	Relative humidity:	31 %

### 8.5.3 Observations, settings and special notes

The spectrum was searched from 30 MHz to the 10<sup>th</sup> harmonic. EUT was set to transmit with 99 % duty cycle. Cabinet radiation measurements were performed at a distance of 3 m with terminated antenna connector with 50 Ω load. No emissions emanating from the RF compartment were observed more than 10 dB below the limit. Only worst case emissions were reported. Since fundamental power was tested using peak power method, the spurious emissions outside restricted bands limit is –20 dBc/100 kHz

Spectrum analyser settings for radiated measurements within restricted bands below 1 GHz:

Resolution bandwidth:	100 kHz
Video bandwidth:	300 kHz
Detector mode:	Peak
Trace mode:	Max Hold

Spectrum analyser settings for peak radiated measurements within restricted bands above 1 GHz:

Resolution bandwidth:	1 MHz
Video bandwidth:	3 MHz
Detector mode:	Peak
Trace mode:	Max Hold

Spectrum analyser settings for average radiated measurements within restricted bands above 1 GHz:

Resolution bandwidth:	1 MHz
Video bandwidth:	10 Hz
Detector mode:	Peak
Trace mode:	Max Hold

### 8.5.3 Observations, settings and special notes, continued

Calculation of the conducted spurious emissions limits for emissions within restricted bands.

Average limit:  $54 \text{ dB}\mu\text{V/m} - 95.23 \text{ dB} - 3.71 \text{ dBi} = -44.94 \text{ dBm}$

Peak limit:  $74 \text{ dB}\mu\text{V/m} - 95.23 \text{ dB} - 3.71 \text{ dBi} = -24.94 \text{ dBm}$

Spectrum analyser settings for conducted spurious emissions outside restricted bands measurements:

Resolution bandwidth:	100 kHz
Video bandwidth:	300 kHz
Detector mode:	Peak
Trace mode:	Max Hold

### 8.5.4 Test data

**Table 8.5-4:** Radiated field strength measurement results for 802.11b

Channel	Frequency, MHz	Peak Field strength, dB $\mu$ V/m		Margin, dB	Average Field strength, dB $\mu$ V/m		Margin, dB
		Measured	Limit		Measured	Limit	
Low	2390.0	57.47	74.00	16.53	43.11	54.00	10.89
Low	4824.0	54.32	74.00	19.68	39.55	54.00	14.45
Mid	4874.0	53.10	74.00	20.90	38.99	54.00	15.01
High	2483.5	61.02	74.00	12.98	40.98	54.00	13.02

Notes: Field strength includes correction factor of antenna, cable loss, amplifier, and attenuators where applicable. All other modulations produced even lesser emissions results.

8.5.4 Test data, continued

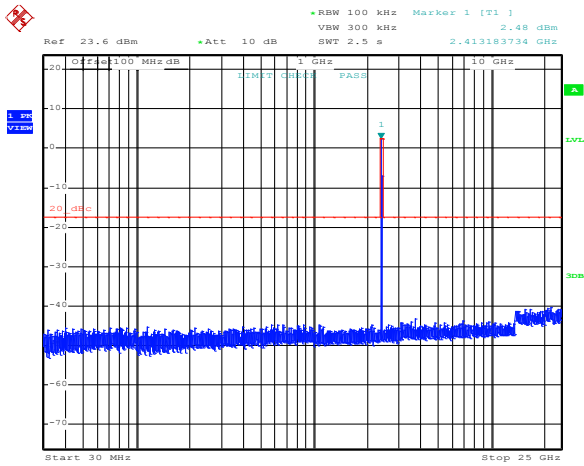

Date: 5.FEB.2014 11:23:08

Figure 8.5-1: Conducted spurious emissions outside restricted bands for 802.11b, low channel at minimum rate

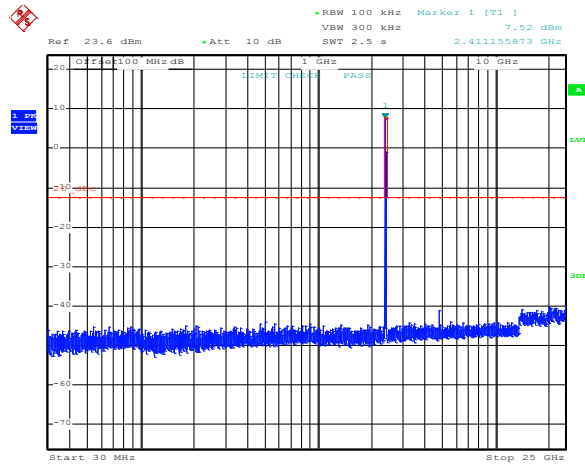

Date: 5.FEB.2014 11:18:43

Figure 8.5-2: Conducted spurious emissions outside restricted bands for 802.11b, low channel at maximum rate

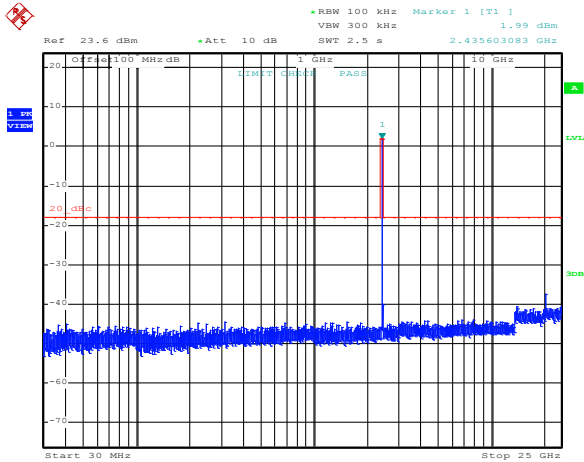

Date: 5.FEB.2014 11:24:03

Figure 8.5-3: Conducted spurious emissions outside restricted bands for 802.11b, mid channel at minimum rate

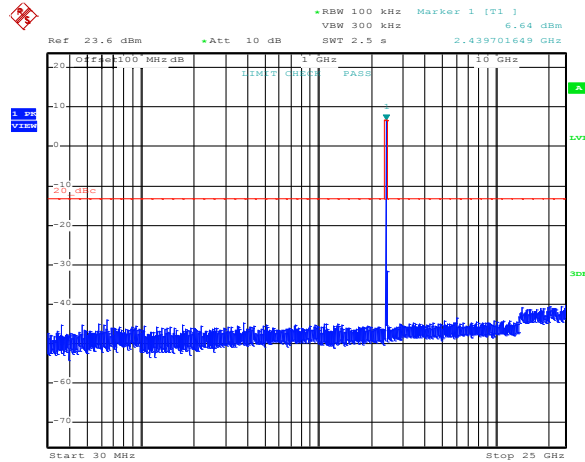

Date: 5.FEB.2014 11:19:43

Figure 8.5-4: Conducted spurious emissions outside restricted bands for 802.11b, mid channel at maximum rate

8.5.4 Test data, continued

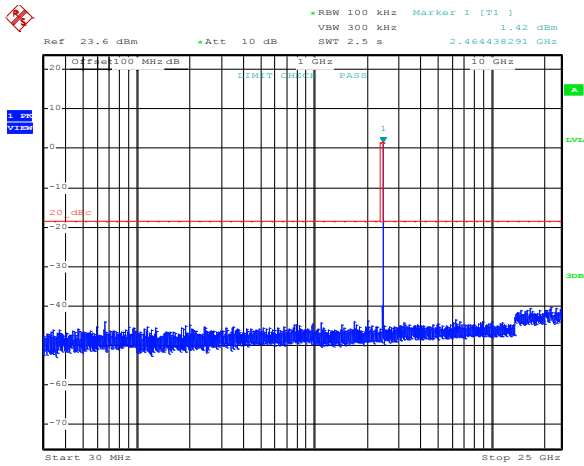

Date: 5.FEB.2014 11:25:13

Figure 8.5-5: Conducted spurious emissions outside restricted bands for 802.11b, high channel at minimum rate

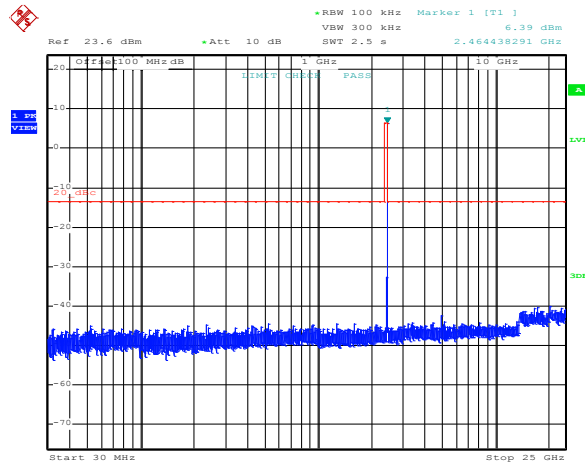

Date: 5.FEB.2014 11:21:44

Figure 8.5-6: Conducted spurious emissions outside restricted bands for 802.11b, high channel at maximum rate

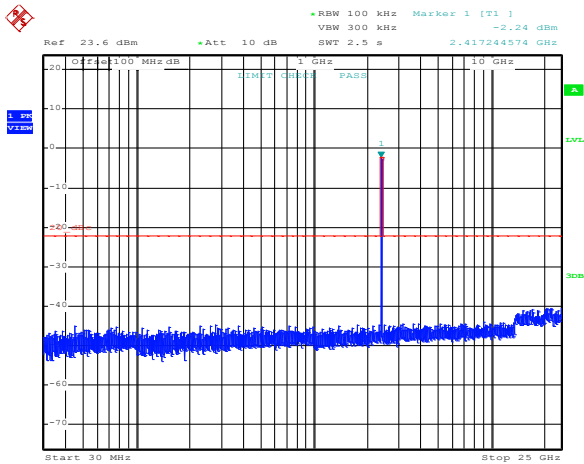

Date: 5.FEB.2014 11:26:31

Figure 8.5-7: Conducted spurious emissions outside restricted bands for 802.11g, low channel at minimum rate

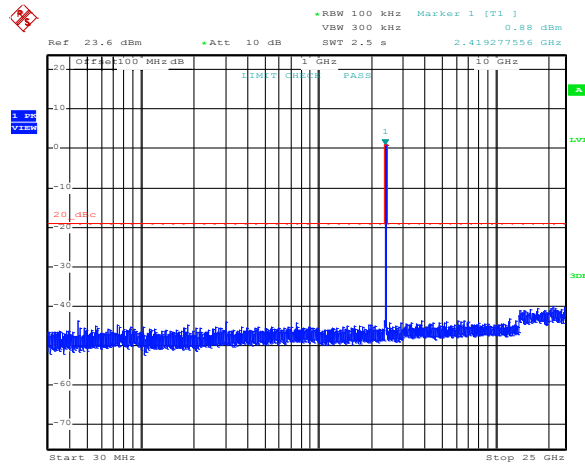

Date: 5.FEB.2014 11:29:42

Figure 8.5-8: Conducted spurious emissions outside restricted bands for 802.11g, low channel at maximum rate

8.5.4 Test data, continued

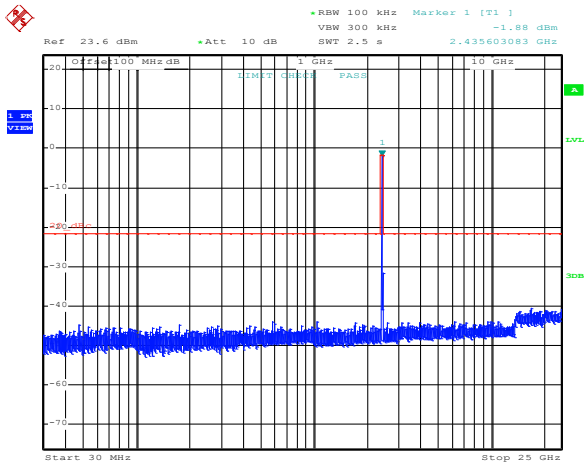

Date: 5.FEB.2014 11:27:27

**Figure 8.5-9:** Conducted spurious emissions outside restricted bands for 802.11g, mid channel at minimum rate

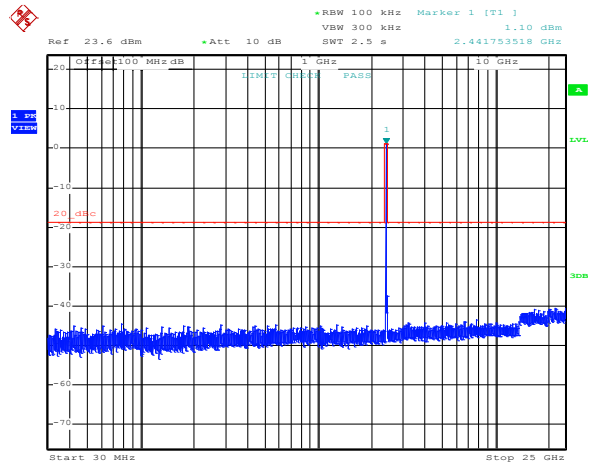

Date: 5.FEB.2014 11:30:40

**Figure 8.5-10:** Conducted spurious emissions outside restricted bands for 802.11g, mid channel at maximum rate

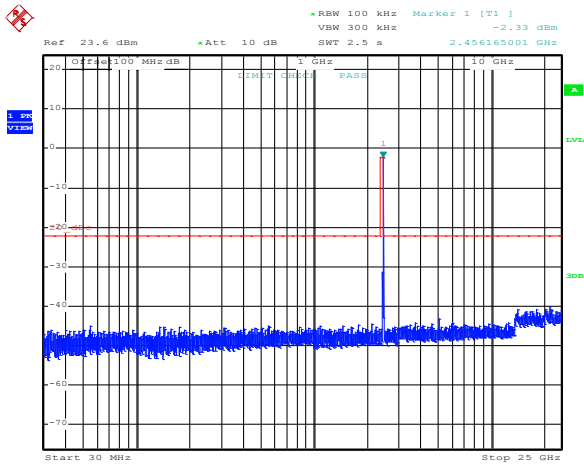

Date: 5.FEB.2014 11:28:17

**Figure 8.5-11:** Conducted spurious emissions outside restricted bands for 802.11g, high channel at minimum rate

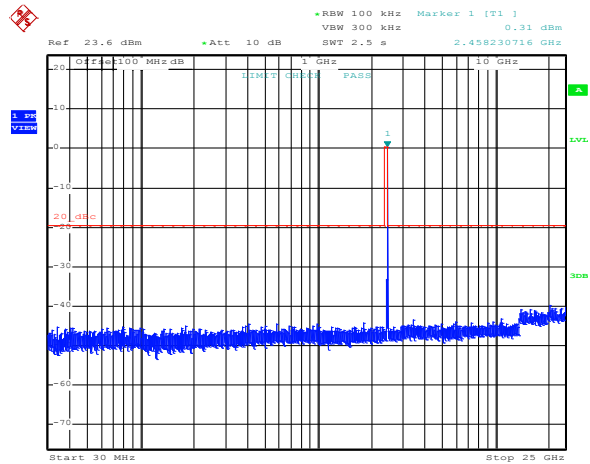

Date: 5.FEB.2014 11:31:49

**Figure 8.5-12:** Conducted spurious emissions outside restricted bands for 802.11g, high channel at maximum rate

8.5.4 Test data, continued

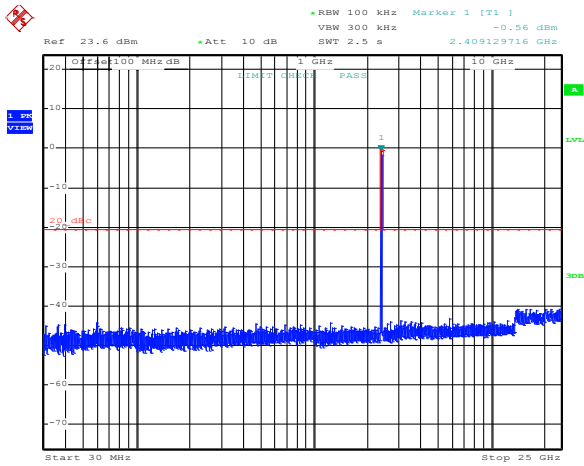

Date: 5.FEB.2014 11:33:07

**Figure 8.5-13:** Conducted spurious emissions outside restricted bands for 802.11n, low channel at minimum rate

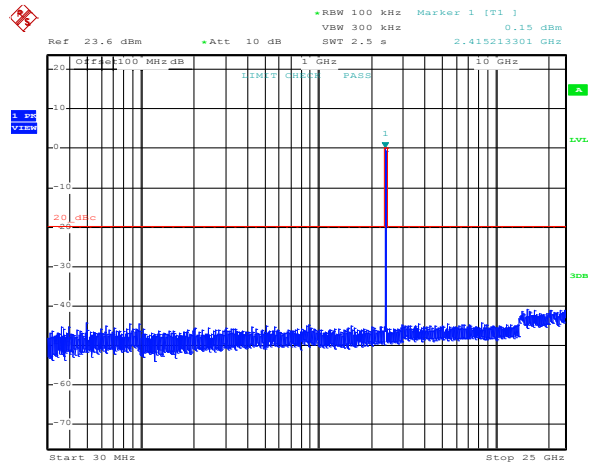

Date: 5.FEB.2014 14:02:02

**Figure 8.5-14:** Conducted spurious emissions outside restricted bands for 802.11n, low channel at maximum rate

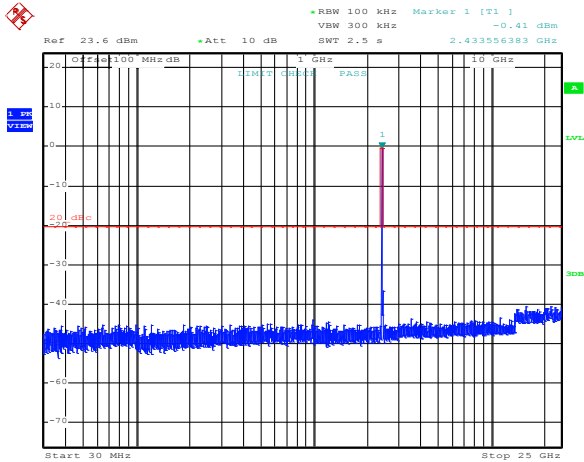

Date: 5.FEB.2014 14:00:16

**Figure 8.5-15:** Conducted spurious emissions outside restricted bands for 802.11n, mid channel at minimum rate

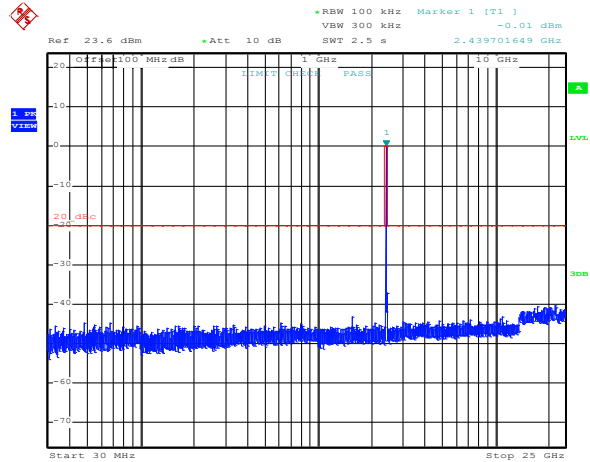

Date: 5.FEB.2014 14:02:53

**Figure 8.5-16:** Conducted spurious emissions outside restricted bands for 802.11n, mid channel at maximum rate

8.5.4 Test data, continued

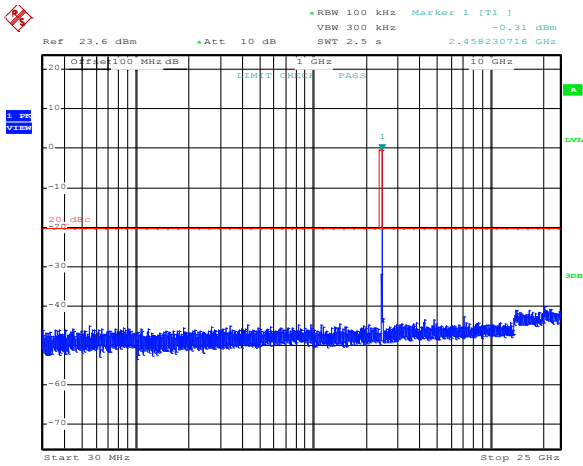

Date: 5.FEB.2014 14:01:10

Figure 8.5-17: Conducted spurious emissions outside restricted bands for 802.11n, high channel at minimum rate

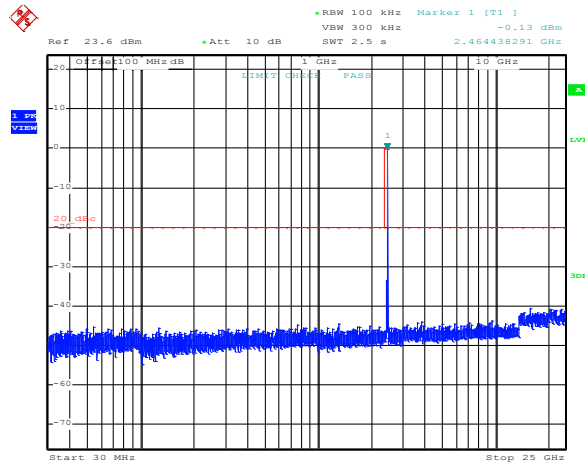

Date: 5.FEB.2014 14:03:36

Figure 8.5-18: Conducted spurious emissions outside restricted bands for 802.11n, high channel at maximum rate

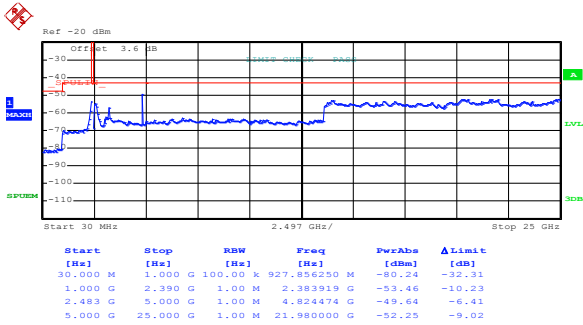

Figure 8.5-19: Conducted peak spurious emissions within restricted bands for 802.11b, low channel at minimum rate

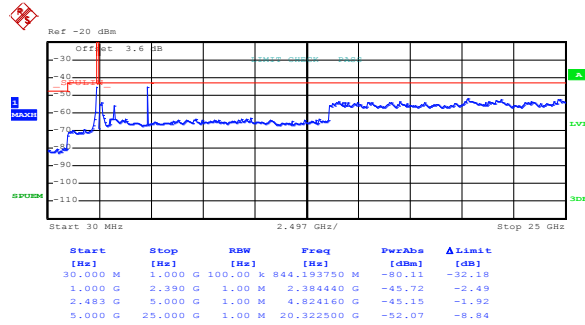

Figure 8.5-20: Conducted peak spurious emissions within restricted bands for 802.11b, low channel at maximum rate



8.5.4 Test data, continued

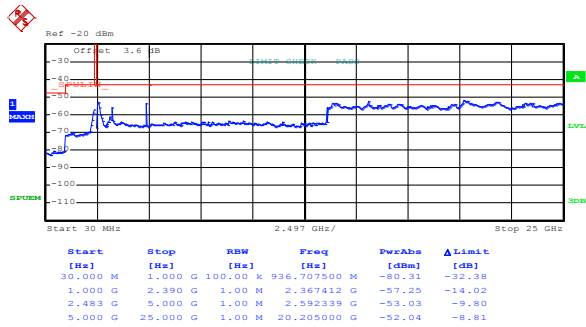

Figure 8.5-21: Conducted peak spurious emissions within restricted bands for 802.11b, mid channel at minimum rate

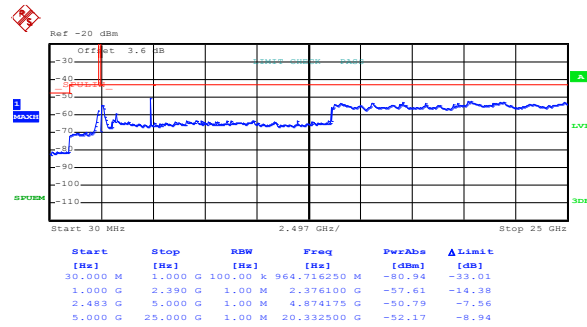

Figure 8.5-22: Conducted peak spurious emissions within restricted bands for 802.11b, mid channel at maximum rate

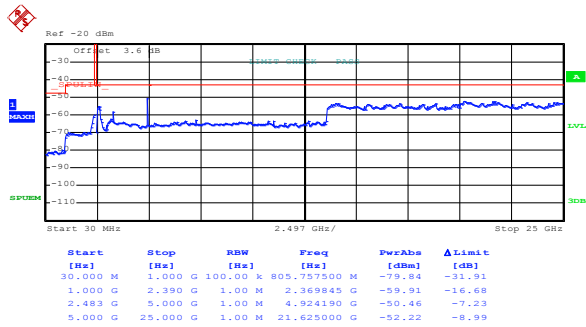

Figure 8.5-23: Conducted peak spurious emissions within restricted bands for 802.11b, high channel at minimum rate

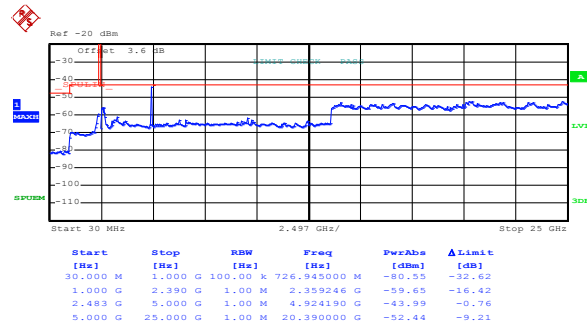

Figure 8.5-24: Conducted peak spurious emissions within restricted bands for 802.11b, high channel at maximum rate

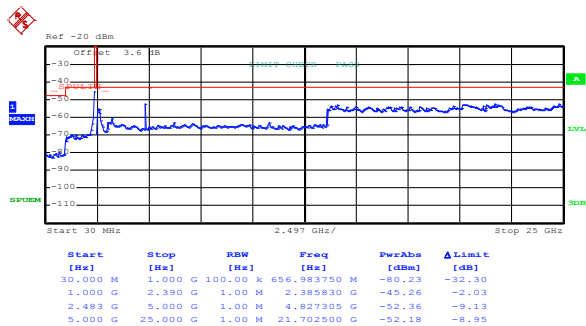

Figure 8.5-25: Conducted peak spurious emissions within restricted bands for 802.11g, low channel at minimum rate

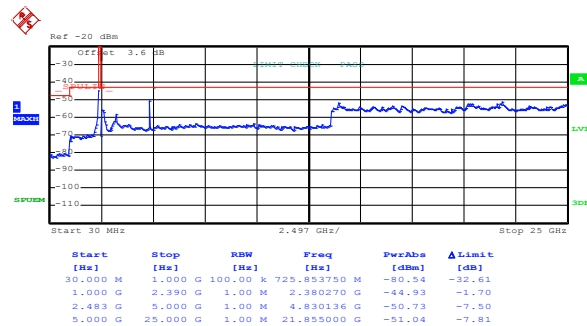

Figure 8.5-26: Conducted peak spurious emissions within restricted bands for 802.11g, low channel at maximum rate

8.5.4 Test data, continued

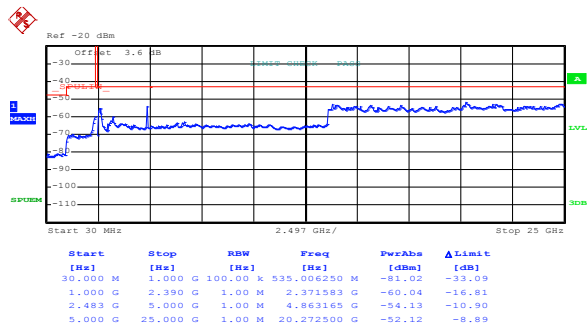

Figure 8.5-27: Conducted peak spurious emissions within restricted bands for 802.11g, mid channel at minimum rate

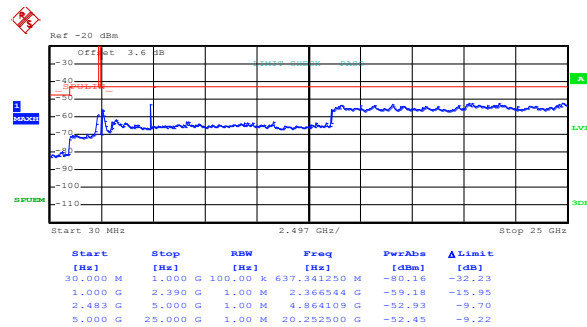

Figure 8.5-28: Conducted peak spurious emissions within restricted bands for 802.11g, mid channel at maximum rate

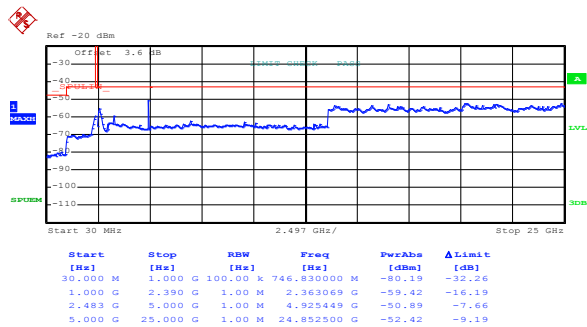

Figure 8.5-29: Conducted peak spurious emissions within restricted bands for 802.11g, high channel at minimum rate

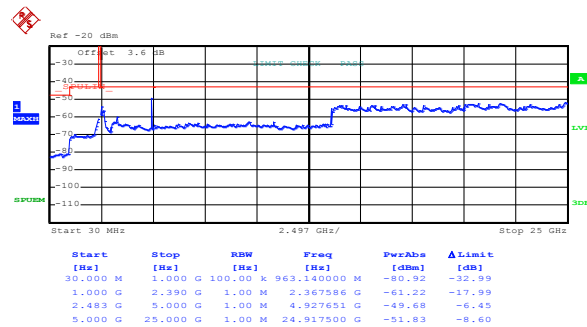

Figure 8.5-30: Conducted peak spurious emissions within restricted bands for 802.11g, high channel at maximum rate

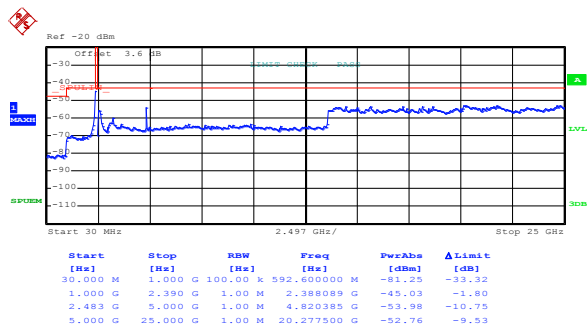

Figure 8.5-31: Conducted peak spurious emissions within restricted bands for 802.11n, low channel at minimum rate

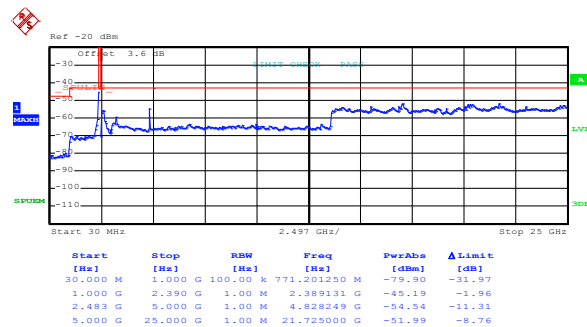

Figure 8.5-32: Conducted peak spurious emissions within restricted bands for 802.11n, low channel at maximum rate

8.5.4 Test data, continued

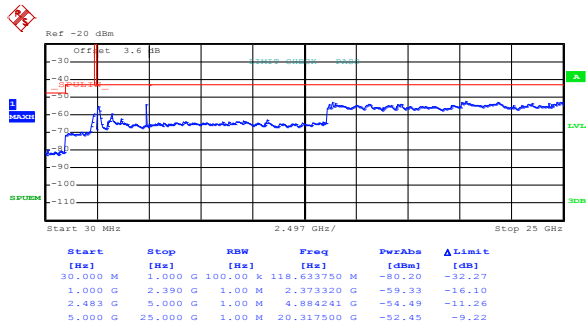

Figure 8.5-33: Conducted peak spurious emissions within restricted bands for 802.11n, mid channel at minimum rate

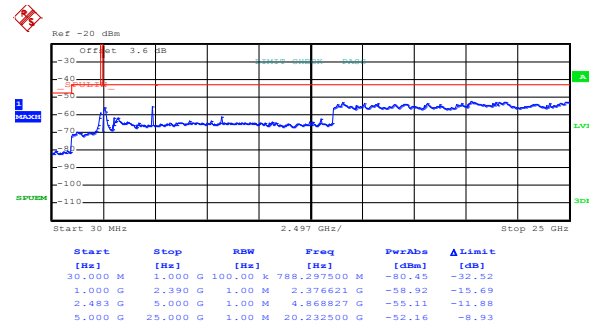

Figure 8.5-34: Conducted peak spurious emissions within restricted bands for 802.11n, mid channel at maximum rate

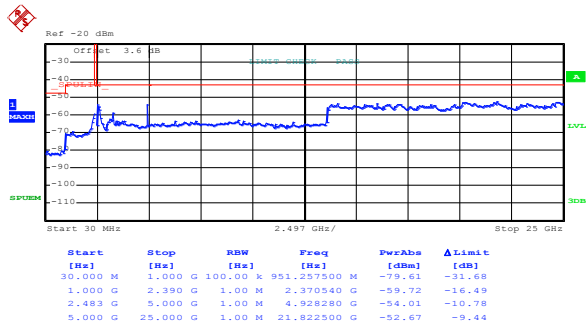

Figure 8.5-35: Conducted peak spurious emissions within restricted bands for 802.11n, high channel at minimum rate

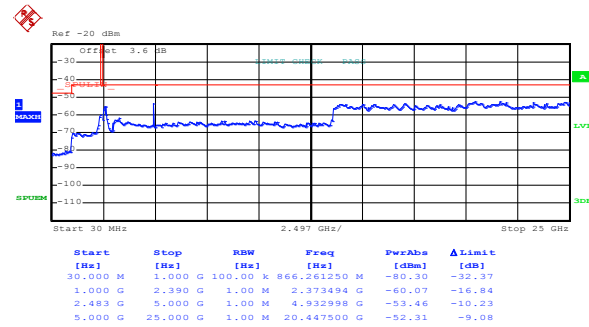

Figure 8.5-36: Conducted peak spurious emissions within restricted bands for 802.11n, high channel at maximum rate

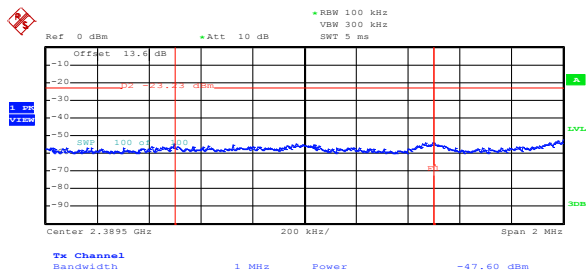

Figure 8.5-37: Conducted peak lower band edge emission for 802.11b at minimum rate

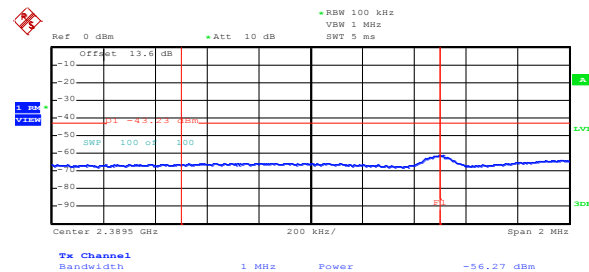

Figure 8.5-38: Conducted average lower band edge emission for 802.11b at minimum rate

8.5.4 Test data, continued

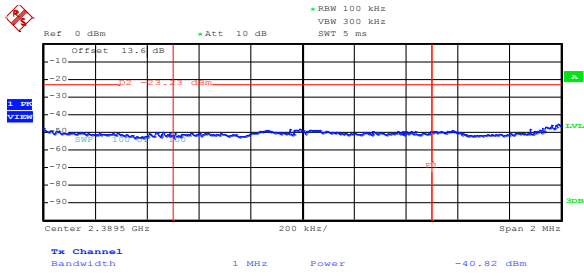

Figure 8.5-39: Conducted peak lower band edge emission for 802.11b at maximum rate

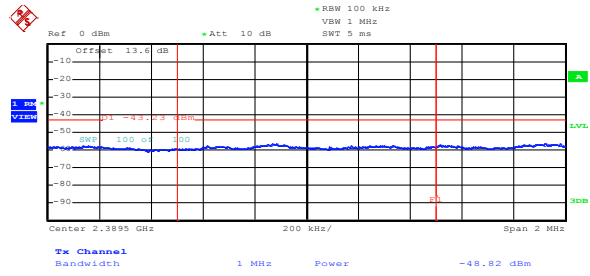

Figure 8.5-40: Conducted average lower band edge emission for 802.11b at maximum rate

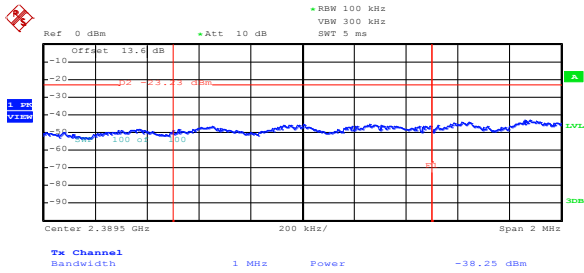

Figure 8.5-41: Conducted peak lower band edge emission for 802.11g at minimum rate

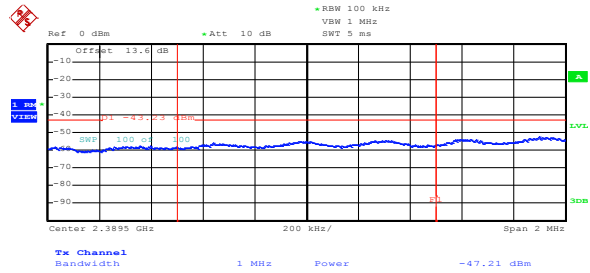

Figure 8.5-42: Conducted average lower band edge emission for 802.11g at minimum rate

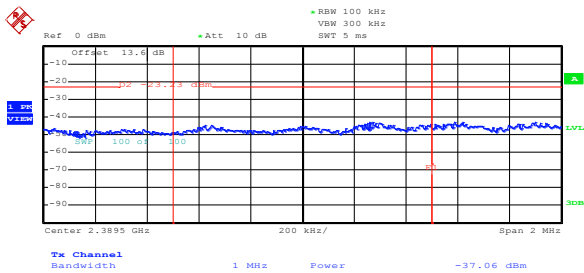

Figure 8.5-43: Conducted peak lower band edge emission for 802.11g at maximum rate

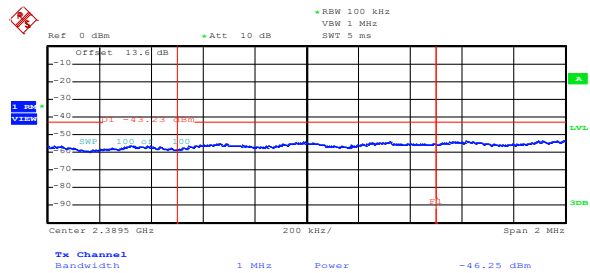

Figure 8.5-44: Conducted average lower band edge emission for 802.11g at maximum rate

8.5.4 Test data, continued

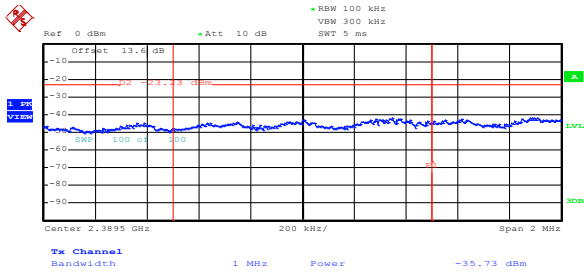

Figure 8.5-45: Conducted peak lower band edge emission for 802.11n at minimum rate

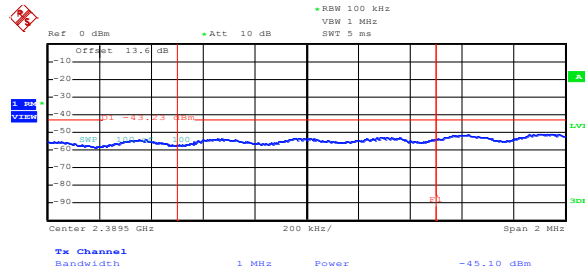

Figure 8.5-46: Conducted average lower band edge emission for 802.11n at minimum rate

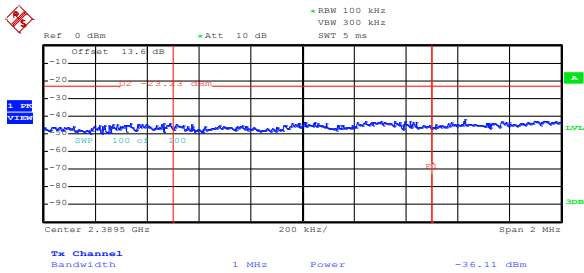

Figure 8.5-47: Conducted peak lower band edge emission for 802.11n at maximum rate

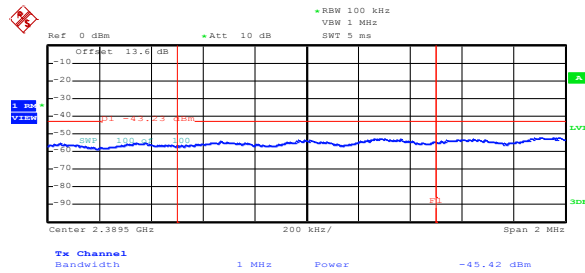

Figure 8.5-48: Conducted average lower band edge emission for 802.11n at maximum rate

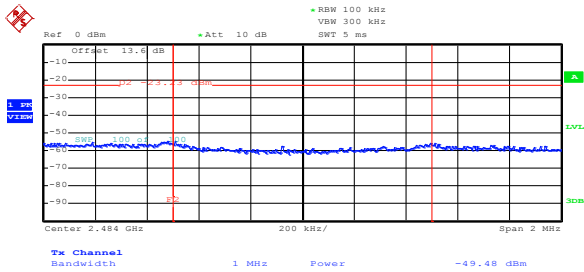

Figure 8.5-49: Conducted peak upper band edge emission for 802.11b at minimum rate

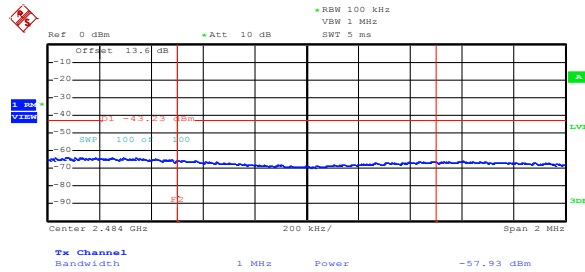

Figure 8.5-50: Conducted average upper band edge emission for 802.11b at minimum rate

8.5.1 Test data, continued

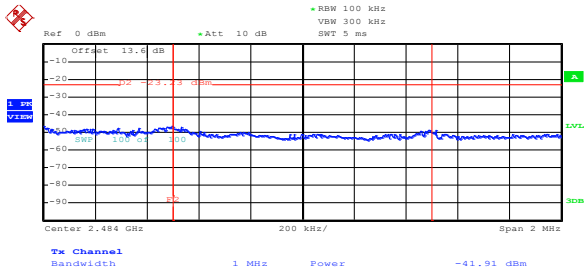

Figure 8.5-51: Conducted peak upper band edge emission for 802.11b at maximum rate

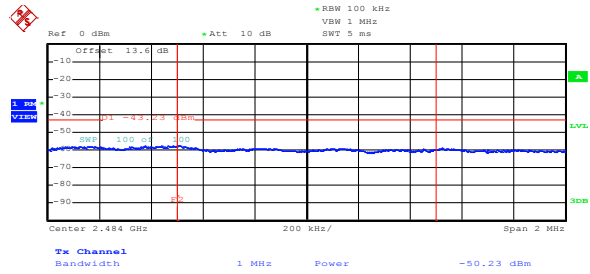

Figure 8.5-52: Conducted average upper band edge emission for 802.11b at maximum rate

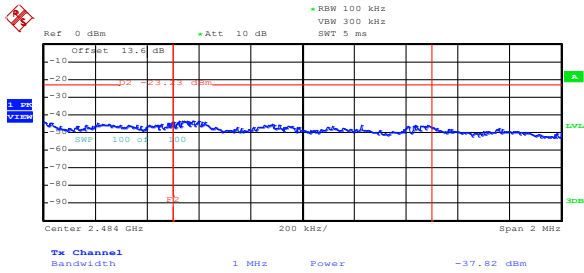

Figure 8.5-53: Conducted peak upper band edge emission for 802.11g at minimum rate

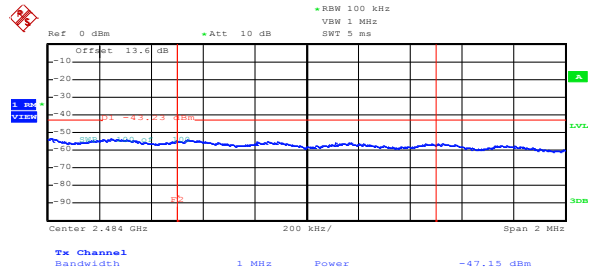

Figure 8.5-54: Conducted average upper band edge emission for 802.11g at minimum rate

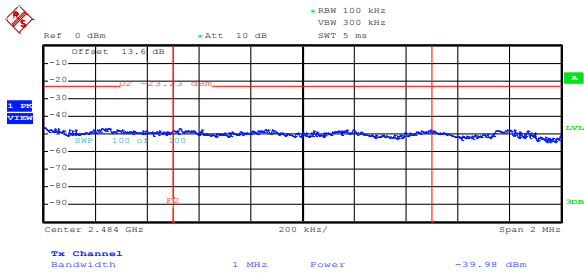

Figure 8.5-55: Conducted peak upper band edge emission for 802.11g at maximum rate

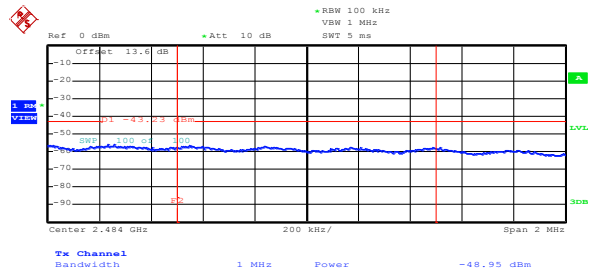

Figure 8.5-56: Conducted average upper band edge emission for 802.11g at maximum rate

8.5.4 Test data, continued

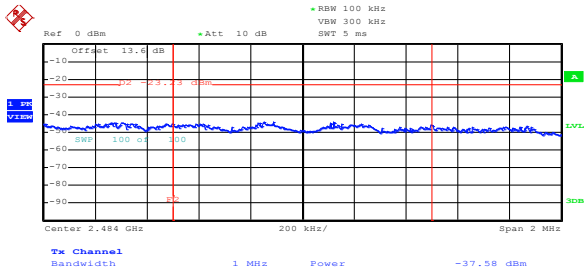

Figure 8.5-57: Conducted peak upper band edge emission for 802.11n at minimum rate

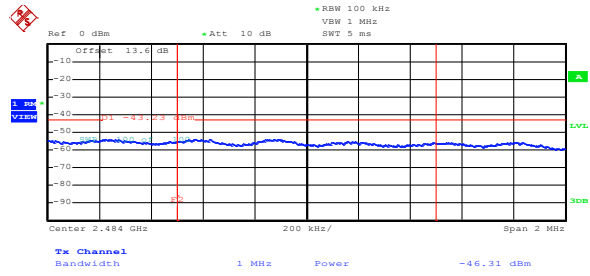

Figure 8.5-58: Conducted average upper band edge emission for 802.11n at minimum rate

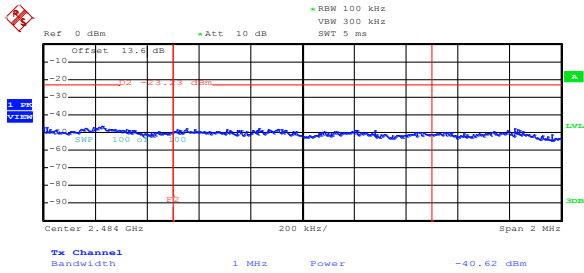

Figure 8.5-59: Conducted peak upper band edge emission for 802.11n at maximum rate

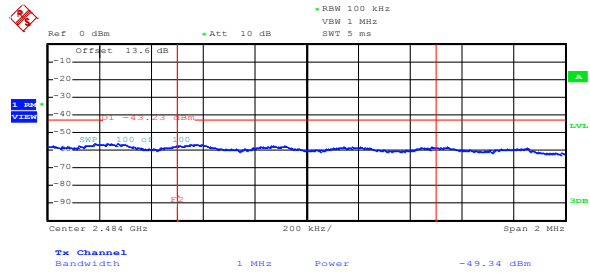

Figure 8.5-60: Conducted average upper band edge emission for 802.11n at maximum rate

## 8.6 FCC 15.247(e) and RSS-210 A8.2(b) Power spectral density for digitally modulated devices

### 8.6.1 Definitions and limits

**FCC:**

For digitally modulated systems, the power spectral density conducted from the intentional radiator to the antenna shall not be greater than 8 dBm in any 3 kHz band during any time interval of continuous transmission. This power spectral density shall be determined in accordance with the provisions of paragraph (b) of this section. The same method of determining the conducted output power shall be used to determine the power spectral density.

**IC:**

The transmitter power spectral density conducted from the transmitter to the antenna shall not be greater than 8 dBm in any 3 kHz band during any time interval of continuous transmission or over 1.0 second if the transmission exceeds 1.0-second duration. This power spectral density shall be determined in accordance with the provisions of Section A8.4(4); (i.e. the power spectral density shall be determined using the same method for determining the conducted output power).

### 8.6.2 Test summary

Test date:	February 5, 2014	Temperature:	22 °C
Test engineer:	Andrey Adelberg	Air pressure:	1008 mbar
Verdict:	Pass	Relative humidity:	31 %

### 8.6.3 Observations, settings and special notes

The output power was tested using peak detector, therefore PSD test was performed using method described in section 10.2 PKPSD of the 558074 D01 DTS Meas Guidance v03r01. Spectrum analyser settings:

Resolution bandwidth:	100 kHz
Video bandwidth:	300 kHz
Frequency span:	30 MHz
Detector mode:	Peak
Trace mode:	Max hold over 100 sweeps

### 8.6.4 Test data

**Table 8.6-1:** PSD measurements results for minimum data rate

Modulation	Frequency, MHz	PSD, dBm/100 kHz	PSD limit, dBm/3 kHz	Margin, dB
802.11b	2412	2.86	8.00	5.14
	2437	2.33	8.00	5.67
	2462	2.18	8.00	5.82
802.11g	2412	0.89	8.00	7.11
	2437	1.52	8.00	6.48
	2462	1.77	8.00	6.23
802.11n	2412	0.74	8.00	7.26
	2437	0.61	8.00	7.39
	2462	0.47	8.00	7.53



8.6.4 Test data, continued

Table 8.6-2: PSD measurements results for maximum data rate

Modulation	Frequency, MHz	PSD, dBm/100 kHz	PSD limit, dBm/3 kHz	Margin, dB
802.11b	2412	7.84	8.00	0.16
	2437	7.47	8.00	0.53
	2462	7.29	8.00	0.71
802.11g	2412	1.30	8.00	6.70
	2437	0.94	8.00	7.06
	2462	0.95	8.00	7.05
802.11n	2412	0.50	8.00	7.50
	2437	0.49	8.00	7.51
	2462	-0.17	8.00	8.17

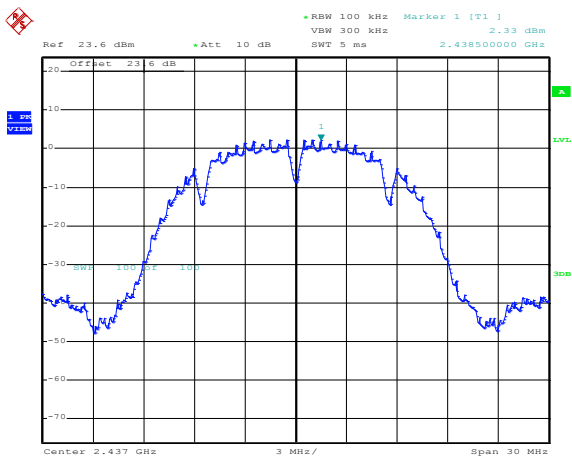

Date: 4.FEB.2014 16:22:23

Figure 8.6-1: PSD sample plot on 802.11b at minimum rate

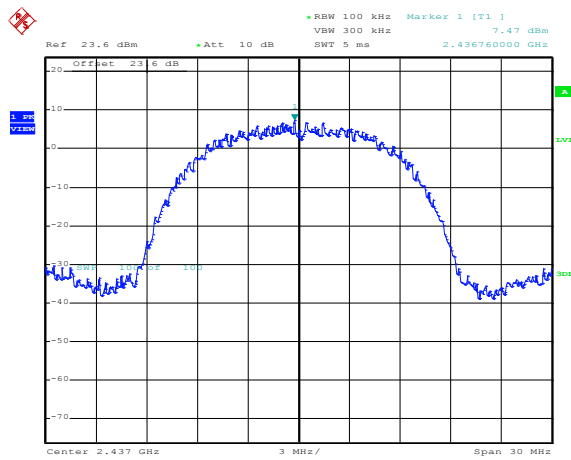

Date: 4.FEB.2014 16:23:59

Figure 8.6-2: PSD sample plot on 802.11b at maximum rate

8.6.4 Test data, continued

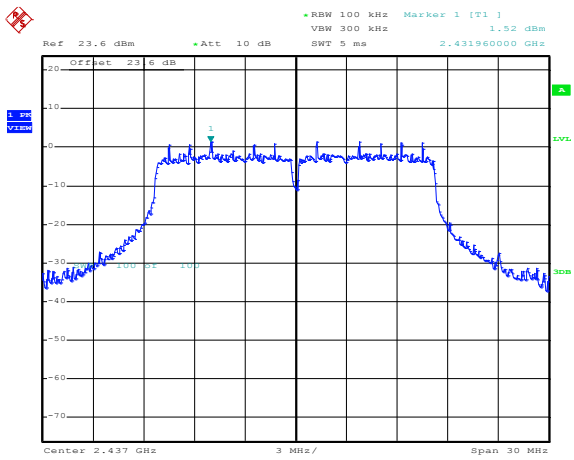

Date: 4.FEB.2014 16:20:36

Figure 8.6-3: PSD sample plot on 802.11g at minimum rate

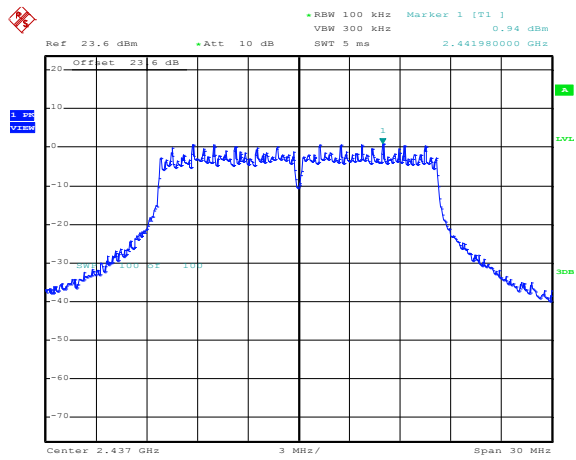

Date: 4.FEB.2014 16:26:07

Figure 8.6-4: PSD sample plot on 802.11g at maximum rate

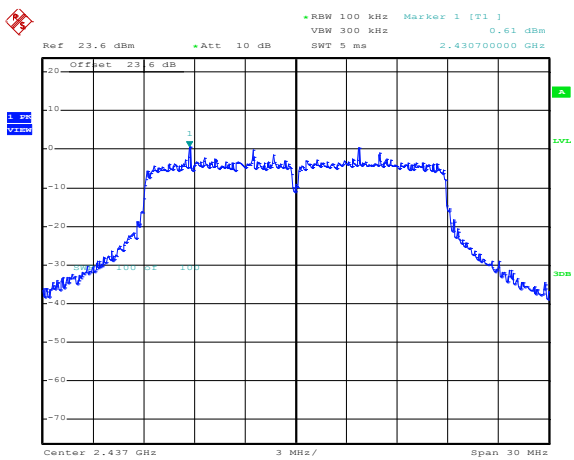

Date: 4.FEB.2014 16:18:20

Figure 8.6-5: PSD sample plot on 802.11n at minimum rate

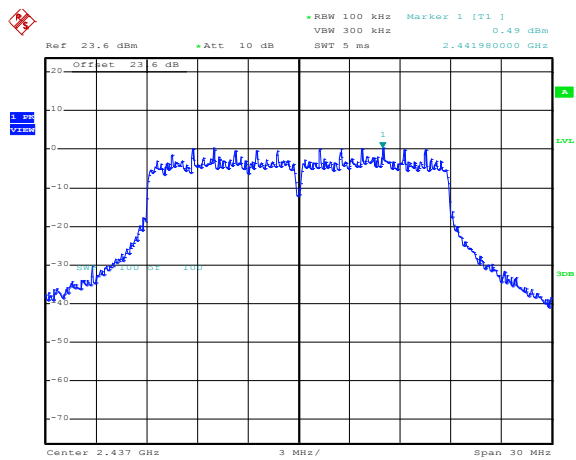

Date: 4.FEB.2014 16:27:46

Figure 8.6-6: PSD sample plot on 802.11n at maximum rate

## Section 9. Block diagrams of test set-ups

### 9.1 Radiated emissions set-up

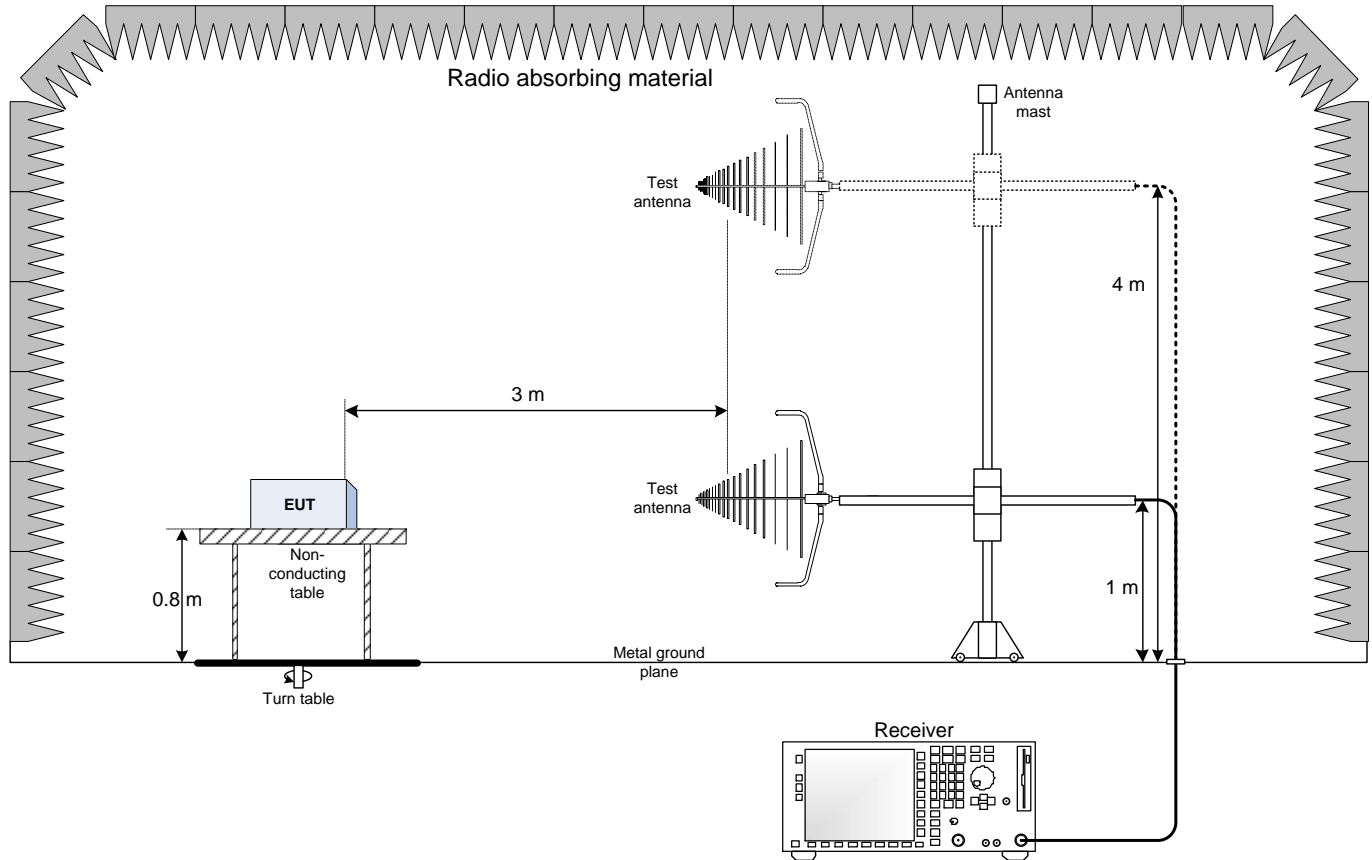

### 9.2 Conducted emissions set-up

