



BUREAU VERITAS

Test Report No.: RF180710W003-3



# FCC TEST REPORT (PART 22)



|            |  |
|------------|--|
| Applicant: | Corporativo Lanix S.A. de C.V.   |
| Address:   | Carretera Internacional Hermosillo-Nogales Km 8.5, Hermosillo Sonora, Mexico |

|                          |  |
|--------------------------|--|
| Manufacturer or Supplier | Corporativo Lanix S.A. de C.V.   |
| Address                  | Carretera Internacional Hermosillo-Nogales Km 8.5, Hermosillo Sonora, Mexico |
| Product                  | smartphone   |
| Brand Name               | LANIX  |
| Model Name               | X530   |
| FCC ID                   | ZC4X530  |
| Date of tests            | Jul. 11 2018 ~ Jul. 29, 2018   |

The tests have been carried out according to the requirements of the following standard:

- FCC PART 22, Subpart H
- ANSI/TIA/EIA-603-D
- ANSI/TIA/EIA-603-E

CONCLUSION: The submitted sample was found to COMPLY with the test requirement

|  |  |
|--|--|
| Prepared by Roger Li<br>Engineer / Mobile Department   | Approved by Sam Tung<br>Manager / Mobile Department  |
| <br>Date: Jul. 30, 2018 | <br>Date: Jul. 30, 2018 |

This report is governed by, and incorporates by reference, CPS Conditions of Service as posted at the date of issuance of this report at <http://www.bureauveritas.com/home/about-us/our-business/cps/about-us/terms-conditions> and is intended for your exclusive use. Any copying or replication of this report to or for any other person or entity, or use of our name or trademark, is permitted only with our prior written permission. This report sets forth our findings solely with respect to the test samples identified herein. The results set forth in this report are not indicative or representative of the quality or characteristics of the lot from which a test sample was taken or any similar or identical product unless specifically and expressly noted. Our report includes all of the tests requested by you and the results thereof based upon the information that you provided to us. Measurement uncertainty is only provided upon request for accredited tests. You have 60 days from date of issuance of this report to notify us of any material error or omission caused by our negligence or if you require measurement uncertainty; provided, however, that such notice shall be in writing and shall specifically address the issue you wish to raise. A failure to raise such issue within the prescribed time shall constitute your unqualified acceptance of the completeness of this report, the tests conducted and the correctness of the report contents.



# TABLE OF CONTENTS

**RELEASE CONTROL RECORD ..... 4**

**1 SUMMARY OF TEST RESULTS..... 5**

1.1 MEASUREMENT UNCERTAINTY ..... 5

1.2 TEST SITE AND INSTRUMENTS ..... 6

**2 GENERAL INFORMATION ..... 7**

2.1 GENERAL DESCRIPTION OF EUT ..... 7

2.2 CONFIGURATION OF SYSTEM UNDER TEST ..... 9

2.3 DESCRIPTION OF SUPPORT UNITS ..... 10

2.4 TEST ITEM AND TEST CONFIGURATION..... 10

2.5 EUT OPERATING CONDITIONS..... 12

2.6 GENERAL DESCRIPTION OF APPLIED STANDARDS..... 12

**3 TEST TYPES AND RESULTS..... 13**

3.1 OUTPUT POWER MEASUREMENT ..... 13

3.1.1 LIMITS OF OUTPUT POWER MEASUREMENT ..... 13

3.1.2 TEST PROCEDURES ..... 13

3.1.3 TEST SETUP..... 14

3.1.4 TEST RESULTS ..... 15

3.2 FREQUENCY STABILITY MEASUREMENT ..... 17

3.2.1 LIMITS OF FREQUENCY STABILITY MEASUREMENT..... 17

3.2.2 TEST PROCEDURE..... 17

3.2.3 TEST SETUP..... 17

3.2.4 TEST RESULTS ..... 18

3.3 OCCUPIED BANDWIDTH MEASUREMENT ..... 21

3.3.1 TEST PROCEDURES ..... 21

3.3.2 TEST SETUP..... 21

3.3.3 TEST RESULTS ..... 22

3.4 BAND EDGE MEASUREMENT ..... 24

3.4.1 LIMITS OF BAND EDGE MEASUREMENT ..... 24

3.4.2 TEST SETUP..... 24

3.4.3 TEST PROCEDURES ..... 24

3.4.4 TEST RESULTS ..... 25

3.5 CONDUCTED SPURIOUS EMISSIONS..... 26

3.5.1 LIMITS OF CONDUCTED SPURIOUS EMISSIONS MEASUREMENT ..... 26

3.5.2 TEST PROCEDURE..... 26

3.5.3 TEST SETUP..... 26

3.5.4 TEST RESULTS ..... 27

3.6 RADIATED EMISSION MEASUREMENT..... 30

3.6.1 LIMITS OF RADIATED EMISSION MEASUREMENT ..... 30

3.6.2 TEST PROCEDURES ..... 30

3.6.3 DEVIATION FROM TEST STANDARD ..... 30

3.6.4 TEST SETUP..... 31



**BUREAU  
VERITAS**

**Test Report No.: RF180710W003-3**

|          |   |           |
|----------|---|-----------|
| 3.6.5    | TEST RESULTS .....  | 33        |
| 3.7      | PEAK TO AVERAGE RATIO .....   | 53        |
| 3.7.1    | LIMITS OF PEAK TO AVERAGE RATIO MEASUREMENT .....   | 53        |
| 3.7.2    | TEST SETUP .....  | 53        |
| 3.7.3    | TEST PROCEDURES .....   | 53        |
| 3.7.4    | TEST RESULTS .....  | 54        |
| <b>4</b> | <b>PHOTOGRAPHS OF THE TEST CONFIGURATION .....</b>  | <b>63</b> |
| <b>5</b> | <b>INFORMATION ON THE TESTING LABORATORIES .....</b>  | <b>64</b> |
| <b>6</b> | <b>APPENDIX A – MODIFICATIONS RECORDERS FOR ENGINEERING CHANGES TO THE EUT BY THE LAB .....</b> | <b>65</b> |



**BUREAU**  
**VERITAS**

Test Report No.: RF180710W003-3

## RELEASE CONTROL RECORD

| ISSUE NO.      | REASON FOR CHANGE | DATE ISSUED   |
|----------------|-------------------|---------------|
| RF180710W003-3 | Original release  | Jul. 30, 2018 |

## 1 SUMMARY OF TEST RESULTS

The EUT has been tested according to the following specifications:

| APPLIED STANDARD: FCC Part 22 & Part 2 |                              |        |   |
|--|------------------------------|--------|---|
| STANDARD SECTION                       | TEST TYPE                    | RESULT | REMARK  |
| 2.1046<br>22.913 (a)                   | Effective Radiated Power     | PASS   | Meet the requirement of limit.  |
| 2.1055<br>22.355                       | Frequency Stability          | PASS   | Meet the requirement of limit.  |
| 2.1049<br>22.917b                      | Occupied Bandwidth           | PASS   | Meet the requirement of limit.  |
| --                                     | Peak to average ratio*       | PASS   | Meet the requirement of limit.  |
| 22.917                                 | Band Edge Measurements       | PASS   | Meet the requirement of limit.  |
| 2.1051<br>22.917                       | Conducted Spurious Emissions | PASS   | Meet the requirement of limit.  |
| 2.1053<br>22.917                       | Radiated Spurious Emissions  | PASS   | Meet the requirement of limit.<br>Minimum passing margin is<br>-20.32dB at 1666MHz. |

\* Refer to KDB 971168 D01 Power Meas License Digital Systems v02r02.

### 1.1 MEASUREMENT UNCERTAINTY

Where relevant, the following measurement uncertainty levels have been estimated for tests performed on the EUT as specified in CISPR 16-4-2:

| MEASUREMENT         | FREQUENCY     | UNCERTAINTY |
|---------------------|---------------|-------------|
| Conducted emissions | 9kHz~30MHz    | 2.66dB      |
| Radiated emissions  | 9KHz ~ 30MHz  | 2.68dB      |
|                     | 30MHz ~ 1GHz  | 3.26dB      |
|                     | 1GHz ~ 18GHz  | 4.48dB      |
|                     | 18GHz ~ 40GHz | 4.12dB      |

This uncertainty represents an expanded uncertainty expressed at approximately the 95% confidence level using a coverage factor of k=2.



## 1.2 TEST SITE AND INSTRUMENTS

| Equipment                                   | Manufacturer | Model No.                           | Serial No.                      | Last Cal.  | Next Cal.  |
|---|--------------|-------------------------------------|---------------------------------|------------|------------|
| MXE EMI Receiver                            | KEYSIGHT     | N9038A-544                          | MY54450026                      | Mar. 16,18 | Mar. 15,19 |
| EXA Signal Analyzer                         | KEYSIGHT     | N9010A-526                          | MY54510322                      | Mar. 16,18 | Mar. 15,19 |
| Bilog Antenna 1                             | ETS-LINDGREN | 3143B                               | 00161964                        | Nov. 26,16 | Nov. 25,18 |
| Bilog Antenna 2                             | ETS-LINDGREN | 3143B                               | 00161965                        | Nov. 26,16 | Nov. 25,18 |
| Horn Antenna 1                              | ETS-LINDGREN | 3117                                | 00168728                        | Nov. 26,16 | Nov. 25,18 |
| Horn Antenna 2                              | ETS-LINDGREN | 3117                                | 00168692                        | Nov. 26,16 | Nov. 25,18 |
| Loop antenna                                | Daze         | ZN30900A                            | 0708                            | Nov. 20,17 | Nov. 19,18 |
| Horn Antenna<br>(18GHz-40GHz)               | N/A          | QWH-SL-18-40<br>-K-SG/QMS-00<br>361 | 15433                           | Dec. 16,16 | Dec. 15,18 |
| Radio<br>Communication<br>Analyzer          | ANRITSU      | MT8820C                             | 6201465426                      | Mar. 02,18 | Mar. 01,19 |
| Signal Pre-Amplifier                        | EMSI         | EMC 9135                            | 980249                          | Jul. 09,18 | Jul. 08,19 |
| Signal Pre-Amplifier                        | EMSI         | EMC 012645B                         | 980257                          | Jul. 09,18 | Jul. 08,19 |
| Signal Pre-Amplifier                        | EMSI         | EMC 184045B                         | 980259                          | Jul. 09,18 | Jul. 08,19 |
| 3m Semi-anechoic<br>Chamber                 | ETS-LINDGREN | 9m*6m*6m                            | Euroshieldpn-<br>CT0001143-1216 | Apr. 21,18 | Apr. 20,19 |
| Test Software                               | E3           | V 9.160323                          | N/A                             | N/A        | N/A        |
| Test Software                               | ADT          | ADT_Radiated<br>_V7.6.15.9.2        | N/A                             | N/A        | N/A        |
| 10dB Attenuator                             | JFW/USA      | 50HF-010-SM<br>A                    | 1505                            | Jul. 09,18 | Jul. 08,19 |
| Power Meter                                 | Anritsu      | ML2495A                             | 1506002                         | Mar. 02,18 | Mar. 01,19 |
| Power Sensor                                | Anritsu      | MA2411B                             | 1339352                         | Mar. 16,18 | Mar. 15,19 |
| Humid & Temp<br>Programmable Tester         | Juyi         | ITH-120-45-CP<br>-AR                | IAA1504-001                     | Jul. 09,18 | Jul. 08,19 |
| MXG Analog<br>Microvave<br>Signal Generator | KEYSIGHT     | N5183A                              | MY50143024                      | Mar. 13,18 | Mar. 12,19 |

**NOTE:** 1. The calibration interval of the above test instruments is 12 months or 24 months and the calibrations are traceable to CEPREI/CHINA, GRGT/CHINA and NIM/CHINA.

2. The test was performed in 3m Semi-anechoic Chamber and RF Oven Room.

3. The horn antenna is used only for the measurement of emission frequency above 1GHz if tested.

4. The FCC Site Registration No. is 525120.



## 2 GENERAL INFORMATION

### 2.1 GENERAL DESCRIPTION OF EUT

|                     |   |                     |
|---------------------|---|---------------------|
| EUT                 | smartphone  |                     |
| MODEL NAME          | X530  |                     |
| POWER SUPPLY        | 5.0Vdc (adapter or host equipment)<br>3.8Vdc (Li-ion, battery)                                      |                     |
| MODULATION TYPE     | GSM/GPRS  | GMSK                |
|                     | WCDMA   | BPSK,QPSK           |
| FREQUENCY RANGE     | GSM/GPRS  | 824.2MHz ~ 848.8MHz |
|                     | WCDMA   | 826.4MHz ~ 846.6MHz |
| MAX. ERP POWER      | GSM   | 623mW               |
|                     | GPRS  | 347mW               |
|                     | WCDMA   | 127mW               |
| EMISSION DESIGNATOR | GSM   | 248KGXW             |
|                     | GPRS  | 245KG7W             |
|                     | WCDMA   | 4M17F9W             |
| ANTENNA TYPE        | Fixed Internal antenna with -0.5dBi gain  |                     |
| HW VERSION          | V1.0  |                     |
| SW VERSION          | X530_SW_01  |                     |
| I/O PORTS           | Refer to user's manual  |                     |
| DATA CABLE          | USB cable: non-shielded, detachable, 1.0meter<br>Earphone cable: non-shielded, detachable, 1.3meter |                     |

**NOTE:**

- For a more detailed features description, please refer to the manufacturer's specifications or the user's manual.
- The EUT was powered by the following adapter:

| ADAPTER |                    |
|---------|--------------------|
| BRAND:  | LANIX              |
| MODEL:  | X530-C             |
| INPUT:  | AC 100-240V, 120mA |
| OUTPUT: | DC 5V, 700mA       |

- The EUT matched the following USB cable and Earphone:

| USB CABLE    |           |
|--------------|-----------|
| BRAND:       | LANIX     |
| MODEL:       | X530      |
| SIGNAL LINE: | 1.0 METER |



**BUREAU  
VERITAS**

Test Report No.: RF180710W003-3

|                     |           |
|---------------------|-----------|
| <b>EARPHONE</b>     |           |
| <b>BRAND:</b>       | LANIX     |
| <b>MODEL:</b>       | X530      |
| <b>SIGNAL LINE:</b> | 1.3 METER |

4. For the test results, the EUT had been tested with all conditions. But only the worst case was shown in test report.





## 2.2 CONFIGURATION OF SYSTEM UNDER TEST

### FOR RADIATION EMISSION

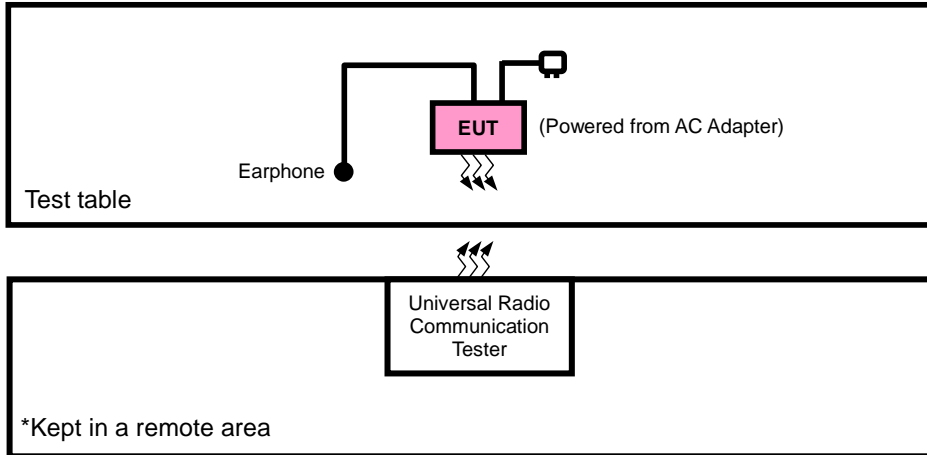

### FOR CONDUCTED & E.R.P. TEST

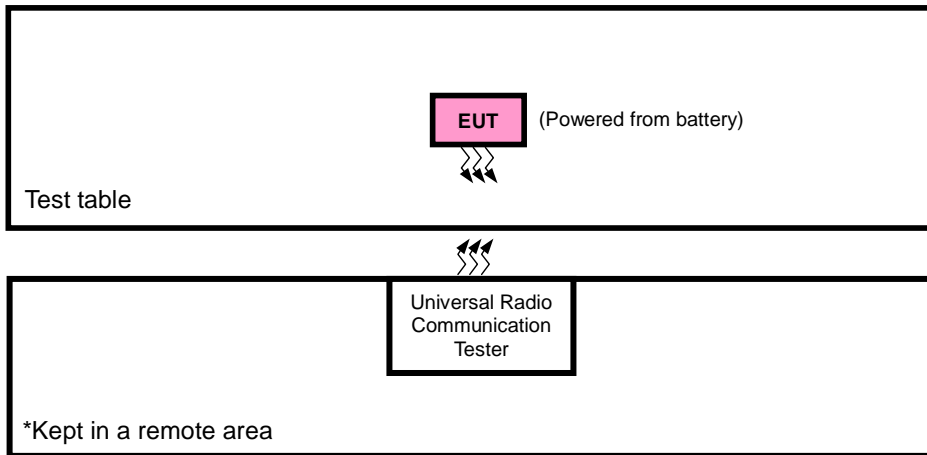



### 2.3 DESCRIPTION OF SUPPORT UNITS

The EUT has been tested as an independent unit together with other necessary accessories or support units. The following support units or accessories were used to form a representative test configuration during the tests.

| NO. | PRODUCT   | BRAND    | MODEL NO. | SERIAL NO. | FCC ID |
|-----|-----------|----------|-----------|------------|--------|
| 1   | DC source | LONG WEI | PS-6403D  | 010934269  | N/A    |
| 2   | PC        | HP       | A6608CN   | 3CR83825X3 | N/A    |

| NO. | SIGNAL CABLE DESCRIPTION OF THE ABOVE SUPPORT UNITS |
|-----|---|
| 1   | DC Line: Unshielded, Detachable 1.0m                |
| 2   | AC Line: Unshielded, Detachable 1.5m                |

**NOTE:**

1. All power cords of the above support units are non shielded (1.8m).

### 2.4 TEST ITEM AND TEST CONFIGURATION

Pre-Scan has been conducted to determine the worst-case mode from all possible combinations between available modulations, data rates, XYZ axis and antenna ports. The worst case in ERP and radiated emission was found when positioned on X-plane for GSM/GPRS/WCDMA. Following channel(s) was (were) selected for the final test as listed below:

| EUT CONFIGURE MODE | DESCRIPTION  |
|--------------------|--|
| A                  | EUT + Adapter + USB Cable+ Earphone with GSM ,WCDMA link |
| B                  | EUT + Battery with GSM ,WCDMA link                       |

#### GSM MODE

| EUT CONFIGURE MODE | TEST ITEM           | AVAILABLE CHANNEL | TESTED CHANNEL | MODE      |
|--------------------|---------------------|-------------------|----------------|-----------|
| B                  | ERP                 | 128 to 251        | 128, 189, 251  | GSM, GPRS |
| B                  | FREQUENCY STABILITY | 128 to 251        | 128, 251       | GSM, GPRS |
| B                  | OCCUPIED BANDWIDTH  | 128 to 251        | 128, 189, 251  | GSM, GPRS |
| B                  | BAND EDGE           | 128 to 251        | 128, 251       | GSM, GPRS |
| B                  | CONDCUDED EMISSION  | 128 to 251        | 128, 189, 251  | GSM, GPRS |
| A                  | RADIATED EMISSION   | 128 to 251        | 128, 189, 251  | GSM, GPRS |



**WCDMA MODE**

| EUT CONFIGURE MODE | TEST ITEM           | AVAILABLE CHANNEL | TESTED CHANNEL   | MODE  |
|--------------------|---------------------|-------------------|------------------|-------|
| B                  | ERP                 | 4132 to 4233      | 4132, 4182, 4233 | WCDMA |
| B                  | FREQUENCY STABILITY | 4132 to 4233      | 4132, 4233       | WCDMA |
| B                  | OCCUPIED BANDWIDTH  | 4132 to 4233      | 4132, 4182, 4233 | WCDMA |
| B                  | BAND EDGE           | 4132 to 4233      | 4132, 4233       | WCDMA |
| B                  | CONDCUDED EMISSION  | 4132 to 4233      | 4132, 4182, 4233 | WCDMA |
| A                  | RADIATED EMISSION   | 4132 to 4233      | 4132, 4182, 4233 | WCDMA |

| TEST ITEM           | ENVIRONMENTAL CONDITIONS | INPUT POWER         | TESTED BY   |
|---------------------|--------------------------|---------------------|-------------|
| ERP                 | 23deg. C, 62%RH          | 3.8Vdc from Battery | Rose Ma     |
| FREQUENCY STABILITY | 23deg. C, 62%RH          | DC 3.45V/3.8V/4.4V  | Wenliang Wu |
| OCCUPIED BANDWIDTH  | 23deg. C, 62%RH          | 3.8Vdc from Battery | Wenliang Wu |
| BAND EDGE           | 23deg. C, 62%RH          | 3.8Vdc from Battery | Wenliang Wu |
| CONDCUDED EMISSION  | 23deg. C, 62%RH          | 3.8Vdc from Battery | Wenliang Wu |
| RADIATED EMISSION   | 25deg. C, 63.6%RH        | 5Vdc from adapter   | Rose Ma     |

## 2.5 EUT OPERATING CONDITIONS

The EUT makes a call to the communication simulator. The communication simulator station system controlled a EUT to export maximum output power under transmission mode and specific channel frequency

## 2.6 GENERAL DESCRIPTION OF APPLIED STANDARDS

The EUT is a RF product. According to the specifications of the manufacturer, it must comply with the requirements of the following standards:

**FCC 47 CFR Part 2**

**FCC 47 CFR Part 22**

**KDB 971168 D01 Power Meas License Digital Systems v03**

**ANSI/TIA/EIA-603-D**

**ANSI/TIA/EIA-603-E**

**ANSI C63.26-2015**

**NOTE:** All test items have been performed and recorded as per the above standards.

### 3 TEST TYPES AND RESULTS

#### 3.1 OUTPUT POWER MEASUREMENT

##### 3.1.1 LIMITS OF OUTPUT POWER MEASUREMENT

Mobile / Portable station are limited to 7 watts e.r.p.

##### 3.1.2 TEST PROCEDURES

###### EIRP / ERP MEASUREMENT:

- a. All measurements were done at low, middle and high operational frequency range. RBW and VBW is 1MHz for GSM & GPRS and 5MHz for WCDMA mode.
- b. Substitution method is used for E.I.R.P measurement. In the semi-anechoic chamber, EUT placed on the 0.8m height of Turn Table, rotated the table around 360 degrees to search the maximum radiation power and receiver antenna shall be rotated vertical and horizontal polarization and moved height from 1m to 4m to find the maximum polar radiated power. The "Read Value" is the spectrum reading the maximum power value.
- c. The substitution horn antenna is substituted for EUT at the same position and signals generator export the CW signal to the substitution antenna via a tx cable. Rotated the Turn Table and moved receiving antenna to find the maximum radiation power. Adjust output power level of S.G to get a Value of spectrum reading equal to "Read Value" of step b. Record the power level of S.G
- d.  $EIRP = \text{Output power level of S.G} - \text{TX cable loss} + \text{Antenna gain of substitution horn}$ .  
E.R.P power can be calculated form E.I.R.P power by subtracting the gain of dipole,  
 $E.R.P \text{ power} = E.I.P.R \text{ power} - 2.15\text{dBi}$ .

###### CONDUCTED POWER MEASUREMENT:

The EUT was set up for the maximum power with WCDMA link data modulation and link up with simulator. Set the EUT to transmit under low, middle and high channel and record the power level shown on simulator.

### 3.1.3 TEST SETUP

#### EIRP / ERP Measurement:

<Radiated Emission below or equal 1 GHz>

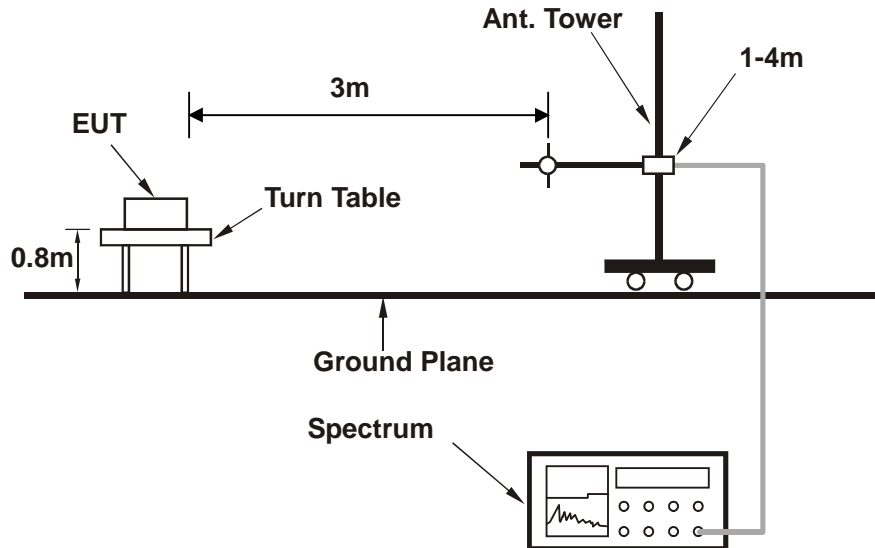

<Radiated Emission above 1 GHz>

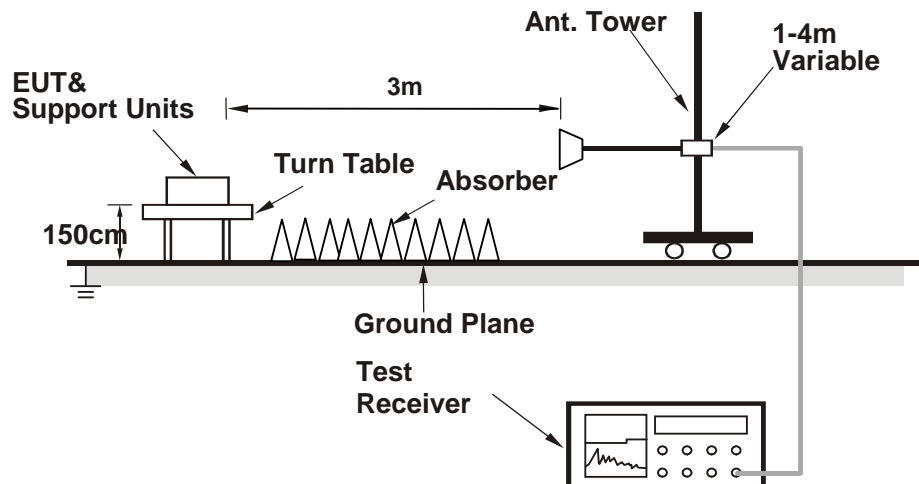

For the actual test configuration, please refer to the attached file (Test Setup Photo).

#### CONDUCTED POWER MEASUREMENT:

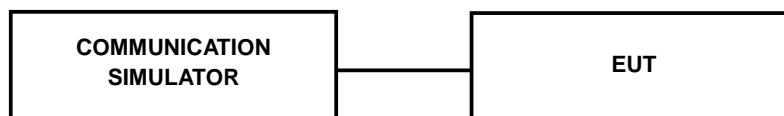



### 3.1.4 TEST RESULTS

#### CONDUCTED OUTPUT POWER (dBm)

| Band            | GSM850 |       |       |
|-----------------|--------|-------|-------|
| Channel         | 128    | 189   | 251   |
| Frequency (MHz) | 824.2  | 836.4 | 848.8 |
| GSM             | 31.82  | 31.83 | 31.67 |
| GPRS 8          | 31.80  | 31.81 | 31.65 |
| GPRS 10         | 29.72  | 29.73 | 29.57 |
| GPRS 11         | 28.24  | 28.25 | 28.09 |
| GPRS 12         | 26.57  | 26.58 | 26.42 |

| Band            | WCDMA V |       |       |
|-----------------|---------|-------|-------|
| Channel         | 4132    | 4182  | 4233  |
| Frequency (MHz) | 826.4   | 836.4 | 846.6 |
| RMC 12.2K       | 21.71   | 21.58 | 21.77 |
| HSPA            |         |       |       |
| HSDPA Subtest-1 | 21.39   | 21.26 | 21.45 |
| HSDPA Subtest-2 | 21.34   | 21.21 | 21.40 |
| HSDPA Subtest-3 | 20.86   | 20.73 | 20.92 |
| HSDPA Subtest-4 | 20.83   | 20.70 | 20.89 |
| HSUPA Subtest-1 | 21.36   | 21.23 | 21.42 |
| HSUPA Subtest-2 | 21.30   | 21.17 | 21.36 |
| HSUPA Subtest-3 | 20.77   | 20.64 | 20.83 |
| HSUPA Subtest-4 | 20.75   | 20.62 | 20.81 |
| HSUPA Subtest-5 | 21.43   | 21.30 | 21.49 |



**ERP POWER (dBm)**

**GSM**

| Channel | Frequency (MHz) | SPA LVL (dBm) | Correction Factor(dB) | ERP(dBm) | ERP(mW)       | Polarization (H/V) |
|---------|-----------------|---------------|-----------------------|----------|---------------|--------------------|
| 128     | 824.2           | -4.21         | 33.56                 | 27.20    | 524.69        | H                  |
| 189     | 836.4           | -3.53         | 33.63                 | 27.95    | <b>623.02</b> | H                  |
| 251     | 848.8           | -3.51         | 33.57                 | 27.91    | 617.73        | H                  |
| 128     | 824.2           | -12.41        | 34.24                 | 19.68    | 92.81         | V                  |
| 189     | 836.4           | -11.97        | 34.59                 | 20.47    | 111.33        | V                  |
| 251     | 848.8           | -10.45        | 34.62                 | 22.02    | 159.33        | V                  |

**REMARKS:** 1. ERP Output Power (dBm) = SPA LVL (dBm) + Correction Factor (dB) -2.15(dB).  
2. Correction factor (dB) = Free Space Loss + Antenna Factor + Cable Loss

**GPRS**

| Channel | Frequency (MHz) | SPA LVL (dBm) | Correction Factor(dB) | ERP(dBm) | ERP(mW)       | Polarization (H/V) |
|---------|-----------------|---------------|-----------------------|----------|---------------|--------------------|
| 128     | 824.2           | -7.31         | 33.56                 | 24.10    | 256.98        | H                  |
| 189     | 836.4           | -6.07         | 33.63                 | 25.41    | <b>347.46</b> | H                  |
| 251     | 848.8           | -7.08         | 33.57                 | 24.34    | 271.52        | H                  |
| 128     | 824.2           | -17.27        | 34.24                 | 14.82    | 30.31         | V                  |
| 189     | 836.4           | -15.84        | 34.59                 | 16.60    | 45.67         | V                  |
| 251     | 848.8           | -18.14        | 34.62                 | 14.33    | 27.12         | V                  |

**REMARKS:** 1. ERP Output Power (dBm) = SPA LVL (dBm) + Correction Factor (dB) -2.15(dB).  
2. Correction factor (dB) = Free Space Loss + Antenna Factor + Cable Loss

**WCDMA**

| Channel | Frequency (MHz) | SPA LVL (dBm) | Correction Factor(dB) | ERP(dBm) | ERP(mW)       | Polarization (H/V) |
|---------|-----------------|---------------|-----------------------|----------|---------------|--------------------|
| 4132    | 826.4           | -11.99        | 33.56                 | 19.42    | 87.48         | H                  |
| 4182    | 836.4           | -11.55        | 33.63                 | 19.93    | 98.38         | H                  |
| 4233    | 846.6           | -10.38        | 33.57                 | 21.04    | <b>127.00</b> | H                  |
| 4132    | 826.4           | -17.73        | 34.24                 | 14.36    | 27.26         | V                  |
| 4182    | 836.4           | -18.91        | 34.59                 | 13.53    | 22.52         | V                  |
| 4233    | 846.6           | -18.31        | 34.62                 | 14.16    | 26.08         | V                  |

**REMARKS:** 1. ERP Output Power (dBm) = SPA LVL (dBm) + Correction Factor (dB) -2.15(dB).  
2. Correction factor (dB) = Free Space Loss + Antenna Factor + Cable Loss



## 3.2 FREQUENCY STABILITY MEASUREMENT

### 3.2.1 LIMITS OF FREQUENCY STABILITY MEASUREMENT

1.5 ppm is for base and fixed station. 2.5 ppm is for mobile station.

### 3.2.2 TEST PROCEDURE

- Device is placed at the oven room. The oven room could control the temperatures and humidity. Power warm up is at least 15 min and power applied should perform before recording frequency error.
- EUT is connected the external power supply to control the DC input power. The test voltage range is from minimum to maximum working voltage. Each step shall be record the frequency error rate.
- The temperature range step is 10 degrees in this test items. All temperature levels shall be hold the  $\pm 0.5^{\circ}\text{C}$  during the measurement testing. The each temperature step shall be at least 0.5 hours, consider the EUT could be test under the stability condition.

**NOTE:** The frequency error was recorded frequency error from the communication simulator.

### 3.2.3 TEST SETUP

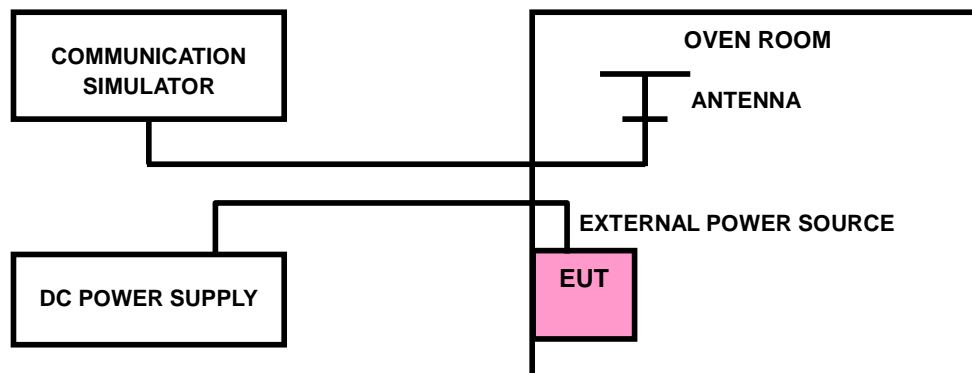



### 3.2.4 TEST RESULTS

#### GSM 850

##### FREQUENCY ERROR VS. VOLTAGE

| VOLTAGE (Volts) | FREQUENCY ERROR (ppm) |              | LIMIT (ppm) |
|-----------------|-----------------------|--------------|-------------|
|                 | Low Channel           | High Channel |             |
| 3.8             | -0.0019               | -0.0022      | 2.5         |
| 3.45            | 0.0022                | 0.0024       | 2.5         |
| 4.4             | 0.0020                | 0.0023       | 2.5         |

**NOTE:** The applicant defined the normal working voltage of the battery is from 3.45Vdc to 4.4Vdc.

##### FREQUENCY ERROR vs. TEMPERATURE.

| TEMP. (°C) | FREQUENCY ERROR (ppm) |              | LIMIT (ppm) |
|------------|-----------------------|--------------|-------------|
|            | Low Channel           | High Channel |             |
| -30        | -0.0123               | -0.0119      | 2.5         |
| -20        | -0.0109               | -0.0105      | 2.5         |
| -10        | -0.0094               | -0.0090      | 2.5         |
| 0          | -0.0080               | -0.0077      | 2.5         |
| 10         | -0.0067               | -0.0064      | 2.5         |
| 20         | -0.0051               | -0.0048      | 2.5         |
| 30         | -0.0038               | -0.0035      | 2.5         |
| 40         | -0.0024               | -0.0021      | 2.5         |
| 50         | -0.0011               | -0.0008      | 2.5         |



**GPRS 850**

**FREQUENCY ERROR VS. VOLTAGE**

| VOLTAGE (Volts) | FREQUENCY ERROR (ppm) |              | LIMIT (ppm) |
|-----------------|-----------------------|--------------|-------------|
|                 | Low Channel           | High Channel |             |
| 3.8             | -0.0022               | -0.0019      | 2.5         |
| 3.45            | 0.0024                | 0.0022       | 2.5         |
| 4.4             | 0.0023                | 0.0020       | 2.5         |

**NOTE:** The applicant defined the normal working voltage of the battery is from 3.45Vdc to 4.4Vdc.

**FREQUENCY ERROR vs. TEMPERATURE.**

| TEMP. (°C) | FREQUENCY ERROR (ppm) |              | LIMIT (ppm) |
|------------|-----------------------|--------------|-------------|
|            | Low Channel           | High Channel |             |
| -30        | -0.0129               | -0.0119      | 2.5         |
| -20        | -0.0113               | -0.0105      | 2.5         |
| -10        | -0.0098               | -0.0091      | 2.5         |
| 0          | -0.0083               | -0.0078      | 2.5         |
| 10         | -0.0069               | -0.0065      | 2.5         |
| 20         | -0.0052               | -0.0050      | 2.5         |
| 30         | -0.0038               | -0.0037      | 2.5         |
| 40         | -0.0023               | -0.0024      | 2.5         |
| 50         | -0.0009               | -0.0011      | 2.5         |



**WCDMA Band V**

**FREQUENCY ERROR VS. VOLTAGE**

| VOLTAGE (Volts) | FREQUENCY ERROR (ppm) |              | LIMIT (ppm) |
|-----------------|-----------------------|--------------|-------------|
|                 | Low Channel           | High Channel |             |
| 3.8             | -0.0021               | -0.0019      | 2.5         |
| 3.45            | 0.0024                | 0.0021       | 2.5         |
| 4.4             | 0.0023                | 0.0019       | 2.5         |

**NOTE:** The applicant defined the normal working voltage of the battery is from 3.45Vdc to 4.4Vdc.

**FREQUENCY ERROR vs. TEMPERATURE.**

| TEMP. (°C) | FREQUENCY ERROR (ppm) |              | LIMIT (ppm) |
|------------|-----------------------|--------------|-------------|
|            | Low Channel           | High Channel |             |
| -30        | -0.0122               | -0.0107      | 2.5         |
| -20        | -0.0108               | -0.0095      | 2.5         |
| -10        | -0.0093               | -0.0081      | 2.5         |
| 0          | -0.0079               | -0.0070      | 2.5         |
| 10         | -0.0063               | -0.0056      | 2.5         |
| 20         | -0.0050               | -0.0044      | 2.5         |
| 30         | -0.0037               | -0.0034      | 2.5         |
| 40         | -0.0026               | -0.0024      | 2.5         |
| 50         | -0.0009               | -0.0010      | 2.5         |

### 3.3 OCCUPIED BANDWIDTH MEASUREMENT

#### 3.3.1 TEST PROCEDURES

The EUT makes a call to the communication simulator. All measurements were done at low, middle and high operational frequency range. The communication simulator station system controlled a EUT to export maximum output power under transmission mode and specific channel frequency. Use OBW measurement function of Spectrum analyzer to measure 99 % occupied bandwidth.

#### 3.3.2 TEST SETUP

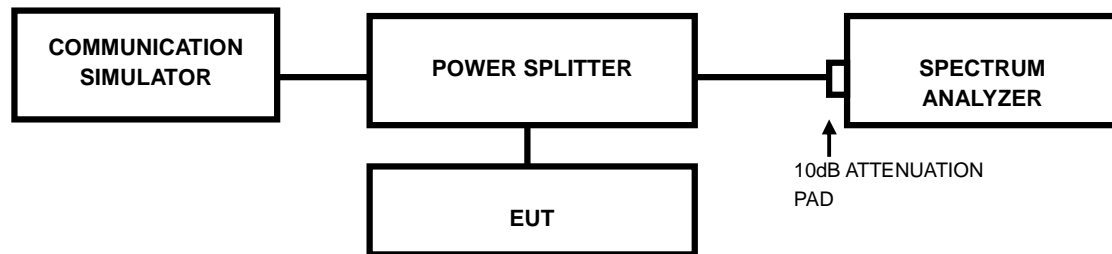



**BUREAU  
VERITAS**

Test Report No.: RF180710W003-3

### 3.3.3 TEST RESULTS

| CHANNEL | Frequency (MHz) | 99% OCCUPIED Bandwidth (kHz) |        | CHANNEL | Frequency (MHz) | 99% OCCUPIED Bandwidth (MHz) |
|---------|-----------------|------------------------------|--------|---------|-----------------|------------------------------|
|         |                 | GSM                          | GPRS   |         |                 | WCDMA                        |
| 128     | 824.2           | 243.00                       | 240.00 | 4132    | 826.4           | 4.17                         |
| 189     | 836.4           | 248.00                       | 243.00 | 4182    | 836.4           | 4.15                         |
| 251     | 848.8           | 247.00                       | 245.00 | 4233    | 846.6           | 4.15                         |

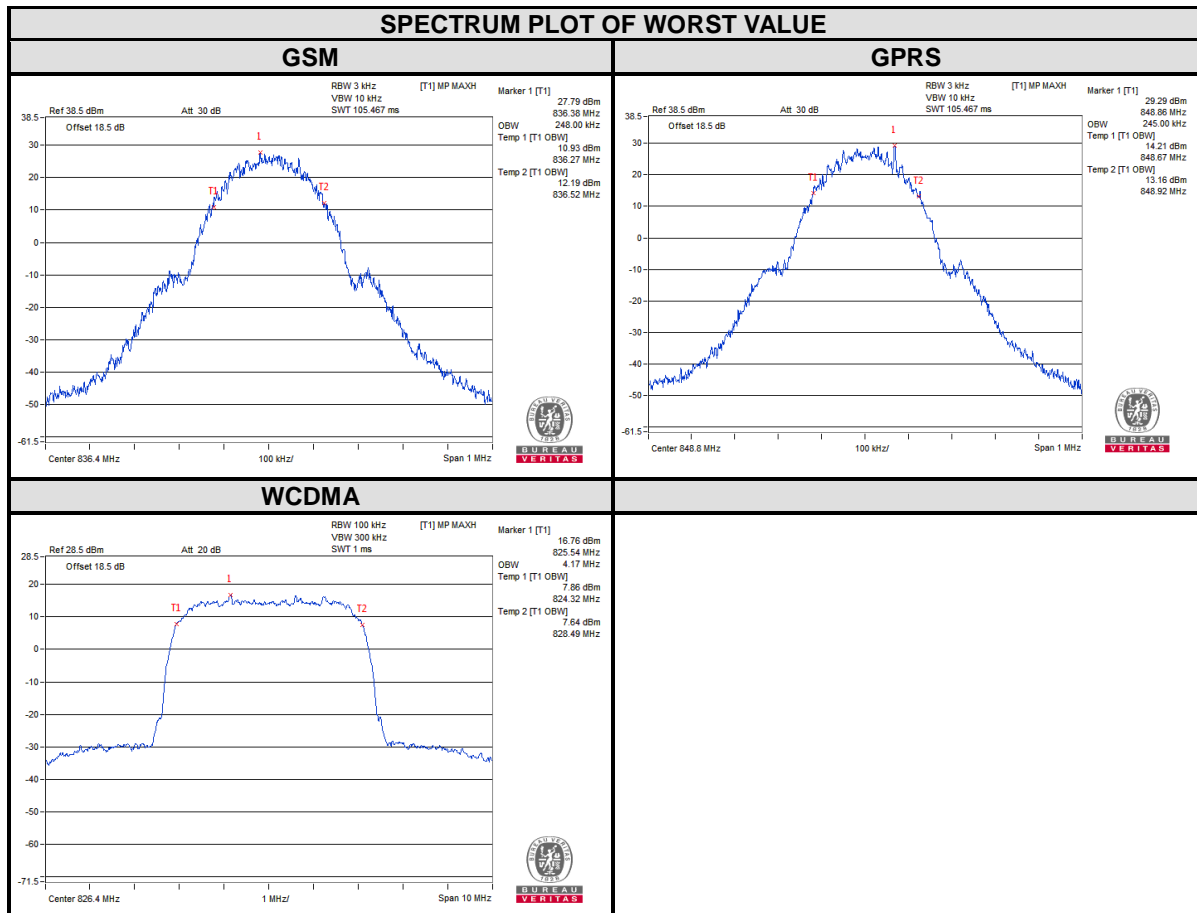



**BUREAU  
VERITAS**

Test Report No.: RF180710W003-3

| CHANNEL | Frequency (MHz) | 26dB Bandwidth (kHz) |        | CHANNEL | Frequency (MHz) | 26dB Bandwidth (MHz) |
|---------|-----------------|----------------------|--------|---------|-----------------|----------------------|
|         |                 | GSM                  | GPRS   |         |                 | WCDMA                |
| 128     | 824.2           | 314.96               | 314.54 | 4132    | 826.4           | 4.68                 |
| 189     | 836.4           | 322.66               | 317.13 | 4182    | 836.4           | 4.67                 |
| 251     | 848.8           | 323.11               | 320.23 | 4233    | 846.6           | 4.68                 |

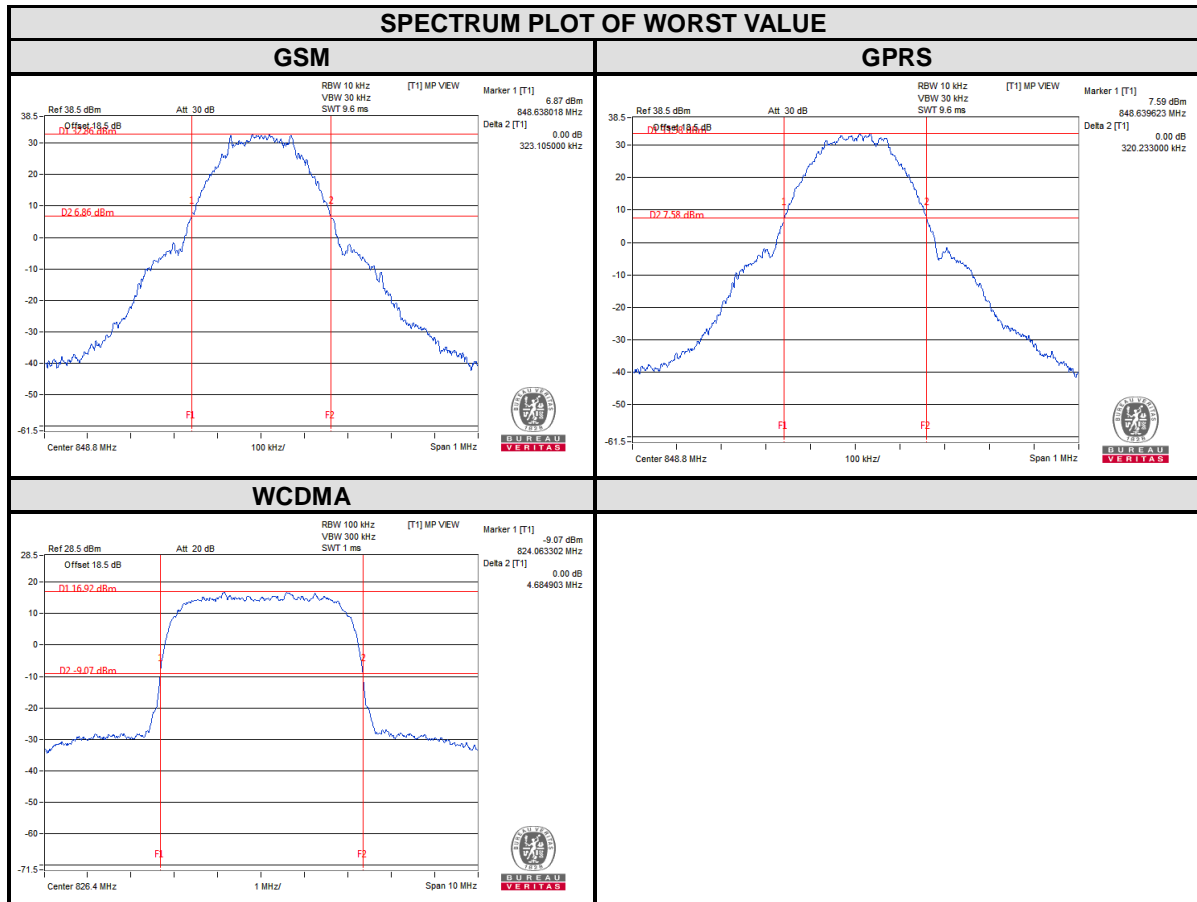

### 3.4 BAND EDGE MEASUREMENT

#### 3.4.1 LIMITS OF BAND EDGE MEASUREMENT

Power of any emission outside of the authorized operating frequency ranges must be attenuated below the transmitting power (P) by a factor of at least  $43 + 10 \log(P)$  dB. In the 1 MHz bands immediately outside and adjacent to the frequency block a resolution bandwidth of at least one percent of the emission bandwidth of the fundamental emission of the transmitter may be employed.

#### 3.4.2 TEST SETUP

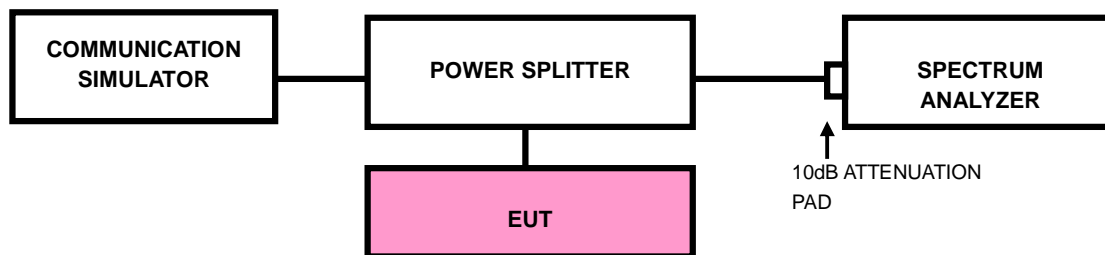

#### 3.4.3 TEST PROCEDURES

- a. All measurements were done at low and high operational frequency range.
- b. The center frequency of spectrum is the band edge frequency and span is 1.5MHz. RBW of the spectrum is 10kHz and VBW of the spectrum is 30kHz (GSM/GPRS).
- c. The center frequency of spectrum is the band edge frequency and span is 10MHz. RBW of the spectrum is 100kHz and VBW of the spectrum is 300kHz (WCDMA).
- d. Record the max trace plot into the test report.





BUREAU VERITAS

Test Report No.: RF180710W003-3

### 3.4.4 TEST RESULTS

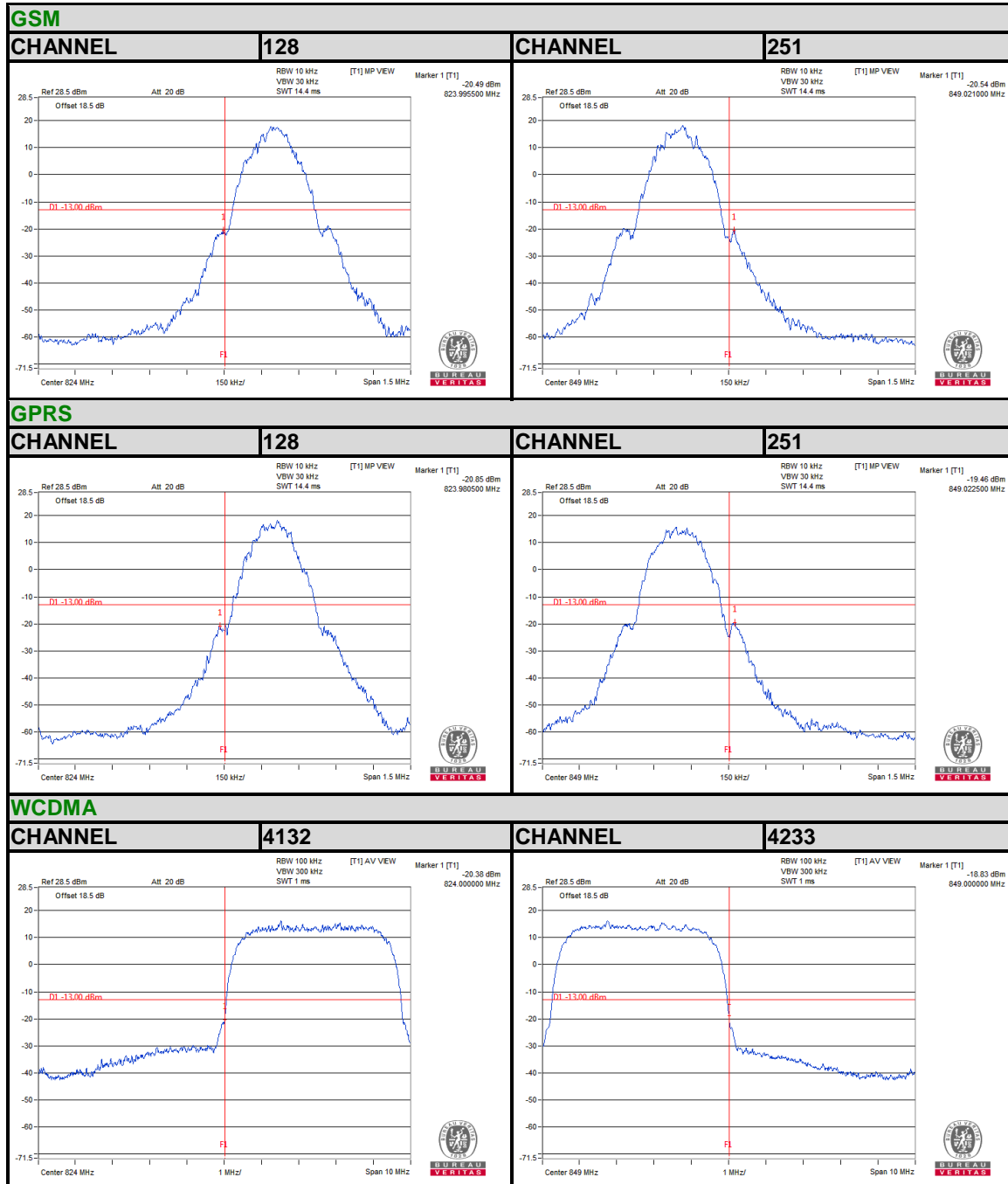

### 3.5 CONDUCTED SPURIOUS EMISSIONS

#### 3.5.1 LIMITS OF CONDUCTED SPURIOUS EMISSIONS MEASUREMENT

The power of any emission outside of the authorized operating frequency ranges must be attenuated below the transmitting power (P) by a factor of at least  $43 + 10 \log(P)$  dB. The emission limit equal to  $-13\text{dBm}$ .

#### 3.5.2 TEST PROCEDURE

- a. The EUT makes a phone call to the communication simulator. All measurements were done at low, middle and high operational frequency range.
- b. Measuring frequency range is from 9 kHz to 9GHz. 10dB attenuation pad is connected with spectrum. RBW=1MHz and VBW=3MHz is used for conducted emission measurement.

#### 3.5.3 TEST SETUP

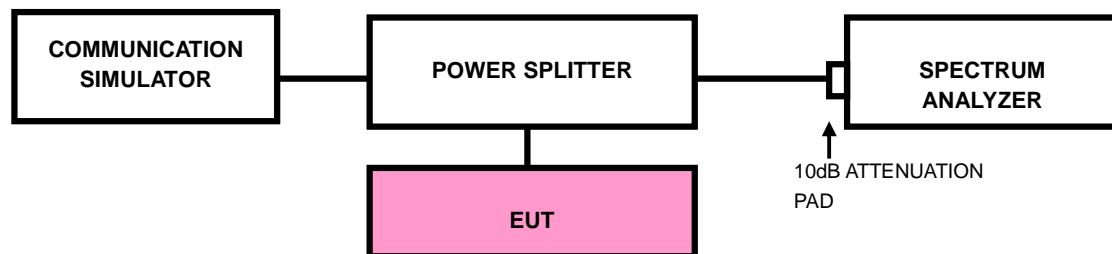



BUREAU VERITAS

Test Report No.: RF180710W003-3

### 3.5.4 TEST RESULTS

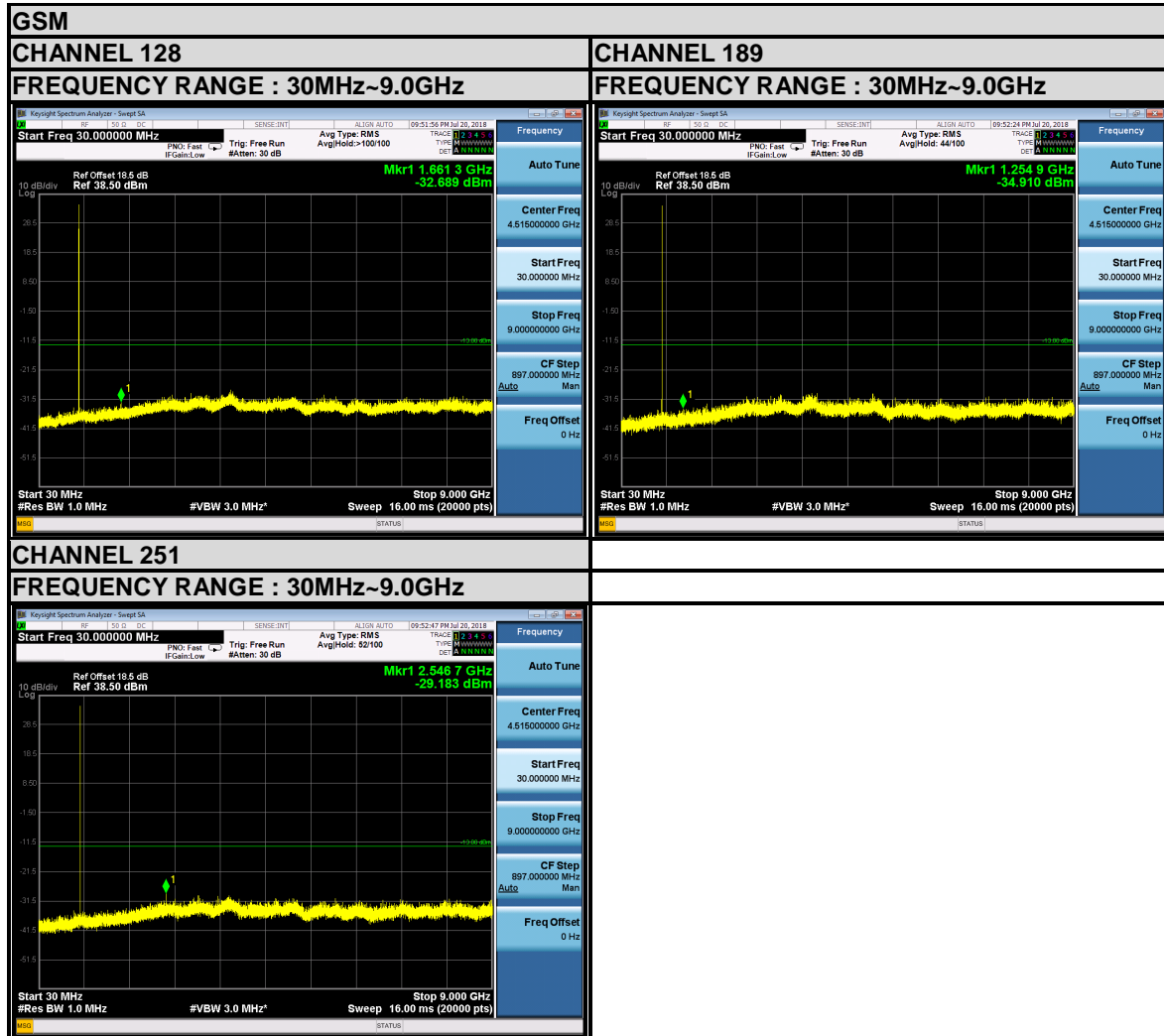



BUREAU VERITAS

Test Report No.: RF180710W003-3

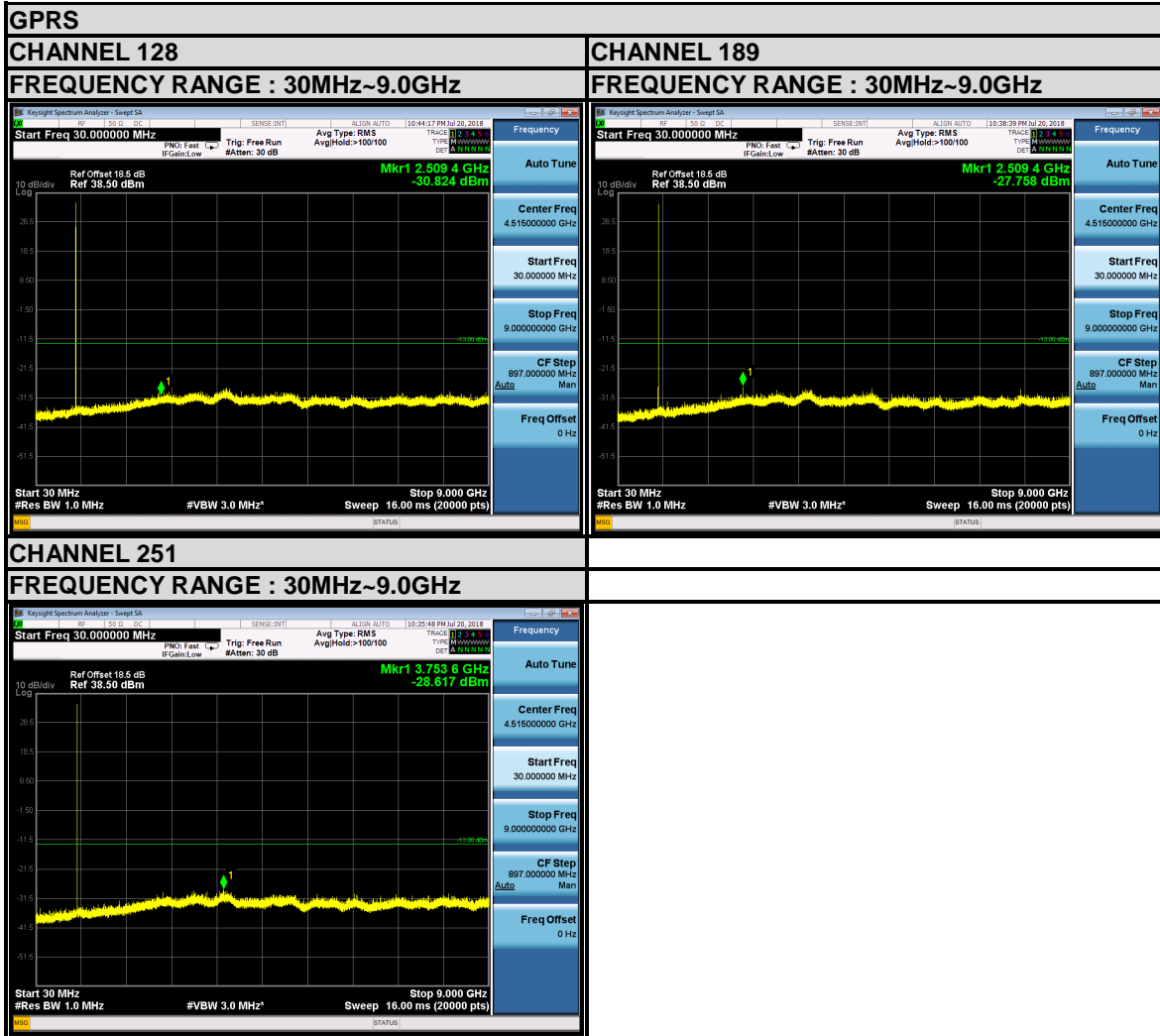



BUREAU VERITAS

Test Report No.: RF180710W003-3

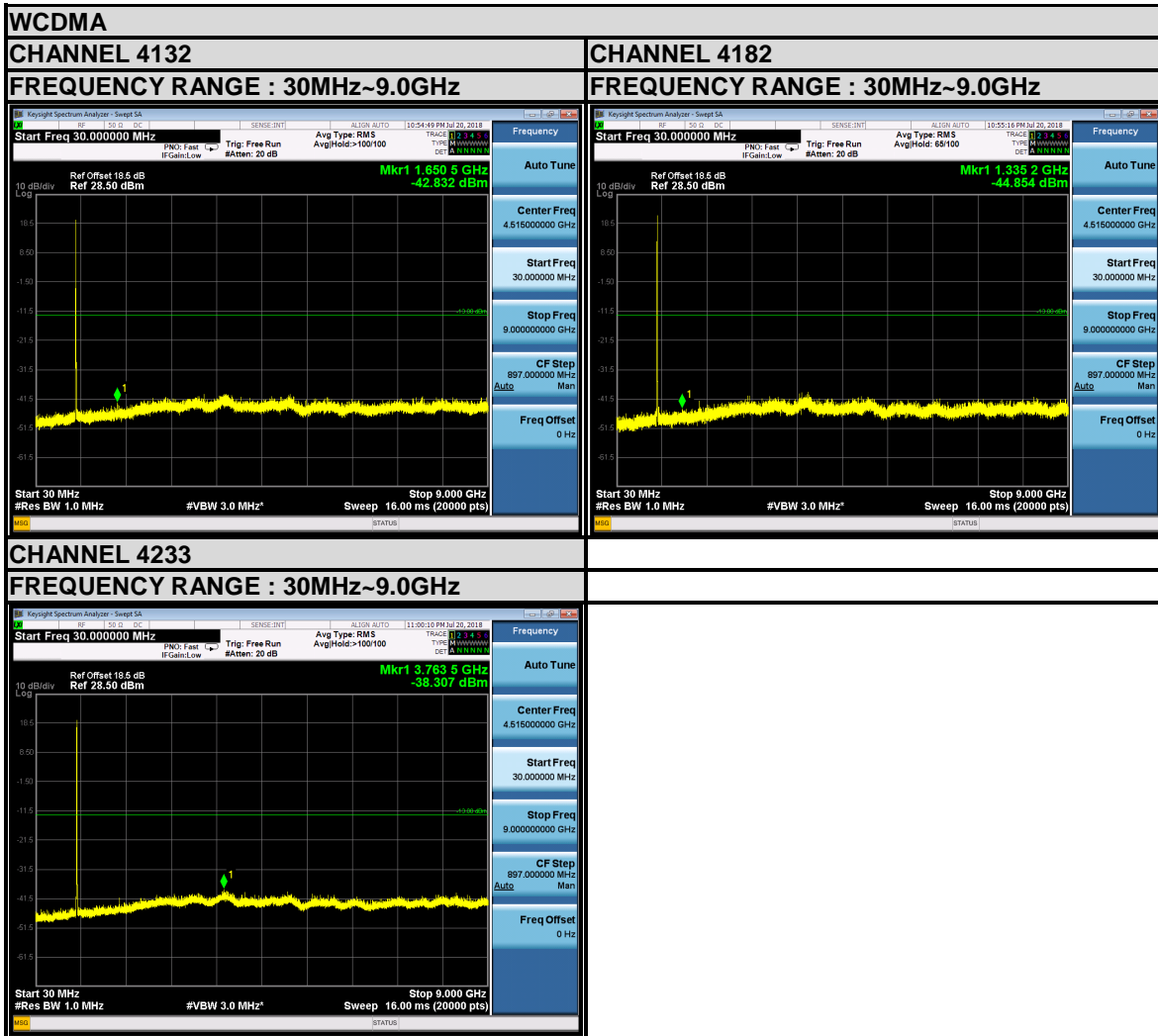

### 3.6 RADIATED EMISSION MEASUREMENT

#### 3.6.1 LIMITS OF RADIATED EMISSION MEASUREMENT

The power of any emission outside of the authorized operating frequency ranges must be attenuated below the transmitting power (P) by a factor of at least  $43 + 10 \log(P)$  dB. The emission limit equal to  $-13\text{dBm}$ .

#### 3.6.2 TEST PROCEDURES

- a. Substitution method is used for E.I.R.P measurement. In the semi-anechoic chamber, EUT placed on the 0.8m height of Turn Table, rotated the table around 360 degrees to search the maximum radiation power and receiver antenna shall be rotated vertical and horizontal polarization and moved height from 1m to 4m to find the maximum polar radiated power. The “Read Value” is the spectrum reading the maximum power value.
- b. The substitution horn antenna is substituted for EUT at the same position and signals generator export the CW signal to the substitution antenna via a TX cable. Rotated the Turn Table and moved receiving antenna to find the maximum radiation power. Adjust output power level of S.G to get a Value of spectrum reading equal to “Read Value” of step a. Record the power level of S.G
- c.  $\text{EIRP} = \text{Output power level of S.G} - \text{TX cable loss} + \text{Antenna gain of substitution horn}$ .
- d. E.R.P power can be calculated form E.I.R.P power by subtracting the gain of dipole,  
 $\text{E.R.P power} = \text{E.I.P.R power} - 2.15\text{dBi}$ .

**NOTE:** The resolution bandwidth and video bandwidth of test receiver/spectrum analyzer is 1MHz/3MHz.

#### 3.6.3 DEVIATION FROM TEST STANDARD

No deviation

### 3.6.4 TEST SETUP

#### <Below 30MHz>

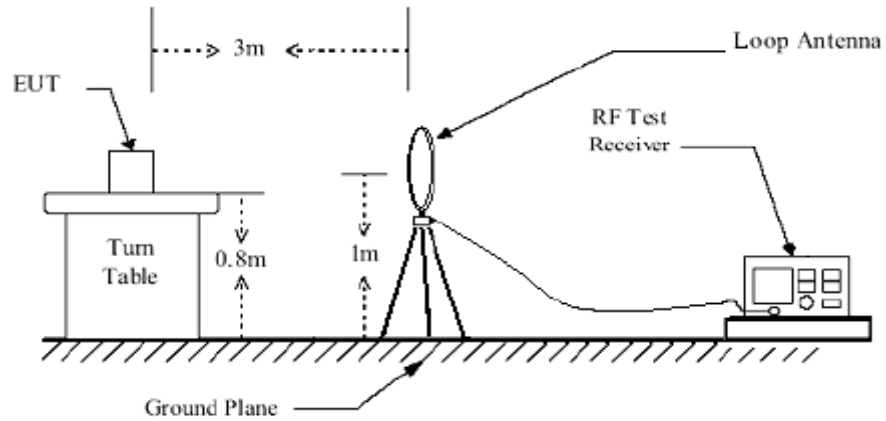

#### < Frequency Range 30MHz~1GHz >

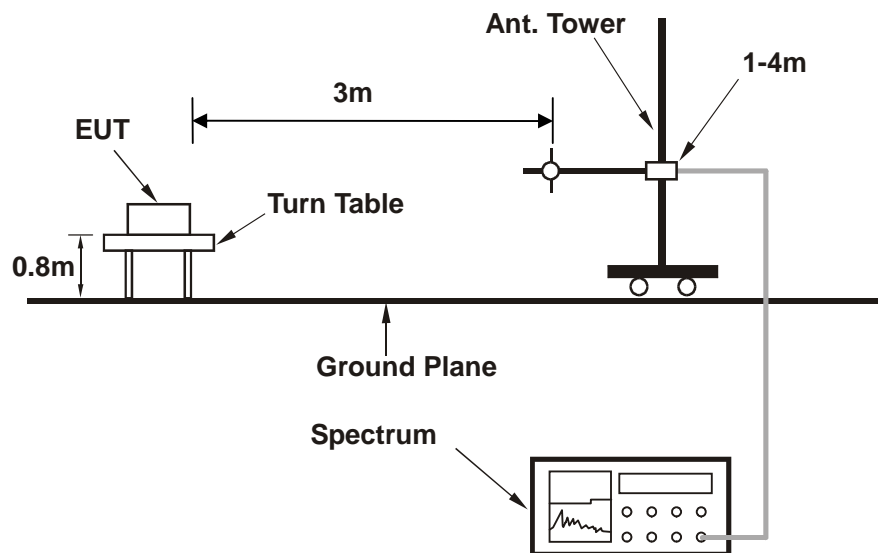

< Frequency Range above 1GHz >

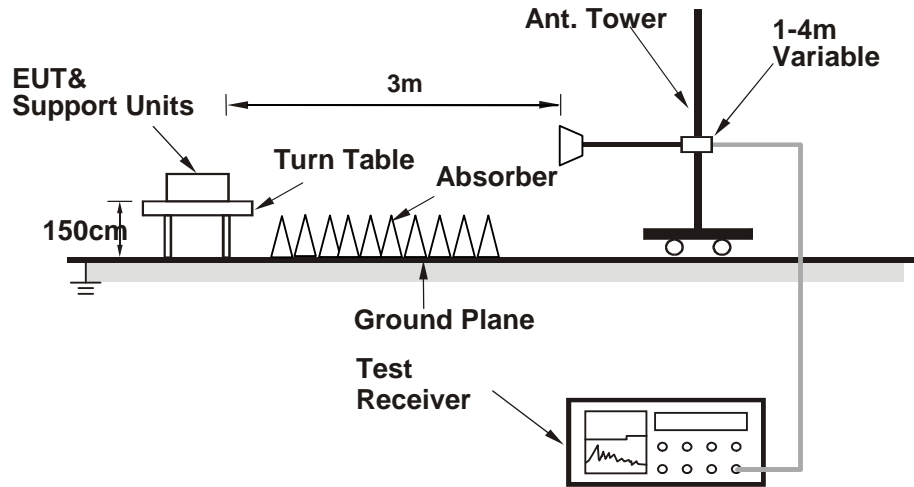

For the actual test configuration, please refer to the attached file (Test Setup Photo).





### 3.6.5 TEST RESULTS

#### BELOW 1GHz WORST-CASE DATA

**9 KHz – 30 MHz data:** the amplitude of spurious emissions attenuated more than 20 dB below the permissible value is not required in the report.

**30 MHz – 1GHz data:**

**GSM 850:**

|  |                 |                        |                    |
|--|-----------------|------------------------|--------------------|
| <b>MODE</b>  | TX channel 189  | <b>FREQUENCY RANGE</b> | Below 1000MHz      |
| <b>ENVIRONMENTAL CONDITIONS</b>                                | 23deg. C, 70%RH | <b>INPUT POWER</b>     | DC 5V from adapter |
| <b>TESTED BY</b>   | Rose Ma         |                        |                    |
| <b>ANTENNA POLARITY &amp; TEST DISTANCE: HORIZONTAL AT 3 M</b> |                 |                        |                    |

|      | Freq    | Read Level | Limit Level | Over Limit | Factor | Remark     | Pol/Phase  |
|------|---------|------------|-------------|------------|--------|------------|------------|
|      | MHz     | dBm/m      | dBm         | dBm/m      | dB     | dB/m       |            |
| 1    | 40.410  | -43.21     | -55.83      | -13.00     | -30.21 | 12.62 Peak | Horizontal |
| 2    | 81.520  | -47.24     | -40.60      | -13.00     | -34.24 | -6.64 Peak | Horizontal |
| 3    | 385.560 | -42.95     | -34.57      | -13.00     | -29.95 | -8.38 Peak | Horizontal |
| 4    | 450.740 | -49.21     | -41.60      | -13.00     | -36.21 | -7.61 Peak | Horizontal |
| 5    | 640.250 | -44.23     | -40.18      | -13.00     | -31.23 | -4.05 Peak | Horizontal |
| 6 PP | 720.230 | -36.66     | -35.17      | -13.00     | -23.66 | -1.49 Peak | Horizontal |

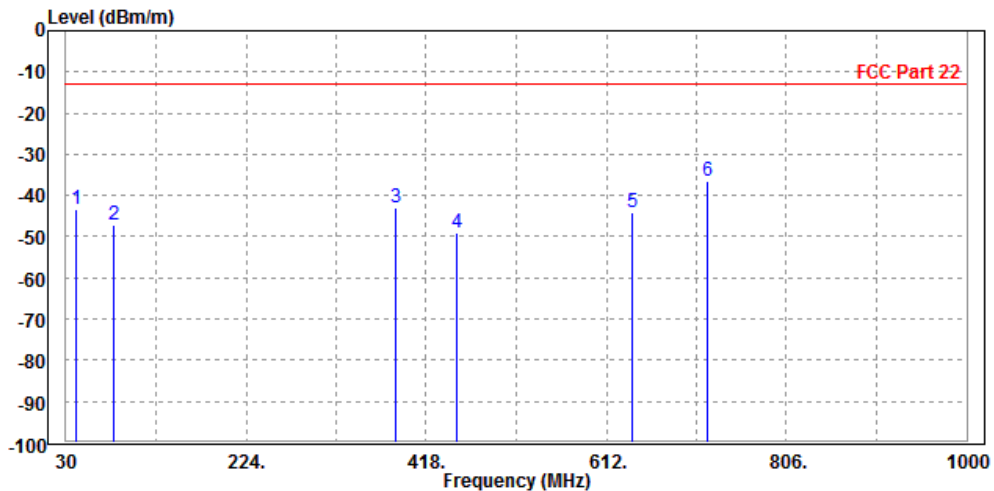

|  |                 |                 |                    |
|--|-----------------|-----------------|--------------------|
| MODE   | TX channel 189  | FREQUENCY RANGE | Below 1000MHz      |
| ENVIRONMENTAL CONDITIONS                                     | 23deg. C, 70%RH | INPUT POWER     | DC 5V from adapter |
| TESTED BY  | Rose Ma         |                 |                    |
| <b>ANTENNA POLARITY &amp; TEST DISTANCE: VERTICAL AT 3 M</b> |                 |                 |                    |

|      | Freq    | Level  | Read Level | Limit  | Over Limit | Factor | Remark | Pol/Phase |
|------|---------|--------|------------|--------|------------|--------|--------|-----------|
|      | MHz     | dBm/m  | dBm        | dBm/m  | dB         | dB/m   |        |           |
| 1    | 32.360  | -50.27 | -53.27     | -13.00 | -37.27     | 3.00   | Peak   | Vertical  |
| 2    | 95.210  | -57.78 | -48.47     | -13.00 | -44.78     | -9.31  | Peak   | Vertical  |
| 3 PP | 203.630 | -48.91 | -40.02     | -13.00 | -35.91     | -8.89  | Peak   | Vertical  |
| 4    | 478.140 | -53.88 | -48.74     | -13.00 | -40.88     | -5.14  | Peak   | Vertical  |
| 5    | 511.120 | -51.85 | -47.60     | -13.00 | -38.85     | -4.25  | Peak   | Vertical  |
| 6    | 690.570 | -53.52 | -50.69     | -13.00 | -40.52     | -2.83  | Peak   | Vertical  |

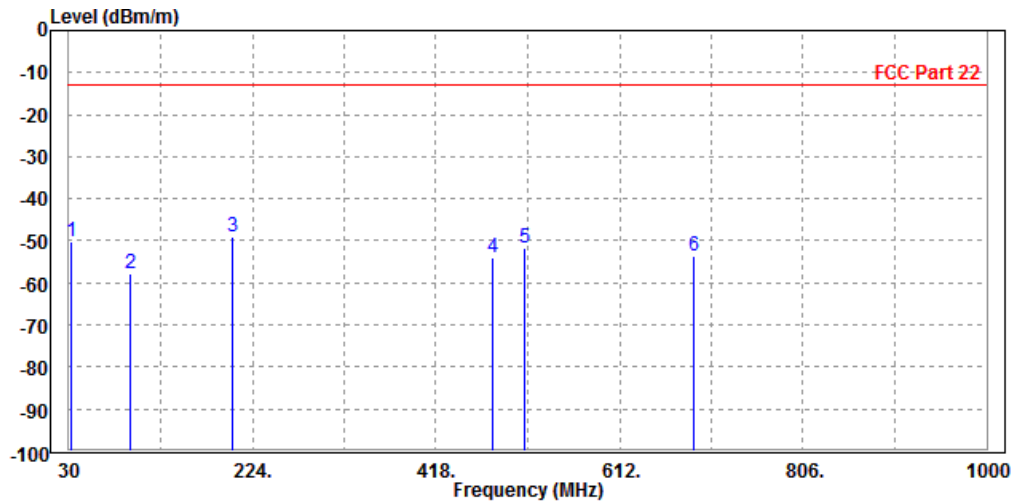



**BUREAU  
VERITAS**

**Test Report No.: RF180710W003-3**

**ABOVE 1GHz DATA**

**Note:** For higher frequency, the emission is too low to be detected.

**GSM 850**

**CH 128:**

|  |                 |                        |                    |
|--|-----------------|------------------------|--------------------|
| <b>MODE</b>  | TX channel 128  | <b>FREQUENCY RANGE</b> | Above 1000MHz      |
| <b>ENVIRONMENTAL CONDITIONS</b>                                | 23deg. C, 70%RH | <b>INPUT POWER</b>     | DC 5V from adapter |
| <b>TESTED BY</b>   | Rose Ma         |                        |                    |
| <b>ANTENNA POLARITY &amp; TEST DISTANCE: HORIZONTAL AT 3 M</b> |                 |                        |                    |

|      | Freq     | Level  | Read Level | Limit Line | Over Limit | Factor | Remark | Pol/Phase  |
|------|----------|--------|------------|------------|------------|--------|--------|------------|
|      | MHz      | dBm/m  | dBm        | dBm/m      | dB         | dB/m   |        |            |
| 1    | 1648.000 | -60.43 | -55.46     | -13.00     | -47.43     | -4.97  | Peak   | Horizontal |
| 2 PP | 2476.000 | -57.72 | -56.07     | -13.00     | -44.72     | -1.65  | Peak   | Horizontal |

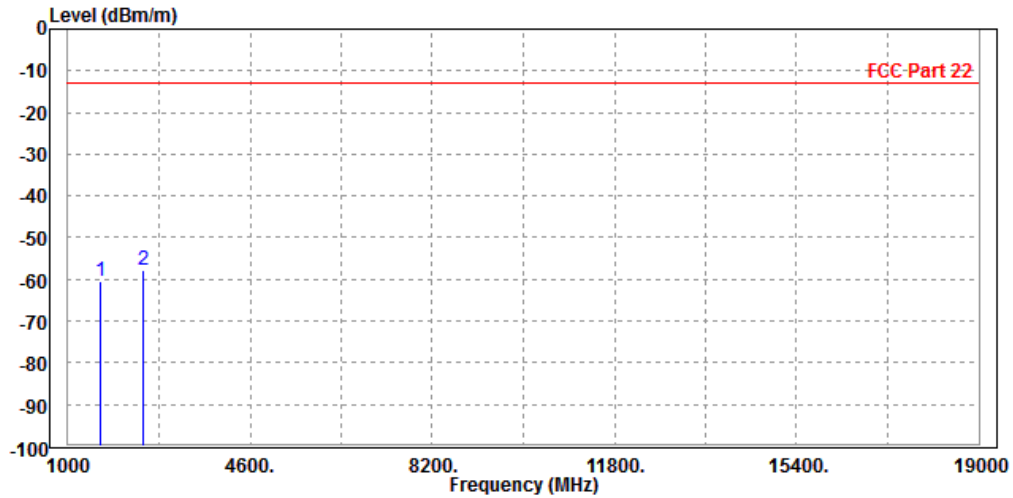



BUREAU VERITAS

Test Report No.: RF180710W003-3

|  |                 |                 |                    |
|--|-----------------|-----------------|--------------------|
| MODE   | TX channel 128  | FREQUENCY RANGE | Above 1000MHz      |
| ENVIRONMENTAL CONDITIONS                                     | 23deg. C, 70%RH | INPUT POWER     | DC 5V from adapter |
| TESTED BY  | Rose Ma         |                 |                    |
| <b>ANTENNA POLARITY &amp; TEST DISTANCE: VERTICAL AT 3 M</b> |                 |                 |                    |

|   | Freq        | Level  | Read Level | Limit Line | Over Limit | Factor | Remark | Pol/Phase |
|---|-------------|--------|------------|------------|------------|--------|--------|-----------|
|   | MHz         | dBm/m  | dBm        | dBm/m      | dB         | dB/m   |        |           |
| 1 | 1648.000    | -59.37 | -55.82     | -13.00     | -46.37     | -3.55  | Peak   | Vertical  |
| 2 | PP 2476.000 | -56.47 | -56.30     | -13.00     | -43.47     | -0.17  | Peak   | Vertical  |

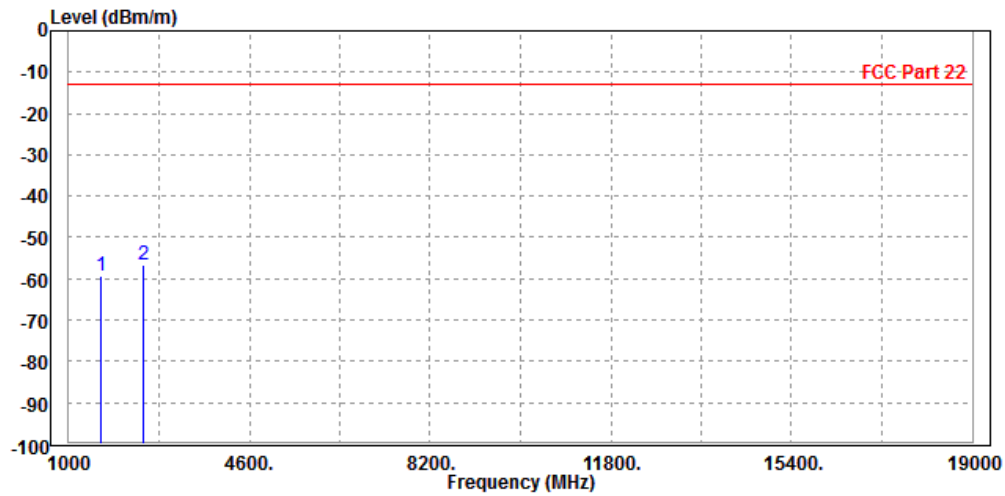



BUREAU VERITAS

Test Report No.: RF180710W003-3

CH 189:

|   |                 |                 |                    |
|---|-----------------|-----------------|--------------------|
| MODE  | TX channel 189  | FREQUENCY RANGE | Above 1000MHz      |
| ENVIRONMENTAL CONDITIONS                            | 23deg. C, 70%RH | INPUT POWER     | DC 5V from adapter |
| TESTED BY   | Rose Ma         |                 |                    |
| ANTENNA POLARITY & TEST DISTANCE: HORIZONTAL AT 3 M |                 |                 |                    |

|   | Freq        | Level  | Read Level | Limit Line | Over Limit | Factor | Remark | Pol/Phase  |
|---|-------------|--------|------------|------------|------------|--------|--------|------------|
|   | MHz         | dBm/m  | dBm        | dBm/m      | dB         | dB/m   |        |            |
| 1 | PP 1666.000 | -39.48 | -34.66     | -13.00     | -26.48     | -4.82  | Peak   | Horizontal |
| 2 | 2509.200    | -51.27 | -49.67     | -13.00     | -38.27     | -1.60  | Peak   | Horizontal |

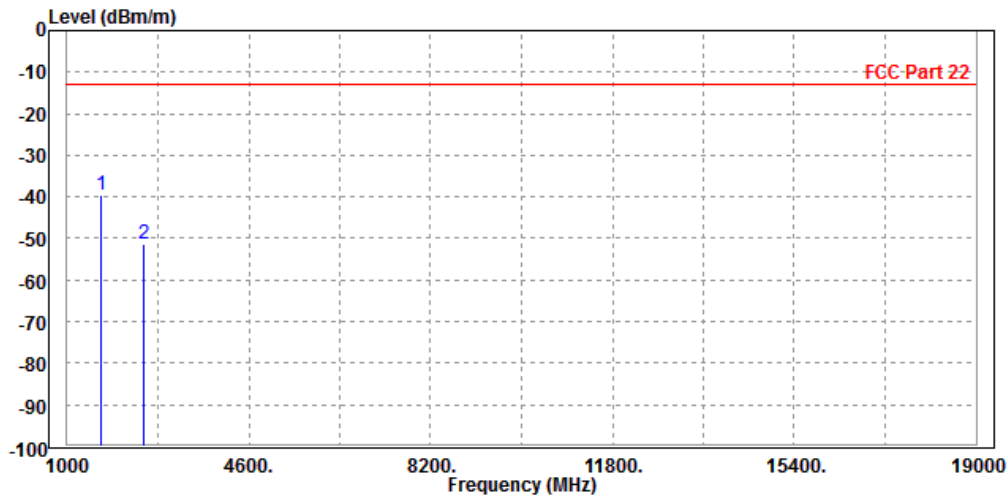



Test Report No.: RF180710W003-3

|  |                 |                        |                    |
|--|-----------------|------------------------|--------------------|
| <b>MODE</b>  | TX channel 189  | <b>FREQUENCY RANGE</b> | Above 1000MHz      |
| <b>ENVIRONMENTAL CONDITIONS</b>                              | 23deg. C, 70%RH | <b>INPUT POWER</b>     | DC 5V from adapter |
| <b>TESTED BY</b>   | Rose Ma         |                        |                    |
| <b>ANTENNA POLARITY &amp; TEST DISTANCE: VERTICAL AT 3 M</b> |                 |                        |                    |

|   | Freq        | Level  | Read Level | Limit Line | Over Limit | Factor | Remark | Pol/Phase |
|---|-------------|--------|------------|------------|------------|--------|--------|-----------|
|   | MHz         | dBm/m  | dBm        | dBm/m      | dB         | dB/m   |        |           |
| 1 | PP 1666.000 | -33.32 | -29.94     | -13.00     | -20.32     | -3.38  | Peak   | Vertical  |
| 2 | 2509.200    | -40.54 | -40.41     | -13.00     | -27.54     | -0.13  | Peak   | Vertical  |

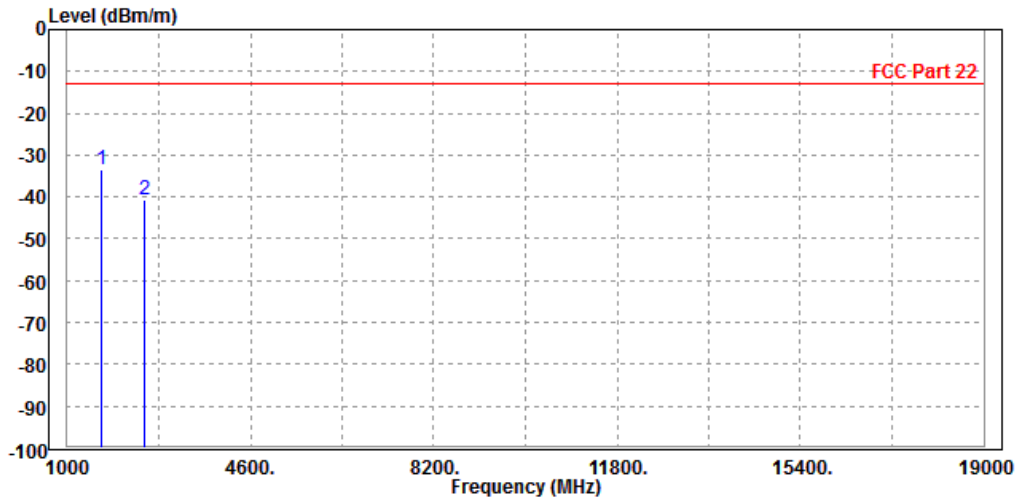



BUREAU VERITAS

Test Report No.: RF180710W003-3

CH 251:

|  |                 |                 |                    |
|--|-----------------|-----------------|--------------------|
| MODE   | TX channel 251  | FREQUENCY RANGE | Above 1000MHz      |
| ENVIRONMENTAL CONDITIONS                                       | 23deg. C, 70%RH | INPUT POWER     | DC 5V from adapter |
| TESTED BY  | Rose Ma         |                 |                    |
| <b>ANTENNA POLARITY &amp; TEST DISTANCE: HORIZONTAL AT 3 M</b> |                 |                 |                    |

|   | Freq        | Level  | Read Level | Limit  | Over Limit | Factor | Remark | Pol/Phase  |
|---|-------------|--------|------------|--------|------------|--------|--------|------------|
|   | MHz         | dBm/m  | dBm        | dBm/m  | dB         | dB/m   |        |            |
| 1 | PP 1702.000 | -40.79 | -36.27     | -13.00 | -27.79     | -4.52  | Peak   | Horizontal |
| 2 | 2548.000    | -49.44 | -47.99     | -13.00 | -36.44     | -1.45  | Peak   | Horizontal |

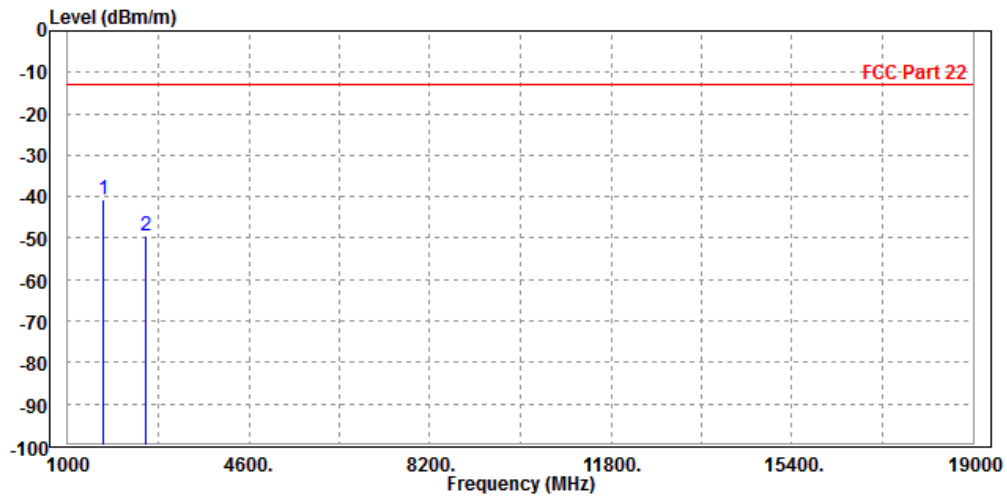



BUREAU VERITAS

Test Report No.: RF180710W003-3

|  |                 |                 |                    |
|--|-----------------|-----------------|--------------------|
| MODE   | TX channel 251  | FREQUENCY RANGE | Above 1000MHz      |
| ENVIRONMENTAL CONDITIONS                                     | 23deg. C, 70%RH | INPUT POWER     | DC 5V from adapter |
| TESTED BY  | Rose Ma         |                 |                    |
| <b>ANTENNA POLARITY &amp; TEST DISTANCE: VERTICAL AT 3 M</b> |                 |                 |                    |

|               | Read   | Limit  | Over   |        |        |               |
|---------------|--------|--------|--------|--------|--------|---------------|
| Freq          | Level  | Level  | Line   | Limit  | Factor | Remark        |
| MHz           | dBm/m  | dBm    | dBm/m  | dB     | dB/m   | Pol/Phase     |
| 1 PP 1702.000 | -36.78 | -33.73 | -13.00 | -23.78 | -3.05  | Peak Vertical |
| 2 2548.000    | -45.28 | -45.31 | -13.00 | -32.28 | 0.03   | Peak Vertical |

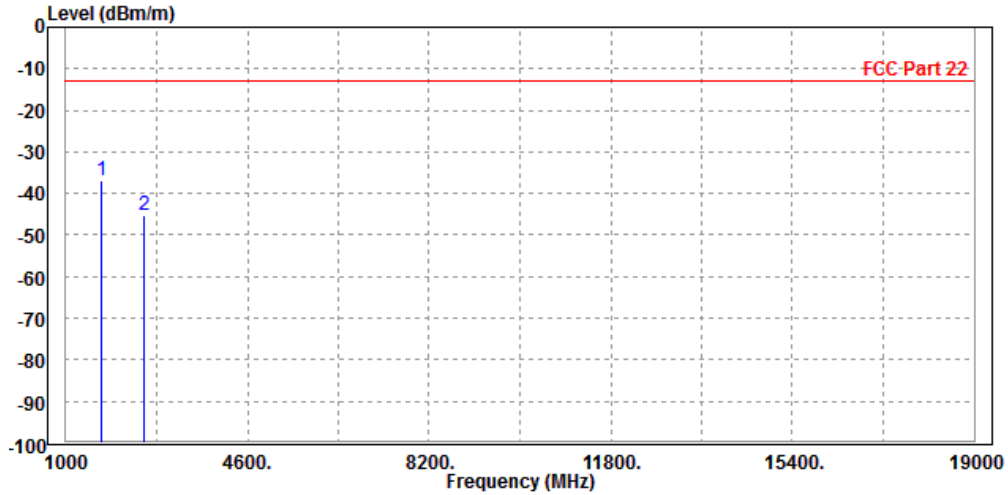





**BUREAU  
VERITAS**

**Test Report No.: RF180710W003-3**

**GPRS 850:**

**CH 128:**

|  |                 |                        |                    |
|--|-----------------|------------------------|--------------------|
| <b>MODE</b>  | TX channel 128  | <b>FREQUENCY RANGE</b> | Above 1000MHz      |
| <b>ENVIRONMENTAL CONDITIONS</b>                                | 23deg. C, 70%RH | <b>INPUT POWER</b>     | DC 5V from adapter |
| <b>TESTED BY</b>   | Rose Ma         |                        |                    |
| <b>ANTENNA POLARITY &amp; TEST DISTANCE: HORIZONTAL AT 3 M</b> |                 |                        |                    |

|   | Freq        | Level  | Read Level | Limit Line | Over Limit | Factor | Remark | Pol/Phase  |
|---|-------------|--------|------------|------------|------------|--------|--------|------------|
|   | MHz         | dBm/m  | dBm        | dBm/m      | dB         | dB/m   |        |            |
| 1 | PP 1648.000 | -39.65 | -34.68     | -13.00     | -26.65     | -4.97  | Peak   | Horizontal |
| 2 | 2476.000    | -48.41 | -46.76     | -13.00     | -35.41     | -1.65  | Peak   | Horizontal |

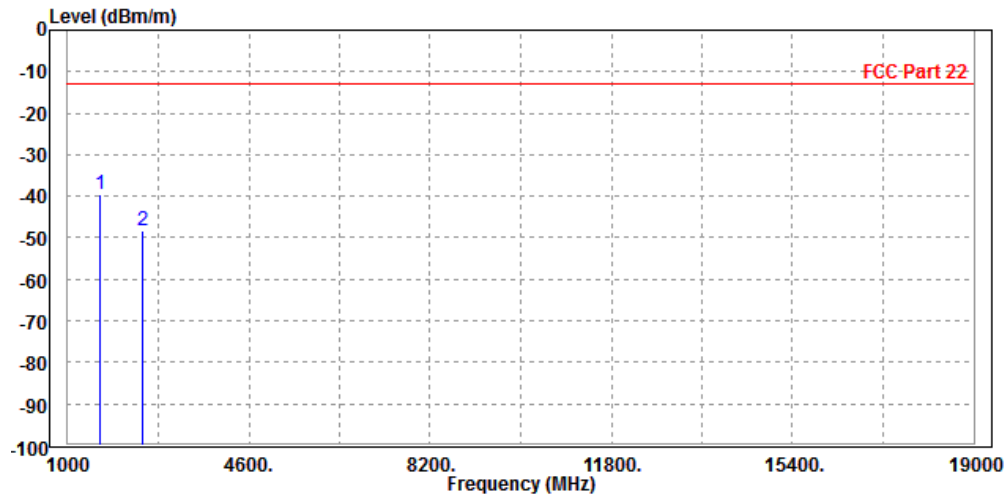



**BUREAU  
VERITAS**

Test Report No.: RF180710W003-3

|  |                 |                        |                    |
|--|-----------------|------------------------|--------------------|
| <b>MODE</b>  | TX channel 128  | <b>FREQUENCY RANGE</b> | Above 1000MHz      |
| <b>ENVIRONMENTAL CONDITIONS</b>                              | 23deg. C, 70%RH | <b>INPUT POWER</b>     | DC 5V from adapter |
| <b>TESTED BY</b>   | Rose Ma         |                        |                    |
| <b>ANTENNA POLARITY &amp; TEST DISTANCE: VERTICAL AT 3 M</b> |                 |                        |                    |

|   | Freq        | Level  | Read Level | Limit Line | Over Limit | Factor | Remark | Pol/Phase |
|---|-------------|--------|------------|------------|------------|--------|--------|-----------|
|   | MHz         | dBm/m  | dBm        | dBm/m      | dB         | dB/m   |        |           |
| 1 | PP 1648.000 | -33.57 | -30.02     | -13.00     | -20.57     | -3.55  | Peak   | Vertical  |
| 2 | 2476.000    | -41.49 | -41.32     | -13.00     | -28.49     | -0.17  | Peak   | Vertical  |

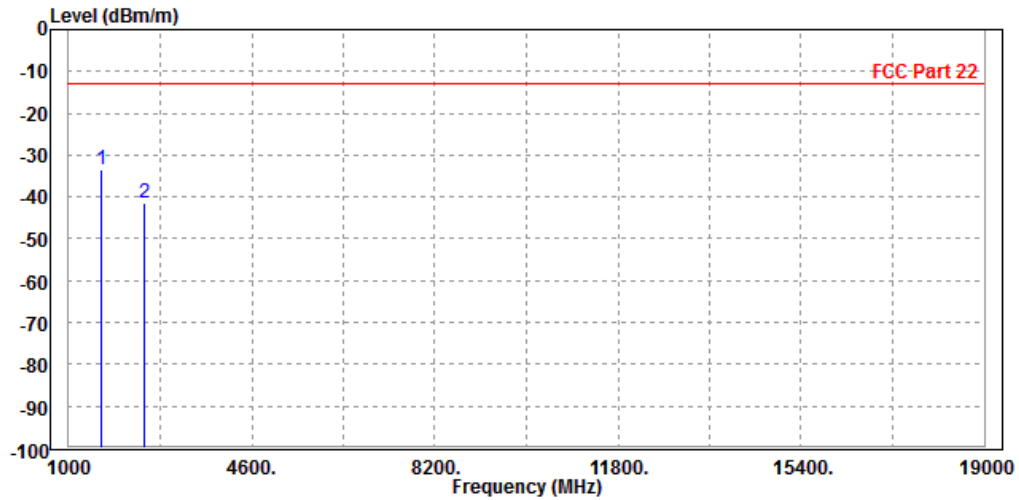



BUREAU VERITAS

Test Report No.: RF180710W003-3

CH 189:

|   |                 |                 |                    |
|---|-----------------|-----------------|--------------------|
| MODE  | TX channel 189  | FREQUENCY RANGE | Above 1000MHz      |
| ENVIRONMENTAL CONDITIONS                            | 23deg. C, 70%RH | INPUT POWER     | DC 5V from adapter |
| TESTED BY   | Rose Ma         |                 |                    |
| ANTENNA POLARITY & TEST DISTANCE: HORIZONTAL AT 3 M |                 |                 |                    |

|   | Freq        | Level  | Read Level | Limit Line | Over Limit | Factor | Remark | Pol/Phase  |
|---|-------------|--------|------------|------------|------------|--------|--------|------------|
|   | MHz         | dBm/m  | dBm        | dBm/m      | dB         | dB/m   |        |            |
| 1 | PP 1666.000 | -38.59 | -33.77     | -13.00     | -25.59     | -4.82  | Peak   | Horizontal |
| 2 | 2512.000    | -52.60 | -51.01     | -13.00     | -39.60     | -1.59  | Peak   | Horizontal |

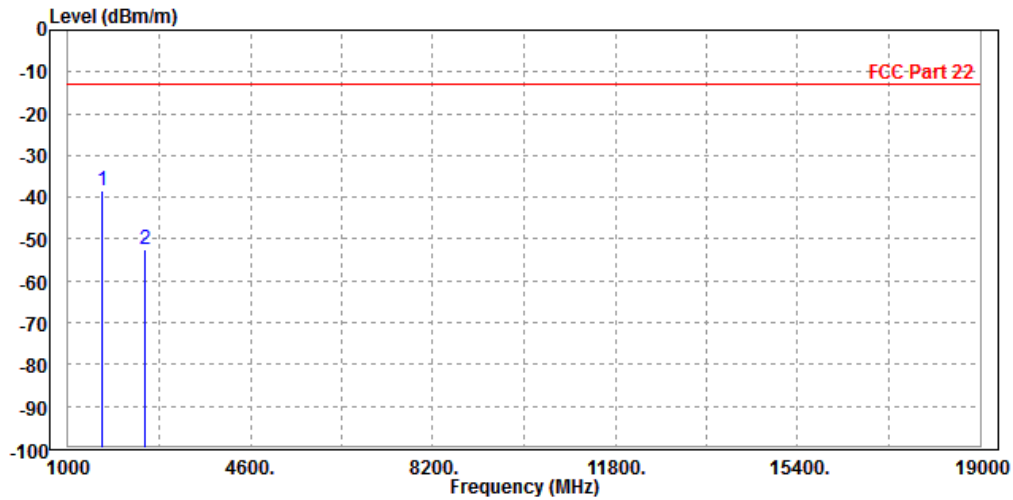



**BUREAU  
VERITAS**

**Test Report No.: RF180710W003-3**

|  |                 |                        |                    |
|--|-----------------|------------------------|--------------------|
| <b>MODE</b>  | TX channel 189  | <b>FREQUENCY RANGE</b> | Above 1000MHz      |
| <b>ENVIRONMENTAL CONDITIONS</b>                              | 23deg. C, 70%RH | <b>INPUT POWER</b>     | DC 5V from adapter |
| <b>TESTED BY</b>   | Rose Ma         |                        |                    |
| <b>ANTENNA POLARITY &amp; TEST DISTANCE: VERTICAL AT 3 M</b> |                 |                        |                    |

|   | Freq        | Level  | Read Level | Limit Line | Over Limit | Factor | Remark | Pol/Phase |
|---|-------------|--------|------------|------------|------------|--------|--------|-----------|
|   | MHz         | dBm/m  | dBm        | dBm/m      | dB         | dB/m   |        |           |
| 1 | PP 1666.000 | -41.79 | -38.41     | -13.00     | -28.79     | -3.38  | Peak   | Vertical  |
| 2 | 2509.200    | -44.39 | -44.26     | -13.00     | -31.39     | -0.13  | Peak   | Vertical  |

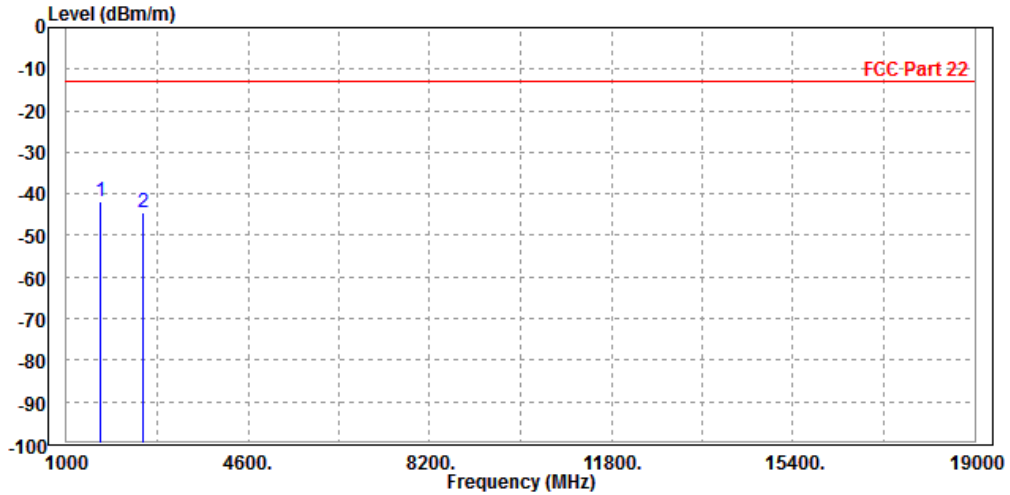



**BUREAU  
VERITAS**

Test Report No.: RF180710W003-3

CH 251:

|  |                 |                        |                    |
|--|-----------------|------------------------|--------------------|
| <b>MODE</b>  | TX channel 251  | <b>FREQUENCY RANGE</b> | Above 1000MHz      |
| <b>ENVIRONMENTAL CONDITIONS</b>                                | 23deg. C, 70%RH | <b>INPUT POWER</b>     | DC 5V from adapter |
| <b>TESTED BY</b>   | Rose Ma         |                        |                    |
| <b>ANTENNA POLARITY &amp; TEST DISTANCE: HORIZONTAL AT 3 M</b> |                 |                        |                    |

|   | Freq        | Level  | Read Level | Limit Line | Over Limit | Factor | Remark | Pol/Phase  |
|---|-------------|--------|------------|------------|------------|--------|--------|------------|
|   | MHz         | dBm/m  | dBm        | dBm/m      | dB         | dB/m   |        |            |
| 1 | PP 1702.000 | -37.27 | -32.75     | -13.00     | -24.27     | -4.52  | Peak   | Horizontal |
| 2 | 2548.000    | -50.54 | -49.09     | -13.00     | -37.54     | -1.45  | Peak   | Horizontal |

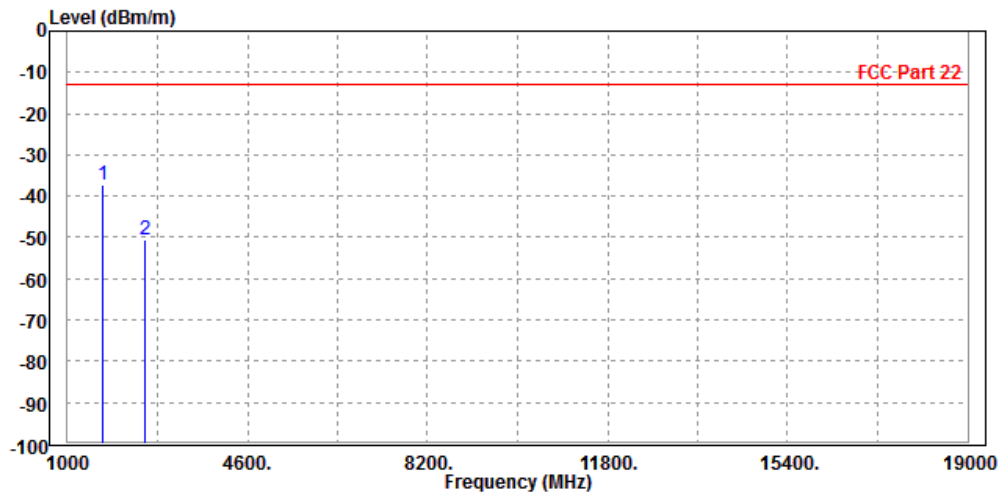



**BUREAU  
VERITAS**

**Test Report No.: RF180710W003-3**

|  |                 |                        |                    |
|--|-----------------|------------------------|--------------------|
| <b>MODE</b>  | TX channel 251  | <b>FREQUENCY RANGE</b> | Above 1000MHz      |
| <b>ENVIRONMENTAL CONDITIONS</b>                              | 23deg. C, 70%RH | <b>INPUT POWER</b>     | DC 5V from adapter |
| <b>TESTED BY</b>   | Rose Ma         |                        |                    |
| <b>ANTENNA POLARITY &amp; TEST DISTANCE: VERTICAL AT 3 M</b> |                 |                        |                    |

|   | Freq        | Level  | Read Level | Limit Line | Over Limit | Factor | Remark | Pol/Phase |
|---|-------------|--------|------------|------------|------------|--------|--------|-----------|
|   | MHz         | dBm/m  | dBm        | dBm/m      | dB         | dB/m   |        |           |
| 1 | PP 1702.000 | -37.75 | -34.70     | -13.00     | -24.75     | -3.05  | Peak   | Vertical  |
| 2 | 2548.000    | -44.45 | -44.48     | -13.00     | -31.45     | 0.03   | Peak   | Vertical  |

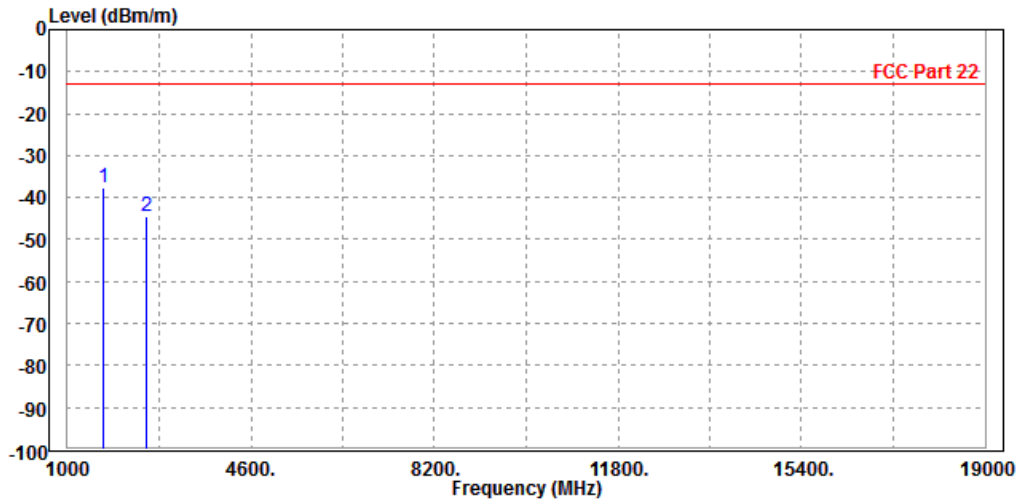



**BUREAU  
VERITAS**

Test Report No.: RF180710W003-3

WCDMA Band V:

CH 4132:

|  |                 |                        |                    |
|--|-----------------|------------------------|--------------------|
| <b>MODE</b>  | TX channel 4132 | <b>FREQUENCY RANGE</b> | Above 1000MHz      |
| <b>ENVIRONMENTAL CONDITIONS</b>                                | 23deg. C, 70%RH | <b>INPUT POWER</b>     | DC 5V from adapter |
| <b>TESTED BY</b>   | Rose Ma         |                        |                    |
| <b>ANTENNA POLARITY &amp; TEST DISTANCE: HORIZONTAL AT 3 M</b> |                 |                        |                    |

|   | Freq        | Level  | Read Level | Limit Line | Over Limit | Factor | Remark | Pol/Phase  |
|---|-------------|--------|------------|------------|------------|--------|--------|------------|
|   | MHz         | dBm/m  | dBm        | dBm/m      | dB         | dB/m   |        |            |
| 1 | PP 1648.000 | -46.67 | -41.70     | -13.00     | -33.67     | -4.97  | Peak   | Horizontal |
| 2 | 2479.200    | -57.08 | -55.43     | -13.00     | -44.08     | -1.65  | Peak   | Horizontal |

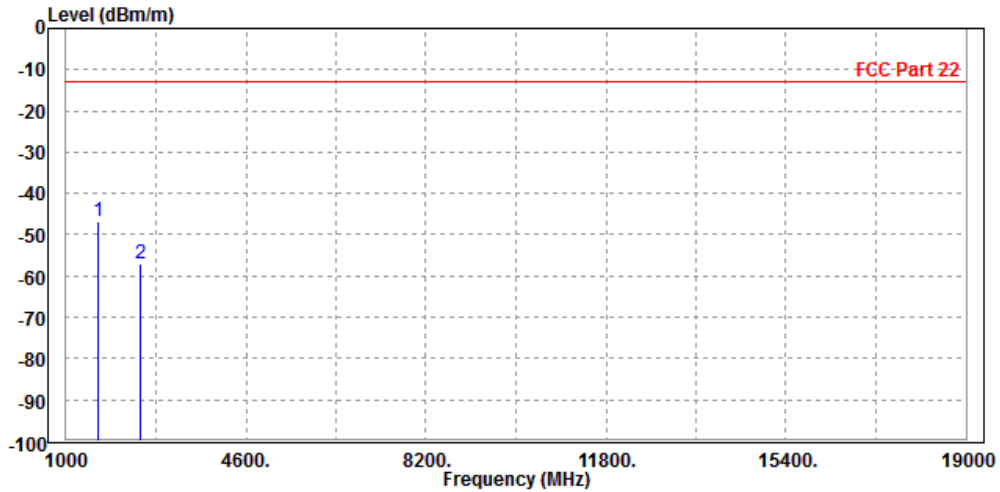



**BUREAU  
VERITAS**

Test Report No.: RF180710W003-3

|  |                 |                        |                    |
|--|-----------------|------------------------|--------------------|
| <b>MODE</b>  | TX channel 4132 | <b>FREQUENCY RANGE</b> | Above 1000MHz      |
| <b>ENVIRONMENTAL CONDITIONS</b>                              | 23deg. C, 70%RH | <b>INPUT POWER</b>     | DC 5V from adapter |
| <b>TESTED BY</b>   | Rose Ma         |                        |                    |
| <b>ANTENNA POLARITY &amp; TEST DISTANCE: VERTICAL AT 3 M</b> |                 |                        |                    |

|   | Freq        | Level  | Read Level | Limit Line | Over Limit | Factor | Remark | Pol/Phase |
|---|-------------|--------|------------|------------|------------|--------|--------|-----------|
|   | MHz         | dBm/m  | dBm        | dBm/m      | dB         | dB/m   |        |           |
| 1 | PP 1648.000 | -41.94 | -38.39     | -13.00     | -28.94     | -3.55  | Peak   | Vertical  |
| 2 | 2479.200    | -52.62 | -52.45     | -13.00     | -39.62     | -0.17  | Peak   | Vertical  |

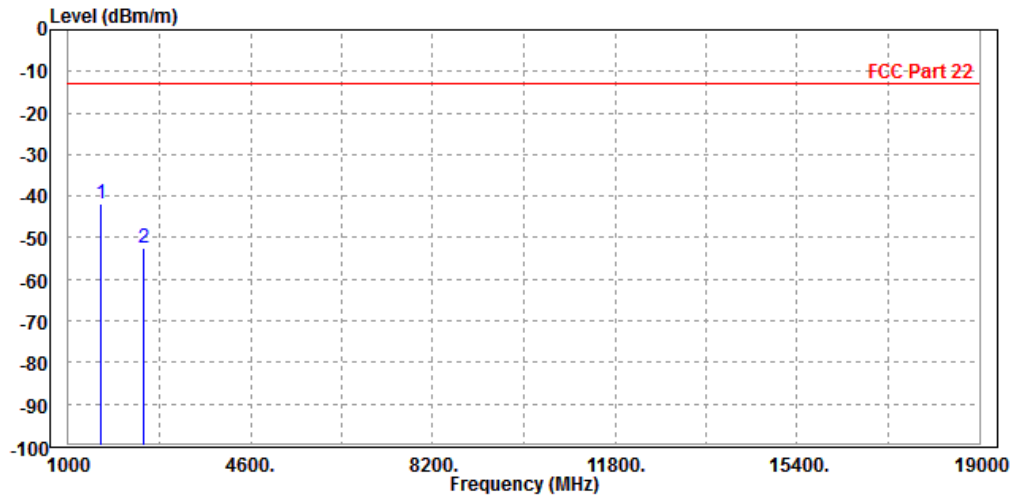





BUREAU VERITAS

Test Report No.: RF180710W003-3

CH 4182:

|   |                 |                 |                    |
|---|-----------------|-----------------|--------------------|
| MODE  | TX channel 4182 | FREQUENCY RANGE | Above 1000MHz      |
| ENVIRONMENTAL CONDITIONS                            | 23deg. C, 70%RH | INPUT POWER     | DC 5V from adapter |
| TESTED BY   | Rose Ma         |                 |                    |
| ANTENNA POLARITY & TEST DISTANCE: HORIZONTAL AT 3 M |                 |                 |                    |

|   | Freq        | Level  | Read Level | Limit Line | Over Limit | Factor | Remark | Pol/Phase  |
|---|-------------|--------|------------|------------|------------|--------|--------|------------|
|   | MHz         | dBm/m  | dBm        | dBm/m      | dB         | dB/m   |        |            |
| 1 | 1648.000    | -60.37 | -55.40     | -13.00     | -47.37     | -4.97  | Peak   | Horizontal |
| 2 | PP 2479.200 | -57.07 | -55.42     | -13.00     | -44.07     | -1.65  | Peak   | Horizontal |

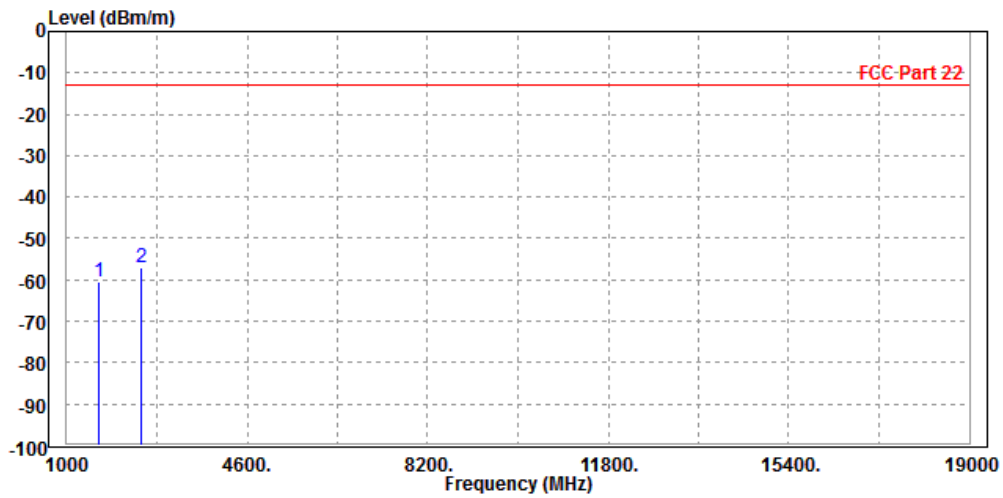



BUREAU VERITAS

Test Report No.: RF180710W003-3

|  |                 |                 |                    |
|--|-----------------|-----------------|--------------------|
| MODE   | TX channel 4182 | FREQUENCY RANGE | Above 1000MHz      |
| ENVIRONMENTAL CONDITIONS                                     | 23deg. C, 70%RH | INPUT POWER     | DC 5V from adapter |
| TESTED BY  | Rose Ma         |                 |                    |
| <b>ANTENNA POLARITY &amp; TEST DISTANCE: VERTICAL AT 3 M</b> |                 |                 |                    |

|      | Freq     | Level  | Read Level | Limit Line | Over Limit | Factor | Remark | Pol/Phase |
|------|----------|--------|------------|------------|------------|--------|--------|-----------|
|      | MHz      | dBm/m  | dBm        | dBm/m      | dB         | dB/m   |        |           |
| 1    | 1648.000 | -59.25 | -55.70     | -13.00     | -46.25     | -3.55  | Peak   | Vertical  |
| 2 PP | 2479.200 | -53.32 | -53.15     | -13.00     | -40.32     | -0.17  | Peak   | Vertical  |

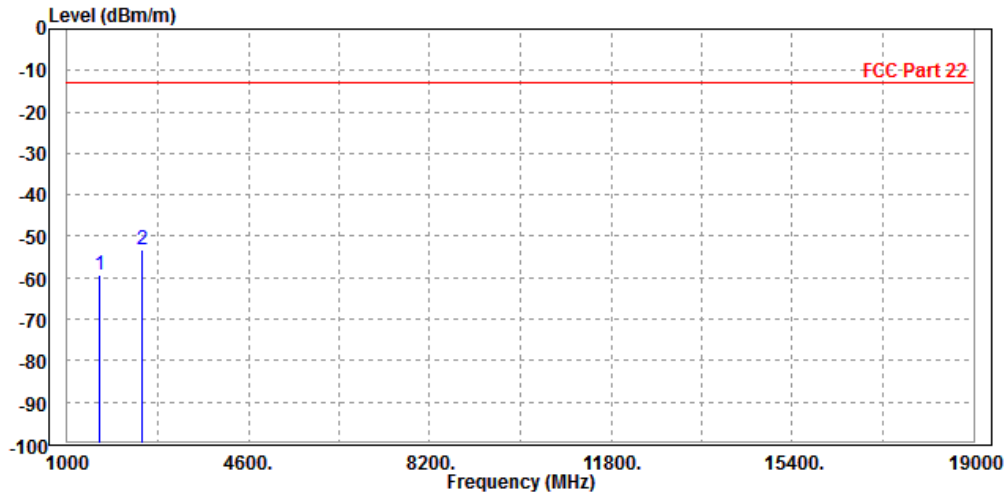



BUREAU VERITAS

Test Report No.: RF180710W003-3

CH 4233:

|  |                 |                 |                    |
|--|-----------------|-----------------|--------------------|
| MODE   | TX channel 4233 | FREQUENCY RANGE | Above 1000MHz      |
| ENVIRONMENTAL CONDITIONS                                       | 23deg. C, 70%RH | INPUT POWER     | DC 5V from adapter |
| TESTED BY  | Rose Ma         |                 |                    |
| <b>ANTENNA POLARITY &amp; TEST DISTANCE: HORIZONTAL AT 3 M</b> |                 |                 |                    |

|   | Freq        | Level  | Read Level | Limit Line | Over Limit | Factor | Remark | Pol/Phase  |
|---|-------------|--------|------------|------------|------------|--------|--------|------------|
|   | MHz         | dBm/m  | dBm        | dBm/m      | dB         | dB/m   |        |            |
| 1 | 1702.000    | -58.93 | -54.41     | -13.00     | -45.93     | -4.52  | Peak   | Horizontal |
| 2 | PP 2539.800 | -57.34 | -55.85     | -13.00     | -44.34     | -1.49  | Peak   | Horizontal |

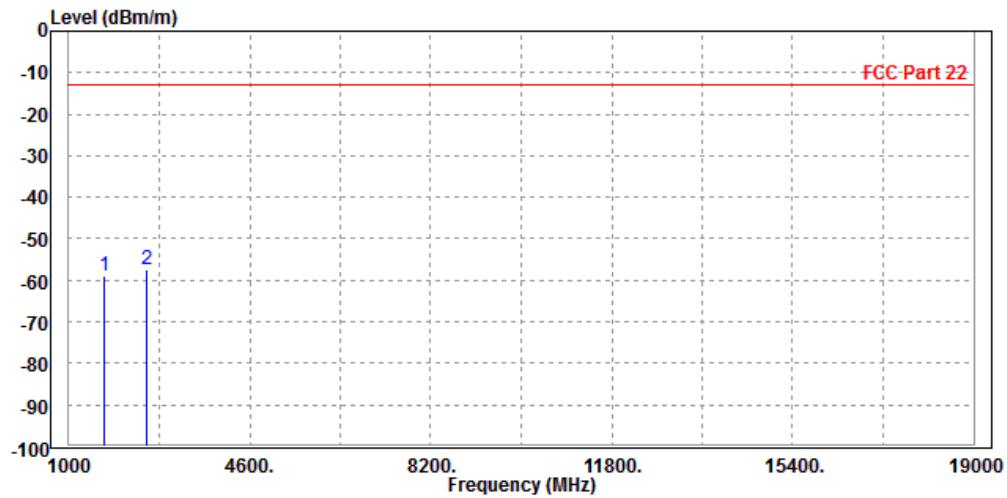



BUREAU VERITAS

Test Report No.: RF180710W003-3

|  |                 |                 |                    |
|--|-----------------|-----------------|--------------------|
| MODE   | TX channel 4233 | FREQUENCY RANGE | Above 1000MHz      |
| ENVIRONMENTAL CONDITIONS                                     | 23deg. C, 70%RH | INPUT POWER     | DC 5V from adapter |
| TESTED BY  | Rose Ma         |                 |                    |
| <b>ANTENNA POLARITY &amp; TEST DISTANCE: VERTICAL AT 3 M</b> |                 |                 |                    |

|   | Freq        | Level  | Read Level | Limit Line | Over Limit | Factor | Remark | Pol/Phase |
|---|-------------|--------|------------|------------|------------|--------|--------|-----------|
|   | MHz         | dBm/m  | dBm        | dBm/m      | dB         | dB/m   |        |           |
| 1 | PP 1702.000 | -46.45 | -43.40     | -13.00     | -33.45     | -3.05  | Peak   | Vertical  |
| 2 | 2539.800    | -56.59 | -56.59     | -13.00     | -43.59     | 0.00   | Peak   | Vertical  |

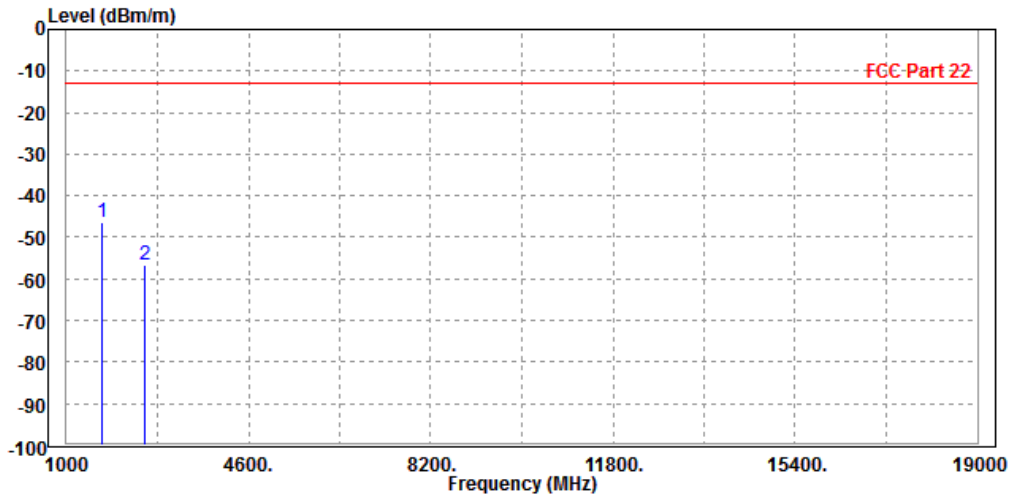

### 3.7 PEAK TO AVERAGE RATIO

#### 3.7.1 LIMITS OF PEAK TO AVERAGE RATIO MEASUREMENT

In measuring transmissions in this band using an average power technique, the peak to-average ratio (PAR) of the transmission may not exceed 13 dB

#### 3.7.2 TEST SETUP

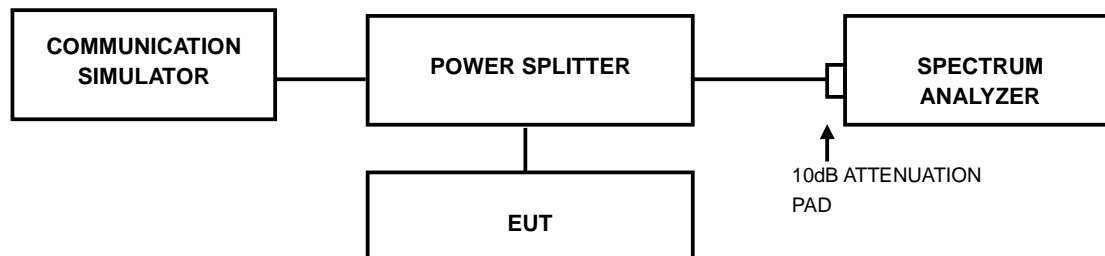

#### 3.7.3 TEST PROCEDURES

1. Set resolution/measurement bandwidth  $\geq$  signal's occupied bandwidth;
2. Set the number of counts to a value that stabilizes the measured CCDF curve;
3. Record the maximum PAPR level associated with a probability of 0.1%.



BUREAU VERITAS

Test Report No.: RF180710W003-3

### 3.7.4 TEST RESULTS

#### GSM

| CHANNEL | FREQUENCY (MHz) | PEAK TO AVERAGE RATIO (dB) |
|---------|-----------------|----------------------------|
| 128     | 824.2           | 2.73                       |

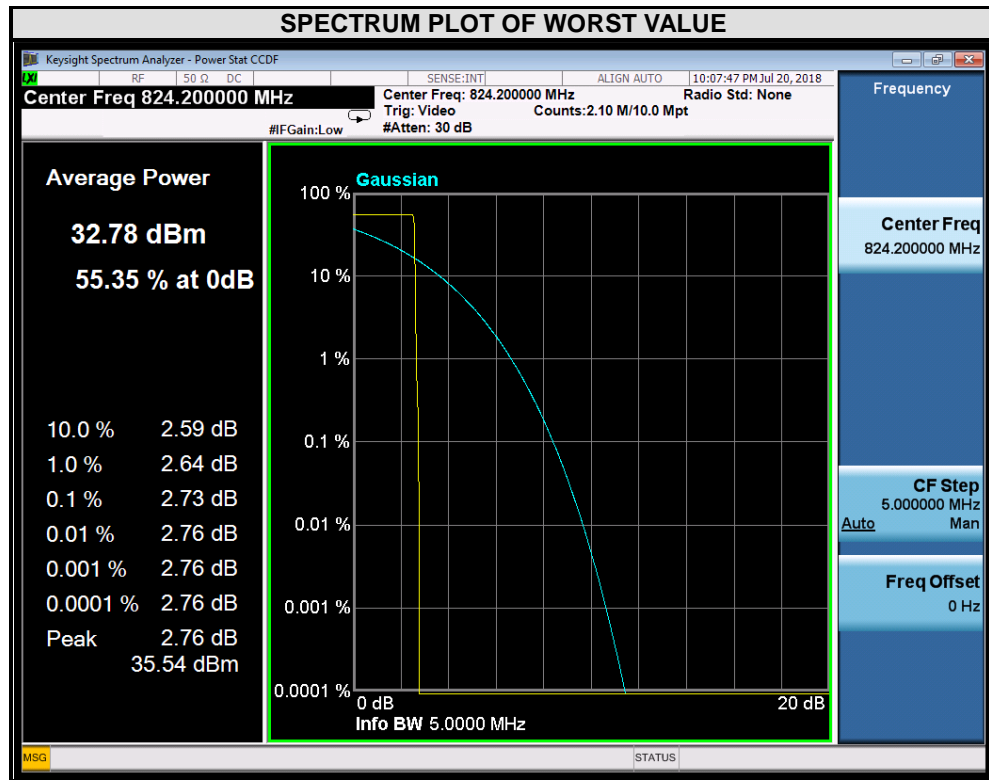



BUREAU VERITAS

Test Report No.: RF180710W003-3

| CHANNEL | FREQUENCY (MHz) | PEAK TO AVERAGE RATIO (dB) |
|---------|-----------------|----------------------------|
| 189     | 836.4           | 2.73                       |

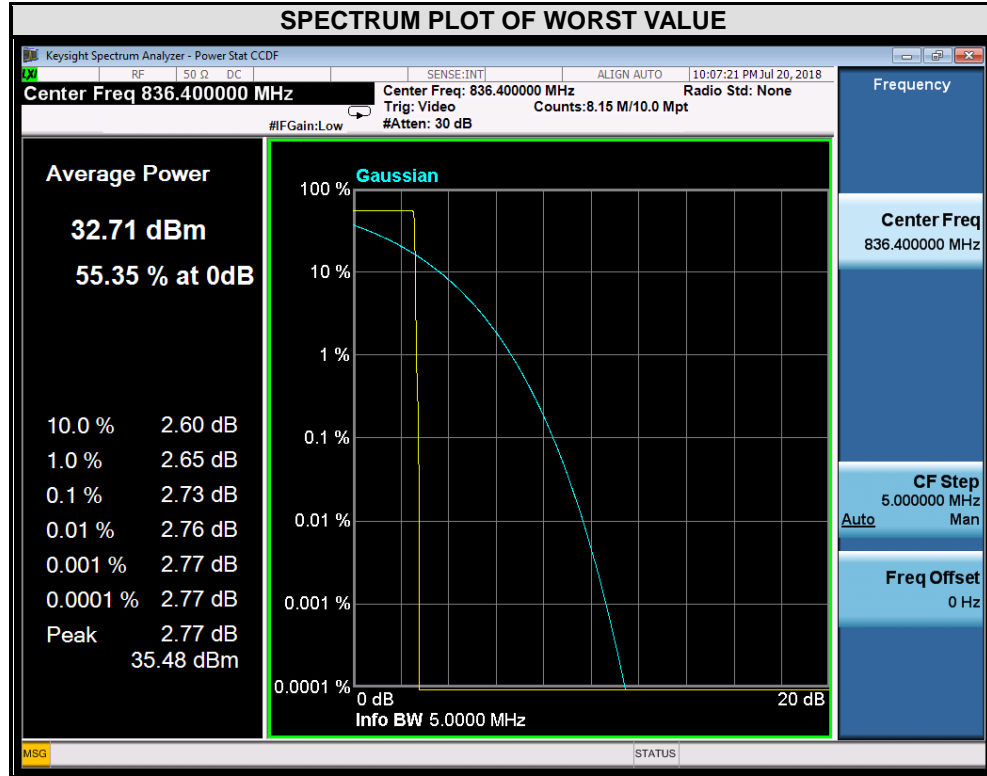



BUREAU VERITAS

Test Report No.: RF180710W003-3

| CHANNEL | FREQUENCY (MHz) | PEAK TO AVERAGE RATIO (dB) |
|---------|-----------------|----------------------------|
| 251     | 848.8           | 2.74                       |

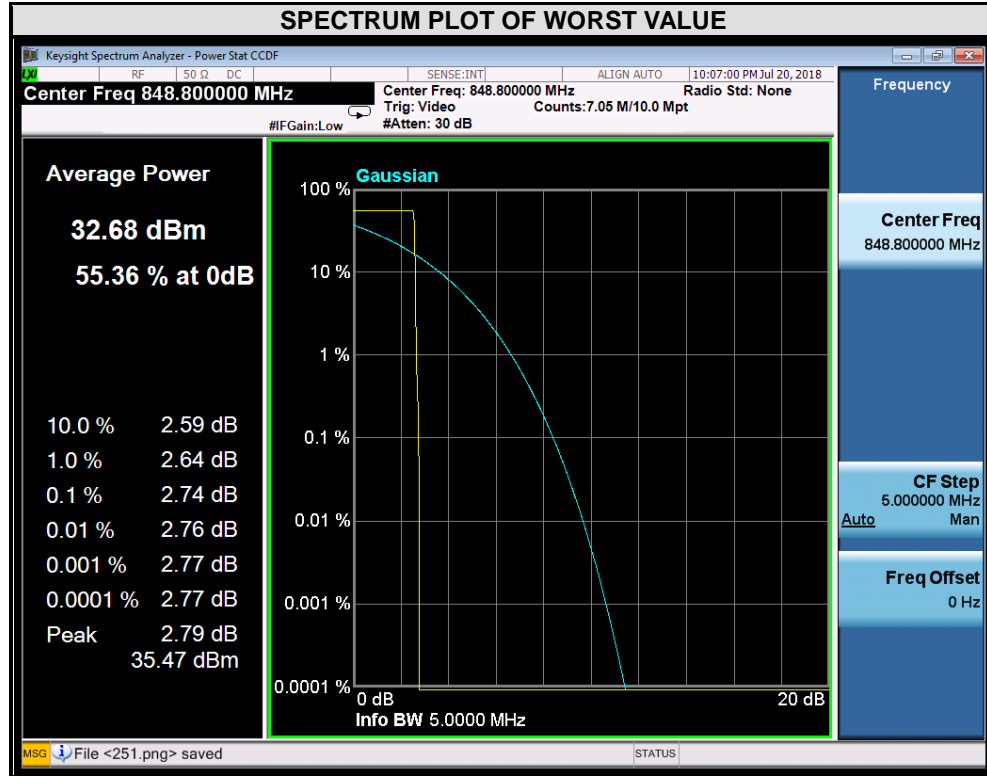





**BUREAU  
VERITAS**

Test Report No.: RF180710W003-3

GPRS

| CHANNEL | FREQUENCY (MHz) | PEAK TO AVERAGE RATIO (dB) |
|---------|-----------------|----------------------------|
| 128     | 824.2           | 2.74                       |

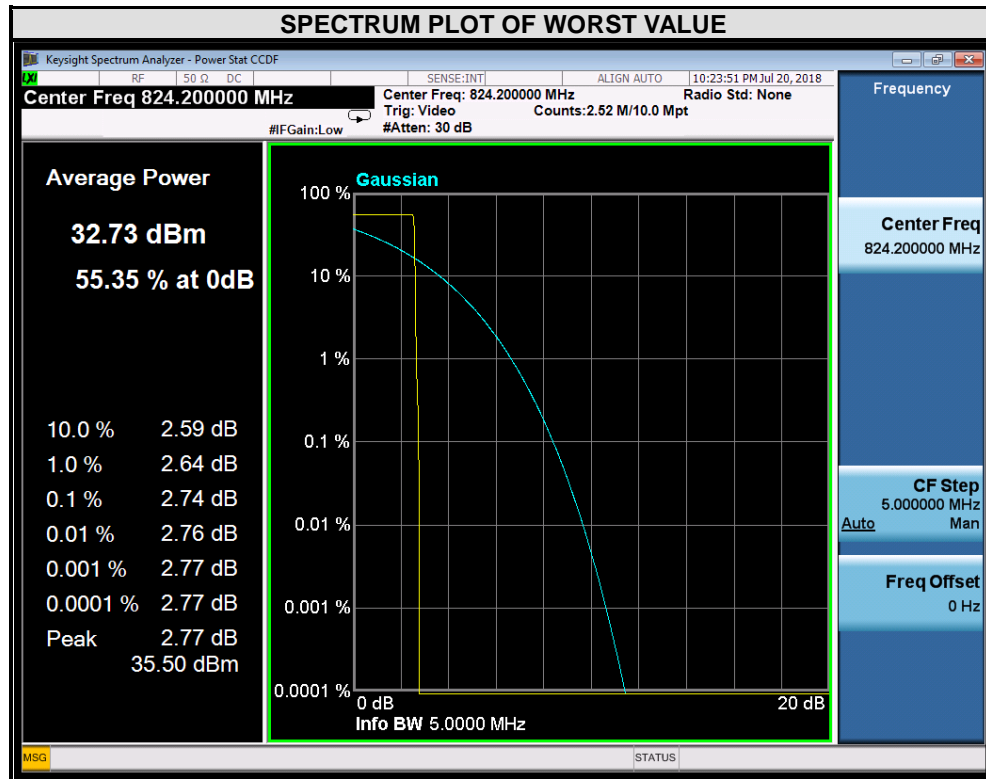



**BUREAU  
VERITAS**

Test Report No.: RF180710W003-3

| CHANNEL | FREQUENCY (MHz) | PEAK TO AVERAGE RATIO (dB) |
|---------|-----------------|----------------------------|
| 189     | 836.4           | 2.73                       |

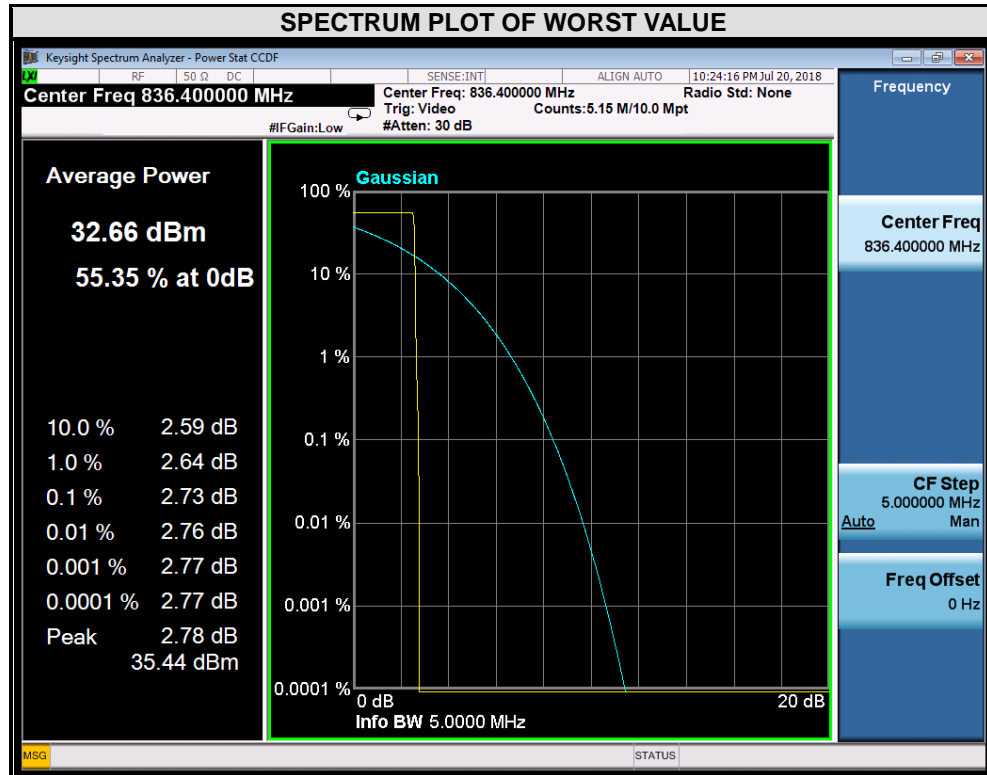



**BUREAU  
VERITAS**

Test Report No.: RF180710W003-3

| CHANNEL | FREQUENCY (MHz) | PEAK TO AVERAGE RATIO (dB) |
|---------|-----------------|----------------------------|
| 251     | 848.8           | 2.75                       |

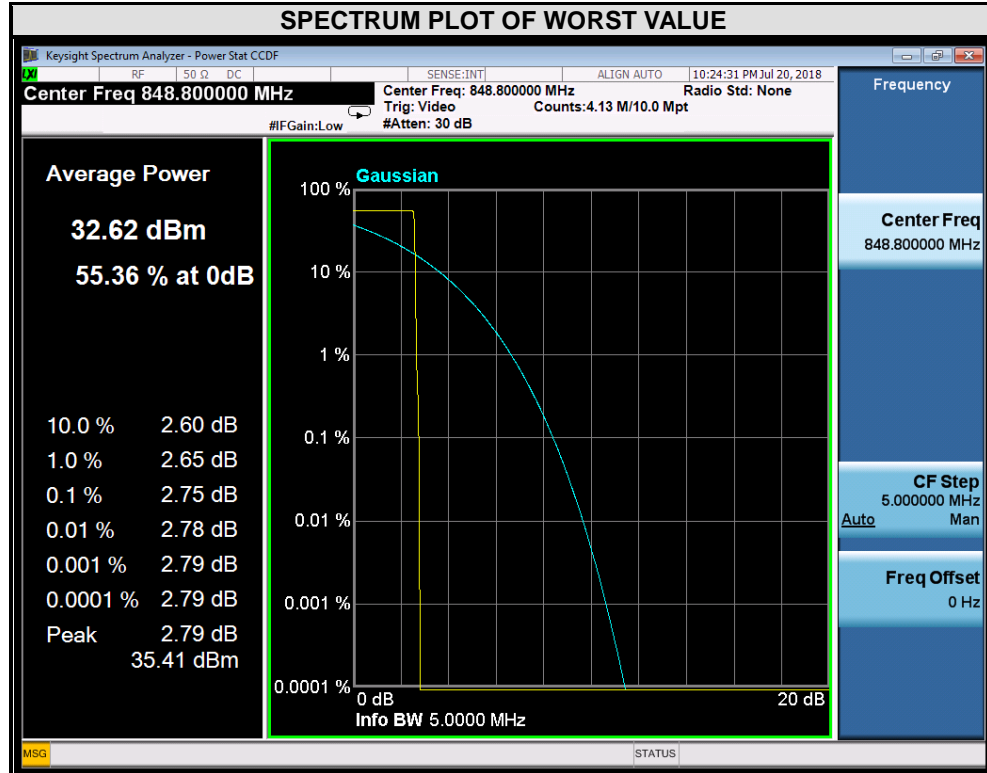



BUREAU VERITAS

Test Report No.: RF180710W003-3

WCDMA

| CHANNEL | FREQUENCY (MHz) | PEAK TO AVERAGE RATIO (dB) |
|---------|-----------------|----------------------------|
| 4132    | 826.4           | 3.19                       |

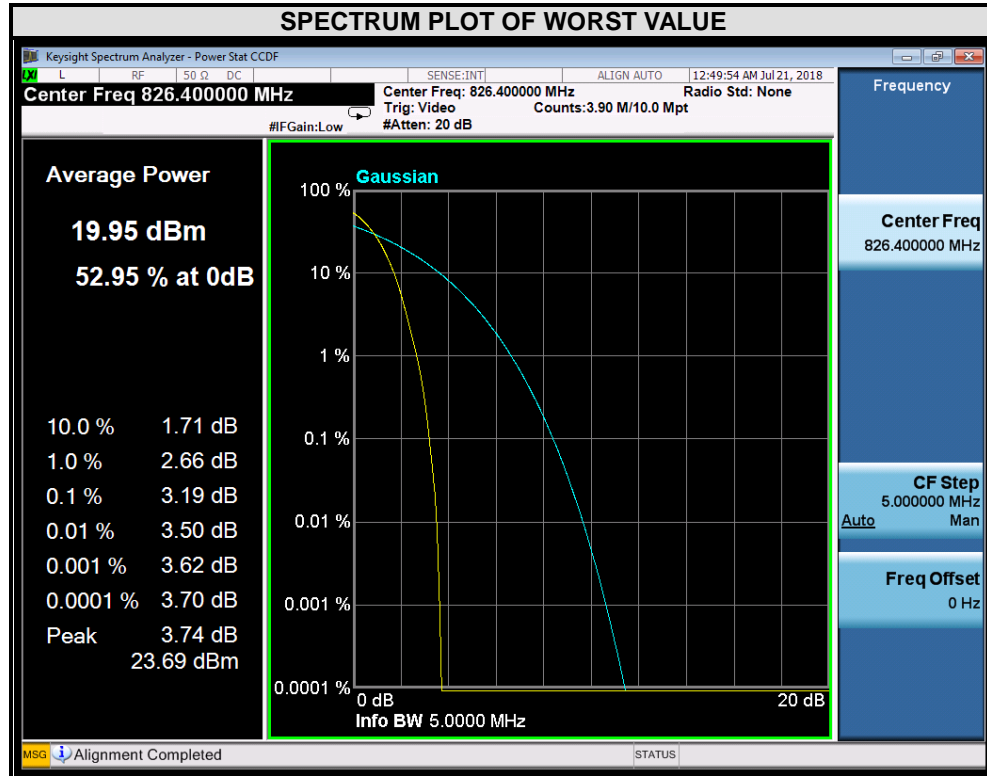



**BUREAU  
VERITAS**

Test Report No.: RF180710W003-3

| CHANNEL | FREQUENCY (MHz) | PEAK TO AVERAGE RATIO (dB) |
|---------|-----------------|----------------------------|
| 4182    | 836.4           | 3.20                       |

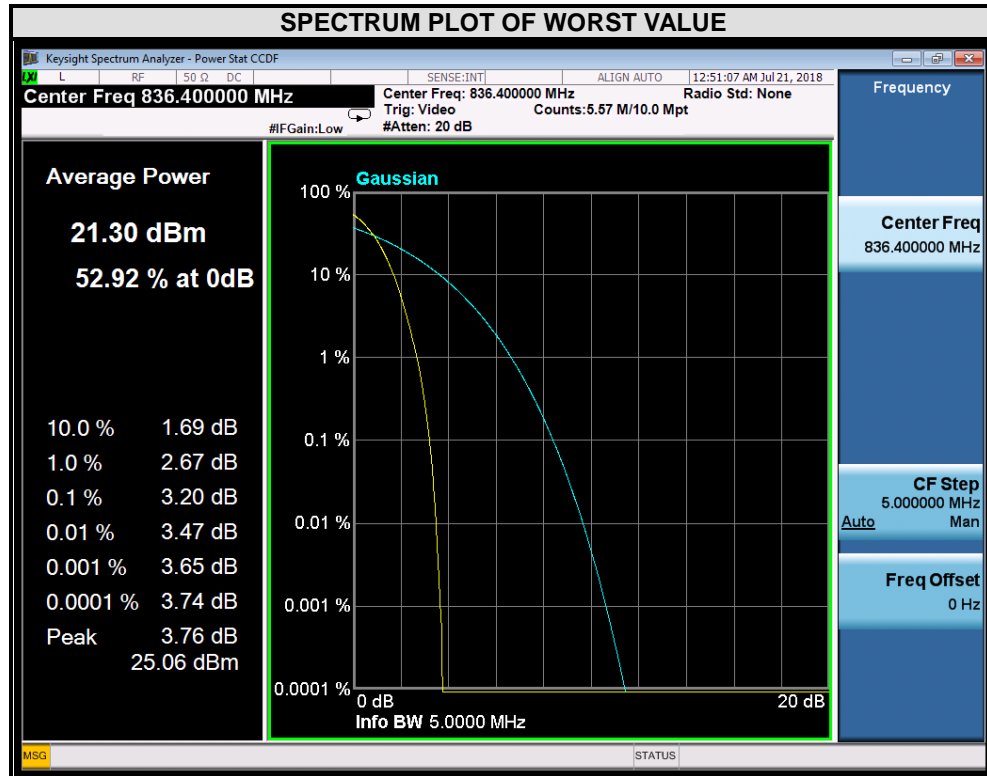



BUREAU VERITAS

Test Report No.: RF180710W003-3

| CHANNEL | FREQUENCY (MHz) | PEAK TO AVERAGE RATIO (dB) |
|---------|-----------------|----------------------------|
| 4233    | 846.6           | 3.17                       |

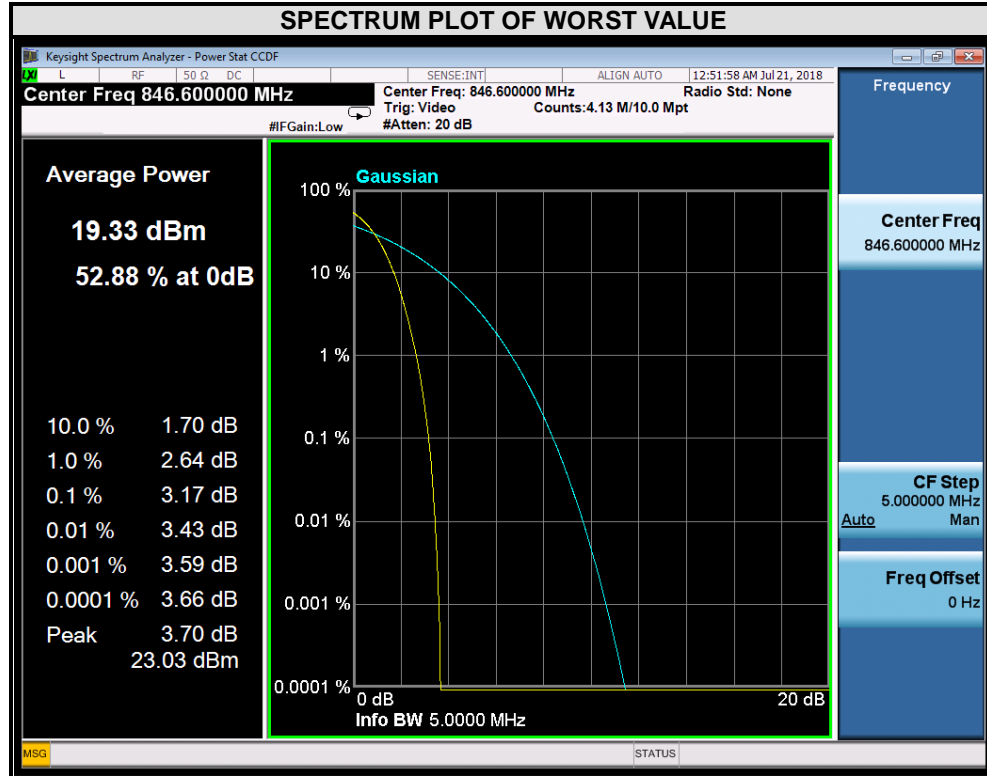



**BUREAU  
VERITAS**

Test Report No.: RF180710W003-3

## 4 PHOTOGRAPHS OF THE TEST CONFIGURATION

Please refer to the attached file (Test Setup Photo).



Test Report No.: RF180710W003-3

## 5 INFORMATION ON THE TESTING LABORATORIES

We, BV 7LAYERS COMMUNICATIONS TECHNOLOGY (SHENZHEN) CO. LTD., were founded in 2015 to provide our best service in EMC, Radio, Telecom and Safety consultation. Our laboratories are accredited and approved according to ISO/IEC 17025.

If you have any comments, please feel free to contact us at the following:

**Shenzhen EMC/RF Lab:**

Tel: +86-755-88696566

Fax: +86-755-88696577

**Email:** [customerservice.dg@cn.bureauveritas.com](mailto:customerservice.dg@cn.bureauveritas.com)

**Web Site:** [www.adt.com.tw](http://www.adt.com.tw)

The address and road map of all our labs can be found in our web site also.





**BUREAU  
VERITAS**

Test Report No.: RF180710W003-3

## **6 APPENDIX A – MODIFICATIONS RECORDERS FOR ENGINEERING CHANGES TO THE EUT BY THE LAB**

No any modifications are made to the EUT by the lab during the test.

**---END---**