

EMC TEST REPORT

Applicant:	Corporativo Lanix S.A. de C.V.
Address:	Carretera Internacional Hermosillo-Nogales Km 8.5, Hermosillo Sonora, Mexico

Manufacturer or Supplier	AMER MOBILE CO., LIMITED
Address	Room A30, 9th floor, Silvercorp International Tower No 707-713, Nathan Road, Mongkok, Kowloon, Hong Kong
Product	Smart phone
FCC ID	ZC4X200
Brand Name	LANIX
Model Name	Ilium X200
Additional Model & Model Difference	N/A
Date of tests	Mar. 14, 2015 ~ Mar. 19, 2015 Jul. 14, 2015 ~ Jul. 15, 2015

The submitted sample of the above equipment has been tested for according to the requirements of the following standards:

FCC Part 15, Subpart B, Class B

CONCLUSION: The submitted sample was found to COMPLY with the test requirement

Tested by Jeffery Lee
Project Engineer / EMC Department

Approved by Sam Tung
Manager / EMC Department



Date: Jul. 15, 2015

This report is for your exclusive use. Any copying or replication of this report to or for any other person or entity, or use of our name or trademark, is permitted only with our prior written permission. This report sets forth our findings solely with respect to the test samples identified herein. The results set forth in this report are not indicative or representative of the quality or characteristics of the lot from which a test sample was taken or any similar or identical product unless specifically and expressly noted. Our report includes all of the tests requested by you and the results thereof based upon the information that you provided to us. You have 60 days from date of issuance of this report to notify us of any material error or omission caused by our negligence, provided, however, that such notice shall be in writing and shall specifically address the issue you wish to raise. A failure to raise such issue within the prescribed time shall constitute your unqualified acceptance of the completeness of this report, the tests conducted and the correctness of the report contents. Unless specific mention, the uncertainty of measurement has been explicitly taken into account to declare the compliance or non-compliance to the specification



Table of Contents

RELEASE CONTROL RECORD.....	3
1 GENERAL INFORMATION	4
1.1 GENERAL DESCRIPTION OF EUT	4
1.2 SUMMARY OF TEST RESULTS.....	5
1.3 MEASUREMENT UNCERTAINTY	5
1.4 DESCRIPTION OF TEST MODES	6
1.5 DESCRIPTION OF SUPPORT UNITS.....	7
1.6 CONFIGURATION OF SYSTEM UNDER TEST	8
2 EMISSION TEST.....	9
2.1 CONDUCTED EMISSION MEASUREMENT.....	9
2.1.1 LIMITS OF CONDUCTED EMISSION MEASUREMENT	9
2.1.2 TEST INSTRUMENTS	9
2.1.3 TEST PROCEDURES.....	10
2.1.4 DEVIATION FROM TEST STANDARD	10
2.1.5 TEST SETUP	11
2.1.6 EUT OPERATING CONDITIONS.....	11
2.1.7 TEST RESULTS.....	12
2.2 RADIATED EMISSION MEASUREMENT	14
2.2.1 LIMITS OF RADIATED EMISSION MEASUREMENT	14
2.2.2 TEST INSTRUMENTS	15
2.2.3 TEST PROCEDURE	16
2.2.4 DEVIATION FROM TEST STANDARD	16
2.2.5 TEST SETUP	17
2.2.6 EUT OPERATING CONDITIONS	17
2.2.7 TEST RESULTS	18
3 APPENDIX A – MODIFICATIONS RECORDERS FOR ENGINEERING CHANGES TO THE EUT BY THE LAB	21



BUREAU
VERITAS

Test Report No.: FV150714N019

RELEASE CONTROL RECORD

ISSUE NO.	REASON FOR CHANGE	DATE ISSUED
FV150313N001	Original release	Mar. 20, 2015
FV150714N019	Based on the original report FV150313N001 adding SIM2 socket and Enable GPS Function.	Jul. 15, 2015



1 GENERAL INFORMATION

1.1 GENERAL DESCRIPTION OF EUT

PRODUCT	Smart phone	
MODEL NAME	Ilium X200	
NOMINAL VOLTAGE	5.0Vdc (adapter or host equipment) 3.7Vdc (battery)	
BATTERY	Brand Name: LANIX Model Name: Ilium X200-BAT Power Rating: DC 3.7V, 1400mAh, Li-ion	
MODULATION TYPE	BT	GFSK, 8DPSK, $\pi/4$ DQPSK BT-LE(GFSK) for DTS
	WLAN	CCK, DQPSK, DBPSK for DSSS 64QAM, 16QAM, QPSK, BPSK for OFDM
	GSM/GPRS	GMSK
	WCDMA	BPSK/QPSK
OPERATING FREQUENCY	BT	2402-2480MHz for BT-LE(GFSK)
	WLAN	2412-2462MHz for 11b/g/n(HT20) 2422-2452MHz for 11b/g/n(HT40)
	GSM/GPRS	824.2MHz ~ 848.8MHz (FOR GSM 850) 1850.2MHz ~ 1909.8MHz(FOR GSM 1900)
	WCDMA	826.4MHz ~ 846.6MHz (FOR WCDMA 850) 1852.4MHz ~ 1907.6MHz (FOR WCDMA 1900)
HW Version	TMB1c	
SW Version	ILIUM_X200_TELCEL_SW_05	
I/O PORTS	Refer to user's manual	
CABLE	USB Cable: unshielded, detachable, 1.0m Earphone Cable: shielded, detachable, 1.0m	
ACCESSORY DEVICES	Refer to note as below	

NOTE:

- For a more detailed features description, please refer to the manufacturer's specifications or the user's manual.
- The EUT was powered by the following adapter:

ADAPTER	
BRAND:	LANIX
MODEL:	Ilium X200-C
INPUT:	AC 100-240V, 150mA
OUTPUT:	DC 5V, 500A

- For the test results, the EUT had been tested with all conditions. But only the worst case was shown in test report.



1.2 SUMMARY OF TEST RESULTS

The EUT has been tested according to the following specifications:

APPLIED STANDARD: FCC Part 15, Subpart B			
Standard Section	Test Item	Result	Remark
FCC Part 15, Subpart B, Class B	Conducted Test	PASS	Meets limits minimum passing margin is -6.23dB at 0.34224MHz.
	Radiated Emission Test (30MHz ~ 1GHz)	PASS	Meets Class B Limit Minimum passing margin is -6.75dB at 47.46MHz.
	Radiated Emission Test (Above 1GHz)	PASS	Meets Class B Limit Minimum passing margin is -18.06dB at 1350MHz.

1.3 MEASUREMENT UNCERTAINTY

Where relevant, the following measurement uncertainty levels have been estimated for tests performed on the EUT as specified in CISPR 16-4-2:

This uncertainty represents an expanded uncertainty expressed at approximately the 95% confidence level using a coverage factor of k=2.

MEASUREMENT	FREQUENCY	UNCERTAINTY
Conducted emissions	150kHz ~ 30MHz	+/-2.66dB
Radiated emissions	30MHz ~ 1GHz	+/-4.10dB
	1GHz ~ 18GHz	+/-4.58dB



1.4 DESCRIPTION OF TEST MODES

Test Mode	Test Condition
Radiated emission test	
1	GSM850 Idle + Adapter + USB Cable + Earphone + Battery + BT Idle + Wifi Idle(2.4G) + GPS RX
2	PCS1900 Idle + USB Link + USB Cable + Earphone + Battery + BT Idle + Wifi Idle(2.4G) + MPEG4
3	WCDMA Band II Idle + Adapter + USB Cable + Earphone + Battery + BT Idle + Wifi Idle(2.4G) + GPS RX
4	WCDMA Band V Idle + Adapter + USB Cable + Earphone + Battery + BT Idle + Wifi Idle(2.4G) + GPS RX
Conducted emission test	
1	GSM850 Idle + Adapter + USB Cable + Earphone + Battery + BT Idle + Wifi Idle(2.4G) + GPS RX
2	PCS1900 Idle + USB Link + USB Cable + Earphone + Battery + BT Idle + Wifi Idle(2.4G) + MPEG4
3	WCDMA Band II Idle + Adapter + USB Cable + Earphone + Battery + BT Idle + Wifi Idle(2.4G) + GPS RX
4	WCDMA Band V Idle + Adapter + USB Cable + Earphone + Battery + BT Idle + Wifi Idle(2.4G) + GPS RX

NOTE:

1. For conducted emission test, test mode2 was the worst case and only this mode was presented in this report.
2. For radiated emission test, test mode 1 was the worst case and only this mode was presented in this report.



1.5 DESCRIPTION OF SUPPORT UNITS

The EUT has been tested as an independent unit together with other necessary accessories or support units. The following support units or accessories were used to form a representative test configuration during the tests.

FOR EMISSION TESTS

NO.	PRODUCT	BRAND	MODEL NO.	SERIAL NO.	FCC ID
1	Universal Radio Communication Tester	R&S	CMU200	123259	N/A
2	Notebook	DELL	E6420	9H12FS1	N/A
3	Mouse	DELL	M056UOA	01688082	N/A
4	Printer	HP	hp LaserJet 1300	CNSJF75989	N/A

NO.	SIGNAL CABLE DESCRIPTION OF THE ABOVE SUPPORT UNITS
1	N/A
2	DC Line: Unshielded, Undetachable, 2.0m
3	USB Line: Unshielded, Undetachable 1.8m;
4	USB Line: Shielded, Detachable 1.5m;

NOTE:

1. All power cords of the above support units are non shielded (1.8m).
2. Items 3-4 acted as communication partners.



1.6 CONFIGURATION OF SYSTEM UNDER TEST

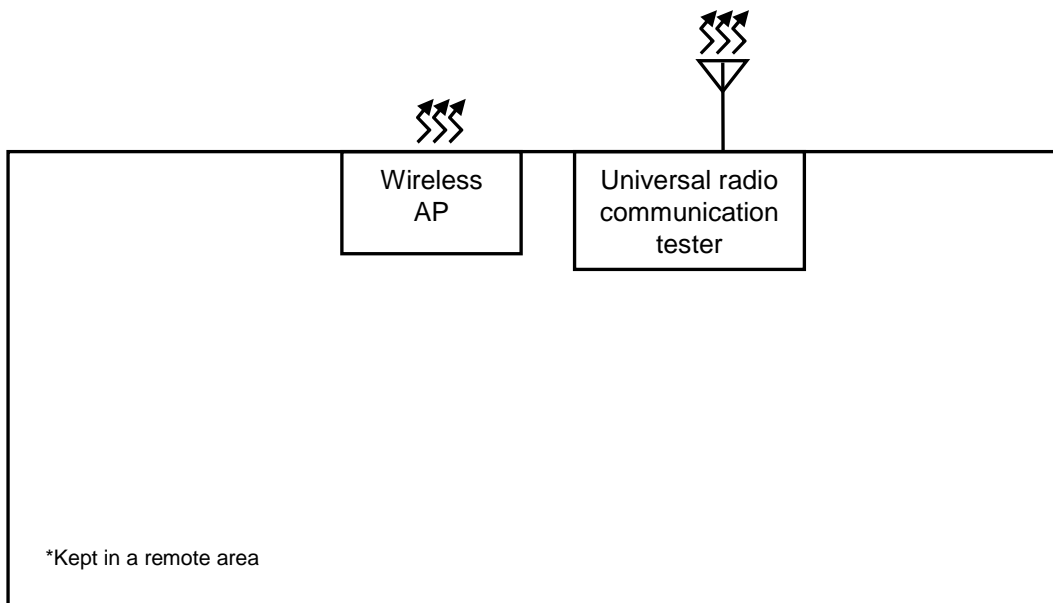
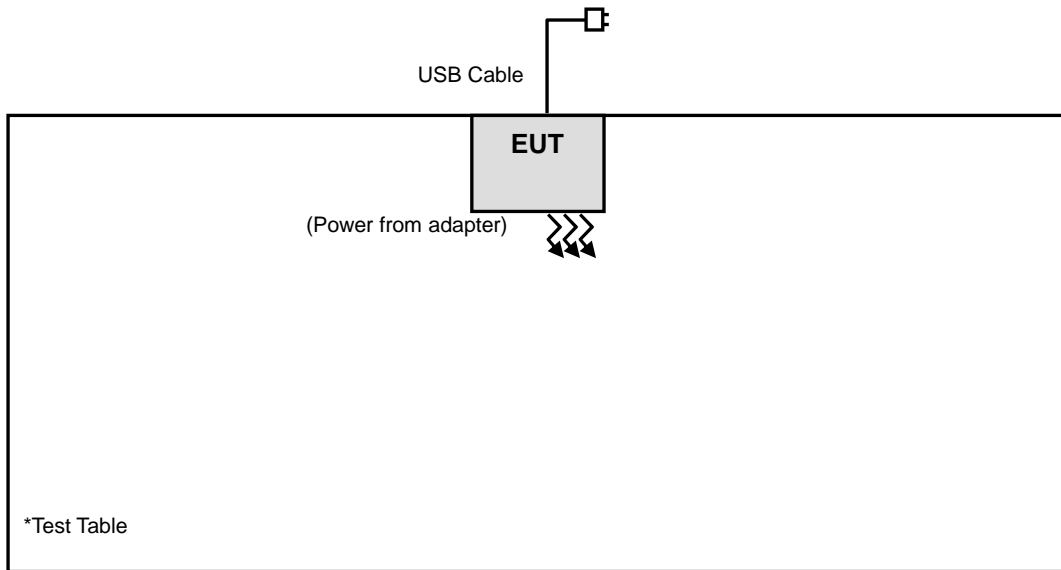



2 EMISSION TEST

2.1 CONDUCTED EMISSION MEASUREMENT

2.1.1 LIMITS OF CONDUCTED EMISSION MEASUREMENT

TEST STANDARD: FCC Part 15, Subpart B (Section: 15.107)

FREQUENCY OF EMISSION (MHz)	CONDUCTED LIMIT (dBµV)	
	Quasi-peak	Average
0.15 ~ 0.5	66 to 56	56 to 46
0.5 ~ 5	56	46
5 ~ 30	60	50

NOTE: 1.The lower limit shall apply at the transition frequencies.

2. The limit decreases in line with the logarithm of the frequency in the range of 0.15 to 0.50MHz.

3. All emanations from a class A/B digital device or system, including any network of conductors and apparatus connected thereto, shall not exceed the level of field strengths specified above.

2.1.2 TEST INSTRUMENTS

Equipment	Manufacturer	Model No.	Serial No.	Last Cal.	Next Cal.
EMI Test Receiver	Rohde&Schwarz	ESU 26	100005	April 25,15	April 24,16
Artificial Mains Network	Rohde&Schwarz	ENV216	101173	April 25,15	April 24,16
Artificial Mains Network	Rohde&Schwarz	ESH3-Z5	100317	April 25,15	April 24,16
Test software	ADT	ADT_Cond_V7.3.7	N/A	N/A	N/A

NOTE: 1. The calibration interval of the above test instruments is 12 months and the calibrations are traceable to CEPREI/CHINA, GRGT/CHINA and NIM/CHINA.

2. The test was performed in Dongguan Shielded Room 553.

There are no sources in the current document.



2.1.3 TEST PROCEDURES

- a. The EUT was placed 0.4 meters from the conducting wall of the shielded room with EUT being connected to the power mains through a line impedance stabilization network (LISN). Other support units were connected to the power mains through another LISN. The two LISNs provide 50 ohm/ 50uH of coupling impedance for the measuring instrument.
- b. Both lines of the power mains connected to the EUT were checked for maximum conducted interference.
- c. The frequency range from 150 kHz to 30MHz was searched. Emission levels under (Limit - 20dB) were not recorded.

NOTE: All modes of operation were investigated and the worst-case emissions are reported.

2.1.4 DEVIATION FROM TEST STANDARD

No deviation.



TEST SETUP

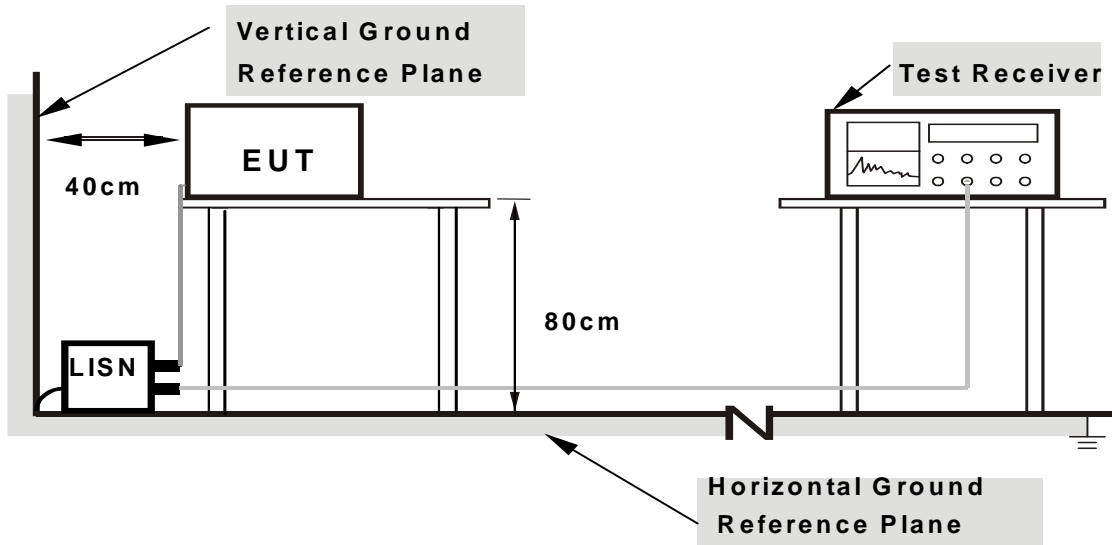

- Note:**
1. Support units were connected to second LISN.
 2. Both of LISNs (AMN) are 80 cm from EUT and at least 80 cm from other units and other metal planes

For the actual test configuration, please refer to the attached file (Test Setup Photo).

2.1.6 EUT OPERATING CONDITIONS

- a. Turned on the power and connected of all equipment.
- b. EUT was operated according to the use type described in the manufacturer's specifications or the user's manual.



2.1.7 TEST RESULTS

TEST VOLTAGE	AC 120 Vac, 60 Hz	6dB BANDWIDTH	9 kHz
ENVIRONMENTAL CONDITIONS	25deg. C, 50RH	PHASE	Line (L)
TESTED BY	David		

No	Freq. [MHz]	Corr. Factor (dB)	Reading Value		Emission Level		Limit		Margin	
			[dB (uV)]		[dB (uV)]		[dB (uV)]		(dB)	
			Q.P.	AV.	Q.P.	AV.	Q.P.	AV.	Q.P.	AV.
1	0.16787	9.77	41.90	33.07	51.67	42.84	65.07	55.07	-13.40	-12.23
2	0.28241	9.78	38.70	33.44	48.48	43.22	60.74	50.74	-12.26	-7.52
3	0.34244	9.82	40.29	33.10	50.11	42.92	59.14	49.14	-9.04	-6.23
4	0.75075	9.76	32.62	16.23	42.38	25.99	56.00	46.00	-13.62	-20.01
5	1.03875	9.80	32.80	18.98	42.60	28.78	56.00	46.00	-13.40	-17.22
6	1.959	9.79	32.75	21.12	42.54	30.91	56.00	46.00	-13.46	-15.09

REMARKS: The emission levels of other frequencies were very low against the limit.

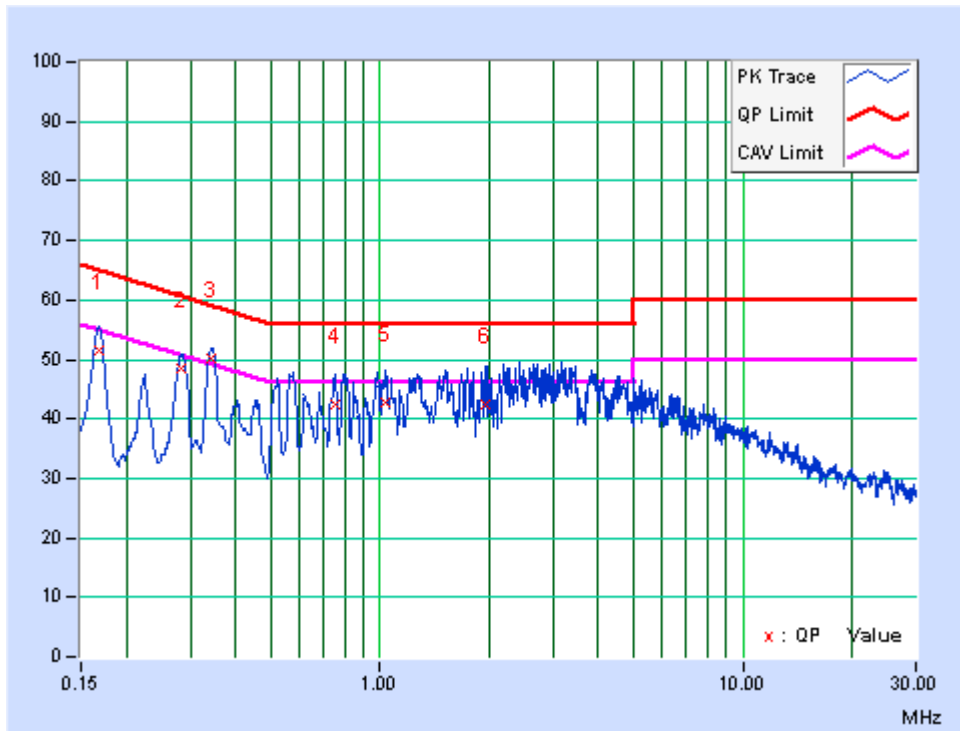



TEST VOLTAGE	AC 120 Vac, 60 Hz	6dB BANDWIDTH	9 kHz
ENVIRONMENTAL CONDITIONS	25deg. C, 50RH	PHASE	Neutral(N)
TESTED BY	David		

No	Freq. [MHz]	Corr. Factor (dB)	Reading Value		Emission Level		Limit		Margin	
			[dB (uV)]		[dB (uV)]		[dB (uV)]		(dB)	
	Q.P.	AV.	Q.P.	AV.	Q.P.	AV.	Q.P.	AV.	Q.P.	AV.
1	0.16966	9.50	42.13	29.63	51.63	39.13	64.98	54.98	-13.34	-15.84
2	0.22623	9.51	36.98	24.08	46.49	33.59	62.59	52.59	-16.10	-19.00
3	0.28092	9.52	35.68	26.96	45.20	36.48	60.79	50.79	-15.58	-14.30
4	0.34125	9.55	37.51	28.19	47.06	37.74	59.17	49.17	-12.12	-11.44
5	0.56404	9.50	30.96	21.43	40.46	30.93	56.00	46.00	-15.54	-15.07
6	0.62522	9.50	30.70	21.77	40.20	31.27	56.00	46.00	-15.80	-14.73

REMARKS: The emission levels of other frequencies were very low against the limit.

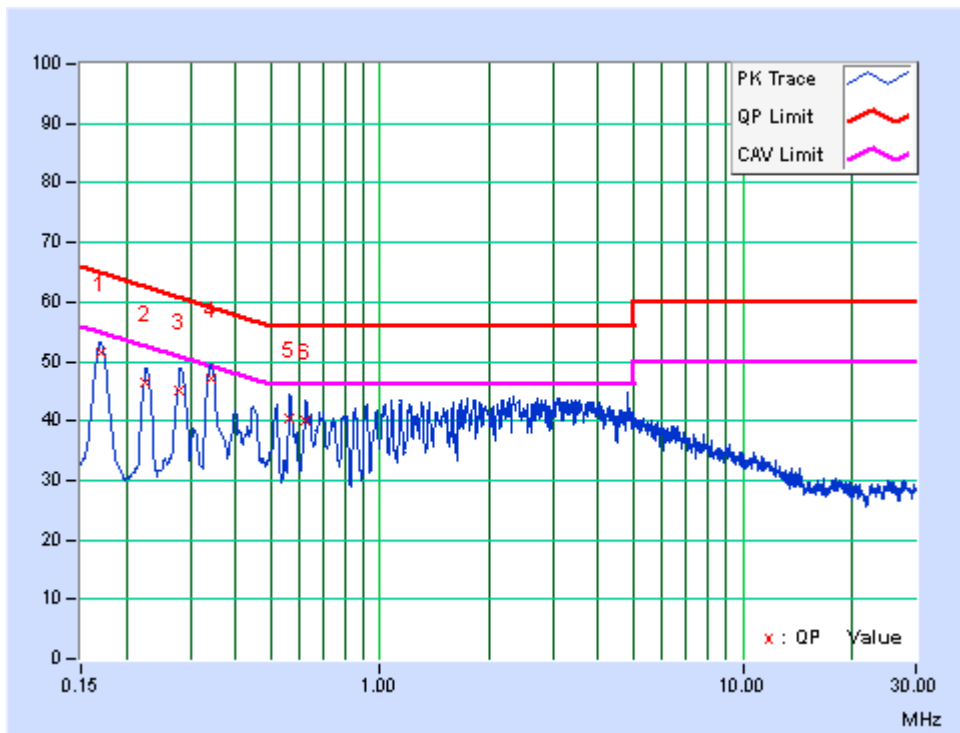



2.2 RADIATED EMISSION MEASUREMENT

2.2.1 LIMITS OF RADIATED EMISSION MEASUREMENT

TEST STANDARD: FCC Part 15, Subpart B (Section: 15.109)

Emissions radiated outside of the specified bands, shall be according to the general radiated limits as following:

Radiated Emissions Limits at 10 meters (dBµV/m)				
Frequencies (MHz)	FCC 15B / ICES-003, Class A	FCC 15B / ICES-003, Class B	CISPR 22, Class A	CISPR 22, Class B
30-88	39	29.5	40	30
88-216	43.5	33.1		
216-230	46.4	35.6		
230-960			47	37
960-1000	49.5	43.5	Not defined	Not defined
1000-3000	Avg: 49.5	Avg: 43.5		
3000+	Peak: 69.5	Peak: 63.5	Not defined	Not defined

Radiated Emissions Limits at 3 meters (dBµV/m)				
Frequencies (MHz)	FCC 15B / ICES-003, Class A	FCC 15B / ICES-003, Class B	CISPR 22, Class A	CISPR 22, Class B
30-88	49.5	40	50.5	40.5
88-216	54	43.5		
216-230	56.9	46		
230-960			57.5	47.5
960-1000	60	54	Avg: 56 Peak: 76	Avg: 50 Peak: 70
1000-3000	Avg: 60	Avg: 54		
3000+	Peak: 80	Peak: 74	Avg: 60 Peak: 80	Avg: 54 Peak: 74

- NOTE:**
1. The lower limit shall apply at the transition frequencies.
 2. Emission level (dBuV/m) = 20 log Emission level (uV/m).
 3. As shown in 15.35(b), for frequencies above 1000MHz, the field strength limits are based on average detector, however, the peak field strength of any emission shall not exceed the maximum permitted average limits, specified above by more than 20dB under any condition of modulation.
 4. QP detector shall be applied if not specified.



2.2.2 TEST INSTRUMENTS

For frequency below 1G

Equipment	Manufacturer	Model No.	Serial No.	Last Cal.	Next Cal.
EMI Test Receiver	Rohde&Schwarz	ESCI	100962	Mar. 05,15	Mar. 04,16
EMI Test Receiver	Rohde&Schwarz	ESCI	101418	Mar. 05,15	Mar. 04,16
Trilog-Broadband Antenna	SCHWARZBECK	VULB 9168	9168-554	Dec. 08, 14	Dec. 07, 15
Trilog-Broadband Antenna	SCHWARZBECK	VULB 9168	9168-555	Nov. 24, 14	Nov. 23, 15
Signal Amplifier	Agilent	8447D	2944A10488	Jun. 24,15	Jun. 23,16
Signal Amplifier	Agilent	8447D	2944A11174	Jun. 24,15	Jun. 23,16
10m Semi-anechoic Chamber	CHANGLING	21.4m*12.1m*8.8m	NSEMC006	Jun. 10, 15	Jun. 09, 16
Test Software	ADT	ADT_Radiated_V8.7.x	N/A	N/A	N/A

Frequency range above 1GHz

Equipment	Manufacturer	Model No.	Serial No.	Last Cal.	Next Cal.
Horn Antenna	ETS-Lindgren	3117	00085519	Feb. 03,15	Feb. 02,17
Horn Antenna	SCHWARZBECK	BBHA 9170	BBHA9170242	Feb. 13,14	Feb. 12,17
Signal and Spectrum Analyzer	Rohde&Schwarz	FSV40	101003	Apr. 07, 15	Apr. 06, 16
Pre-Amplifier (100MHz-26.5GHz)	EMCI	EMC 012645	980077	May 26,15	May 25,16
Pre-Amplifier (18GHz-40GHz)	EMCI	EMC 184045	980102	Nov. 20,14	Nov. 19,15
Test Software	ADT	ADT_Radiated_V8.7.x	N/A	N/A	N/A

- NOTE:**
1. The test was performed in 10m Chamber.
 2. The calibration interval of the above test instruments is 12 months or 24 months and the calibrations are traceable to CEPREI/CHINA, GRGT/CHINA and NIM/CHINA.
 3. The FCC Site Registration No. is 502831.



2.2.3 TEST PROCEDURE

The basic test procedure was in accordance with ANSI C63.4:2009 (section 12).

- a. The EUT was placed on the top of a rotating table 0.8 meters above the ground at a 10 meters Semi-anechoic chamber room. The table was rotated 360 degrees to determine the position of the highest radiation.
- b. The EUT was set 10 meters (below 1GHz) and 3 meters (above 1GHz) away from the interference-receiving antenna, which was mounted on the top of a variable-height antenna tower.
- c. The height of antenna is varied from one meter to four meters above the ground to determine the maximum value of the field strength. Both horizontal and vertical polarizations of the antenna are set to make the measurement. The bore sight should be used during the test above 1GHz.
- d. For each suspected emission, the EUT was arranged to its worst case and then the antenna was tuned to heights from 1 meter to 4 meters and the rotatable table was turned from 0 degrees to 360 degrees to find the maximum reading.
- e. The test-receiver system was set to quasi-peak detect function and specified bandwidth with maximum hold mode when the test frequency is below 1 GHz.
- f. The test receiver/spectrum was set to peak and average detect function and specified bandwidth with maximum hold mode when the test frequency is above 1 GHz.

NOTE:

1. The resolution bandwidth of test receiver/spectrum analyzer is 120kHz for Quasi-peak detection (QP) at frequency below 1GHz.
2. The resolution bandwidth is 1MHz and video bandwidth of test receiver/spectrum analyzer is 3MHz for Peak detection at frequency above 1GHz. The resolution bandwidth of test receiver/spectrum analyzer is 1 MHz and video bandwidth of test receiver/spectrum analyzer is 3MHz for Average detection (AV) at frequency above 1GHz.
3. For measurement of frequency above 1000 MHz, the EUT was set 3 meters away from the receiver antenna.
4. Emission level(dBuV/m)=Raw Value(dBuV) + Correction Factor(dB/m)
5. Correction Factor(dB/m) = Antenna Factor (dB/m) + Cable Factor (dB) (if the raw value not contains the amplifier);
6. Correction Factor(dB/m) = Antenna Factor (dB/m) + Cable Factor (dB) – Amplifier Gain(dB) (if the raw value contains the amplifier)
7. Margin value = Emission level – Limit value.

2.2.4 DEVIATION FROM TEST STANDARD

No deviation.



2.2.5 TEST SETUP

<Frequency Range below 1GHz>

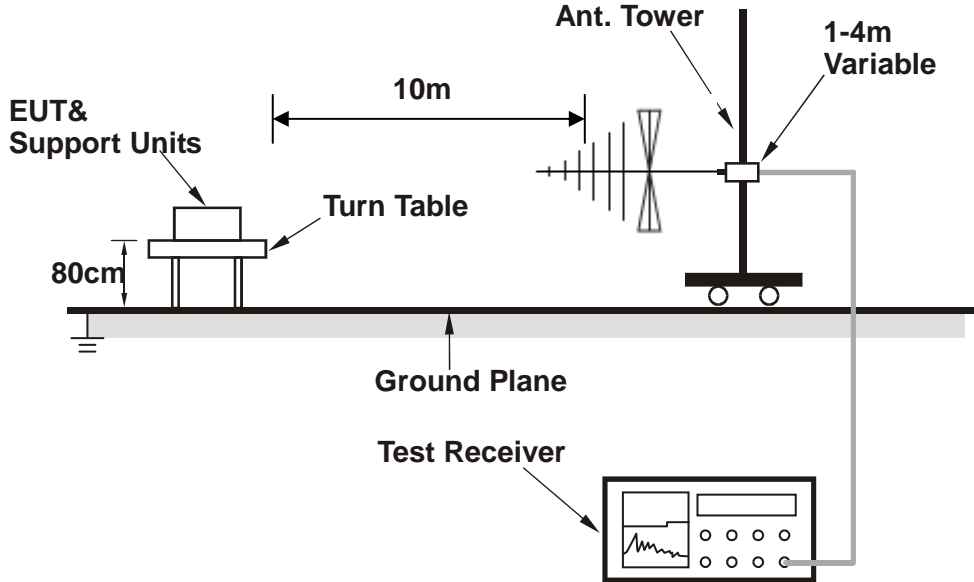

<Frequency Range above 1GHz>

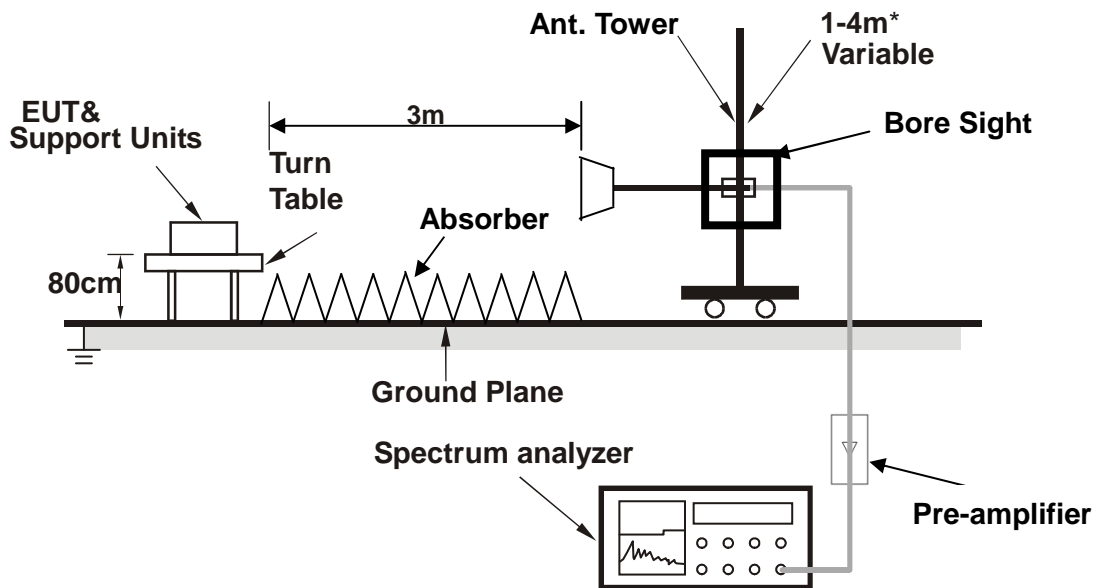

* : depends on the EUT height and the antenna 3dB beamwidth both, refer to section 7.3 of CISPR 16-2-3.

2.2.6 EUT OPERATING CONDITIONS

Same as item 2.1.6.



2.2.7 TEST RESULTS

TEST VOLTAGE	AC 120V/60Hz	FREQUENCY RANGE	30-1000 MHz
ENVIRONMENTAL CONDITIONS	22deg. C, 60 %RH	DETECTOR FUNCTION & BANDWIDTH	Quasi-Peak , 120 kHz
TESTED BY	Cheng Zhong		

ANTENNA POLARITY & TEST DISTANCE: HORIZONTAL AT 10 M								
No.	Freq. (MHz)	Correction Factor (dB/m)	Raw Value (dBuV)	Emission Level (dBuV/m)	Limit (dBuV/m)	Margin (dB)	Antenna Height (cm)	Table Angle (Degree)
1	31.39	-15.27	37.07	21.80	30.00	-8.20	400	56
2	47.46	-14.30	37.55	23.25	30.00	-6.75	400	293
3	64.92	-15.41	34.30	18.89	30.00	-11.11	400	218
4	142.52	-14.35	31.89	17.54	30.00	-12.46	400	111
5	179.38	-14.59	36.11	21.52	30.00	-8.48	400	132
6	262.80	-13.51	31.72	18.21	37.00	-18.79	400	24

- REMARKS:**
1. Peak detector quick scan is showed on the graph and final quasi-peak detector data is measured corresponding to relevant limit and recorded in the data table.
 2. Negative sign (-) in the margin column signify levels below the limit.
 3. Frequency range scanned: 30MHz to 1000MHz.
 4. Only emissions significantly above equipment noise floor are reported.

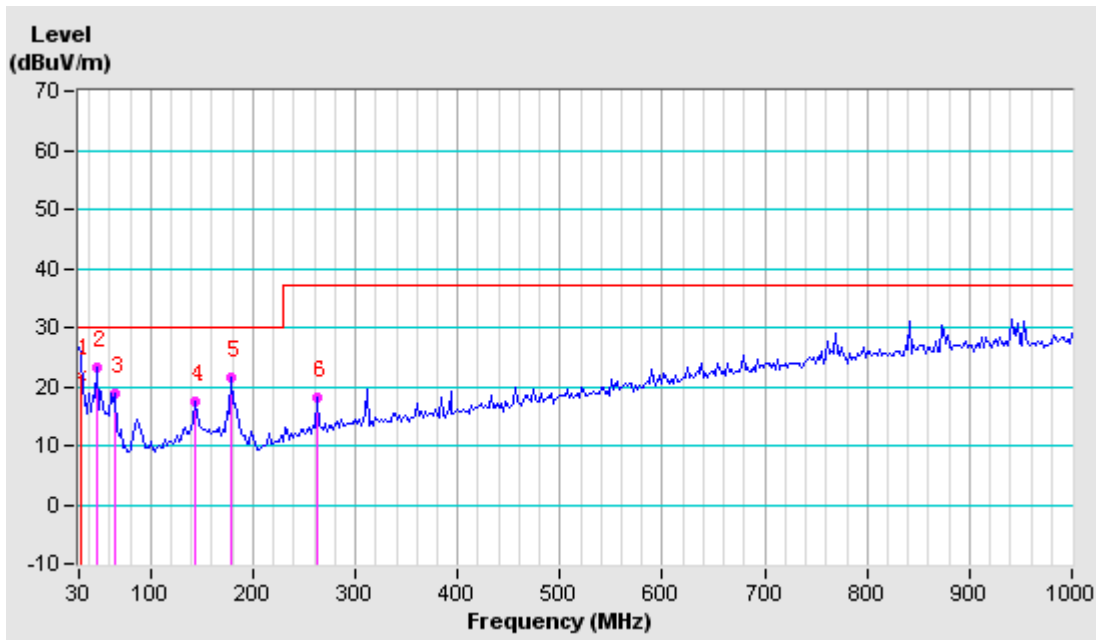



TEST VOLTAGE	AC 120V/60Hz	FREQUENCY RANGE	30-1000 MHz
ENVIRONMENTAL CONDITIONS	22deg. C, 60 %RH	DETECTOR FUNCTION & BANDWIDTH	Quasi-Peak , 120 kHz
TESTED BY	Cheng Zhong		

ANTENNA POLARITY & TEST DISTANCE: VERTICAL AT 10 M								
No.	Freq. (MHz)	Correction Factor (dB/m)	Raw Value (dBuV)	Emission Level (dBuV/m)	Limit (dBuV/m)	Margin (dB)	Antenna Height (cm)	Table Angle (Degree)
1	33.88	-14.50	34.70	20.20	30.00	-9.80	100	118
2	165.80	-12.25	27.20	14.95	30.00	-15.05	100	358
3	262.80	-11.38	33.44	22.06	37.00	-14.94	100	266
4	311.30	-9.69	32.41	22.72	37.00	-14.28	100	277
5	383.08	-8.06	29.79	21.73	37.00	-15.27	100	122
6	627.52	-2.26	27.44	25.18	37.00	-11.82	100	338

- REMARKS:**
1. Peak detector quick scan is showed on the graph and final quasi-peak detector data is measured corresponding to relevant limit and recorded in the data table.
 2. Negative sign (-) in the margin column signify levels below the limit.
 3. Frequency range scanned: 30MHz to 1000MHz.
 4. Only emissions significantly above equipment noise floor are reported.

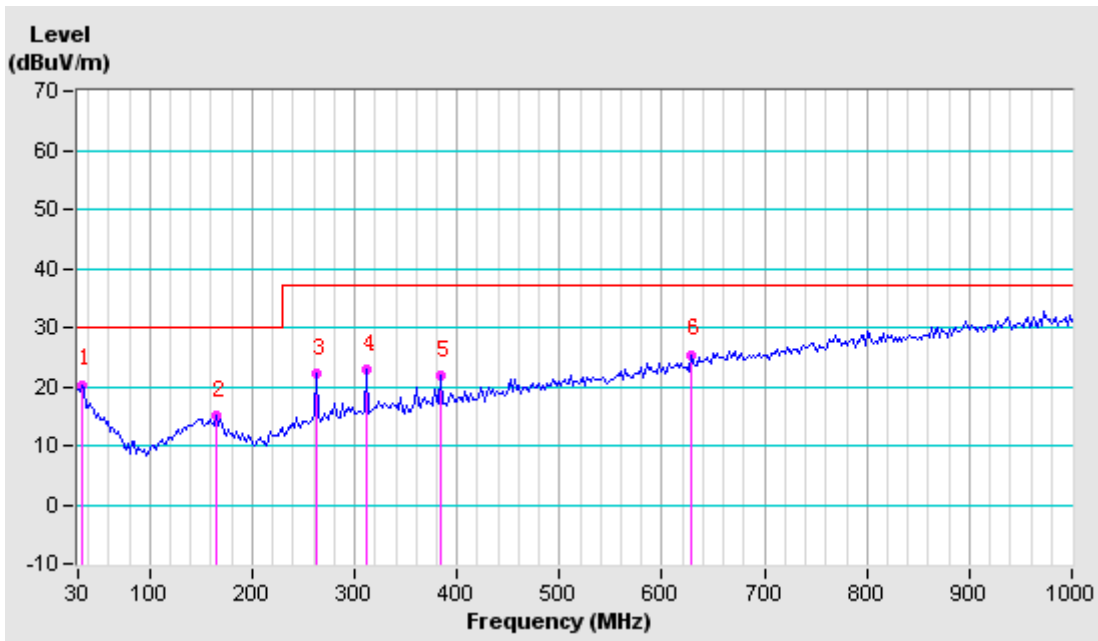



TEST VOLTAGE	AC 120V/60Hz	FREQUENCY RANGE	1-6 GHz
ENVIRONMENTAL CONDITIONS	22deg. C, 60 %RH	DETECTOR FUNCTION & BANDWIDTH	Peak/Average, 1 MHz
TESTED BY	Cheng Zhong		

ANTENNA POLARITY & TEST DISTANCE: HORIZONTAL AT 10 M								
No.	Freq. (MHz)	Correction Factor (dB/m)	Raw Value (dBuV)	Emission Level (dBuV/m)	Limit (dBuV/m)	Margin (dB)	Antenna Height (cm)	Table Angle (Degree)
1	1350 PK	-12.54	68.48	55.94	74.00	-18.06	140	130
2	1350 AV	-12.54	36.05	23.51	54.00	-30.49	140	130
3	4250 PK	-2.80	56.10	53.30	74.00	-20.70	100	205
4	4250 AV	-2.80	22.70	19.90	54.00	-34.10	100	205
5	5610 PK	-0.58	54.68	54.10	74.00	-19.90	180	235
6	5610 AV	-0.58	26.28	25.70	54.00	-28.30	180	235

ANTENNA POLARITY & TEST DISTANCE: VERTICAL AT 10 M								
No.	Freq. (MHz)	Correction Factor (dB/m)	Raw Value (dBuV)	Emission Level (dBuV/m)	Limit (dBuV/m)	Margin (dB)	Antenna Height (cm)	Table Angle (Degree)
1	1370 PK	-12.49	66.69	54.20	74.00	-19.80	150	110
2	1370 AV	-12.49	34.39	21.90	54.00	-32.10	150	110
3	3900 PK	-3.60	58.70	55.10	74.00	-18.90	130	180
4	3900 AV	-3.60	27.00	23.40	54.00	-30.60	130	180
5	5520 PK	-0.81	54.61	53.80	74.00	-20.20	220	210
6	5520 AV	-0.81	24.51	23.70	54.00	-30.30	220	210

- REMARKS:**
1. Peak detector quick scan is showed on the graph and final quasi-peak detector data is measured corresponding to relevant limit and recorded in the data table.
 2. Negative sign (-) in the margin column signify levels below the limit.
 3. Frequency range scanned: 1GHz to 6GHz.
 4. Only emissions significantly above equipment noise floor are reported.



**BUREAU
VERITAS**

Test Report No.: FV150714N019

3 APPENDIX A – MODIFICATIONS RECORDERS FOR ENGINEERING CHANGES TO THE EUT BY THE LAB

No any modifications were made to the EUT by the lab during the test.

---END---