



FCC Test Report

APPLICANT : Corporativo Lanix S.A. de C.V.
EQUIPMENT : Mobile phone
BRAND NAME : LANIX
MODEL NAME : Ilium S130
MARKETING NAME : Ilium S130
FCC ID : ZC4S130
STANDARD : FCC 47 CFR FCC Part 15 Subpart B
CLASSIFICATION : Certification

The product was received on Jun. 05, 2014 and testing was completed on Jun. 27, 2014. We, SPORTON INTERNATIONAL (SHENZHEN) INC., would like to declare that the tested sample has been evaluated in accordance with the test procedures given in ANSI C63.4-2003 and has been in compliance with the applicable technical standards.

The test results in this report apply exclusively to the tested model / sample. Without written approval of SPORTON INTERNATIONAL (SHENZHEN) INC., the test report shall not be reproduced except in full.

Reviewed by: Louis Wu / Manager

Approved by: Jones Tsai / Manager

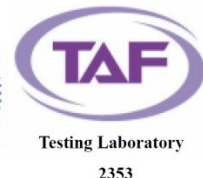

SPORTON INTERNATIONAL (SHENZHEN) INC.

No. 3 Building, the third floor of south, Shahe River west, Fengzeyuan warehouse, Nanshan District, Shenzhen, Guangdong, P.R.C.



TABLE OF CONTENTS

REVISION HISTORY.....	3
SUMMARY OF TEST RESULT	4
1. GENERAL DESCRIPTION	5
1.1. Applicant.....	5
1.2. Manufacturer	5
1.3. Feature of Equipment Under Test.....	5
1.4. Product Specification of Equipment Under Test	6
1.5. Modification of EUT.....	7
1.6. Test Site	7
1.7. Applied Standards	7
2. TEST CONFIGURATION OF EQUIPMENT UNDER TEST.....	8
2.1. Test Mode	8
2.2. Connection Diagram of Test System	10
2.3. Support Unit used in test configuration and system.....	11
2.4. EUT Operation Test Setup.....	11
3. TEST RESULT.....	12
3.1. Test of AC Conducted Emission Measurement	12
3.2. Test of Radiated Emission Measurement	18
4. LIST OF MEASURING EQUIPMENT	24
5. UNCERTAINTY OF EVALUATION	25
APPENDIX A. SETUP PHOTOGRAPHS	



REVISION HISTORY

REPORT NO.	VERSION	DESCRIPTION	ISSUED DATE
FC460504	Rev. 01	Initial issue of report	Jun. 30, 2014



SUMMARY OF TEST RESULT

Report Section	FCC Rule	Description	Limit	Result	Remark
3.1	15.107	AC Conducted Emission	< 15.107 limits	PASS	Under limit 13.79 dB at 4.200 MHz
3.2	15.109	Radiated Emission	< 15.109 limits	PASS	Under limit 2.02 dB at 31.620 MHz for Quasi-Peak



1. General Description

1.1. Applicant

Corporativo Lanix S.A. de C.V.

Carretera Internacional Hermosillo-Nogales Km 8.5, Hermosillo Sonora, Mexico

1.2. Manufacturer

Tinno Mobile Technology Corp.

4/F, H-3 Building, OCT Eastern industrial Park, No.1 XiangShan East Rd., Nan Shan District, Shenzhen, P. R. China

1.3. Product Feature of Equipment Under Test

Product Feature	
Equipment	Mobile phone
Brand Name	LANIX
Model Name	Ilium S130
Marketing Name	Ilium S130
FCC ID	ZC4S130
EUT supports Radios application	GSM/GPRS/EGPRS/WCDMA/HSPA/HSPA+(Downlink Only) WLAN 2.4GHz 802.11b/g/n HT20/HT40 Bluetooth v3.0 + EDR/Bluetooth v4.0 LE
HW Version	V1.1
SW Version	S4011AP_PR1_00_05
EUT Stage	Identical Prototype

Remark: The above EUT's information was declared by manufacturer. Please refer to the specifications or user's manual for more detailed description.



1.4. Product Specification subjective to this standard

Product Specification subjective to this standard	
Tx Frequency	GSM850 : 824.2 MHz ~ 848.8 MHz GSM1900 : 1850.2 MHz ~ 1909.8MHz WCDMA Band V : 826.4 MHz ~ 846.6 MHz WCDMA Band II : 1852.4 MHz ~ 1907.6 MHz 802.11b/g/n: 2412 MHz ~ 2462 MHz Bluetooth: 2402 MHz ~ 2480 MHz
Rx Frequency	GSM850 : 869.2 MHz ~ 893.8 MHz GSM1900 : 1930.2 MHz ~ 1989.8 MHz WCDMA Band V : 871.4 MHz ~ 891.6 MHz WCDMA Band II : 1932.4 MHz ~ 1987.6 MHz 802.11b/g/n: 2412 MHz ~ 2462 MHz Bluetooth: 2402 MHz ~ 2480 MHz GPS : 1.57542 GHz
Antenna Type	WWAN : Monopole Antenna WLAN : PIFA Antenna Bluetooth : PIFA Antenna GPS : PIFA Antenna
Type of Modulation	GSM: GMSK GPRS: GMSK EDGE(MCS 0-4): GMSK / (MCS 5-9): 8PSK WCDMA: QPSK (Uplink) HSDPA: QPSK (Uplink) HSUPA: QPSK (Uplink) HSPA+: 16QAM (Downlink Only) 802.11b : DSSS (DBPSK / DQPSK / CCK) 802.11g/n : OFDM (BPSK / QPSK / 16QAM / 64QAM) Bluetooth v4.0 LE : GFSK Bluetooth v3.0 EDR : GFSK, $\pi/4$ -DQPSK, 8-DPSK GPS : BPSK



1.5. Modification of EUT

No modifications are made to the EUT during all test items.

1.6. Test Location

Test Site	SPORTON INTERNATIONAL (SHENZHEN) INC.		
Test Site Location	No. 3 Building, the third floor of south, Shahe River west, Fengzeyuan warehouse, Nanshan District, Shenzhen, Guangdong, P.R.C. TEL: +86-755- 3320-2398		
Test Site No.	Sporton Site No.		FCC Registration No.
	CO01-SZ	03CH01-SZ	831040

1.7. Applicable Standards

According to the specifications of the manufacturer, the EUT must comply with the requirements of the following standards:

- ♦ FCC 47 CFR FCC Part 15 Subpart B
- ♦ ANSI C63.4-2003

Remark: All test items were verified and recorded according to the standards and without any deviation during the test.

2. Test Configuration of Equipment Under Test

2.1. Test Mode

The EUT has been associated with peripherals pursuant to ANSI C63.4-2003 and configuration operated in a manner tended to maximize its emission characteristics in a typical application.

Frequency range investigated: conduction (150 kHz to 30 MHz), radiation (30MHz to the 5th harmonic of the highest fundamental frequency or to 40 GHz, whichever is lower).

The following tables are showing the test modes as the worst cases and recorded in this report.

Item	EUT Configuration	Test Condition		
		EMI AC	EMI RE<1G	EMI RE≥1G
1.	Charging Mode (EUT with adapter)	☒	☒	☒
2.	Data application transferred mode (EUT connected with notebook)	☒	☒	☒

Abbreviations:

- EMI AC: AC conducted emissions
- EMI RE ≥ 1G: EUT radiated emissions ≥ 1GHz
- EMI RE < 1G: EUT radiated emissions < 1GHz

Test Items	EUT Configure Mode	Function Type
AC Conducted Emission	1/2	Mode 1: GSM850 Idle + Bluetooth Idle + WLAN Idle + USB Cable (Charging from Adapter) + Earphone + Camera <Fig. 1> Mode 2: GSM1900 Idle + Bluetooth Idle + WLAN Idle + USB Cable (Charging from Adapter) + Earphone + MPEG4 <Fig. 1> Mode 3: WCDMA Band V Idle + Bluetooth Idle + WLAN Idle + USB Cable (Data Link with Notebook) + Earphone + GPS Rx <Fig. 2>
Radiated Emissions < 1GHz	1/2	Mode 1: GSM850 Idle + Bluetooth Idle + WLAN Idle + USB Cable (Charging from Adapter) + Earphone + Camera <Fig. 1> Mode 2: GSM1900 Idle + Bluetooth Idle + WLAN Idle + USB Cable (Charging from Adapter) + Earphone + MPEG4 <Fig. 1> Mode 3: WCDMA Band V Idle + Bluetooth Idle + WLAN Idle + USB Cable (Data Link with Notebook) + Earphone + GPS Rx <Fig. 2>
Radiated Emissions ≥ 1GHz	1/2	Mode 1: GSM850 Idle + Bluetooth Idle + WLAN Idle + USB Cable (Charging from Adapter) + Earphone + Camera <Fig. 1> Mode 2: WCDMA Band V Idle + Bluetooth Idle + WLAN Idle + USB Cable (Data Link with Notebook) + Earphone + GPS Rx <Fig. 2>

Remark:

1. The worst case of AC is mode 1, and the USB Link mode of AC is mode 3, the test data of these modes are reported.
2. The worst case of RE < 1G is mode 1, and the USB Link mode of RE is mode 3, the test data of these modes are reported.
3. Link with Notebook means data application transferred mode between EUT and Notebook.

2.2. Connection Diagram of Test System

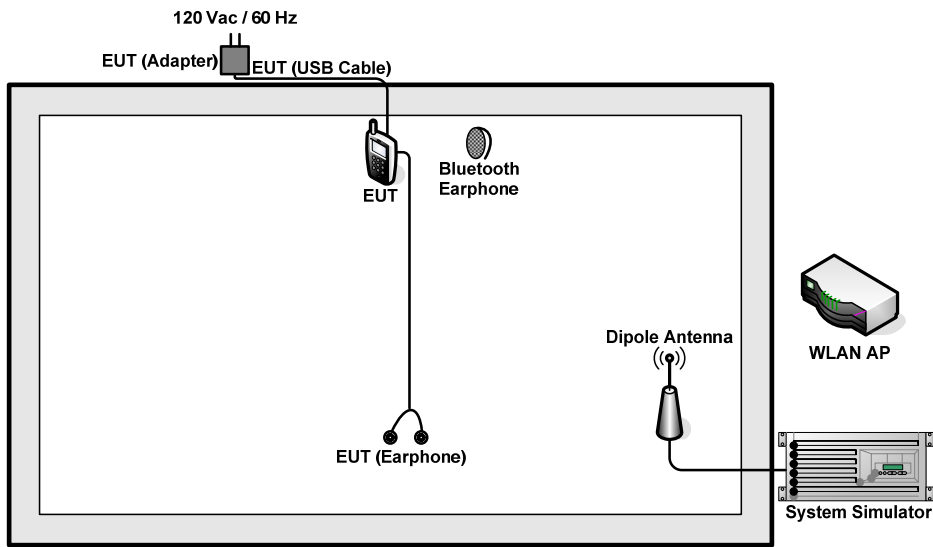

<Fig. 1>

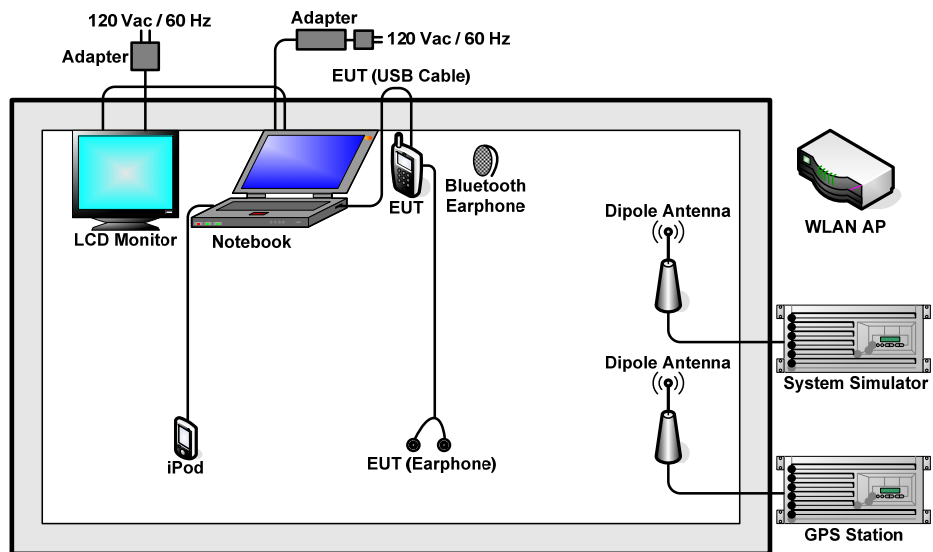

<Fig. 2>

2.3. Support Unit used in test configuration and system

Item	Equipment	Trade Name	Model Name	FCC ID	Data Cable	Power Cord
1.	System Simulator	R&S	CMW 500	N/A	N/A	Unshielded, 1.8 m
2.	System Simulator	Agilent	E5515C	N/A	N/A	Unshielded, 1.8 m
3.	GPS Station	T&E	GS50	N/A	N/A	Unshielded, 1.8 m
4.	GPS Station	ADIVIC	MP9000	N/A	N/A	Unshielded, 1.8 m
5.	WLAN AP	D-link	DIR-628	KA2DIR628A2	N/A	Unshielded, 1.8m
6.	WLAN AP	D-link	DIR-615	N/A	N/A	Unshielded, 1.8m
7.	Bluetooth Earphone	Nokia	BH-108	PYAHS-107W	N/A	N/A
8.	Notebook	Lenovo	G480	FCC DoC	N/A	AC I/P: Unshielded, 1.2m DC O/P: Shielded, 1.8 m
9.	Notebook	Lenovo	E540	FCC DoC	N/A	AC I/P: Unshielded, 1.2m DC O/P: Shielded, 1.8 m
10.	LCD Monitor	DELL	IN1940MWb	FCC DoC	Shielded, 1.6 m	Unshielded, 1.8 m
11.	SD Card	SanDisk	4G class 4	FCC DoC	N/A	N/A
12.	iPod nano 8GB	Apple	MC690 ZP/A	FCC DoC	Shielded, 1.2 m	N/A
13.	iPod	Apple	MC525 ZP/A	FCC DoC	Shielded, 1.0 m	N/A

2.4. EUT Operation Test Setup

The EUT was in GSM or WCDMA idle mode during the testing. The EUT was synchronized to the BCCH, and was in continuous receiving mode by setting system simulator's paging reorganization.

At the same time, the EUT was attached to the Bluetooth earphone or WLAN AP, and the following programs installed in the EUT were programmed during the test.

1. Execute the program, "Winthrax" under WIN7 installed in notebook for files transfer with EUT via USB cable.
2. Execute "GPS Test" to make the EUT receive continuous signals from GPS station.
3. Execute "Windows Media Player" to play MPEG4 files.
4. Turn on camera to capture images.

3. Test Result

3.1. Test of AC Conducted Emission Measurement

3.1.1 Limits of AC Conducted Emission

For equipment that is designed to be connected to the public utility (AC) power line, the radio frequency voltage that is conducted back onto the AC power line on any frequency or frequencies within the band 150 kHz to 30 MHz shall not exceed the limits in the following table.

Frequency of emission (MHz)	Conducted limit (dBuV)	
	Quasi-peak	Average
0.15-0.5	66 to 56*	56 to 46*
0.5-5	56	46
5-30	60	50

*Decreases with the logarithm of the frequency.

3.1.2 Measuring Instruments

The measuring equipment is listed in the section 4 of this test report.

3.1.3 Test Procedure

1. The EUT was placed 0.4 meter from the conducting wall of the shielding room was kept at least 80 centimeters from any other grounded conducting surface.
2. Connect EUT to the power mains through a line impedance stabilization network (LISN).
3. All the support units are connecting to the other LISN.
4. The LISN provides 50 ohm coupling impedance for the measuring instrument.
5. The FCC states that a 50 ohm, 50 microhenry LISN should be used.
6. Both sides of AC line were checked for maximum conducted interference.
7. The frequency range from 150 kHz to 30 MHz was searched.
8. Set the test-receiver system to Peak Detect Function and specified bandwidth with Maximum Hold Mode.

3.1.4 Test Setup





3.1.5 Test Result of AC Conducted Emission

Test Mode :	Mode 1	Temperature :	21~22°C
Test Engineer :	Jack Tian	Relative Humidity :	41~42%
Test Voltage :	120Vac / 60Hz	Phase :	Line
Function Type :	GSM850 Idle + Bluetooth Idle + WLAN Idle + USB Cable (Charging from Adapter) + Earphone + Camera		

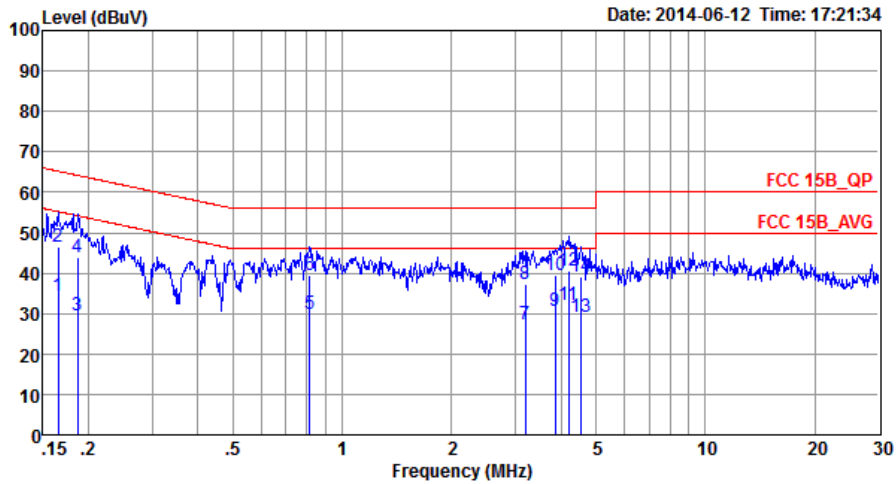

Site : CO01-SZ
 Condition: FCC 15B_QP LISN_L_20140304 LINE
 Project : (FC)460504
 Mode : Mode 1

	Freq	Level	Over Limit	Limit Line	Read Level	LISN Factor	Cable Loss	Remark
	MHz	dBuV	dB	dBuV	dBuV	dB	dB	
1	0.17	34.46	-20.75	55.21	23.90	0.22	10.34	Average
2	0.17	46.46	-18.75	65.21	35.90	0.22	10.34	QP
3	0.19	29.63	-24.57	54.20	19.10	0.22	10.31	Average
4	0.19	43.93	-20.27	64.20	33.40	0.22	10.31	QP
5	0.81	29.96	-16.04	46.00	19.60	0.21	10.15	Average
6	0.81	39.66	-16.34	56.00	29.30	0.21	10.15	QP
7	3.19	27.24	-18.76	46.00	16.71	0.32	10.21	Average
8	3.19	37.24	-18.76	56.00	26.71	0.32	10.21	QP
9	3.86	30.49	-15.51	46.00	19.90	0.36	10.23	Average
10	3.86	39.49	-16.51	56.00	28.90	0.36	10.23	QP
11 *	4.20	32.21	-13.79	46.00	21.60	0.38	10.23	Average
12	4.20	40.51	-15.49	56.00	29.90	0.38	10.23	QP
13	4.53	29.13	-16.87	46.00	18.50	0.40	10.23	Average
14	4.53	38.93	-17.07	56.00	28.30	0.40	10.23	QP



Test Mode :	Mode 1	Temperature :	21~22°C
Test Engineer :	Jack Tian	Relative Humidity :	41~42%
Test Voltage :	120Vac / 60Hz	Phase :	Neutral
Function Type :	GSM850 Idle + Bluetooth Idle + WLAN Idle + USB Cable (Charging from Adapter) + Earphone + Camera		

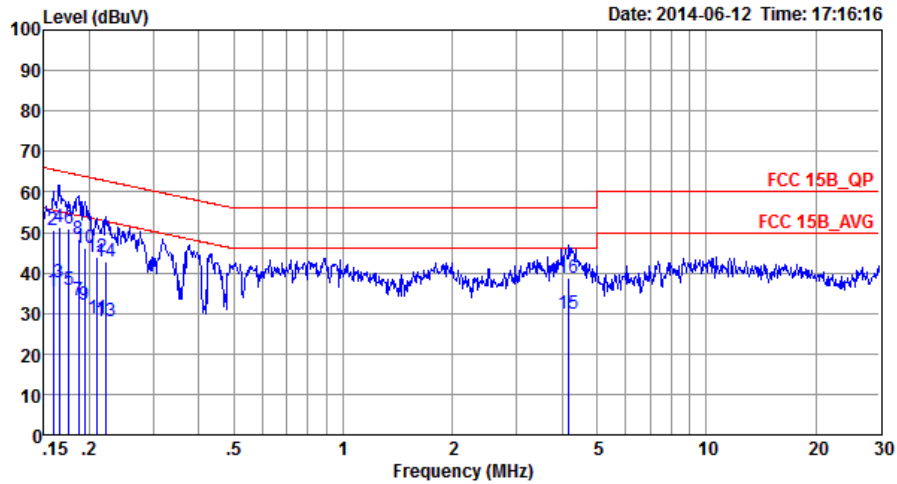

Site : CO01-SZ
 Condition: FCC 15B_QP LISN_N_20140304 NEUTRAL
 Project : (FC)460504
 Mode : Mode 1

	Freq	Level	Over Limit	Limit Line	Read Level	LISN Factor	Cable Loss	Remark
	MHz	dBuV	dB	dBuV	dBuV	dB	dB	
1	0.16	35.57	-19.95	55.52	24.89	0.33	10.35	Average
2	0.16	50.57	-14.95	65.52	39.89	0.33	10.35	QP
3	0.17	37.66	-17.55	55.21	26.99	0.33	10.34	Average
4	0.17	51.26	-13.95	65.21	40.59	0.33	10.34	QP
5	0.18	35.65	-19.03	54.68	25.01	0.32	10.32	Average
6 *	0.18	50.75	-13.93	64.68	40.11	0.32	10.32	QP
7	0.19	33.03	-21.17	54.20	22.40	0.32	10.31	Average
8	0.19	48.23	-15.97	64.20	37.60	0.32	10.31	QP
9	0.19	31.92	-21.92	53.84	21.30	0.32	10.30	Average
10	0.19	46.22	-17.62	63.84	35.60	0.32	10.30	QP
11	0.21	28.91	-24.27	53.18	18.30	0.33	10.28	Average
12	0.21	43.91	-19.27	63.18	33.30	0.33	10.28	QP
13	0.22	28.20	-24.54	52.74	17.60	0.33	10.27	Average
14	0.22	42.90	-19.84	62.74	32.30	0.33	10.27	QP
15	4.18	29.90	-16.10	46.00	19.20	0.47	10.23	Average
16	4.18	38.80	-17.20	56.00	28.10	0.47	10.23	QP



Test Mode :	Mode 3	Temperature :	21~22°C
Test Engineer :	Jack Tian	Relative Humidity :	41~42%
Test Voltage :	120Vac / 60Hz	Phase :	Line
Function Type :	WCDMA Band V Idle + Bluetooth Idle + WLAN Idle + USB Cable (Data Link with Notebook) + Earphone + GPS Rx		

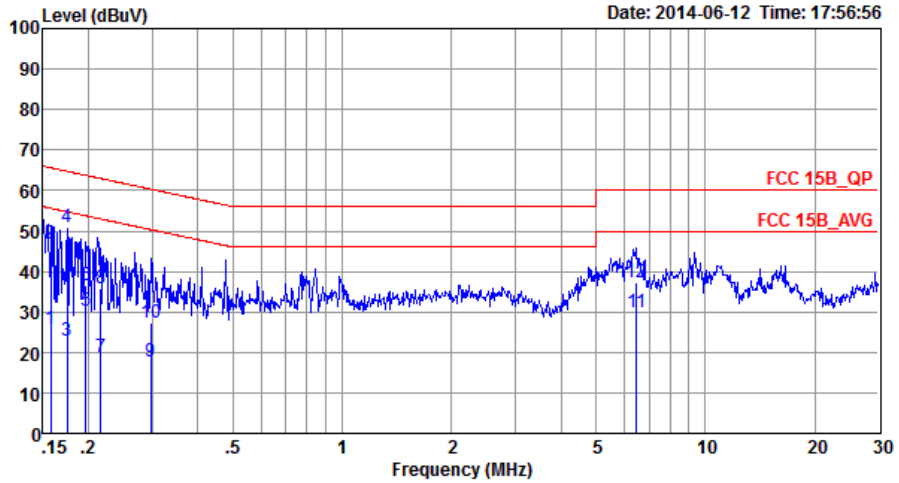

Site : CO01-SZ
 Condition: FCC 15B_QP LISN_L_20140304 LINE
 Project : (FC)460504
 Mode : Mode 3

	Freq	Level	Over	Limit	Read	LISN	Cable	
	MHz	dBuV	Limit	Line	Level	Factor	Loss	Remark
			dB	dBuV	dBuV	dB	dB	
1	0.16	25.67	-29.93	55.60	15.10	0.22	10.35	Average
2	0.16	46.87	-18.73	65.60	36.30	0.22	10.35	QP
3	0.17	23.04	-31.68	54.72	12.50	0.22	10.32	Average
4 *	0.17	50.74	-13.98	64.72	40.20	0.22	10.32	QP
5	0.20	30.32	-23.44	53.76	19.80	0.22	10.30	Average
6	0.20	36.42	-27.34	63.76	25.90	0.22	10.30	QP
7	0.22	18.80	-34.16	52.96	8.29	0.23	10.28	Average
8	0.22	35.70	-27.26	62.96	25.19	0.23	10.28	QP
9	0.30	17.56	-32.76	50.32	7.11	0.25	10.20	Average
10	0.30	27.46	-32.86	60.32	17.01	0.25	10.20	QP
11	6.45	29.86	-20.14	50.00	19.20	0.39	10.27	Average
12	6.45	37.26	-22.74	60.00	26.60	0.39	10.27	QP



Test Mode :	Mode 3	Temperature :	21~22°C
Test Engineer :	Jack Tian	Relative Humidity :	41~42%
Test Voltage :	120Vac / 60Hz	Phase :	Neutral
Function Type :	WCDMA Band V Idle + Bluetooth Idle + WLAN Idle + USB Cable (Data Link with Notebook) + Earphone + GPS Rx		

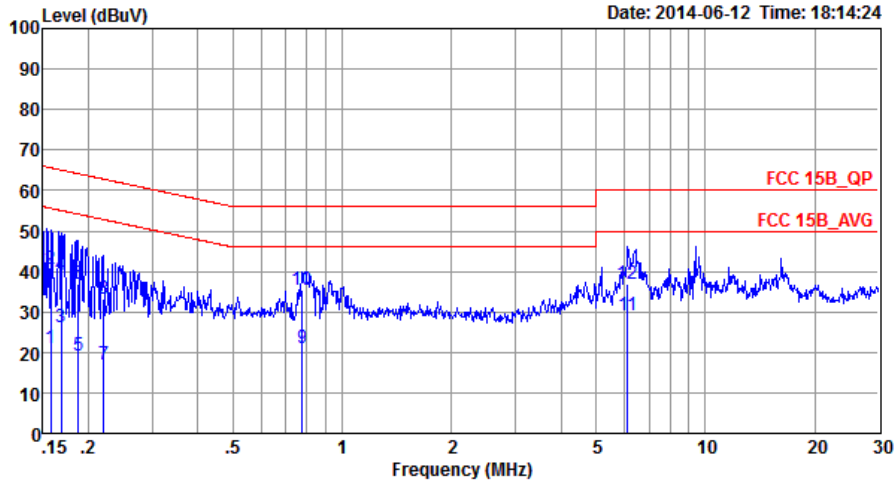

Site : CO01-SZ
 Condition: FCC 15B_QP LISN_N_20140304 NEUTRAL
 Project : (FC)460504
 Mode : Mode 3

	Freq	Level	Over	Limit	Read	LISN	Cable	
	MHz	dBuV	Limit	Line	Level	Factor	Loss	Remark
			dB	dBuV	dBuV	dB	dB	
1	0.16	21.18	-34.42	55.60	10.50	0.33	10.35	Average
2	0.16	40.68	-24.92	65.60	30.00	0.33	10.35	QP
3	0.17	26.06	-28.97	55.03	15.40	0.33	10.33	Average
4	0.17	39.16	-25.87	65.03	28.50	0.33	10.33	QP
5	0.19	19.23	-34.92	54.15	8.60	0.32	10.31	Average
6	0.19	36.83	-27.32	64.15	26.20	0.32	10.31	QP
7	0.22	17.00	-35.79	52.79	6.40	0.33	10.27	Average
8	0.22	33.30	-29.49	62.79	22.70	0.33	10.27	QP
9	0.78	21.12	-24.88	46.00	10.70	0.27	10.15	Average
10	0.78	35.32	-20.68	56.00	24.90	0.27	10.15	QP
11	6.12	29.02	-20.98	50.00	18.30	0.46	10.26	Average
12	6.12	36.92	-23.08	60.00	26.20	0.46	10.26	QP



3.2. Test of Radiated Emission Measurement

3.2.1. Limit of Radiated Emission

The emissions from an unintentional radiator shall not exceed the field strength levels specified in the following table:

Frequency (MHz)	Field Strength (microvolts/meter)	Measurement Distance (meters)
30 – 88	100	3
88 – 216	150	3
216 - 960	200	3
Above 960	500	3

3.2.2. Measuring Instruments

The measuring equipment is listed in the section 4 of this test report.

3.2.3. Test Procedures

1. The EUT was placed on a turntable with 0.8 meter above ground.
2. The EUT was set 3 meters from the interference receiving antenna, which was mounted on the top of a variable height antenna tower.
3. The table was rotated 360 degrees to determine the position of the highest radiation.
4. The antenna is a Bi-Log antenna and its height is adjusted between one to four meters above ground to find the maximum value of the field strength for both horizontal polarization and vertical polarization of the antenna.
5. For each suspected emission, the EUT was arranged to its worst case and then tune the antenna tower (from 1 m to 4 m) and turntable (from 0 degree to 360 degrees) to find the maximum reading.
6. Set the test-receiver system to Peak Detect Function and specified bandwidth with Maximum Hold Mode.
7. If the emission level of the EUT in peak mode was 3 dB lower than the limit specified, peak values of EUT will be reported. Otherwise, the emission will be repeated by using the quasi-peak method and reported.
8. Emission level (dBµV/m) = 20 log Emission level (µV/m)
9. Corrected Reading: Antenna Factor + Cable Loss + Read Level - Preamp Factor = Level

3.2.4. Test Setup of Radiated Emission

For radiated emissions from 30MHz to 1GHz

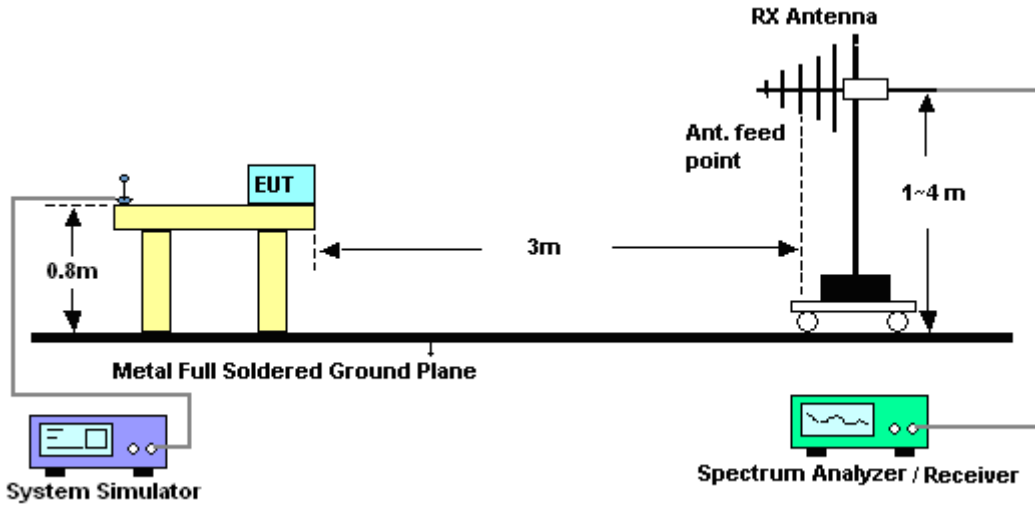

For radiated emissions above 1GHz

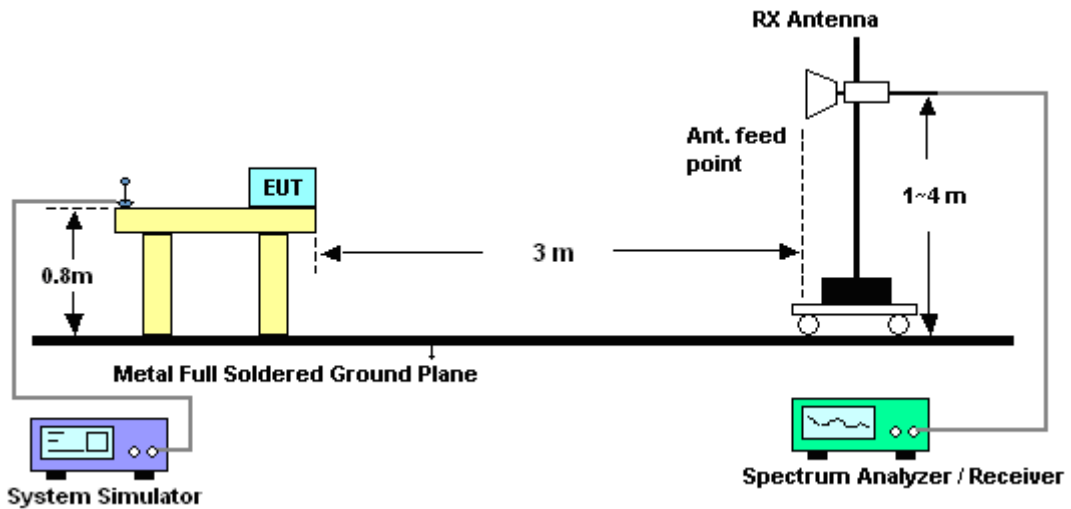



3.2.5. Test Result of Radiated Emission

Test Mode :	Mode 1	Temperature :	23~25°C
Test Engineer :	Gavin Zhang	Relative Humidity :	48~52%
Test Distance :	3m	Polarization :	Horizontal
Function Type :	GSM850 Idle + Bluetooth Idle + WLAN Idle + USB Cable (Charging from Adapter) + Earphone + Camera		
Remark :	#7 is system simulator signal which can be ignored.		

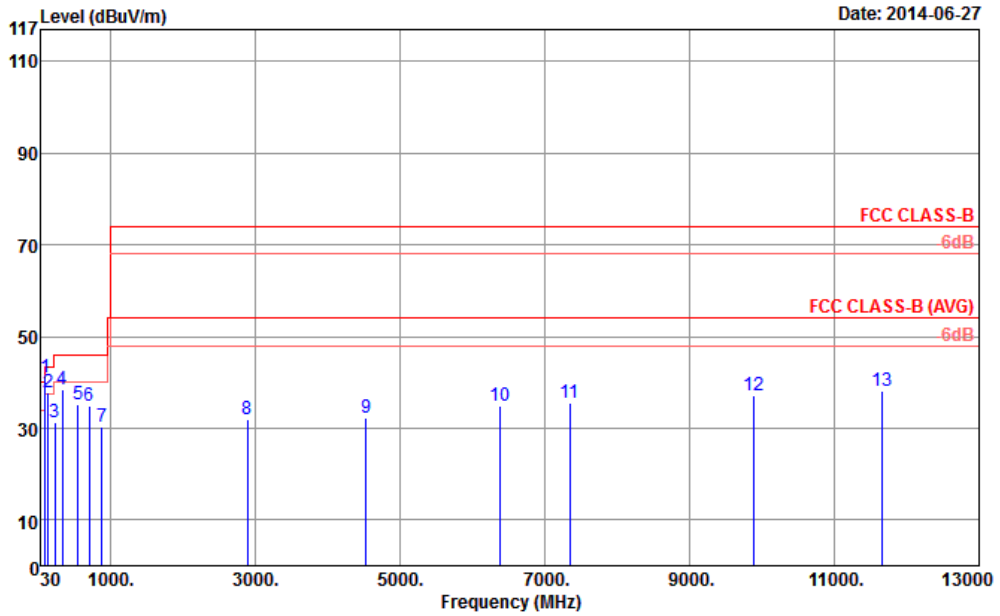

Site : 03CH01-SZ
 Condition : FCC CLASS-B 3m LF_ANT_131026 HORIZONTAL
 Project : (FC) 460504
 Mode : Mode 1

	Freq	Level	Over Limit	Limit Line	ReadAntenna Level	Antenna Factor	Cable Loss	Preamp Factor	A/Pos	T/Pos	Remark
	MHz	dBuV/m	dB	dBuV/m	dBuV	dB/m	dB	dB	cm	deg	
1	Q	101.82	41.01	-2.49	43.50	58.32	11.36	1.27	29.94	100	65 QP
2	P	140.16	37.94	-5.56	43.50	55.57	10.88	1.43	29.94	---	Peak
3		234.12	31.35	-14.65	46.00	48.71	10.76	1.81	29.93	---	Peak
4		337.80	38.40	-7.60	46.00	52.01	14.20	2.12	29.93	---	Peak
5		545.70	35.19	-10.81	46.00	44.49	17.98	2.64	29.92	---	Peak
6		701.80	35.00	-11.00	46.00	42.97	19.00	2.96	29.93	---	Peak
7		881.70	30.25			36.34	20.56	3.29	29.94	---	Peak
8		2886.00	32.07	-41.93	74.00	50.08	32.88	6.24	57.13	---	Peak
9		4530.00	32.29	-41.71	74.00	49.12	33.18	8.05	58.06	---	Peak
10		6376.00	34.72	-39.28	74.00	47.87	34.00	9.69	56.84	---	Peak
11		7346.00	35.51	-38.49	74.00	48.73	33.91	10.01	57.14	---	Peak
12		9896.00	37.16	-36.84	74.00	45.95	36.86	12.49	58.14	---	Peak
13		11658.00	38.19	-35.81	74.00	45.46	37.92	13.42	58.61	123	201 Peak



Test Mode :	Mode 1	Temperature :	23~25°C
Test Engineer :	Gavin Zhang	Relative Humidity :	48~52%
Test Distance :	3m	Polarization :	Vertical
Function Type :	GSM850 Idle + Bluetooth Idle + WLAN Idle + USB Cable (Charging from Adapter) + Earphone + Camera		
Remark :	#7 is system simulator signal which can be ignored.		

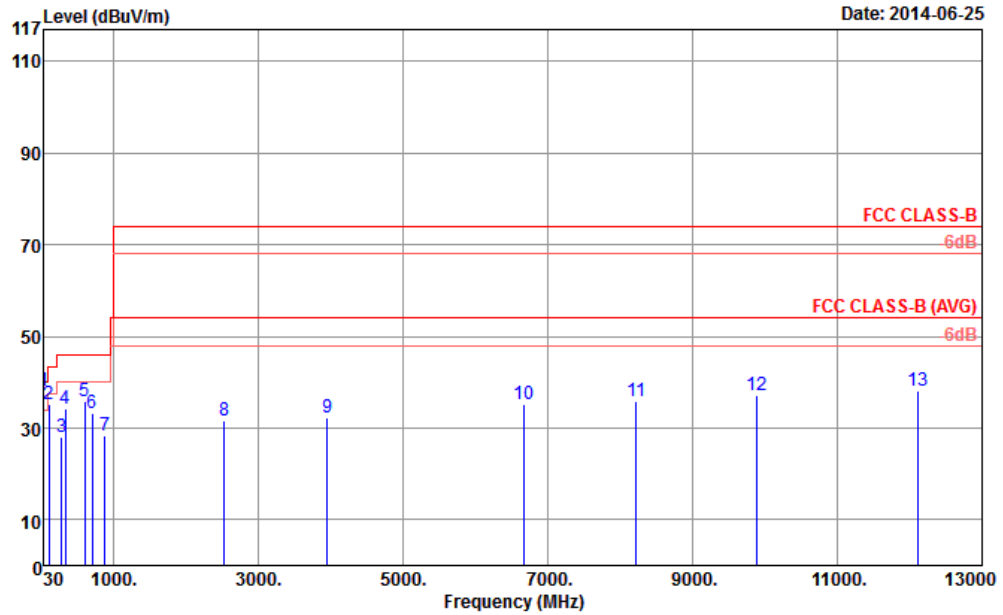

Site : 03CH01-SZ
 Condition : FCC CLASS-B 3m LF_ANT_131026 VERTICAL
 Project : (FC) 460504
 Mode : Mode 1

	Freq	Level	Over	Limit	ReadAntenna	Cable	Preamp	A/Pos	T/Pos	Remark
	MHz	dBuV/m	Limit	Line	Level	Loss	Factor	cm	deg	
			dB	dBuV/m	dBuV	dB/m	dB	dB		
1 Q	31.62	37.98	-2.02	40.00	49.23	17.90	0.78	29.93	100	154 QP
2 P	104.25	35.08	-8.42	43.50	52.13	11.60	1.29	29.94	---	Peak
3	285.96	28.06	-17.94	46.00	43.70	12.32	1.97	29.93	---	Peak
4	337.80	34.24	-11.76	46.00	47.85	14.20	2.12	29.93	---	Peak
5	598.20	35.90	-10.10	46.00	44.51	18.55	2.76	29.92	---	Peak
6	701.80	33.40	-12.60	46.00	41.37	19.00	2.96	29.93	---	Peak
7	881.70	28.25			34.34	20.56	3.29	29.94	---	Peak
8	2528.00	31.76	-42.24	74.00	50.48	32.53	5.77	57.02	---	Peak
9	3954.00	32.19	-41.81	74.00	50.52	33.10	7.58	59.01	---	Peak
10	6670.00	35.15	-38.85	74.00	48.54	33.90	9.85	57.14	---	Peak
11	8218.00	35.81	-38.19	74.00	46.60	35.30	10.85	56.94	---	Peak
12	9894.00	37.15	-36.85	74.00	45.94	36.86	12.49	58.14	---	Peak
13	12106.00	38.25	-35.75	74.00	44.64	38.14	13.66	58.19	100	360 Peak



Test Mode :	Mode 3	Temperature :	23~25°C
Test Engineer :	Gavin Zhang	Relative Humidity :	48~52%
Test Distance :	3m	Polarization :	Horizontal
Function Type :	WCDMA Band V Idle + Bluetooth Idle + WLAN Idle + USB Cable (Data Link with Notebook) + Earphone + GPS Rx		
Remark :	#7 is system simulator signal which can be ignored.		

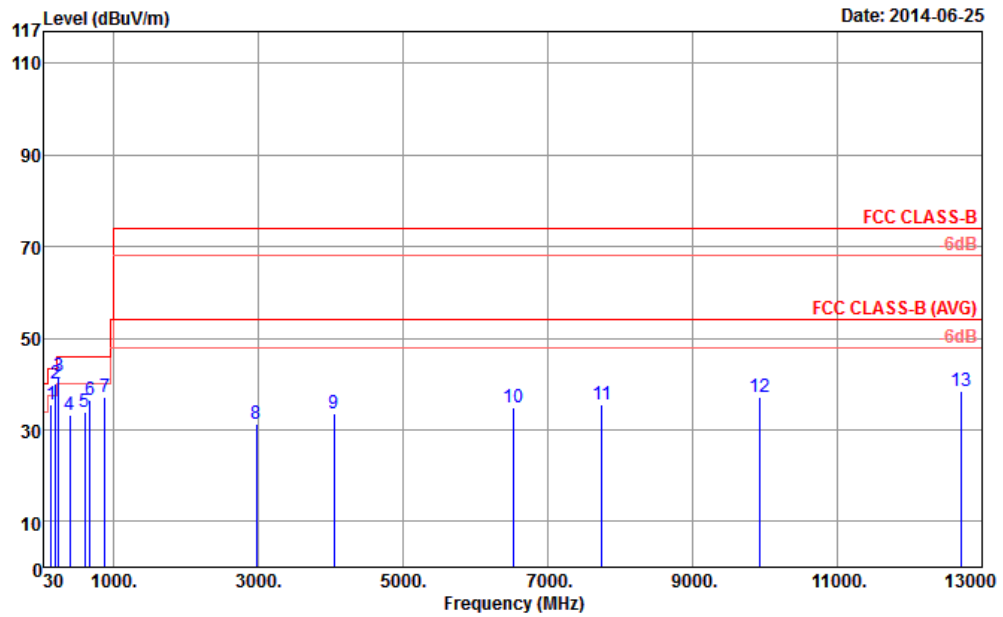

Site : 03CH01-SZ
 Condition : FCC CLASS-B 3m LF_ANT_131026 HORIZONTAL
 Project : (FC) 460504
 Mode : Mode 3

	Freq	Level	Over Limit	Limit Line	ReadAntenna Level	Antenna Factor	Cable Loss	Preamp Factor	A/Pos	T/Pos	Remark
	MHz	dBuV/m	dB	dBuV/m	dBuV	dB/m	dB	dB	cm	deg	
1	135.03	35.42	-8.08	43.50	52.40	11.55	1.41	29.94	---	---	Peak
2	199.83	40.16	-3.34	43.50	59.30	9.10	1.70	29.94	---	---	Peak
3	240.06	41.86	-4.14	46.00	58.62	11.35	1.82	29.93	100	357	QP
4	399.40	33.09	-12.91	46.00	44.83	15.90	2.29	29.93	---	---	Peak
5	599.60	33.86	-12.14	46.00	42.45	18.57	2.76	29.92	---	---	Peak
6	674.50	36.41	-9.59	46.00	44.93	18.50	2.91	29.93	---	---	Peak
7	881.66	37.11			43.20	20.56	3.29	29.94	---	---	Peak
8	2978.00	31.35	-42.65	74.00	49.16	32.97	6.37	57.15	---	---	Peak
9	4046.00	33.68	-40.32	74.00	51.88	33.10	7.68	58.98	---	---	Peak
10	6520.00	34.92	-39.08	74.00	48.08	33.99	9.84	56.99	---	---	Peak
11	7742.00	35.66	-38.34	74.00	47.60	34.45	10.36	56.75	---	---	Peak
12	9922.00	37.27	-36.73	74.00	45.96	36.90	12.54	58.13	---	---	Peak
13	12704.00	38.30	-35.70	74.00	43.89	38.26	14.27	58.12	100	230	Peak



Test Mode :	Mode 3	Temperature :	23~25°C
Test Engineer :	Gavin Zhang	Relative Humidity :	48~52%
Test Distance :	3m	Polarization :	Vertical
Function Type :	WCDMA Band V Idle + Bluetooth Idle + WLAN Idle + USB Cable (Data Link with Notebook) + Earphone + GPS Rx		
Remark :	#7 is system simulator signal which can be ignored.		

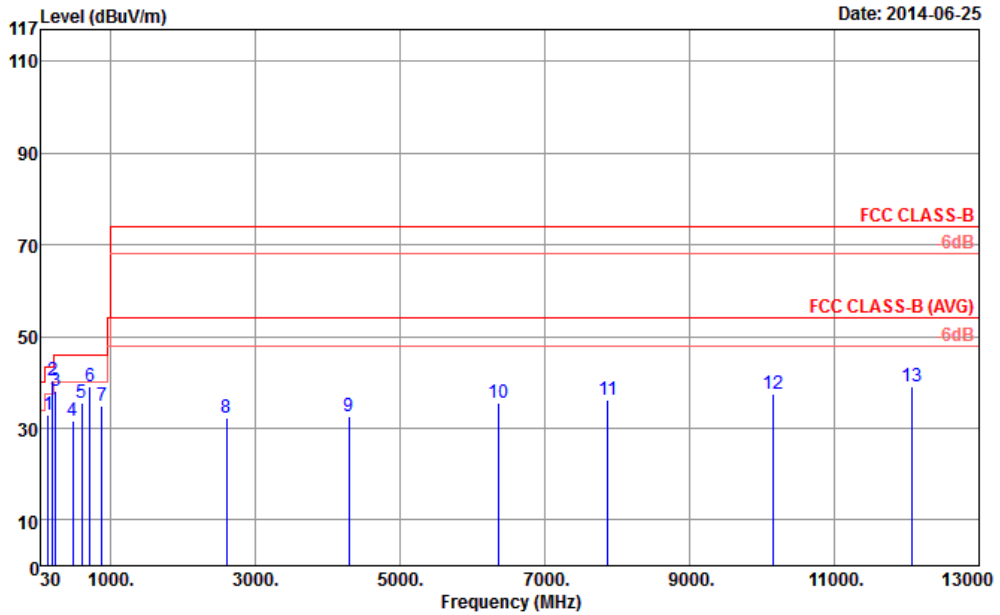

Site : 03CH01-SZ
 Condition : FCC CLASS-B 3m LF_ANT_131026 VERTICAL
 Project : (FC) 460504
 Mode : Mode 3

	Freq	Level	Over Limit	Limit Line	ReadAntenna Level	Antenna Factor	Cable Loss	Preamp Factor	A/Pos	T/Pos	Remark
	MHz	dBuV/m	dB	dBuV/m	dBuV	dB/m	dB	dB	cm	deg	
1	135.30	32.90	-10.60	43.50	49.99	11.44	1.41	29.94	---	---	Peak
2 P	199.83	40.48	-3.02	43.50	59.62	9.10	1.70	29.94	100	320	Peak
3	240.06	38.23	-7.77	46.00	54.99	11.35	1.82	29.93	---	---	Peak
4	479.90	31.56	-14.44	46.00	41.60	17.40	2.48	29.92	---	---	Peak
5	599.60	35.45	-10.55	46.00	44.04	18.57	2.76	29.92	---	---	Peak
6	720.00	39.26	-6.74	46.00	46.90	19.30	2.99	29.93	---	---	Peak
7	881.66	34.88			40.97	20.56	3.29	29.94	---	---	Peak
8	2604.00	32.19	-41.81	74.00	50.76	32.60	5.87	57.04	---	---	Peak
9	4298.00	32.49	-41.51	74.00	50.03	33.10	7.87	58.51	---	---	Peak
10	6356.00	35.45	-38.55	74.00	48.61	34.00	9.66	56.82	---	---	Peak
11	7874.00	36.06	-37.94	74.00	47.47	34.66	10.56	56.63	---	---	Peak
12	10158.00	37.37	-36.63	74.00	46.04	36.90	12.75	58.32	---	---	Peak
13	12070.00	39.16	-34.84	74.00	45.61	38.16	13.58	58.19	110	350	Peak



4. List of Measuring Equipment

Instrument	Manufacturer	Model No.	Serial No.	Characteristics	Calibration Date	Test Date	Due Date	Remark
ESCIO TEST Receiver	R&S	ESCI	100724	9kHz~3GHz	Feb. 21, 2014	Jun. 25, 2014~ Jun. 27, 2014	Feb. 20, 2015	Radiation (03CH01-SZ)
Spectrum Analyzer	Agilent Technologies	N9038A	MY522601 85	20Hz~26.5GHz	May 26, 2014	Jun. 25, 2014~ Jun. 27, 2014	May 25, 2015	Radiation (03CH01-SZ)
Loop Antenna	R&S	HFH2-Z2	100354	9kHz~30MHz	May 09, 2014	Jun. 25, 2014~ Jun. 27, 2014	May 08, 2015	Radiation (03CH01-SZ)
Bilog Antenna	TESEQ	CBL 6112D	23188	30MHz~2GHz	Oct. 26, 2013	Jun. 25, 2014~ Jun. 27, 2014	Oct. 25, 2014	Radiation (03CH01-SZ)
Double Ridge Horn Antenna	ETS Lindgren	3117	00119436	1GHz~18GHz	Oct. 26, 2013	Jun. 25, 2014~ Jun. 27, 2014	Oct. 25, 2014	Radiation (03CH01-SZ)
Double Ridged Horn Antenna	COM-POWER	AH-840	101073	18GHz~40GHz	Jan. 27, 2014	Jun. 25, 2014~ Jun. 27, 2014	Jan. 26, 2015	Radiation (03CH01-SZ)
Amplifier	ADVANTEST	BB525C	E9007003	9kHz~3000MHz	Feb. 21, 2014	Jun. 25, 2014~ Jun. 27, 2014	Feb. 20, 2015	Radiation (03CH01-SZ)
Amplifier	Yiai	AV3860B	04030	2GHz~26.5GHz	May 08, 2014	Jun. 25, 2014~ Jun. 27, 2014	May 07, 2015	Radiation (03CH01-SZ)
AC Source(AVR)	Chroma	61601	616010001 985	100Vac~250Vac	Mar. 25, 2014	Jun. 25, 2014~ Jun. 27, 2014	Mar. 24, 2015	Radiation (03CH01-SZ)
Turn Table	EM Electronics	EM 1000	N/A	0~360 degree	NCR	Jun. 25, 2014~ Jun. 27, 2014	NCR	Radiation (03CH01-SZ)
Antenna Mast	EM Electronics	EM 1000	N/A	1 m~4 m	NCR	Jun. 25, 2014~ Jun. 27, 2014	NCR	Radiation (03CH01-SZ)
ESCIO TEST Receiver	R&S	ESCI	100724	9kHz~3GHz	Feb. 21, 2014	Jun. 12, 2014	Feb. 20, 2015	Conduction (CO01-SZ)
AC LISN	EMCO	3816/2SH	00103912	9kHz~30MHz	Mar. 04, 2014	Jun. 12, 2014	Mar. 03, 2015	Conduction (CO01-SZ)
AC LISN (for auxiliary equipment)	EMCO	3816/2SH	00103892	9kHz~30MHz	Mar. 04, 2014	Jun. 12, 2014	Mar. 03, 2015	Conduction (CO01-SZ)
AC Power Source	Chroma	61602	616020000 891	100Vac~250Vac	Dec. 17, 2013	Jun. 12, 2014	Dec. 16, 2014	Conduction (CO01-SZ)



5. Uncertainty of Evaluation

Uncertainty of Conducted Emission Measurement (150 kHz ~ 30 MHz)

Measuring Uncertainty for a Level of Confidence of 95% ($U = 2Uc(y)$)	2.31
---	------

Uncertainty of Radiated Emission Measurement (30 MHz ~ 1000 MHz)

Measuring Uncertainty for a Level of Confidence of 95% ($U = 2Uc(y)$)	3.90
---	------