

Contents

Get Started	2
Install SIM Card	2
Insert Micro SD card	2
Charge Mobile Phone	3
PC-Phone File Transfer	4
Keys and Parts	5
Lock and Unlock the Screen	7
Notification Panel	8
Arranging and Rearranging Widgets and Icons	9
Adding Folders on your Screen	10
Adjusting Brightness	11
Changing your Wallpaper	12
Make a Call	13
Call Log	15
Reject a Call by Sending a Busy Message	16
Add a Contact	16
Messaging	17
Receiving a New Message.....	17
Editing SMS and MMS	17
Message conversations.....	17
Browse the Web	19
Enjoy Music	20
Download Applications on Google Play	21
Manage Applications	22
Maintenance & Safety	23

Get Started

Install SIM Card

You must insert the SIM card before using the phone.

-> Steps:

1. Switch off the mobile phone.
2. Insert the SIM card correctly in the card slot(s) (See figure below)

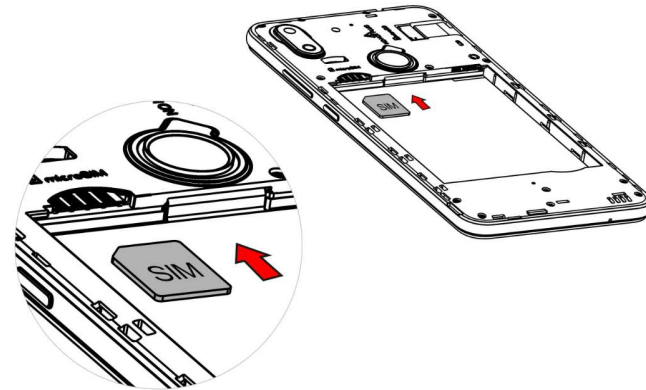

Insert Micro SD card

The phone supports Micro SD card, which is a multimedia memory card used to multiply the memory of the device. Please follow the instructions as above mentioned.

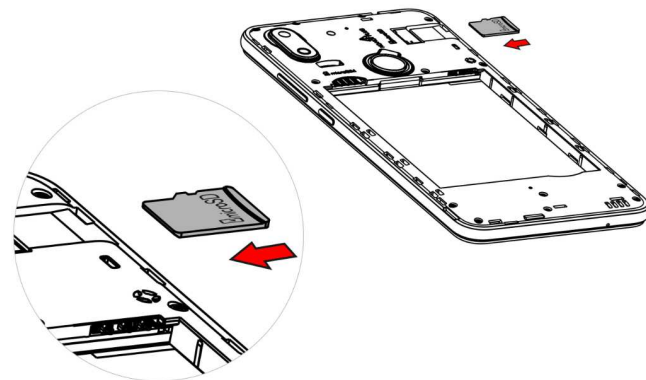

Charge Mobile Phone

Your phone is powered by a rechargeable battery. If your phone comes up a message which notifies you that the battery power is too low, at that moment, please recharge the battery, if the charge is too low, it may shorten the life of the battery.

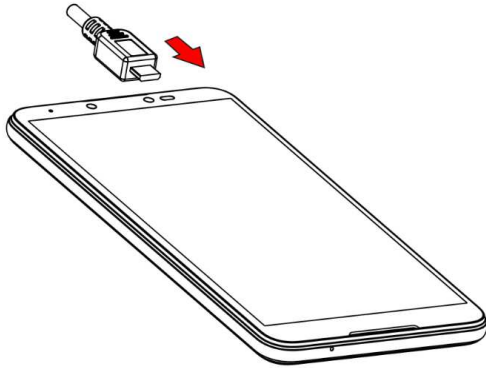

PC-Phone File Transfer

Once the mobile phone is connected to a PC with USB, the PC will charge the mobile phone automatically. In such case, *USB Computer connection* will appear on your screen.

1. Drag the notification panel down and tap *Connect as Media device*.
2. Select *Media device*.
3. The device is recognized as a Removable Disk by the computer. Open the folder and transfer or copy files from your phone to PC and vice-versa.

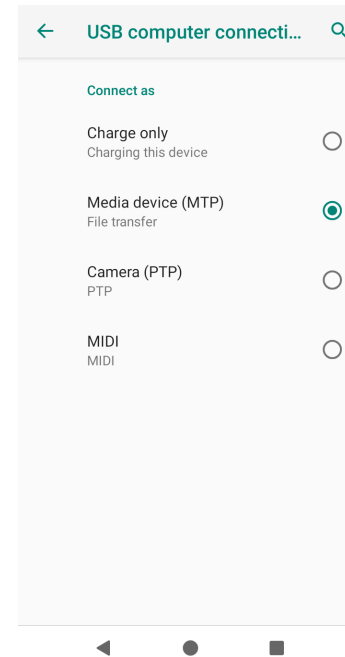

Keys and Parts

The phone gives you marvelous feelings to experience on Camera, Video recorder, FM radio, Music and Sound recorder. Let you install various APPs, games, and more (supports APK format) by downloading from Google Play™.



1.Volume Up/Down Key	To adjust the ringer volume, adjust the voice volume during a call and adjust media volume.
2.Headset port	To connect an earphone so you can listen to music or radio, etc.
3.Receiver	To hear the voice of the other side when calling.
4.Front Camera	Allow you to take pictures while facing the screen.
5.Power Key	Switch the phone on or off. Press and hold to open phone options menu.
6.Back Camera lens	For taking photos.
7.Flashlight	To take photos in low-light conditions.
8. USB jack	To connect charger or USB data cable for data exchange.
9.Fingerprint key	After you set fingerprint, you can use it to unlock the screen.

Lock and Unlock the Screen

Press power button to enter Sleep mode and meanwhile the screen will be locked; press power button again to wake up and then drag the lock icon upward to unlock.

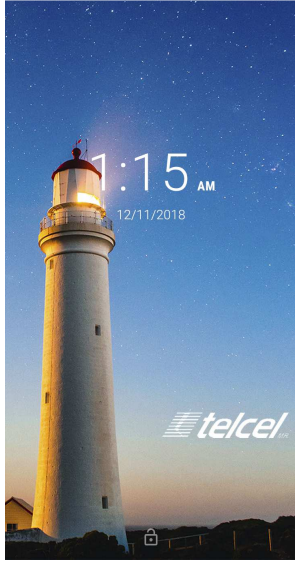

Notification Panel

Notification icons on the status bar report the new arrival of messages, calendar events, alarm set and ongoing settings such as when call forwarding is on or the current call status. You can open the Notifications panel to open the message, reminder, or event notification and see the mobile operator's name. Even you can switch on Data connection, WLAN, Bluetooth, etc.

-> Opening the Notifications panel

Press and hold the status bar, slide your finger downward to open the Notifications panel.

If you have several notifications, you can scroll down the status bar to view more notifications.

-> Closing the Notifications panel

Do one operation of the following:

1. Press and hold the bottom bar of the Notifications panel, then slide your finger up the screen.
2. Press BACK or Home directly.

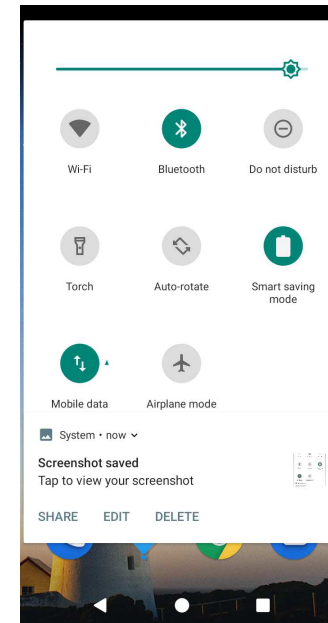

Arranging and Rearranging Widgets and Icons

Rearrange the widgets and icons on your Home screen to give room for adding more items to the Home screen.

-> Press and hold the widget or icon you are desired to move.

You'll see this icon Remove on the screen. Don't release your finger.

-> Drag the widget or icon to a new location on the screen. Pause at the left or right edge of the screen to drag the widget or icon onto another Home screen panel.

-> When the widget or icon is where you are desired to put it, release your finger. If you've released your finger but a message shows that there's no space to place the widget or icon, drag it right or left again to another Home screen panel.

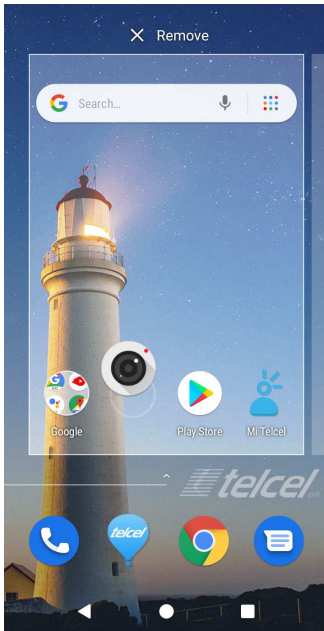

Adding Folders on your Screen

Use folders to group related applications and other shortcuts to keep your Home screen tidy and organized.

-> *Adding folder on your screen*

Press and hold an application icon or a widget that you want to move. Don't release your finger. Drag the application icon or widget and drop it on top of another application icon or widget. Then, simply tap the folder to open it so you can access the applications and widgets inside the folder.

-> *Renaming a folder*

Tap the folder to open it, and enter a new folder name and then tap anywhere on the screen.

-> *Deleting folder*

Drag out all the applications from the folder, then the folder will be deleted automatically.

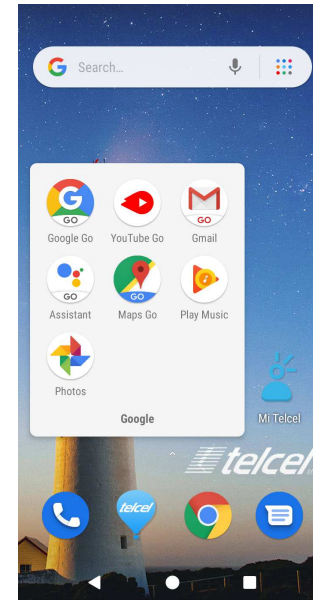

Adjusting Brightness

Drag the notification panel down and adjust brightness. Or enter Settings->Display->Brightness level, and adjust the brightness level here (by dragging the brightness slider to the left to decrease or to the right to increase the screen Brightness).

Note: Lower the brightness of the screen to prolong the battery life.

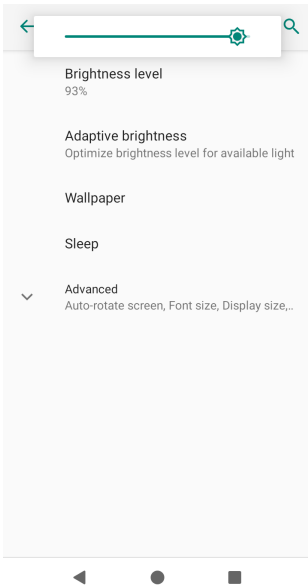

Changing your Wallpaper

Personalizing your Home screen wallpaper with your favorite photo is a quick and easy way to change the feel of your phone and give it a fresh look. Browse the collection of wallpapers included in your phone by default or choose from photos that you have taken with the camera.

-> Press and hold the screen where there is space.

-> The screen will show an optional context.

-> Select the wallpaper you want and confirm to set it as wallpaper.

Or you can enter Settings->Display->Wallpaper, then will show an optional context.

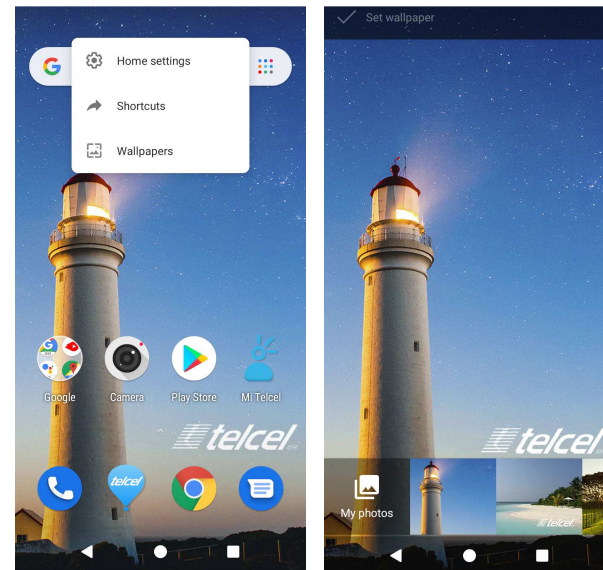

Make a Call

On the start screen choose  and enter a complete phone number to make a call.

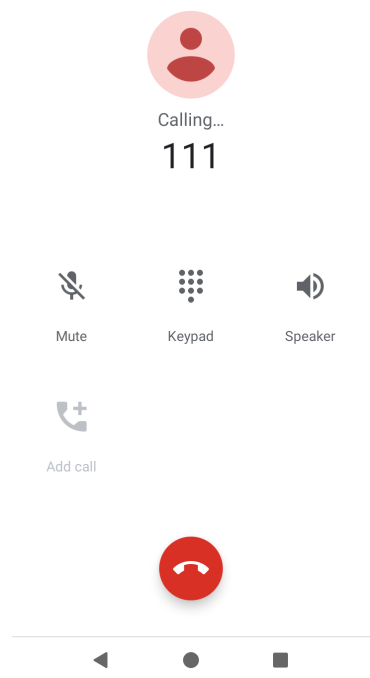

Call Log

Enter Phone interface, then tap Recents access Call log. In call log page, you can make calls, create new contact and send message etc.

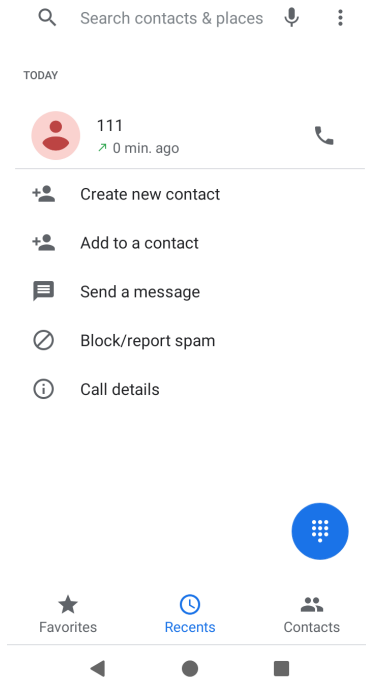

Reject a Call by Sending a Busy Message

While there is an incoming call, you are inconvenient to accept the call, and then you can send a busy message for rejecting the call.

Tap the SMS icon, some busy messages will show on the screen, short tap any of them to send out.

Add a Contact

Tap  and enter Contacts and then add a contact (see figure below.)

Tap  to add a new contact to Phone or SIM card.

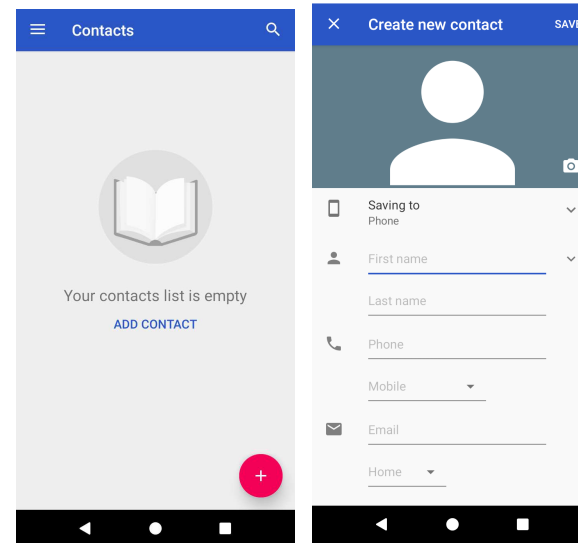

Messaging

Enter Messaging, and then compose new message. You touch a text field where you want to enter text, to open the keyboard.

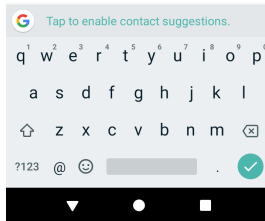
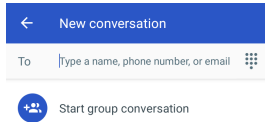

Receiving a New Message

When there is a new message comes, a new message icon will appear in the notifications area of the status bar to notify you of a new text or multimedia message.

To open the message, press and hold the status bar, and then slide the status bar down to open the Notifications panel. Or go to Messaging, read the message directly.

Editing SMS and MMS

-> When you are composing a new text message, you can select text for cutting or copying. Touch the text field or portion that contains text. You can select all contexts, copy, cut and share. The selected text is highlighted in Blue.

-> A multimedia message may contain video, pictures, audio, slideshow, etc. Thus, when you are supposed to edit a MMS, you can just add videos, pictures and more to SMS and change to MMS.

Message conversations

Text and multimedia messages that are sent to and received from a contact (or a number) are grouped into conversations or message threads in the All messages screen. Threaded

SMS or MMS let you see exchanged messages (similar to a chat program) with a contact on the screen.

Browse the Web

Open the browser; click the URL on the screen to search or tap website address.

The browser is fully optimized and comes with advanced features that let you enjoy Internet browsing on your phone.

You must have an active data connection or Wi-Fi connection to access the Internet.



Enjoy Music

When you copy music to your Micro SD card, the Music player searches the device for music files and builds a catalog of your music, based on information about each file that is stored in the file itself.

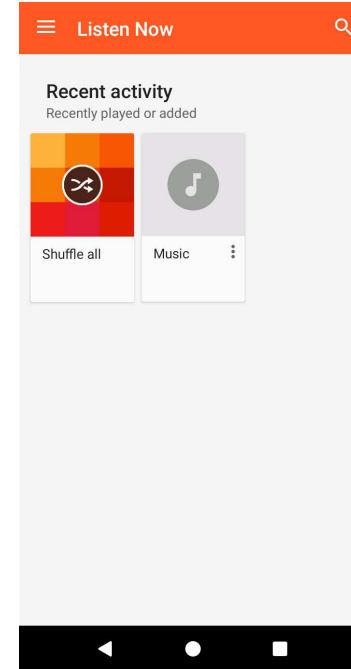

Download Applications on Google Play

Add a Google™ account

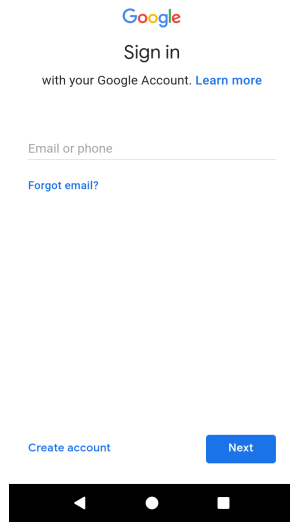

Download apps on Google Play.

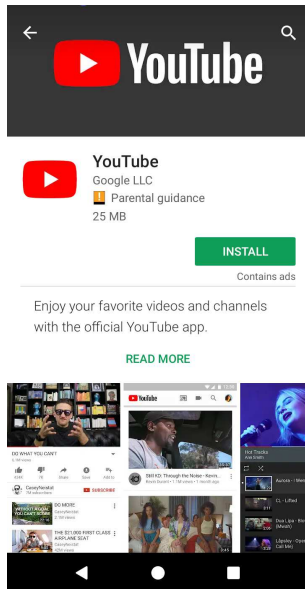
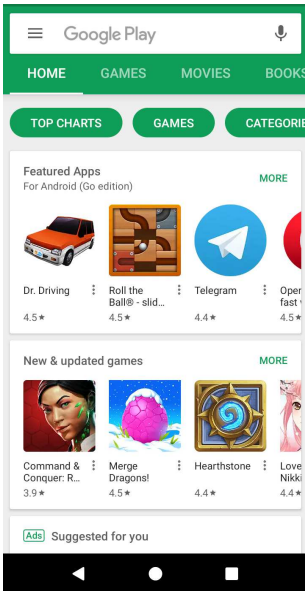

Manage Applications

Enter Settings>Apps & notifications>App info, then manage the applications. Tap any app to view the information of the applications, and you can also force the apps to stop or uninstall the apps.

To install Apps, you need switch on “Allow from this source” in settings.

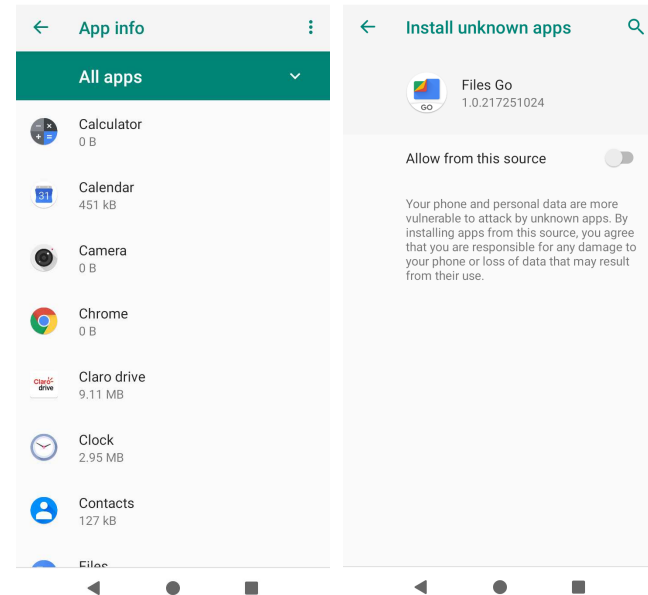

Maintenance & Safety

Please read this safety information carefully so that you can use your phone in complete safety:

1. Children: Be very careful with children and your phone. A mobile phone contains a number of detachable parts. Exercise great care when children are in close proximity to the phone. The phone contains small parts that could be swallowed or cause choking. If your phone is equipped with a camera or lighting device, do not use it too near children or animals.
2. Hearing: Prolonged listening at full power using a lightweight headset or headphones can damage your hearing. Reduce the volume to the lowest possible level when listening to music or conversations. Avoid high volumes over extended periods.
3. Driving: Exercise care when driving. Driving requires maximum attention at all times in order to minimize the risk of accidents. Using a mobile phone can distract the user and result in an accident. You must fully comply with the local regulations and laws in force regarding the use of cell phones whilst driving. You are not allowed to use the phone whilst driving. A hands-free kit should not be regarded as an alternative solution.
Flying: Turn your phone off when flying. Remember to turn your phone off when you are in a plane (GSM + Bluetooth) as it may cause interference.
4. Hospitals: Turn your phone off near any medical devices. It is extremely dangerous to leave a phone switched on near medical devices as it may cause interference. You must observe any instructions or warnings in hospitals and treatment centers. Remember to turn your phone off in service stations. Do not use your device in a petrol station near fuel. It is dangerous to use your phone inside a professional garage.
5. Electronic implants and pacemakers: Users who wear a pacemaker or who are fitted with an electronic implant must hold the phone on the opposite side to their implant as a precaution when making a call. If you notice that your phone is causing interference with a pacemaker, switch it off immediately and contact the manufacturer of the pacemaker for advice on what action to take.
6. Fire hazard: Do not leave your device near heat sources such as radiators or cookers. Do not leave your phone charging near flammable materials as there is a real risk of fire.
7. Contact with liquid: Do not expose the phone to liquid or touch it with wet hands: any damage caused by water may be irreparable.

8. Use only LANIX-approved accessories. The use of unauthorized accessories may damage your phone or cause a safety risk.

9. Do not destroy the batteries and chargers. Never use a battery or charger that has been damaged. Keep batteries away from magnetic objects as the latter might cause short-circuit between the positive and negative terminals of your batteries and destroy the battery or phone permanently. As a general rule, you should not expose the batteries to very high or low temperatures (below 0°C or above 45°C). Differences in temperature may reduce battery autonomy and service life.

10. Shocks and impact: Handle and use your phone with the utmost care. Protect your phone: shocks and impact may damage it. Some parts of your phone are made from glass and might break if the phone is dropped or is subject to severe impact. Avoid dropping your phone. Do not touch the screen with sharp objects.

11. Electric shock: Do not try to dismantle your phone as there is a very real risk of electric shock.

12. Maintenance: If you want to clean your handset, use a dry cloth (do not use a solvent, such as benzene, or alcohol).

13. Recharge your phone in a well-ventilated area. Do not recharge your device when it is resting on a soft surface.

14. Damage to magnetic strips: Keep your phone away from credit cards as they may damage the data on the magnetic strips.

15. Do not use the mobile phone in the environment at too high or too low temperature, never expose the mobile phone under strong sunshine or too wet environment. The suitable temperature for the phone is -10°C to +45°C, the maximum charging temperature declared by the manufacturer is +40°C.

16. Due to the used enclosure material, the GSM mobile phone shall only be connected to a USB Interface of version 2.0 or higher. The connection to so called power USB is prohibited.

17. The power adapter is the disconnect device for this equipment. The socket-outlet shall be near the equipment and easily accessible.

18. This charger is for indoor use only, the charger type is X530 -C, output voltage/current is 5.V/0.7A.

~ Important operating guidelines

1. To increase the life of your battery, only use LANIX chargers and batteries. Replacing the battery with a non-compliant model may result in the latter exploding.
2. Never throw batteries on a fire and follow the guidelines in

force for recycling used batteries and phones.

3. Be careful not to crush or damage the battery, as this could cause an internal short circuit and overheating.
4. Do not take the battery apart.
5. The battery can be recharged several hundred times before needing to be replaced. When it shows signs of losing its power, it can be replaced.
6. If you do not use your mobile phone for an extended period, remember to recharge the battery to optimize its use time.
7. Do not throw batteries away with household waste: recycle them in accordance with the manufacturer's guidelines. If the battery is damaged, contact the after-sales service or the nearest authorized LANIX dealer.
8. Unplug the charger from the wall socket when the battery is fully charged in order to reduce your energy consumption.
9. Do not leave the battery being charged for more than a week as this might result in an overload and reduce the life of the product.
10. Handle the SIM cards with care: wipe them with a soft cloth if they appear dirty.
11. Emergency calls: the emergency numbers may not be accessible on all mobile telephone networks, in isolated areas or areas where there is no coverage; check first with your operator.
12. Radio Frequency Exposure: Your mobile phone has been designed and manufactured in accordance with the international guidelines (ICNIRP1) on exposure to radio frequencies. These guidelines, which are based on various studies and research, have been developed by independent scientific organizations to ensure the safety of everyone who uses a mobile phone.

~ General Notice

Due to the used enclosure material, the GSM mobile phone shall only be connected to a USB Interface of version 2.0 or higher. The connection to so called power USB is prohibited.

The adapter shall be installed near the equipment and shall be easily accessible.

Do not use the mobile phone in the environment at too high or too low temperature, never expose the mobile phone under strong sunshine or too wet environment. The suitable temperature for the phone is 0°C-50°C.

The maximum operating ambient temperature of the charger declared by the manufacturer is 45°C.

Caution risk of explosion if battery is replaced by an incorrect

type. Dispose of used batteries according to the instructions.

FCC Regulations

This mobile phone complies with part 15 of the FCC Rules. Operation is subject to the following two conditions: (1) This device may not cause harmful interference, and (2) this device must accept any interference received, including interference that may cause undesired operation.

This mobile phone has been tested and found to comply with the limits for a Class B digital device, pursuant to Part 15 of the FCC Rules. These limits are designed to provide reasonable protection against harmful interference in a residential installation. This equipment generates, uses and can radiated radio frequency energy and, if not installed and used in accordance with the instructions, may cause harmful interference to radio communications. However, there is no guarantee that interference will not occur in a particular installation. If this equipment does cause harmful interference to radio or television reception, which can be determined by turning the equipment off and on, the user is encouraged to try to correct the interference by one or more of the following measures:

- Reorient or relocate the receiving antenna.
- Increase the separation between the equipment and receiver.
- Connect the equipment into an outlet on a circuit different from that to which the receiver is connected.
- Consult the dealer or an experienced radio/TV technician for help.

FCC Note:

Caution: Changes or modifications not expressly approved by the party responsible for compliance could void the user's authority to operate the equipment.

RF Exposure Information (SAR)

This phone is designed and manufactured not to exceed the emission limits for exposure to radio frequency (RF) energy set by the Federal Communications Commission of the United States.

During SAR testing, this device was set to transmit at its highest certified power level in all tested frequency bands, and placed in positions that simulate RF exposure in usage against the head with no separation, and near the body with the separation of 10 mm. Although the SAR is determined at the highest certified power level, the actual SAR level of the device while operating can be well below the maximum value. This is because the

phone is designed to operate at multiple power levels so as to use only the power required to reach the network. In general, the closer you are to a wireless base station antenna, the lower the power output.

The exposure standard for wireless devices employing a unit of measurement is known as the Specific Absorption Rate, or SAR.

The SAR limit set by the FCC is 1.6W/kg.

This device is complied with SAR for general population /uncontrolled exposure limits in ANSI/IEEE C95.1-1992 and had been tested in accordance with the measurement methods and procedures specified in IEEE1528. This device has been tested and meets the FCC RF exposure guidelines when tested with the device directly contacted to the body.

The FCC has granted an Equipment Authorization for this model phone with all reported SAR levels evaluated as in compliance with the FCC RF exposure guidelines. SAR information on this model phone is on file with the FCC and can be found under the Display Grant section of www.fcc.gov/oet/ea/fccid after searching on FCC ID: ZC4M7S.

For this device, the highest reported SAR value for usage against the head is 0.47 W/kg, for usage near the body is 0.78 W/kg.

While there may be differences between the SAR levels of various phones and at various positions, they all meet the government requirements.

SAR compliance for body-worn operation is based on a separation distance of 10 mm between the unit and the human body. Carry this device at least 10 mm away from your body to ensure RF exposure level compliant or lower to the reported level. To support body-worn operation, choose the belt clips or holsters, which do not contain metallic components, to maintain a separation of 10 mm between this device and your body.

RF exposure compliance with anybody-worn accessory, which contains metal, was not tested and certified, and use such body-worn accessory should be avoided.

Google, Google Play, YouTube and other marks are trademarks of Google LLC.