

EMC TEST REPORT



Applicant:	Corporativo Lanix S.A. de C.V.
Address:	Carretera Internacional Hermosillo-Nogales Km 8.5, Hermosillo Sonora, Mexico

Manufacturer or Supplier:	Corporativo Lanix S.A. de C.V.
Address:	Carretera Internacional Hermosillo-Nogales Km 8.5, Hermosillo Sonora, Mexico
Product:	Smartphone
Brand Name:	LANIX
Model Name:	Ilium M5
FCC ID:	ZC4M5
Date of tests:	Feb. 26, 2018 ~ Mar. 12, 2018

The submitted sample of the above equipment has been tested for according to the requirements of the following standards:

- FCC Part 15, Subpart B, Class B**
- ANSI C63.4:2014**

CONCLUSION: The submitted sample was found to COMPLY with the test requirement

Issued by Yuqiang Yin Engineer / Mobile Department	Approved by Bill Yao Manager / Mobile Department
 Date: Mar. 13, 2018	 Date: Mar. 13, 2018

This report is for your exclusive use. Any copying or replication of this report to or for any other person or entity, or use of our name or trademark, is permitted only with our prior written permission. This report sets forth our findings solely with respect to the test samples identified herein. The results set forth in this report are not indicative or representative of the quality or characteristics of the lot from which a test sample was taken or any similar or identical product unless specifically and expressly noted. Our report includes all of the tests requested by you and the results thereof based upon the information that you provided to us. You have 60 days from date of issuance of this report to notify us of any material error or omission caused by our negligence, provided, however, that such notice shall be in writing and shall specifically address the issue you wish to raise. A failure to raise such issue within the prescribed time shall constitute your unqualified acceptance of the completeness of this report, the tests conducted and the correctness of the report contents. Unless specific mention, the uncertainty of measurement has been explicitly taken into account to declare the compliance or non-compliance to the specification



TABLE OF CONTENTS

RELEASE CONTROL RECORD 3

1 GENERAL INFORMATION 4

1.1 GENERAL DESCRIPTION OF EUT 4

1.2 SUMMARY OF TEST RESULTS 6

1.3 MEASUREMENT UNCERTAINTY 6

1.4 DESCRIPTION OF TEST MODES 7

1.5 DESCRIPTION OF SUPPORT UNITS 8

1.6 CONFIGURATION OF SYSTEM UNDER TEST 9

2 EMISSION TEST 10

2.1 CONDUCTED EMISSION MEASUREMENT 10

2.1.1 LIMITS OF CONDUCTED EMISSION MEASUREMENT 10

2.1.2 TEST INSTRUMENTS 10

2.1.3 TEST PROCEDURES 11

2.1.4 DEVIATION FROM TEST STANDARD 11

2.1.5 TEST SETUP 12

2.1.6 EUT OPERATING CONDITIONS 12

2.1.7 TEST RESULTS 13

2.2 RADIATED EMISSION MEASUREMENT 15

2.2.1 LIMITS OF RADIATED EMISSION MEASUREMENT 15

2.2.2 TEST INSTRUMENTS 16

2.2.3 TEST PROCEDURE 17

2.2.4 DEVIATION FROM TEST STANDARD 18

2.2.5 TEST SETUP 19

2.2.6 EUT OPERATING CONDITIONS 19

2.2.7 TEST RESULTS 20

3 APPENDIX A – MODIFICATIONS RECORDERS FOR ENGINEERING CHANGES TO THE EUT BY THE LAB 24



**BUREAU
VERITAS**

Test Report No.: FV180224W002

RELEASE CONTROL RECORD

ISSUE NO.	REASON FOR CHANGE	DATE ISSUED
FV180224W002	Original release	Mar. 13, 2018



1 GENERAL INFORMATION

1.1 GENERAL DESCRIPTION OF EUT

PRODUCT	Smartphone	
BRAND NAME	LANIX	
MODEL NAME	Ilium M5	
NOMINAL VOLTAGE	5Vdc (adapter or host equipment) 3.8Vdc (Li-ion, battery)	
BATTERY	Brand Name: LANIX Model Name: Ilium M5-BAT Power Rating: DC 3.8V, 2500mAh, Li-ion	
MODULATION TYPE	WLAN	CCK, DQPSK, DBPSK for DSSS 64QAM, 16QAM, QPSK, BPSK for OFDM
	BT_LE	BT-LE(GFSK) for DTS
	Bluetooth	GFSK, $\pi/4$ -DQPSK, 8DPSK
	GPS	C/A code
	GSM	GMSK
	WCDMA	BPSK/QPSK
	LTE	QPSK/16QAM
	FM	FSK
OPERATING FREQUENCY	WLAN	2412 ~ 2472MHz for 11b/g/n(HT20) 2422 ~ 2462MHz for 11n(HT40)
	Bluetooth/BT_LE	2402MHz ~ 2480MHz
	GPS	1575.42MHz
	GSM	824.2MHz ~ 848.8MHz (FOR GSM 850) 1850.2MHz ~ 1909.8MHz (FOR GSM 1900)
	WCDMA	1852.4MHz ~ 1907.6MHz (FOR WCDMA Band 2) 826.4MHz ~ 846.6MHz (FOR WCDMA Band 5)
	LTE	1850.7MHz ~ 1909.3MHz (FOR LTE Band2) 1710.7MHz ~ 1754.3MHz (FOR LTE Band4) 824.7MHz ~ 848.3MHz (FOR LTE Band5) 2500MHz ~ 2570MHz (FOR LTE Band7)
	FM	98MHz
HW VERSION	V1.0	
SW VERSION	Ilium M5_SW_01	
I/O PORTS	Refer to user's manual	



CABLE SUPPLIED	USB cable: non-shielded, detachable, 1.0meter Earphone cable: non-shielded, detachable, 1.2meter
ACCESSORY DEVICES	Refer to note as below

NOTE:

- For a more detailed features description, please refer to the manufacturer's specifications or the user's manual.
- The EUT was powered by the following adapter:

ADAPTER	
BRAND:	LANIX
MODEL:	Ilium M5-C
INPUT:	AC 100-240V, 150mA
OUTPUT:	DC 5V, 1000mA

- The EUT matched the following USB cable and earphone:

USB CABLE	
BRAND:	LANIX
MODEL:	Ilium M5
SIGNAL LINE:	1.0 METER

EARPHONE	
BRAND:	LANIX
MODEL:	Ilium M5
SIGNAL LINE:	1.2 METER

- For the test results, the EUT had been tested with all conditions. But only the worst case was shown in test report.

1.2 SUMMARY OF TEST RESULTS

The EUT has been tested according to the following specifications:

APPLIED STANDARD: FCC Part 15, Subpart B			
Standard Section	Test Item	Result	Remark
FCC Part 15, Subpart B, Class B ANSI C63.4:2014	Conducted Test	PASS	Meets limits minimum passing margin is -8.60dB at 0.460000MHz.
	Radiated Emission Test (30MHz ~ 1GHz)	PASS	Meets Class B Limit Minimum passing margin is -3.02dB at 300.25MHz
	Radiated Emission Test (Above 1GHz)	PASS	Meets Class B Limit Minimum passing margin is -13.58dB at 3670MHz

1.3 MEASUREMENT UNCERTAINTY

Where relevant, the following measurement uncertainty levels have been estimated for tests performed on the EUT as specified in CISPR 16-4-2:

This uncertainty represents an expanded uncertainty expressed at approximately the 95% confidence level using a coverage factor of k=2.

MEASUREMENT	FREQUENCY	UNCERTAINTY
Conducted emissions	150kHz ~ 30MHz	+/-2.66dB
Radiated emissions	30MHz ~ 1GHz	+/-3.26dB
	1GHz ~ 18GHz	+/-4.48dB

1.4 DESCRIPTION OF TEST MODES

Test Mode	Test Condition
Radiated emission test	
1	GSM850 Idle+ Adapter+ Earphone+ USB cable+ BT Idle+ WIFI Idle(2.4G)+ GPS Rx+ Back camera on
2	GSM1900 Idle+ Adapter+ Earphone+ USB cable+ BT Idle+ WIFI Idle(2.4G)+ GPS Rx+ Front camera on
3	WCDMA B2 Idle+ Adapter+ Earphone+ USB cable+ BT Idle+ WIFI Idle(2.4G)+ GPS Rx+ MPEG4
4	WCDMA B5 Idle+ Adapter+ Earphone+ USB cable+ BT Idle+ WIFI Idle(2.4G)+ GPS Rx+ FM Rx
5	LTE B2 Idle+ Adapter+ Earphone+ USB cable+ BT Idle+ WIFI Idle(2.4G)+ GPS Rx
6	LTE B4 Idle+ Adapter+ Earphone+ USB cable+ BT Idle+ WIFI Idle(2.4G)+ GPS Rx
7	LTE B5 Idle+ Adapter+ Earphone+ USB cable+ BT Idle+ WIFI Idle(2.4G)+ GPS Rx
8	LTE B7 Idle+ Adapter+ Earphone+ USB cable+ BT Idle+ WIFI Idle(2.4G)+ GPS Rx
9	GSM 850 Idle+ USB Link+ Earphone+ BT Idle+ WIFI Idle(2.4G) + GPS Rx
Conducted emission test	
1	GSM850 Idle+ Adapter+ Earphone+ USB cable+ BT Idle+ WIFI Idle(2.4G)+ GPS Rx+ Back camera on
2	GSM1900 Idle+ Adapter+ Earphone+ USB cable+ BT Idle+ WIFI Idle(2.4G)+ GPS Rx+ Front camera on
3	WCDMA B2 Idle+ Adapter+ Earphone+ USB cable+ BT Idle+ WIFI Idle(2.4G)+ GPS Rx+ MPEG4
4	WCDMA B5 Idle+ Adapter+ Earphone+ USB cable+ BT Idle+ WIFI Idle(2.4G)+ GPS Rx+ FM Rx
5	LTE B2 Idle+ Adapter+ Earphone+ USB cable+ BT Idle+ WIFI Idle(2.4G)+ GPS Rx
6	LTE B4 Idle+ Adapter+ Earphone+ USB cable+ BT Idle+ WIFI Idle(2.4G)+ GPS Rx
7	LTE B5 Idle+ Adapter+ Earphone+ USB cable+ BT Idle+ WIFI Idle(2.4G)+ GPS Rx
8	LTE B7 Idle+ Adapter+ Earphone+ USB cable+ BT Idle+ WIFI Idle(2.4G)+ GPS Rx
9	GSM 850 Idle+ USB Link+ Earphone+ BT Idle+ WIFI Idle(2.4G) + GPS Rx

NOTE:

1. For conducted emission test, test mode 1 was the worst case and only this mode was presented in this report.
2. For radiated emission test, test mode 9 was the worst case and only this mode was presented in this report



1.5 DESCRIPTION OF SUPPORT UNITS

The EUT has been tested as an independent unit together with other necessary accessories or support units. The following support units or accessories were used to form a representative test configuration during the tests.

FOR EMISSION TESTS

NO.	PRODUCT	BRAND	MODEL NO.	SERIAL NO.	FCC ID
1	Notebook	N/A	N/A	N/A	N/A
2	Printer	N/A	N/A	N/A	N/A
3	Bluetooth Earphone	N/A	N/A	N/A	N/A

NO.	SIGNAL CABLE DESCRIPTION OF THE ABOVE SUPPORT UNITS
1	N/A
2	N/A
3	N/A



1.6 CONFIGURATION OF SYSTEM UNDER TEST

Test configuration

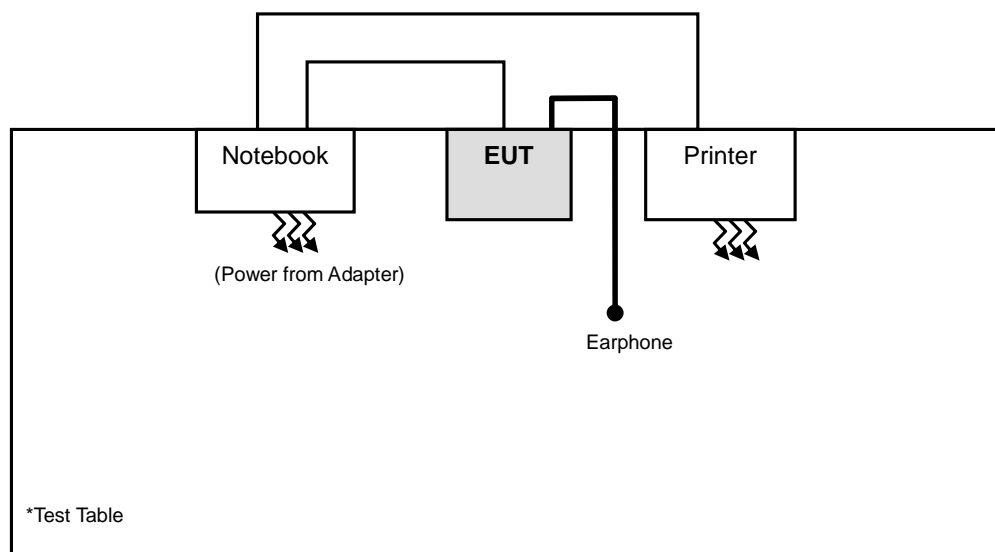

2 EMISSION TEST

2.1 CONDUCTED EMISSION MEASUREMENT

2.1.1 LIMITS OF CONDUCTED EMISSION MEASUREMENT

TEST STANDARD: FCC Part 15, Subpart B (Section: 15.107)

FREQUENCY OF EMISSION (MHz)	CONDUCTED LIMIT (dB μ V)	
	Quasi-peak	Average
0.15 ~ 0.5	66 to 56	56 to 46
0.5 ~ 5	56	46
5 ~ 30	60	50

- NOTE:**
1. The lower limit shall apply at the transition frequencies.
 2. The limit decreases in line with the logarithm of the frequency in the range of 0.15 to 0.50MHz.
 3. All emanations from a class A/B digital device or system, including any network of conductors and apparatus connected thereto, shall not exceed the level of field strengths specified above.

2.1.2 TEST INSTRUMENTS

Equipment	Manufacturer	Model No.	Serial No.	Last Cal.	Next Cal.
EMI Test Receiver	Rohde&Schwarz	ESR3	101900	Jun. 28,17	Jun. 27,18
EMC32 test software	Rohde&Schwarz	EMC32	NA	NA	NA
LISN network	Rohde&Schwarz	ENV216	101922	Sep. 18,17	Sep. 17,18

- NOTE:**
1. The test was performed in CE shielded room.
 2. The calibration interval of the above test instruments is 12 months and the calibrations are traceable to CEPREI/CHINA, GRGT/CHINA and NIM/CHINA.

2.1.3 TEST PROCEDURES

- a. The EUT was placed 0.4 meters from the conducting wall of the shielded room with EUT being connected to the power mains through a line impedance stabilization network (LISN). Other support units were connected to the power mains through another LISN. The two LISNs provide 50 ohm/ 50uH of coupling impedance for the measuring instrument.
- b. Both lines of the power mains connected to the EUT were checked for maximum conducted interference.
- c. The frequency range from 150 kHz to 30MHz was searched. Emission levels under (Limit - 20dB) were not recorded.

NOTE: All modes of operation were investigated and the worst-case emissions are reported.

2.1.4 DEVIATION FROM TEST STANDARD

No deviation.



2.1.5 TEST SETUP

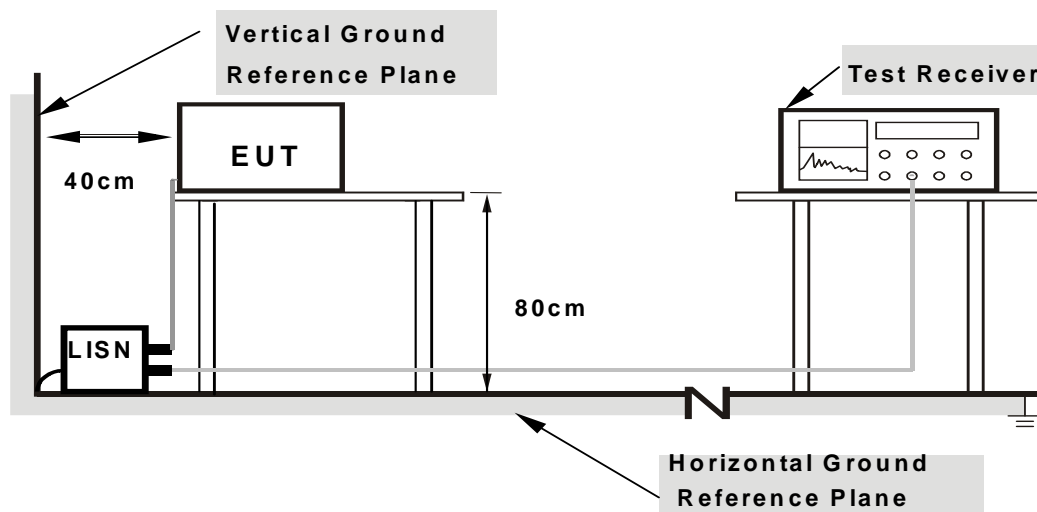

- Note:**
- 1.Support units were connected to second LISN.
 - 2.Both of LISNs (AMN) are 80 cm from EUT and at least 80 from other units and other metal planes

For the actual test configuration, please refer to the attached file (Test Setup Photo).

2.1.6 EUT OPERATING CONDITIONS

- a. Turned on the power and connected of all equipment.
- b. EUT was operated according to the use type described in the manufacturer's specifications or the user's manual.



2.1.7 TEST RESULTS

TEST VOLTAGE	DC 5V From Adapter Input 120 Vac, 60 Hz	Detector Function & Resolution Bandwidth	Quasi-Peak (QP) / Average (AV), 9 kHz
ENVIRONMENTAL CONDITIONS	23deg. C, 52RH	TESTED BY	Jocan Guo

Frequency (MHz)	QuasiPeak (dBµV)	CAverage (dBµV)	Limit (dBµV)	Margin (dB)	Line	Filter	Corr. (dB)
0.460000	---	35.63	46.69	-11.06	L1	ON	9.7
0.460000	41.90	---	56.69	-14.79	L1	ON	9.7
2.888000	---	24.10	46.00	-21.90	L1	ON	9.7
2.888000	31.38	---	56.00	-24.62	L1	ON	9.7
4.468000	---	28.17	46.00	-17.83	L1	ON	9.7
4.468000	34.35	---	56.00	-21.65	L1	ON	9.7
9.976000	---	30.28	50.00	-19.72	L1	ON	9.9
9.976000	36.28	---	60.00	-23.72	L1	ON	9.9
13.928000	---	34.58	50.00	-15.42	L1	ON	9.9
13.928000	40.44	---	60.00	-19.56	L1	ON	9.9
17.744000	---	25.54	50.00	-24.46	L1	ON	9.9
17.744000	33.64	---	60.00	-26.36	L1	ON	9.9

- REMARKS:**
1. Q.P. and AV. are abbreviations of quasi-peak and average individually.
 2. "-": The Quasi-peak reading value also meets average limit and measurement with the average detector is unnecessary.
 3. The emission levels of other frequencies were very low against the limit.
 4. Margin value = Emission level - Limit value
 5. Correction factor = Insertion loss + Cable loss
 6. Emission Level = Correction Factor + Reading Value.

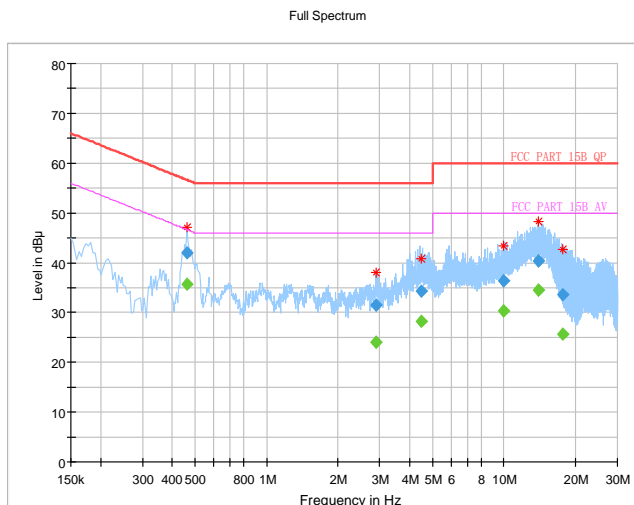

TEST VOLTAGE	DC 5V From Adapter Input 120 Vac, 60 Hz	Detector Function & Resolution Bandwidth	Quasi-Peak (QP) / Average (AV), 9 kHz
ENVIRONMENTAL CONDITIONS	23deg. C, 52RH	TESTED BY	Jocan Guo

Frequency (MHz)	QuasiPeak (dBuV)	CAverage (dBuV)	Limit (dBuV)	Margin (dB)	Line	Filter	Corr. (dB)
0.460000	---	38.09	46.69	-8.60	N	ON	10.1
0.460000	44.59	---	56.69	-12.10	N	ON	10.1
0.472000	---	37.78	46.48	-8.70	N	ON	10.1
0.472000	45.51	---	56.48	-10.97	N	ON	10.1
4.700000	---	30.06	46.00	-15.94	N	ON	9.8
4.700000	39.17	---	56.00	-16.83	N	ON	9.8
10.324000	---	32.77	50.00	-17.23	N	ON	9.9
10.324000	41.29	---	60.00	-18.71	N	ON	9.9
14.336000	---	36.91	50.00	-13.09	N	ON	9.9
14.336000	46.00	---	60.00	-14.00	N	ON	9.9
17.932000	---	28.17	50.00	-21.83	N	ON	10.0
17.932000	40.09	---	60.00	-19.91	N	ON	10.0

- REMARKS:**
1. Q.P. and AV. are abbreviations of quasi-peak and average individually.
 2. "-": The Quasi-peak reading value also meets average limit and measurement with the average detector is unnecessary.
 3. The emission levels of other frequencies were very low against the limit.
 4. Margin value = Emission level - Limit value
 5. Correction factor = Insertion loss + Cable loss
 6. Emission Level = Correction Factor + Reading Value.

Full Spectrum

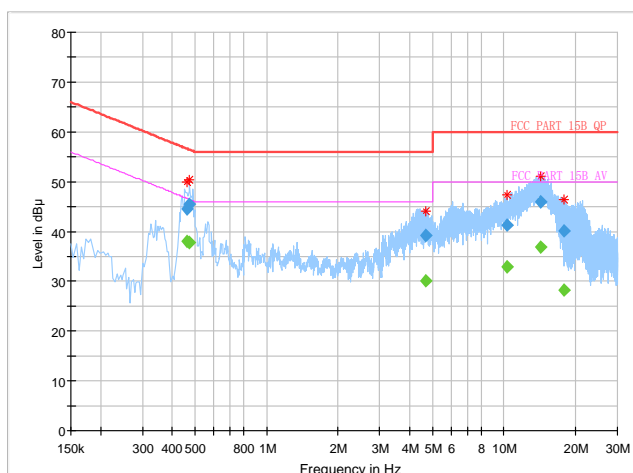

2.2 RADIATED EMISSION MEASUREMENT

2.2.1 LIMITS OF RADIATED EMISSION MEASUREMENT

TEST STANDARD: FCC Part 15, Subpart B (Section: 15.109)

Emissions radiated outside of the specified bands, shall be according to the general radiated limits as following:

Radiated Emissions Limits at 10 meters (dB μ V/m)				
Frequencies (MHz)	FCC 15B/ ICES-003, Class A	FCC 15B / ICES-003, Class B	CISPR 22, Class A	CISPR 22, Class B
30-88	39	29.5	40	30
88-216	43.5	33.1		
216-230	46.4	35.6		
230-960			47	37
960-1000	49.5	43.5	Not defined	Not defined
1000-3000	Avg: 49.5	Avg: 43.5		
3000+	Peak: 69.5	Peak: 63.5	Not defined	Not defined

Radiated Emissions Limits at 3 meters (dB μ V/m)				
Frequencies (MHz)	FCC 15B / ICES-003, Class A	FCC 15B / ICES-003, Class B	CISPR 22, Class A	CISPR 22, Class B
30-88	49.5	40	50.5	40.5
88-216	54	43.5		
216-230	56.9	46		
230-960			57.5	47.5
960-1000	60	54	Avg: 56 Peak: 76	Avg: 50 Peak: 70
1000-3000	Avg: 60	Avg: 54		
3000+	Peak: 80	Peak: 74	Avg: 60 Peak: 80	Avg: 54 Peak: 74

Frequency Range (For unintentional radiators)

Highest frequency generated or used in the device or on which the device operates or tunes (MHz)	Upper frequency of measurement range (MHz)
Below 1.705	30
1.705-108	1000
108-500	2000
500-1000	5000
Above 1000	5 th harmonic of the highest frequency or 40GHz, whichever is lower

- NOTE:**
1. The lower limit shall apply at the transition frequencies.
 2. Emission level (dBuV/m) = 20 log Emission level (uV/m).
 3. As shown in 15.35(b), for frequencies above 1000MHz, the field strength limits are based on average detector, however, the peak field strength of any emission shall not exceed the maximum permitted average limits, specified above by more than 20dB under any condition of modulation.
 4. QP detector shall be applied if not specified.

2.2.2 TEST INSTRUMENTS

Frequency range below 1GHz

Equipment	Manufacturer	Model No.	Serial No.	Last Cal.	Next Cal.
3m Semi-anechoic Chamber	ETS-LINDGREN	9m*6m*6m	Euroshieldpn-CT0001143-1216	May 06,17	May 05,18
Bilog Antenna	ETS-LINDGREN	3143B	00161965	Nov. 26,16	Nov. 25,18
MXE EMI Receiver	KEYSIGHT	N9038A-544	MY54450026	Mar. 10,18	Mar. 09,19
Signal Pre-Amplifier	EMSI	EMC 9135	980249	Jul. 24,17	Jul. 23,18

Frequency range above 1GHz

Equipment	Manufacturer	Model No.	Serial No.	Last Cal.	Next Cal.
3m Semi-anechoic Chamber	ETS-LINDGREN	9m*6m*6m	Euroshieldpn-CT0001143-1216	May 06,17	May 05,18
Horn Antenna	ETS-LINDGREN	3117	00168728	Nov. 26,16	Nov. 25,18
MXE EMI Receiver	KEYSIGHT	N9038A-544	MY54450026	Mar. 10,18	Mar. 09,19
Signal Pre-Amplifier	EMSI	EMC 012645B	980257	Jul. 24,17	Jul. 23,18

- NOTE:**
1. The test was performed in 3m chamber.
 2. The calibration interval of the above test instruments is 12 months or 24 months and the calibrations are traceable to CEPREI/CHINA, GRGT/CHINA and NIM/CHINA.
 3. The FCC Site Registration No. is 525120.

2.2.3 TEST PROCEDURE

<Frequency Range below 1GHz>

The basic test procedure was in accordance with ANSI C63.4:2014 (section 12).

- a. The EUT was placed on the top of a rotating table 0.8 meters above the ground at a 3 meter semi-anechoic chamber room. The table was rotated 360 degrees to determine the position of the highest radiation.
- b. The EUT was set 3 meters away from the interference-receiving antenna, which was mounted on the top of a variable-height antenna tower.
- c. The height of antenna is varied from 1 meter to 4 meters above the ground to determine the maximum value of the field strength. Both horizontal and vertical polarizations of the antenna are set to make the measurement.
- d. For each suspected emission, the EUT was arranged to its worst case and then the antenna was tuned to heights from 1 meter to 4 meters and the rotatable table was turned from 0 degrees to 360 degrees to find the maximum reading.
- e. The test-receiver system was set to quasi-peak detect function and specified bandwidth with maximum hold mode when the test frequency is below 1GHz.

NOTE:

1. The resolution bandwidth of test receiver/spectrum analyzer is 120kHz for Quasi-peak detection (QP) at frequency below 1GHz.
2. Emission level(dBuV/m)=Raw Value(dBuV) + Correction Factor(dB/m)
3. Correction Factor(dB/m) = Antenna Factor (dB/m) + Cable Factor (dB) (if the raw value not contains the amplifier);
4. Correction Factor(dB/m) = Antenna Factor (dB/m) + Cable Factor (dB) – Amplifier Gain(dB) (if the raw value contains the amplifier).
5. Margin value = Emission level – Limit value.

<Frequency Range above 1GHz>

- a. The EUT was placed on the top of a rotating table 0.8 meters above the ground at a 3 meter fully-anechoic chamber room. The table was rotated 360 degrees to determine the position of the highest radiation.
- b. The EUT was set 3 meters away from the interference-receiving antenna, which was mounted on the top of a variable-height antenna tower.
- c. The height of antenna is varied from one meter to four meters above the ground to determine the maximum value of the field strength. Both horizontal and vertical polarizations of the antenna are set to make the measurement. The bore sight should be used during the test above 1GHz.
- d. For each suspected emission, the EUT was arranged to its worst case and then the antenna was tuned to heights from 1 meter to 4 meters and the rotatable table was turned from 0 degrees to 360 degrees to find the maximum reading.
- e. The test-receiver system was set to peak and average detect function and specified bandwidth with maximum hold mode when the test frequency is above 1 GHz

NOTE:

1. The resolution bandwidth of test receiver/spectrum analyzer is 120kHz for Quasi-peak detection (QP) at frequency below 1GHz.
2. The resolution bandwidth is 1MHz and video bandwidth of test receiver/spectrum analyzer is 3MHz for Peak detection at frequency above 1GHz. The resolution bandwidth of test receiver/spectrum analyzer is 1 MHz and video bandwidth of test receiver/spectrum analyzer is 10Hz for Average detection (AV) at frequency above 1GHz.
3. For measurement of frequency above 1000 MHz, the EUT was set 3 meters away from the receiver antenna.
4. Emission level(dBuV/m)=Raw Value(dBuV) + Correction Factor(dB/m)
5. Correction Factor(dB/m) = Antenna Factor (dB/m) + Cable Factor (dB) (if the raw value not contains the amplifier);
6. Correction Factor(dB/m) = Antenna Factor (dB/m) + Cable Factor (dB) – Amplifier Gain(dB) (if the raw value contains the amplifier)
7. Margin value = Emission level – Limit value.

2.2.4 DEVIATION FROM TEST STANDARD

No deviation.

2.2.5 TEST SETUP

<Frequency Range below 1GHz>

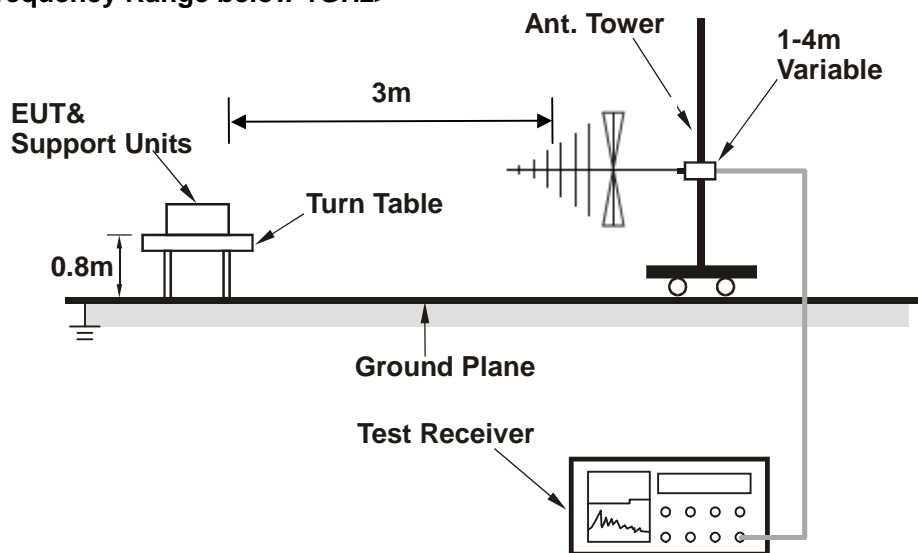

<Frequency Range above 1GHz>

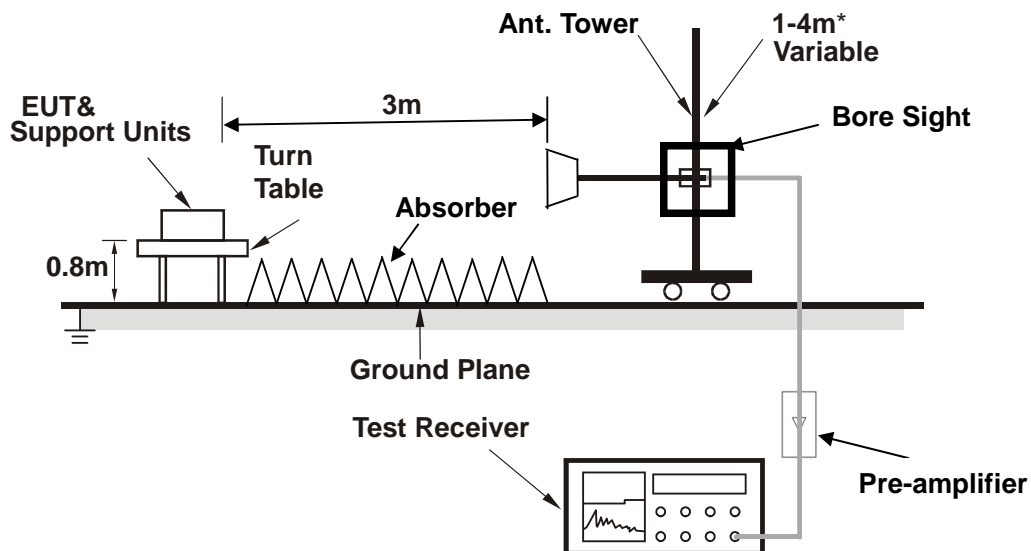

* : depends on the EUT height and the antenna 3dB beamwidth both, refer to section 7.3 of CISPR 16-2-3.

2.2.6 EUT OPERATING CONDITIONS

Same as item 2.1.6.

2.2.7 TEST RESULTS

TEST VOLTAGE	DC 5V From Adapter Input 120 Vac, 60 Hz	FREQUENCY RANGE	30-1000 MHz
ENVIRONMENTAL CONDITIONS	23deg. C, 70 %RH	DETECTOR FUNCTION & RESOLUTION BANDWIDTH	Quasi-Peak, 120 kHz
TESTED BY	Star Le		

ANTENNA POLARITY & TEST DISTANCE: HORIZONTAL AT 3 M										
FREQ. (MHz)	EMISSION LEVEL (dBuV/m)	READ LEVEL (dBuV)	LIMIT (dBuV/m)	MARGIN (dB)	ANTENNA FACTOR (dB /m)	CABLE LOSS (dB)	PREAMP FACTOR (dB)	ANTENNA HEIGHT (cm)	TABLE ANGLE (Degree)	REMARK
90.14	40.08	67.25	43.5	-3.42	8.41	1.46	37.04	100	55	QP
140.58	37.96	64.13	43.5	-5.54	8.85	1.82	36.84	100	21	QP
177.44	38.84	63.34	43.5	-4.66	10.16	2.04	36.7	100	25	QP
203.63	39.45	63.05	43.5	-4.05	10.75	2.19	36.54	100	326	QP
300.25	42.98	62.95	46	-3.02	13.81	2.72	36.5	100	5	QP
387.93	37.39	54.28	46	-8.61	16.7	3.1	36.69	200	274	QP

- REMARKS:**
1. Peak detector quick scan is showed on the graph and final quasi-peak detector data is measured corresponding to relevant limit and recorded in the data table.
 2. Negative sign (-) in the margin column signify levels below the limit.
 3. Frequency range scanned: 30MHz to 1000MHz.
 4. Only emissions significantly above equipment noise floor are reported.

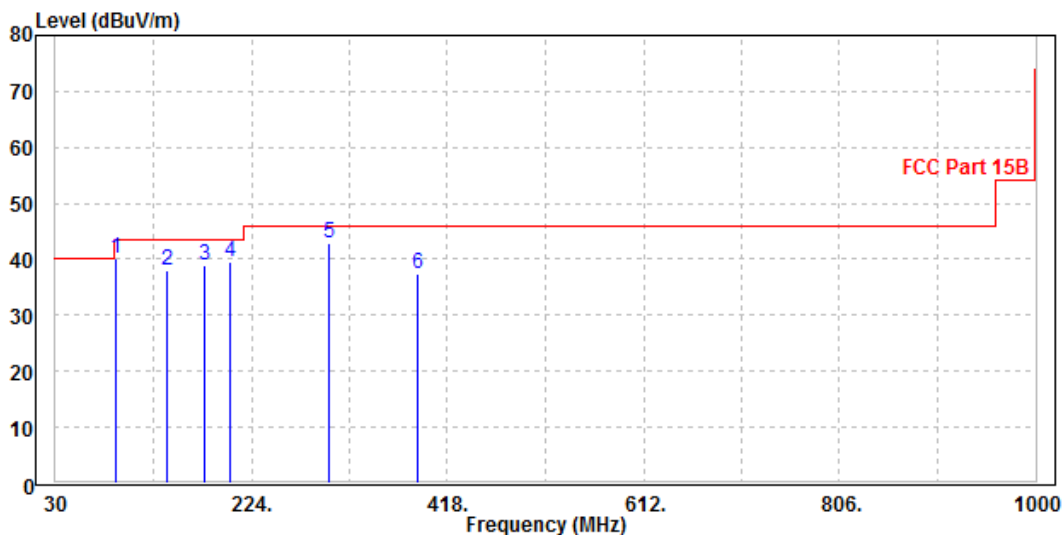

TEST VOLTAGE	DC 5V From Adapter Input 120 Vac, 60 Hz	FREQUENCY RANGE	30-1000 MHz
ENVIRONMENTAL CONDITIONS	23deg. C, 70 %RH	DETECTOR FUNCTION & RESOLUTION BANDWIDTH	Quasi-Peak, 120 kHz
TESTED BY	Star Le		

ANTENNA POLARITY & TEST DISTANCE: VERTICAL AT 3 M										
FREQ. (MHz)	EMISSION LEVEL (dBuV/m)	READ LEVEL (dBuV)	LIMIT (dBuV/m)	MARGIN (dB)	ANTENNA FACTOR (dB /m)	CABLE LOSS (dB)	PREAMP FACTOR (dB)	ANTENNA HEIGHT (cm)	TABLE ANGLE (Degree)	REMARK
45.52	36.63	66.95	40	-3.37	6.08	1.03	37.43	200	278	QP
89.17	40.02	67.25	43.5	-3.48	8.37	1.45	37.05	100	20	QP
146.4	38.63	64.2	43.5	-4.87	9.38	1.86	36.81	100	55	QP
159.98	40.1	64.31	43.5	-3.4	10.6	1.93	36.74	100	25	QP
191.99	40.14	64.21	43.5	-3.36	10.4	2.13	36.6	100	355	QP
276.38	41.19	61.83	46	-4.81	13.28	2.59	36.51	200	163	QP

- REMARKS:**
1. Peak detector quick scan is showed on the graph and final quasi-peak detector data is measured corresponding to relevant limit and recorded in the data table.
 2. Negative sign (-) in the margin column signify levels below the limit.
 3. Frequency range scanned: 30MHz to 1000MHz.
 4. Only emissions significantly above equipment noise floor are reported.

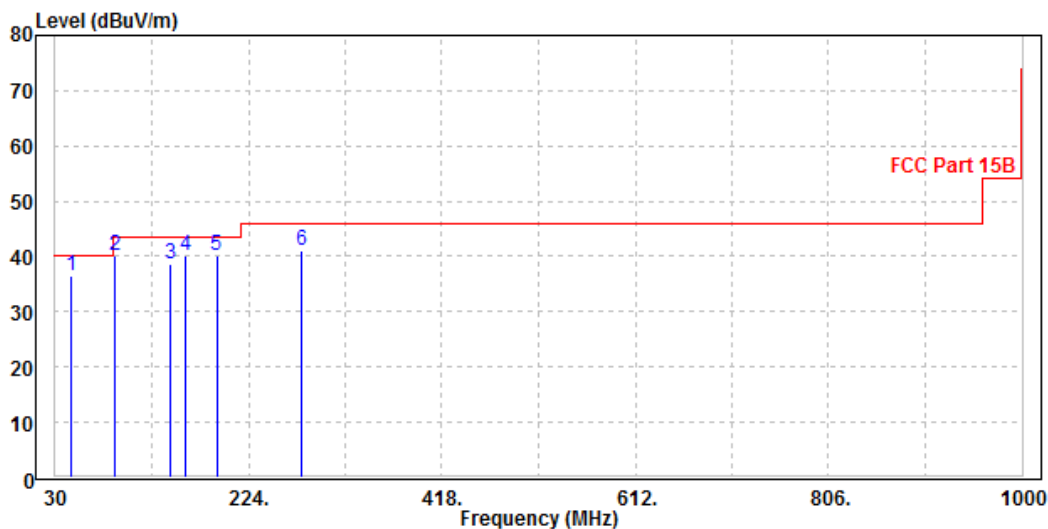

TEST VOLTAGE	DC 5V From Adapter Input 120 Vac, 60 Hz	FREQUENCY RANGE	1-18 GHz
ENVIRONMENTAL CONDITIONS	23deg. C, 70 %RH	DETECTOR FUNCTION & RESOLUTION BANDWIDTH	Peak/Average, 1 MHz
TESTED BY	Star Le		

ANTENNA POLARITY & TEST DISTANCE: HORIZONTAL AT 3 M										
FREQ. (MHz)	EMISSION LEVEL (dBuV/m)	READ LEVEL (dBuV)	LIMIT (dBuV/m)	MARGIN (dB)	ANTENNA FACTOR (dB /m)	CABLE LOSS (dB)	PREAMP FACTOR (dB)	ANTENNA HEIGHT (cm)	TABLE ANGLE (Degree)	REMARK
1595	35.48	48	54	-18.52	29.31	6.53	48.36	100	120	Average
1595	42.29	54.81	74	-31.71	29.31	6.53	48.36	100	120	Peak
2715	36.12	43.09	54	-17.88	32.62	8.72	48.31	100	63	Average
2715	46.29	53.26	74	-27.71	32.62	8.72	48.31	100	63	Peak
3865	38.07	42.44	54	-15.93	33.58	10.58	48.53	100	112	Average
3865	47.73	52.1	74	-26.27	33.58	10.58	48.53	100	112	Peak

- REMARKS:**
1. Peak detector quick scan is showed on the graph and final quasi-peak detector data is measured corresponding to relevant limit and recorded in the data table.
 2. Negative sign (-) in the margin column signify levels below the limit.
 3. Frequency range scanned: 1GHz to 18GHz.
 4. Only emissions significantly above equipment noise floor are reported.

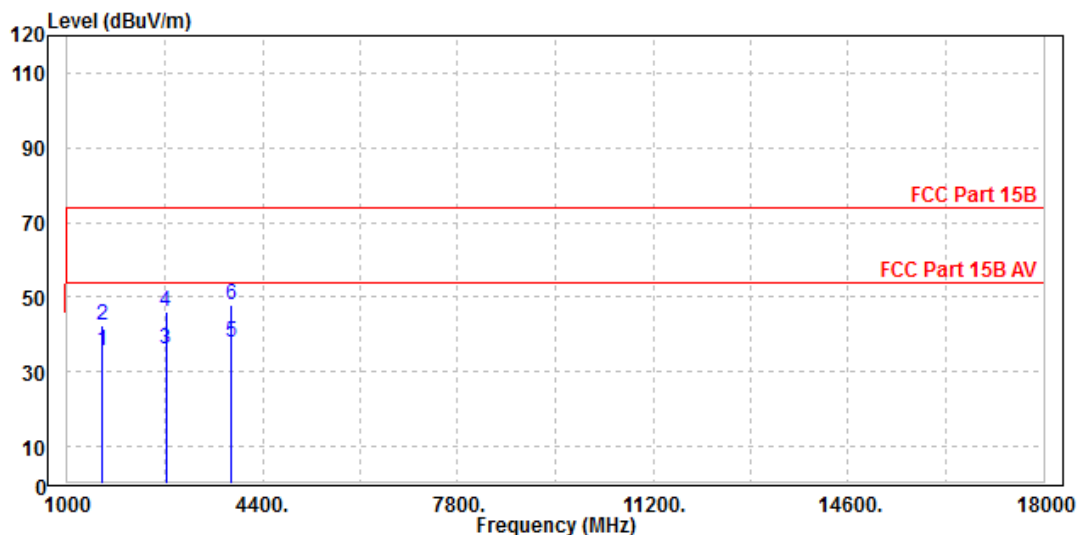

TEST VOLTAGE	DC 5V From Adapter Input 120 Vac, 60 Hz	FREQUENCY RANGE	1-18 GHz
ENVIRONMENTAL CONDITIONS	23deg. C, 70 %RH	DETECTOR FUNCTION & RESOLUTION BANDWIDTH	Peak/Average, 1 MHz
TESTED BY	Star Le		

ANTENNA POLARITY & TEST DISTANCE: VERTICAL AT 3 M										
FREQ. (MHz)	EMISSION LEVEL (dBuV/m)	READ LEVEL (dBuV)	LIMIT (dBuV/m)	MARGIN (dB)	ANTENNA FACTOR (dB /m)	CABLE LOSS (dB)	PREAMP FACTOR (dB)	ANTENNA HEIGHT (cm)	TABLE ANGLE (Degree)	REMARK
1595	35.87	48.39	54	-18.13	29.31	6.53	48.36	100	96	Average
1595	44.34	56.86	74	-29.66	29.31	6.53	48.36	100	96	Peak
2805	37.85	44.59	54	-16.15	32.71	8.87	48.32	100	248	Average
2805	49.57	56.31	74	-24.43	32.71	8.87	48.32	100	248	Peak
3670	40.42	45.37	54	-13.58	33.27	10.24	48.46	100	45	Average
3670	50.56	55.51	74	-23.44	33.27	10.24	48.46	100	45	Peak

- REMARKS:**
1. Peak detector quick scan is showed on the graph and final quasi-peak detector data is measured corresponding to relevant limit and recorded in the data table.
 2. Negative sign (-) in the margin column signify levels below the limit.
 3. Frequency range scanned: 1GHz to 18GHz.
 4. Only emissions significantly above equipment noise floor are reported.

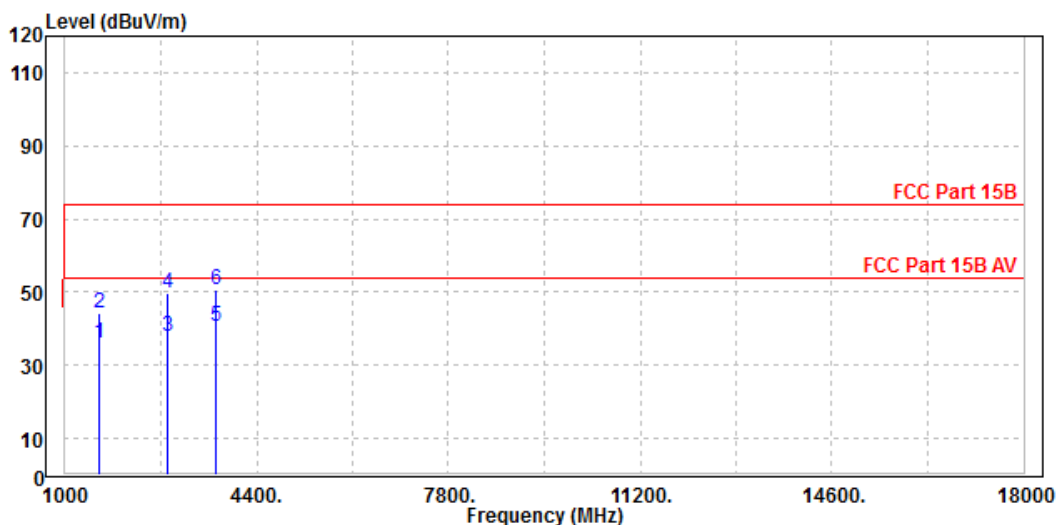



Test Report No.: FV180224W002

3 APPENDIX A – MODIFICATIONS RECORDERS FOR ENGINEERING CHANGES TO THE EUT BY THE LAB

No any modifications were made to the EUT by the lab during the test.

---END---