



FCC Test Report

APPLICANT : Corporativo Lanix S.A. de C.V.
EQUIPMENT : Smartphone
BRAND NAME : LANIX
MODEL NAME : Ilium L950
MARKETING NAME : Ilium L950
FCC ID : ZC4L950
STANDARD : FCC 47 CFR FCC Part 15 Subpart B
CLASSIFICATION : Certification

The product was received on Jun. 11, 2015 and testing was completed on Jul. 08, 2015. We, SPORTON INTERNATIONAL (SHENZHEN) INC., would like to declare that the tested sample has been evaluated in accordance with the test procedures given in ANSI C63.4-2009 and has been in compliance with the applicable technical standards.

The test results in this report apply exclusively to the tested model / sample. Without written approval of SPORTON INTERNATIONAL (SHENZHEN) INC., the test report shall not be reproduced except in full.

Reviewed by: Louis Wu / Manager

Approved by: Jones Tsai / Manager



SPORTON INTERNATIONAL (SHENZHEN) INC.

**1F & 2F, Building A, Morning Business Center, No. 4003 ShiGu Rd., Xili Town,
Nanshan District, Shenzhen, Guangdong, P. R. China**



TABLE OF CONTENTS

REVISION HISTORY..... 3

SUMMARY OF TEST RESULT 4

1. GENERAL DESCRIPTION 5

 1.1. Applicant..... 5

 1.2. Manufacturer 5

 1.3. Product Feature of Equipment Under Test 5

 1.4. Product Specification subjective to this standard..... 6

 1.5. Modification of EUT..... 7

 1.6. Test Location..... 7

 1.7. Applicable Standards 7

2. TEST CONFIGURATION OF EQUIPMENT UNDER TEST..... 8

 2.1. Test Mode 8

 2.2. Connection Diagram of Test System 10

 2.3. Support Unit used in test configuration and system..... 11

 2.4. EUT Operation Test Setup..... 11

3. TEST RESULT..... 12

 3.1. Test of AC Conducted Emission Measurement 12

 3.2. Test of Radiated Emission Measurement 18

4. LIST OF MEASURING EQUIPMENT 24

5. UNCERTAINTY OF EVALUATION 25

APPENDIX A. SETUP PHOTOGRAPHS



REVISION HISTORY

REPORT NO.	VERSION	DESCRIPTION	ISSUED DATE
FC561107	Rev. 01	Initial issue of report	Jul. 10, 2015



SUMMARY OF TEST RESULT

Report Section	FCC Rule	Description	Limit	Result	Remark
3.1	15.107	AC Conducted Emission	< 15.107 limits	PASS	Under limit 6.84 dB at 0.580 MHz
3.2	15.109	Radiated Emission	< 15.109 limits	PASS	Under limit 1.38 dB at 533.100 MHz for Quasi-Peak



1. General Description

1.1. Applicant

Corporativo Lanix S.A. de C.V.

Carretera Internacional Hermosillo-Nogales Km 8.5, Hermosillo Sonora, Mexico

1.2. Manufacturer

Shenzhen Tinno Mobile Technology Corp.

4/F, H-3 Building, OCT Eastern industrial Park, No.1 XiangShan East Road, Nan Shan District, Shenzhen, P.R. China

1.3. Product Feature of Equipment Under Test

Product Feature	
Equipment	Smartphone
Brand Name	LANIX
Model Name	Ilium L950
Marketing Name	Ilium L950
FCC ID	ZC4L950
EUT supports Radios application	GSM/GPRS/EGPRS/WCDMA/HSPA/ HSPA+(Downlink Only)/LTE/ WLAN 2.4GHz 802.11b/g/n HT20/ HT40 Bluetooth v3.0 + EDR/Bluetooth v4.0 LE
IMEI Code	Radiation: 353924025867130 Conduction: 353924025867007
HW Version	V1.0
SW Version	ILIUUM L950_TELCEL_SW_01
EUT Stage	Pre-Production

Remark: The above EUT's information was declared by manufacturer. Please refer to the specifications or user's manual for more detailed description.



1.4. Product Specification subjective to this standard

Product Specification subjective to this standard	
Tx Frequency	GSM850: 824.2 MHz ~ 848.8 MHz GSM1900: 1850.2 MHz ~ 1909.8MHz WCDMA Band V: 826.4 MHz ~ 846.6 MHz WCDMA Band II: 1852.4 MHz ~ 1907.6 MHz LTE Band 2 : 1850.7 MHz ~ 1909.3 MHz LTE Band 4 : 1710.7 MHz ~ 1754.3 MHz LTE Band 7 :2502.5 MHz ~ 2567.5 MHz 802.11b/g/n: 2412 MHz ~ 2462 MHz Bluetooth: 2402 MHz ~ 2480 MHz
Rx Frequency	GSM850: 869.2 MHz ~ 893.8 MHz GSM1900: 1930.2 MHz ~ 1989.8 MHz WCDMA Band V: 871.4 MHz ~ 891.6 MHz WCDMA Band II: 1932.4 MHz ~ 1987.6 MHz LTE Band 2 : 1930.7 MHz ~ 1989.3 MHz LTE Band 4 : 2110.7 MHz ~ 2154.3 MHz LTE Band 7 : 2622.5MHz ~ 2687.5 MHz 802.11b/g/n: 2412 MHz ~ 2462 MHz Bluetooth: 2402 MHz ~ 2480 MHz GPS : 1.57542 GHz
Antenna Type	WWAN : PIFA Antenna WLAN : PIFA Antenna Bluetooth :PIFA Antenna GPS : PIFA Antenna
Type of Modulation	GSM: GMSK GPRS: GMSK EDGE(MCS 0-4): GMSK / (MCS 5-9): 8PSK WCDMA: QPSK (Uplink) HSDPA: QPSK (Uplink) HSUPA: QPSK (Uplink) HSPA+: 16QAM (Downlink Only) LTE: QPSK / 16QAM 802.11b : DSSS (DBPSK / DQPSK / CCK) 802.11g/n : OFDM (BPSK / QPSK / 16QAM / 64QAM) Bluetooth v4.0 LE : GFSK Bluetooth (1Mbps) : GFSK Bluetooth (2Mbps) : $\pi/4$ -DQPSK Bluetooth (3Mbps) : 8-DPSK GPS : BPSK



1.5. Modification of EUT

No modifications are made to the EUT during all test items.

1.6. Test Location

Test Site	SPORTON INTERNATIONAL (SHENZHEN) INC.	
Test Site Location	1F & 2F, Building A, Morning Business Center, No. 4003 ShiGu Rd., Xili Town, Nanshan District, Shenzhen, Guangdong, P. R. China TEL: +86-755-8637-9589 FAX: +86-755-8637-9595	
Test Site No.	Sporton Site No.	
	CO01-SZ	

Test Site	SPORTON INTERNATIONAL (SHENZHEN) INC.	
Test Site Location	No. 3 Building, the third floor of south, Shahe River west, Fengzeyuan warehouse, Nanshan District, Shenzhen, Guangdong, P. R. China TEL: +86-755- 3320-2398	
Test Site No.	Sporton Site No.	FCC Registration No.
	03CH01-SZ	831040

Note: The test site complies with ANSI C63.4 2009 requirement.

1.7. Applicable Standards

According to the specifications of the manufacturer, the EUT must comply with the requirements of the following standards:

- ♦ FCC 47 CFR FCC Part 15 Subpart B
- ♦ ANSI C63.4-2009

Remark: All test items were verified and recorded according to the standards and without any deviation during the test.



2. Test Configuration of Equipment Under Test

2.1. Test Mode

The EUT has been associated with peripherals pursuant to ANSI C63.4-2009 and configuration operated in a manner tended to maximize its emission characteristics in a typical application.

Frequency range investigated: conduction (150 kHz to 30 MHz), radiation (30MHz to the 5th harmonic of the highest fundamental frequency or to 40 GHz, whichever is lower).

The following tables are showing the test modes as the worst cases and recorded in this report.

Item	EUT Configuration	Test Condition		
		EMI AC	EMI RE<1G	EMI RE≥1G
1.	Charging Mode (EUT with adapter)	☒	☒	☒
2.	Data application transferred mode (EUT with notebook)	☒	☒	☒

Abbreviations:

- EMI AC: AC conducted emissions
- EMI RE ≥ 1G: EUT radiated emissions ≥ 1GHz
- EMI RE < 1G: EUT radiated emissions < 1GHz



Test Items	EUT Configure Mode	Function Type
AC Conducted Emission	1/2	Mode 1: GSM850 Link + Bluetooth Link + WLAN Link + USB Cable (Charging from Adapter 1) + Earphone + Camera<Fig.1> Mode 2: WCDMA Band II Link + Bluetooth Link + WLAN Link + Earphone + USB Cable (Charging from Adapter 2) + MPEG4 <Fig.1> Mode 3: LTE Band 7 Link + Bluetooth Link + WLAN Link + Earphone + USB Cable (Data Link with Notebook) + GPS Rx <Fig.2> Mode 4: GSM1900 Link + Bluetooth Link + WLAN Link + USB Cable (Charging from Adapter 3) + Earphone + Camera<Fig.1>
Radiated Emissions < 1GHz	1/2	Mode 1: GSM850 Idle + Bluetooth Idle + WLAN Idle + USB Cable (Charging from Adapter 1) + Earphone + Camera<Fig.1> Mode 2: WCDMA Band II Idle + Bluetooth Idle + WLAN Idle + Earphone + USB Cable (Charging from Adapter 2) + MPEG4 <Fig.1> Mode 3: LTE Band 7 Idle + Bluetooth Idle + WLAN Idle + Earphone + USB Cable (Data Link with Notebook) + GPS Rx <Fig.2> Mode 4: GSM1900 Idle + Bluetooth Idle + WLAN Idle + USB Cable (Charging from Adapter 3) + Earphone + Camera<Fig.1>
Radiated Emissions ≥ 1GHz	1/2	Mode 1: LTE Band 7 Idle + Bluetooth Idle + WLAN Idle + Earphone + USB Cable (Data Link with Notebook) + GPS Rx <Fig.2> Mode 2: GSM1900 Idle + Bluetooth Idle + WLAN Idle + USB Cable (Charging from Adapter 3) + Earphone + Camera<Fig.1>

Remark:

1. The worst case of AC is mode 1; and the USB Link mode of AC is mode 3; the test data of these modes are reported.
2. The worst case of RE < 1G is mode 4; and the USB Link mode of RE is mode 3; only the test data of these modes are reported.
3. Link with notebook means data application transferred mode between EUT and notebook.

2.2. Connection Diagram of Test System

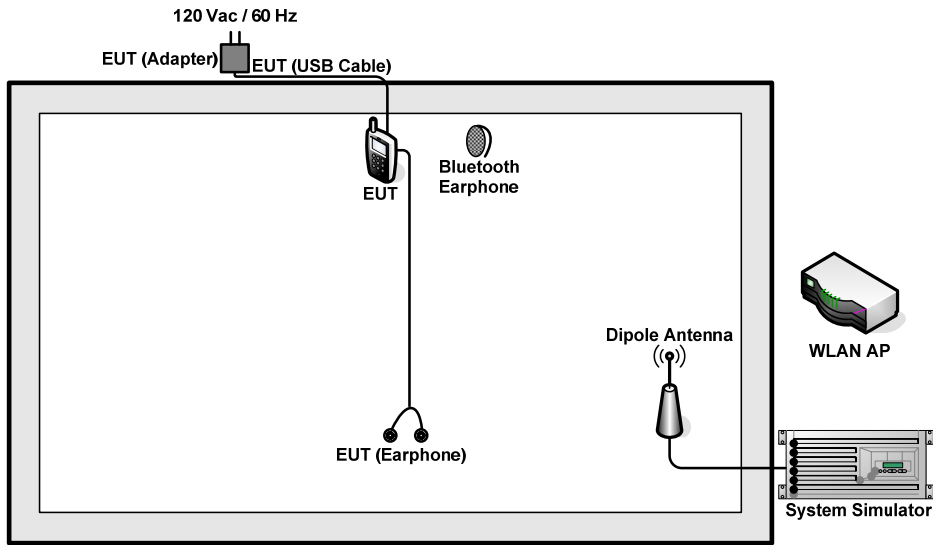

<Fig.1>

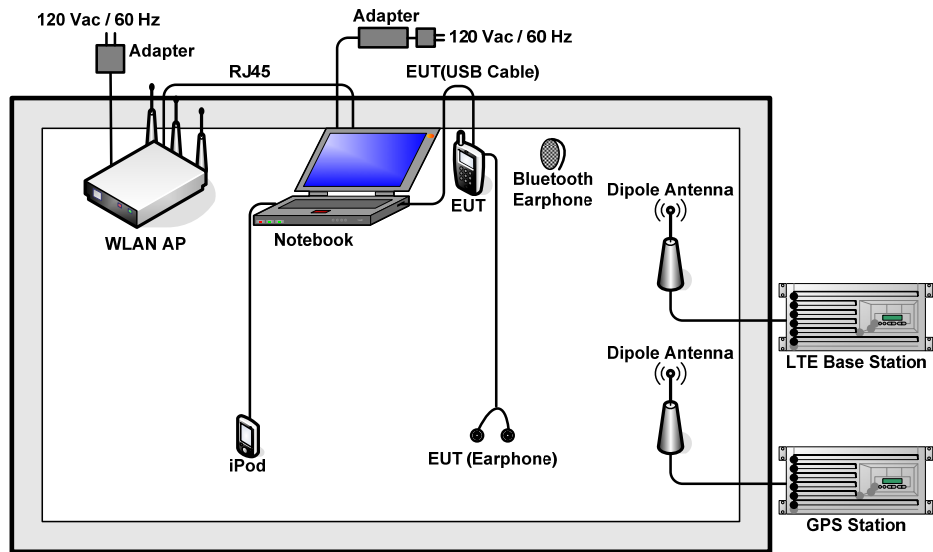

<Fig.2>

2.3. Support Unit used in test configuration and system

Item	Equipment	Trade Name	Model Name	FCC ID	Data Cable	Power Cord
1.	System Simulator	R&S	CMU 200	N/A	N/A	Unshielded, 1.8 m
2.	LTE Base Station	Anritsu	MT8820C	FCC DoC	Shielded, 1.5 m	N/A
3.	GPS Station	ADIVIC	MP9000	N/A	N/A	Unshielded, 1.8 m
4.	WLAN AP	D-Link	DIR-615	N/A	N/A	Unshielded, 1.8 m
5.	WLAN AP	ASUSTek	RT-AC66U	MSQ-RTAC66U	N/A	Unshielded, 2.7m
6.	Notebook	Lenovo	E540	FCC DoC	N/A	AC I/P: Unshielded, 1.2m DC O/P: Shielded, 1.8 m
7.	Bluetooth Earphone	Lenovo	LBH301	N/A	N/A	N/A
8.	Bluetooth Earphone	Nokia	BH-108	PYAHS-107W	N/A	N/A
9.	iPod	Apple	MC525 ZP/A	FCC DoC	Shielded, 1.0 m	N/A

2.4. EUT Operation Test Setup

The EUT was in GSM or WCDMA or LTE idle mode during the testing. The EUT was synchronized to the BCCH, and is in continuous receiving mode by setting system simulator's paging reorganization.

At the same time, the EUT was attached to the Bluetooth earphone or WLAN AP, and the following programs installed in the EUT were programmed during the test.

1. Data application is transferred between notebook and EUT via USB cable.
2. Turn on GPS function to make the EUT receive continuous signals from GPS station.
3. Execute "Video Player" to play MPEG4 files.
4. Turn on camera to capture images.

3. Test Result

3.1. Test of AC Conducted Emission Measurement

3.1.1 Limits of AC Conducted Emission

For equipment that is designed to be connected to the public utility (AC) power line, the radio frequency voltage that is conducted back onto the AC power line on any frequency or frequencies within the band 150 kHz to 30 MHz shall not exceed the limits in the following table.

Frequency of emission (MHz)	Conducted limit (dBuV)	
	Quasi-peak	Average
0.15-0.5	66 to 56*	56 to 46*
0.5-5	56	46
5-30	60	50

*Decreases with the logarithm of the frequency.

3.1.2 Measuring Instruments

The measuring equipment is listed in the section 4 of this test report.

3.1.3 Test Procedure

1. The EUT was placed 0.4 meter from the conducting wall of the shielding room was kept at least 80 centimeters from any other grounded conducting surface.
2. Connect EUT to the power mains through a line impedance stabilization network (LISN).
3. All the support units are connecting to the other LISN.
4. The LISN provides 50 ohm coupling impedance for the measuring instrument.
5. The FCC states that a 50 ohm, 50 microhenry LISN should be used.
6. Both sides of AC line were checked for maximum conducted interference.
7. The frequency range from 150 kHz to 30 MHz was searched.
8. Set the test-receiver system to Peak Detect Function and specified bandwidth (IF Bandwidth = 9kHz) with Maximum Hold Mode. Then measurement is also conducted by Average Detector and Quasi-Peak Detector Function respectively.

3.1.4 Test Setup





3.1.5 Test Result of AC Conducted Emission

Test Mode :	Mode 1	Temperature :	21~22°C
Test Engineer :	Jack Tian	Relative Humidity :	41~42%
Test Voltage :	120Vac / 60Hz	Phase :	Line
Function Type :	GSM850 Link + Bluetooth Link + WLAN Link + USB Cable (Charging from Adapter 1) + Earphone + Camera		

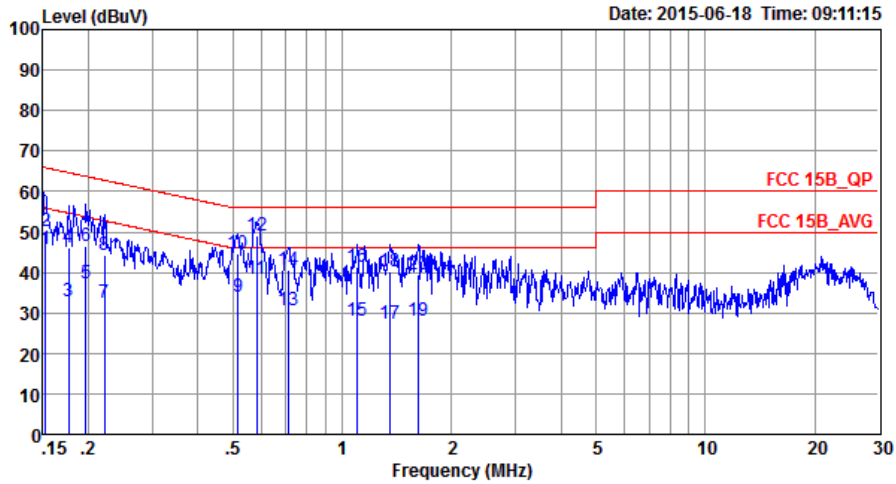

Site : CO01-SZ
 Condition: FCC 15B_QP LISN_L_20150304 LINE
 Project : (FC)561107
 Mode : Mode 1
 IMEI : 353924025867007

	Freq	Level	Over Limit	Limit Line	Read Level	LISN Factor	Cable Loss	Remark
	MHz	dBuV	dB	dBuV	dBuV	dB	dB	
1	0.15	45.59	-10.28	55.87	34.79	0.44	10.36	Average
2	0.15	50.09	-15.78	65.87	39.29	0.44	10.36	QP
3	0.18	33.00	-21.64	54.64	22.20	0.48	10.32	Average
4	0.18	46.20	-18.44	64.64	35.40	0.48	10.32	QP
5	0.20	37.11	-16.65	53.76	26.30	0.51	10.30	Average
6	0.20	46.61	-17.15	63.76	35.80	0.51	10.30	QP
7	0.22	32.50	-20.24	52.74	21.70	0.53	10.27	Average
8	0.22	44.10	-18.64	62.74	33.30	0.53	10.27	QP
9	0.52	33.81	-12.19	46.00	22.99	0.66	10.16	Average
10	0.52	44.71	-11.29	56.00	33.89	0.66	10.16	QP
11	0.58	38.46	-7.54	46.00	27.70	0.61	10.15	Average
12	0.58	49.16	-6.84	56.00	38.40	0.61	10.15	QP
13	0.71	30.79	-15.21	46.00	20.10	0.54	10.15	Average
14	0.71	40.69	-15.31	56.00	30.00	0.54	10.15	QP
15	1.10	28.16	-17.84	46.00	17.50	0.50	10.16	Average
16	1.10	41.46	-14.54	56.00	30.80	0.50	10.16	QP
17	1.36	27.45	-18.55	46.00	16.79	0.49	10.17	Average
18	1.36	40.15	-15.85	56.00	29.49	0.49	10.17	QP
19	1.62	27.95	-18.05	46.00	17.29	0.48	10.18	Average
20	1.62	39.55	-16.45	56.00	28.89	0.48	10.18	QP



Test Mode :	Mode 1	Temperature :	21~22°C
Test Engineer :	Jack Tian	Relative Humidity :	41~42%
Test Voltage :	120Vac / 60Hz	Phase :	Neutral
Function Type :	GSM850 Link + Bluetooth Link + WLAN Link + USB Cable (Charging from Adapter 1) + Earphone + Camera		

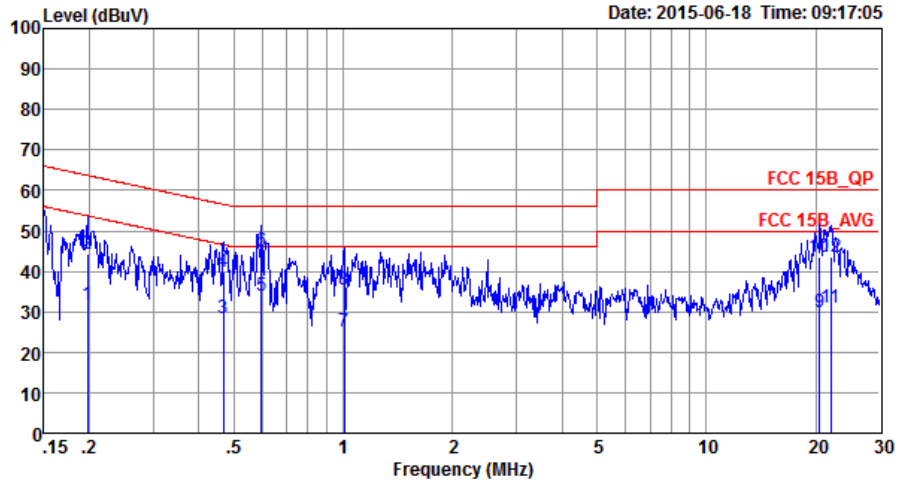

Site : CO01-SZ
 Condition: FCC 15B_QP LISN_N_20150304 NEUTRAL
 Project : (FC)561107
 Mode : Mode 1
 IMEI : 353924025867007

	Freq	Level	Over Limit	Limit Line	Read Level	LISN Factor	Cable Loss	Remark
	MHz	dBuV	dB	dBuV	dBuV	dB	dB	
1	0.20	31.80	-21.91	53.71	20.99	0.51	10.30	Average
2	0.20	44.10	-19.61	63.71	33.29	0.51	10.30	QP
3	0.47	28.55	-17.99	46.54	17.80	0.59	10.16	Average
4	0.47	39.95	-16.59	56.54	29.20	0.59	10.16	QP
5	0.59	34.13	-11.87	46.00	23.40	0.58	10.15	Average
6 *	0.59	45.03	-10.97	56.00	34.30	0.58	10.15	QP
7	1.00	25.21	-20.79	46.00	14.50	0.56	10.15	Average
8	1.00	35.31	-20.69	56.00	24.60	0.56	10.15	QP
9	20.49	30.02	-19.98	50.00	18.70	0.70	10.62	Average
10	20.49	43.62	-16.38	60.00	32.30	0.70	10.62	QP
11	22.06	30.93	-19.07	50.00	19.60	0.74	10.59	Average
12	22.06	43.43	-16.57	60.00	32.10	0.74	10.59	QP



Test Mode :	Mode 3	Temperature :	21~22°C
Test Engineer :	Jack Tian	Relative Humidity :	41~42%
Test Voltage :	120Vac / 60Hz	Phase :	Line
Function Type :	LTE Band 7 Link + Bluetooth Link + WLAN Link + Earphone + USB Cable (Data Link with Notebook) + GPS Rx		

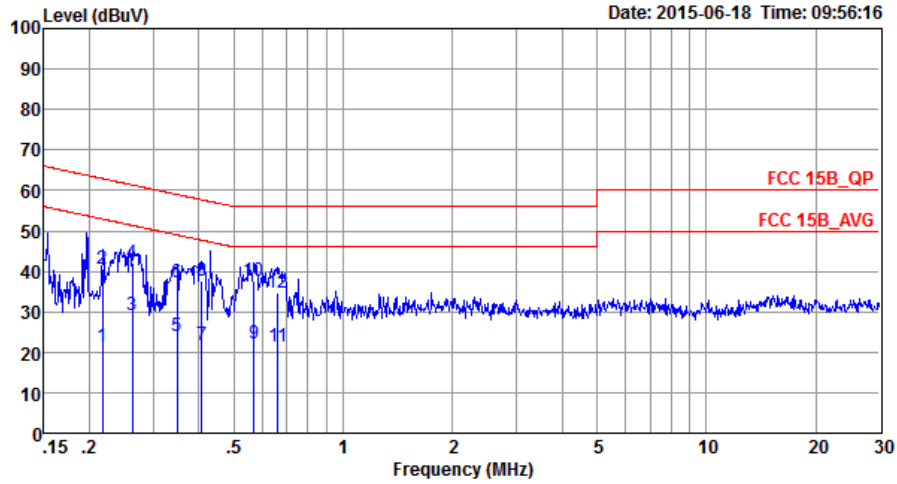

Site : C001-SZ
 Condition: FCC 15B_QP LISN_L_20150304 LINE
 Project : (FC)561107
 Mode : Mode 3
 IMEI : 353924025867007

	Freq	Level	Over Limit	Limit Line	Read Level	LISN Factor	Cable Loss	Remark
	MHz	dBuV	dB	dBuV	dBuV	dB	dB	
1	0.22	21.41	-31.51	52.92	10.61	0.53	10.27	Average
2	0.22	40.51	-22.41	62.92	29.71	0.53	10.27	QP
3	0.26	29.18	-22.16	51.34	18.40	0.55	10.23	Average
4	0.26	41.98	-19.36	61.34	31.20	0.55	10.23	QP
5	0.35	23.94	-25.06	49.00	13.20	0.55	10.19	Average
6	0.35	37.14	-21.86	59.00	26.40	0.55	10.19	QP
7	0.41	21.62	-26.06	47.68	10.90	0.55	10.17	Average
8	0.41	37.72	-19.96	57.68	27.00	0.55	10.17	QP
9	0.57	22.27	-23.73	46.00	11.50	0.62	10.15	Average
10 *	0.57	37.47	-18.53	56.00	26.70	0.62	10.15	QP
11	0.66	21.31	-24.69	46.00	10.60	0.56	10.15	Average
12	0.66	34.71	-21.29	56.00	24.00	0.56	10.15	QP



Test Mode :	Mode 3	Temperature :	21~22°C
Test Engineer :	Jack Tian	Relative Humidity :	41~42%
Test Voltage :	120Vac / 60Hz	Phase :	Neutral
Function Type :	LTE Band 7 Link + Bluetooth Link + WLAN Link + Earphone + USB Cable (Data Link with Notebook) + GPS Rx		

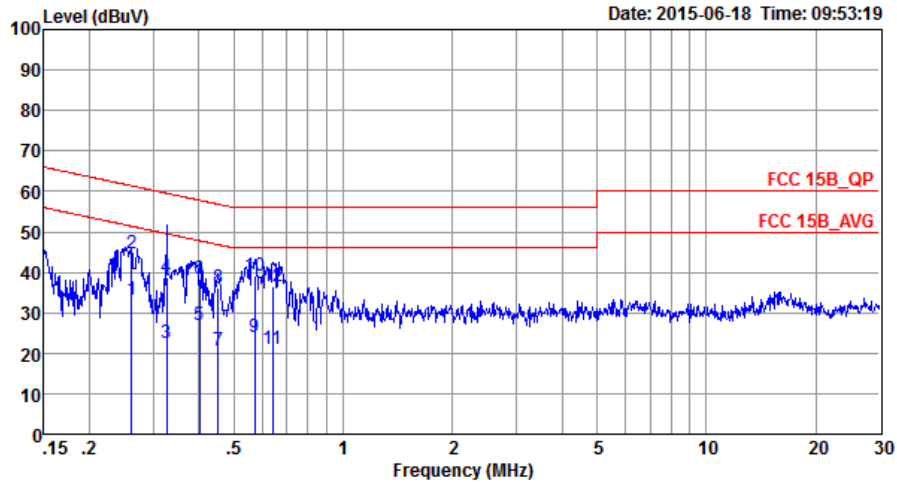

Site : CO01-SZ
 Condition: FCC 15B_QP LISN_N_20150304 NEUTRAL
 Project : (FC)561107
 Mode : Mode 3
 IMEI : 353924025867007

	Freq	Level	Over Limit	Limit Line	Read Level	LISN Factor	Cable Loss	Remark
	MHz	dBuV	dB	dBuV	dBuV	dB	dB	
1	0.26	33.19	-18.19	51.38	22.40	0.56	10.23	Average
2	0.26	44.59	-16.79	61.38	33.80	0.56	10.23	QP
3	0.33	22.57	-26.96	49.53	11.80	0.58	10.19	Average
4	0.33	38.67	-20.86	59.53	27.90	0.58	10.19	QP
5	0.40	27.12	-20.69	47.81	16.40	0.55	10.17	Average
6	0.40	38.42	-19.39	57.81	27.70	0.55	10.17	QP
7	0.45	20.64	-26.21	46.85	9.90	0.58	10.16	Average
8	0.45	36.34	-20.51	56.85	25.60	0.58	10.16	QP
9	0.57	23.94	-22.06	46.00	13.20	0.59	10.15	Average
10 *	0.57	39.24	-16.76	56.00	28.50	0.59	10.15	QP
11	0.64	21.02	-24.98	46.00	10.30	0.57	10.15	Average
12	0.64	36.42	-19.58	56.00	25.70	0.57	10.15	QP



3.2. Test of Radiated Emission Measurement

3.2.1. Limit of Radiated Emission

The emissions from an unintentional radiator shall not exceed the field strength levels specified in the following table:

Frequency (MHz)	Field Strength (microvolts/meter)	Measurement Distance (meters)
30 – 88	100	3
88 – 216	150	3
216 - 960	200	3
Above 960	500	3

3.2.2. Measuring Instruments

The measuring equipment is listed in the section 4 of this test report.

3.2.3. Test Procedures

1. The EUT was placed on a turntable with 0.8 meter above ground.
2. The EUT was set 3 meters from the interference receiving antenna, which was mounted on the top of a variable height antenna tower.
3. The table was rotated 360 degrees to determine the position of the highest radiation.
4. The antenna height is adjusted between one to four meters above ground to find the maximum value of the field strength for both horizontal polarization and vertical polarization of the antenna.
5. For each suspected emission, the EUT was arranged to its worst case and then tune the antenna tower (from 1 m to 4 m) and turntable (from 0 degree to 360 degrees) to find the maximum reading.
6. Set the test-receiver system to Peak Detect Function and specified bandwidth with Maximum Hold Mode (RBW=120kHz/VBW=300kHz for frequency below 1GHz; RBW=1MHz VBW=3MHz (Peak), RBW=1MHz/VBW=10Hz (Average) for frequency above 1GHz).
7. If the emission level of the EUT in peak mode was 3 dB lower than the limit specified, peak values of EUT will be reported. Otherwise, the emission will be repeated by using the quasi-peak method and reported.
8. Emission level (dB μ V/m) = 20 log Emission level (μ V/m)
9. Corrected Reading: Antenna Factor + Cable Loss + Read Level - Preamp Factor = Level

3.2.4. Test Setup of Radiated Emission

For radiated emissions from 30MHz to 1GHz



For radiated emissions above 1GHz

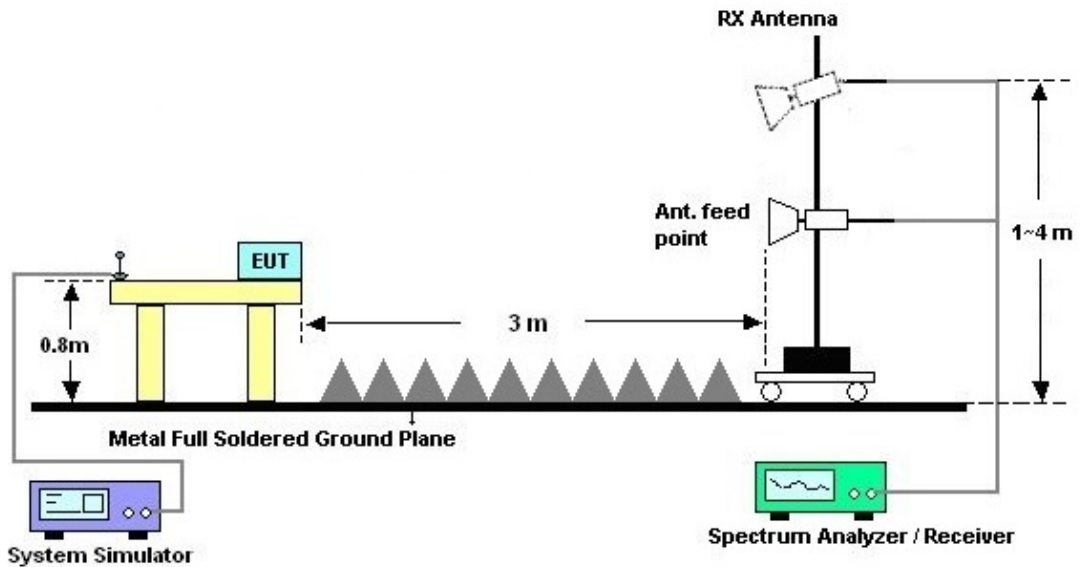



3.2.5. Test Result of Radiated Emission

Test Mode :	Mode 3	Temperature :	24~25°C
Test Engineer :	Leo Liao	Relative Humidity :	50~52%
Test Distance :	3m	Polarization :	Horizontal
Function Type :	LTE Band 7 Idle + Bluetooth Idle + WLAN Idle + Earphone + USB Cable (Data Link with Notebook) + GPS Rx		
Remark :	#8 is system simulator signal which can be ignored.		

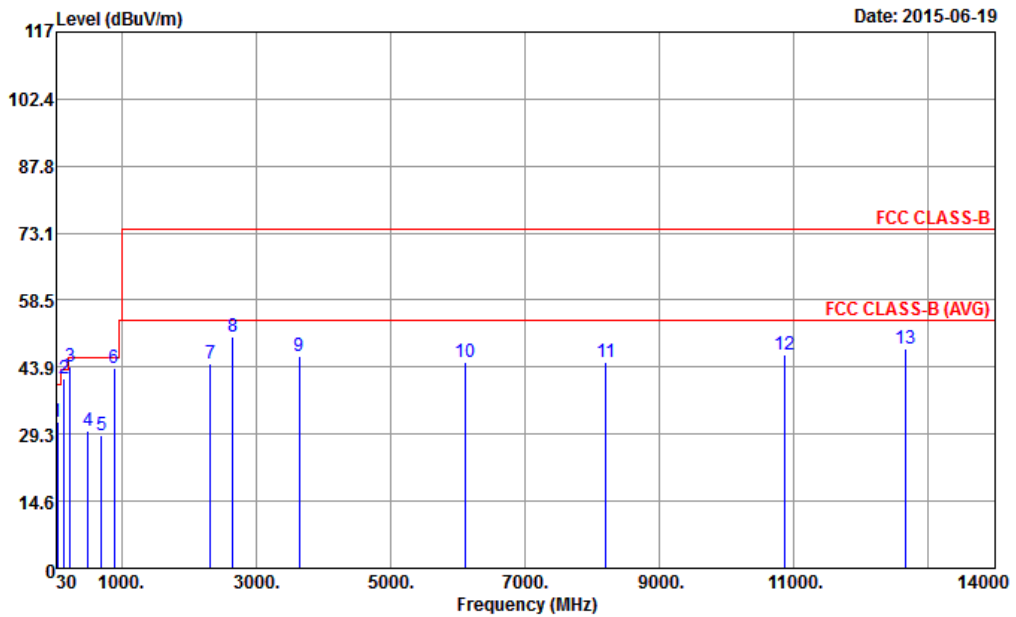

Site : 03CH01-SZ
 Condition : FCC CLASS-B 3m LF_ANT_141107 HORIZONTAL
 Project : (FC) 561107
 Mode : Mode 3
 IMEI : 353924025867130
 Plane : Y

	Freq	Level	Over	Limit	ReadAntenna	Cable	Preamp	A/Pos	T/Pos	Remark
	MHz	dBuV/m	dB	dBuV/m	dBuV	dB/m	dB	dB	cm	deg
1	45.39	32.02	-7.98	40.00	44.98	11.99	1.03	25.98	---	---
2	151.77	41.44	-2.06	43.50	52.18	12.85	1.91	25.50	100	20 QP
3	239.79	44.00	-2.00	46.00	54.52	12.23	2.42	25.17	100	0 QP
4	498.10	29.92	-16.08	46.00	33.36	19.32	3.57	26.33	---	---
5	697.60	29.10	-16.90	46.00	30.92	20.28	4.27	26.37	---	---
6	888.70	43.54	-2.46	46.00	42.85	21.70	4.89	25.90	120	80 QP
7	2328.00	44.78	-29.22	74.00	33.09	32.53	8.43	29.27	---	---
8	2654.00	50.67			37.90	32.82	9.11	29.16	---	---
9	3640.00	46.21	-27.79	74.00	29.65	33.54	11.41	28.39	---	---
10	6126.00	45.07	-28.93	74.00	23.29	35.93	13.90	28.05	---	---
11	8214.00	44.93	-29.07	74.00	18.76	36.38	16.17	26.38	---	---
12	10870.00	46.57	-27.43	74.00	15.12	38.73	17.51	24.79	---	---
13	12674.00	48.02	-25.98	74.00	14.46	39.19	18.57	24.20	100	253 Peak



Test Mode :	Mode 3	Temperature :	24~25°C
Test Engineer :	Leo Liao	Relative Humidity :	50~52%
Test Distance :	3m	Polarization :	Vertical
Function Type :	LTE Band 7 Idle + Bluetooth Idle + WLAN Idle + Earphone + USB Cable (Data Link with Notebook) + GPS Rx		
Remark :	#8 is system simulator signal which can be ignored.		

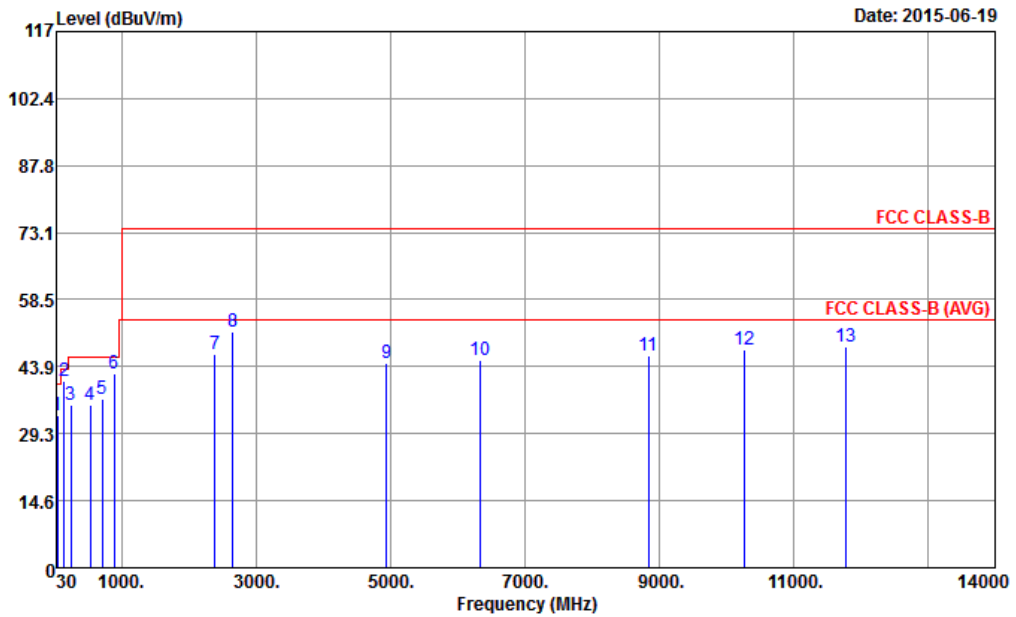

Site : 03CH01-SZ
 Condition : FCC CLASS-B 3m LF_ANT_141107 VERTICAL
 Project : (FC) 561107
 Mode : Mode 3
 IMEI : 353924025867130
 Plane : Y

	Freq	Level	Over	Limit	ReadAntenna	Cable	Preamp	A/Pos	T/Pos	Remark
	MHz	dBuV/m	Limit	Line	Level	Loss	Factor	cm	deg	
			dB	dBuV/m	dBuV	dB	dB			
1	44.31	33.36	-6.64	40.00	45.91	12.41	1.02	25.98	---	Peak
2	143.67	40.59	-2.91	43.50	50.70	13.58	1.86	25.55	180	50 QP
3	244.92	35.58	-10.42	46.00	45.96	12.32	2.45	25.15	---	Peak
4	533.10	35.49	-10.51	46.00	38.64	19.50	3.72	26.37	---	Peak
5	710.90	36.84	-9.16	46.00	38.37	20.53	4.29	26.35	---	Peak
6	888.70	42.50	-3.50	46.00	41.81	21.70	4.89	25.90	---	Peak
7	2394.00	46.61	-27.39	74.00	34.79	32.60	8.60	29.38	---	Peak
8	2654.00	51.37			38.60	32.82	9.11	29.16	---	Peak
9	4942.00	44.67	-29.33	74.00	25.34	34.47	13.04	28.18	---	Peak
10	6328.00	45.44	-28.56	74.00	23.07	36.12	14.21	27.96	---	Peak
11	8840.00	46.19	-27.81	74.00	19.05	36.60	16.52	25.98	---	Peak
12	10274.00	47.53	-26.47	74.00	16.82	38.33	17.50	25.12	---	Peak
13	11772.00	48.19	-25.81	74.00	14.47	39.37	18.84	24.49	100	200 Peak



Test Mode :	Mode 4	Temperature :	24~25°C
Test Engineer :	Leo Liao	Relative Humidity :	50~52%
Test Distance :	3m	Polarization :	Horizontal
Function Type :	GSM1900 Idle + Bluetooth Idle + WLAN Idle + USB Cable (Charging from Adapter 3) + Earphone + Camera		
Remark :	#8 is system simulator signal which can be ignored.		

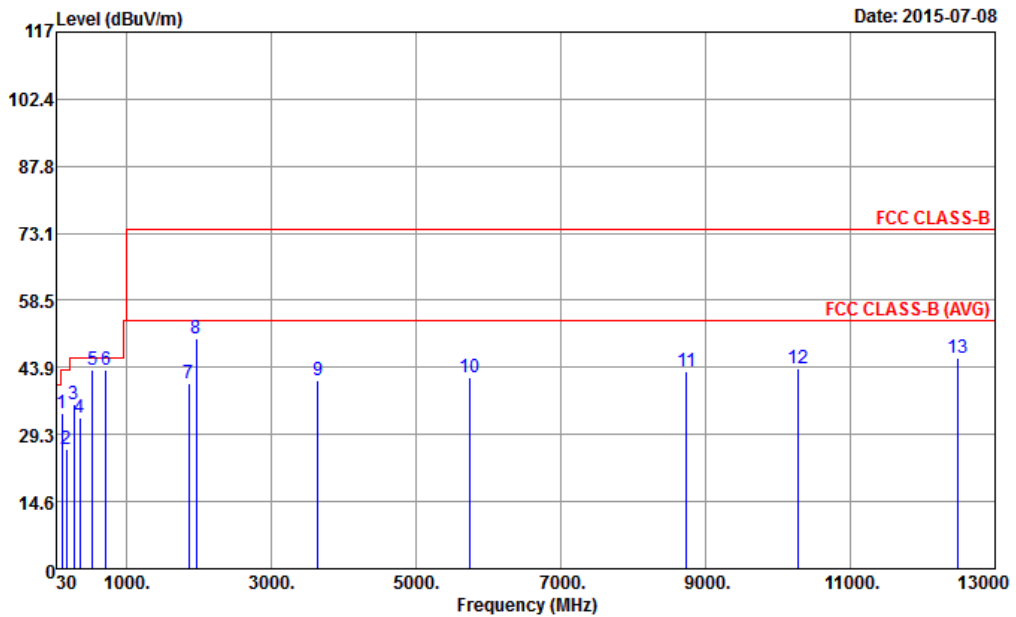

Site : 03CH01-SZ
 Condition : FCC CLASS-B 3m LF_ANT_141107 HORIZONTAL
 Project : (FC) 561107
 Mode : Mode 4
 IMEI : 353924025867130
 Plane : Y

	Freq	Level	Over	Limit	ReadAntenna	Cable	Preamp	A/Pos	T/Pos	Remark	
	MHz	dBuV/m	dB	dBuV/m	dBuV	dB/m	dB	dB	cm	deg	
1	102.36	34.05	-9.45	43.50	46.13	12.11	1.57	25.76	---	---	Peak
2	168.51	26.08	-17.42	43.50	37.57	11.90	2.02	25.41	---	---	Peak
3	273.81	35.84	-10.16	46.00	45.15	13.20	2.59	25.10	---	---	Peak
4	355.30	32.77	-13.23	46.00	40.43	14.82	2.99	25.47	---	---	Peak
5	533.10	43.19	-2.81	46.00	46.34	19.50	3.72	26.37	100	50	QP
6	710.90	43.21	-2.79	46.00	44.74	20.53	4.29	26.35	150	80	QP
7	1860.00	40.50	-33.50	74.00	31.36	30.97	7.51	29.34	---	---	Peak
8	1960.00	50.24			40.24	31.74	7.90	29.64	---	---	Peak
9	3640.00	41.21	-32.79	74.00	24.65	33.54	11.41	28.39	---	---	Peak
10	5752.00	41.69	-32.31	74.00	20.56	35.46	13.87	28.20	---	---	Peak
11	8740.00	43.17	-30.83	74.00	16.03	36.48	16.69	26.03	---	---	Peak
12	10274.00	43.82	-30.18	74.00	13.11	38.33	17.50	25.12	---	---	Peak
13	12480.00	46.09	-27.91	74.00	12.76	39.31	18.29	24.27	100	30	Peak



Test Mode :	Mode 4	Temperature :	24~25°C
Test Engineer :	Leo Liao	Relative Humidity :	50~52%
Test Distance :	3m	Polarization :	Vertical
Function Type :	GSM1900 Idle + Bluetooth Idle + WLAN Idle + USB Cable (Charging from Adapter 3) + Earphone + Camera		
Remark :	#7 is system simulator signal which can be ignored.		

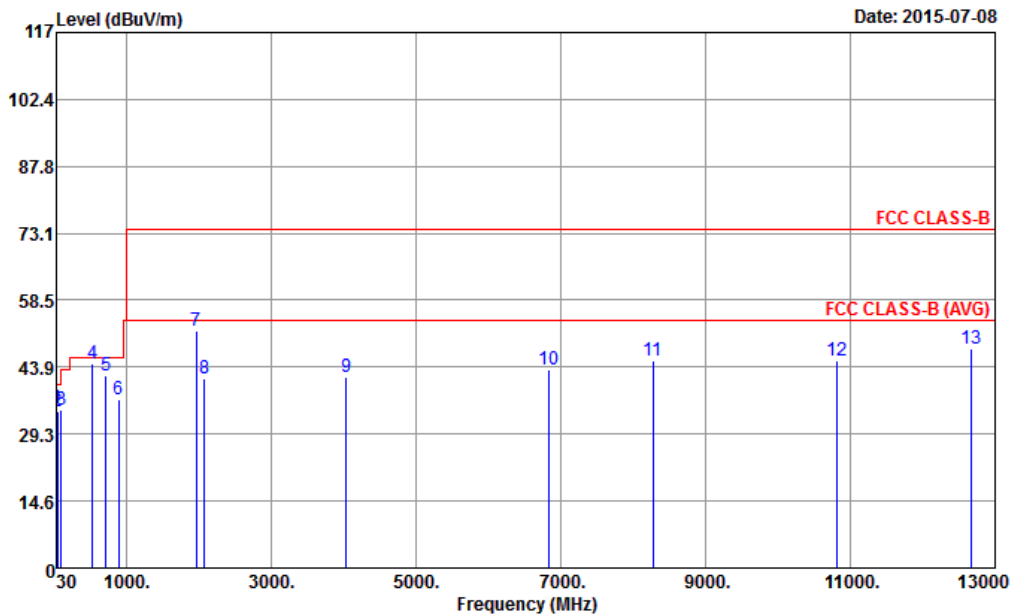

Site : 03CH01-SZ
 Condition : FCC CLASS-B 3m LF_ANT_141107 VERTICAL
 Project : (FC) 561107
 Mode : Mode 4
 IMEI : 353924025867130
 Plane : Y

	Freq	Level	Over	Limit	ReadAntenna	Cable	Preamp	A/Pos	T/Pos	Remark	
	MHz	dBuV/m	dB	dBuV/m	dBuV	dB/m	dB	dB	cm	deg	
1	30.81	34.96	-5.04	40.00	41.07	19.09	0.86	26.06	---	---	Peak
2	48.90	34.22	-5.78	40.00	48.40	10.74	1.06	25.98	---	---	Peak
3	100.74	34.64	-8.86	43.50	47.01	11.84	1.56	25.77	---	---	Peak
4	533.10	44.62	-1.38	46.00	47.77	19.50	3.72	26.37	120	0	QP
5	710.90	42.12	-3.88	46.00	43.65	20.53	4.29	26.35	---	---	Peak
6	889.40	36.67	-9.33	46.00	35.98	21.70	4.89	25.90	---	---	Peak
7	1960.00	51.94			41.94	31.74	7.90	29.64	---	---	Peak
8	2074.00	41.36	-32.64	74.00	30.45	32.27	8.10	29.46	---	---	Peak
9	4034.00	41.67	-32.33	74.00	24.68	33.92	11.61	28.54	---	---	Peak
10	6838.00	43.38	-30.62	74.00	20.02	36.17	14.51	27.32	---	---	Peak
11	8272.00	45.29	-28.71	74.00	19.05	36.33	16.26	26.35	---	---	Peak
12	10822.00	45.38	-28.62	74.00	14.11	38.70	17.39	24.82	---	---	Peak
13	12662.00	47.82	-26.18	74.00	14.26	39.20	18.57	24.21	150	80	Peak



4. List of Measuring Equipment

Instrument	Manufacturer	Model No.	Serial No.	Characteristics	Calibration Date	Test Date	Due Date	Remark
EMI Test Receiver&SA	Agilent Technologies	N9038A	MY52260185	20Hz~26.5GHz	May 26, 2015	Jun. 19, 2015~Jul. 08, 2015	May 25, 2016	Radiation (03CH01-SZ)
Bilog Antenna	TeseQ	CBL6112D	23188	30MHz~2GHz	Nov. 07, 2014	Jun. 19, 2015~Jul. 08, 2015	Nov. 06, 2015	Radiation (03CH01-SZ)
Double Ridge Horn Antenna	ETS-Lindgren	3117	00119436	1GHz~18GHz	Oct. 15, 2014	Jun. 19, 2015~Jul. 08, 2015	Oct. 14, 2015	Radiation (03CH01-SZ)
Amplifier	ADVANTEST	BB525C	E9007003	9kHz~3000MHz / 30 dB	Jan. 28, 2015	Jun. 19, 2015~Jul. 08, 2015	Jan. 27, 2016	Radiation (03CH01-SZ)
Amplifier	Agilent Technologies	83017A	MY39501302	500MHz~26.5GHz	Jan. 28, 2015	Jun. 19, 2015~Jul. 08, 2015	Jan. 27, 2016	Radiation (03CH01-SZ)
AC Power Source	Chroma	61601	616010001985	N/A	NCR	Jun. 19, 2015~Jul. 08, 2015	NCR	Radiation (03CH01-SZ)
Turn Table	EM	EM1000	N/A	0~360 degree	NCR	Jun. 19, 2015~Jul. 08, 2015	NCR	Radiation (03CH01-SZ)
Antenna Mast	EM	EM1000	N/A	1 m~4 m	NCR	Jun. 19, 2015~Jul. 08, 2015	NCR	Radiation (03CH01-SZ)
EMI Receiver	R&S	ESCI7	100724	9kHz~3GHz	Jan. 28, 2015	Jun. 18, 2015	Jan. 27, 2016	Conduction (CO01-SZ)
AC LISN	EMCO	3816/2SH	103892	9kHz~30MHz	Feb. 02, 2015	Jun. 18, 2015	Feb. 01, 2016	Conduction (CO01-SZ)
AC LISN (for auxiliary equipment)	MessTec	AN3016	16850	9kHz~30MHz	Feb. 02, 2015	Jun. 18, 2015	Feb. 01, 2016	Conduction (CO01-SZ)
AC Power Source	Chroma	61602	616020000891	100Vac~250Vac	Sep. 29, 2014	Jun. 18, 2015	Sep. 28, 2015	Conduction (CO01-SZ)
Pulse Limiter	COM-POWER	LIT-153 Transient Limiter	53139	150kHz~30MHz	Oct. 24, 2014	Jun. 18, 2015	Oct. 23, 2015	Conduction (CO01-SZ)



5. Uncertainty of Evaluation

Uncertainty of Conducted Emission Measurement (150 kHz ~ 30 MHz)

Measuring Uncertainty for a Level of Confidence of 95% ($U = 2Uc(y)$)	2.3dB
---	-------

Uncertainty of Radiated Emission Measurement (30 MHz ~ 1000 MHz)

Measuring Uncertainty for a Level of Confidence of 95% ($U = 2Uc(y)$)	3.9dB
---	-------