



Test Report No.: RF150212N021-5



# FCC TEST REPORT (PART 27)

**Product:** Smartphone  
**Model Name:** Ilium L900  
**FCC ID:** ZC4L900  
**Applicant:** Corporativo Lanix S.A. de C.V.  
**Address:** Carretera Internacional Hermosillo-Nogales Km 8.5,  
Hermosillo Sonora, Mexico  
**Manufacturer:** Tinno Mobile Technology Corp.  
4/F., H-3 Building, OCT Eastern Industrial Park. NO.1  
**Address:** XiangShan East Road., Nan Shan District, Shenzhen, P.R.  
China.  
**Prepared by:** Bureau Veritas Shenzhen Co., Ltd. Dongguan Branch  
**Lab Location:** No. 34, Chenwulu Section, Guantai Rd., Houjie Town,  
Dongguan City, Guangdong 523942, China  
**TEL:** +86 769 8593 5656  
**FAX:** +86 769 8593 1080  
**E-MAIL:** [customerservice.dg@cn.bureauveritas.com](mailto:customerservice.dg@cn.bureauveritas.com)  
**Report No.:** RF150212N021-5  
**Received Date:** Feb. 12, 2015  
**Test Date:** Feb. 12, 2015 ~ Mar. 11, 2015  
**Issued Date:** Mar. 12, 2015

This report should not be used by the client to claim product certification, approval, or endorsement by A2LA or any government agencies.

This report is for your exclusive use. Any copying or replication of this report to or for any other person or entity, or use of our name or trademark, is permitted only with our prior written permission. This report sets forth our findings solely with respect to the test samples identified herein. The results set forth in this report are not indicative or representative of the quality or characteristics of the lot from which a test sample was taken or any similar or identical product unless specifically and expressly noted. Our report includes all of the tests requested by you and the results thereof based upon the information that you provided to us. You have 60 days from date of issuance of this report to notify us of any material error or omission caused by our negligence, provided, however, that such notice shall be in writing and shall specifically address the issue you wish to raise. A failure to raise such issue within the prescribed time shall constitute your unqualified acceptance of the completeness of this report, the tests conducted and the correctness of the report contents. Unless specific mention, the uncertainty of measurement has been explicitly taken into account to declare the compliance or non-compliance to the specification

Bureau Veritas Shenzhen Co., Ltd.  
Dongguan Branch

No. 34, Chenwulu Section, Guantai Rd.,  
Houjie Town, Dongguan City,  
Guangdong 523942, China

Tel: +86 769 8593 5656  
Fax: +86 769 8593 1080  
Email: [customerservice.dg@cn.bureauveritas.com](mailto:customerservice.dg@cn.bureauveritas.com)



# TABLE OF CONTENTS

**RELEASE CONTROL RECORD ..... 4**

**1 CERTIFICATION ..... 5**

**2 SUMMARY OF TEST RESULTS ..... 6**

2.1 MEASUREMENT UNCERTAINTY ..... 6

2.2 TEST SITE AND INSTRUMENTS ..... 7

**3 GENERAL INFORMATION..... 8**

3.1 GENERAL DESCRIPTION OF EUT ..... 8

3.2 CONFIGURATION OF SYSTEM UNDER TEST ..... 10

3.3 DESCRIPTION OF SUPPORT UNITS .....11

3.4 DESCRIPTION OF TEST MODES .....11

3.5 GENERAL DESCRIPTION OF APPLIED STANDARDS ..... 15

**4 TEST TYPES AND RESULTS ..... 16**

4.1 OUTPUT POWER MEASUREMENT ..... 16

4.1.1 LIMITS OF OUTPUT POWER MEASUREMENT ..... 16

4.1.2 TEST PROCEDURES ..... 16

4.1.3 TEST SETUP ..... 17

4.1.4 TEST RESULTS ..... 18

4.2 FREQUENCY STABILITY MEASUREMENT ..... 31

4.2.1 LIMITS OF FREQUENCY STABILIIY MEASUREMENT ..... 31

4.2.2 TEST PROCEDURE ..... 31

4.2.3 TEST SETUP ..... 31

4.2.4 TEST RESULTS ..... 32

4.3 OCCUPIED BANDWIDTH MEASUREMENT ..... 34

4.3.1 LIMITS OF OCCUPIED BANDWIDTH MEASUREMENT ..... 34

4.3.2 TEST SETUP ..... 34

4.3.3 TEST PROCEDURES ..... 34

4.3.4 TEST RESULTS ..... 35

4.4 PEAK TO AVERAGE RATIO ..... 39

4.4.1 LIMITS OF PEAK TO AVERAGE RATIO MEASUREMENT ..... 39

4.4.2 TEST SETUP ..... 39

4.4.3 TEST PROCEDURES ..... 39

4.4.4 TEST RESULTS ..... 40

4.5 BAND EDGE MEASUREMENT ..... 44

4.5.1 LIMITS OF BAND EDGE MEASUREMENT ..... 44

4.5.2 TEST SETUP ..... 44

4.5.3 TEST PROCEDURES ..... 44

4.5.4 TEST RESULTS ..... 46

4.6 CONDUCTED SPURIOUS EMISSIONS ..... 54

4.6.1 LIMITS OF CONDUCTED SPURIOUS EMISSIONS MEASUREMENT ..... 54

4.6.2 TEST PROCEDURE ..... 54

4.6.3 TEST SETUP ..... 54

4.6.4 TEST RESULTS ..... 55

4.7 RADIATED EMISSION MEASUREMENT ..... 57

4.7.1 LIMITS OF RADIATED EMISSION MEASUREMENT ..... 57

4.7.2 TEST PROCEDURES ..... 57

4.7.3 DEVIATION FROM TEST STANDARD ..... 57

4.7.4 TEST SETUP ..... 58



**BUREAU  
VERITAS**

**Test Report No.: RF150212N021-5**

4.7.5	TEST RESULTS .....	59
5	INFORMATION ON THE TESTING LABORATORIES .....	79
6	APPENDIX A – MODIFICATIONS RECORDERS FOR ENGINEERING CHANGES TO THE EUT BY THE LAB .....	80



Test Report No.: RF150212N021-5

## RELEASE CONTROL RECORD

ISSUE NO.	REASON FOR CHANGE	DATE ISSUED
RF150212N021-5	Original release	Mar. 12, 2015



Test Report No.: RF150212N021-5

## 1 CERTIFICATION

**PRODUCT:** Smartphone  
**BRAND NAME:** LANIX  
**MODEL NAME:** Ilium L900  
**APPLICANT:** Corporativo Lanix S.A. de C.V.  
**TESTED:** Feb. 12, 2015 ~ Mar. 11, 2015  
**TEST SAMPLE:** Production unit  
**TEST STANDARDS:** **FCC Part 27, Subpart C, L**  
**FCC Part 2**  
ANSI C63.4-2003

The above equipment has been tested by **Bureau Veritas Shenzhen Co., Ltd. Dongguan Branch**, and found compliance with the requirement of the above standards. The test record, data evaluation & Equipment Under Test (EUT) configurations represented herein are true and accurate accounts of the measurements of the sample's EMC characteristics under the conditions specified in this report.

**TESTED BY :**  \_\_\_\_\_, **DATE :** Mar. 12, 2015  
Glyn He/ Project Engineer

**APPROVED BY :**  \_\_\_\_\_, **DATE :** Mar. 12, 2015  
Sam Tung / Technical Manager

## 2 SUMMARY OF TEST RESULTS

The EUT has been tested according to the following specifications:

APPLIED STANDARD: FCC Part 27 & Part 2			
STANDARD SECTION	TEST TYPE AND LIMIT	RESULT	REMARK
2.1046 27.50(d)(4)	Maximum Peak Output Power	PASS	Meet the requirement of limit.
2.1055 27.54	Frequency Stability	PASS	Meet the requirement of limit.
2.1049 27.53(h)	Occupied Bandwidth	PASS	Meet the requirement of limit.
27.50(d)(5)	Peak to average ratio	PASS	Meet the requirement of limit.
27.53(h)	Band Edge Measurements	PASS	Meet the requirement of limit.
2.1051 27.53(h)	Conducted Spurious Emissions	PASS	Meet the requirement of limit.
2.1053 27.53(h)	Radiated Spurious Emissions	PASS	Meet the requirement of limit. Minimum passing margin is -51.94dB at 6930.00MHz.

### 2.1 MEASUREMENT UNCERTAINTY

Where relevant, the following measurement uncertainty levels have been estimated for tests performed on the EUT as specified in CISPR 16-4-2:

MEASUREMENT	FREQUENCY	UNCERTAINTY
Conducted emissions	9kHz~30MHz	2.66dB
Radiated emissions	9KHz ~ 30MHz	2.74dB
	30MHz ~ 1GMHz	3.55dB
	1GHz ~ 18GHz	4.84dB
	18GHz ~ 40GHz	1.94dB

This uncertainty represents an expanded uncertainty expressed at approximately the 95% confidence level using a coverage factor of k=2.

## 2.2 TEST SITE AND INSTRUMENTS

Equipment	Manufacturer	Model No.	Serial No.	Last Cal.	Next Cal.
Spectrum Analyzer	Agilent	E4446A	MY46180622	Apr. 29,14	Apr. 28,15
Spectrum Analyzer (10Hz-40GHz)	Rohde&Schwarz	FSV40	101003	Apr. 09,14	Apr. 08,15
Signal Analyzer	Rohde&Schwarz	FSV7	102331	Nov. 05,14	Nov. 04,15
EMI Test Receiver	Rohde&Schwarz	ESVS10	841431/004	May 17,14	May 16,15
Loop antenna (9kHz-30MHz)	Daze	ZN30900A	0708	Dec. 05,14	Dec. 05,15
Bilog Antenna	Teseq	CBL 6111D	30643	Jul. 25, 14	Jul. 24, 15
Horn Antenna (1GHz -18GHz)	ETS -Lindgren	3117	00062558	May 30,14	May 29,15
Horn Antenna (15GHz-40GHz)	SCHWARZBECK	BBHA 9170	BBHA9170147	Jan. 21,15	Jan. 20,16
Signal Amplifier	Agilent	8447D	2944A10488	Jun. 25,14	Jun. 24,15
Pre-Amplifier (100MHz-26.5GHz)	Agilent	8449B	3008A00409	May 13,14	May 12,15
Pre-Amplifier (18GHz-40GHz)	EMCI	EMC 184045	980102	Nov. 20,14	Nov. 19,15
Digital Multimeter	FLUKE	15B	A1220010DG	Oct. 27,14	Oct. 26,15
Peak and Avg Power Sensor	Anritsu	MA2411B	1126068	Feb. 21,15	Feb. 20,16
Power Meter	Anritsu	ML2495A	1139001	Feb. 21,15	Feb. 20,16
3m Semi-anechoic Chamber	ETS-LINDGREN	9m*6m*6m	NSEMC003	Apr. 19,14	Apr. 18,15
Humid & Temp Programmable Tester	Haida	HD-2257	110807201	Sep.04,14	Sep. 03,15
Signal Generator	Agilent	N5183A	MY50140980	Nov. 05,14	Nov. 04,15
ESG Vector Signal Generator	Agilent	E4438C	MY49072505	Mar.14, 14	Mar. 13, 15
Test Software	ADT	ADT_Radiated _V7.6.15.9.2	N/A	N/A	N/A
BLUETOOTH TESTER	Rohde&Schwarz	CBT32	100811	Sep 04,14	Sep 03,15

- NOTE:**
1. The calibration interval of the above test instruments is 12 months or 24 months and the calibrations are traceable to CEPREI/CHINA, GRGT/CHINA and NIM/CHINA.
  2. The test was performed in Dongguan 966 Chamber.
  3. The horn antenna are used only for the measurement of emission frequency above 1GHz if tested.
  4. The FCC Site Registration No. is 502831.

### 3 GENERAL INFORMATION

#### 3.1 GENERAL DESCRIPTION OF EUT

<b>PRODUCT</b>	Smartphone		
<b>MODEL NAME</b>	Ilium L900		
<b>FCC ID</b>	ZC4L900		
<b>POWER SUPPLY</b>	5.0Vdc (adapter or host equipment) 3.8Vdc (battery)		
<b>MODULATION TECHNOLOGY</b>	<b>LTE Band 4</b>	QPSK, 16QAM	
	<b>LTE Band 17</b>	QPSK, 16QAM	
<b>FREQUENCY RANGE</b>	<b>LTE Band 4 Channel Bandwidth: 1.4MHz</b>	1710.7MHz ~ 1754.3MHz	
	<b>LTE Band 4 Channel Bandwidth: 3MHz</b>	1711.5MHz ~ 1753.5MHz	
	<b>LTE Band 4 Channel Bandwidth: 5MHz</b>	1712.5MHz ~ 1752.5MHz	
	<b>LTE Band 4 Channel Bandwidth: 10MHz</b>	1715.0MHz ~ 1750.0MHz	
	<b>LTE Band 4 Channel Bandwidth: 15MHz</b>	1717.5MHz ~ 1747.5MHz	
	<b>LTE Band 4 Channel Bandwidth: 20MHz</b>	1720.0MHz ~ 1745.0MHz	
	<b>LTE Band 17 Channel Bandwidth: 5MHz</b>	706.5MHz ~ 713.5MHz	
	<b>LTE Band 17 Channel Bandwidth: 10MHz</b>	709.0MHz ~ 711.0MHz	
	<b>EMISSION DESIGNATOR</b>	<b>LTE Band 4 Channel Bandwidth: 1.4MHz</b>	QPSK: 1M09G7D
			16QAM: 1M09W7D
<b>LTE Band 4 Channel Bandwidth: 3MHz</b>		QPSK: 2M69G7D	
		16QAM: 2M68W7D	
<b>LTE Band 4 Channel Bandwidth: 5MHz</b>		QPSK: 4M49G7D	
		16QAM: 4M49W7D	
<b>LTE Band 4 Channel Bandwidth: 10MHz</b>		QPSK: 8M94G7D	
		16QAM: 8M97W7D	
<b>LTE Band 4 Channel Bandwidth: 15MHz</b>		QPSK: 13M5G7D	
		16QAM: 13M4W7D	
<b>LTE Band 4 Channel Bandwidth: 20MHz</b>		QPSK: 18M0G7D	
		16QAM: 17M8W7D	
<b>LTE Band 17 Channel Bandwidth: 5MHz</b>	QPSK: 4M50G7D		
	16QAM: 4M47W7D		
<b>LTE Band 17 Channel Bandwidth: 10MHz</b>	QPSK: 8M97G7D		
	16QAM: 8M97W7D		





BUREAU  
VERITAS

Test Report No.: RF150212N021-5

<b>MAX. ERP/EIRP POWER</b>	<b>LTE Band 4 Channel Bandwidth: 1.4MHz</b>	192mW
	<b>LTE Band 4 Channel Bandwidth: 3MHz</b>	191mW
	<b>LTE Band 4 Channel Bandwidth: 5MHz</b>	185mW
	<b>LTE Band 4 Channel Bandwidth: 10MHz</b>	203mW
	<b>LTE Band 4 Channel Bandwidth: 15MHz</b>	226mW
	<b>LTE Band 4 Channel Bandwidth: 20MHz</b>	190mW
	<b>LTE Band 17 Channel Bandwidth: 5MHz</b>	115mW
	<b>LTE Band 17 Channel Bandwidth: 10MHz</b>	119mW
<b>ANTENNA TYPE</b>	<b>LTE Band 4</b>	Fixed Internal antenna with -1dBi gain
	<b>LTE Band 17</b>	Fixed Internal antenna with -1dBi gain
<b>HW VERSION</b>	V1.0	
<b>SW VERSION</b>	KTU84P	
<b>I/O PORTS</b>	Refer to user's manual	
<b>DATA CABLE</b>	USB Cable: unshielded, detachable, 1.0m Earphone Cable: shielded, detachable, 1.0m	

**NOTE:**

- For a more detailed features description, please refer to the manufacturer's specifications or the user's manual.
- The EUT was powered by the following adapter:

<b>ADAPTER</b>	
<b>BRAND:</b>	LANIX
<b>MODEL:</b>	Ilium L900-C
<b>INPUT:</b>	AC 100-240V, 150mA
<b>OUTPUT:</b>	DC 5V, 1000mA

- For the test results, the EUT had been tested with all conditions. But only the worst case was shown in test report.

### 3.2 CONFIGURATION OF SYSTEM UNDER TEST

#### FOR RADIATION EMISSION TEST

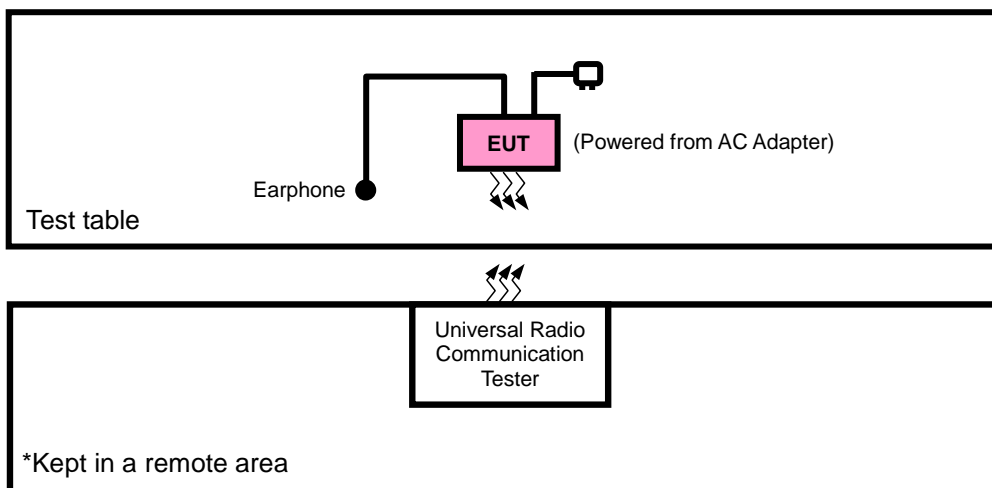

#### FOR E.R.P./E.I.R.P TEST

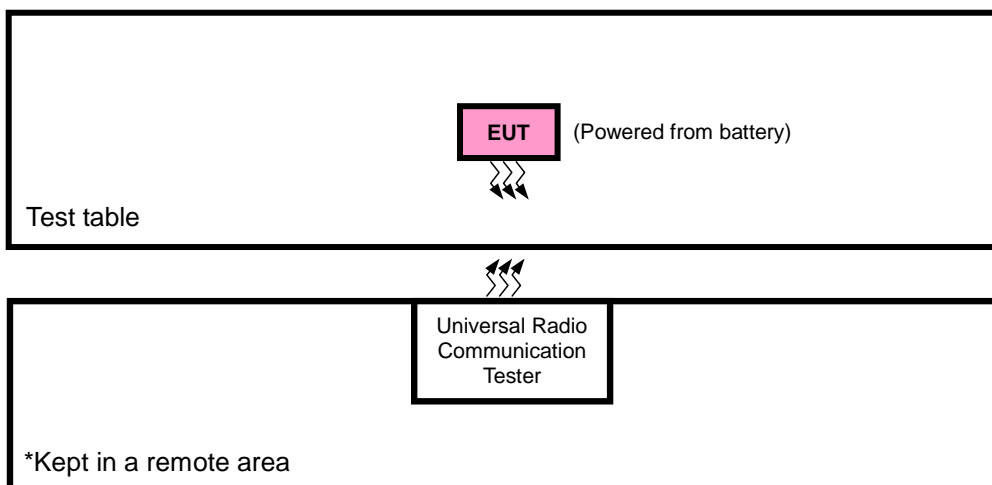

### 3.3 DESCRIPTION OF SUPPORT UNITS

The EUT has been tested as an independent unit together with other necessary accessories or support units. The following support units or accessories were used to form a representative test configuration during the tests.

NO.	PRODUCT	BRAND	MODEL NO.	SERIAL NO.	FCC ID
1	DC source	LONG WEI	PS-6403D	010934269	N/A
2	PC	HP	A6608CN	3CR83825X3	N/A

NO.	SIGNAL CABLE DESCRIPTION OF THE ABOVE SUPPORT UNITS
1	DC Line: Unshielded, Detachable 1.0m
2	AC Line: Unshielded, Detachable 1.5m

**NOTE:**

1. All power cords of the above support units are non shielded (1.8m).

### 3.4 DESCRIPTION OF TEST MODES

Pre-Scan has been conducted to determine the worst-case mode from all possible combinations between available modulations, data rates, XYZ axis and antenna ports. The worst case was found when positioned on X-plane for ERP/EIRP and X-axis for radiated emission. Following channel(s) was (were) selected for the final test as listed below:

EUT CONFIGURE MODE	DESCRIPTION
A	EUT + Adapter + Earphone with LTE link
B	EUT + Battery + Earphone with LTE link



**BUREAU  
VERITAS**

Test Report No.: RF150212N021-5

**LTE BAND 4**

EUT CONFIGURE MODE	TEST ITEM	AVAILABLE CHANNEL	TESTED CHANNEL	CHANNEL BANDWIDTH	MODULATION	MODE
B	EIRP	19957 to 20393	19957, 20175, 20393	1.4MHz	QPSK, 16QAM	1 RB / 0 RB Offset
		19965 to 20385	19965, 20175, 20385	3MHz	QPSK, 16QAM	1 RB / 0 RB Offset
		19975 to 20375	19975, 20175, 20375	5MHz	QPSK, 16QAM	1 RB / 0 RB Offset
		20000 to 20350	20000, 20175, 20350	10MHz	QPSK, 16QAM	1 RB / 0 RB Offset
		20025 to 20325	20025, 20175, 20325	15MHz	QPSK, 16QAM	1 RB / 0 RB Offset
		20050 to 20300	20050, 20175, 20300	20MHz	QPSK, 16QAM	1 RB / 0 RB Offset
B	FREQUENCY STABILITY	19957 to 20393	20175	1.4MHz	QPSK	1 RB / 0 RB Offset
		19965 to 20385	20175	3MHz	QPSK	1 RB / 0 RB Offset
		19975 to 20375	20175	5MHz	QPSK	1 RB / 0 RB Offset
		20000 to 20350	20175	10MHz	QPSK	1 RB / 0 RB Offset
		20025 to 20325	20175	15MHz	QPSK	1 RB / 0 RB Offset
		20050 to 20300	20175	20MHz	QPSK	1 RB / 0 RB Offset
B	OCCUPIED BANDWIDTH	19957 to 20393	19957, 20175, 20393	1.4MHz	QPSK, 16QAM	6 RB / 0 RB Offset
		19965 to 20385	19965, 20175, 20385	3MHz	QPSK, 16QAM	15 RB / 0 RB Offset
		19975 to 20375	19975, 20175, 20375	5MHz	QPSK, 16QAM	25 RB / 0 RB Offset
		20000 to 20350	20000, 20175, 20350	10MHz	QPSK, 16QAM	50 RB / 0 RB Offset
		20025 to 20325	20025, 20175, 20325	15MHz	QPSK, 16QAM	75 RB / 0 RB Offset
		20050 to 20300	20050, 20175, 20300	20MHz	QPSK, 16QAM	100 RB / 0 RB Offset
B	PEAK TO AVERAGE RATIO	19957 to 20393	19957, 20175, 20393	1.4MHz	QPSK, 16QAM	1 RB / 0 RB Offset
		19965 to 20385	19965, 20175, 20385	3MHz	QPSK, 16QAM	1 RB / 0 RB Offset
		19975 to 20375	19975, 20175, 20375	5MHz	QPSK, 16QAM	1 RB / 0 RB Offset
		20000 to 20350	20000, 20175, 20350	10MHz	QPSK, 16QAM	1 RB / 0 RB Offset
		20025 to 20325	20025, 20175, 20325	15MHz	QPSK, 16QAM	1 RB / 0 RB Offset
		20050 to 20300	20050, 20175, 20300	20MHz	QPSK, 16QAM	1 RB / 0 RB Offset
B	BAND EDGE	19957 to 20393	19957	1.4MHz	QPSK	1 RB / 0 RB Offset 6 RB / 0 RB Offset
			20393	1.4MHz	QPSK	1 RB / 5 RB Offset 6 RB / 0 RB Offset
		19965 to 20385	19965	3MHz	QPSK	1 RB / 0 RB Offset 15 RB / 0 RB Offset
			20385	3MHz	QPSK	1 RB / 14 RB Offset 15 RB / 0 RB Offset
		19975 to 20375	19975	5MHz	QPSK	1 RB / 0 RB Offset 25 RB / 0 RB Offset
			20375	5MHz	QPSK	1 RB / 24 RB Offset 25 RB / 0 RB Offset
		20000 to 20350	20000	10MHz	QPSK	1 RB / 0 RB Offset 50 RB / 0 RB Offset
			20350	10MHz	QPSK	1 RB / 49 RB Offset 50 RB / 0 RB Offset



**BUREAU  
VERITAS**

**Test Report No.: RF150212N021-5**

B	BAND EDGE	20025 to 20325	20025	15MHz	QPSK	1 RB / 0 RB Offset
			20325	15MHz	QPSK	75 RB / 0 RB Offset
		20050 to 20300	20050	20MHz	QPSK	1 RB / 74 RB Offset
			20300	20MHz	QPSK	75 RB / 0 RB Offset
B	CONDCUDETED EMISSION	19957 to 20393	20175	1.4MHz	QPSK	1 RB / 0 RB Offset
		19965 to 20385	20175	3MHz	QPSK	1 RB / 0 RB Offset
		19975 to 20375	20175	5MHz	QPSK	1 RB / 0 RB Offset
		20000 to 20350	20175	10MHz	QPSK	1 RB / 0 RB Offset
		20025 to 20325	20175	15MHz	QPSK	1 RB / 0 RB Offset
		20050 to 20300	20175	20MHz	QPSK	100 RB / 0 RB Offset
A	RADIATED EMISSION	19957 to 20393	20175	1.4MHz	QPSK	1 RB / 0 RB Offset
		19965 to 20385	20175	3MHz	QPSK	1 RB / 0 RB Offset
		19975 to 20375	20175	5MHz	QPSK	1 RB / 0 RB Offset
		20000 to 20350	20175	10MHz	QPSK	1 RB / 0 RB Offset
		20025 to 20325	20175	15MHz	QPSK	1 RB / 0 RB Offset
		20050 to 20300	20175	20MHz	QPSK	100 RB / 0 RB Offset

**Note:** This device was tested under all bandwidths, RB configurations and modulations. The worst case was found in QPSK modulation.

**LTE BAND 17**

EUT CONFIGURE MODE	TEST ITEM	AVAILABLE CHANNEL	TESTED CHANNEL	CHANNEL BANDWIDTH	MODULATION	MODE		
B	ERP	23755 to 23825	23755, 23790, 23825	5MHz	QPSK, 16QAM	1 RB / 0 RB Offset		
		23780 to 23800	23780, 23790, 23800	10MHz	QPSK, 16QAM	1 RB / 0 RB Offset		
B	FREQUENCY STABILITY	23755 to 23825	23790	5MHz	QPSK	1 RB / 0 RB Offset		
		23780 to 23800	23790	10MHz	QPSK	1 RB / 0 RB Offset		
B	OCCUPIED BANDWIDTH	23755 to 23825	23755, 23790, 23825	5MHz	QPSK, 16QAM	25 RB / 0 RB Offset		
		23780 to 23800	23780, 23790, 23800	10MHz	QPSK, 16QAM	50 RB / 0 RB Offset		
B	PEAK TO AVERAGE RATIO	23755 to 23825	23755, 23790, 23825	5MHz	QPSK, 16QAM	1 RB / 0 RB Offset		
		23780 to 23800	23780, 23790, 23800	10MHz	QPSK, 16QAM	1 RB / 0 RB Offset		
B	BAND EDGE	23755 to 23825	23755	5MHz	QPSK	1 RB / 0 RB Offset 25 RB / 0 RB Offset		
			23825	5MHz	QPSK	1 RB / 24 RB Offset 25 RB / 0 RB Offset		
		23780 to 23800	23780	10MHz	QPSK	1 RB / 0 RB Offset 50 RB / 0 RB Offset		
			23800	10MHz	QPSK	1 RB / 49 RB Offset 50 RB / 0 RB Offset		
		B	CONDCUDED EMISSION	23755 to 23825	23790	5MHz	QPSK	1 RB / 0 RB Offset
				23780 to 23800	23790	10MHz	QPSK	1 RB / 0 RB Offset
A	RADIATED EMISSION	23755 to 23825	23790	5MHz	QPSK	1 RB / 0 RB Offset		
		23780 to 23800	23790	10MHz	QPSK	1 RB / 0 RB Offset		

**Note:** This device was tested under all bandwidths, RB configurations and modulations. The worst case was found in QPSK modulation.

**TEST CONDITION:**

TEST ITEM	ENVIRONMENTAL CONDITIONS	INPUT POWER	TESTED BY
EIRP(ERP)	24deg. C, 60%RH	3.8Vdc from Battery	Blue Zheng
FREQUENCY STABILITY	24deg. C, 61%RH	3.8Vdc from Battery	Yuqiang Yin
OCCUPIED BANDWIDTH	24deg. C, 61%RH	3.8Vdc from Battery	Yuqiang Yin
PEAK TO AVERAGE RATIO	24deg. C, 61%RH	3.8Vdc from Battery	Yuqiang Yin
BAND EDGE	24deg. C, 61%RH	3.8Vdc from Battery	Yuqiang Yin
CONDCUDED EMISSION	24deg. C, 61%RH	3.8Vdc from Battery	Yuqiang Yin
RADIATED EMISSION	24deg. C, 60%RH	5Vdc from adapter	Blue Zheng



Test Report No.: RF150212N021-5

### 3.5 GENERAL DESCRIPTION OF APPLIED STANDARDS

The EUT is a RF product. According to the specifications of the manufacturer, it must comply with the requirements of the following standards:

**FCC 47 CFR Part 2**

**FCC 47 CFR Part 27**

**ANSI/TIA/EIA-603-C 2004**

**NOTE:** All test items have been performed and recorded as per the above standards.



## 4 TEST TYPES AND RESULTS

### 4.1 OUTPUT POWER MEASUREMENT

#### 4.1.1 LIMITS OF OUTPUT POWER MEASUREMENT

Fixed, mobile, and portable (hand-held) stations operating in the 1710–1755 MHz band are limited to 1 watt EIRP.

Portable stations (hand-held devices) operating in the 699-716 MHz band are limited to 3 watts ERP.

#### 4.1.2 TEST PROCEDURES

##### EIRP / ERP MEASUREMENT:

- a. The EUT was set up for the maximum power with LTE link data modulation. The power was measured with R&S Spectrum Analyzer. All measurements were done at 3 channels (low, middle and high operational frequency range). RBW and VBW is 10MHz for LTE.
- b. E.I.R.P power measurement. In the semi-anechoic chamber, EUT placed on the 0.8m height of Turn Table, rotated the table around 360 degrees to search the maximum radiation power and receiver antenna shall be rotated vertical and horizontal polarization and moved height from 1m to 4m to find the maximum polar radiated power. The “Read Value” is the spectrum reading the maximum power value.
- c. The substitution horn antenna is substituted for EUT at the same position and signals generator export the CW signal to the substitution antenna via a TX cable. Rotated the Turn Table and moved receiving antenna to find the maximum radiation power. Adjust output power level of S.G to get a Value of spectrum reading equal to “Read Value” of step a. Record the power level of S.G
- d.  $EIRP = \text{Output power level of S.G} - \text{TX cable loss} + \text{Antenna gain of substitution horn}$
- e.  $E.R.P = E.I.R.P - 2.15 \text{ dB}$

##### CONDUCTED POWER MEASUREMENT:

- a. The EUT was set up for the maximum power with LTE link data modulation and link up with simulator.
- b. Set the EUT to transmit under low, middle and high channel and record the power level shown on simulator.



### 4.1.3 TEST SETUP

#### EIRP / ERP MEASUREMENT:

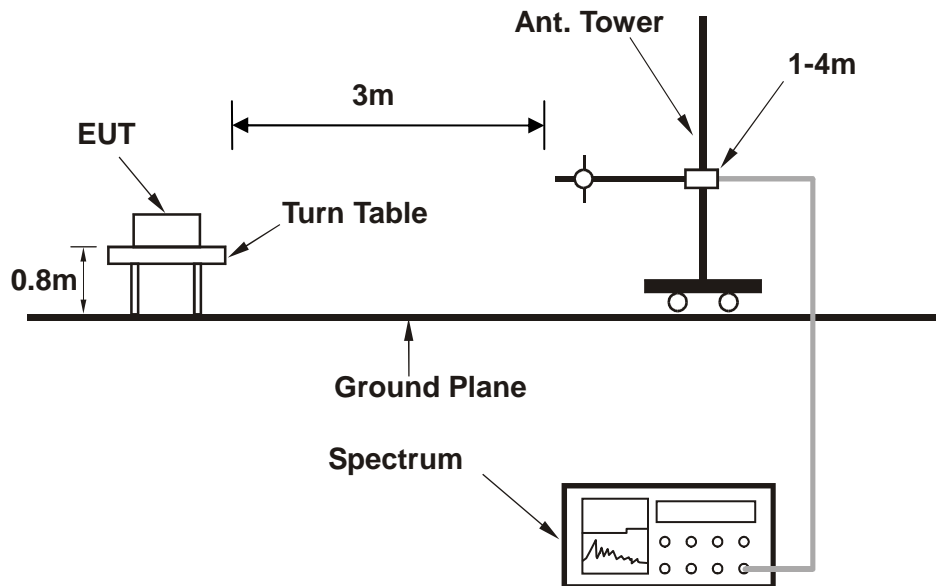

For the actual test configuration, please refer to the attached file (Test Setup Photo).

#### CONDUCTED POWER MEASUREMENT:

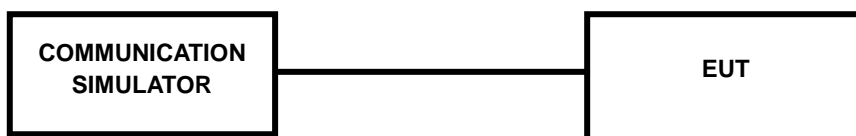

For the actual test configuration, please refer to the attached file (Test Setup Photo).

#### 4.1.4 TEST RESULTS

##### AVERAGE CONDUCTED OUTPUT POWER (dBm)

LTE Band 4							
BW	Modulation	RB Size	RB Offset	Low CH 19957	Mid CH 20175	High CH 20393	MPR
				Frequency 1710.7 MHz	Frequency 1732.5 MHz	Frequency 1754.3 MHz	
1.4MHz	QPSK	1	0	<b>22.67</b>	22.43	22.56	0
		1	2	22.51	22.38	22.55	0
		1	5	22.45	22.21	22.23	0
		3	0	<b>22.56</b>	22.51	22.53	0
		3	1	22.31	22.45	22.3	0
		3	3	22.4	22.4	22.51	0
		6	0	<b>21.49</b>	21.44	21.25	1
	16QAM	1	0	21.47	21.37	21.23	1
		1	2	21.44	21.38	21.19	1
		1	5	21.3	21.31	<b>21.54</b>	1
		3	0	<b>21.44</b>	21.42	21.2	1
		3	1	21.4	21.28	21.2	1
		3	3	21.42	21.18	21.22	1
		6	0	20.39	<b>20.47</b>	20.19	2

LTE Band 4							
BW	Modulation	RB Size	RB Offset	Low CH 19965	Mid CH 20175	High CH 20385	MPR
				Frequency 1711.5 MHz	Frequency 1732.5 MHz	Frequency 1753.5 MHz	
3 MHz	QPSK	1	0	<b>22.71</b>	22.47	22.6	0
		1	7	22.55	22.42	22.59	0
		1	14	22.49	22.25	22.27	0
		8	0	<b>21.6</b>	21.55	21.57	1
		8	3	21.35	21.49	21.34	1
		8	7	21.44	21.44	21.55	1
		15	0	<b>21.53</b>	21.48	21.29	1
	16QAM	1	0	21.51	21.41	21.27	1
		1	7	21.48	21.42	21.23	1
		1	14	21.34	21.35	<b>21.58</b>	1
		8	0	<b>20.48</b>	20.46	20.24	2
		8	3	20.44	20.32	20.24	2
		8	7	20.46	20.22	20.26	2
		15	0	20.43	<b>20.51</b>	20.23	2
BW	Modulation	RB Size	RB Offset	Low CH 19975	Mid CH 20175	High CH 20375	MPR
				Frequency 1712.5 MHz	Frequency 1732.5 MHz	Frequency 1752.5 MHz	
5 MHz	QPSK	1	0	<b>22.75</b>	22.51	22.64	0
		1	12	22.59	22.46	22.63	0
		1	24	22.53	22.29	22.31	0
		12	0	<b>21.64</b>	21.59	21.61	1
		12	6	21.39	21.53	21.38	1
		12	13	21.48	21.48	21.59	1
		25	0	<b>21.57</b>	21.52	21.33	1
	16QAM	1	0	21.55	21.45	21.31	1
		1	12	21.52	21.46	21.27	1
		1	24	21.38	21.39	<b>21.62</b>	1
		12	0	<b>20.52</b>	20.5	20.28	2
		12	6	20.48	20.36	20.28	2
		12	13	20.5	20.26	20.3	2
		25	0	20.47	<b>20.55</b>	20.27	2

LTE Band 4							
BW	Modulation	RB Size	RB Offset	Low CH 20000	Mid CH 20175	High CH 20350	MPR
				Frequency 1715 MHz	Frequency 1732.5 MHz	Frequency 1750 MHz	
10 MHz	QPSK	1	0	<b>22.78</b>	22.54	22.67	0
		1	24	22.62	22.49	22.66	0
		1	49	22.56	22.32	22.34	0
		25	0	<b>21.67</b>	21.62	21.64	1
		25	12	21.42	21.56	21.41	1
		25	25	21.51	21.51	21.62	1
		50	0	<b>21.6</b>	21.55	21.36	1
	16QAM	1	0	21.58	21.48	21.34	1
		1	24	21.55	21.49	21.3	1
		1	49	21.41	21.42	<b>21.65</b>	1
		25	0	<b>20.55</b>	20.53	20.31	2
		25	12	20.51	20.39	20.31	2
		25	25	20.53	20.29	20.33	2
		50	0	20.5	<b>20.58</b>	20.3	2
BW	Modulation	RB Size	RB Offset	Low CH 20025	Mid CH 20175	High CH 20325	MPR
				Frequency 1717.5 MHz	Frequency 1732.5 MHz	Frequency 1747.5 MHz	
15 MHz	QPSK	1	0	<b>22.84</b>	22.6	22.73	0
		1	37	22.68	22.55	22.72	0
		1	74	22.62	22.38	22.4	0
		36	0	<b>21.73</b>	21.68	21.7	1
		36	19	21.48	21.62	21.47	1
		36	39	21.57	21.57	21.68	1
		75	0	<b>21.66</b>	21.61	21.42	1
	16QAM	1	0	21.64	21.54	21.4	1
		1	37	21.61	21.55	21.36	1
		1	74	21.47	21.48	<b>21.71</b>	1
		36	0	<b>20.61</b>	20.59	20.37	2
		36	19	20.57	20.45	20.37	2
		36	39	20.59	20.35	20.39	2
		75	0	20.56	<b>20.64</b>	20.36	2

LTE Band 4							
BW	Modulation	RB Size	RB Offset	Low CH 20050	Mid CH 20175	High CH 20300	MPR
				Frequency 1720 MHz	Frequency 1732.5 MHz	Frequency 1745 MHz	
20MHz	QPSK	1	0	<b>22.89</b>	22.65	22.78	0
		1	50	22.73	22.6	22.77	0
		1	99	22.67	22.43	22.45	0
		50	0	<b>21.78</b>	21.73	21.75	1
		50	25	21.53	21.67	21.52	1
		50	50	21.62	21.62	21.73	1
		100	0	<b>21.71</b>	21.66	21.47	1
	16QAM	1	0	21.69	21.59	21.45	1
		1	50	21.66	21.6	21.41	1
		1	99	21.52	21.53	<b>21.76</b>	1
		50	0	<b>20.66</b>	20.64	20.42	2
		50	25	20.62	20.5	20.42	2
		50	50	20.64	20.4	20.44	2
		100	0	20.61	<b>20.69</b>	20.41	2

LTE Band 17							
BW	Modulation	RB Size	RB Offset	Low CH 23755	Mid CH 23790	High CH 23825	MPR
				Frequency 706.5 MHz	Frequency 710 MHz	Frequency 713.5 MHz	
5 MHz	QPSK	1	0	22.7	22.76	<b>22.84</b>	0
		1	12	22.69	22.7	22.72	0
		1	24	22.63	22.59	22.57	0
		12	0	21.56	21.58	21.55	1
		12	6	21.49	21.77	21.58	1
		12	13	21.66	21.79	<b>21.8</b>	1
		25	0	21.58	21.55	<b>21.59</b>	1
	16QAM	1	0	21.62	21.54	21.62	1
		1	12	21.64	21.54	<b>21.69</b>	1
		1	24	21.51	21.45	21.64	1
		12	0	20.61	20.6	20.66	2
		12	6	20.64	20.7	20.63	2
		12	13	20.67	<b>20.72</b>	20.69	2
		25	0	20.54	20.54	<b>20.66</b>	2
BW	Modulation	RB Size	RB Offset	Low CH 23780	Mid CH 23790	High CH 23800	MPR
				Frequency 709 MHz	Frequency 710 MHz	Frequency 711 MHz	
10 MHz	QPSK	1	0	22.75	22.81	<b>22.89</b>	0
		1	24	22.74	22.75	22.77	0
		1	49	22.68	22.64	22.62	0
		25	0	21.61	21.63	21.6	1
		25	12	21.54	21.82	21.63	1
		25	25	21.71	21.84	<b>21.85</b>	1
		50	0	21.63	21.6	<b>21.64</b>	1
	16QAM	1	0	21.67	21.59	21.67	1
		1	24	21.69	21.59	<b>21.74</b>	1
		1	49	21.56	21.5	21.69	1
		25	0	20.66	20.65	20.71	2
		25	12	20.69	20.75	20.68	2
		25	25	20.72	<b>20.77</b>	20.74	2
		50	0	20.59	20.59	<b>20.71</b>	2



**BUREAU  
VERITAS**

Test Report No.: RF150212N021-5

**EIRP**

**LTE BAND 4**

**CHANNEL BANDWIDTH: 1.4MHz QPSK**

Channel	Frequency (MHz)	LVL (dBm)	Correction Factor(dB)	EIRP(dBm)	EIRP(mW)	Polarization (H/V)	LIMIT (W)
19957	1710.7	-18.18	40.25	22.07	161.06	H	1
20175	1732.5	-18.22	40.86	22.64	183.65	H	1
20393	1754.3	-18.39	41.22	22.83	<b>191.87</b>	H	1
19957	1710.7	-24.97	44.36	19.39	86.90	V	1
20175	1732.5	-25.16	44.08	18.92	77.98	V	1
20393	1754.3	-25.45	44.91	19.46	88.31	V	1

**NOTE:** EIRP (dBm) = LVL (dBm) + Correction Factor (dB)

**CHANNEL BANDWIDTH: 1.4MHz 16QAM**

Channel	Frequency (MHz)	LVL (dBm)	Correction Factor(dB)	EIRP(dBm)	EIRP(mW)	Polarization (H/V)	LIMIT (W)
19957	1710.7	-19.05	40.25	21.20	131.83	H	1
20175	1732.5	-19.15	40.86	21.71	148.25	H	1
20393	1754.3	-19.35	41.22	21.87	153.82	H	1
19957	1710.7	-25.84	44.36	18.52	71.12	V	1
20175	1732.5	-26.09	44.08	17.99	62.95	V	1
20393	1754.3	-26.41	44.91	18.50	70.79	V	1

**NOTE:** EIRP (dBm) = LVL (dBm) + Correction Factor (dB)



LTE BAND 4

CHANNEL BANDWIDTH: 3MHz QPSK

Channel	Frequency (MHz)	LVL (dBm)	Correction Factor(dB)	EIRP(dBm)	EIRP(mW)	Polarization (H/V)	LIMIT (W)
19965	1711.5	-18.16	40.18	22.02	159.22	H	1
20175	1732.5	-18.28	40.86	22.58	181.13	H	1
20385	1753.5	-18.34	41.15	22.81	<b>190.99</b>	H	1
19965	1711.5	-24.95	44.29	19.34	85.90	V	1
20175	1732.5	-25.22	44.08	18.86	76.91	V	1
20385	1753.5	-25.40	44.83	19.43	87.70	V	1

NOTE: EIRP (dBm) = LVL (dBm) + Correction Factor (dB)

CHANNEL BANDWIDTH: 3MHz 16QAM

Channel	Frequency (MHz)	LVL (dBm)	Correction Factor(dB)	EIRP(dBm)	EIRP(mW)	Polarization (H/V)	LIMIT (W)
19965	1711.5	-19.23	40.18	20.95	124.45	H	1
20175	1732.5	-19.17	40.86	21.69	147.57	H	1
20385	1753.5	-19.33	41.15	21.82	152.05	H	1
19965	1711.5	-26.02	44.29	18.27	67.14	V	1
20175	1732.5	-26.11	44.08	17.97	62.66	V	1
20385	1753.5	-26.39	44.83	18.44	69.82	V	1

NOTE: EIRP (dBm) = LVL (dBm) + Correction Factor (dB)





**BUREAU  
VERITAS**

Test Report No.: RF150212N021-5

**LTE BAND 4**

**CHANNEL BANDWIDTH: 5MHz QPSK**

Channel	Frequency (MHz)	LVL (dBm)	Correction Factor(dB)	EIRP(dBm)	EIRP(mW)	Polarization (H/V)	LIMIT (W)
19975	1712.5	-18.22	40.34	22.12	162.93	H	1
20175	1732.5	-18.23	40.86	22.63	183.23	H	1
20375	1752.5	-18.29	40.96	22.67	<b>184.93</b>	H	1
19975	1712.5	-25.01	44.19	19.18	82.79	V	1
20175	1732.5	-25.17	44.08	18.91	77.80	V	1
20375	1752.5	-25.35	44.82	19.47	88.51	V	1

**NOTE:** EIRP (dBm) = LVL (dBm) + Correction Factor (dB)

**CHANNEL BANDWIDTH: 5MHz 16QAM**

Channel	Frequency (MHz)	LVL (dBm)	Correction Factor(dB)	EIRP(dBm)	EIRP(mW)	Polarization (H/V)	LIMIT (W)
19975	1712.5	-19.05	40.34	21.29	134.59	H	1
20175	1732.5	-19.25	40.86	21.61	144.88	H	1
20375	1752.5	-19.39	40.96	21.57	143.55	H	1
19975	1712.5	-25.84	44.19	18.35	68.39	V	1
20175	1732.5	-26.19	44.08	17.89	61.52	V	1
20375	1752.5	-26.45	44.82	18.37	68.71	V	1

**NOTE:** EIRP (dBm) = LVL (dBm) + Correction Factor (dB)



**BUREAU  
VERITAS**

Test Report No.: RF150212N021-5

**LTE BAND 4**

**CHANNEL BANDWIDTH: 10MHz QPSK**

Channel	Frequency (MHz)	LVL (dBm)	Correction Factor(dB)	EIRP(dBm)	EIRP(mW)	Polarization (H/V)	LIMIT (W)
20000	1715.0	-18.03	41.10	23.07	<b>202.77</b>	H	1
20175	1732.5	-18.17	40.86	22.69	185.78	H	1
20350	1750.0	-18.16	41.14	22.98	198.61	H	1
20000	1715.0	-24.82	44.16	19.34	85.90	V	1
20175	1732.5	-25.11	44.08	18.97	78.89	V	1
20350	1750.0	-25.22	44.73	19.51	89.33	V	1

**NOTE:** EIRP (dBm) = LVL (dBm) + Correction Factor (dB)

**CHANNEL BANDWIDTH: 10MHz 16QAM**

Channel	Frequency (MHz)	LVL (dBm)	Correction Factor(dB)	EIRP(dBm)	EIRP(mW)	Polarization (H/V)	LIMIT (W)
20000	1715.0	-19.18	41.10	21.92	155.60	H	1
20175	1732.5	-19.27	40.86	21.59	144.21	H	1
20350	1750.0	-19.32	41.14	21.82	152.05	H	1
20000	1715.0	-25.97	44.16	18.19	65.92	V	1
20175	1732.5	-26.21	44.08	17.87	61.24	V	1
20350	1750.0	-26.38	44.73	18.35	68.39	V	1

**NOTE:** EIRP (dBm) = LVL (dBm) + Correction Factor (dB)



**BUREAU  
VERITAS**

Test Report No.: RF150212N021-5

**LTE BAND 4**

**CHANNEL BANDWIDTH: 15MHz QPSK**

Channel	Frequency (MHz)	LVL (dBm)	Correction Factor(dB)	EIRP(dBm)	EIRP(mW)	Polarization (H/V)	LIMIT (W)
20025	1717.5	-18.04	41.35	23.31	214.29	H	1
20175	1732.5	-18.24	41.16	22.92	195.88	H	1
20325	1747.5	-18.23	41.78	23.55	<b>226.46</b>	H	1
20025	1717.5	-24.83	44.08	19.25	84.14	V	1
20175	1732.5	-25.18	44.08	18.90	77.62	V	1
20325	1747.5	-25.29	44.87	19.58	90.78	V	1

**NOTE:** EIRP (dBm) = LVL (dBm) + Correction Factor (dB)

**CHANNEL BANDWIDTH: 15MHz 16QAM**

Channel	Frequency (MHz)	LVL (dBm)	Correction Factor(dB)	EIRP(dBm)	EIRP(mW)	Polarization (H/V)	LIMIT (W)
20025	1717.5	-18.90	41.35	22.45	175.79	H	1
20175	1732.5	-19.11	41.16	22.05	160.32	H	1
20325	1747.5	-19.08	41.78	22.70	186.21	H	1
20025	1717.5	-25.69	44.08	18.39	69.02	V	1
20175	1732.5	-26.05	44.08	18.03	63.53	V	1
20325	1747.5	-26.14	44.87	18.73	74.64	V	1

**NOTE:** EIRP (dBm) = LVL (dBm) + Correction Factor (dB)



LTE BAND 4

CHANNEL BANDWIDTH: 20MHz QPSK

Channel	Frequency (MHz)	LVL (dBm)	Correction Factor(dB)	EIRP(dBm)	EIRP(mW)	Polarization (H/V)	LIMIT (W)
20050	1720.0	-18.62	41.04	22.42	174.58	H	1
20175	1732.5	-18.69	40.86	22.17	164.82	H	1
20300	1745.0	-18.81	41.59	22.78	<b>189.67</b>	H	1
20050	1720.0	-25.41	43.26	17.85	60.95	V	1
20175	1732.5	-25.63	44.08	18.45	69.98	V	1
20300	1745.0	-25.87	44.33	18.46	70.15	V	1

NOTE: EIRP (dBm) = LVL (dBm) + Correction Factor (dB)

CHANNEL BANDWIDTH: 20MHz 16QAM

Channel	Frequency (MHz)	LVL (dBm)	Correction Factor(dB)	EIRP(dBm)	EIRP(mW)	Polarization (H/V)	LIMIT (W)
20050	1720.0	-19.55	41.04	21.49	140.93	H	1
20175	1732.5	-19.76	40.86	21.10	128.82	H	1
20300	1745.0	-19.64	41.59	21.95	156.68	H	1
20050	1720.0	-26.34	43.26	16.92	49.20	V	1
20175	1732.5	-26.70	44.08	17.38	54.70	V	1
20300	1745.0	-26.70	44.33	17.63	57.94	V	1

NOTE: EIRP (dBm) = LVL (dBm) + Correction Factor (dB)



BUREAU  
VERITAS

Test Report No.: RF150212N021-5

LTE BAND 17

CHANNEL BANDWIDTH: 5MHz QPSK

Channel	Frequency (MHz)	LVL (dBm)	Correction Factor(dB)	ERP(dBm)	ERP(mW)	Polarization (H/V)	LIMIT (W)
23755	706.5	-9.32	32.04	20.57	114.02	H	3
23790	710.0	-9.47	32.24	20.62	<b>115.35</b>	H	3
23825	713.5	-9.81	32.34	20.38	109.14	H	3
23755	706.5	-15.14	36.34	19.05	80.35	V	3
23790	710.0	-15.27	36.43	19.01	79.62	V	3
23825	713.5	-15.47	36.48	18.86	76.91	V	3

NOTE: ERP (dBm) = LVL (dBm) + Correction Factor (dB)-2.15dB.

CHANNEL BANDWIDTH: 5MHz 16QAM

Channel	Frequency (MHz)	LVL (dBm)	Correction Factor(dB)	ERP(dBm)	ERP(mW)	Polarization (H/V)	LIMIT (W)
23755	706.5	-9.52	32.04	20.37	108.89	H	3
23790	710.0	-9.94	32.24	20.15	103.51	H	3
23825	713.5	-9.94	32.34	20.25	105.93	H	3
23755	706.5	-16.16	36.34	18.03	63.53	V	3
23790	710.0	-16.13	36.43	18.15	65.31	V	3
23825	713.5	-16.22	36.48	18.11	64.71	V	3

NOTE: ERP (dBm) = LVL (dBm) + Correction Factor (dB)-2.15dB.



**LTE BAND 17**

**CHANNEL BANDWIDTH: 10MHz QPSK**

Channel	Frequency (MHz)	LVL (dBm)	Correction Factor(dB)	ERP(dBm)	ERP(mW)	Polarization (H/V)	LIMIT (W)
23780	709.0	-9.24	32.15	20.76	<b>119.12</b>	H	3
23790	710.0	-9.52	32.24	20.57	114.02	H	3
23800	711.0	-9.67	32.33	20.51	112.46	H	3
23780	709.0	-15.88	36.38	18.35	68.39	V	3
23790	710.0	-15.71	36.43	18.57	71.94	V	3
23800	711.0	-15.95	36.51	18.41	69.34	V	3

**NOTE:** ERP (dBm) = LVL (dBm) + Correction Factor (dB)-2.15dB.

**CHANNEL BANDWIDTH: 10MHz 16QAM**

Channel	Frequency (MHz)	LVL (dBm)	Correction Factor(dB)	ERP(dBm)	ERP(mW)	Polarization (H/V)	LIMIT (W)
23780	709.0	-10.17	32.15	19.83	96.16	H	3
23790	710.0	-10.59	32.24	19.50	89.13	H	3
23800	711.0	-10.50	32.33	19.68	92.90	H	3
23780	709.0	-16.81	36.38	17.42	55.21	V	3
23790	710.0	-16.78	36.43	17.50	56.23	V	3
23800	711.0	-16.78	36.51	17.58	57.28	V	3

**NOTE:** ERP (dBm) = LVL (dBm) + Correction Factor (dB)-2.15dB.

## 4.2 FREQUENCY STABILITY MEASUREMENT

### 4.2.1 LIMITS OF FREQUENCY STABILITY MEASUREMENT

The frequency stability shall be sufficient to ensure that the fundamental emissions stay within the authorized bands of operation.

### 4.2.2 TEST PROCEDURE

- a. Device is placed at the oven room. The oven room could control the temperatures and humidity. Power warm up is at least 15 min and power applied should perform before recording frequency error.
- b. EUT is connected the external power supply to control the DC input power. The test voltage range is from minimum to maximum working voltage. Each step shall be record the frequency error rate.
- c. The temperature range step is 10 degrees in this test items. All temperature levels shall be hold the  $\pm 0.5^{\circ}\text{C}$  during the measurement testing. The each temperature step shall be at least 0.5 hours, consider the EUT could be test under the stability condition.

**NOTE:** The frequency error was recorded frequency error from the communication simulator.

### 4.2.3 TEST SETUP

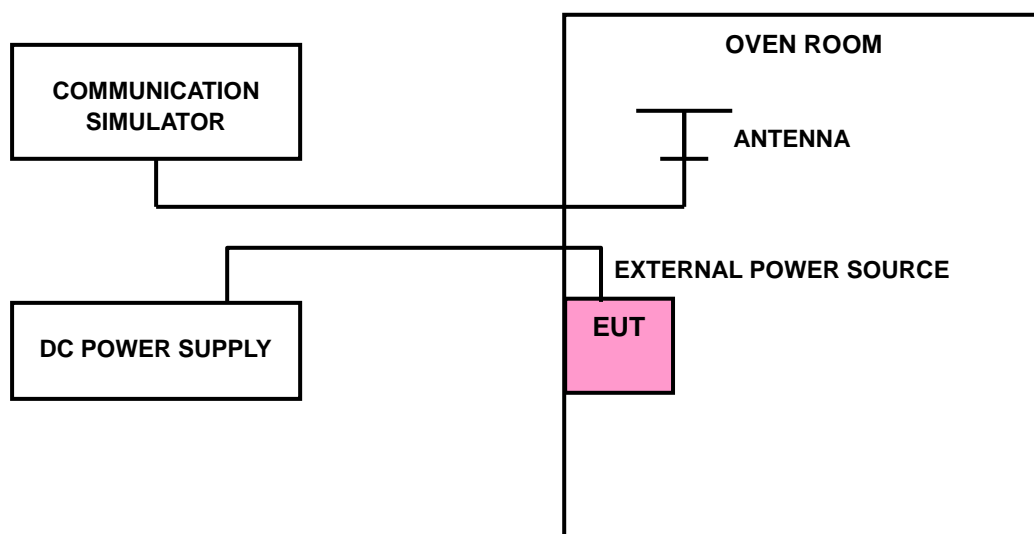

#### 4.2.4 TEST RESULTS

##### LTE BAND 4

AFC FREQUENCY ERROR vs. VOLTAGE							
VOLTAGE (Volts)	FREQUENCY ERROR (ppm)						LIMIT (ppm)
	1.4MHz	3MHz	5MHz	10MHz	15MHz	20MHz	
3.8	0.001	0.001	0.001	0.001	0.001	0.001	2.5
3.5	-0.002	-0.002	-0.002	-0.002	-0.003	-0.002	2.5
4.2	0.002	0.002	0.002	0.002	0.003	0.003	2.5

**NOTE:** The applicant defined the normal working voltage of the battery is from 3.5Vdc to 4.2Vdc.

AFC FREQUENCY ERROR vs. TEMPERATURE							
TEMP. (°C)	FREQUENCY ERROR (ppm)						LIMIT (ppm)
	1.4MHz	3MHz	5MHz	10MHz	15MHz	20MHz	
-30	-0.008	-0.008	-0.009	-0.009	-0.008	-0.008	2.5
-20	-0.008	-0.007	-0.008	-0.008	-0.008	-0.007	2.5
-10	-0.007	-0.006	-0.007	-0.007	-0.007	-0.006	2.5
0	-0.006	-0.006	-0.006	-0.005	-0.006	-0.005	2.5
10	-0.004	-0.004	-0.005	-0.005	-0.004	-0.004	2.5
20	-0.003	-0.003	-0.004	-0.004	-0.003	-0.003	2.5
30	-0.002	-0.003	-0.002	-0.003	-0.002	-0.002	2.5
40	-0.001	-0.001	-0.001	-0.002	-0.001	-0.001	2.5
50	0.000	0.000	0.000	-0.001	0.001	0.000	2.5
60	0.002	0.001	0.001	0.001	0.002	0.001	2.5



**LTE BAND 17**

VOLTAGE (Volts)	FREQUENCY ERROR (ppm)		LIMIT (ppm)
	5MHz	10MHz	
3.8	0.002	0.001	2.5
3.5	-0.001	-0.005	2.5
4.2	0.001	0.005	2.5

**NOTE:** The applicant defined the normal working voltage of the battery is from 3.5Vdc to 4.2Vdc.

VOLTAGE (Volts)	FREQUENCY ERROR (ppm)		LIMIT (ppm)
	5MHz	10MHz	
-30	-0.021	-0.023	2.5
-20	-0.019	-0.020	2.5
-10	-0.018	-0.018	2.5
0	-0.016	-0.016	2.5
10	-0.013	-0.013	2.5
20	-0.011	-0.009	2.5
30	-0.009	-0.006	2.5
40	-0.006	-0.004	2.5
50	-0.003	-0.002	2.5
60	0.000	0.002	2.5

### 4.3 OCCUPIED BANDWIDTH MEASUREMENT

#### 4.3.1 LIMITS OF OCCUPIED BANDWIDTH MEASUREMENT

The width of a frequency band such that, below the lower and above the upper frequency limits, the mean powers emitted are each equal to a specified percentage 0.5 %of the total mean power of a given emission.

#### 4.3.2 TEST SETUP

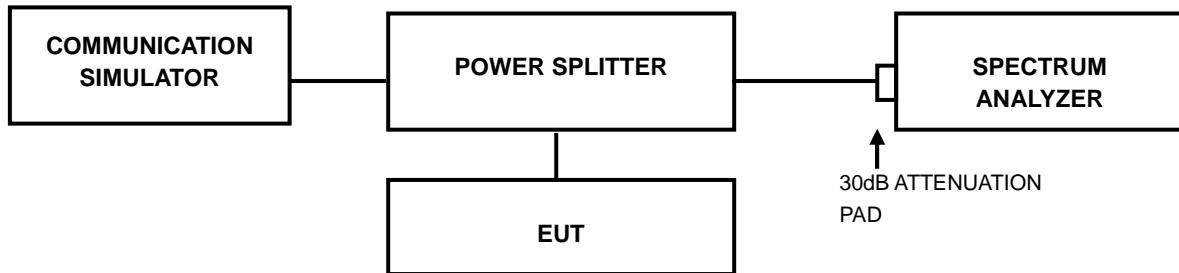

#### 4.3.3 TEST PROCEDURES

- a. The conducted occupied bandwidth used the power splitter via EUT RF power connector between simulation base station and spectrum analyzer.
- b. Use OBW measurement function of Spectrum analyzer to measure 99 % occupied bandwidth.

### 4.3.4 TEST RESULTS

#### LTE BAND 4

CHANNEL BANDWIDTH: 1.4MHz				CHANNEL BANDWIDTH: 3MHz			
CHANNEL	Frequency (MHz)	99% OCCUPIED Bandwidth (MHz)		CHANNEL	Frequency (MHz)	99% OCCUPIED Bandwidth (MHz)	
		QPSK	16QAM			QPSK	16QAM
19957	1710.7	1.09	1.09	19965	1711.5	2.68	2.68
20175	1732.5	1.09	1.09	20175	1732.5	2.69	2.68
20393	1754.3	1.09	1.09	20385	1753.5	2.68	2.68

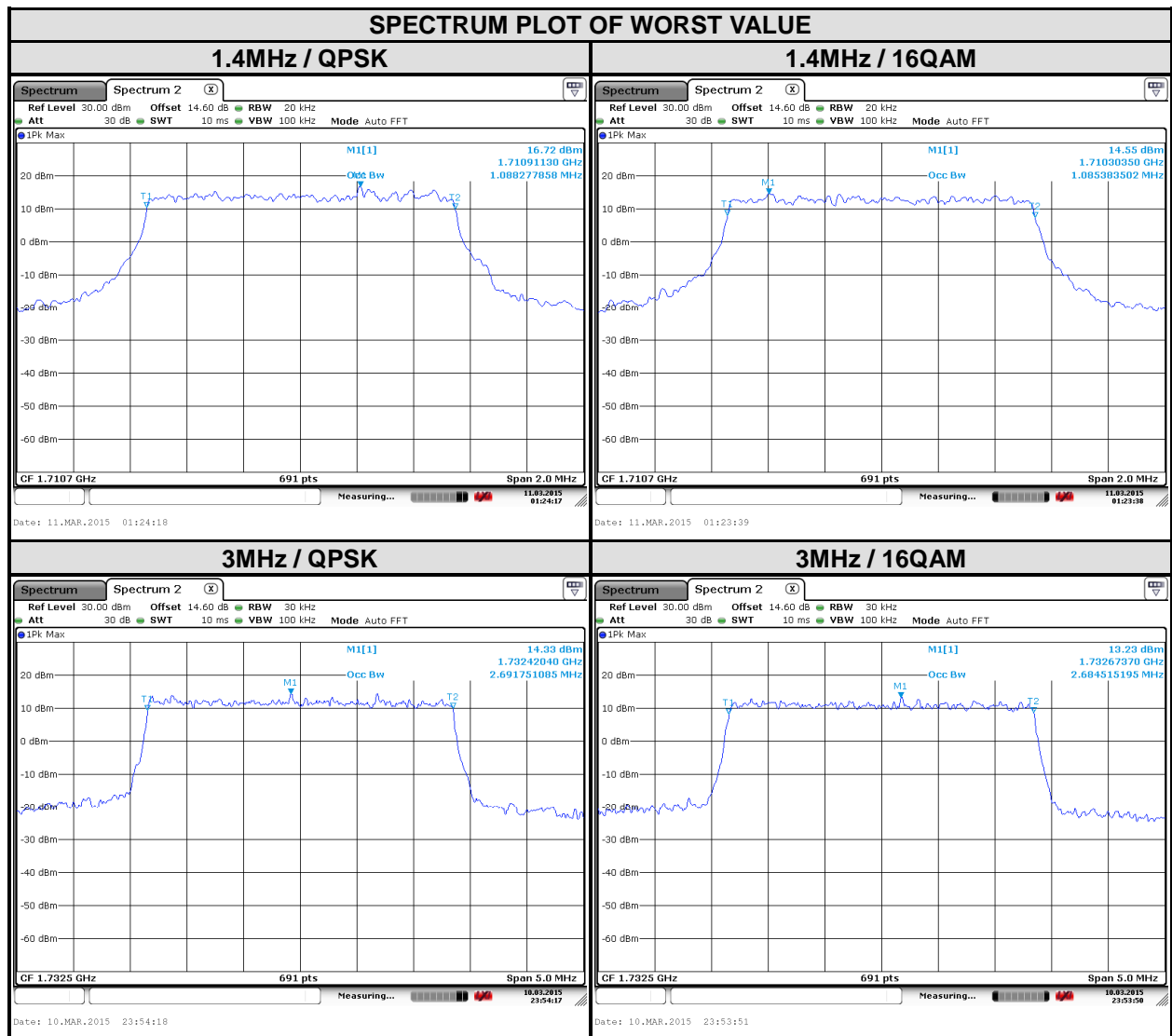



BUREAU  
VERITAS

Test Report No.: RF150212N021-5

LTE BAND 4

CHANNEL BANDWIDTH: 5MHz				CHANNEL BANDWIDTH: 10MHz			
CHANNEL	Frequency (MHz)	99% OCCUPIED Bandwidth (MHz)		CHANNEL	Frequency (MHz)	99% OCCUPIED Bandwidth (MHz)	
		QPSK	16QAM			QPSK	16QAM
19975	1712.5	4.47	4.49	20000	1715	8.94	8.97
20175	1732.5	4.49	4.47	20175	1732.5	8.94	8.94
20375	1752.5	4.47	4.46	20350	1750	8.94	8.94

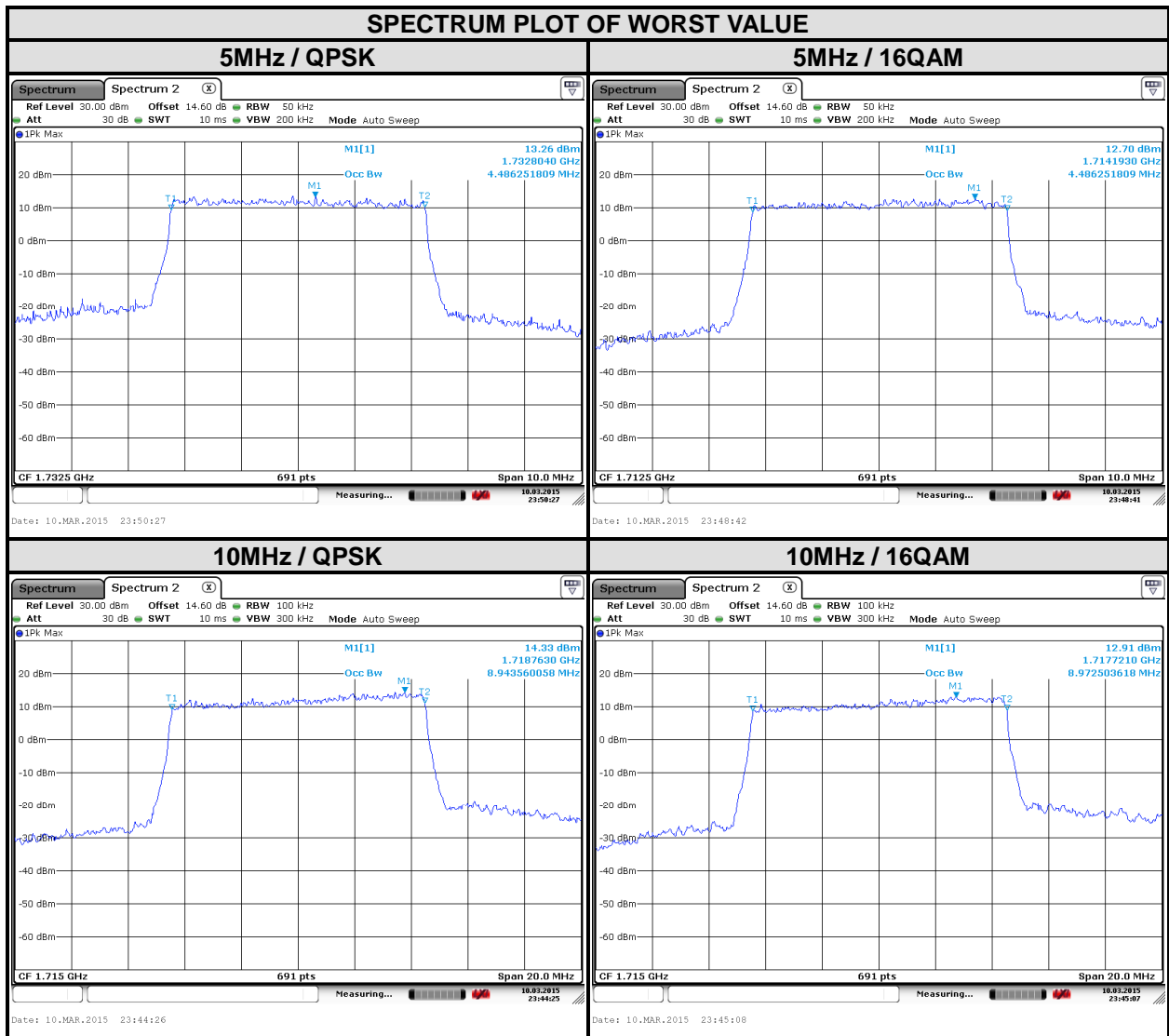

Bureau Veritas Shenzhen Co., Ltd.  
Dongguan Branch

No. 34, Chenwulu Section, Guantai Rd.,  
Houjie Town, Dongguan City,  
Guangdong 523942, China

Tel: +86 769 8593 5656  
Fax: +86 769 8593 1080  
Email: [customerservice.dg@cn.bureauveritas.com](mailto:customerservice.dg@cn.bureauveritas.com)



**BUREAU  
VERITAS**

Test Report No.: RF150212N021-5

**LTE BAND 4**

CHANNEL BANDWIDTH: 15MHz				CHANNEL BANDWIDTH: 20MHz			
CHANNEL	FREQUENCY (MHz)	99% OCCUPIED BANDWIDTH (MHz)		CHANNEL	FREQUENCY (MHz)	99% OCCUPIED BANDWIDTH (MHz)	
		QPSK	16QAM			QPSK	16QAM
20025	1717.5	13.42	13.42	20050	1720	17.83	17.71
20175	1732.5	13.42	13.42	20175	1732.5	17.89	17.83
20325	1747.5	13.46	13.42	20300	1745	17.95	17.83

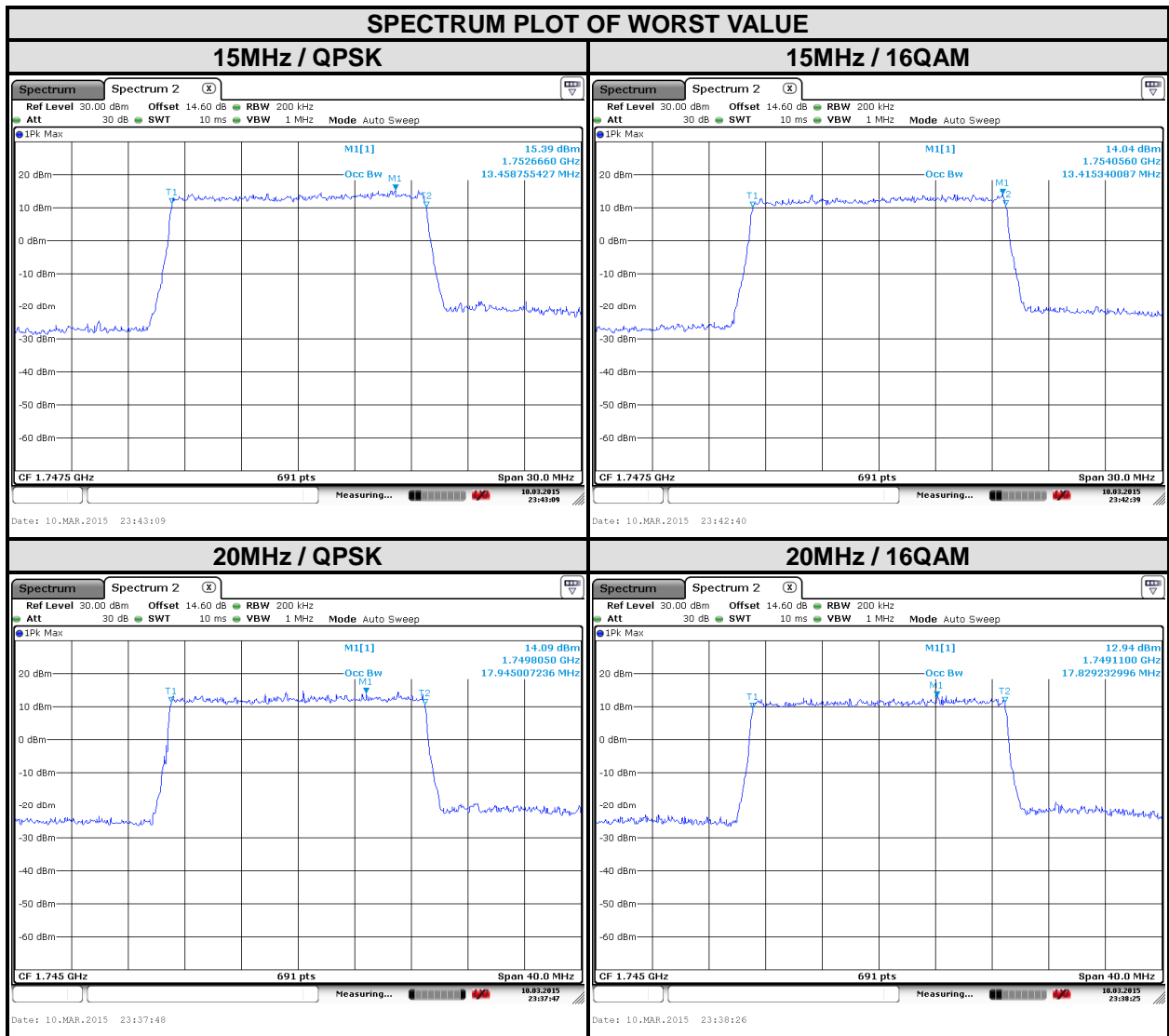

Bureau Veritas Shenzhen Co., Ltd.  
Dongguan Branch

No. 34, Chenwulu Section, Guantai Rd.,  
Houjie Town, Dongguan City,  
Guangdong 523942, China

Tel: +86 769 8593 5656  
Fax: +86 769 8593 1080  
Email: [customerservice.dg@cn.bureauveritas.com](mailto:customerservice.dg@cn.bureauveritas.com)



**BUREAU  
VERITAS**

Test Report No.: RF150212N021-5

**LTE BAND 17**

CHANNEL BANDWIDTH: 5MHz				CHANNEL BANDWIDTH: 10MHz			
CHANNEL	Frequency (MHz)	99% OCCUPIED Bandwidth (MHz)		CHANNEL	Frequency (MHz)	99% OCCUPIED Bandwidth (MHz)	
		QPSK	16QAM			QPSK	16QAM
23755	706.5	4.50	4.47	23780	709	8.97	8.97
23790	710	4.47	4.47	23790	710	8.97	8.97
23825	713.5	4.47	4.47	23800	711	8.97	8.97

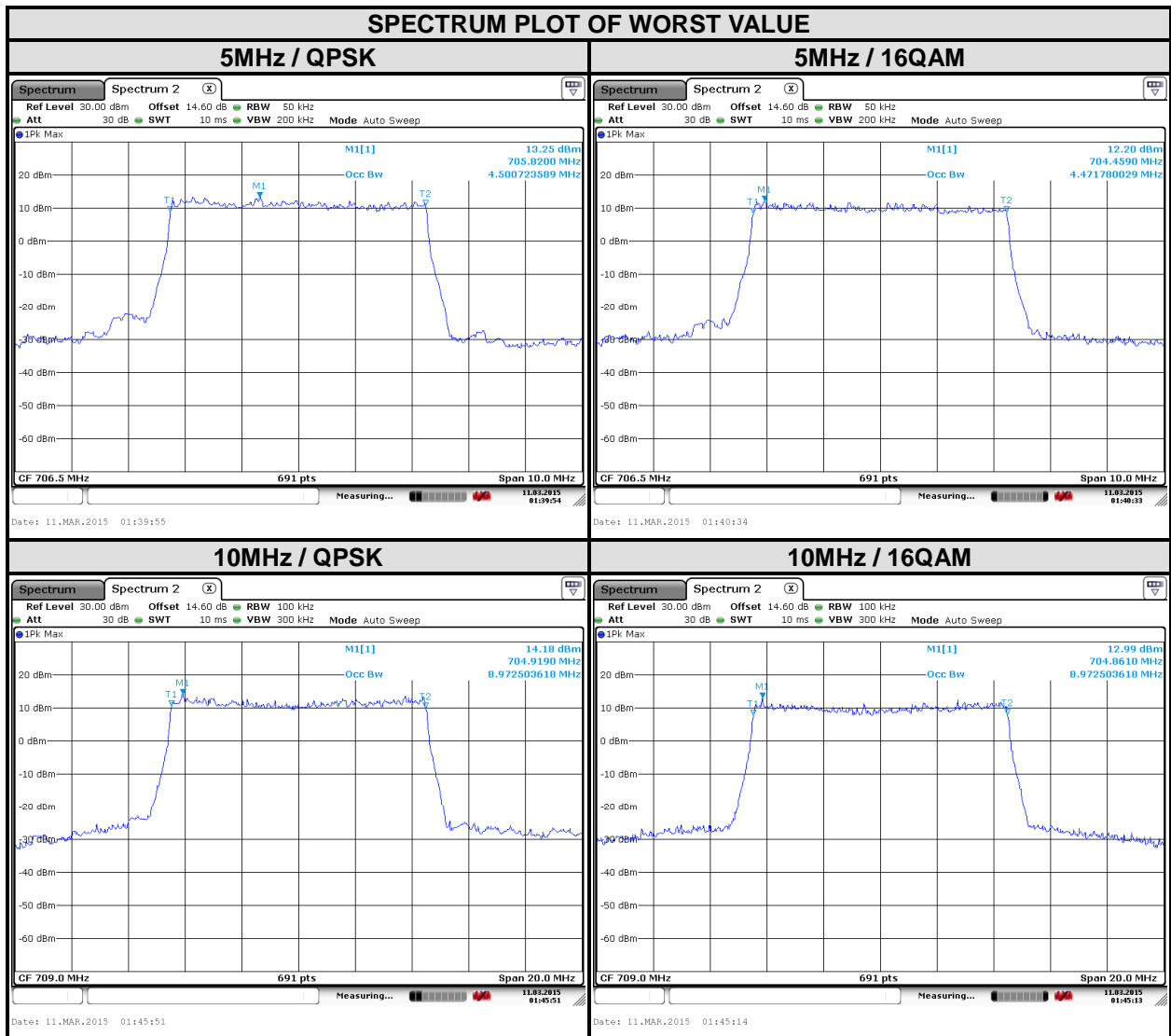

Bureau Veritas Shenzhen Co., Ltd.  
Dongguan Branch

No. 34, Chenwulu Section, Guantai Rd.,  
Houjie Town, Dongguan City,  
Guangdong 523942, China

Tel: +86 769 8593 5656  
Fax: +86 769 8593 1080  
Email: [customerservice.dg@cn.bureauveritas.com](mailto:customerservice.dg@cn.bureauveritas.com)

## 4.4 PEAK TO AVERAGE RATIO

### 4.4.1 LIMITS OF PEAK TO AVERAGE RATIO MEASUREMENT

In measuring transmissions in this band using an average power technique, the peak to-average ratio (PAR) of the transmission may not exceed 13 dB

### 4.4.2 TEST SETUP

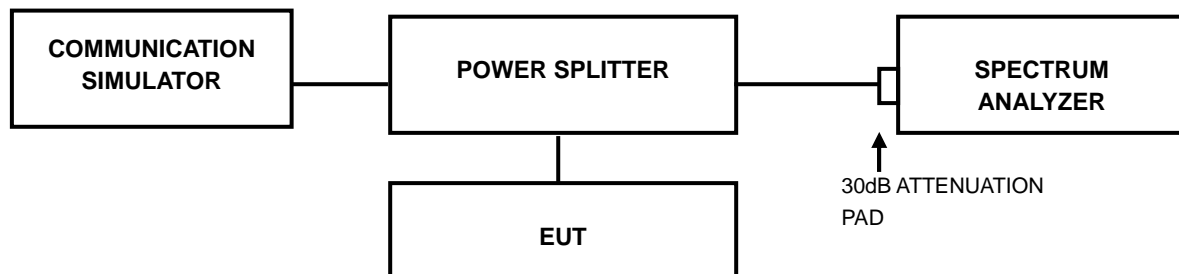

### 4.4.3 TEST PROCEDURES

1. Set resolution/measurement bandwidth  $\geq$  signal's occupied bandwidth;
2. Set the number of counts to a value that stabilizes the measured CCDF curve;
3. Record the maximum PAPR level associated with a probability of 0.1%.



**BUREAU  
VERITAS**

Test Report No.: RF150212N021-5

### 4.4.4 TEST RESULTS

#### LTE BAND 4

CHANNEL BANDWIDTH: 1.4MHz				CHANNEL BANDWIDTH: 3MHz			
CHANNEL	FREQUENCY (MHz)	PEAK TO AVERAGE RATIO (dB)		CHANNEL	FREQUENCY (MHz)	PEAK TO AVERAGE RATIO (dB)	
		QPSK	16QAM			QPSK	16QAM
19957	1710.7	6.20	7.01	19965	1711.5	6.00	6.84
20175	1732.5	4.78	5.97	20175	1732.5	5.19	5.97
20393	1754.3	5.51	6.35	20385	1753.5	5.88	6.43

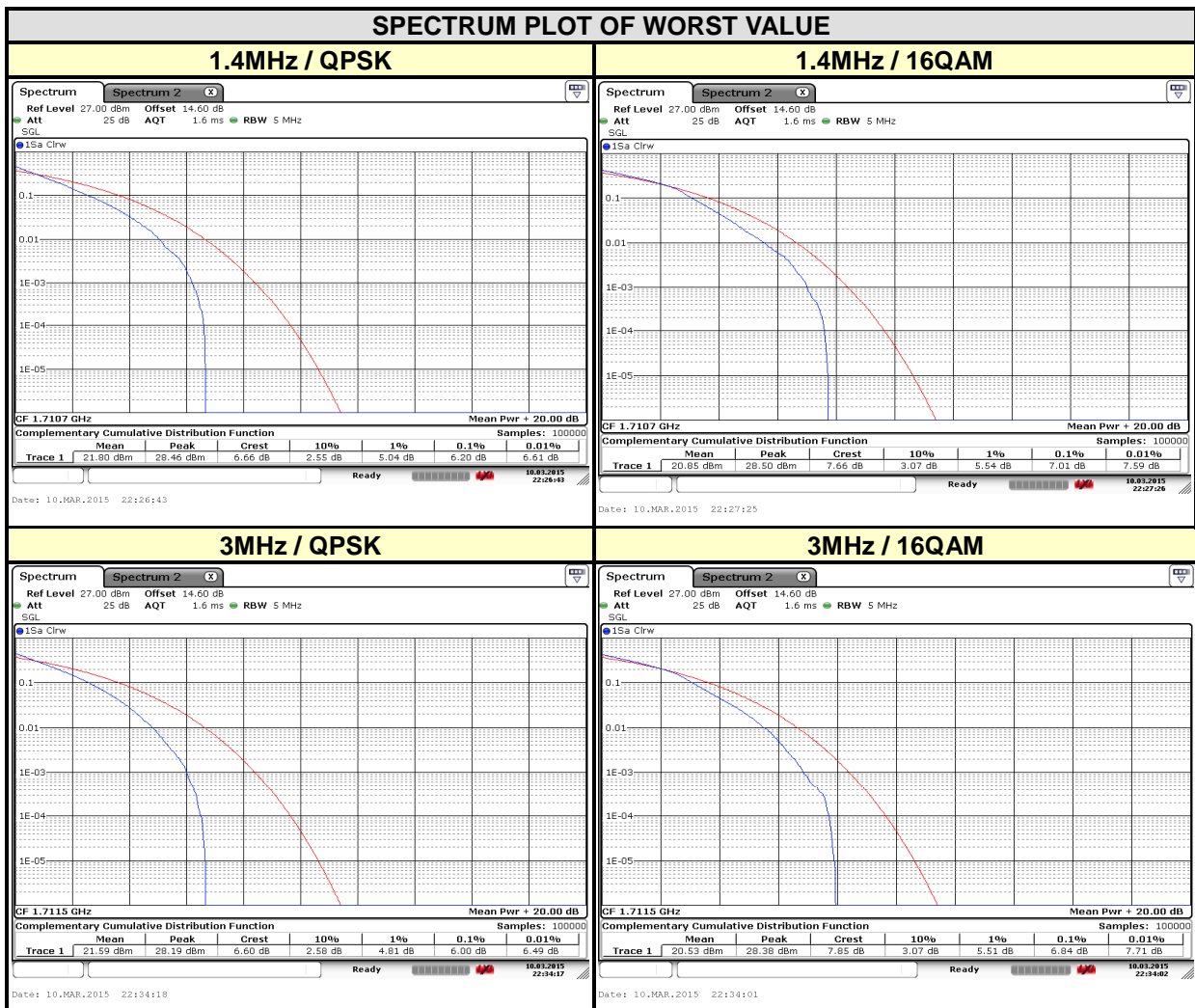





Test Report No.: RF150212N021-5

CHANNEL BANDWIDTH: 5MHz				CHANNEL BANDWIDTH: 10MHz			
CHANNEL	FREQUENCY (MHz)	PEAK TO AVERAGE RATIO (dB)		CHANNEL	FREQUENCY (MHz)	PEAK TO AVERAGE RATIO (dB)	
		QPSK	16QAM			QPSK	16QAM
19975	1712.5	5.83	6.61	20000	1715	5.74	6.41
20175	1732.5	4.99	5.91	20175	1732.5	4.99	5.88
20375	1752.5	5.57	6.46	20350	1750	5.94	6.61

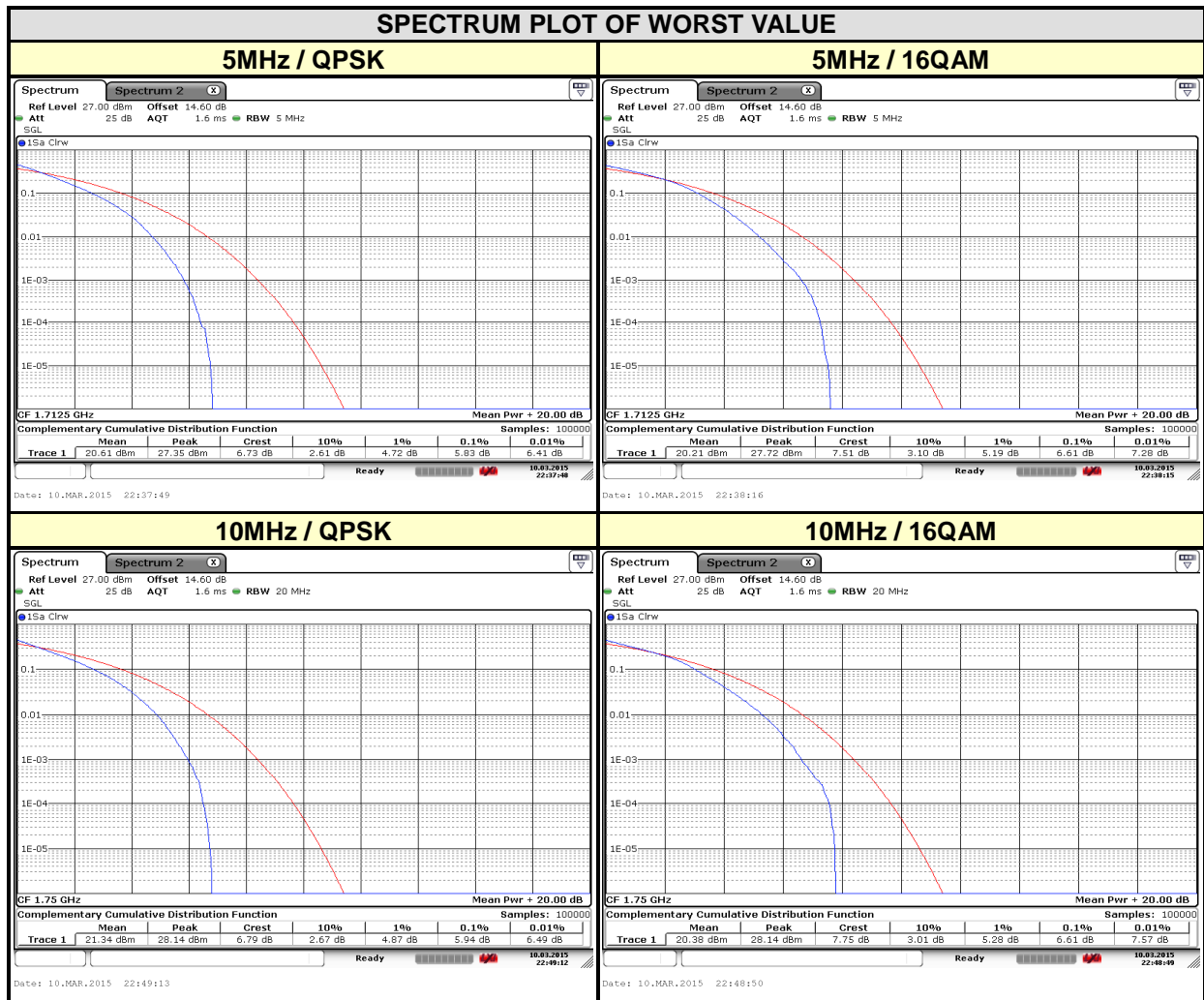



**BUREAU  
VERITAS**

Test Report No.: RF150212N021-5

CHANNEL BANDWIDTH: 15MHz				CHANNEL BANDWIDTH: 20MHz			
CHANNEL	FREQUENCY (MHz)	PEAK TO AVERAGE RATIO (dB)		CHANNEL	FREQUENCY (MHz)	PEAK TO AVERAGE RATIO (dB)	
		QPSK	16QAM			QPSK	16QAM
20025	1717.5	5.04	6.00	20050	1720	4.87	5.97
20175	1732.5	4.93	5.74	20175	1732.5	4.99	5.94
20325	1747.5	5.77	6.52	20300	1745	5.65	6.67

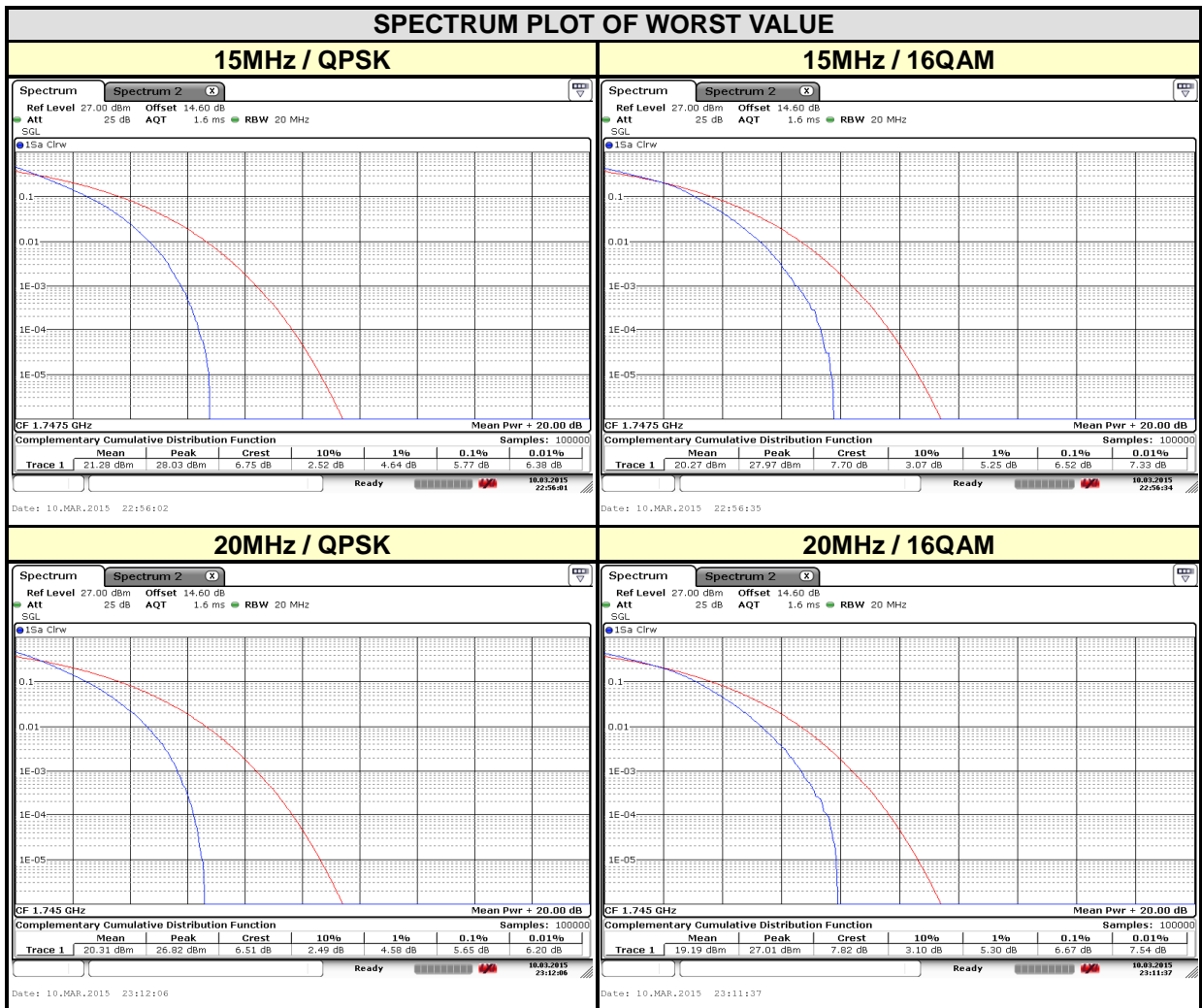



Test Report No.: RF150212N021-5

LTE BAND 17

CHANNEL BANDWIDTH: 5MHz				CHANNEL BANDWIDTH: 10MHz			
CHANNEL	FREQUENCY (MHz)	PEAK TO AVERAGE RATIO (dB)		CHANNEL	FREQUENCY (MHz)	PEAK TO AVERAGE RATIO (dB)	
		QPSK	16QAM			QPSK	16QAM
23755	706.5	5.19	5.94	23780	709	5.80	6.41
23790	710	5.19	6.03	23790	710	5.65	6.26
23825	713.5	4.96	6.00	23800	711	5.57	6.26

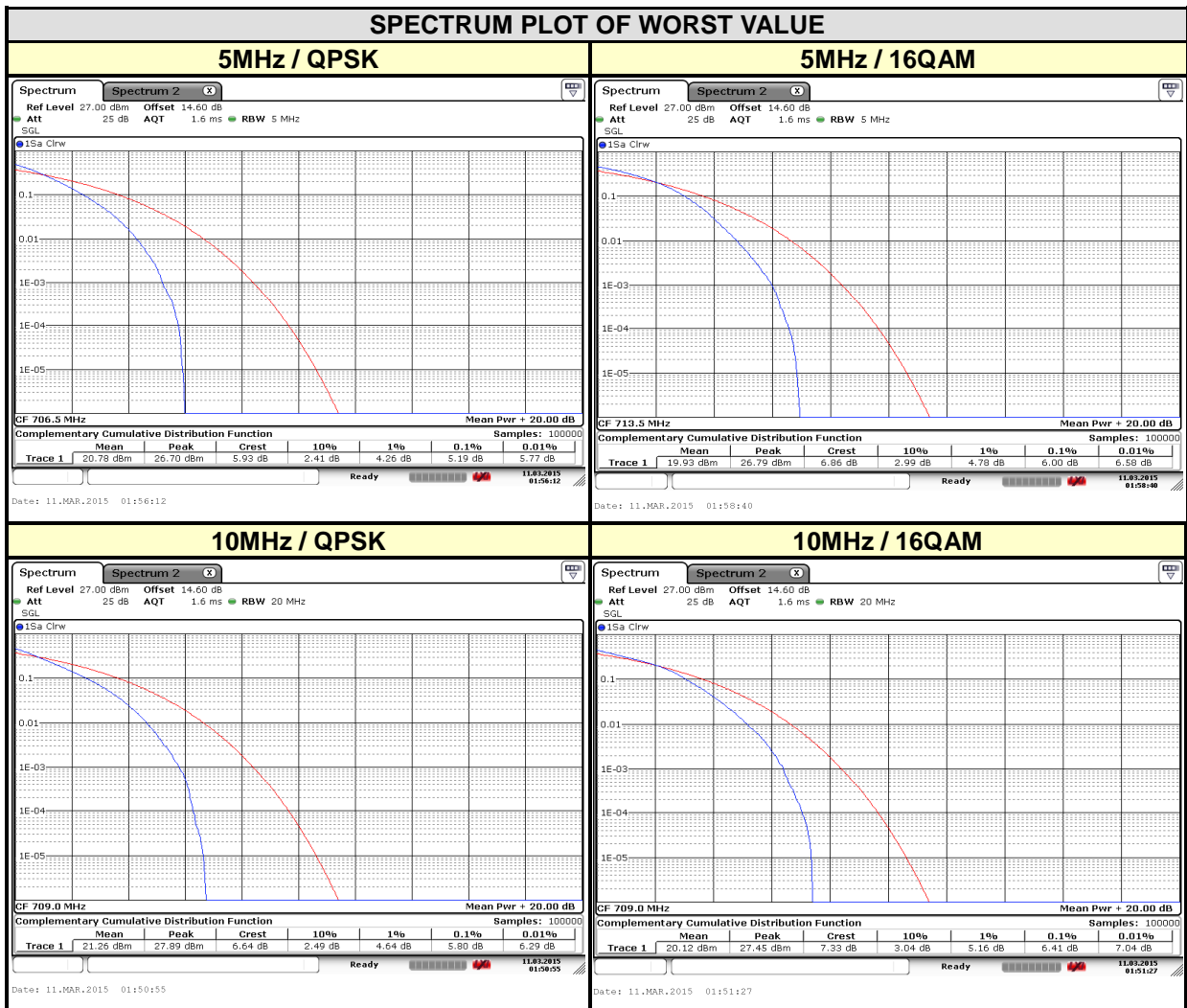

## 4.5 BAND EDGE MEASUREMENT

### 4.5.1 LIMITS OF BAND EDGE MEASUREMENT

The power of any emission outside a licensee's frequency band(s) of operation shall be attenuated below the transmitter power (P) within the licensed band(s) of operation, measured in watts, by at least  $43 + 10 \log (P)$  dB. Compliance with this provision is based on the use of measurement instrumentation employing a resolution bandwidth of 100 kilohertz or greater.

However, in the 100 kilohertz bands immediately outside and adjacent to a licensee's frequency block, a resolution bandwidth of at least 30 kHz may be employed.

### 4.5.2 TEST SETUP

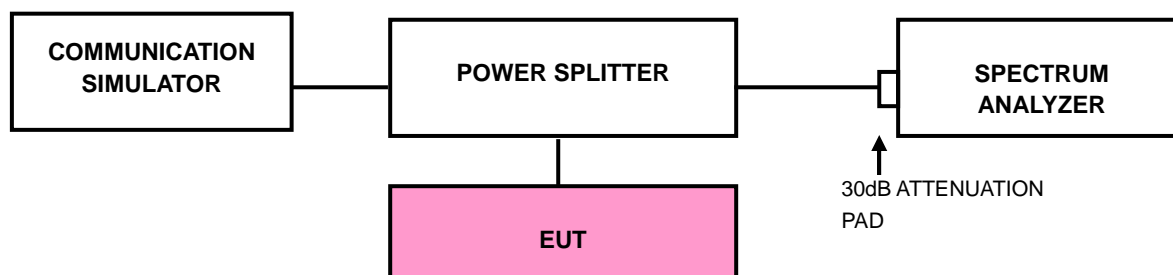

### 4.5.3 TEST PROCEDURES

- a. The EUT was set up for the maximum peak power with LTE link data modulation. The power was measured with R&S Spectrum Analyzer. All measurements were done at 2 channels (low and high operational frequency range.).
- b. The band edge measurement used the power splitter via EUT RF power connector between simulation base station and spectrum analyzer.
- c. The center frequency of spectrum is the band edge frequency and span is 1~5 MHz. RB of the spectrum is 20kHz and VB of the spectrum is 100 kHz. (LTE bandwidth 1.4MHz)
- d. The center frequency of spectrum is the band edge frequency and span is 1~5 MHz. RB of the spectrum is 30kHz and VB of the spectrum is 100kHz. (LTE bandwidth 3MHz)



**BUREAU  
VERITAS**

**Test Report No.: RF150212N021-5**

- e. The center frequency of spectrum is the band edge frequency and span is 1~5 MHz. RB of the spectrum is 50kHz and VB of the spectrum is 200kHz. (LTE bandwidth 5MHz)
- f. The center frequency of spectrum is the band edge frequency and span is 1~5 MHz. RB of the spectrum is 100kHz and VB of the spectrum is 300kHz. (LTE bandwidth 10MHz)
- g. The center frequency of spectrum is the band edge frequency and span is 1~5 MHz. RB of the spectrum is 200kHz and VB of the spectrum is 1MHz. (LTE bandwidth 15MHz)
- h. The center frequency of spectrum is the band edge frequency and span is 1~5 MHz. RB of the spectrum is 200kHz and VB of the spectrum is 1MHz. (LTE bandwidth 20MHz)
- i. Record the max trace plot into the test report.



### 4.5.4 TEST RESULTS

#### LTE BAND 4

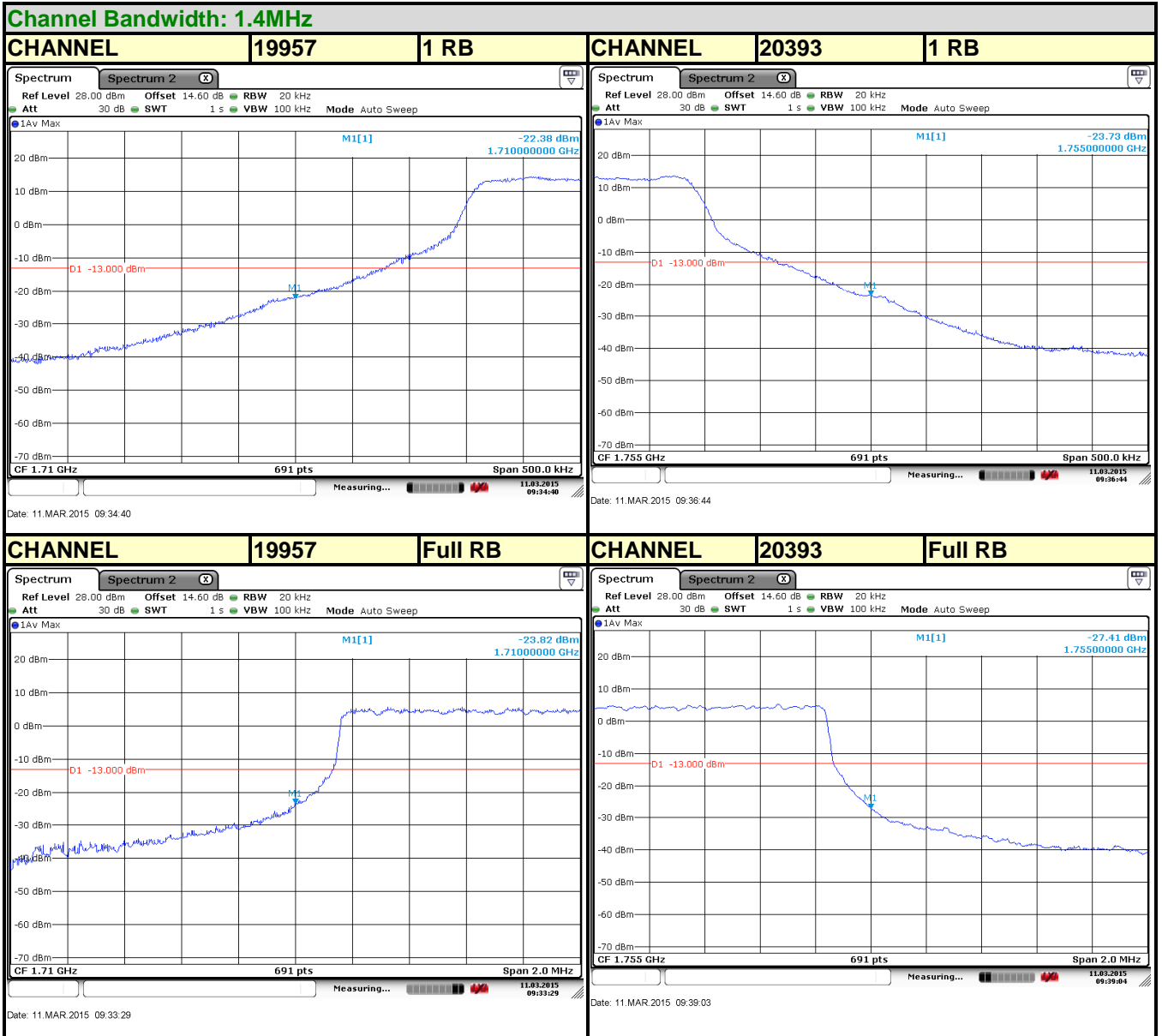



Test Report No.: RF150212N021-5

LTE BAND 4

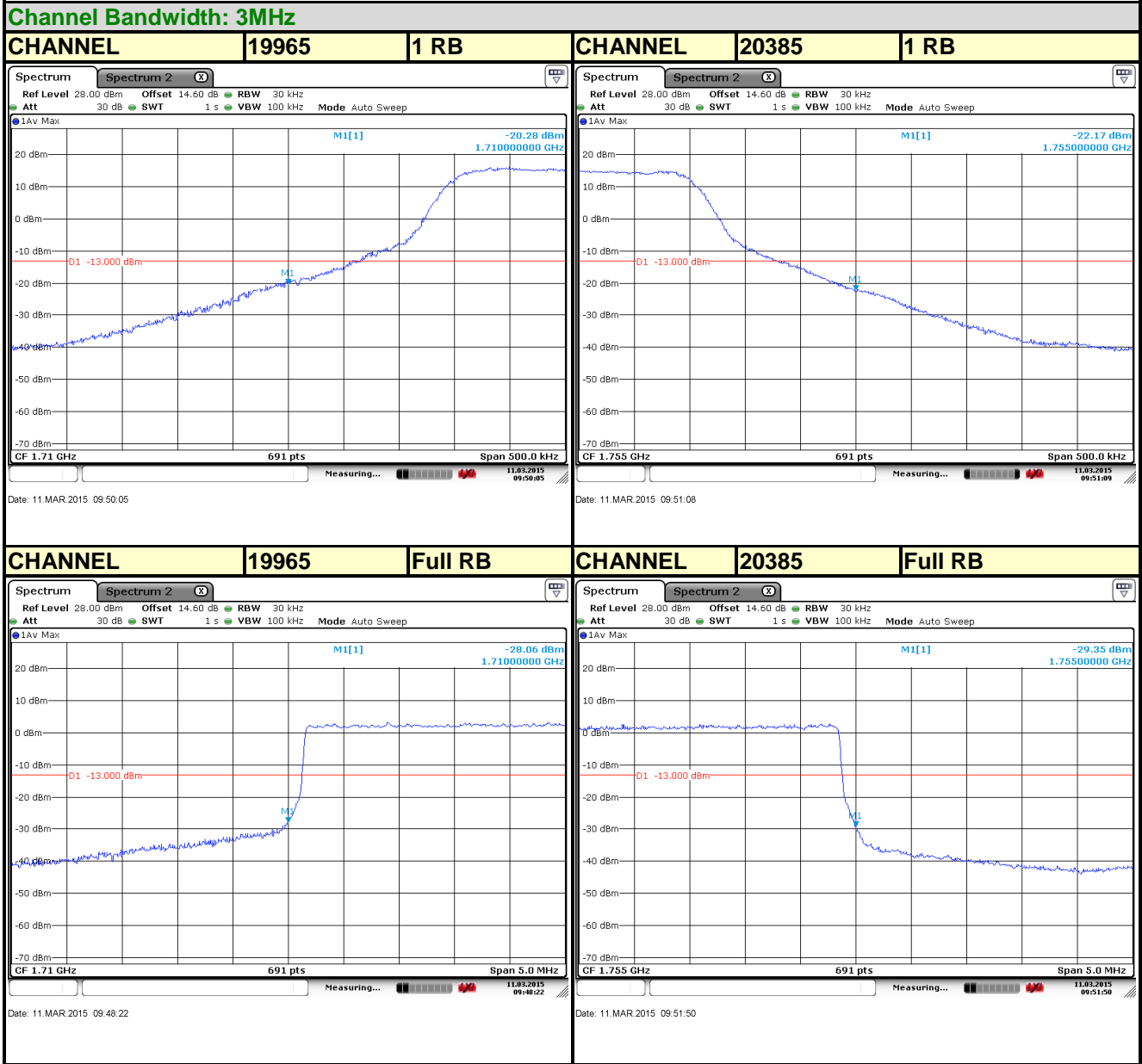



BUREAU VERITAS

Test Report No.: RF150212N021-5

LTE BAND 4

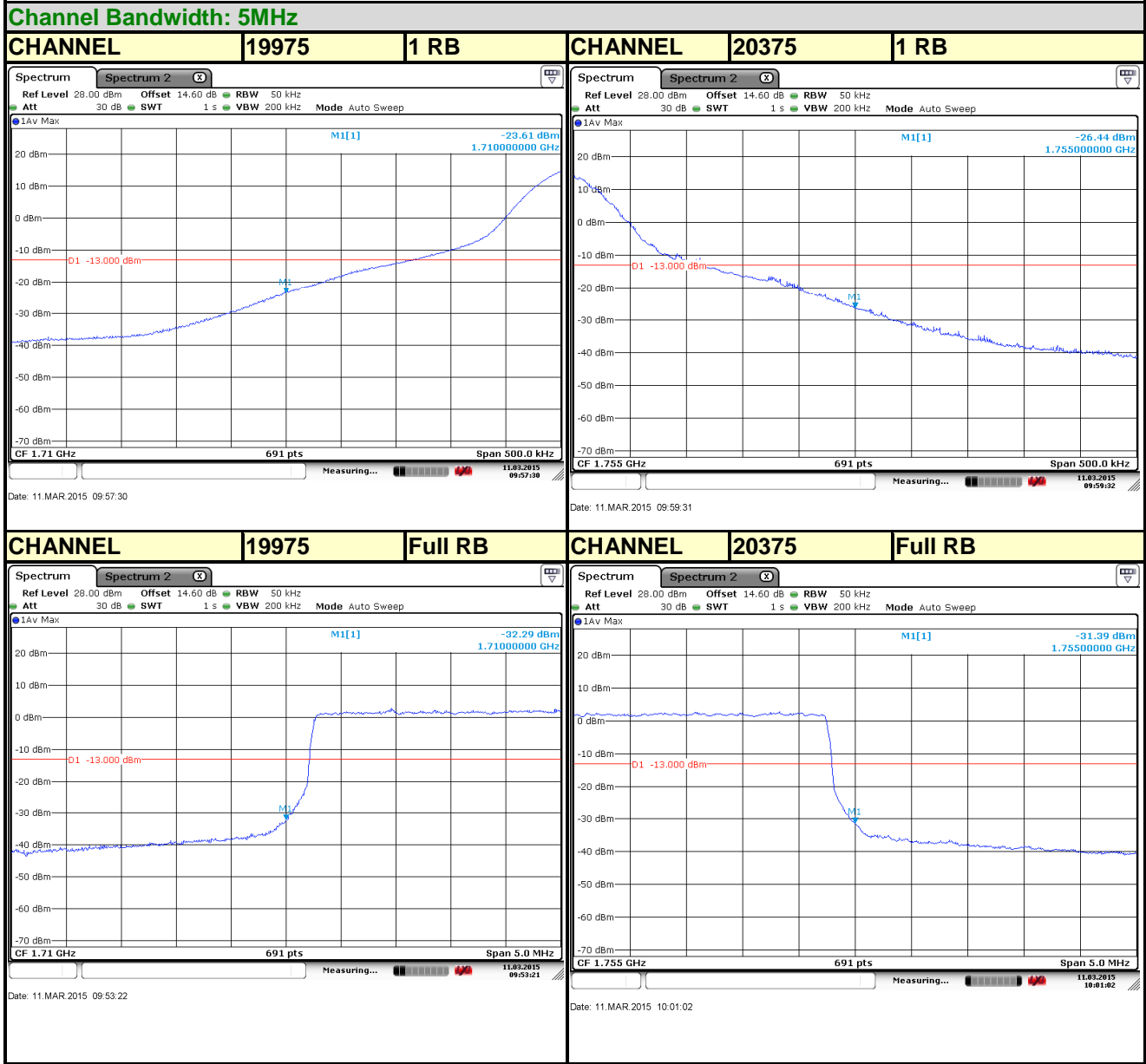

Bureau Veritas Shenzhen Co., Ltd.  
Dongguan Branch

No. 34, Chenwulu Section, Guantai Rd.,  
Houjie Town, Dongguan City,  
Guangdong 523942, China

Tel: +86 769 8593 5656  
Fax: +86 769 8593 1080  
Email: [customerservice.dg@cn.bureauveritas.com](mailto:customerservice.dg@cn.bureauveritas.com)





Test Report No.: RF150212N021-5

LTE BAND 4

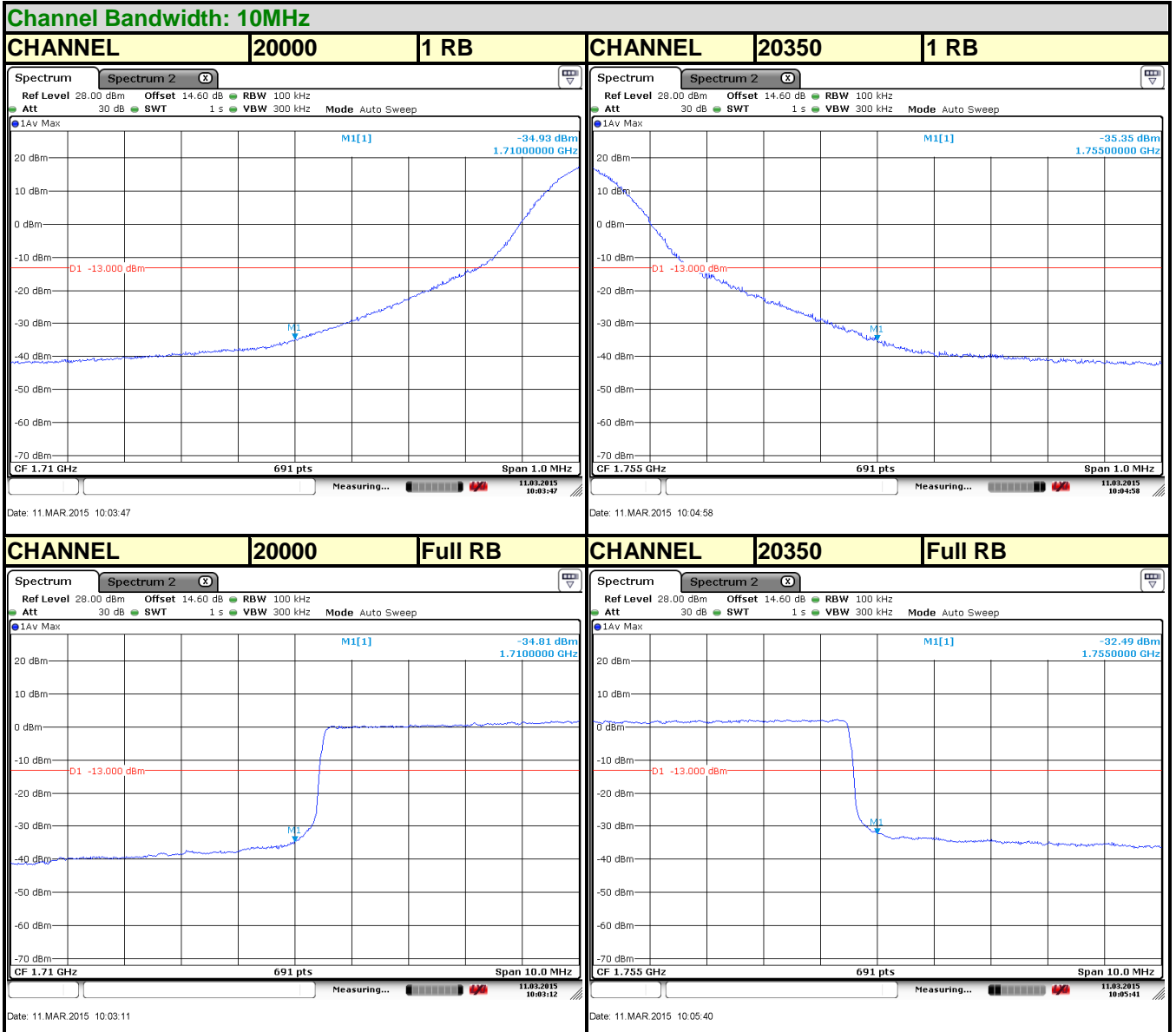

Bureau Veritas Shenzhen Co., Ltd.  
Dongguan Branch

No. 34, Chenwulu Section, Guantai Rd.,  
Houjie Town, Dongguan City,  
Guangdong 523942, China

Tel: +86 769 8593 5656  
Fax: +86 769 8593 1080  
Email: [customerservice.dg@cn.bureauveritas.com](mailto:customerservice.dg@cn.bureauveritas.com)



Test Report No.: RF150212N021-5

LTE BAND 4

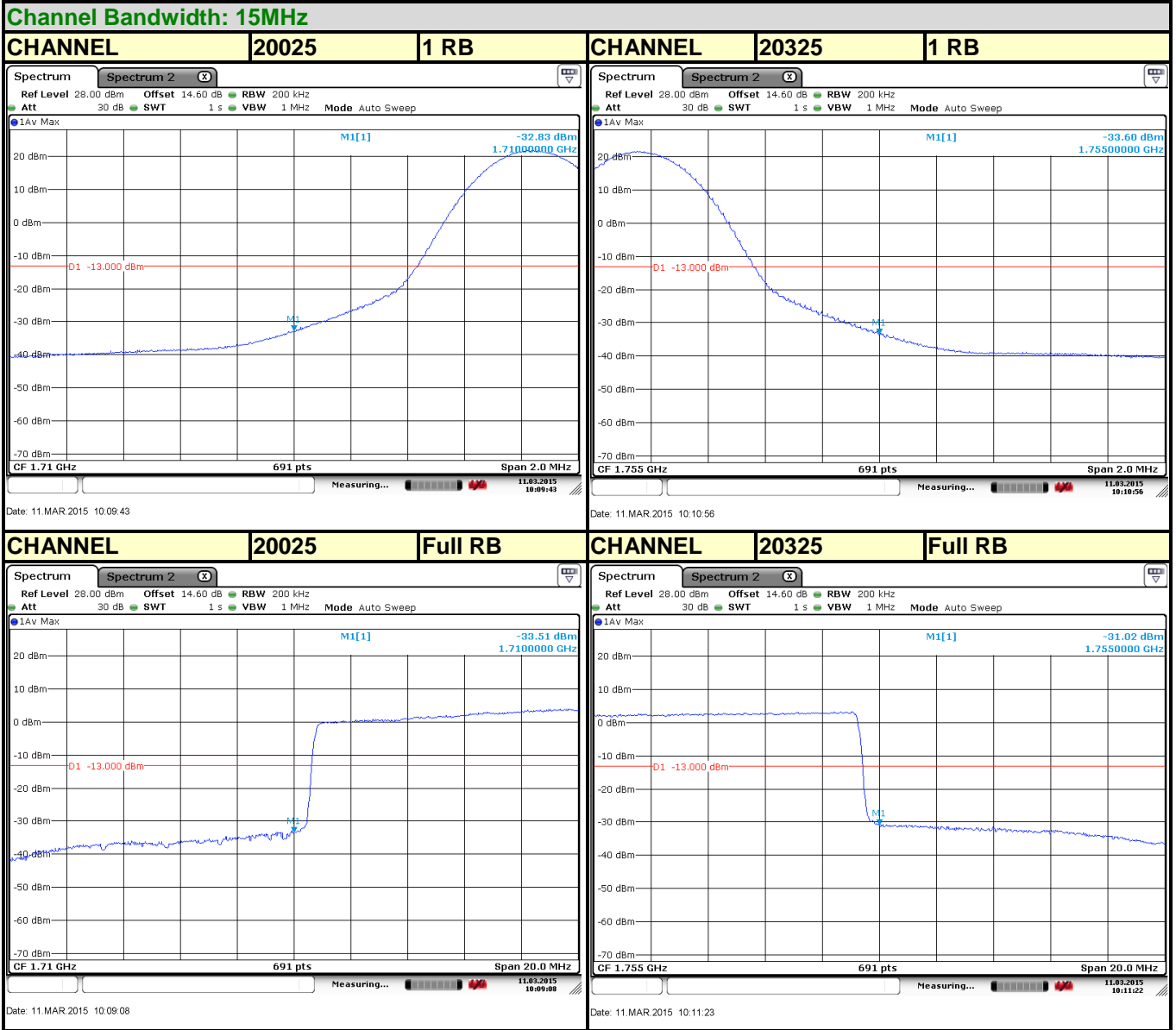

Bureau Veritas Shenzhen Co., Ltd.  
Dongguan Branch

No. 34, Chenwulu Section, Guantai Rd.,  
Houjie Town, Dongguan City,  
Guangdong 523942, China

Tel: +86 769 8593 5656  
Fax: +86 769 8593 1080  
Email: [customerservice.dg@cn.bureauveritas.com](mailto:customerservice.dg@cn.bureauveritas.com)



Test Report No.: RF150212N021-5

LTE BAND 4

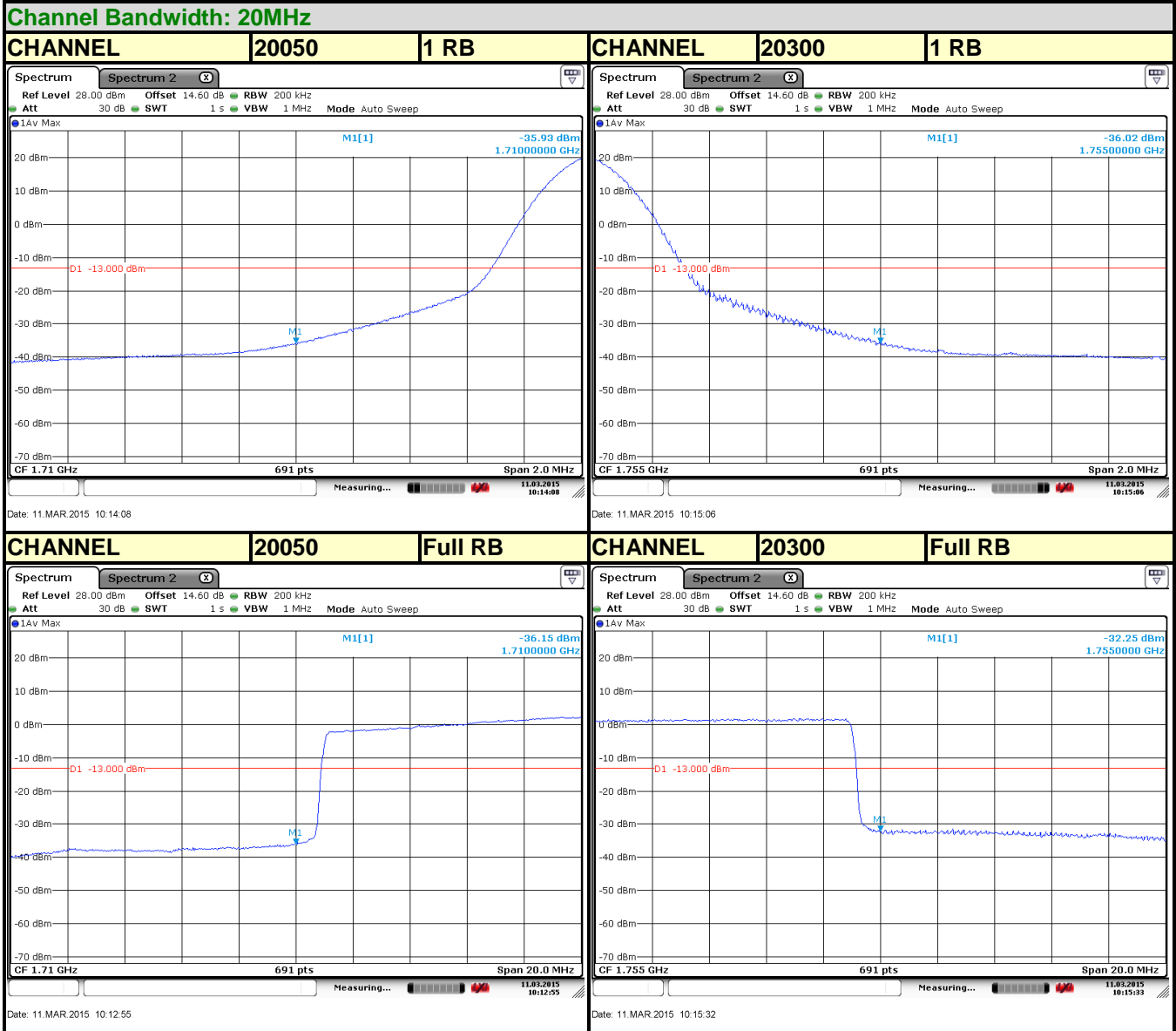



Test Report No.: RF150212N021-5

LTE BAND 17

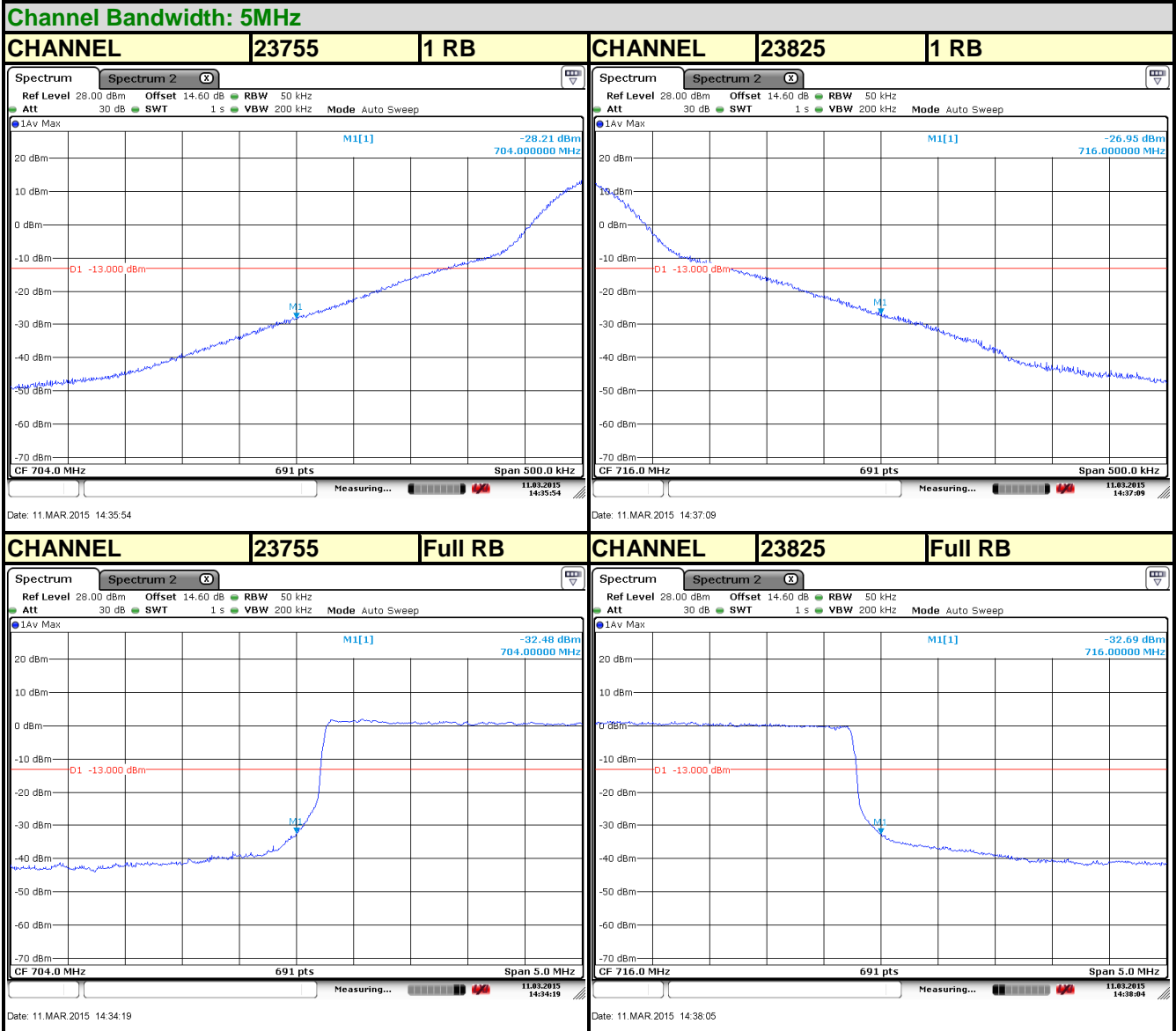

Bureau Veritas Shenzhen Co., Ltd.  
Dongguan Branch

No. 34, Chenwulu Section, Guantai Rd.,  
Houjie Town, Dongguan City,  
Guangdong 523942, China

Tel: +86 769 8593 5656  
Fax: +86 769 8593 1080  
Email: [customerservice.dg@cn.bureauveritas.com](mailto:customerservice.dg@cn.bureauveritas.com)



Test Report No.: RF150212N021-5

LTE BAND 17

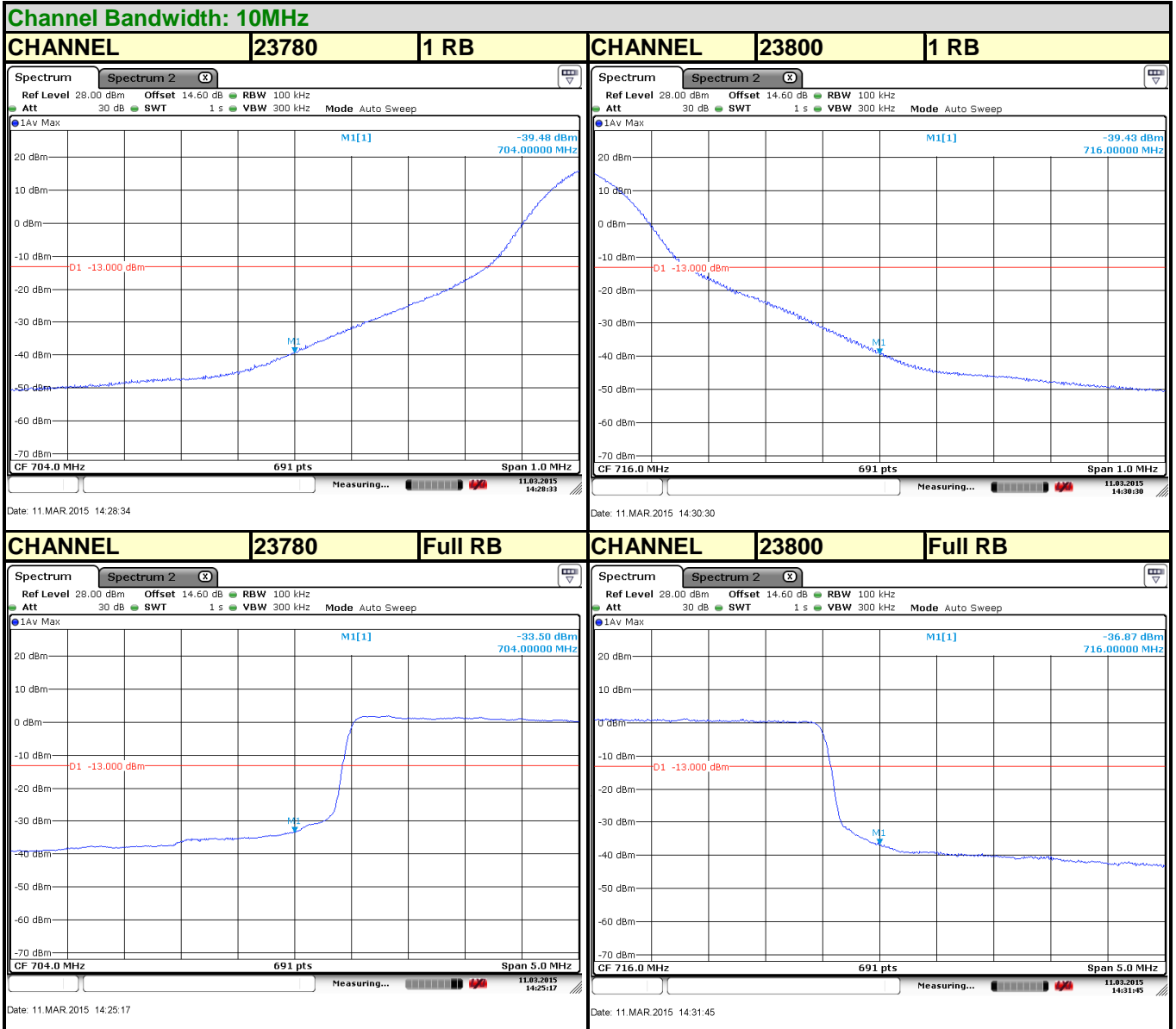

## 4.6 CONDUCTED SPURIOUS EMISSIONS

### 4.6.1 LIMITS OF CONDUCTED SPURIOUS EMISSIONS MEASUREMENT

The power of any emission outside a licensee's frequency block shall be attenuated below the transmitter power (P) by at least  $43 + 10 \log_{10}(P)$  dB. The limit of emission equal to  $-13\text{dBm}$

### 4.6.2 TEST PROCEDURE

- a. The EUT makes a phone call to the communication simulator. All measurements were done at middle operational frequency range.
- b. Measuring frequency range is from 30 MHz to 19.1GHz for LTE Band 4 and 30 MHz to 9GHz for LTE Band 12&17. 10dB attenuation pad is connected with spectrum. RBW=1MHz and VBW=3MHz are used for conducted emission measurement.

### 4.6.3 TEST SETUP

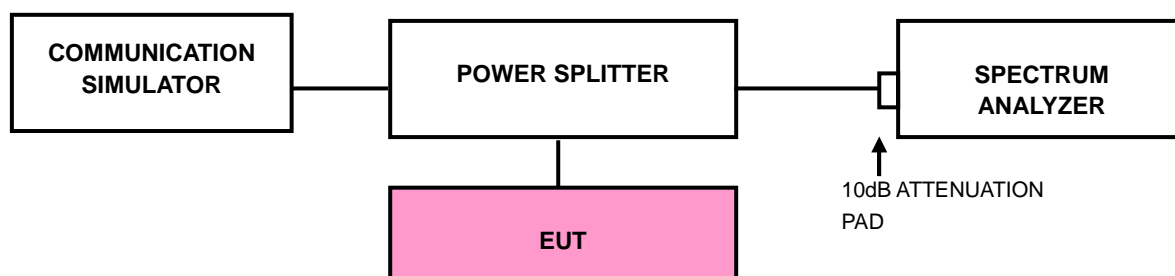



BUREAU VERITAS

Test Report No.: RF150212N021-5

### 4.6.4 TEST RESULTS

#### LTE BAND 4

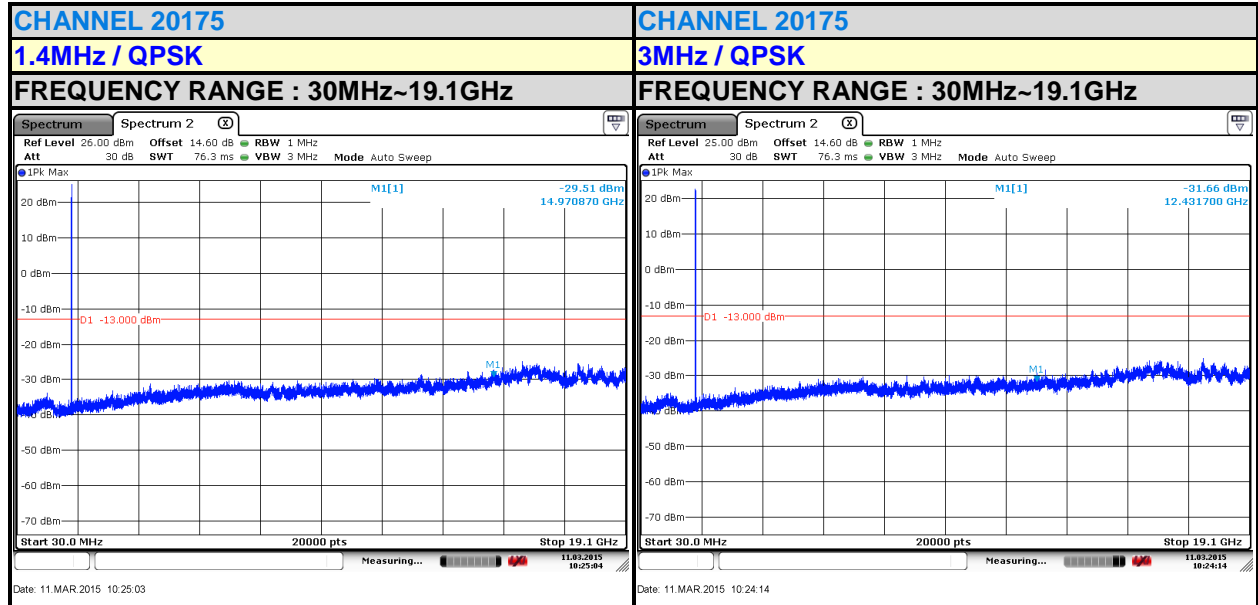

#### LTE BAND 4

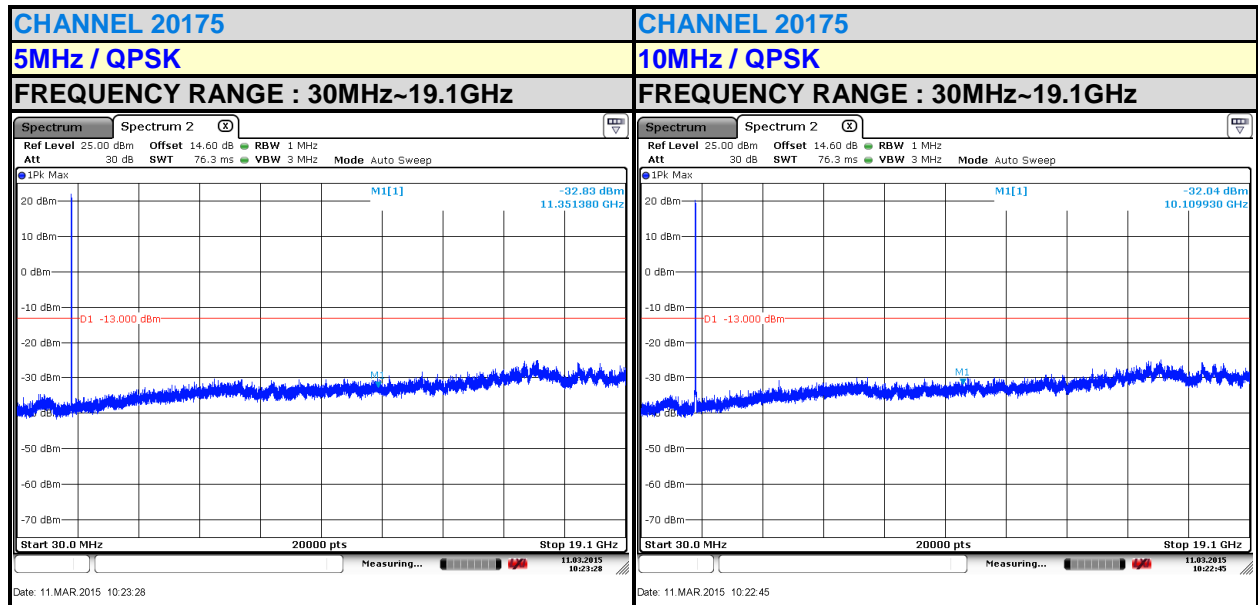

Bureau Veritas Shenzhen Co., Ltd.  
Dongguan Branch

No. 34, Chenwulu Section, Guantai Rd.,  
Houjie Town, Dongguan City,  
Guangdong 523942, China

Tel: +86 769 8593 5656  
Fax: +86 769 8593 1080  
Email: [customerservice.dg@cn.bureauveritas.com](mailto:customerservice.dg@cn.bureauveritas.com)



LTE BAND 4

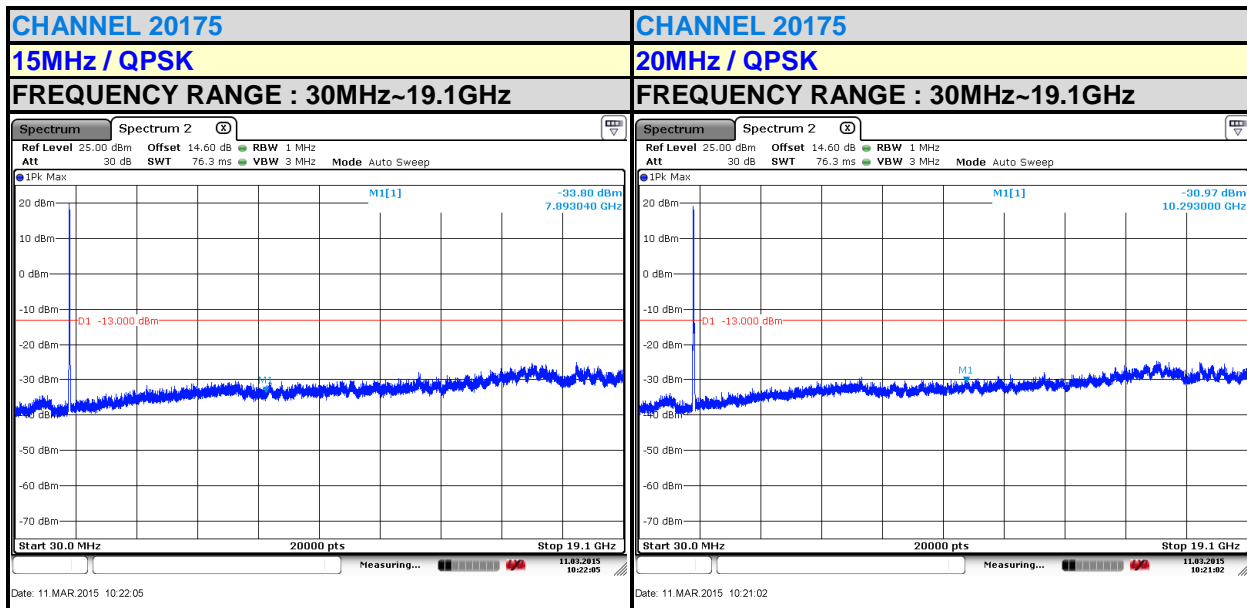

LTE BAND 17

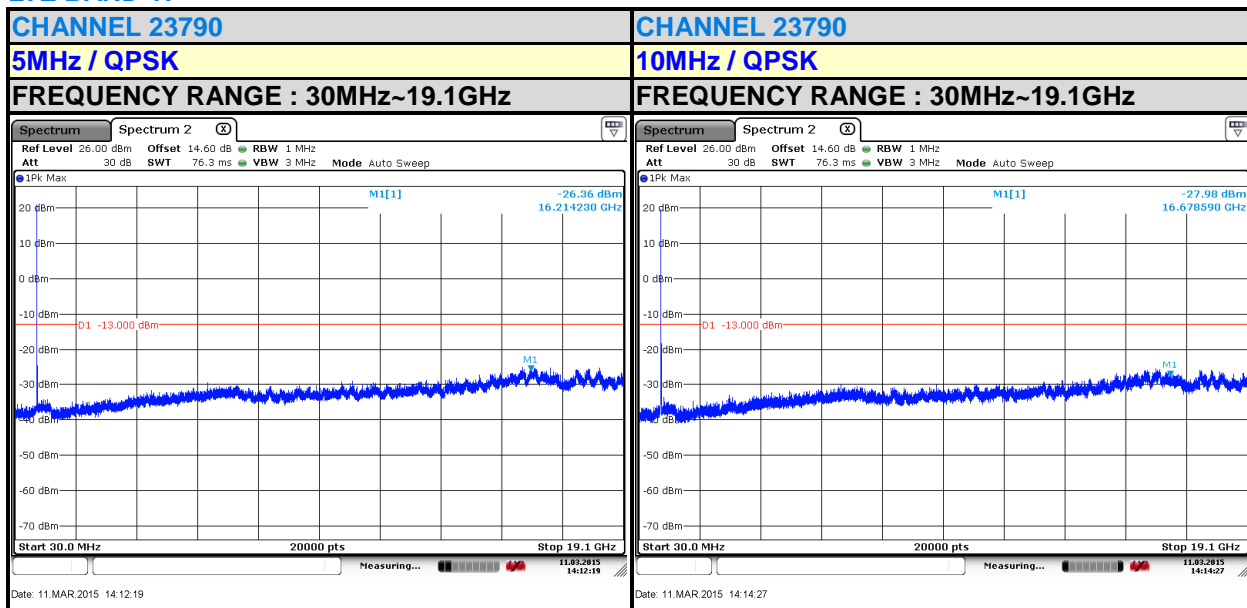





## 4.7 RADIATED EMISSION MEASUREMENT

### 4.7.1 LIMITS OF RADIATED EMISSION MEASUREMENT

The power of any emission outside a licensee's frequency block shall be attenuated below the transmitter power (P) by at least  $43 + 10 \log_{10}(P)$  dB. The limit of emission equal to  $-13\text{dBm}$

### 4.7.2 TEST PROCEDURES

- a. Substitution method is used for E.I.R.P measurement. In the semi-anechoic chamber, EUT placed on the 0.8m height of Turn Table, rotated the table around 360 degrees to search the maximum radiation power and receiver antenna shall be rotated vertical and horizontal polarization and moved height from 1m to 4m to find the maximum polar radiated power. The "Read Value" is the spectrum reading the maximum power value.
- b. The substitution horn antenna is substituted for EUT at the same position and signals generator export the CW signal to the substitution antenna via a TX cable. Rotated the Turn Table and moved receiving antenna to find the maximum radiation power. Adjust output power level of S.G to get a Value of spectrum reading equal to "Read Value" of step a. Record the power level of S.G
- c.  $\text{EIRP} = \text{Output power level of S.G} - \text{TX cable loss} + \text{Antenna gain of substitution horn}$ .
- d. E.R.P power can be calculated form E.I.R.P power by subtracting the gain of dipole,  $\text{E.R.P power} = \text{E.I.P.R power} - 2.15\text{dBi}$ .

**NOTE:** The resolution bandwidth of spectrum analyzer is 1 MHz and the video bandwidth is 3 MHz.

### 4.7.3 DEVIATION FROM TEST STANDARD

No deviation

#### 4.7.4 TEST SETUP

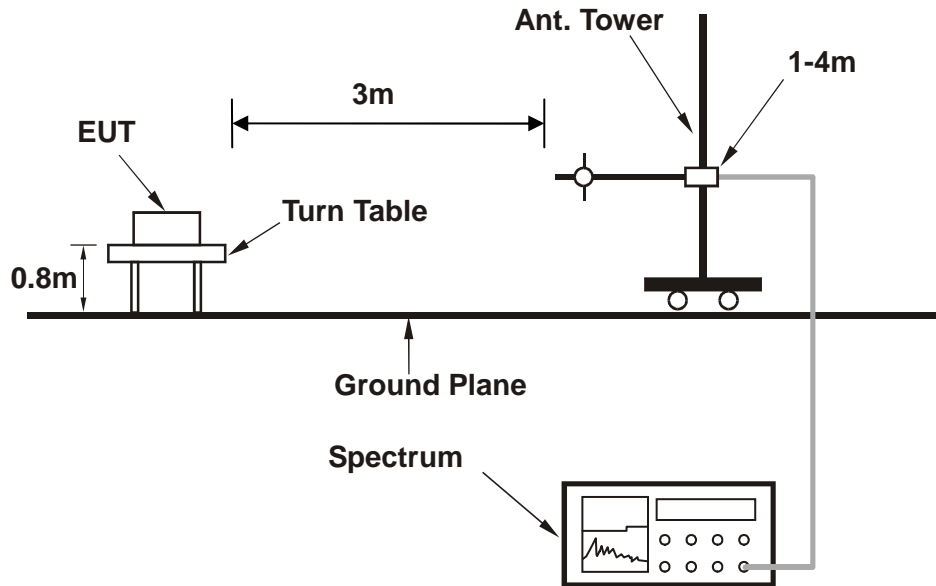

For the actual test configuration, please refer to the attached file (Test Setup Photo).



Test Report No.: RF150212N021-5

### 4.7.5 TEST RESULTS

#### BELOW 1GHz WORST-CASE DATA

##### LTE Band 4:

<b>MODE</b>	TX channel20175	<b>FREQUENCY RANGE</b>	Below 1000MHz
<b>ENVIRONMENTAL CONDITIONS</b>	26deg. C, 56%RH	<b>INPUT POWER</b>	DC 5V from adapter
<b>TESTED BY</b>	Tyler Zhang		
<b>ANTENNA POLARITY &amp; TEST DISTANCE: HORIZONTAL AT 3 M</b>			

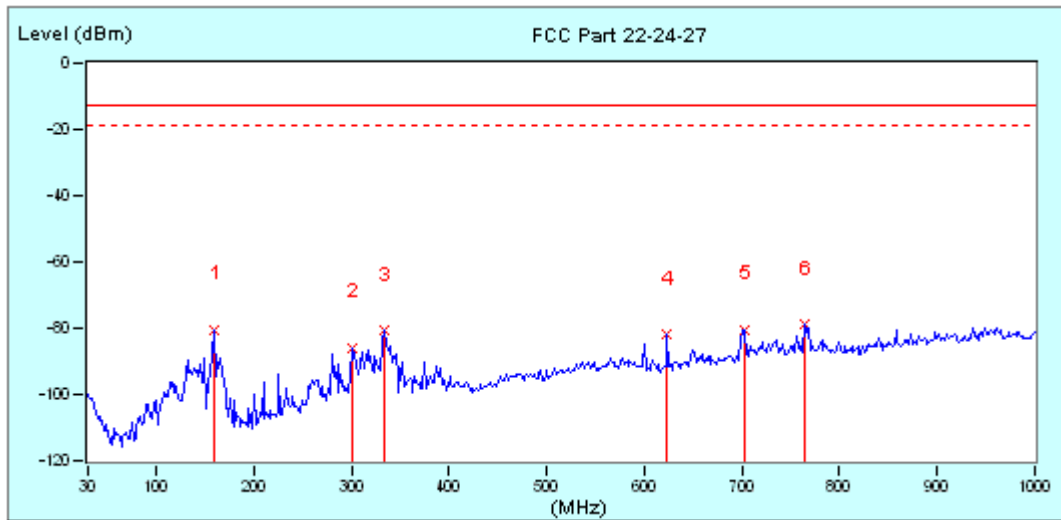

No.	Frequency MHz	Factor dB	Reading dBm	Emission dBm	Limit dBm	Margin dB	Tower / Table cm deg	
1	159.33	-19.04	-61.39	-80.43	-13.00	-67.43	100	244
2	299.98	-15.13	-70.73	-85.86	-13.00	-72.86	100	274
3	333.93	-14.36	-66.30	-80.66	-13.00	-67.66	100	254
4	623.32	-6.10	-75.94	-82.04	-13.00	-69.04	100	304
5	702.53	-5.04	-75.39	-80.43	-13.00	-67.43	100	295
*	763.97	-3.20	-75.48	-78.68	-13.00	-65.68	100	285



Test Report No.: RF150212N021-5

<b>MODE</b>	TX channel20175	<b>FREQUENCY RANGE</b>	Below 1000MHz
<b>ENVIRONMENTAL CONDITIONS</b>	26deg. C, 56%RH	<b>INPUT POWER</b>	DC 5V from adapter
<b>TESTED BY</b>	Tyler Zhang		
<b>ANTENNA POLARITY &amp; TEST DISTANCE: VERTICAL AT 3 M</b>			

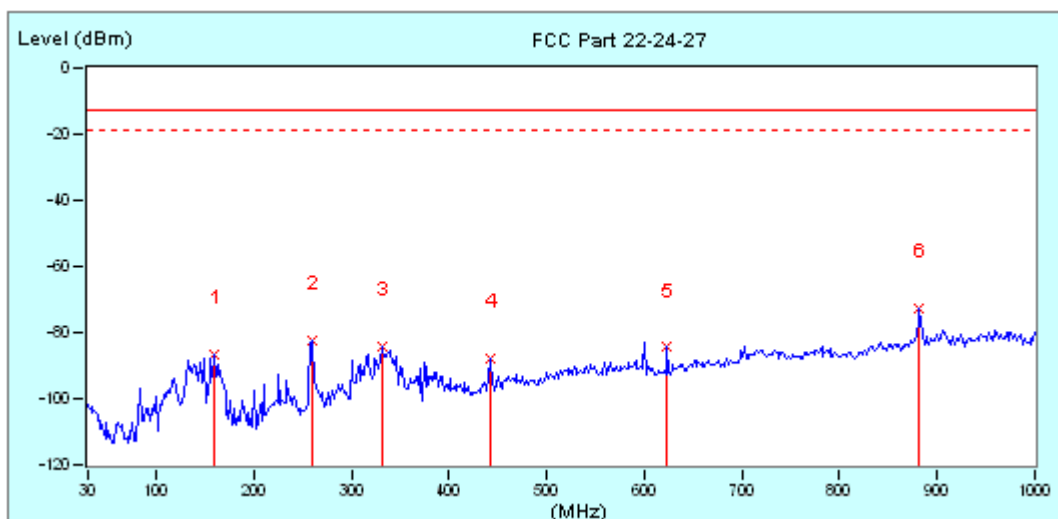

No.	Frequency MHz	Factor dB	Reading dBm	Emission dBm	Limit dBm	Margin dB	Tower / Table cm deg	
1	159.33	-19.04	-67.35	-86.39	-13.00	-73.39	100	83
2	259.57	-15.42	-66.77	-82.19	-13.00	-69.19	100	72
3	330.70	-14.48	-69.60	-84.08	-13.00	-71.08	100	62
4	442.25	-10.79	-76.84	-87.63	-13.00	-74.63	100	93
5	623.32	-6.10	-78.22	-84.32	-13.00	-71.32	100	45
* 6	881.98	-1.53	-71.02	-72.55	-13.00	-59.55	100	33



**BUREAU  
VERITAS**

Test Report No.: RF150212N021-5

**LTE Band 17:**

<b>MODE</b>	TX channel23790	<b>FREQUENCY RANGE</b>	Below 1000MHz
<b>ENVIRONMENTAL CONDITIONS</b>	26deg. C, 56%RH	<b>INPUT POWER</b>	DC 5V from adapter
<b>TESTED BY</b>	Tyler Zhang		
<b>ANTENNA POLARITY &amp; TEST DISTANCE: HORIZONTAL AT 3 M</b>			

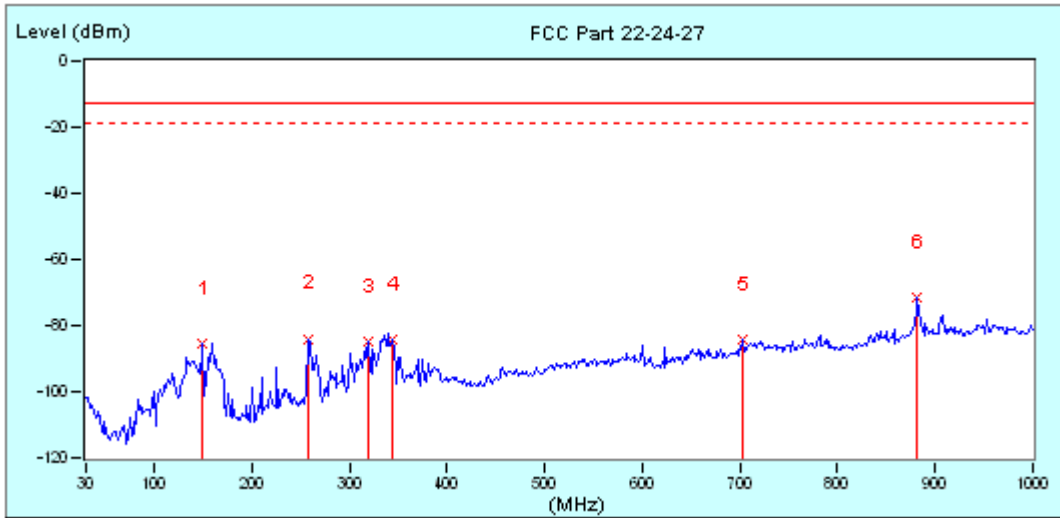

No.	Frequency MHz	Factor dB	Reading dBm	Emission dBm	Limit dBm	Margin dB	Tower / Table cm deg	
1	149.63	-18.52	-66.88	-85.40	-13.00	-72.40	100	0
2	257.95	-15.63	-68.40	-84.03	-13.00	-71.03	100	0
3	319.38	-14.40	-70.53	-84.93	-13.00	-71.93	100	0
4	343.63	-14.02	-70.11	-84.13	-13.00	-71.13	100	0
5	702.53	-5.04	-79.07	-84.11	-13.00	-71.11	100	0
* 6	881.98	-1.53	-69.98	-71.51	-13.00	-58.51	100	0



Test Report No.: RF150212N021-5

<b>MODE</b>	TX channel23790	<b>FREQUENCY RANGE</b>	Below 1000MHz
<b>ENVIRONMENTAL CONDITIONS</b>	26deg. C, 56%RH	<b>INPUT POWER</b>	DC 5V from adapter
<b>TESTED BY</b>	Tyler Zhang		
<b>ANTENNA POLARITY &amp; TEST DISTANCE: VERTICAL AT 3 M</b>			

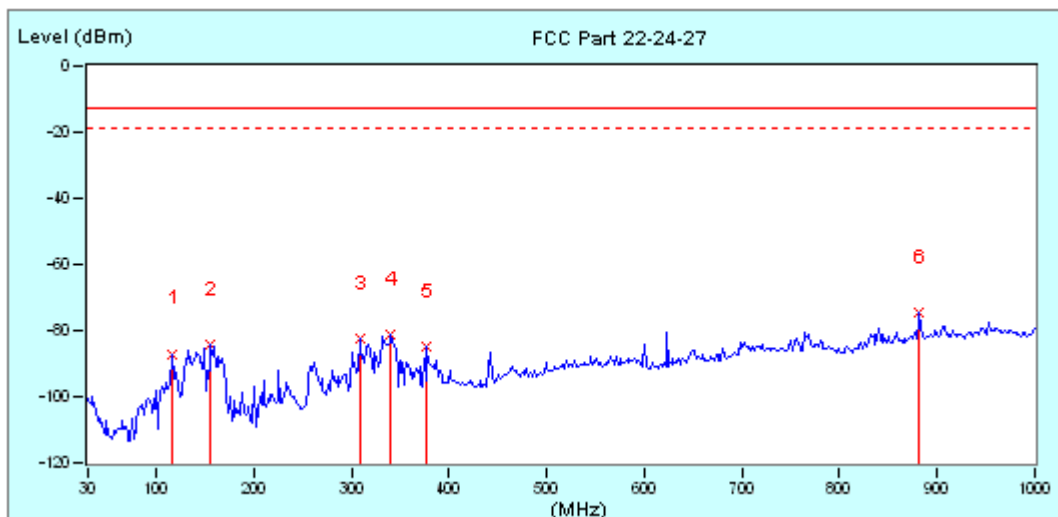

No.	Frequency MHz	Factor dB	Reading dBm	Emission dBm	Limit dBm	Margin dB	Tower / Table cm deg	
1	115.68	-18.68	-68.39	-87.07	-13.00	-74.07	100	178
2	156.10	-18.87	-65.60	-84.47	-13.00	-71.47	100	168
3	308.07	-14.83	-67.81	-82.64	-13.00	-69.64	100	138
4	340.40	-14.11	-67.26	-81.37	-13.00	-68.37	100	148
5	377.58	-12.74	-72.36	-85.10	-13.00	-72.10	100	158
*	6	881.98	-1.53	-73.27	-74.80	-13.00	100	125



**BUREAU  
VERITAS**

Test Report No.: RF150212N021-5

ABOVE 1GHz

LTE BAND 4

CHANNEL BANDWIDTH: 1.4MHz / QPSK

<b>MODE</b>	TX channel 20175	<b>FREQUENCY RANGE</b>	Below 1000MHz
<b>ENVIRONMENTAL CONDITIONS</b>	26deg. C, 56%RH	<b>INPUT POWER</b>	DC 5V from adapter
<b>TESTED BY</b>	Tyler Zhang		
<b>ANTENNA POLARITY &amp; TEST DISTANCE: HORIZONTAL AT 3 M</b>			

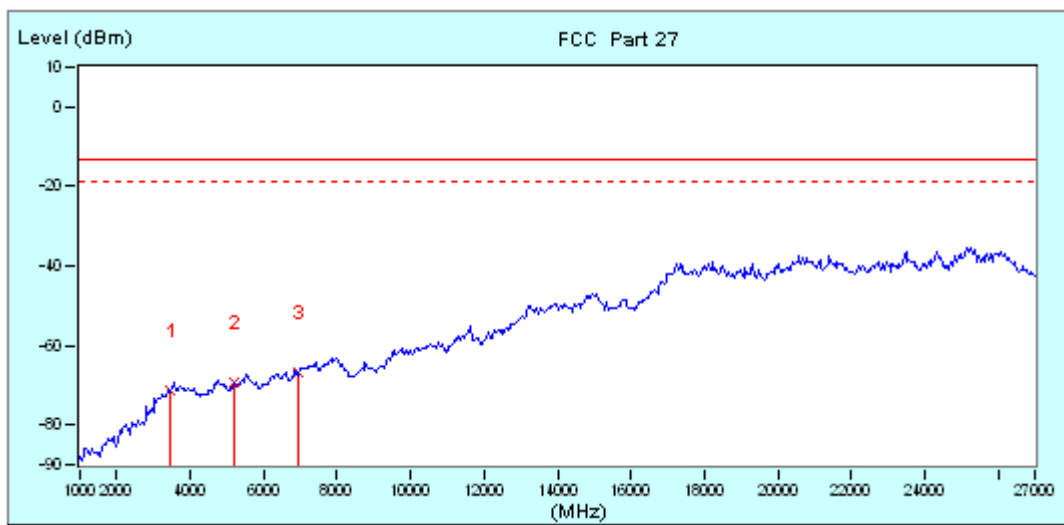

No.	Frequency MHz	Factor dB	Reading dBm	Emission dBm	Limit dBm	Margin dB	Tower / Table cm deg
1	3470.00 (PK)	-2.72	-68.50	-71.22	-13.00	-58.22	100 0
2	5200.00 (PK)	-0.21	-69.07	-69.28	-13.00	-56.28	100 0
*	6930.00 (PK)	0.44	-67.07	-66.63	-13.00	-53.63	100 0



Test Report No.: RF150212N021-5

<b>MODE</b>	TX channel 20175	<b>FREQUENCY RANGE</b>	Below 1000MHz
<b>ENVIRONMENTAL CONDITIONS</b>	26deg. C, 56%RH	<b>INPUT POWER</b>	DC 5V from adapter
<b>TESTED BY</b>	Tyler Zhang		
<b>ANTENNA POLARITY &amp; TEST DISTANCE: VERTICAL AT 3 M</b>			

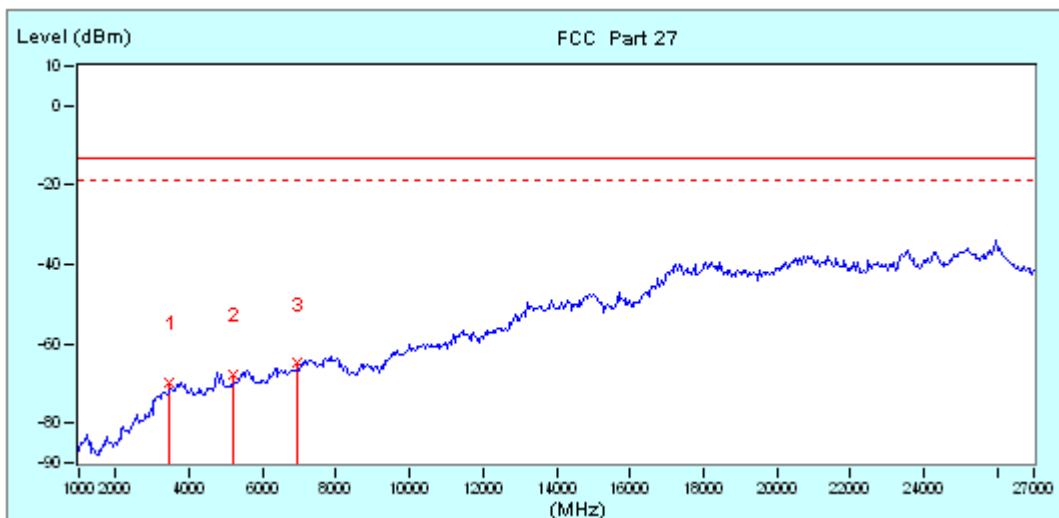

No.	Frequency MHz	Factor dB	Reading dBm	Emission dBm	Limit dBm	Margin dB	Tower / Table cm deg	
1	3470.00 (PK)	-2.84	-67.14	-69.98	-13.00	-56.98	100	0
2	5200.00 (PK)	0.31	-68.22	-67.91	-13.00	-54.91	100	0
*	3	6930.00 (PK)	0.95	-65.93	-64.98	-13.00	100	0





**BUREAU  
VERITAS**

Test Report No.: RF150212N021-5

**CHANNEL BANDWIDTH: 3MHz / QPSK**

<b>MODE</b>	TX channel 20175	<b>FREQUENCY RANGE</b>	Below 1000MHz
<b>ENVIRONMENTAL CONDITIONS</b>	26deg. C, 56%RH	<b>INPUT POWER</b>	DC 5V from adapter
<b>TESTED BY</b>	Tyler Zhang		
<b>ANTENNA POLARITY &amp; TEST DISTANCE: HORIZONTAL AT 3 M</b>			

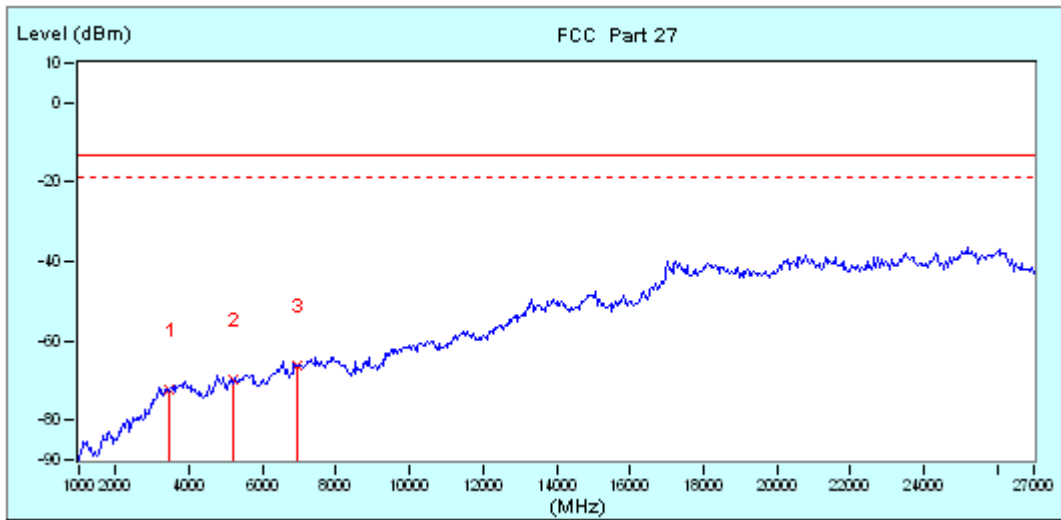

No.	Frequency MHz	Factor dB	Reading dBm	Emission dBm	Limit dBm	Margin dB	Tower / Table cm deg
1	3470.00 (PK)	-2.72	-69.43	-72.15	-13.00	-59.15	100 0
2	5200.00 (PK)	-0.21	-69.58	-69.79	-13.00	-56.79	100 0
*	6930.00 (PK)	0.44	-66.50	-66.06	-13.00	-53.06	100 0



Test Report No.: RF150212N021-5

<b>MODE</b>	TX channel 20175	<b>FREQUENCY RANGE</b>	Below 1000MHz
<b>ENVIRONMENTAL CONDITIONS</b>	26deg. C, 56%RH	<b>INPUT POWER</b>	DC 5V from adapter
<b>TESTED BY</b>	Tyler Zhang		
<b>ANTENNA POLARITY &amp; TEST DISTANCE: VERTICAL AT 3 M</b>			

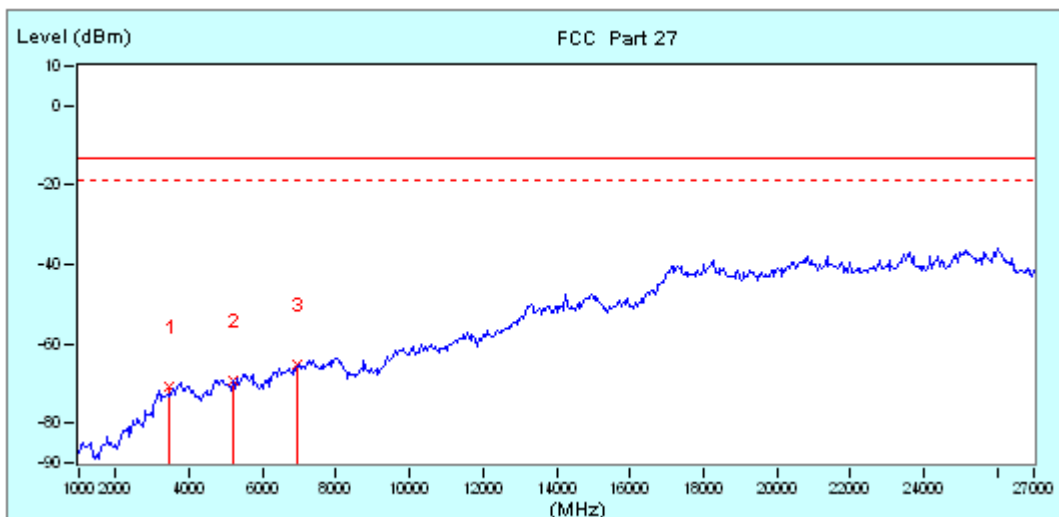

No.	Frequency MHz	Factor dB	Reading dBm	Emission dBm	Limit dBm	Margin dB	Tower / Table	
							cm	deg
1	3470.00 (PK)	-2.84	-68.08	-70.92	-13.00	-57.92	100	0
2	5200.00 (PK)	0.31	-69.58	-69.27	-13.00	-56.27	100	0
* 3	6930.00 (PK)	0.95	-66.12	-65.17	-13.00	-52.17	100	0



**BUREAU  
VERITAS**

Test Report No.: RF150212N021-5

**CHANNEL BANDWIDTH: 5MHz / QPSK**

<b>MODE</b>	TX channel 20175	<b>FREQUENCY RANGE</b>	Below 1000MHz
<b>ENVIRONMENTAL CONDITIONS</b>	26deg. C, 56%RH	<b>INPUT POWER</b>	DC 5V from adapter
<b>TESTED BY</b>	Tyler Zhang		
<b>ANTENNA POLARITY &amp; TEST DISTANCE: HORIZONTAL AT 3 M</b>			

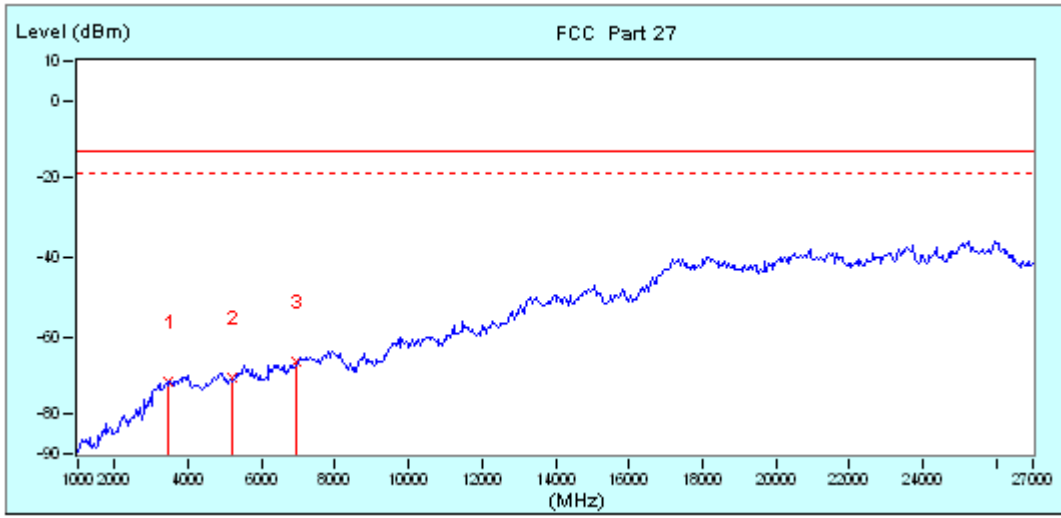

No.	Frequency MHz	Factor dB	Reading dBm	Emission dBm	Limit dBm	Margin dB	Tower / Table cm deg	
1	3470.00 (PK)	-2.72	-68.71	-71.43	-13.00	-58.43	100	0
2	5200.00 (PK)	-0.21	-69.92	-70.13	-13.00	-57.13	100	0
*	6930.00 (PK)	0.44	-66.74	-66.30	-13.00	-53.30	100	0



Test Report No.: RF150212N021-5

<b>MODE</b>	TX channel 20175	<b>FREQUENCY RANGE</b>	Below 1000MHz
<b>ENVIRONMENTAL CONDITIONS</b>	26deg. C, 56%RH	<b>INPUT POWER</b>	DC 5V from adapter
<b>TESTED BY</b>	Tyler Zhang		
<b>ANTENNA POLARITY &amp; TEST DISTANCE: VERTICAL AT 3 M</b>			

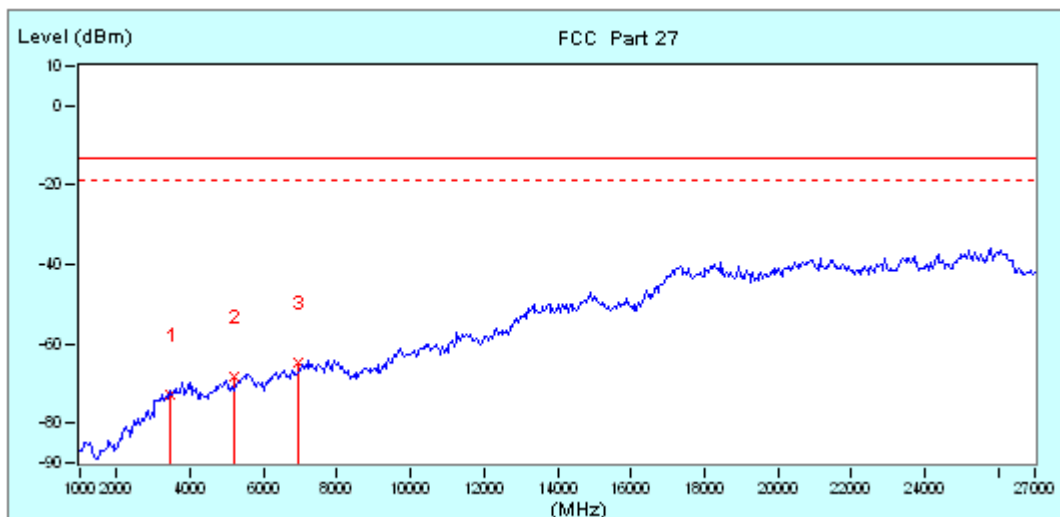

No.	Frequency MHz	Factor dB	Reading dBm	Emission dBm	Limit dBm	Margin dB	Tower / Table cm deg	
1	3470.00 (PK)	-2.84	-70.00	-72.84	-13.00	-59.84	100	0
2	5200.00 (PK)	0.31	-68.75	-68.44	-13.00	-55.44	100	0
*	6930.00 (PK)	0.95	-65.89	-64.94	-13.00	-51.94	100	0



**BUREAU  
VERITAS**

Test Report No.: RF150212N021-5

**CHANNEL BANDWIDTH: 10MHz / QPSK**

<b>MODE</b>	TX channel 20175	<b>FREQUENCY RANGE</b>	Below 1000MHz
<b>ENVIRONMENTAL CONDITIONS</b>	26deg. C, 56%RH	<b>INPUT POWER</b>	DC 5V from adapter
<b>TESTED BY</b>	Tyler Zhang		
<b>ANTENNA POLARITY &amp; TEST DISTANCE: HORIZONTAL AT 3 M</b>			

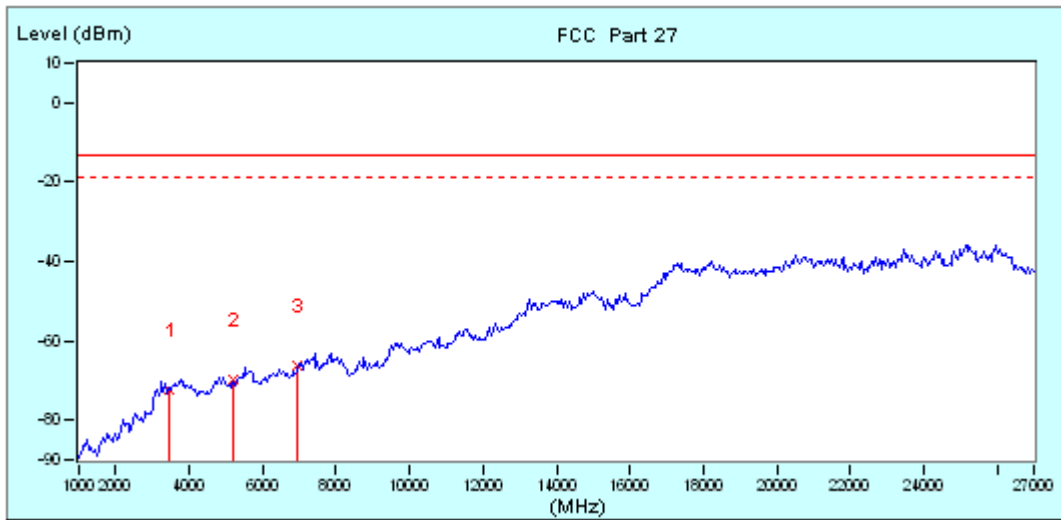

No.	Frequency MHz	Factor dB	Reading dBm	Emission dBm	Limit dBm	Margin dB	Tower / Table cm deg	
1	3470.00 (PK)	-2.72	-69.38	-72.10	-13.00	-59.10	100	0
2	5200.00 (PK)	-0.21	-69.55	-69.76	-13.00	-56.76	100	0
*	6930.00 (PK)	0.44	-66.79	-66.35	-13.00	-53.35	100	0



Test Report No.: RF150212N021-5

<b>MODE</b>	TX channel 20175	<b>FREQUENCY RANGE</b>	Below 1000MHz
<b>ENVIRONMENTAL CONDITIONS</b>	26deg. C, 56%RH	<b>INPUT POWER</b>	DC 5V from adapter
<b>TESTED BY</b>	Tyler Zhang		
<b>ANTENNA POLARITY &amp; TEST DISTANCE: VERTICAL AT 3 M</b>			

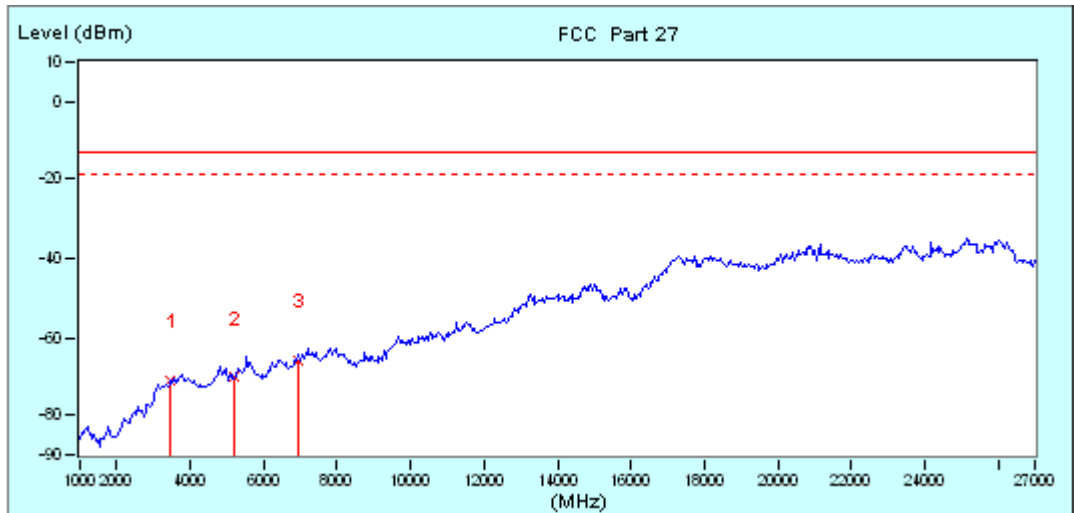

No.	Frequency MHz	Factor dB	Reading dBm	Emission dBm	Limit dBm	Margin dB	Tower / Table cm deg	
1	3470.00 (PK)	-2.84	-68.02	-70.86	-13.00	-57.86	100	0
2	5200.00 (PK)	0.31	-70.31	-70.00	-13.00	-57.00	100	0
*	6930.00 (PK)	0.95	-66.80	-65.85	-13.00	-52.85	100	0



**BUREAU  
VERITAS**

Test Report No.: RF150212N021-5

**CHANNEL BANDWIDTH: 15MHz / QPSK**

<b>MODE</b>	TX channel 20175	<b>FREQUENCY RANGE</b>	Below 1000MHz
<b>ENVIRONMENTAL CONDITIONS</b>	26deg. C, 56%RH	<b>INPUT POWER</b>	DC 5V from adapter
<b>TESTED BY</b>	Tyler Zhang		
<b>ANTENNA POLARITY &amp; TEST DISTANCE: HORIZONTAL AT 3 M</b>			

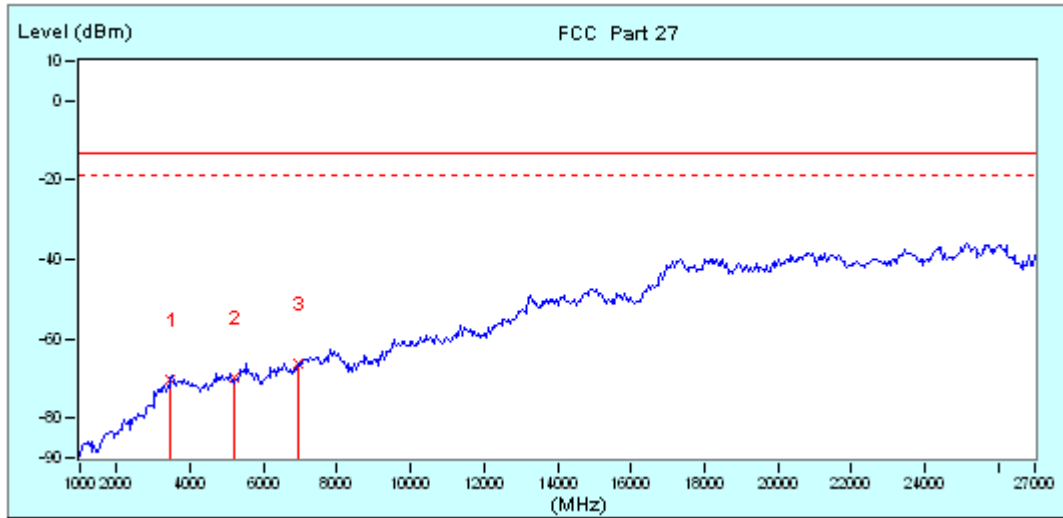

No.	Frequency MHz	Factor dB	Reading dBm	Emission dBm	Limit dBm	Margin dB	Tower / Table cm deg
1	3470.00 (PK)	-2.72	-67.74	-70.46	-13.00	-57.46	100 0
2	5200.00 (PK)	-0.21	-69.62	-69.83	-13.00	-56.83	100 0
* 3	6930.00 (PK)	0.44	-66.69	-66.25	-13.00	-53.25	100 0



Test Report No.: RF150212N021-5

<b>MODE</b>	TX channel 20175	<b>FREQUENCY RANGE</b>	Below 1000MHz
<b>ENVIRONMENTAL CONDITIONS</b>	26deg. C, 56%RH	<b>INPUT POWER</b>	DC 5V from adapter
<b>TESTED BY</b>	Tyler Zhang		
<b>ANTENNA POLARITY &amp; TEST DISTANCE: VERTICAL AT 3 M</b>			

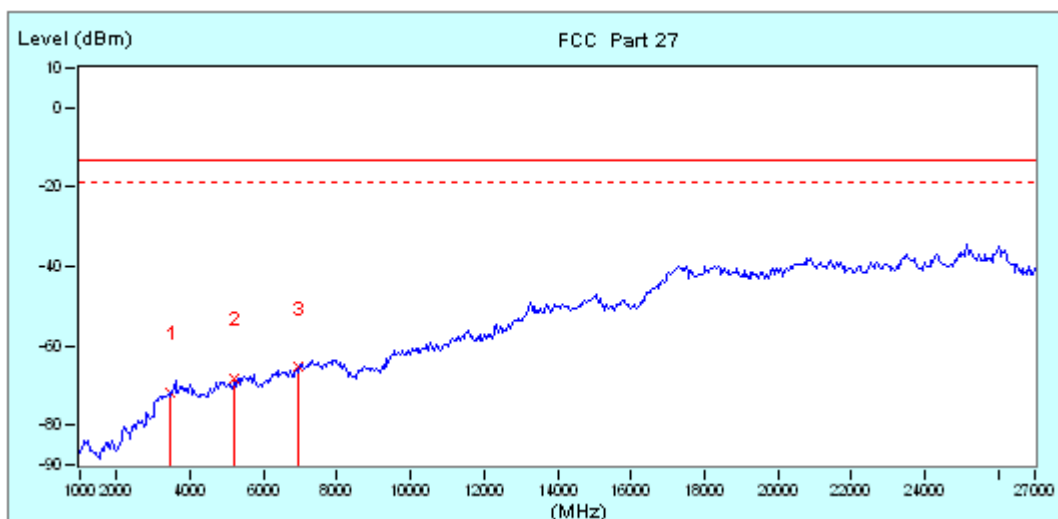

No.	Frequency MHz	Factor dB	Reading dBm	Emission dBm	Limit dBm	Margin dB	Tower / Table cm deg
1	3470.00 (PK)	-2.84	-68.76	-71.60	-13.00	-58.60	100 0
2	5200.00 (PK)	0.31	-68.39	-68.08	-13.00	-55.08	100 0
* 3	6930.00 (PK)	0.95	-66.44	-65.49	-13.00	-52.49	100 0





**BUREAU  
VERITAS**

Test Report No.: RF150212N021-5

**CHANNEL BANDWIDTH: 20MHz / QPSK**

<b>MODE</b>	TX channel 20175	<b>FREQUENCY RANGE</b>	Below 1000MHz
<b>ENVIRONMENTAL CONDITIONS</b>	26deg. C, 56%RH	<b>INPUT POWER</b>	DC 5V from adapter
<b>TESTED BY</b>	Tyler Zhang		
<b>ANTENNA POLARITY &amp; TEST DISTANCE: HORIZONTAL AT 3 M</b>			

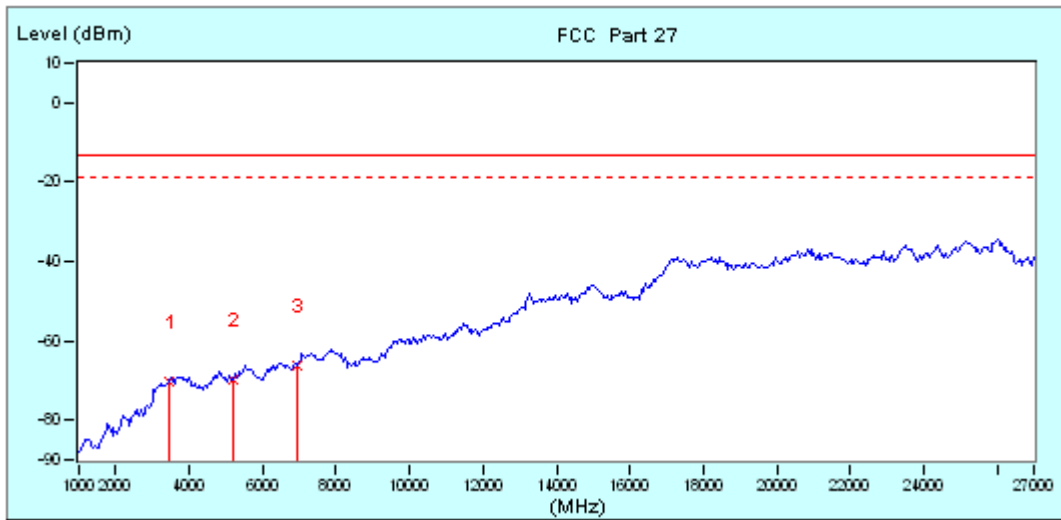

No.	Frequency MHz	Factor dB	Reading dBm	Emission dBm	Limit dBm	Margin dB	Tower / Table cm deg
1	3470.00 (PK)	-2.72	-67.74	-70.46	-13.00	-57.46	100 0
2	5200.00 (PK)	-0.21	-69.62	-69.83	-13.00	-56.83	100 0
* 3	6930.00 (PK)	0.44	-66.64	-66.20	-13.00	-53.20	100 0



Test Report No.: RF150212N021-5

<b>MODE</b>	TX channel 20175	<b>FREQUENCY RANGE</b>	Below 1000MHz
<b>ENVIRONMENTAL CONDITIONS</b>	26deg. C, 56%RH	<b>INPUT POWER</b>	DC 5V from adapter
<b>TESTED BY</b>	Tyler Zhang		
<b>ANTENNA POLARITY &amp; TEST DISTANCE: VERTICAL AT 3 M</b>			

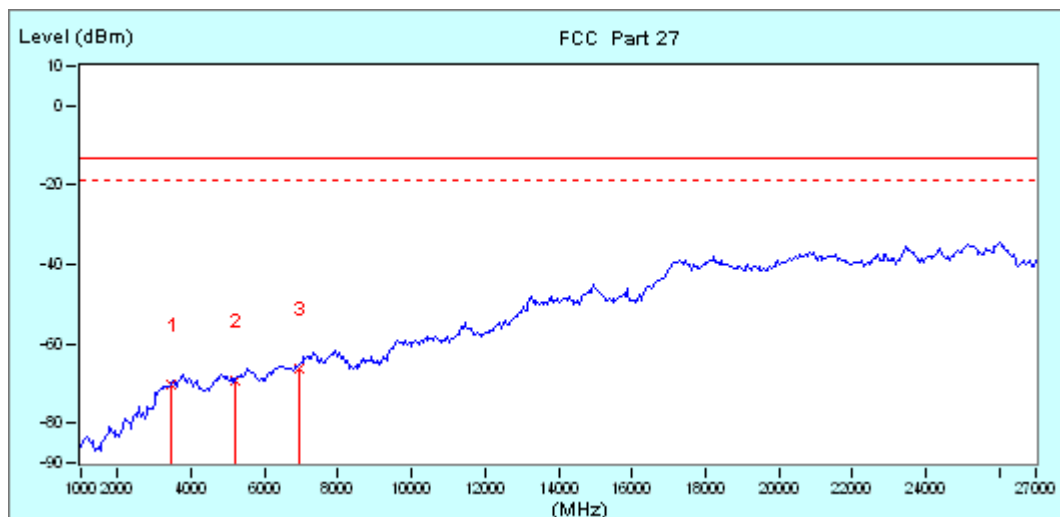

No.	Frequency MHz	Factor dB	Reading dBm	Emission dBm	Limit dBm	Margin dB	Tower / Table cm deg
1	3470.00 (PK)	-2.84	-67.62	-70.46	-13.00	-57.46	100 0
2	5200.00 (PK)	0.31	-69.39	-69.08	-13.00	-56.08	100 0
* 3	6930.00 (PK)	0.95	-67.01	-66.06	-13.00	-53.06	100 0



**BUREAU  
VERITAS**

Test Report No.: RF150212N021-5

LTE Band 17

CHANNEL BANDWIDTH: 5MHz / QPSK

<b>MODE</b>	TX channel 23790	<b>FREQUENCY RANGE</b>	Below 1000MHz
<b>ENVIRONMENTAL CONDITIONS</b>	26deg. C, 56%RH	<b>INPUT POWER</b>	DC 5V from adapter
<b>TESTED BY</b>	Tyler Zhang		
<b>ANTENNA POLARITY &amp; TEST DISTANCE: HORIZONTAL AT 3 M</b>			

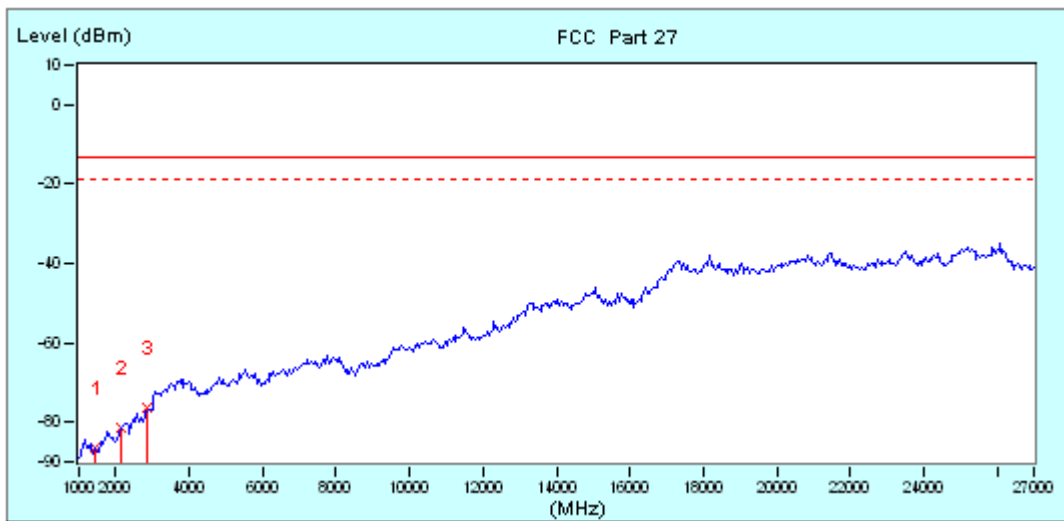

No.	Frequency MHz	Factor dB	Reading dBm	Emission dBm	Limit dBm	Margin dB	Tower / Table cm deg	
1	1420.00 (PK)	-17.90	-68.65	-86.55	-13.00	-73.55	100	0
2	2130.00 (PK)	-13.18	-68.27	-81.45	-13.00	-68.45	100	0
*	2840.00 (PK)	-8.82	-67.65	-76.47	-13.00	-63.47	100	0



Test Report No.: RF150212N021-5

<b>MODE</b>	TX channel 23790	<b>FREQUENCY RANGE</b>	Below 1000MHz
<b>ENVIRONMENTAL CONDITIONS</b>	26deg. C, 56%RH	<b>INPUT POWER</b>	DC 5V from adapter
<b>TESTED BY</b>	Tyler Zhang		
<b>ANTENNA POLARITY &amp; TEST DISTANCE: VERTICAL AT 3 M</b>			

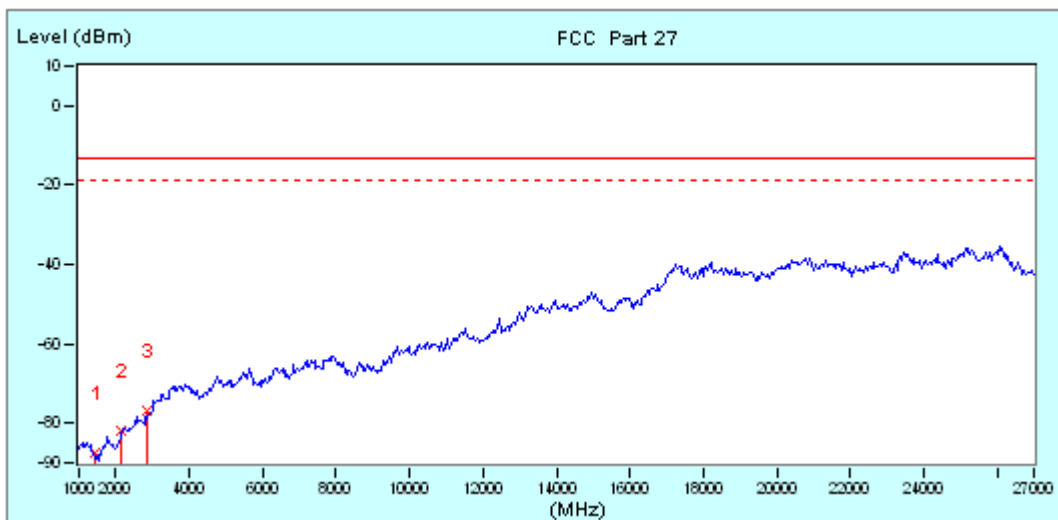

No.	Frequency MHz	Factor dB	Reading dBm	Emission dBm	Limit dBm	Margin dB	Tower / Table cm deg	
1	1420.00 (PK)	-17.86	-69.47	-87.33	-13.00	-74.33	100	0
2	2130.00 (PK)	-14.12	-67.93	-82.05	-13.00	-69.05	100	0
*	3	2840.00 (PK)	-9.03	-67.91	-76.94	-13.00	100	0



**BUREAU  
VERITAS**

**Test Report No.: RF150212N021-5**

**CHANNEL BANDWIDTH: 10MHz / QPSK**

<b>MODE</b>	TX channel 23790	<b>FREQUENCY RANGE</b>	Below 1000MHz
<b>ENVIRONMENTAL CONDITIONS</b>	26deg. C, 56%RH	<b>INPUT POWER</b>	DC 5V from adapter
<b>TESTED BY</b>	Tyler Zhang		
<b>ANTENNA POLARITY &amp; TEST DISTANCE: HORIZONTAL AT 3 M</b>			

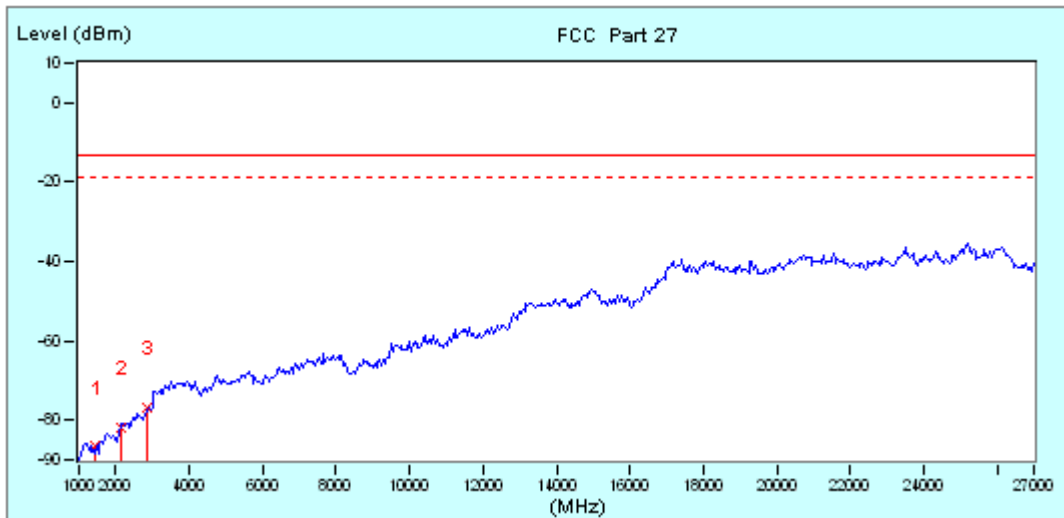

No.	Frequency MHz	Factor dB	Reading dBm	Emission dBm	Limit dBm	Margin dB	Tower / Table cm deg
1	1420.00 (PK)	-17.90	-68.77	-86.67	-13.00	-73.67	100 0
2	2130.00 (PK)	-13.18	-68.94	-82.12	-13.00	-69.12	100 0
* 3	2840.00 (PK)	-8.82	-68.10	-76.92	-13.00	-63.92	100 0



Test Report No.: RF150212N021-5

<b>MODE</b>	TX channel 23790	<b>FREQUENCY RANGE</b>	Below 1000MHz
<b>ENVIRONMENTAL CONDITIONS</b>	26deg. C, 56%RH	<b>INPUT POWER</b>	DC 5V from adapter
<b>TESTED BY</b>	Tyler Zhang		
<b>ANTENNA POLARITY &amp; TEST DISTANCE: VERTICAL AT 3 M</b>			

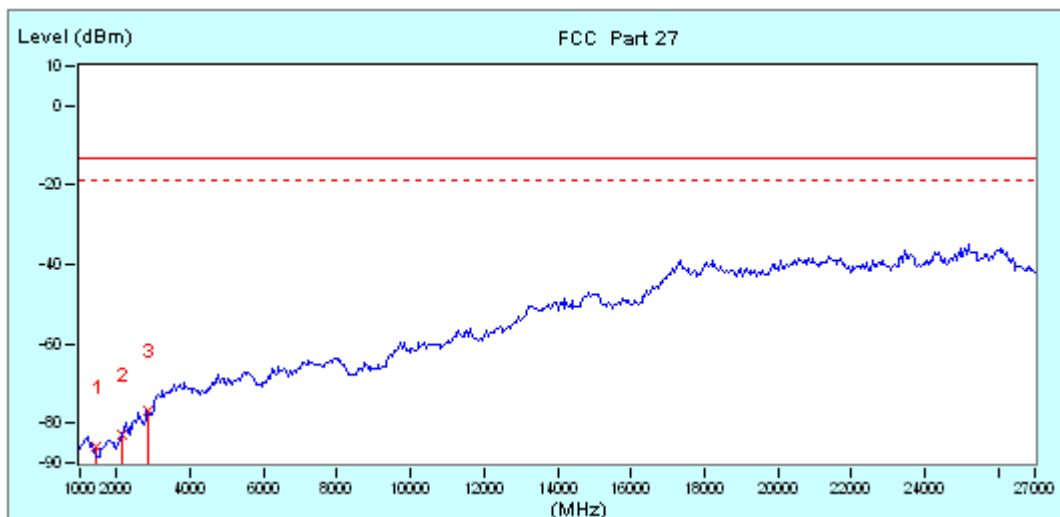

No.	Frequency MHz	Factor dB	Reading dBm	Emission dBm	Limit dBm	Margin dB	Tower / Table cm deg	
1	1420.00 (PK)	-17.60	-06.22	-80.08	-13.00	-73.08	100	0
2	2130.00 (PK)	-14.12	-68.80	-82.92	-13.00	-69.92	100	0
*	2840.00 (PK)	-9.03	-68.01	-77.04	-13.00	-64.04	100	0



**BUREAU  
VERITAS**

Test Report No.: RF150212N021-5

## 5 INFORMATION ON THE TESTING LABORATORIES

We, Bureau Veritas Shenzhen Co., Ltd. Dongguan Branch, were founded in 2002 to provide our best service in EMC, Radio, Telecom and Safety consultation. Our laboratories are accredited and approved according to ISO/IEC 17025.

If you have any comments, please feel free to contact us at the following:

**Dongguan EMC/RF Lab:**

Tel: +86-769-85935656

Fax: +86-769-85931080

**Email:** [customerservice.dg@cn.bureauveritas.com](mailto:customerservice.dg@cn.bureauveritas.com)

**Web Site:** [www.adt.com.tw](http://www.adt.com.tw)

The address and road map of all our labs can be found in our web site also.



Test Report No.: RF150212N021-5

## 6 APPENDIX A – MODIFICATIONS RECORDERS FOR ENGINEERING CHANGES TO THE EUT BY THE LAB

No modifications were made to the EUT by the lab during the test.

---END---