



FCC RF Test Report

APPLICANT : Corporativo Lanix S.A. de C.V.
EQUIPMENT : Smart phone
BRAND NAME : LANIX
MODEL NAME : Ilium L820
FCC ID : ZC4L820
STANDARD : 47 CFR Part 2, 24(E), 27(L), 27(M)
CLASSIFICATION : PCS Licensed Transmitter Held to Ear (PCE)

The product was received on Sep. 22, 2014 and testing was completed on Oct. 15, 2014. We, SPORTON INTERNATIONAL (SHENZHEN) INC., would like to declare that the tested sample has been evaluated in accordance with the test procedures given in ANSI / TIA / EIA-603-C-2004 and the testing has shown the tested sample to be in compliance with the applicable technical standards.

The test results in this report apply exclusively to the tested model / sample. Without written approval of SPORTON INTERNATIONAL (SHENZHEN) INC., the test report shall not be reproduced except in full.

Reviewed by: Joseph Lin / Supervisor

Approved by: Jones Tsai / Manager



SPORTON INTERNATIONAL (SHENZHEN) INC.

No. 3 Building, the third floor of south, Shahe River west, Fengzeyuan warehouse, Nanshan District, Shenzhen, Guangdong, P.R.C.



TABLE OF CONTENTS

REVISION HISTORY..... 3

SUMMARY OF TEST RESULT 4

1 GENERAL DESCRIPTION 6

 1.1 Applicant 6

 1.2 Manufacturer 6

 1.3 Product Feature of Equipment Under Test..... 6

 1.4 Product Specification subjective to this standard 7

 1.5 Modification of EUT 7

 1.6 Maximum ERP/EIRP Power, Frequency Tolerance, and Emission Designator 8

 1.7 Testing Location 10

 1.8 Applicable Standards..... 10

2 TEST CONFIGURATION OF EQUIPMENT UNDER TEST 11

 2.1 Test Mode 11

 2.2 Connection Diagram of Test System..... 13

 2.3 Support Unit used in test configuration and system 14

 2.4 Measurement Results Explanation Example..... 14

3 TEST RESULT..... 15

 3.1 Conducted Output Power Measurement 15

 3.2 Peak-to-Average Ratio 24

 3.3 Equivalent Isotropic Radiated Power Measurement 44

 3.4 99% Occupied Bandwidth and 26dB Bandwidth Measurement..... 49

 3.5 Conducted Band Edge Measurement 84

 3.6 Conducted Spurious Emission Measurement 150

 3.7 Radiated Spurious Emission Measurement 200

 3.8 Frequency Stability Measurement..... 218

4 LIST OF MEASURING EQUIPMENT 222

5 UNCERTAINTY OF EVALUATION 223

APPENDIX A. SETUP PHOTOGRAPHS



SUMMARY OF TEST RESULT

Report Section	FCC Rule	Description	Limit	Result	Remark
3.1	§2.1046	Conducted Output Power	Reporting Only	PASS	-
3.2	§24.232(d)	Peak-to-Average Ratio	<13 dB	PASS	-
3.3	§24.232(c) §27.50(h)(2)	Equivalent Isotropic Radiated Power (Band 2) (Band 7)	EIRP < 2Watt	PASS	-
	§27.50(d)(4)	Equivalent Isotropic Radiated Power (Band 4)	EIRP < 1Watt		
3.4	§2.1049 §24.238(b) §27.53(h)(3) §27.53(m)(6)	Occupied Bandwidth & 26dB Bandwidth	Reporting Only	PASS	-
3.5	§2.1051 §24.238(a) §27.53(h)	Conducted Band Edge Measurement (Band 2) (Band 4)	$< 43+10\log_{10}(P[\text{Watt}])$	PASS	-
	§2.1051 §27.53(m)(4)	Conducted Band Edge Measurement (Band 7)	< 5MHz: -10 dBm 5 MHz~6MHz or 26dB(BW): -13 dBm ≥6MHz or 26dB(BW): -25 dBm		



Report Section	FCC Rule	Description	Limit	Result	Remark
3.6	§2.1051 §24.238(a) §27.53(h)	Conducted Spurious Emission (Band 2) (Band 4)	$< 43+10\log_{10}(P[\text{Watts}])$	PASS	-
	§2.1051 §27.53(m)(4)	Conducted Spurious Emission (Band 7)	$< 55+10\log_{10}(P[\text{Watts}])$	PASS	
3.7	§2.1053 §24.238(a) §27.53(h)	Radiated Spurious Emission (Band 2) (Band 4)	$< 43+10\log_{10}(P[\text{Watts}])$	PASS	Under limit 19.29 dB at 5170.770 MHz
	§2.1053 §27.53(m)(4)	Radiated Spurious Emission (Band 7)	$< 55+10\log_{10}(P[\text{Watts}])$	PASS	
3.8	§2.1055 §24.235 §27.54	Frequency Stability Temperature & Voltage	within authorized band	PASS	



1 General Description

1.1 Applicant

Corporativo Lanix S.A. de C.V.

Carretera Internacional Hermosillo-Nogales Km 8.5, Hermosillo Sonora, Mexico

1.2 Manufacturer

Tinno Mobile Technology Corp.

4/F, H-3 Building, OCT Eastern industrial Park, No.1 XiangShan East Road., Nan Shan District, Shenzhen, P.R.China

1.3 Product Feature of Equipment Under Test

Product Feature	
Equipment	Smart phone
Brand Name	LANIX
Model Name	Ilium L820
FCC ID	ZC4L820
EUT supports Radios application	GSM/GPRS/EGPRS/WCDMA/HSPA/HSPA+(Downlink Only)/LTE/ WLAN 2.4GHz 802.11b/g/n HT20/HT40 Bluetooth v3.0 + EDR/Bluetooth v4.0 LE
HW Version	V1.0
SW Version	Ilium L820_CLARO_SW_01
EUT Stage	Pre-Production

Remark: The above EUT's information was declared by manufacturer. Please refer to the specifications or user's manual for more detailed description.



1.4 Product Specification subjective to this standard

Product Specification subjective to this standard	
Tx Frequency	LTE Band 2 : 1850.7 MHz ~ 1909.3 MHz LTE Band 4 : 1710.7 MHz ~ 1754.3 MHz LTE Band 7 : 2502.5 MHz ~ 2567.5 MHz
Rx Frequency	LTE Band 2 : 1930.7 MHz ~ 1989.3 MHz LTE Band 4 : 2110.7 MHz ~ 2154.3 MHz LTE Band 7 : 2622.5MHz ~ 2687.5 MHz
Bandwidth	LTE Band 2 : 1.4MHz / 3MHz / 5MHz / 10MHz / 15MHz / 20MHz LTE Band 4 : 1.4MHz / 3MHz / 5MHz / 10MHz / 15MHz / 20MHz LTE Band 7 : 5MHz/ 10MHz / 15MHz / 20MHz
Maximum Output Power to Antenna	LTE Band 2 : 22.55 dBm LTE Band 4 : 22.17 dBm LTE Band 7 : 21.80 dBm
Antenna Type	IFA Antenna
Type of Modulation	QPSK / 16QAM

1.5 Modification of EUT

No modifications are made to the EUT during all test items.



1.6 Maximum ERP/EIRP Power, Frequency Tolerance, and Emission Designator

FCC Rule	System	Type of Modulation	BW	Emission Designator	Frequency Tolerance (ppm)	Maximum EIRP
Part 24E	LTE Band 2	QPSK	1.4 MHz	1M09G7D	-	0.3281 W
Part 24E	LTE Band 2	16QAM	1.4 MHz	1M10W7D	-	0.2673 W
Part 24E	LTE Band 2	QPSK	3 MHz	2M72G7D	-	-
Part 24E	LTE Band 2	16QAM	3 MHz	2M72W7D	-	-
Part 24E	LTE Band 2	QPSK	5 MHz	4M51G7D	-	-
Part 24E	LTE Band 2	16QAM	5 MHz	4M51W7D	-	-
Part 24E	LTE Band 2	QPSK	10 MHz	9M11G7D	0.0011 ppm	-
Part 24E	LTE Band 2	16QAM	10 MHz	9M01W7D	-	-
Part 24E	LTE Band 2	QPSK	15 MHz	13M5G7D	-	-
Part 24E	LTE Band 2	16QAM	15 MHz	13M5W7D	-	-
Part 24E	LTE Band 2	QPSK	20 MHz	18M4G7D	-	0.3236 W
Part 24E	LTE Band 2	16QAM	20 MHz	18M4W7D	-	0.2642 W
Part 27L	LTE Band 4	QPSK	1.4 MHz	1M09G7D	-	0.1914 W
Part 27L	LTE Band 4	16QAM	1.4 MHz	1M10W7D	-	0.1611 W
Part 27L	LTE Band 4	QPSK	3 MHz	2M72G7D	-	-
Part 27L	LTE Band 4	16QAM	3 MHz	2M72W7D	-	-
Part 27L	LTE Band 4	QPSK	5MHz	4M51G7D	-	-
Part 27L	LTE Band 4	16QAM	5MHz	4M51W7D	-	-
Part 27L	LTE Band 4	QPSK	10MHz	9M07G7D	0.0017 ppm	-
Part 27L	LTE Band 4	16QAM	10MHz	9M01W7D	-	-
Part 27L	LTE Band 4	QPSK	15MHz	13M5G7D	-	-
Part 27L	LTE Band 4	16QAM	15MHz	13M5W7D	-	-
Part 27L	LTE Band 4	QPSK	20MHz	18M5G7D	-	0.1884 W
Part 27L	LTE Band 4	16QAM	20MHz	18M4W7D	-	0.1368 W



FCC Rule	System	Type of Modulation	BW	Emission Designator	Frequency Tolerance	Maximum EIRP
Part 27M	LTE Band 7	QPSK	5MHz	4M52G7D	-	0.2239 W
Part 27M	LTE Band 7	16QAM	5MHz	4M51W7D	-	0.1820 W
Part 27M	LTE Band 7	QPSK	10MHz	9M11G7D	0.0020 ppm	-
Part 27M	LTE Band 7	16QAM	10MHz	9M05W7D	-	-
Part 27M	LTE Band 7	QPSK	15MHz	13M5G7D	-	-
Part 27M	LTE Band 7	16QAM	15MHz	13M5W7D	-	-
Part 27M	LTE Band 7	QPSK	20MHz	18M5G7D	-	0.2000 W
Part 27M	LTE Band 7	16QAM	20MHz	18M5W7D	-	0.1862 W



1.7 Testing Location

Test Site	SPORTON INTERNATIONAL (SHENZHEN) INC.		
Test Site Location	No. 3 Building, the third floor of south, Shahe River west, Fengzeyuan warehouse, Nanshan District, Shenzhen, Guangdong, P.R.C. TEL: +86-755- 3320-2398		
Test Site No.	Sporton Site No.		FCC Registration No.
	TH01-SZ	03CH01-SZ	831040

Test Site	SPORTON INTERNATIONAL (SHENZHEN) INC.		
Test Site Location	No. 101, Complex Building C, Guanlong Village, Xili Town, Nanshan District, Shenzhen, Guangdong, P.R.C. TEL:+86-755-8637-9589 FAX: +86-755-8637-9595		
Test Site No.	Sporton Site No.		
	OTA01-SZ		

1.8 Applicable Standards

According to the specifications of the manufacturer, the EUT must comply with the requirements of the following standards:

- ♦ 47 CFR Part 2, 24(E), 27(L), 27(M)
- ♦ ANSI / TIA / EIA-603-C-2004
- ♦ FCC KDB 971168 D01 Power Meas. License Digital Systems v02r01

Remark:

1. All test items were verified and recorded according to the standards and without any deviation during the test.
2. This EUT has also been tested and complied with the requirements of FCC Part 15, Subpart B, recorded in a separate test report.



2 Test Configuration of Equipment Under Test

2.1 Test Mode

Antenna port conducted and radiated test items listed below are performed according to KDB 971168 D01 Power Meas. License Digital Systems v02r01 with maximum output power.

Radiated measurements are performed by rotating the EUT in three different orthogonal test planes to find the maximum emission.

Test Items	Band	Bandwidth (MHz)						Modulation		RB #			Test Channel		
		1.4	3	5	10	15	20	QPSK	16QAM	1	Half	Full	L	M	H
Max. Output Power	2	v	v	v	v	v	v	v	v	v	v	v	v	v	v
	4	v	v	v	v	v	v	v	v	v	v	v	v	v	v
	7	-	-	v	v	v	v	v	v	v	v	v	v	v	v
Peak-to-Average Ratio	2						v	v	v	v		v	v	v	v
	4						v	v	v	v		v	v	v	v
	7	-	-				v	v	v	v		v	v	v	v
26dB and 99% Bandwidth	2	v	v	v	v	v	v	v	v			v		v	
	4	v	v	v	v	v	v	v	v			v		v	
	7	-	-	v	v	v	v	v	v			v		v	
Conducted Band Edge	2	v	v	v	v	v	v	v	v	v		v	v		v
	4	v	v	v	v	v	v	v	v	v		v	v		v
	7	-	-	v	v	v	v	v	v	v		v	v		v



Test Items	Band	Bandwidth (MHz)						Modulation		RB #			Test Channel		
		1.4	3	5	10	15	20	QPSK	16QAM	1	Half	Full	L	M	H
Conducted Spurious Emission	2	v	v	v	v	v	v	v	v	v			v	v	v
	4	v	v	v	v	v	v	v	v	v			v	v	v
	7	-	-	v	v	v	v	v	v	v			v	v	v
Frequency Stability	2				v			v				v		v	
	4				v			v				v		v	
	7	-	-		v			v				v		v	
E.R.P/ E.I.R.P.	2	v					v	v	v	v			v	v	v
	4	v					v	v	v	v			v	v	v
	7	-	-	v			v	v	v	v			v	v	v
Radiated Spurious Emission	2	v	v	v	v	v	v	v		v				v	
	4	v	v	v	v	v	v	v		v				v	
	7	-	-	v	v	v	v	v		v				v	
Note	<p>1. The mark "v " means that this configuration is chosen for testing</p> <p>2. The mark "- " means that this bandwidth is not supported.</p> <p>3. For E.R.P/E.I.R.P. measurement, the widest bandwidth of each band is chosen for testing due to highest conducted power. Besides, the lowest bandwidth of each band is also measured for reporting only.</p> <p>4. The device is investigated from 30MHz to 10 times of fundamental signal for radiated spurious emission test under different RB size/offset and modulations in exploratory test. Subsequently, only the worst case emissions are reported.</p>														

2.2 Connection Diagram of Test System

For 27(M)

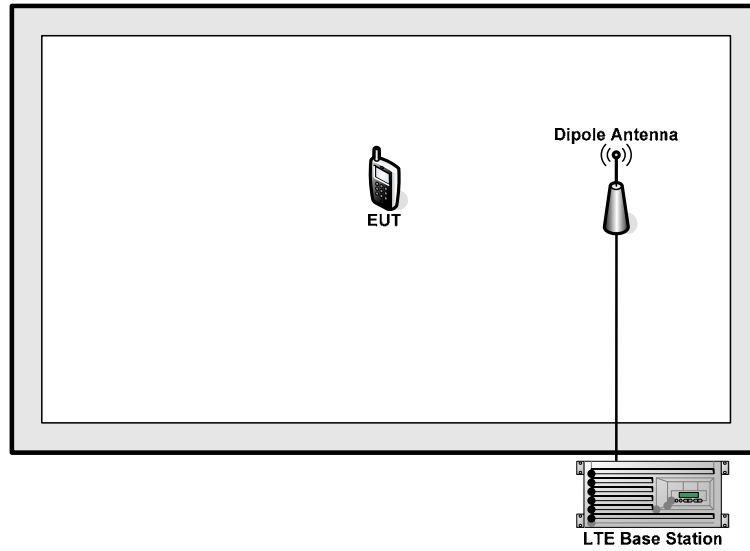

For 24(E)/27(L)

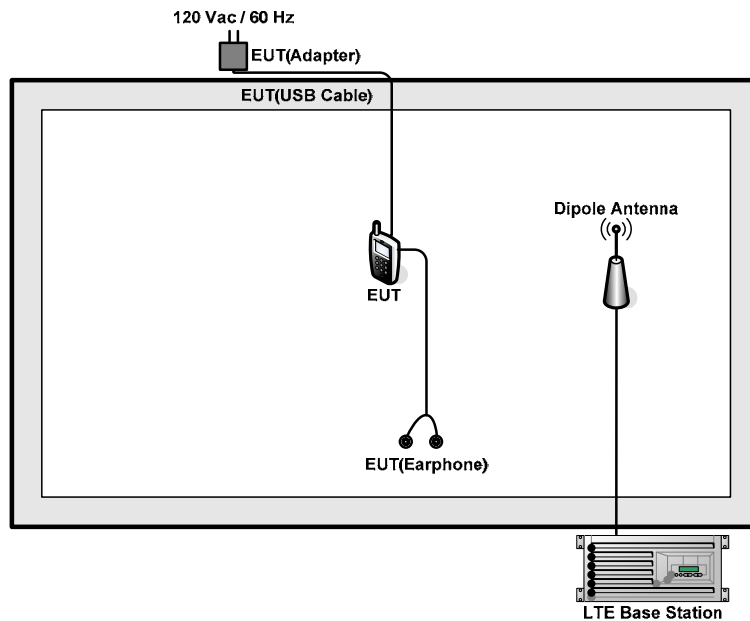



2.3 Support Unit used in test configuration and system

Item	Equipment	Trade Name	Model No.	FCC ID	Data Cable	Power Cord
1.	LTE Base Station	Anritsu	MT8820C	N/A	N/A	Unshielded, 1.8 m
2.	DC Power Supply	TOPWORD	3303DR	N/A	N/A	N/A

2.4 Measurement Results Explanation Example

For all conducted test items:

The offset level is set in the spectrum analyzer to compensate the RF cable loss and attenuator factor between EUT conducted output port and spectrum analyzer. With the offset compensation, the spectrum analyzer reading level is exactly the EUT RF output level.

The spectrum analyzer offset is derived from RF cable loss and attenuator factor.

Offset = RF cable loss + attenuator factor.

Following shows an offset computation example with cable loss 7.5 dB and 10dB attenuator.

Example :

$$\begin{aligned} \text{Offset(dB)} &= \text{RF cable loss(dB)} + \text{attenuator factor(dB)}. \\ &= 7.5 + 10 = 17.5 \text{ (dB)} \end{aligned}$$

3 Test Result

3.1 Conducted Output Power Measurement

3.1.1 Description of the Conducted Output Power Measurement

A system simulator was used to establish communication with the EUT. Its parameters were set to force the EUT transmitting at maximum output power. The measured power in the radio frequency on the transmitter output terminals shall be reported.

3.1.2 Measuring Instruments

The measuring equipment is listed in the section 4 of this test report.

3.1.3 Test Procedures

1. The transmitter output port was connected to the system simulator.
2. Set EUT at maximum power through the system simulator.
3. Select lowest, middle, and highest channels for each band and different modulation.
4. Measure and record the power level from the system simulator.

3.1.4 Test Setup

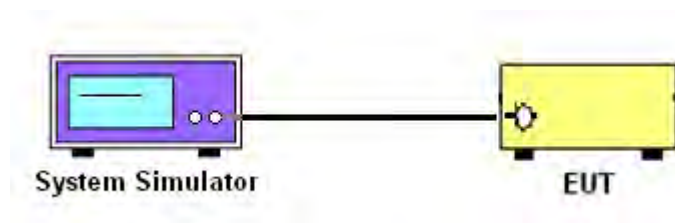



3.1.5 Test Result of Conducted Output Power

<LTE Band 7 Conducted Power>

BW [MHz]	Modulation	RB Size	RB Offset	Power (dBm) Low Ch. / Freq.	Power (dBm) Middle Ch. / Freq.	Power (dBm) High Ch. / Freq.
Channel				20850	21100	21350
Frequency (MHz)				2510	2535	2560
20	QPSK	1	0	21.80	21.56	21.30
20	QPSK	1	49	21.70	21.10	21.05
20	QPSK	1	99	21.68	21.02	21.24
20	QPSK	50	0	20.85	20.47	20.30
20	QPSK	50	24	20.80	20.30	20.19
20	QPSK	50	49	20.78	20.22	20.25
20	QPSK	100	0	20.74	20.34	20.17
20	16QAM	1	0	20.81	20.75	20.13
20	16QAM	1	49	21.02	20.34	20.36
20	16QAM	1	99	21.00	20.22	20.52
20	16QAM	50	0	19.77	19.45	19.05
20	16QAM	50	24	19.79	19.28	19.16
20	16QAM	50	49	19.80	19.18	19.23
20	16QAM	100	0	19.78	19.27	19.14
Channel				20825	21100	21375
Frequency (MHz)				2507.5	2535	2562.5
15	QPSK	1	0	21.59	21.46	21.00
15	QPSK	1	37	21.74	21.25	21.26
15	QPSK	1	74	21.73	21.15	21.34
15	QPSK	36	0	20.70	20.44	20.18
15	QPSK	36	18	20.73	20.32	20.24
15	QPSK	36	37	20.76	20.25	20.32
15	QPSK	75	0	20.74	20.33	20.24
15	16QAM	1	0	20.94	20.86	20.43
15	16QAM	1	37	21.13	20.27	20.61
15	16QAM	1	74	21.19	20.46	20.70
15	16QAM	36	0	19.75	19.42	19.08
15	16QAM	36	18	19.80	19.33	19.18
15	16QAM	36	37	19.84	19.19	19.31
15	16QAM	75	0	19.79	19.28	19.17



BW [MHz]	Modulation	RB Size	RB Offset	Power (dBm) Low Ch. / Freq.	Power (dBm) Middle Ch. / Freq.	Power (dBm) High Ch. / Freq.
Channel				20800	21100	21400
Frequency (MHz)				2505	2535	2565
10	QPSK	1	0	21.45	21.28	21.03
10	QPSK	1	24	21.52	21.19	21.11
10	QPSK	1	49	21.58	21.09	21.16
10	QPSK	25	0	20.63	20.33	20.15
10	QPSK	25	12	20.68	20.28	20.18
10	QPSK	25	24	20.71	20.24	20.17
10	QPSK	50	0	20.67	20.33	20.20
10	16QAM	1	0	20.53	20.34	20.11
10	16QAM	1	24	20.65	20.21	20.15
10	16QAM	1	49	20.76	20.07	20.22
10	16QAM	25	0	19.58	19.28	19.07
10	16QAM	25	12	19.68	19.13	19.13
10	16QAM	25	24	19.63	19.17	19.14
10	16QAM	50	0	19.62	19.25	19.12
Channel				20775	21100	21425
Frequency (MHz)				2502.5	2535	2567.5
5	QPSK	1	0	21.50	21.30	21.17
5	QPSK	1	12	21.52	21.18	21.25
5	QPSK	1	24	21.62	21.18	21.26
5	QPSK	12	0	20.61	20.35	20.22
5	QPSK	12	6	20.71	20.30	20.25
5	QPSK	12	11	20.68	20.27	20.24
5	QPSK	25	0	20.58	20.27	20.21
5	16QAM	1	0	20.52	20.35	20.23
5	16QAM	1	12	20.58	20.32	20.36
5	16QAM	1	24	20.60	20.17	20.29
5	16QAM	12	0	19.64	19.30	19.22
5	16QAM	12	6	19.60	19.25	19.25
5	16QAM	12	11	19.73	19.22	19.22
5	16QAM	25	0	19.64	19.25	19.23



<LTE Band 2 Conducted Power>

BW [MHz]	Modulation	RB Size	RB Offset	Power (dBm) Low Ch. / Freq.	Power (dBm) Middle Ch. / Freq.	Power (dBm) High Ch. / Freq.
Channel				18700	18900	19100
Frequency (MHz)				1860	1880	1900
20	QPSK	1	0	22.47	22.20	21.46
20	QPSK	1	49	22.22	21.94	21.36
20	QPSK	1	99	21.97	21.80	21.26
20	QPSK	50	0	21.51	21.13	20.54
20	QPSK	50	24	21.38	20.98	20.43
20	QPSK	50	49	21.27	20.80	20.37
20	QPSK	100	0	21.40	20.96	20.41
20	16QAM	1	0	21.73	21.70	21.10
20	16QAM	1	49	21.49	21.50	20.87
20	16QAM	1	99	21.29	21.14	20.74
20	16QAM	50	0	20.57	20.20	19.60
20	16QAM	50	24	20.43	20.03	19.48
20	16QAM	50	49	20.33	19.86	19.42
20	16QAM	100	0	20.44	19.97	19.41
Channel				18675	18900	19125
Frequency (MHz)				1857.5	1880	1902.5
15	QPSK	1	0	22.47	22.11	21.39
15	QPSK	1	37	22.36	21.98	21.28
15	QPSK	1	74	22.19	21.63	21.24
15	QPSK	36	0	21.55	21.10	20.41
15	QPSK	36	18	21.51	21.00	20.40
15	QPSK	36	37	21.38	20.87	20.38
15	QPSK	75	0	21.46	20.98	20.40
15	16QAM	1	0	21.70	21.38	20.66
15	16QAM	1	37	21.56	21.22	20.52
15	16QAM	1	74	21.44	21.17	20.46
15	16QAM	36	0	20.62	20.14	19.40
15	16QAM	36	18	20.51	20.01	19.42
15	16QAM	36	37	20.38	19.92	19.37
15	16QAM	75	0	20.50	20.04	19.45



BW [MHz]	Modulation	RB Size	RB Offset	Power (dBm) Low Ch. / Freq.	Power (dBm) Middle Ch. / Freq.	Power (dBm) High Ch. / Freq.
Channel				18650	18900	19150
Frequency (MHz)				1855	1880	1905
10	QPSK	1	0	22.47	21.98	21.28
10	QPSK	1	24	22.49	21.92	21.22
10	QPSK	1	49	22.28	21.73	21.23
10	QPSK	25	0	21.53	21.03	20.34
10	QPSK	25	12	21.48	20.98	20.32
10	QPSK	25	24	21.46	20.91	20.27
10	QPSK	50	0	21.57	20.95	20.36
10	16QAM	1	0	21.43	20.99	20.23
10	16QAM	1	24	21.36	20.97	20.20
10	16QAM	1	49	21.24	20.72	20.10
10	16QAM	25	0	20.55	19.99	19.40
10	16QAM	25	12	20.44	19.99	19.37
10	16QAM	25	24	20.47	19.95	19.35
10	16QAM	50	0	20.59	20.02	19.42
Channel				18625	18900	19175
Frequency (MHz)				1852.5	1880	1907.5
5	QPSK	1	0	22.49	21.93	21.24
5	QPSK	1	12	22.47	21.90	21.14
5	QPSK	1	24	22.44	21.79	21.20
5	QPSK	12	0	21.55	21.09	20.35
5	QPSK	12	6	21.55	21.03	20.33
5	QPSK	12	11	21.54	21.01	20.29
5	QPSK	25	0	21.53	20.96	20.27
5	16QAM	1	0	21.97	21.04	20.43
5	16QAM	1	12	21.84	20.89	20.17
5	16QAM	1	24	21.80	20.88	20.08
5	16QAM	12	0	20.57	20.15	19.40
5	16QAM	12	6	20.57	20.09	19.33
5	16QAM	12	11	20.55	20.03	19.34
5	16QAM	25	0	20.50	19.97	19.29



BW [MHz]	Modulation	RB Size	RB Offset	Power (dBm) Low Ch. / Freq.	Power (dBm) Middle Ch. / Freq.	Power (dBm) High Ch. / Freq.
Channel				18615	18900	19185
Frequency (MHz)				1851.5	1880	1908.5
3	QPSK	1	0	22.39	21.87	21.16
3	QPSK	1	7	22.44	21.91	21.21
3	QPSK	1	14	22.39	21.78	21.17
3	QPSK	8	0	21.58	21.02	20.25
3	QPSK	8	4	21.56	20.98	20.27
3	QPSK	8	7	21.55	20.99	20.27
3	QPSK	15	0	21.59	20.94	20.28
3	16QAM	1	0	21.89	21.32	20.53
3	16QAM	1	7	21.90	21.37	20.55
3	16QAM	1	14	21.84	21.23	20.43
3	16QAM	8	0	20.69	20.11	19.37
3	16QAM	8	4	20.75	20.06	19.35
3	16QAM	8	7	20.61	20.09	19.33
3	16QAM	15	0	20.47	19.89	19.20
Channel				18607	18900	19193
Frequency (MHz)				1850.7	1880	1909.3
1.4	QPSK	1	0	22.38	21.85	21.12
1.4	QPSK	1	2	22.55	21.99	21.30
1.4	QPSK	1	5	22.35	21.82	21.07
1.4	QPSK	3	0	22.53	21.97	21.17
1.4	QPSK	3	1	22.49	21.94	21.12
1.4	QPSK	3	2	22.49	21.91	21.26
1.4	QPSK	6	0	21.58	21.01	20.32
1.4	16QAM	1	0	21.44	20.95	20.07
1.4	16QAM	1	2	21.67	21.05	20.30
1.4	16QAM	1	5	21.55	21.03	20.05
1.4	16QAM	3	0	21.44	20.92	20.25
1.4	16QAM	3	1	21.39	20.83	20.20
1.4	16QAM	3	2	21.36	20.82	20.21
1.4	16QAM	6	0	20.63	20.01	19.22



<LTE Band 4 Conducted Power>

BW [MHz]	Modulation	RB Size	RB Offset	Power (dBm) Low Ch. / Freq.	Power (dBm) Middle Ch. / Freq.	Power (dBm) High Ch. / Freq.
Channel				20050	20175	20300
Frequency (MHz)				1720	1732.5	1745
20	QPSK	1	0	22.17	21.82	21.75
20	QPSK	1	49	21.82	21.43	21.52
20	QPSK	1	99	21.70	21.42	21.70
20	QPSK	50	0	21.05	20.65	20.70
20	QPSK	50	24	20.86	20.46	20.60
20	QPSK	50	49	20.63	20.43	20.67
20	QPSK	100	0	20.83	20.53	20.62
20	16QAM	1	0	21.59	21.31	21.03
20	16QAM	1	49	21.27	20.89	21.08
20	16QAM	1	99	20.93	20.60	21.24
20	16QAM	50	0	20.07	19.70	19.60
20	16QAM	50	24	19.88	19.53	19.64
20	16QAM	50	49	19.67	19.47	19.71
20	16QAM	100	0	19.88	19.59	19.66
Channel				20025	20175	20325
Frequency (MHz)				1717.5	1732.5	1747.5
15	QPSK	1	0	22.00	21.62	21.47
15	QPSK	1	37	21.80	21.37	21.56
15	QPSK	1	74	21.51	21.33	21.68
15	QPSK	36	0	21.07	20.58	20.61
15	QPSK	36	18	20.94	20.49	20.65
15	QPSK	36	37	20.81	20.41	20.69
15	QPSK	75	0	20.93	20.49	20.63
15	16QAM	1	0	21.49	21.17	21.08
15	16QAM	1	37	21.32	20.86	21.19
15	16QAM	1	74	21.09	20.86	21.26
15	16QAM	36	0	20.07	19.59	19.69
15	16QAM	36	18	19.94	19.53	19.74
15	16QAM	36	37	19.82	19.44	19.76
15	16QAM	75	0	19.96	19.55	19.70



BW [MHz]	Modulation	RB Size	RB Offset	Power (dBm) Low Ch. / Freq.	Power (dBm) Middle Ch. / Freq.	Power (dBm) High Ch. / Freq.
Channel				20000	20175	20350
Frequency (MHz)				1715	1732.5	1750
10	QPSK	1	0	21.94	21.46	21.43
10	QPSK	1	24	21.81	21.42	21.65
10	QPSK	1	49	21.70	21.35	21.72
10	QPSK	25	0	21.01	20.49	20.59
10	QPSK	25	12	20.99	20.43	20.65
10	QPSK	25	24	20.88	20.40	20.68
10	QPSK	50	0	20.98	20.46	20.68
10	16QAM	1	0	21.25	21.13	21.12
10	16QAM	1	24	21.10	21.00	21.24
10	16QAM	1	49	20.96	20.89	21.22
10	16QAM	25	0	20.09	19.54	19.71
10	16QAM	25	12	20.04	19.47	19.73
10	16QAM	25	24	19.97	19.46	19.74
10	16QAM	50	0	20.03	19.52	19.77
Channel				19975	20175	20375
Frequency (MHz)				1712.5	1732.5	1752.5
5	QPSK	1	0	21.96	21.45	21.61
5	QPSK	1	12	21.95	21.37	21.69
5	QPSK	1	24	21.91	21.42	21.64
5	QPSK	12	0	21.09	20.52	20.73
5	QPSK	12	6	21.08	20.45	20.72
5	QPSK	12	11	21.03	20.47	20.74
5	QPSK	25	0	21.00	20.42	20.66
5	16QAM	1	0	21.47	20.95	21.12
5	16QAM	1	12	21.43	20.88	21.17
5	16QAM	1	24	20.82	20.86	21.11
5	16QAM	12	0	20.16	19.57	19.78
5	16QAM	12	6	20.12	19.52	19.75
5	16QAM	12	11	20.12	19.51	19.73
5	16QAM	25	0	20.11	19.36	19.65



BW [MHz]	Modulation	RB Size	RB Offset	Power (dBm) Low Ch. / Freq.	Power (dBm) Middle Ch. / Freq.	Power (dBm) High Ch. / Freq.
Channel				19965	20175	20385
Frequency (MHz)				1711.5	1732.5	1753.5
3	QPSK	1	0	21.97	21.33	21.63
3	QPSK	1	7	21.90	21.38	21.62
3	QPSK	1	14	21.87	21.29	21.58
3	QPSK	8	0	21.06	20.46	20.71
3	QPSK	8	4	21.05	20.43	20.70
3	QPSK	8	7	21.05	20.42	20.70
3	QPSK	15	0	21.05	20.40	20.66
3	16QAM	1	0	21.39	20.81	21.00
3	16QAM	1	7	21.37	20.84	21.06
3	16QAM	1	14	21.23	20.72	20.98
3	16QAM	8	0	20.18	19.56	19.79
3	16QAM	8	4	20.19	19.52	19.81
3	16QAM	8	7	20.14	19.52	19.81
3	16QAM	15	0	20.07	19.32	19.66
Channel				19957	20175	20393
Frequency (MHz)				1710.7	1732.5	1754.3
1.4	QPSK	1	0	21.87	21.25	21.53
1.4	QPSK	1	2	22.05	21.45	21.75
1.4	QPSK	1	5	21.89	21.28	21.57
1.4	QPSK	3	0	22.03	21.42	21.72
1.4	QPSK	3	1	22.00	21.40	21.70
1.4	QPSK	3	2	21.97	21.39	21.67
1.4	QPSK	6	0	21.05	20.40	20.70
1.4	16QAM	1	0	21.06	20.51	20.76
1.4	16QAM	1	2	21.15	20.59	20.64
1.4	16QAM	1	5	21.06	20.50	21.11
1.4	16QAM	3	0	21.11	20.53	20.82
1.4	16QAM	3	1	21.07	20.48	20.71
1.4	16QAM	3	2	21.04	20.46	20.73
1.4	16QAM	6	0	20.09	19.49	19.80

Note: maximum average power for LTE.

3.2 Peak-to-Average Ratio

3.2.1 Description of the PAR Measurement

Power Complementary Cumulative Distribution Function (CCDF) curves provide a means for characterizing the power peaks of a digitally modulated signal on a statistical basis. A CCDF curve depicts the probability of the peak signal amplitude exceeding the average power level. Most contemporary measurement instrumentation include the capability to produce CCDF curves for an input signal provided that the instrument's resolution bandwidth can be set wide enough to accommodate the entire input signal bandwidth. In measuring transmissions in this band using an average power technique, the peak-to-average ratio (PAR) of the transmission may not exceed 13 dB.

3.2.2 Measuring Instruments

The measuring equipment is listed in the section 4 of this test report.

3.2.3 Test Procedures

1. The EUT was connected to spectrum and system simulator via a power divider.
2. Set the CCDF (Complementary Cumulative Distribution Function) option in spectrum analyzer.
3. The highest RF powers were measured and recorded the maximum PAPR level associated with a probability of 0.1 %.
4. Record the deviation as Peak to Average Ratio.

3.2.4 Test Setup

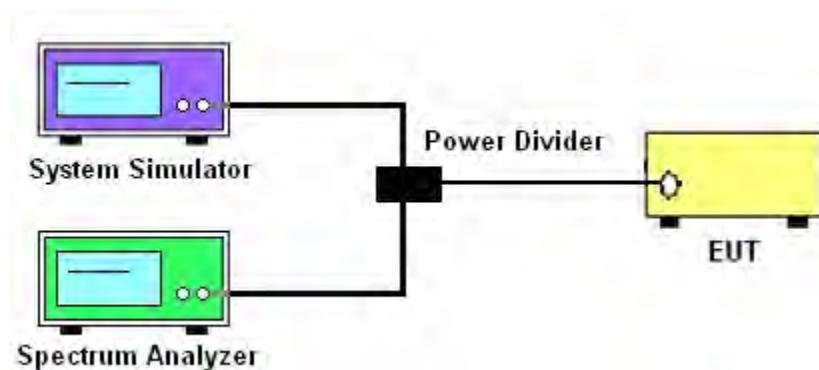



3.2.5 Test Result of Peak-to-Average Ratio

LTE Band 2						
BW [MHz]	Modulation	RB Size	RB Offset	Power (dBm) Low Ch. / Freq.	Power (dBm) Middle Ch. / Freq.	Power (dBm) High Ch. / Freq.
Channel				18700	18900	19100
Frequency (MHz)				1860	1880	1900
20	QPSK	1	0	4.17	4.03	4.49
20	QPSK	100	0	4.93	5.10	5.19
20	16QAM	1	0	5.91	5.36	5.16
20	16QAM	100	0	5.97	6.14	6.12

LTE Band 4						
BW [MHz]	Modulation	RB Size	RB Offset	Power (dBm) Low Ch. / Freq.	Power (dBm) Middle Ch. / Freq.	Power (dBm) High Ch. / Freq.
Channel				20050	20175	20300
Frequency (MHz)				1720	1732.5	1745
20	QPSK	1	0	4.67	4.20	5.19
20	QPSK	100	0	5.36	5.45	5.42
20	16QAM	1	0	5.25	5.57	5.39
20	16QAM	100	0	6.12	6.29	6.41

LTE Band 7						
BW [MHz]	Modulation	RB Size	RB Offset	Power (dBm) Low Ch. / Freq.	Power (dBm) Middle Ch. / Freq.	Power (dBm) High Ch. / Freq.
Channel				20850	21100	21350
Frequency (MHz)				2510	2535	2560
20	QPSK	1	0	3.97	4.43	4.23
20	QPSK	100	0	5.22	5.25	5.16
20	16QAM	1	0	4.46	4.99	4.70
20	16QAM	100	0	6.06	6.03	6.03



3.2.6 Peak to Average Power Ratio

Peak-to-Average Ratio on LTE Band 2
20MHz / QPSK in Ch. 18700 (1RB Size)

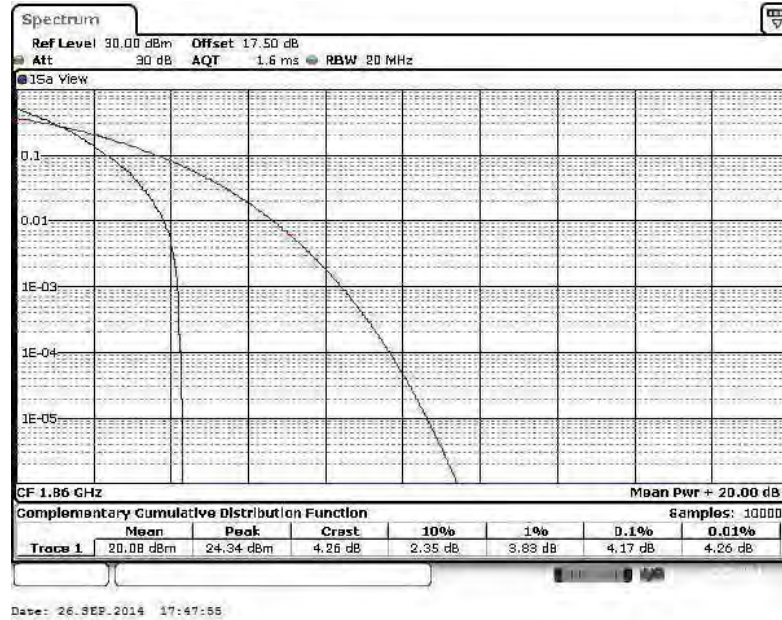

Peak-to-Average Ratio on LTE Band 2
20MHz / QPSK in Ch. 18900 (1RB Size)

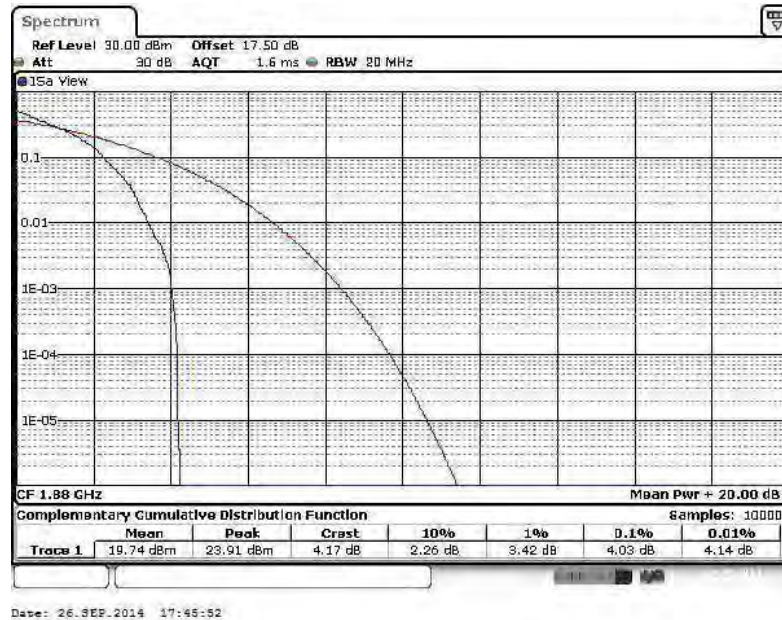



Peak-to-Average Ratio on LTE Band 2
20MHz / QPSK in Ch. 19100 (1RB Size)

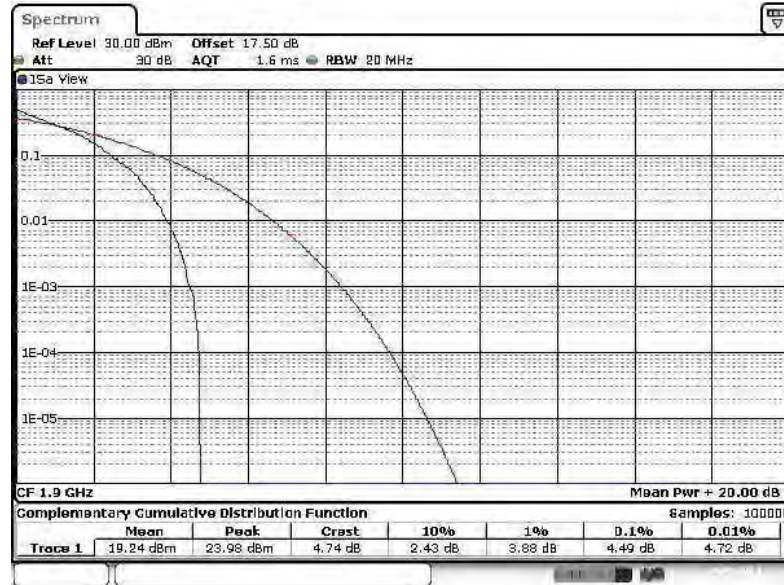

Date: 26.SEP.2014 17:46:23

Peak-to-Average Ratio on LTE Band 2
20MHz / QPSK in Ch. 18700 (100RB Size)

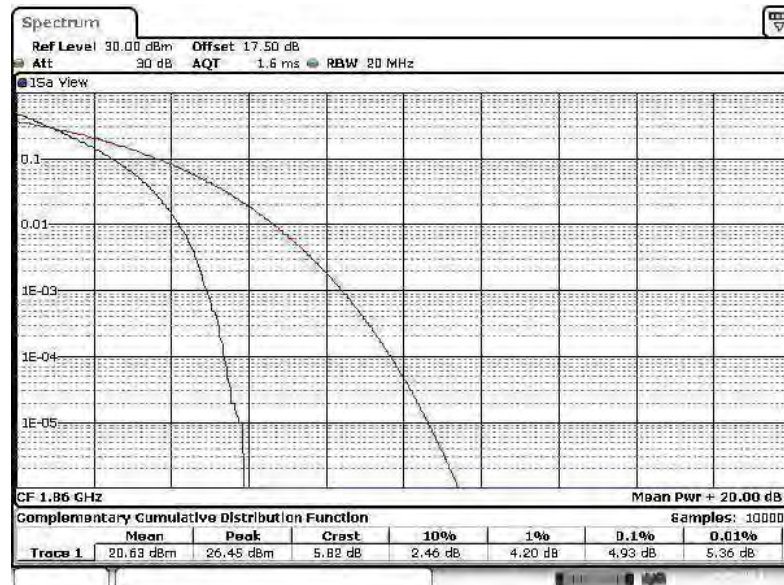

Date: 26.SEP.2014 17:47:27



Peak-to-Average Ratio on LTE Band 2
20MHz / QPSK in Ch. 18900 (100RB Size)

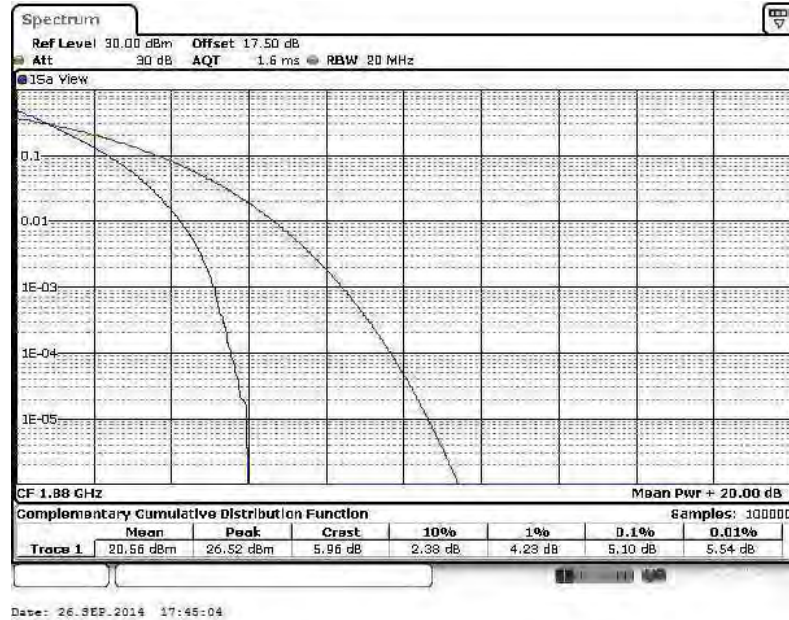

Peak-to-Average Ratio on LTE Band 2
20MHz / QPSK in Ch. 19100 (100RB Size)

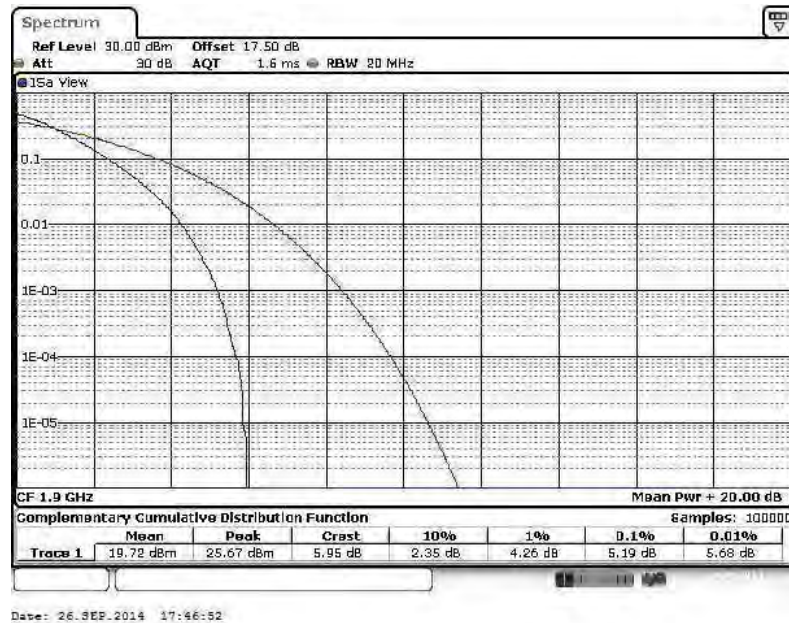



Peak-to-Average Ratio on LTE Band 2
20MHz / 16QAM in Ch. 18700 (1RB Size)

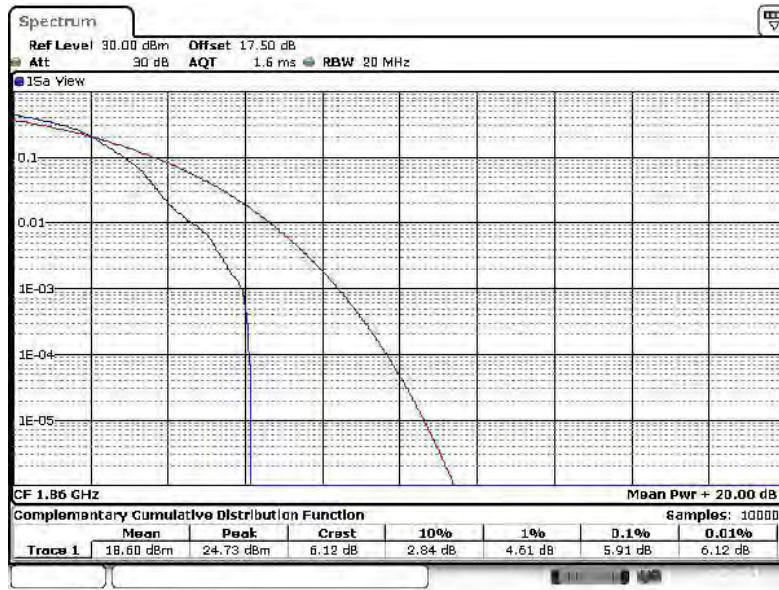

Date: 25.SEP.2014 21:16:37

Peak-to-Average Ratio on LTE Band 2
20MHz / 16QAM in Ch. 18900 (1RB Size)

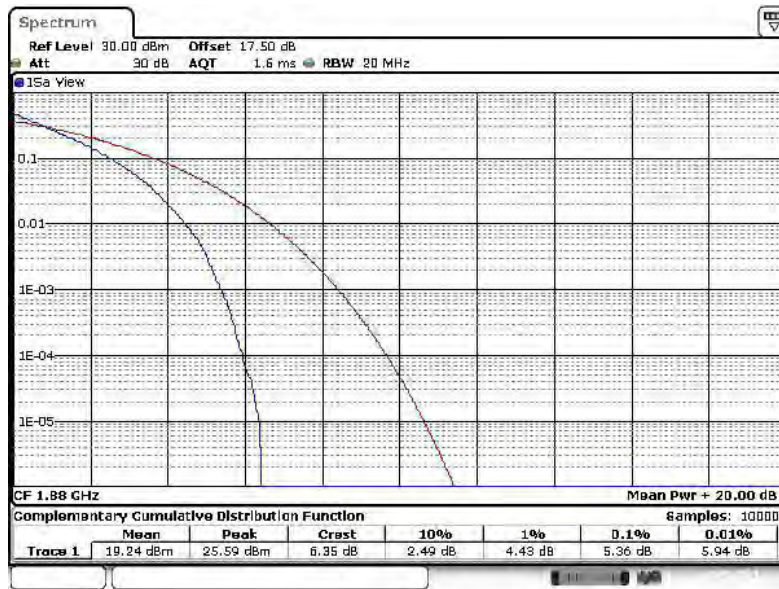

Date: 25.SEP.2014 21:18:25



Peak-to-Average Ratio on LTE Band 2
20MHz / 16QAM in Ch. 19100 (1RB Size)

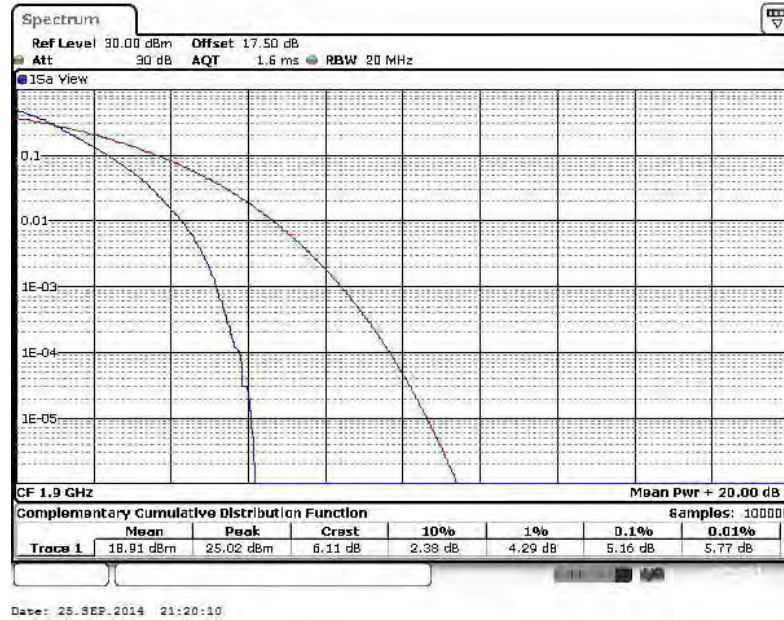

Peak-to-Average Ratio on LTE Band 2
20MHz / 16QAM in Ch. 18700 (100RB Size)

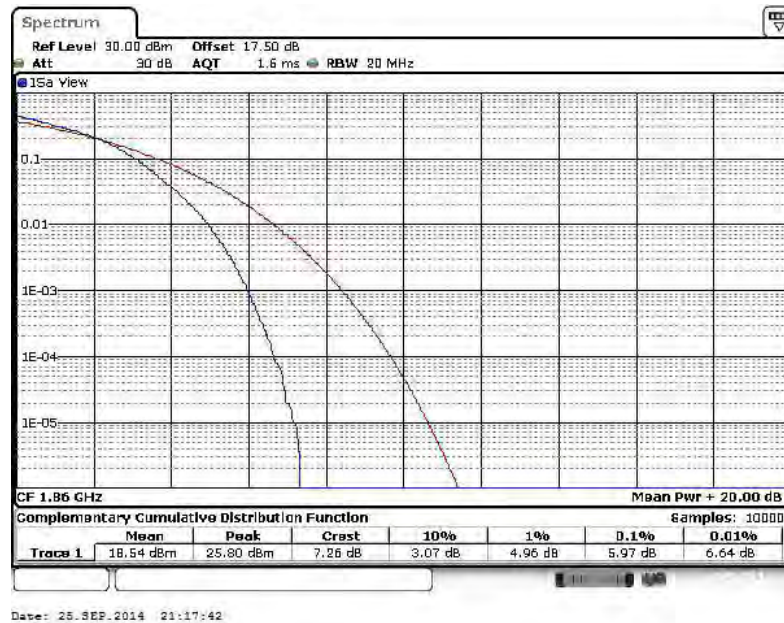



Peak-to-Average Ratio on LTE Band 2
20MHz / 16QAM in Ch. 18900 (100RB Size)

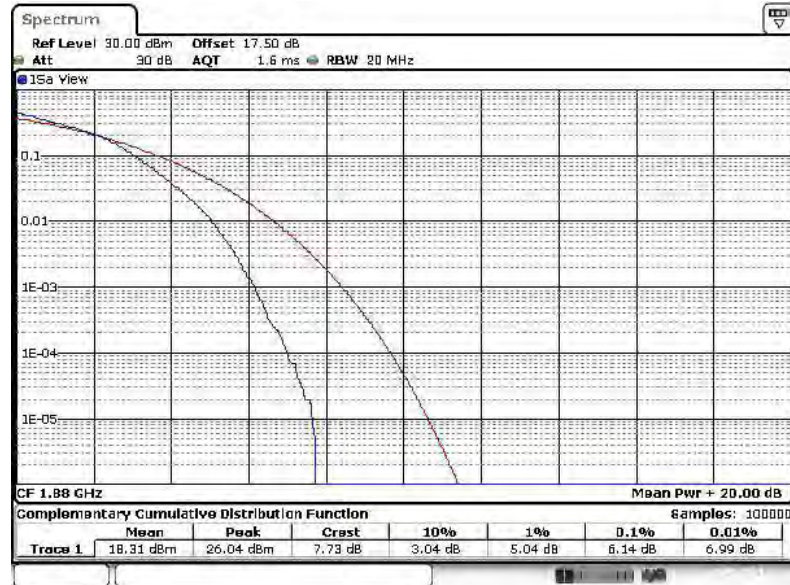

Date: 25.SEP.2014 21:19:15

Peak-to-Average Ratio on LTE Band 2
20MHz / 16QAM in Ch. 19100 (100RB Size)

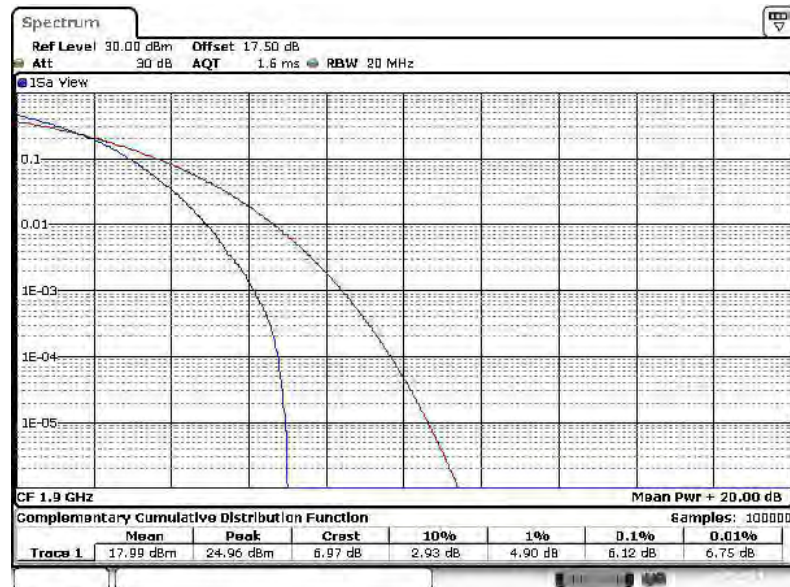

Date: 25.SEP.2014 21:23:50



Peak-to-Average Ratio on LTE Band 4
20MHz / QPSK in Ch. 20050 (1RB Size)

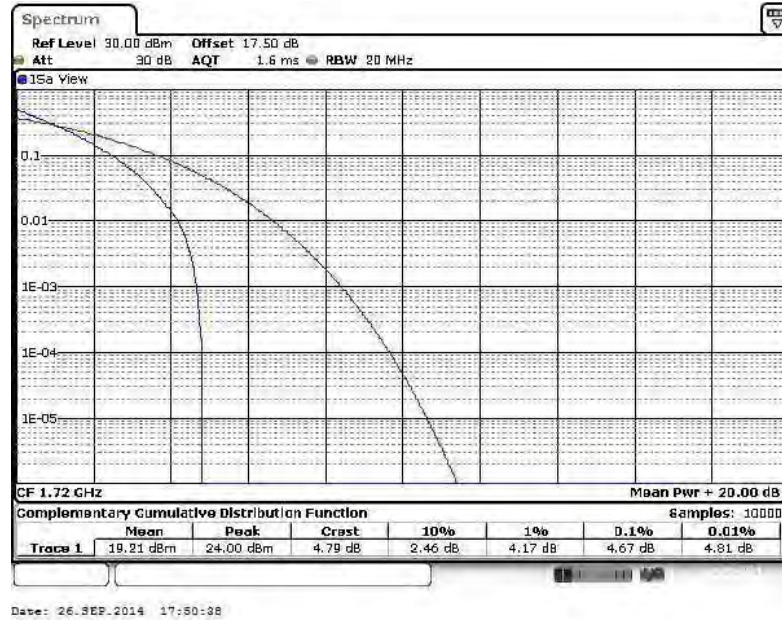

Peak-to-Average Ratio on LTE Band 4
20MHz / QPSK in Ch. 20175 (1RB Size)

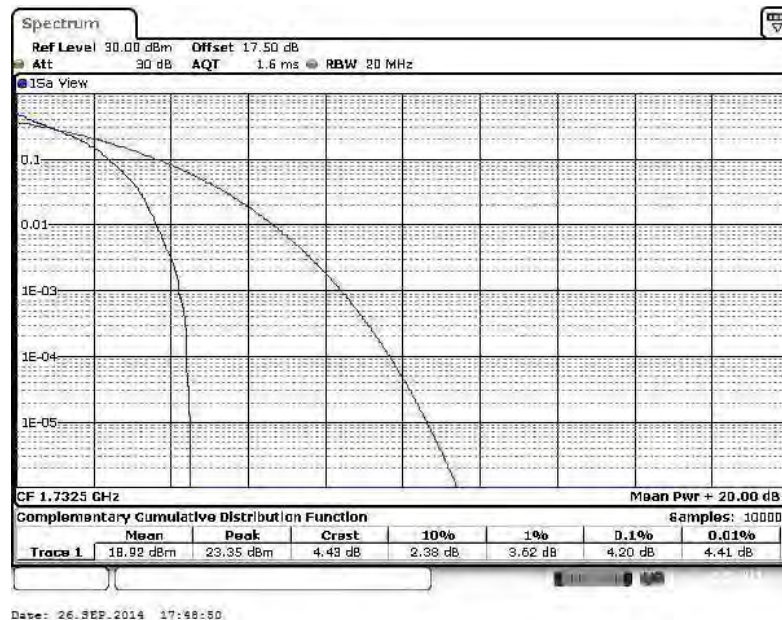



Peak-to-Average Ratio on LTE Band 4
20MHz / QPSK in Ch. 20300 (1RB Size)

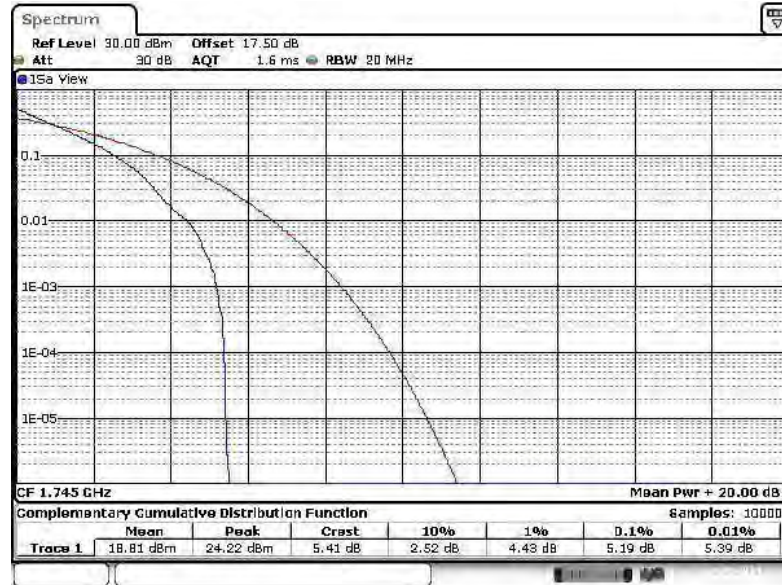

Date: 26.SEP.2014 17:50:07

Peak-to-Average Ratio on LTE Band 4
20MHz / QPSK in Ch. 20500 (100RB Size)

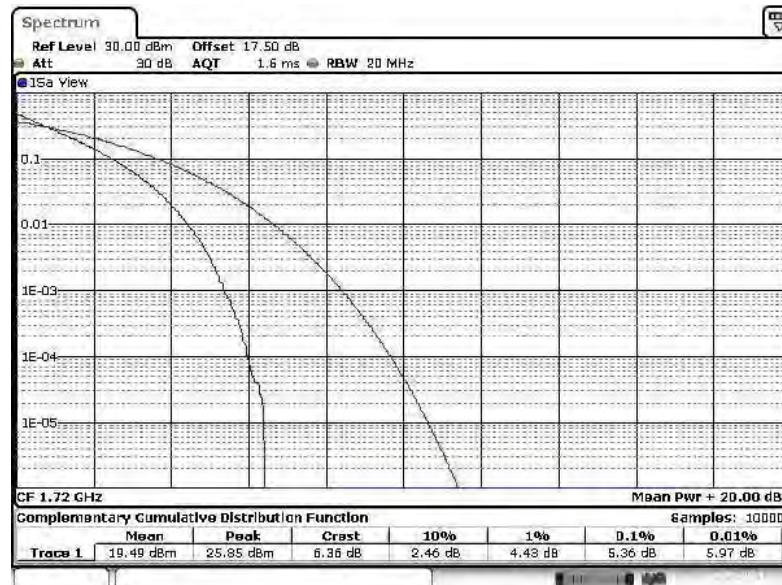

Date: 26.SEP.2014 17:51:13



Peak-to-Average Ratio on LTE Band 4
20MHz / QPSK in Ch. 20175 (100RB Size)

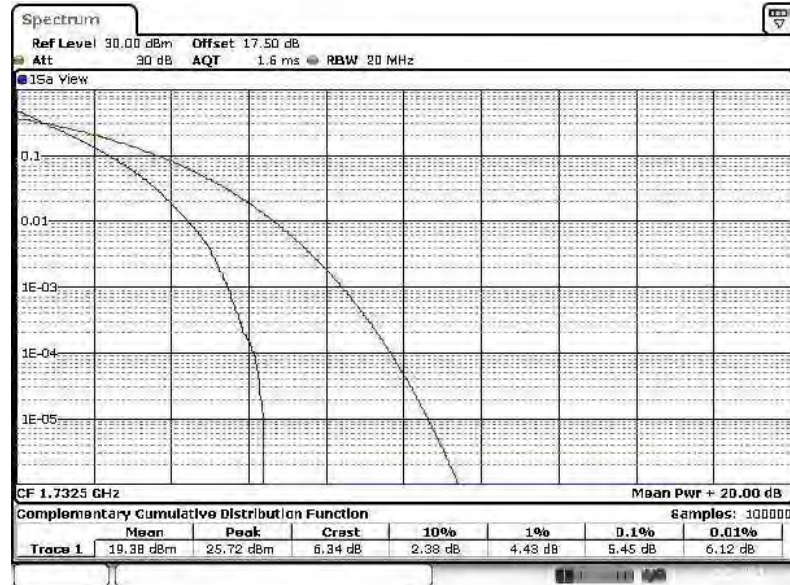

Date: 26.SEP.2014 17:49:17

Peak-to-Average Ratio on LTE Band 4
20MHz / QPSK in Ch. 20300 (100RB Size)

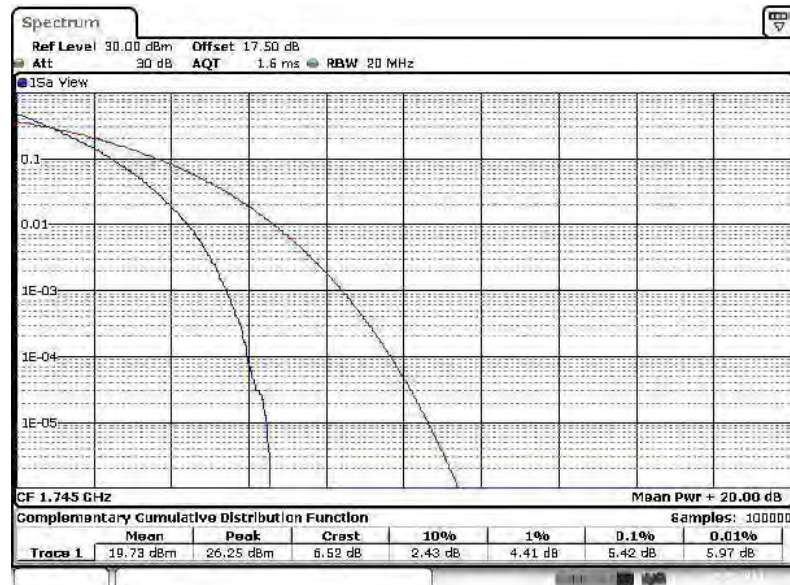

Date: 26.SEP.2014 17:49:42



Peak-to-Average Ratio on LTE Band 4
20MHz / 16QAM in Ch. 20050 (1RB Size)

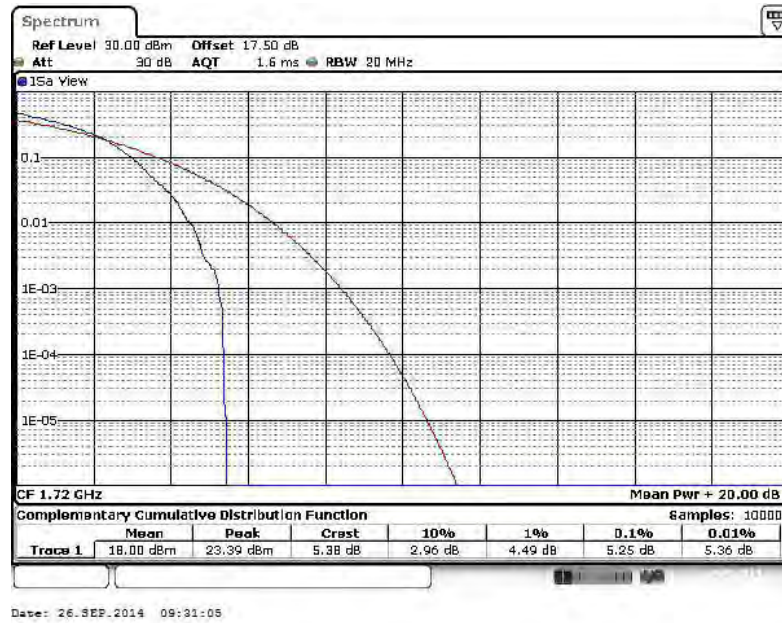

Peak-to-Average Ratio on LTE Band 4
20MHz / 16QAM in Ch. 20175 (1RB Size)

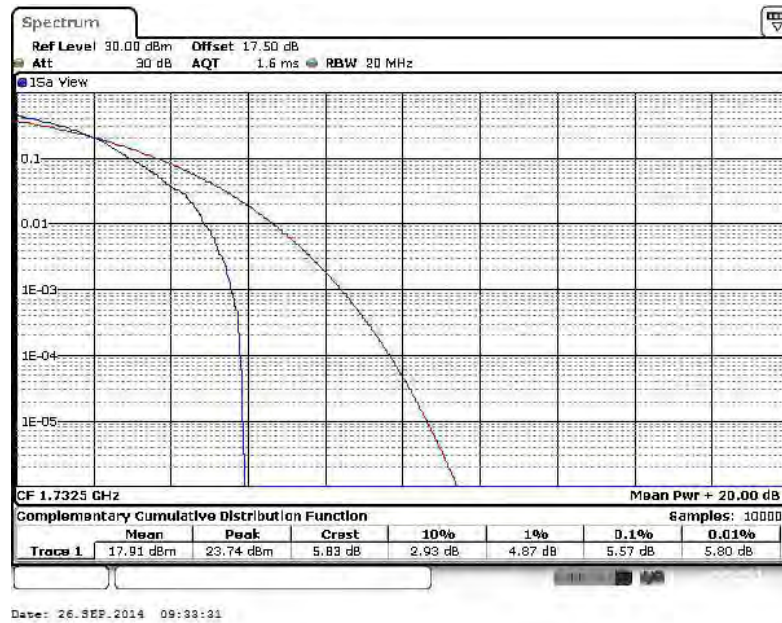



Peak-to-Average Ratio on LTE Band 4
20MHz / 16QAM in Ch. 20300 (1RB Size)

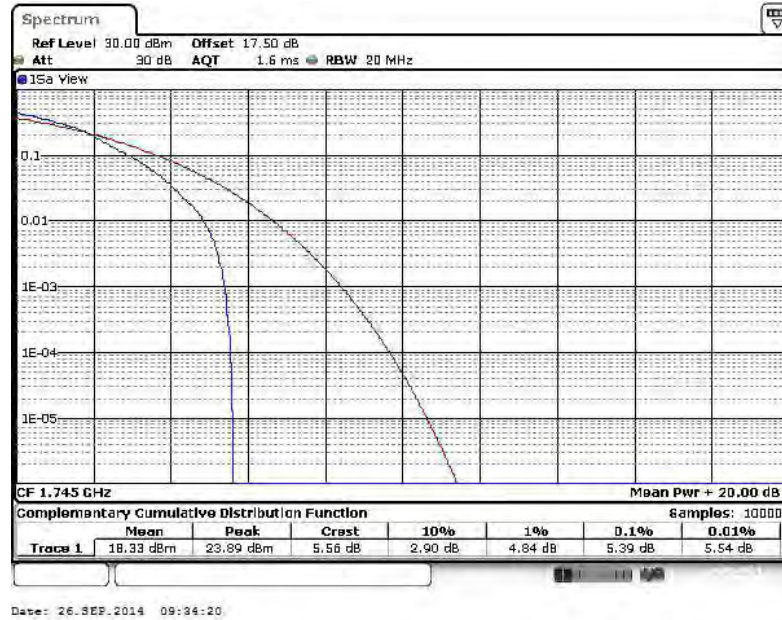

Peak-to-Average Ratio on LTE Band 4
20MHz / 16QAM in Ch. 20500 (100RB Size)

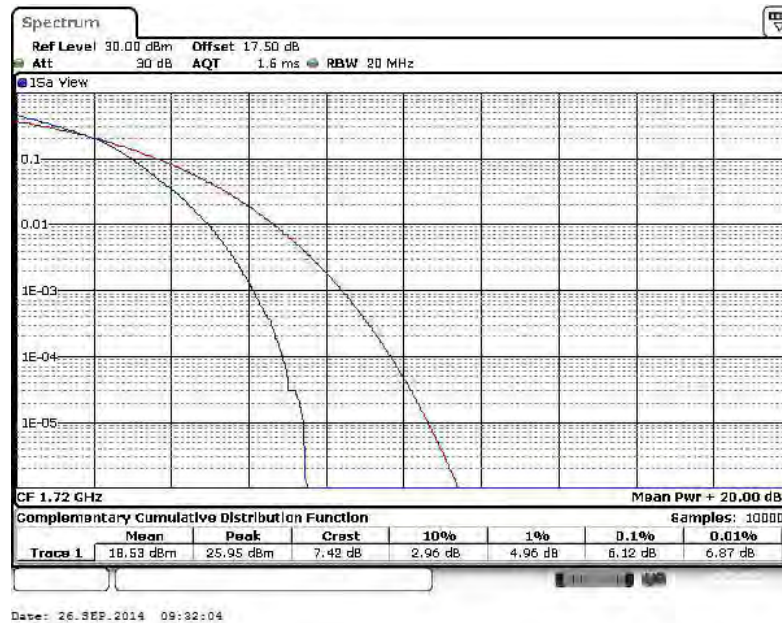



Peak-to-Average Ratio on LTE Band 4
20MHz / 16QAM in Ch. 201750 (100RB Size)

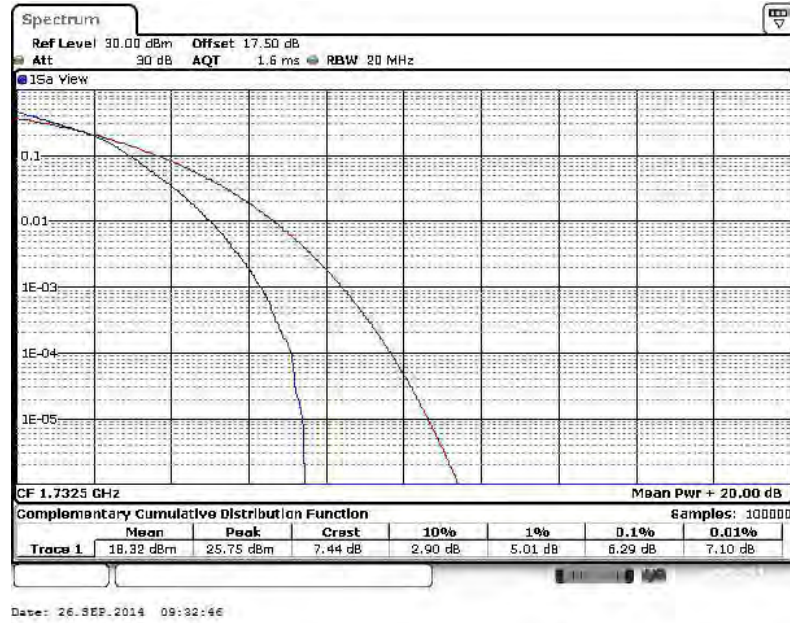

Peak-to-Average Ratio on LTE Band 4
20MHz / 16QAM in Ch. 20300 (100RB Size)

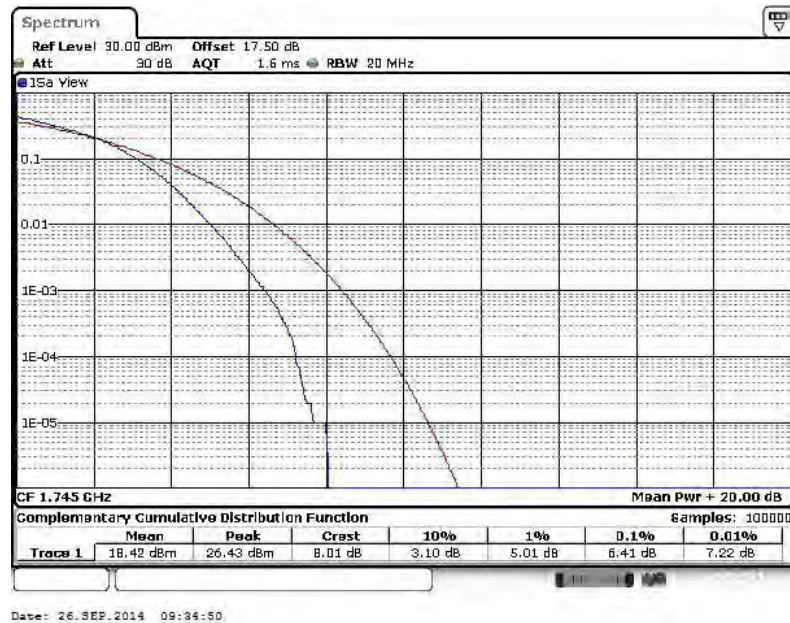



Peak-to-Average Ratio on LTE Band 7
20MHz / QPSK in Ch. 20850 (1RB Size)

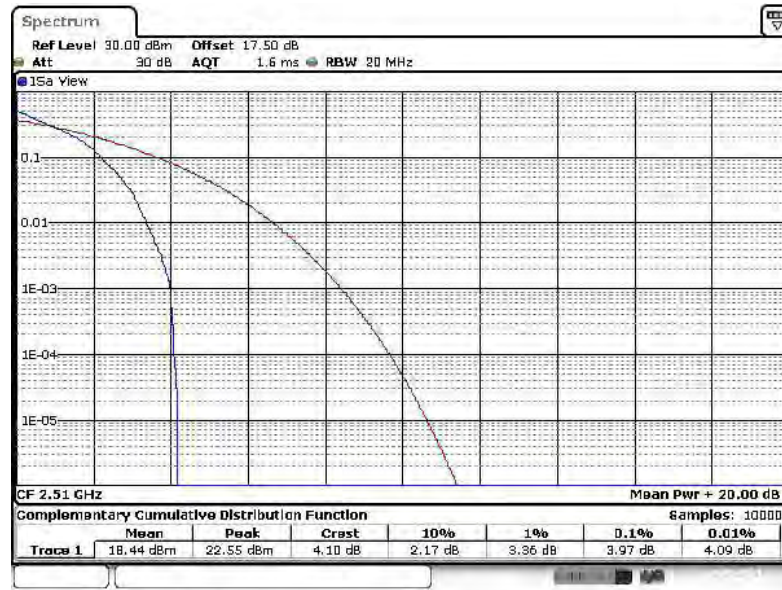

Date: 26.SEP.2014 17:54:28

Peak-to-Average Ratio on LTE Band 7
20MHz / QPSK in Ch. 21100 (1RB Size)

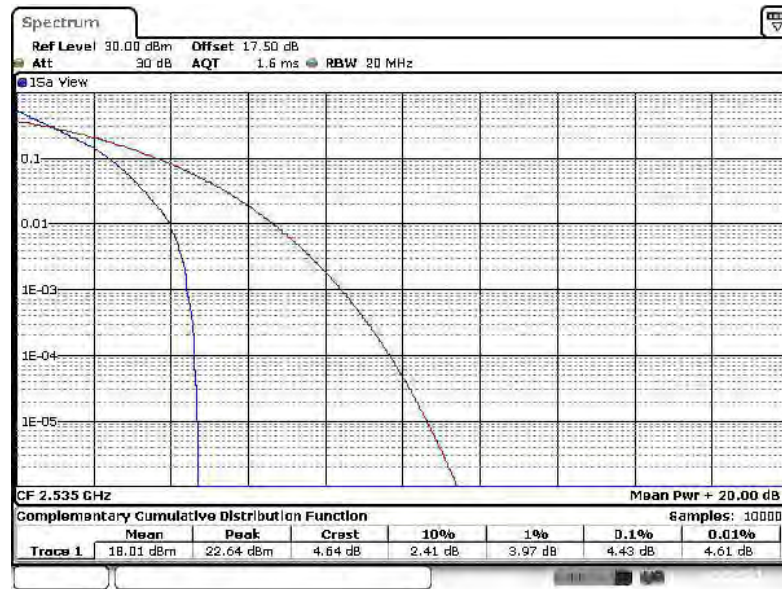

Date: 26.SEP.2014 17:52:38



Peak-to-Average Ratio on LTE Band 7
20MHz / QPSK in Ch. 21350 (1RB Size)

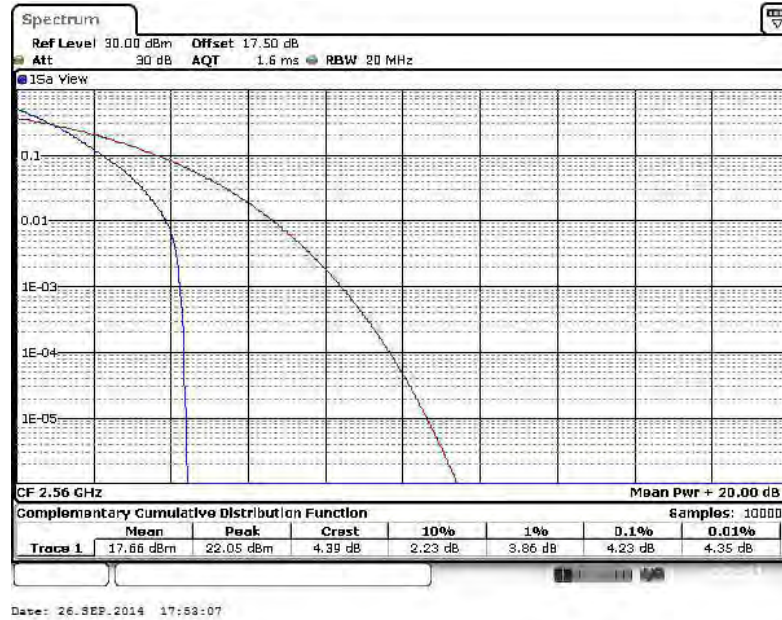

Peak-to-Average Ratio on LTE Band 7
20MHz / QPSK in Ch. 20850 (100RB Size)

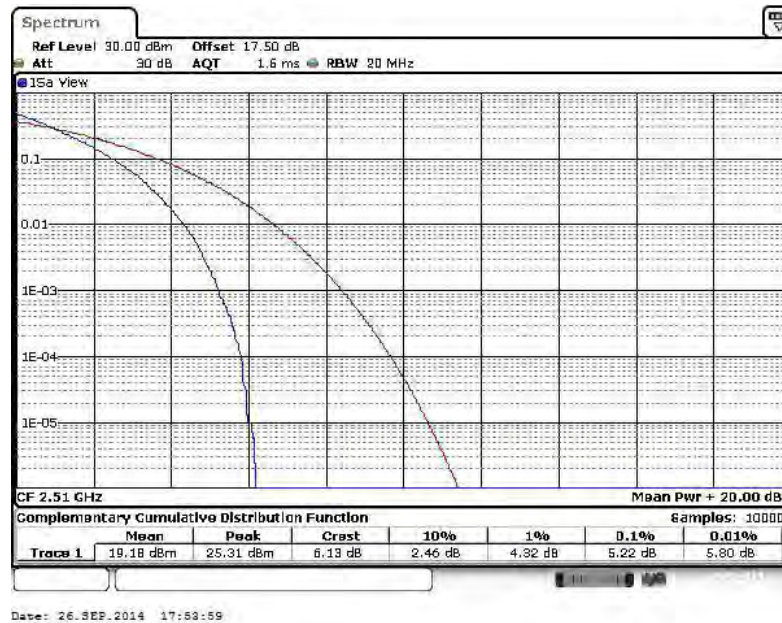



Peak-to-Average Ratio on LTE Band 7
20MHz / QPSK in Ch. 21100 (100RB Size)

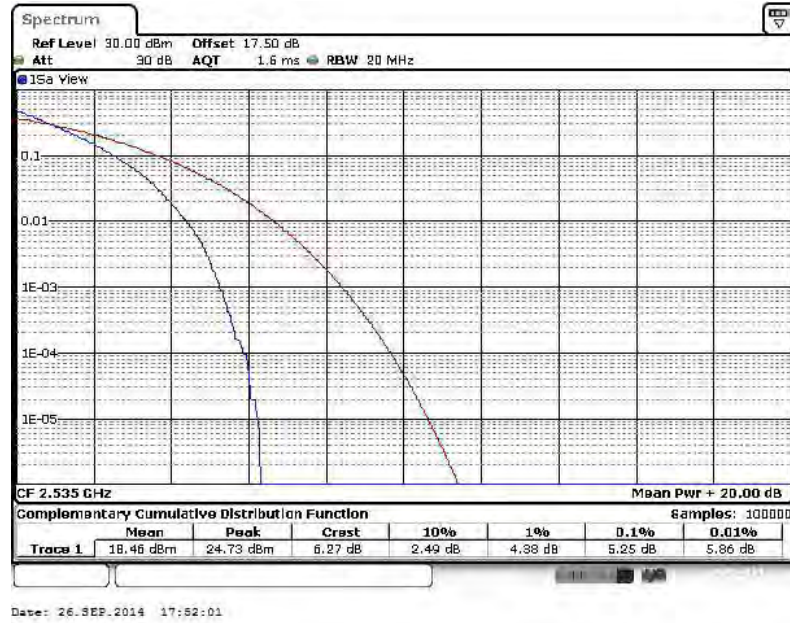

Peak-to-Average Ratio on LTE Band 7
20MHz / QPSK in Ch. 21350 (100RB Size)

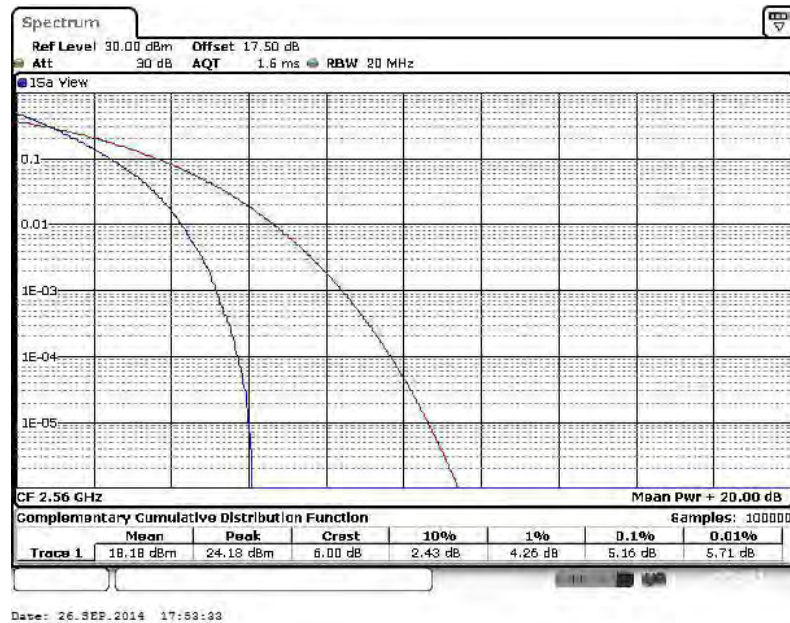



Peak-to-Average Ratio on LTE Band 7
20MHz / 16QAM in Ch. 20850 (1RB Size)

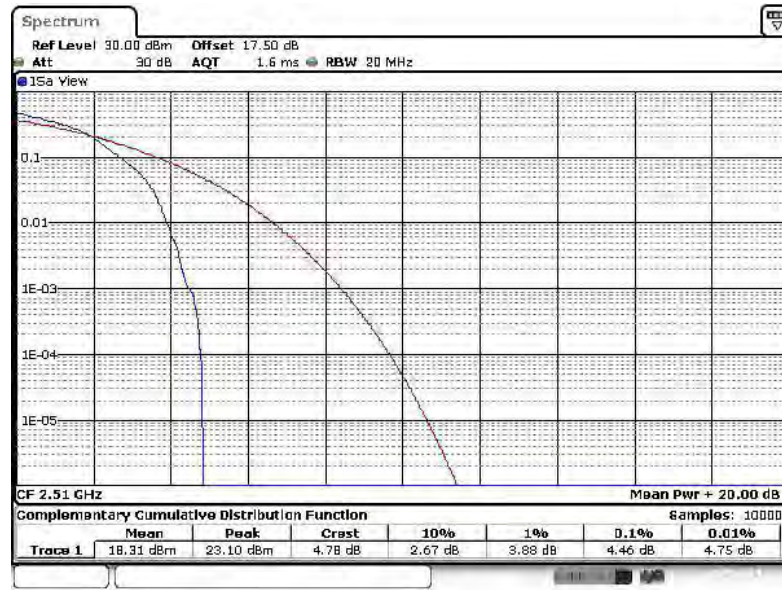

Date: 25.SEP.2014 16:07:56

Peak-to-Average Ratio on LTE Band 7
20MHz / 16QAM in Ch. 21100 (1RB Size)

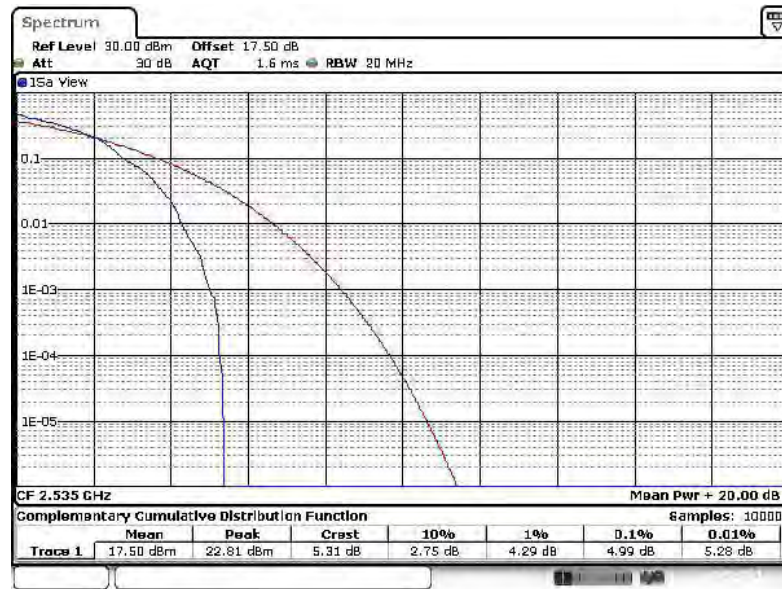

Date: 25.SEP.2014 16:07:30



Peak-to-Average Ratio on LTE Band 7
20MHz / 16QAM in Ch. 21350 (1RB Size)

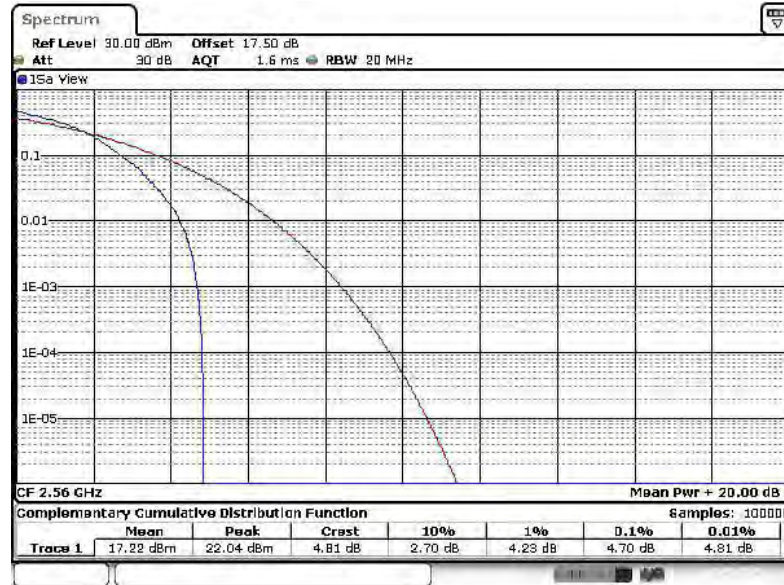

Date: 25.SEP.2014 16:10:55

Peak-to-Average Ratio on LTE Band 7
20MHz / 16QAM in Ch. 20850 (100RB Size)

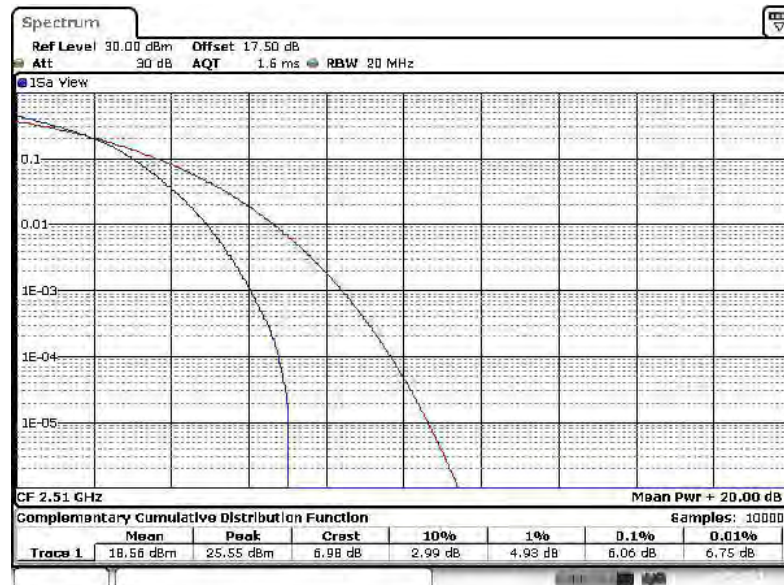

Date: 25.SEP.2014 16:08:30



Peak-to-Average Ratio on LTE Band 7
20MHz / 16QAM in Ch. 21100 (100RB Size)

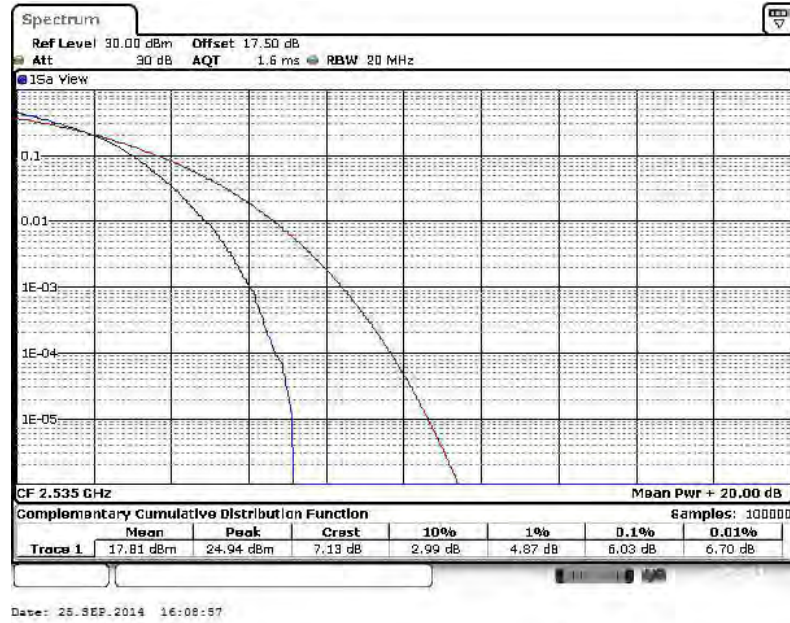

Peak-to-Average Ratio on LTE Band 7
20MHz / 16QAM in Ch. 21350 (100RB Size)

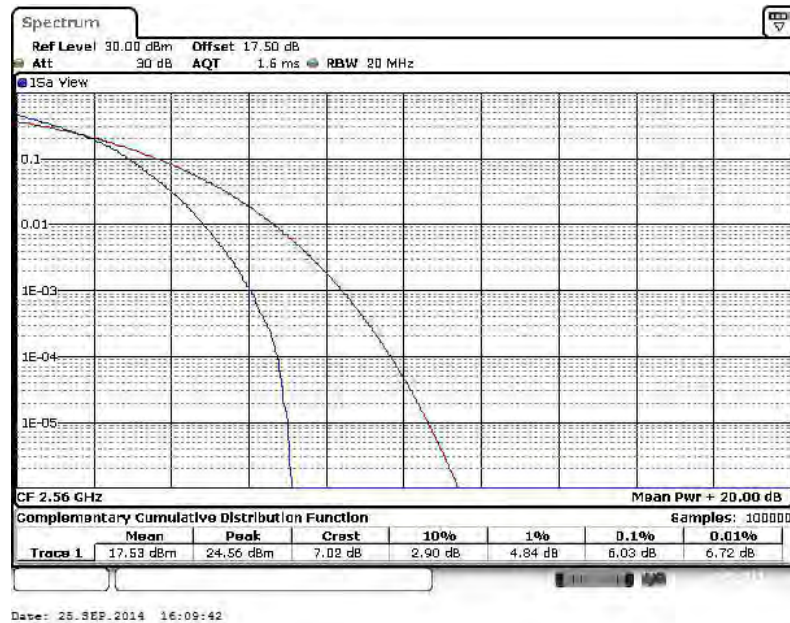



3.3 Equivalent Isotropic Radiated Power Measurement

3.3.1 Description of the EIRP Measurement

Equivalent isotropic radiated power output measurements by substitution method according to ANSI / TIA / EIA-603-C-2004, and the spectrum analyzer configuration follows KDB 971168 D01 Power Meas. License Digital Systems v02r01. Mobile and portable (hand-held) stations operating are limited to average EIRP of 2 watts with LTE band 2 / 7 and 1 watt with LTE band 4.

3.3.2 Measuring Instruments

The measuring equipment is listed in the section 4 of this test report.

3.3.3 Test Procedures

1. The EUT was placed on a turntable with 1.5 meter height in a fully anechoic chamber.
2. The EUT was set at 3 meters from the receiving antenna, which was mounted on the antenna tower.
3. The radiated emission at the fundamental frequency was measured at 3 m with a test antenna and a spectrum analyzer which used a channel power option across EUT's signal bandwidth per section 4.0 of KDB 971168 D01.
4. The table was rotated 360 degrees to determine the position of the highest radiated power.
5. The height of the receiving antenna is adjusted to look for the maximum ERP/EIRP.
6. Taking the record of maximum ERP/EIRP.
7. A dipole antenna was substituted in place of the EUT and was driven by a signal generator.
8. The conducted power at the terminal of the dipole antenna is measured.
9. Repeat step 3 to step 5 to get the maximum ERP/EIRP of the substitution antenna.
10. $ERP/EIRP = P_s + E_t - E_s + G_s = P_s + R_t - R_s + G_s$

P_s (dBm) : Input power to substitution antenna.

G_s (dBi or dBd) : Substitution antenna Gain.

$E_t = R_t + AF$

$E_s = R_s + AF$

AF (dB/m) : Receive antenna factor

R_t : The highest received signal in spectrum analyzer for EUT.

R_s : The highest received signal in spectrum analyzer for substitution antenna.

3.3.4 Test Setup

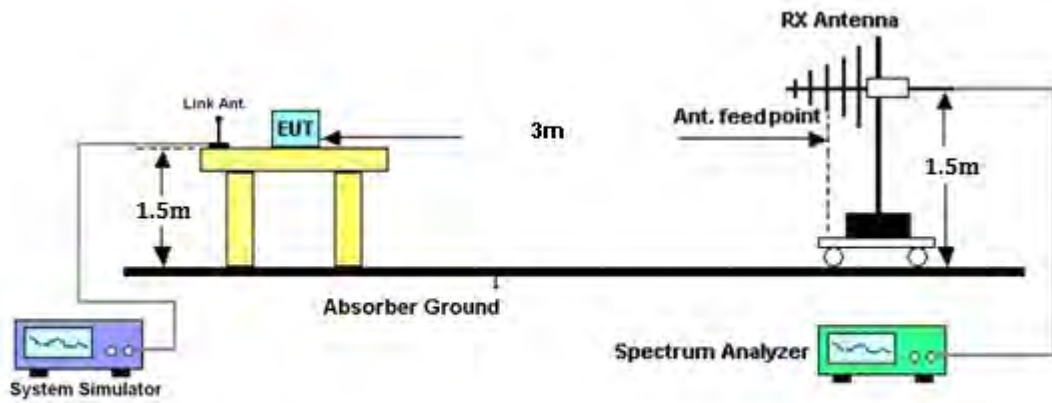



3.3.5 Test Result of EIRP

LTE Band 2 Radiated Power EIRP								
LTE Band	Channel BW (MHz)	Modulation	RB Configuration		Freq. (MHz)	EIRP (dBm)	EIRP (W)	H/V
			RB Size	RB Offset				
2	1.4	QPSK	1	2	1850.7	25.06	0.3206	H
2	1.4	QPSK	1	2	1880	24.22	0.1667	H
2	1.4	QPSK	1	2	1909.3	23.09	0.2037	H
2	1.4	QPSK	1	2	1850.7	25.16	0.3281	V
2	1.4	QPSK	1	2	1880	24.13	0.2588	V
2	1.4	QPSK	1	2	1909.3	23.05	0.2018	V
2	1.4	16QAM	1	2	1850.7	24.16	0.2606	H
2	1.4	16QAM	1	2	1880	23.36	0.2168	H
2	1.4	16QAM	1	2	1909.3	22.39	0.1734	H
2	1.4	16QAM	1	2	1850.7	24.27	0.2673	V
2	1.4	16QAM	1	2	1880	23.28	0.2128	V
2	1.4	16QAM	1	2	1909.3	22.36	0.1722	V
2	20	QPSK	1	0	1860	25.07	0.3214	H
2	20	QPSK	1	0	1880	24.54	0.2844	H
2	20	QPSK	1	0	1900	23.60	0.2291	H
2	20	QPSK	1	0	1860	25.10	0.3236	V
2	20	QPSK	1	0	1880	24.52	0.2831	V
2	20	QPSK	1	0	1900	23.52	0.2249	V
2	20	16QAM	1	0	1860	24.14	0.2594	H
2	20	16QAM	1	0	1880	23.17	0.2075	H
2	20	16QAM	1	0	1900	22.79	0.1901	H
2	20	16QAM	1	0	1860	24.22	0.2642	V
2	20	16QAM	1	0	1880	23.22	0.2099	V
2	20	16QAM	1	0	1900	22.72	0.1871	V



LTE Band 4 Radiated Power EIRP								
LTE Band	Channel BW (MHz)	Modulation	RB Configuration		Freq. (MHz)	EIRP (dBm)	EIRP (W)	H/V
			RB Size	RB Offset				
4	1.4	QPSK	1	2	1710.7	22.60	0.1820	H
4	1.4	QPSK	1	2	1732.5	21.93	0.1560	H
4	1.4	QPSK	1	2	1754.3	22.68	0.1854	H
4	1.4	QPSK	1	2	1710.7	22.74	0.1879	V
4	1.4	QPSK	1	2	1732.5	21.97	0.1574	V
4	1.4	QPSK	1	2	1754.3	22.82	0.1914	V
4	1.4	16QAM	1	2	1710.7	21.72	0.1486	H
4	1.4	16QAM	1	2	1732.5	21.19	0.1315	H
4	1.4	16QAM	1	5	1754.3	21.90	0.1549	H
4	1.4	16QAM	1	2	1710.7	21.90	0.1549	V
4	1.4	16QAM	1	2	1732.5	21.27	0.1340	V
4	1.4	16QAM	1	5	1754.3	22.07	0.1611	V
4	20	QPSK	1	0	1720	22.60	0.1820	H
4	20	QPSK	1	0	1732.5	21.29	0.1346	H
4	20	QPSK	1	0	1745	22.03	0.1596	H
4	20	QPSK	1	0	1720	22.75	0.1884	V
4	20	QPSK	1	0	1732.5	21.26	0.1337	V
4	20	QPSK	1	0	1745	22.17	0.1648	V
4	20	16QAM	1	0	1720	20.56	0.1138	H
4	20	16QAM	1	0	1732.5	20.64	0.1159	H
4	20	16QAM	1	99	1745	21.18	0.1312	H
4	20	16QAM	1	0	1720	20.66	0.1164	V
4	20	16QAM	1	0	1732.5	20.65	0.1161	V
4	20	16QAM	1	99	1745	21.36	0.1368	V



LTE Band 7 Radiated Power EIRP								
LTE Band	Channel BW (MHz)	Modulation	RB Configuration		Freq. (MHz)	EIRP (dBm)	EIRP (W)	H/V
			RB Size	RB Offset				
7	5	QPSK	1	24	2502.5	22.71	0.1866	H
7	5	QPSK	1	0	2535	22.78	0.1897	H
7	5	QPSK	1	24	2567.5	23.50	0.2239	H
7	5	QPSK	1	24	2502.5	22.56	0.1803	V
7	5	QPSK	1	0	2535	22.59	0.1816	V
7	5	QPSK	1	24	2567.5	23.26	0.2118	V
7	5	16QAM	1	24	2502.5	22.25	0.1679	H
7	5	16QAM	1	0	2535	22.26	0.1683	H
7	5	16QAM	1	12	2567.5	22.60	0.1820	H
7	5	16QAM	1	24	2502.5	22.03	0.1596	V
7	5	16QAM	1	0	2535	21.96	0.1570	V
7	5	16QAM	1	12	2567.5	22.32	0.1706	V
7	20	QPSK	1	0	2510	22.80	0.1905	H
7	20	QPSK	1	0	2535	22.14	0.1637	H
7	20	QPSK	1	0	2560	23.01	0.2000	H
7	20	QPSK	1	0	2510	22.67	0.1849	V
7	20	QPSK	1	0	2535	21.88	0.1542	V
7	20	QPSK	1	0	2560	22.78	0.1897	V
7	20	16QAM	1	49	2510	22.12	0.1629	H
7	20	16QAM	1	0	2535	21.93	0.1560	H
7	20	16QAM	1	99	2560	22.70	0.1862	H
7	20	16QAM	1	49	2510	21.73	0.1489	V
7	20	16QAM	1	0	2535	21.60	0.1445	V
7	20	16QAM	1	99	2560	22.40	0.1738	V

3.4 99% Occupied Bandwidth and 26dB Bandwidth Measurement

3.4.1 Description of 99% Occupied Bandwidth and 26dB Bandwidth Measurement

The occupied bandwidth is the width of a frequency band such that, below the lower and above the upper frequency limits, the mean powers emitted are each equal to a specified percentage 0.5% of the total mean transmitted power.

The 26 dB emission bandwidth is defined as the frequency range between two points, one above and one below the carrier frequency, at which the spectral density of the emission is attenuated 26 dB below the maximum in-band spectral density of the modulated signal. Spectral density (power per unit bandwidth) is to be measured with a detector of resolution bandwidth equal to approximately 1.0% of the emission bandwidth.

3.4.2 Measuring Instruments

The measuring equipment is listed in the section 4 of this test report.

3.4.3 Test Procedures

1. The EUT was connected to spectrum analyzer and system simulator via a power divider.
2. The 26dB and 99% occupied bandwidth (BW) of the middle channel for the highest RF power with full RB sizes were measured.

3.4.4 Test Setup

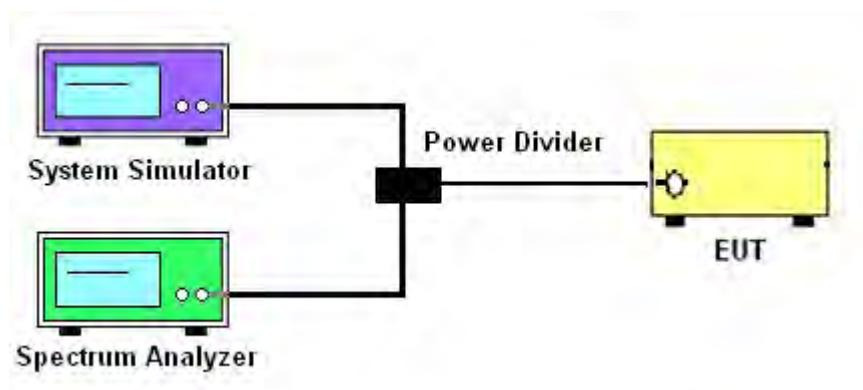

3.4.5 Test Result of 99% Occupied Bandwidth and 26dB Bandwidth

Modes	LTE Band 7			
BW / Mod.	5MHz / QPSK	5MHz / 16QAM	10MHz / QPSK	10MHz / 16QAM
99% OBW (MHz)	4.515	4.505	9.111	9.051
26dB BW (MHz)	5.085	5.055	10.090	10.030
BW / Mod.	15MHz / QPSK	15MHz / 16QAM	20MHz / QPSK	20MHz / 16QAM
99% OBW (MHz)	13.516	13.516	18.501	18.541
26dB BW (MHz)	14.805	14.955	20.739	20.619

Modes	LTE Band 2			
BW / Mod.	1.4MHz / QPSK	1.4MHz / 16QAM	3MHz / QPSK	3MHz / 16QAM
99% OBW (MHz)	1.094	1.099	2.721	2.721
26dB BW (MHz)	1.256	1.284	3.033	3.027
BW / Mod.	5MHz / QPSK	5MHz / 16QAM	10MHz / QPSK	10MHz / 16QAM
99% OBW (MHz)	4.505	4.505	9.111	9.011
26dB BW (MHz)	5.085	5.075	10.110	10.010
BW / Mod.	15MHz / QPSK	15MHz / 16QAM	20MHz / QPSK	20MHz / 16QAM
99% OBW (MHz)	13.487	13.457	18.422	18.422
26dB BW (MHz)	14.865	14.715	20.539	20.380

Modes	LTE Band 4			
BW / Mod.	1.4MHz / QPSK	1.4MHz / 16QAM	3MHz / QPSK	3MHz / 16QAM
99% OBW (MHz)	1.094	1.097	2.721	2.715
26dB BW (MHz)	1.264	1.281	3.021	3.027
BW / Mod.	5MHz / QPSK	5MHz / 16QAM	10MHz / QPSK	10MHz / 16QAM
99% OBW (MHz)	4.505	4.505	9.071	9.011
26dB BW (MHz)	5.075	5.085	10.070	9.970
BW / Mod.	15MHz / QPSK	15MHz / 16QAM	20MHz / QPSK	20MHz / 16QAM
99% OBW (MHz)	13.487	13.457	18.462	18.422
26dB BW (MHz)	14.865	14.835	20.579	20.579



Note:

The maximum RB configurations of the 99% Occupied Bandwidth and 26dB Bandwidth summary as below:

BW1.4MHz RB setting : RB Size 6, RB offset 0

BW3.0MHz RB setting : RB Size 15, RB offset 0

BW5.0MHz RB setting : RB Size 25, RB offset 0

BW10MHz RB setting : RB Size 50, RB offset 0

BW15MHz RB setting : RB Size 75, RB offset 0

BW20MHz RB setting : RB Size 100, RB offset 0



3.4.6 Test Result (Plots) of 99% Occupied Bandwidth and 26dB Bandwidth

Band :	LTE Band 7	BW / Mod. :	5MHz / QPSK
--------	------------	-------------	-------------

99% Occupied Bandwidth Plot on Channel 21100

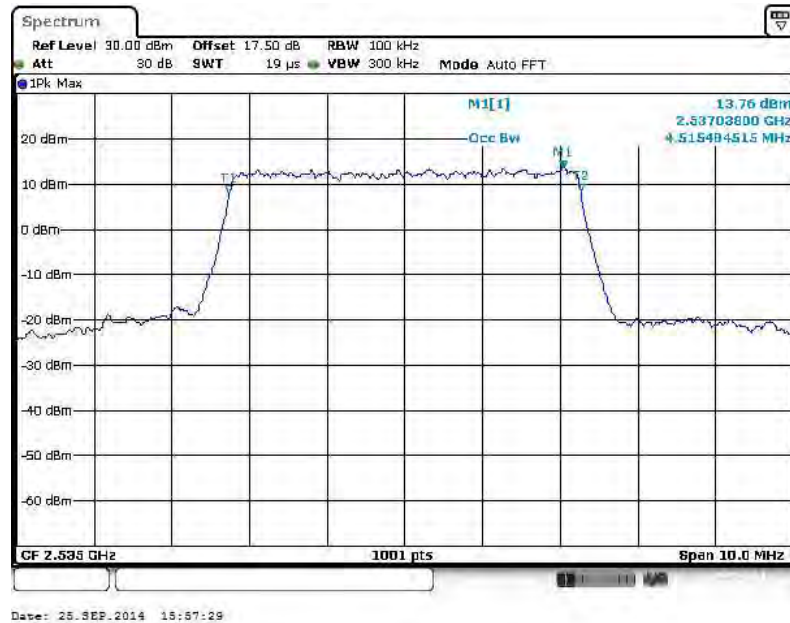

26dB Bandwidth Plot on Channel 21100

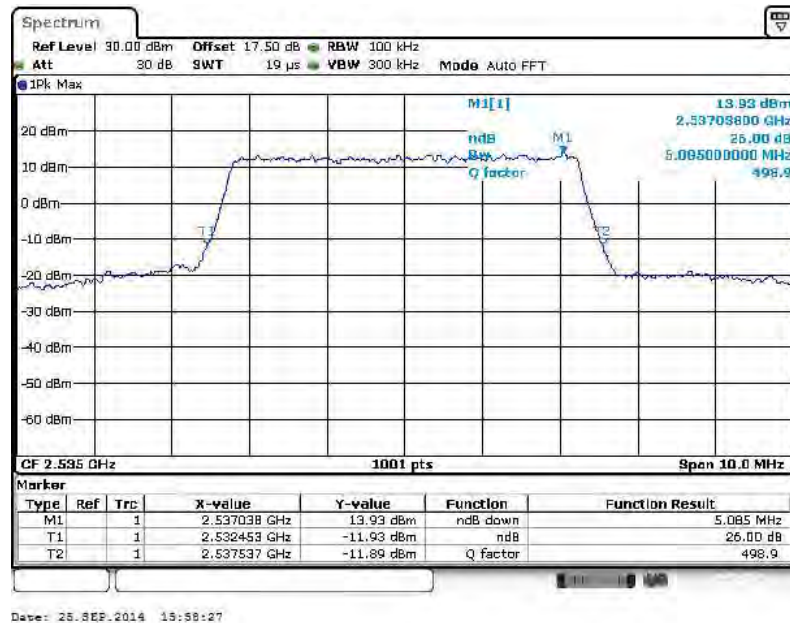



Band :	LTE Band 7	BW / Mod. :	5MHz / 16QAM
--------	------------	-------------	--------------

99% Occupied Bandwidth Plot on Channel 21100

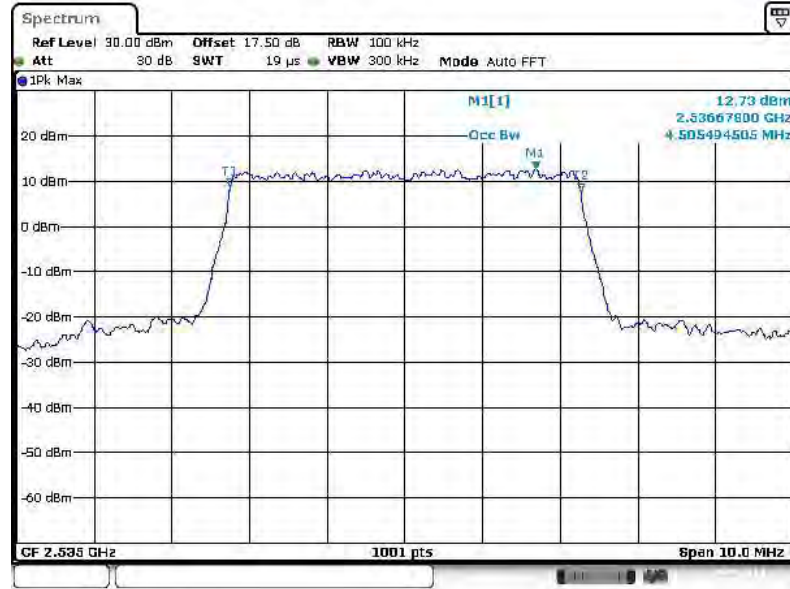

Date: 25 SEP. 2014 15:56:04

26dB Bandwidth Plot on Channel 21100

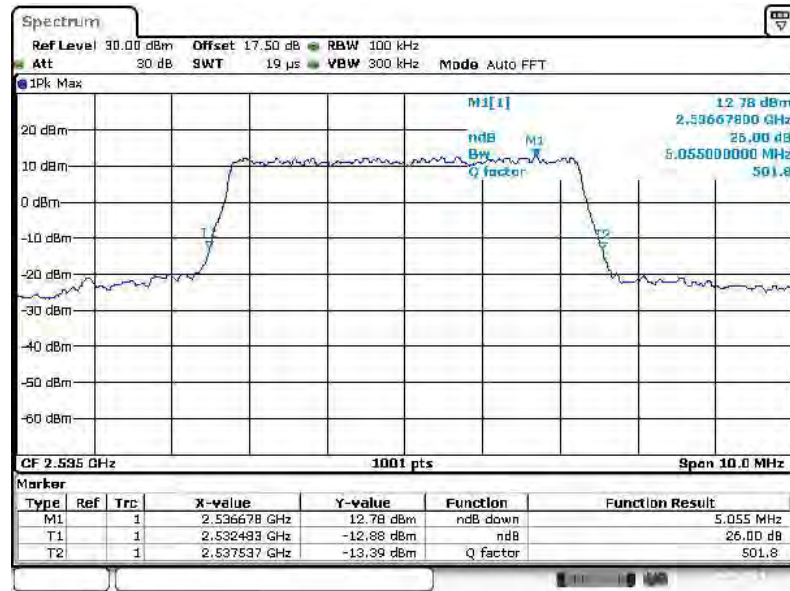

Date: 25 SEP. 2014 15:56:46



Band :	LTE Band 7	BW / Mod. :	10MHz / QPSK
--------	------------	-------------	--------------

99% Occupied Bandwidth Plot on Channel 21100

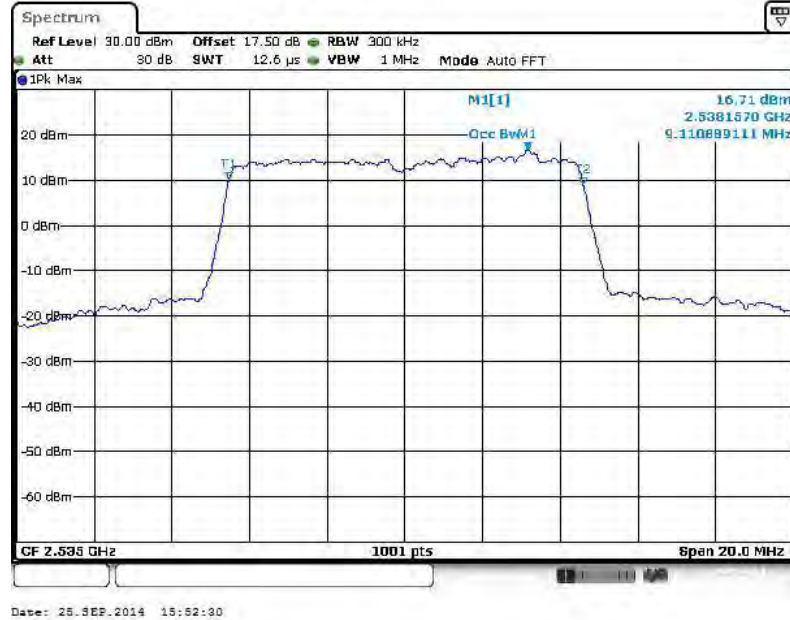

26dB Bandwidth Plot on Channel 21100

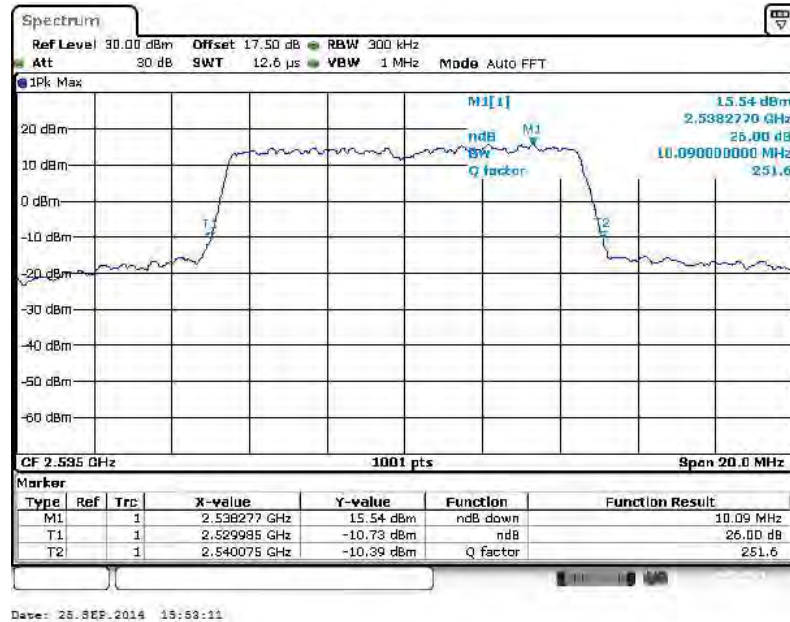



Band :	LTE Band 7	BW / Mod. :	10MHz / 16QAM
--------	------------	-------------	---------------

99% Occupied Bandwidth Plot on Channel 21100

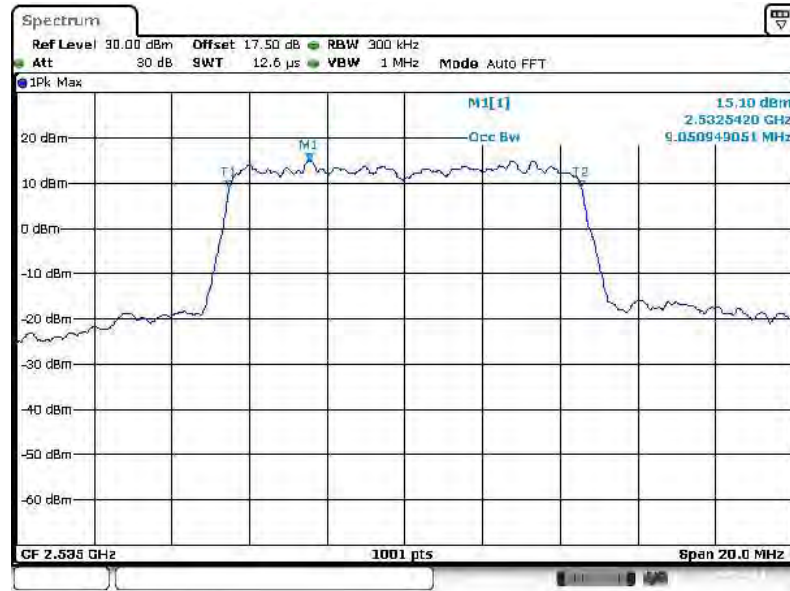

Date: 25 SEP. 2014 15:53:47

26dB Bandwidth Plot on Channel 21100

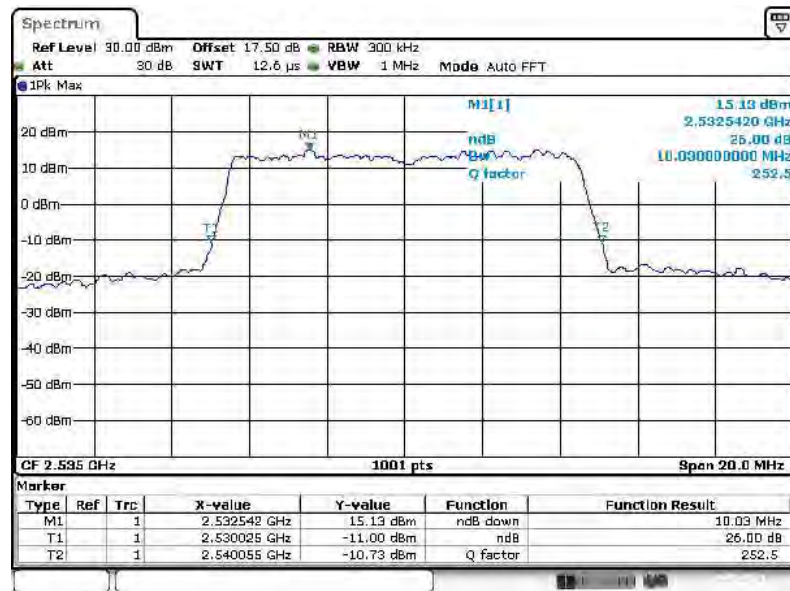

Date: 25 SEP. 2014 15:54:47



Band :	LTE Band 7	BW / Mod. :	15MHz / QPSK
--------	------------	-------------	--------------

99% Occupied Bandwidth Plot on Channel 21100



Date: 25.SEP.2014 15:59:51

26dB Bandwidth Plot on Channel 21100

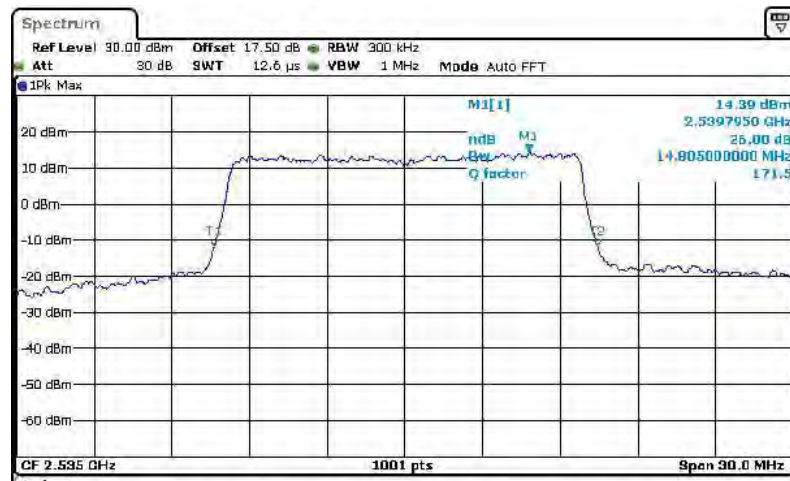

Marker	Type	Ref	Trc	X-value	Y-value	Function	Function Result
M1	1			2.539795 GHz	14.39 dBm	ndB down	14.805 MHz
T1	1			2.527627 GHz	-11.67 dBm	ndB	26.00 dB
T2	1			2.542433 GHz	-11.82 dBm	Q factor	171.5

Date: 25.SEP.2014 16:01:28



Band :	LTE Band 7	BW / Mod. :	15MHz / 16QAM
--------	------------	-------------	---------------

99% Occupied Bandwidth Plot on Channel 21100

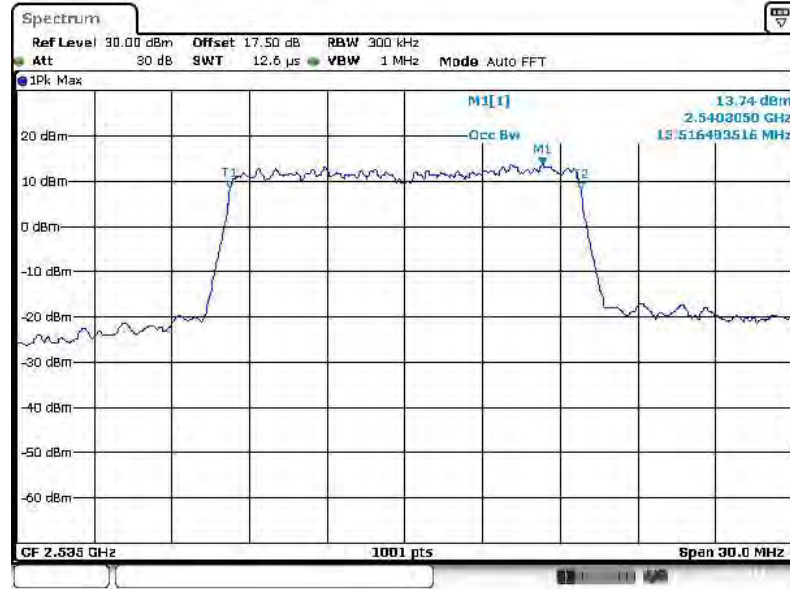

Date: 25.SEP.2014 16:03:05

26dB Bandwidth Plot on Channel 21100

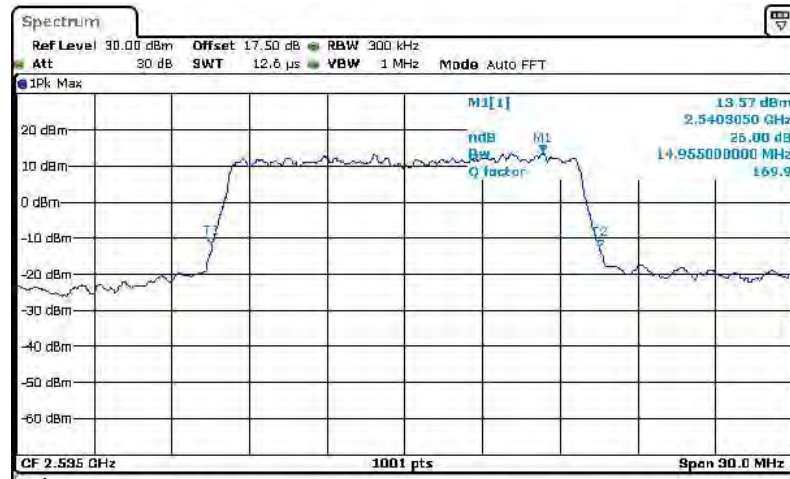

Type	Ref	Trc	X-value	Y-value	Function	Function Result
M1	1		2.540305 GHz	13.57 dBm	ndB down	14.955 MHz
T1	1		2.527537 GHz	-12.07 dBm	ndB	26.00 dB
T2	1		2.542493 GHz	-12.47 dBm	Q factor	169.9

Date: 25.SEP.2014 16:03:49



Band :	LTE Band 7	BW / Mod. :	20MHz / QPSK
--------	------------	-------------	--------------

99% Occupied Bandwidth Plot on Channel 21100

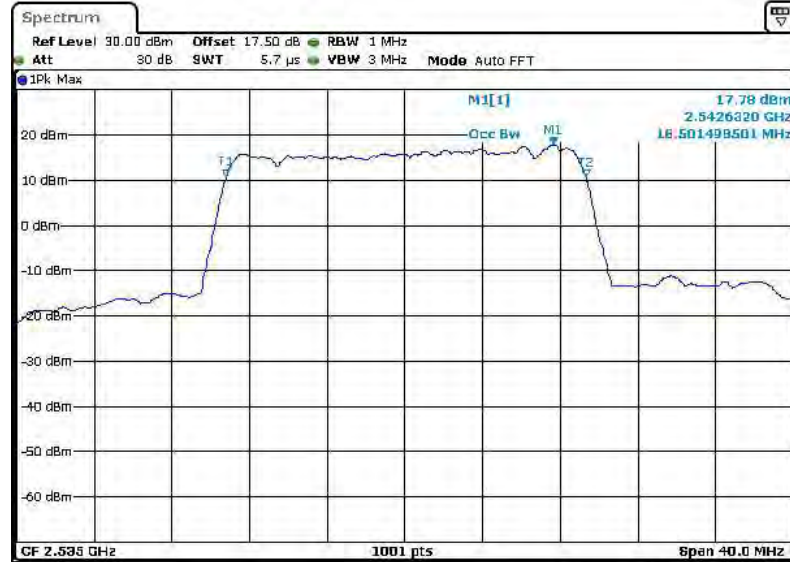

Date: 25. SEP. 2014 16:12:59

26dB Bandwidth Plot on Channel 21100

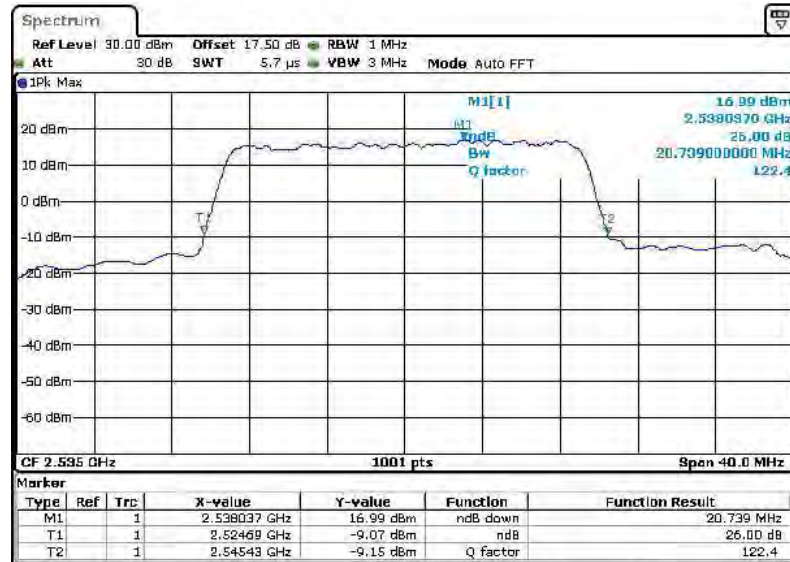

Date: 25. SEP. 2014 16:13:39



Band :	LTE Band 7	BW / Mod. :	20MHz / 16QAM
--------	------------	-------------	---------------

99% Occupied Bandwidth Plot on Channel 21100



26dB Bandwidth Plot on Channel 21100

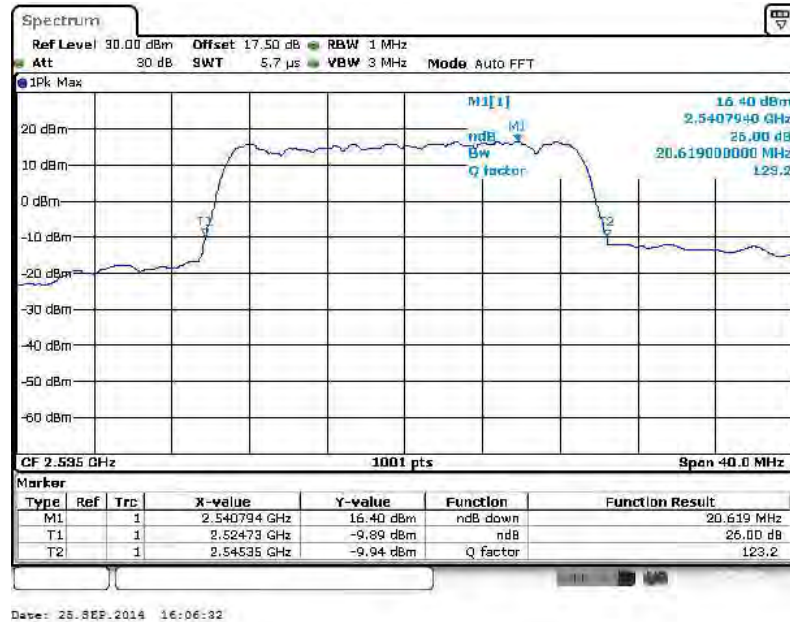



Band :	LTE Band 2	BW / Mod. :	1.4MHz / QPSK
--------	------------	-------------	---------------

99% Occupied Bandwidth Plot on Channel 18900

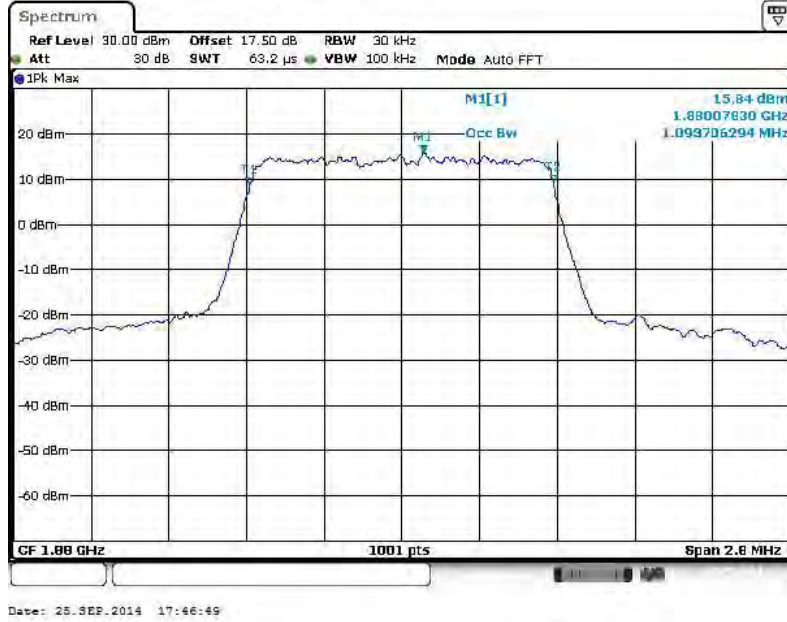

26dB Bandwidth Plot on Channel 18900

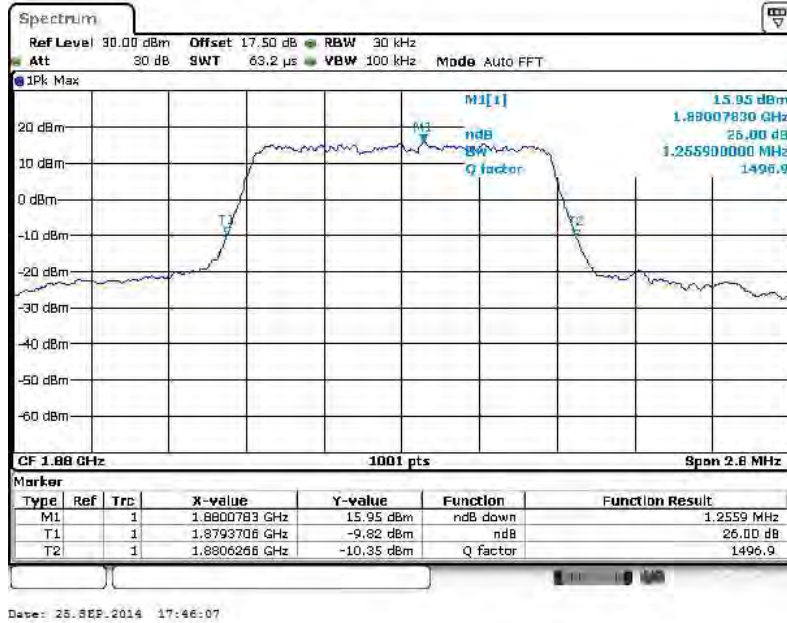



Band :	LTE Band 2	BW / Mod. :	1.4MHz / 16QAM
---------------	------------	--------------------	----------------

99% Occupied Bandwidth Plot on Channel 18900

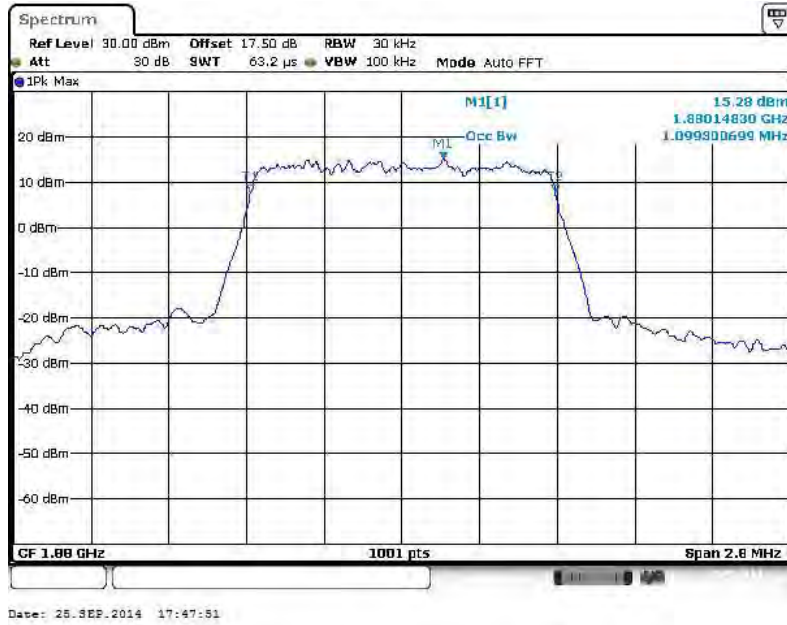

26dB Bandwidth Plot on Channel 18900

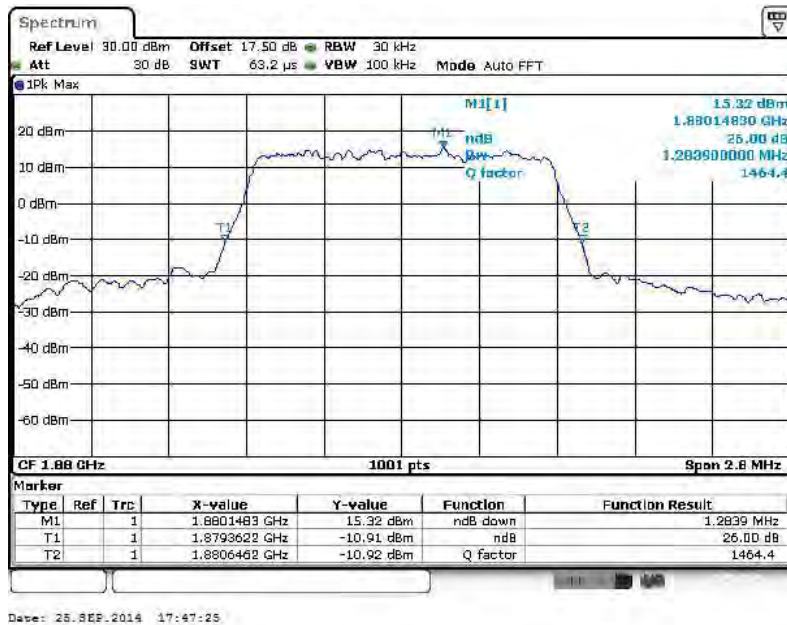



Band :	LTE Band 2	BW / Mod. :	3MHz / QPSK
---------------	------------	--------------------	-------------

99% Occupied Bandwidth Plot on Channel 18900

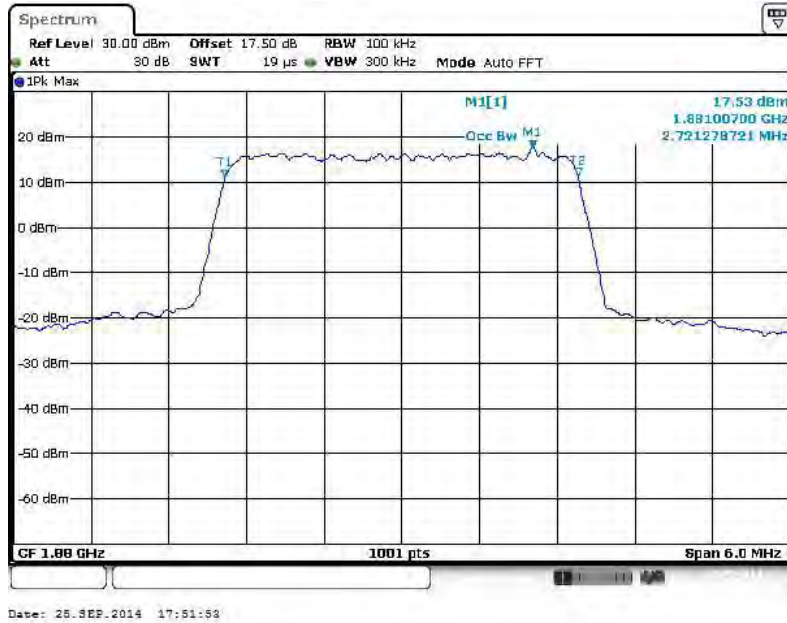

26dB Bandwidth Plot on Channel 18900

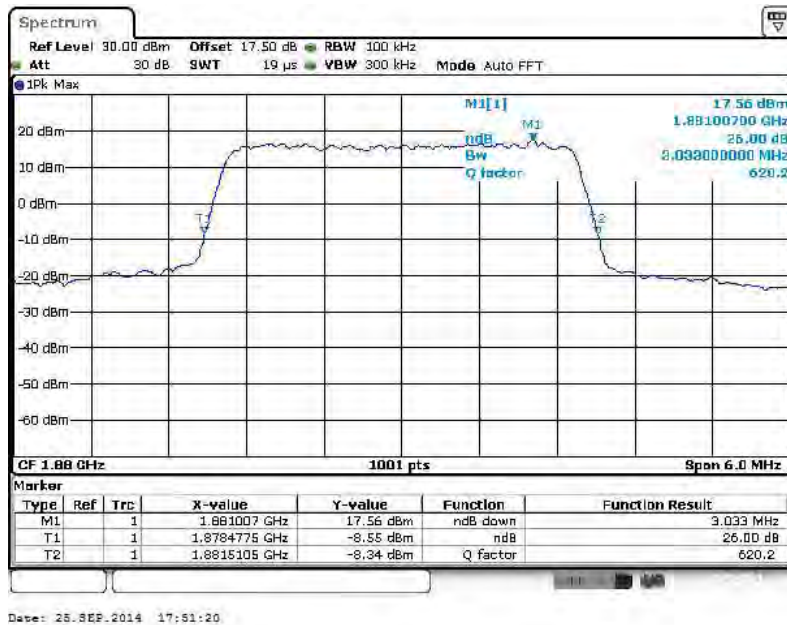



Band :	LTE Band 2	BW / Mod. :	3MHz / 16QAM
--------	------------	-------------	--------------

99% Occupied Bandwidth Plot on Channel 18900

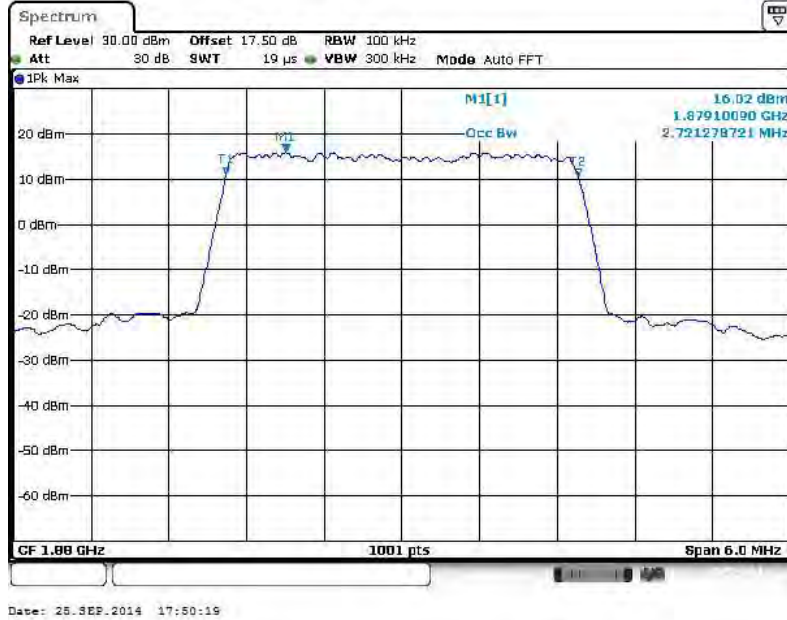

26dB Bandwidth Plot on Channel 18900

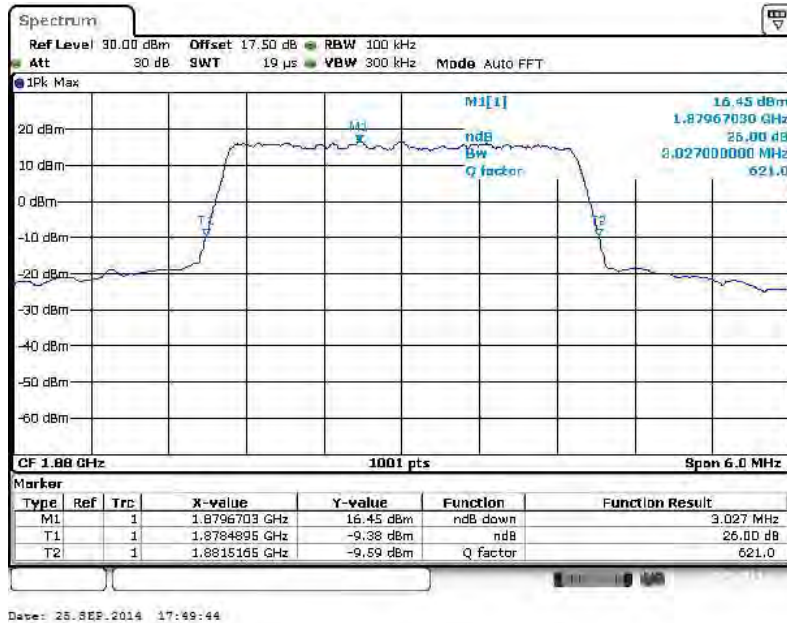



Band :	LTE Band 2	BW / Mod. :	5MHz / QPSK
--------	------------	-------------	-------------

99% Occupied Bandwidth Plot on Channel 18900

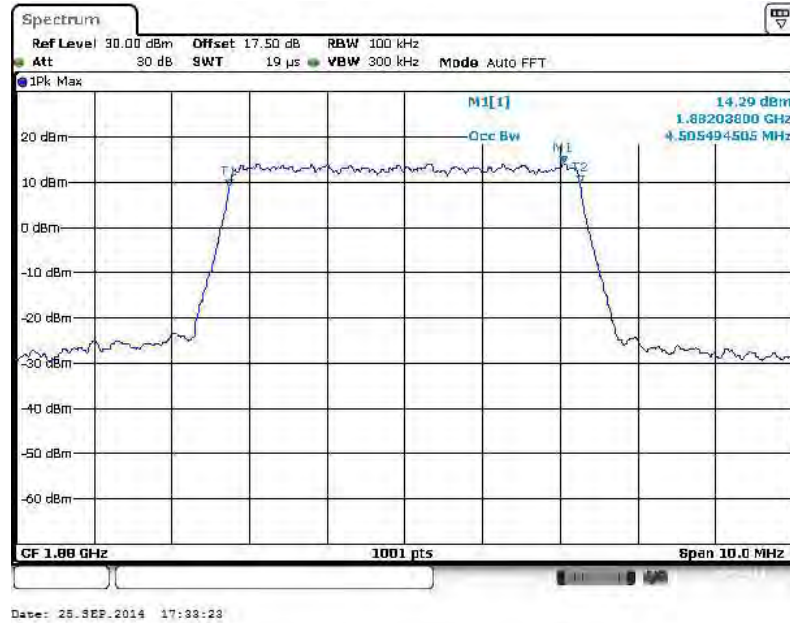

26dB Bandwidth Plot on Channel 18900

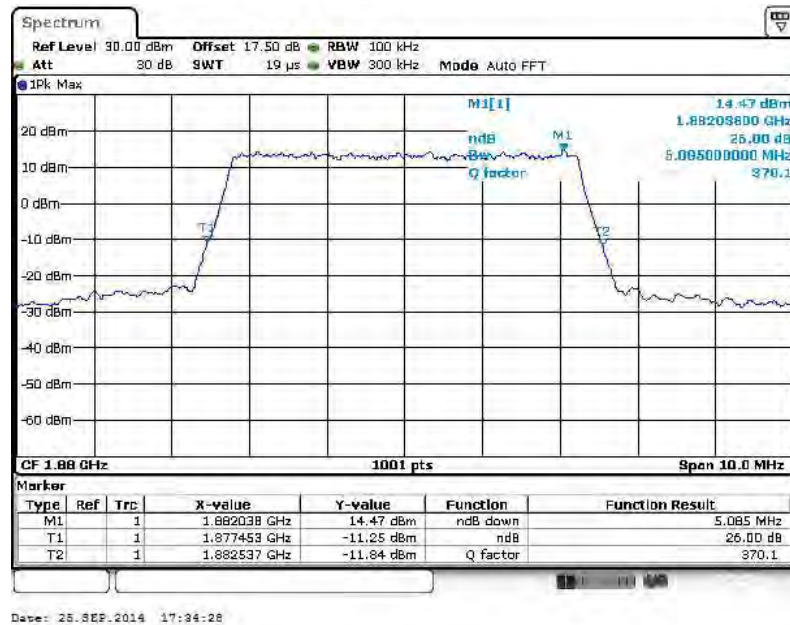



Band :	LTE Band 2	BW / Mod. :	5MHz / 16QAM
---------------	------------	--------------------	--------------

99% Occupied Bandwidth Plot on Channel 18900

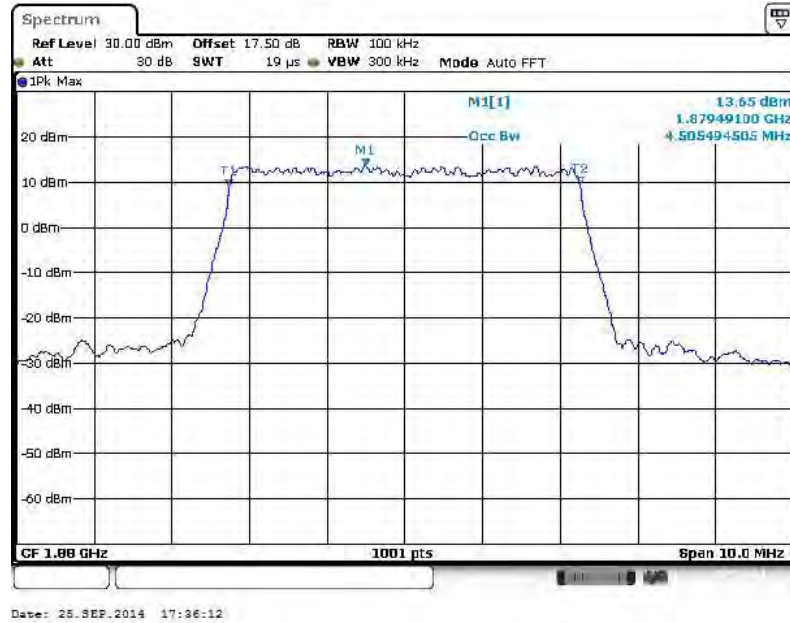

26dB Bandwidth Plot on Channel 18900

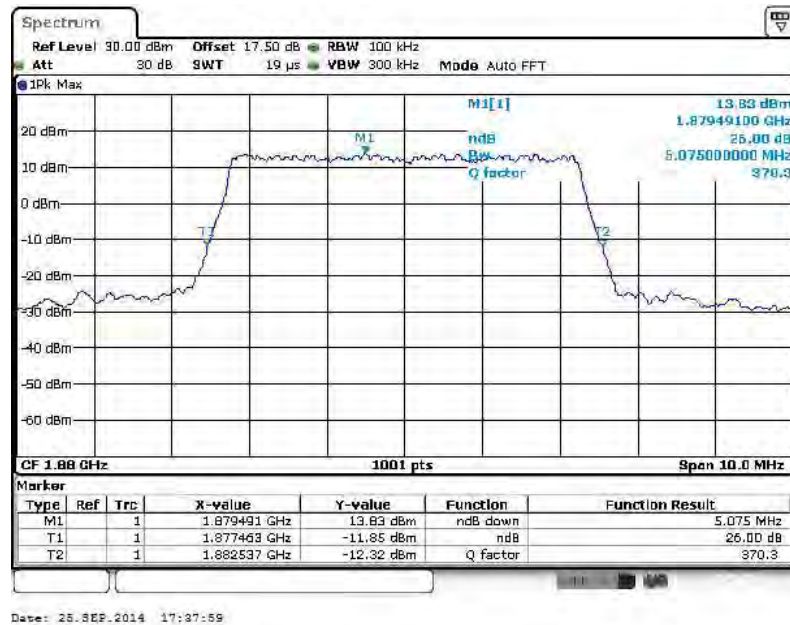



Band :	LTE Band 2	BW / Mod. :	10MHz / QPSK
--------	------------	-------------	--------------

99% Occupied Bandwidth Plot on Channel 18900

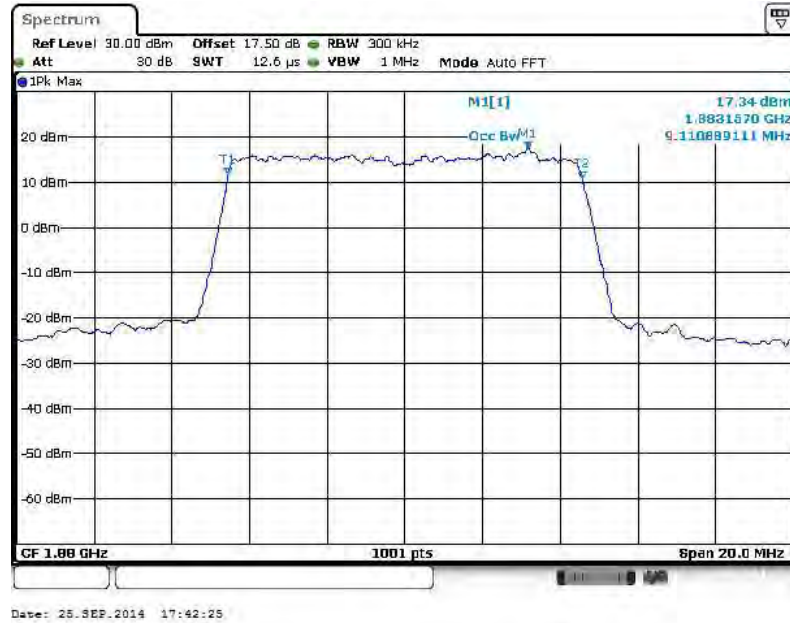

26dB Bandwidth Plot on Channel 18900

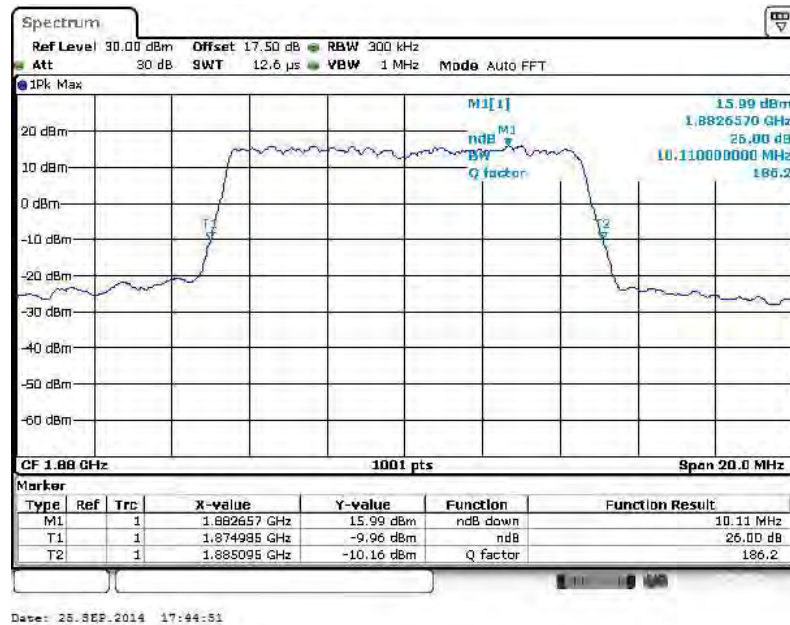



Band :	LTE Band 2	BW / Mod. :	10MHz / 16QAM
---------------	------------	--------------------	---------------

99% Occupied Bandwidth Plot on Channel 18900

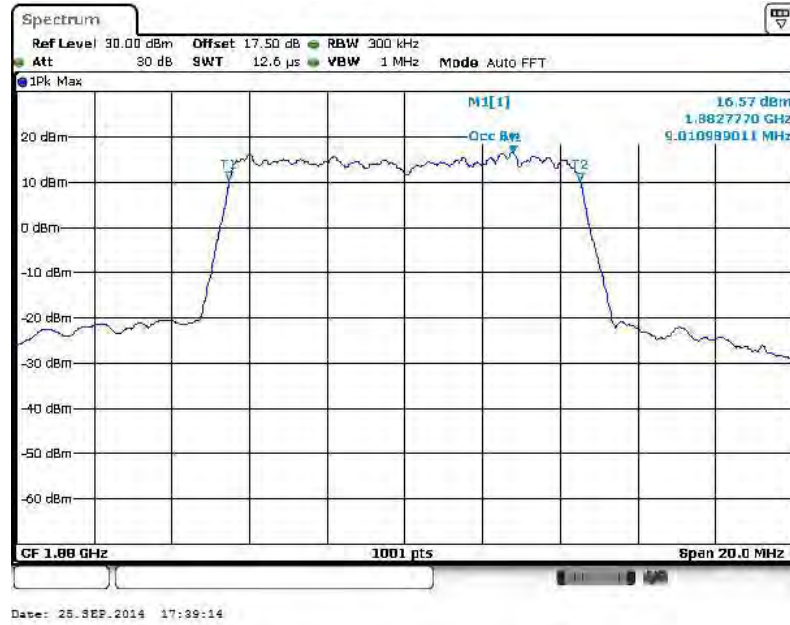

26dB Bandwidth Plot on Channel 18900

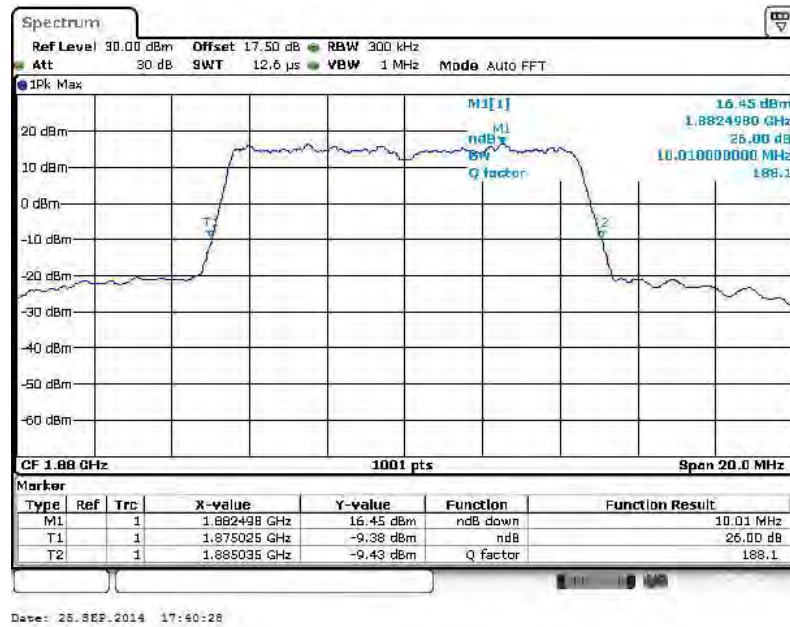



Band :	LTE Band 2	BW / Mod. :	15MHz / QPSK
--------	------------	-------------	--------------

99% Occupied Bandwidth Plot on Channel 18900

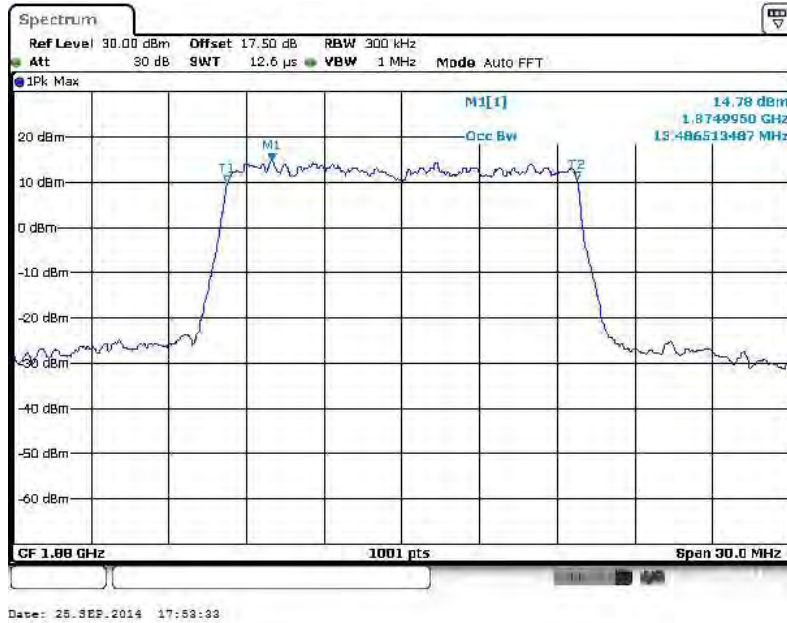

26dB Bandwidth Plot on Channel 18900

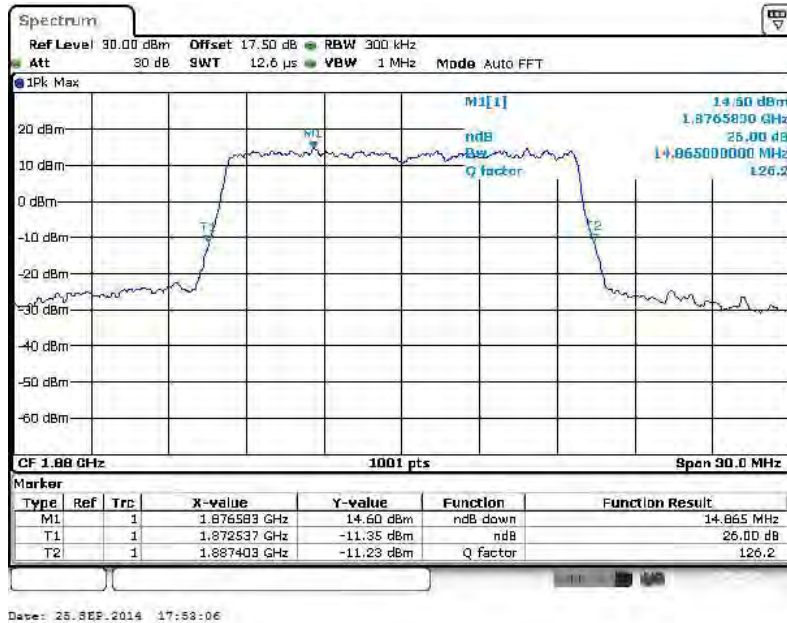



Band :	LTE Band 2	BW / Mod. :	15MHz / 16QAM
--------	------------	-------------	---------------

99% Occupied Bandwidth Plot on Channel 18900

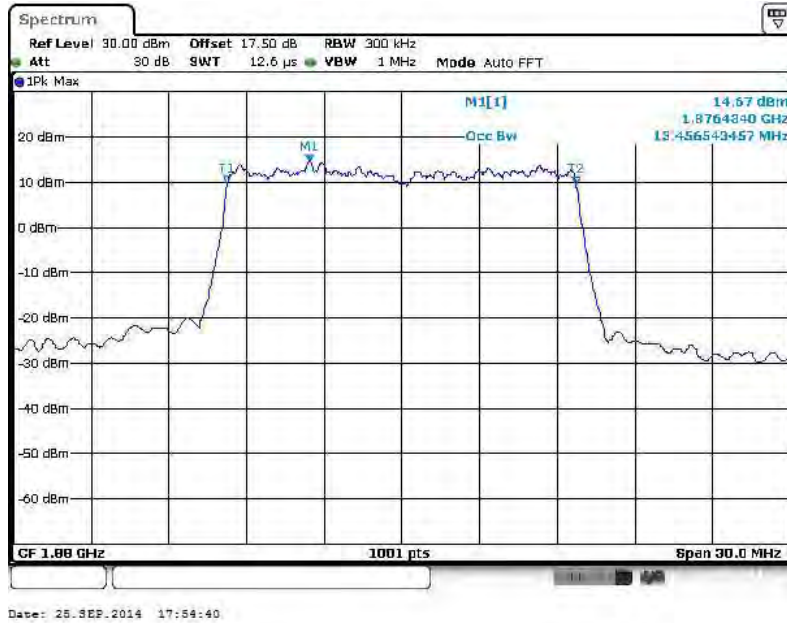

26dB Bandwidth Plot on Channel 18900

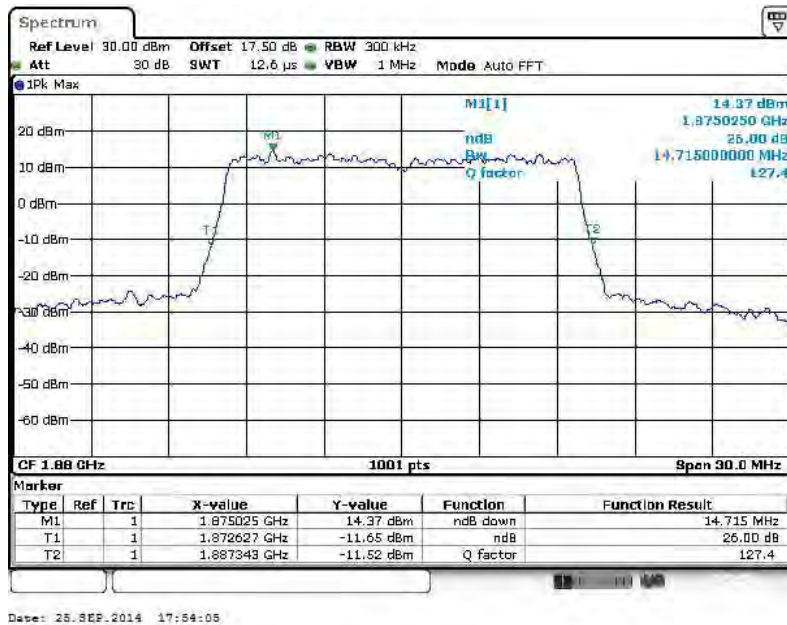



Band :	LTE Band 2	BW / Mod. :	20MHz / QPSK
--------	------------	-------------	--------------

99% Occupied Bandwidth Plot on Channel 18900

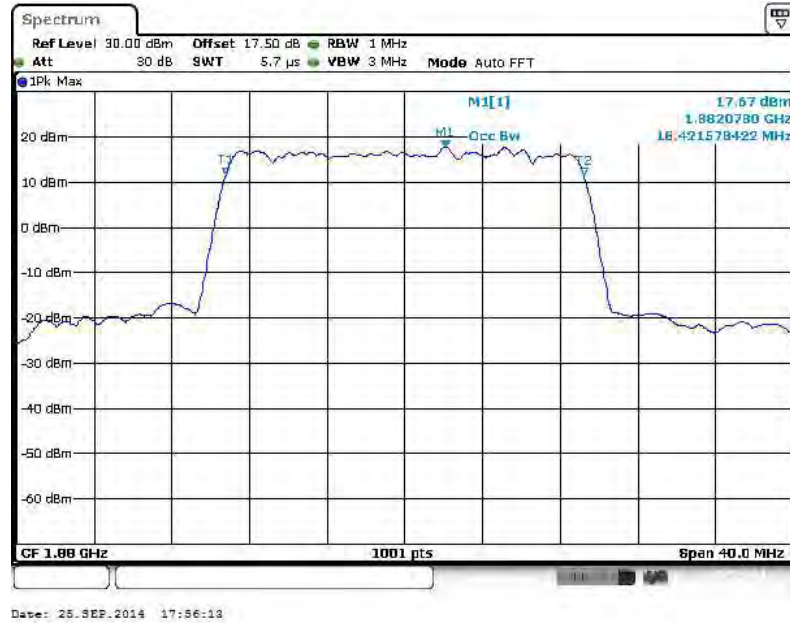

26dB Bandwidth Plot on Channel 18900

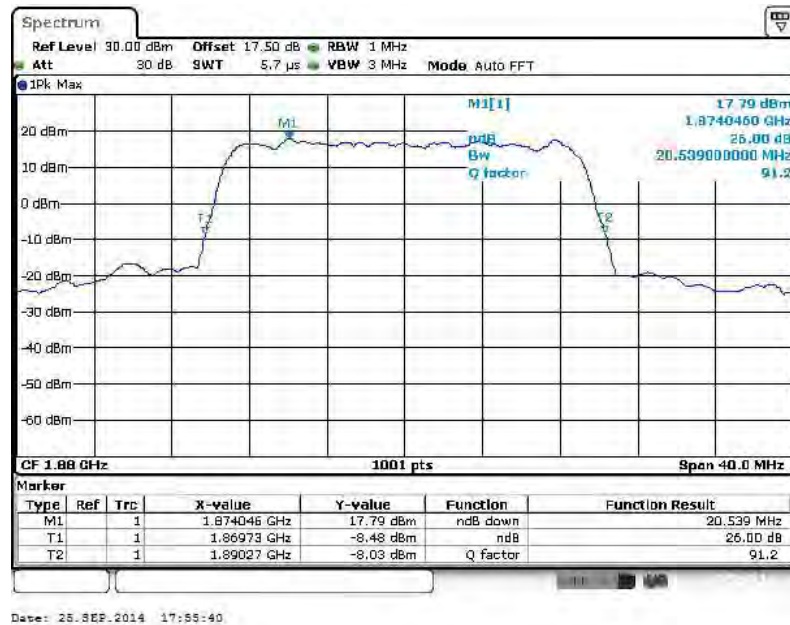



Band :	LTE Band 2	BW / Mod. :	20MHz / 16QAM
---------------	------------	--------------------	---------------

99% Occupied Bandwidth Plot on Channel 18900

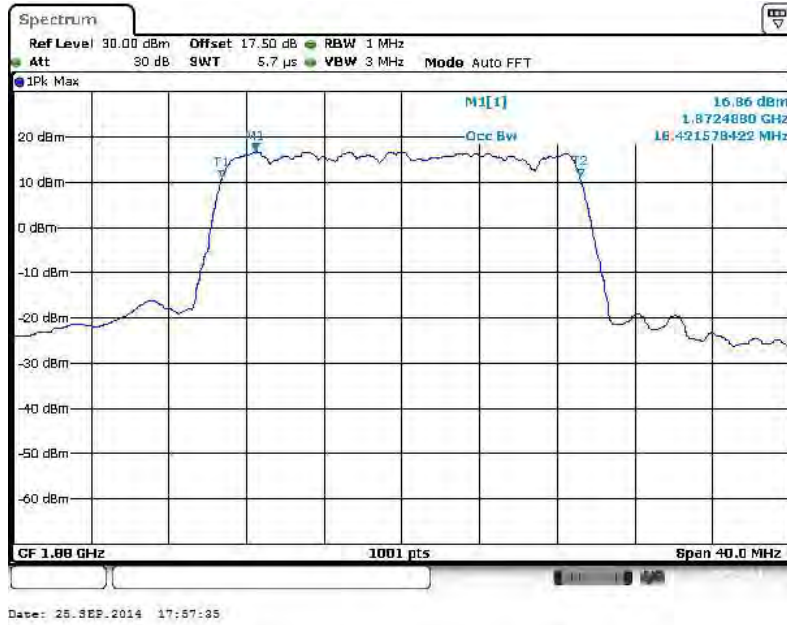

26dB Bandwidth Plot on Channel 18900

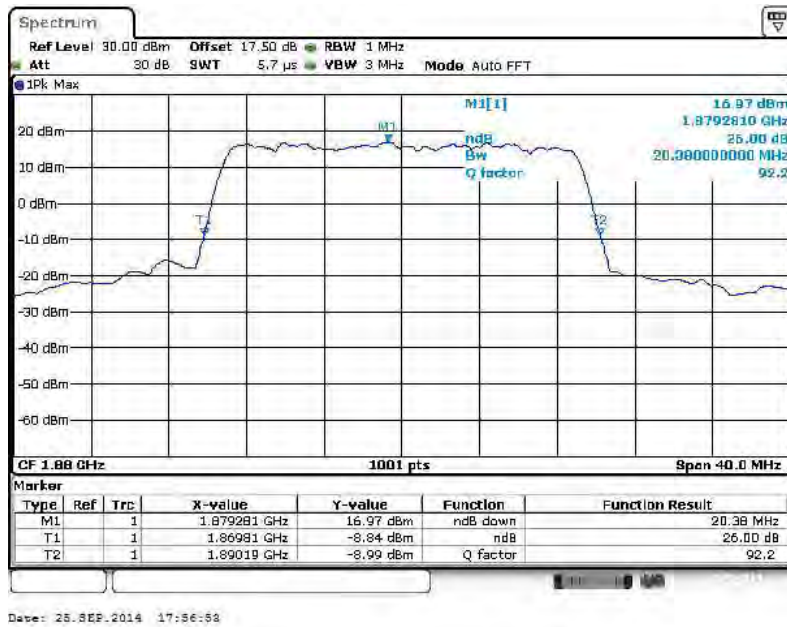



Band :	LTE Band 4	BW / Mod. :	1.4MHz / QPSK
---------------	------------	--------------------	---------------

99% Occupied Bandwidth Plot on Channel 20175

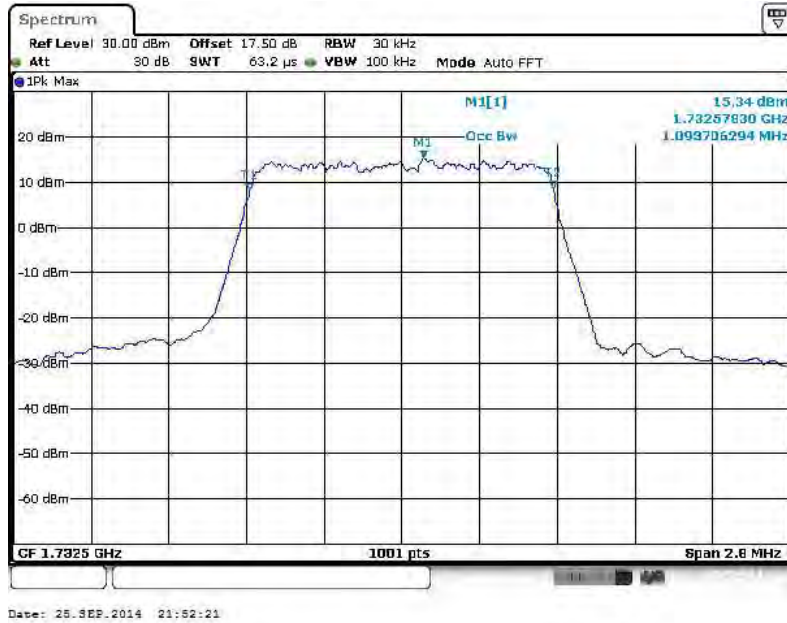

26dB Bandwidth Plot on Channel 20175

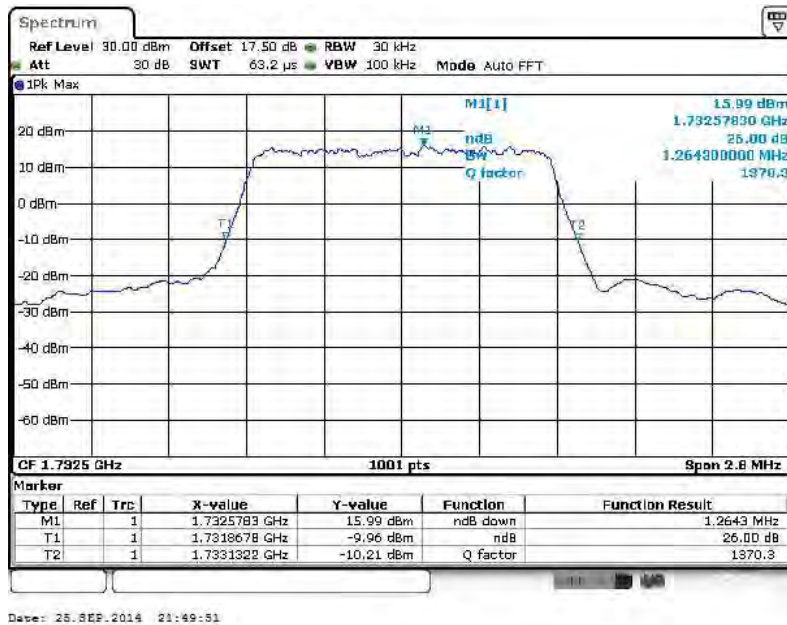



Band :	LTE Band 4	BW / Mod. :	1.4MHz / 16QAM
---------------	------------	--------------------	----------------

99% Occupied Bandwidth Plot on Channel 20175

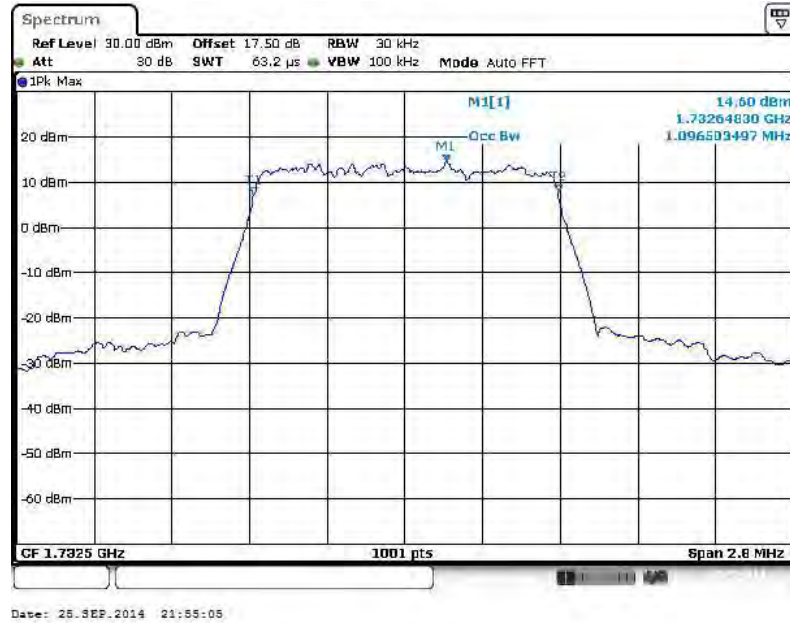

26dB Bandwidth Plot on Channel 20175

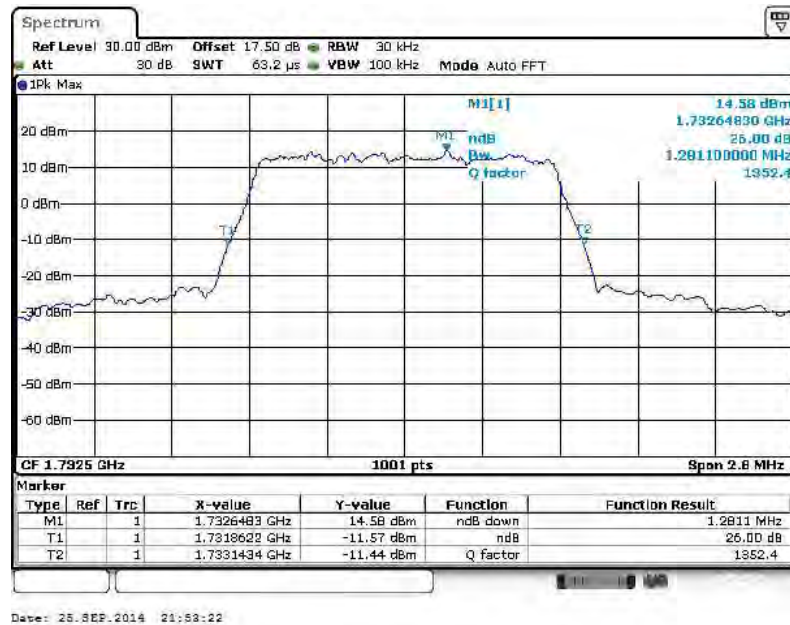



Band :	LTE Band 4	BW / Mod. :	3MHz / QPSK
--------	------------	-------------	-------------

99% Occupied Bandwidth Plot on Channel 20175

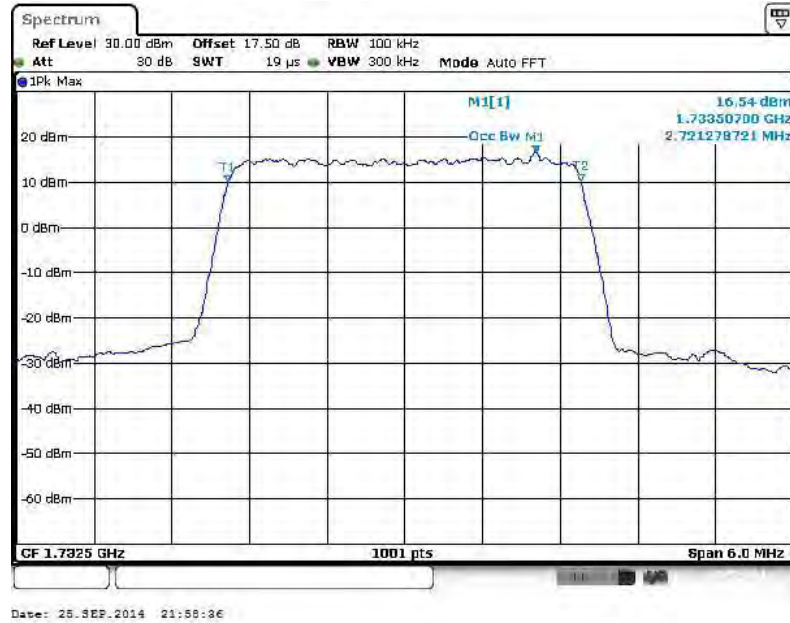

26dB Bandwidth Plot on Channel 20175

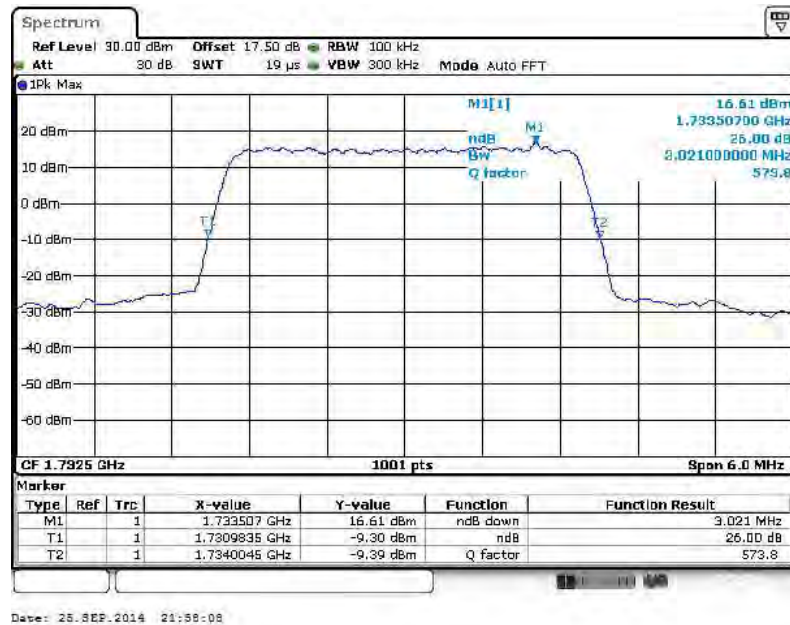



Band :	LTE Band 4	BW / Mod. :	3MHz / 16QAM
--------	------------	-------------	--------------

99% Occupied Bandwidth Plot on Channel 20175

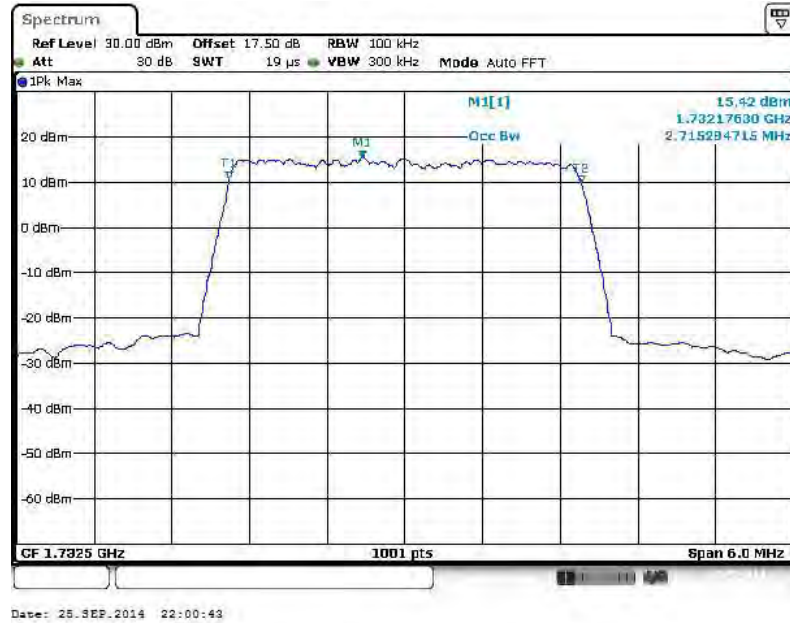

26dB Bandwidth Plot on Channel 20175

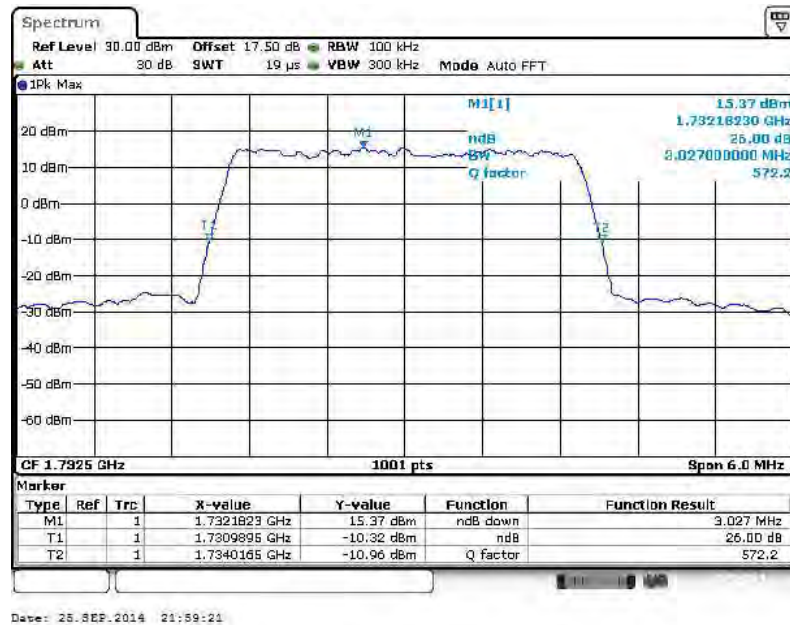



Band :	LTE Band 4	BW / Mod. :	5MHz / QPSK
--------	------------	-------------	-------------

99% Occupied Bandwidth Plot on Channel 20175

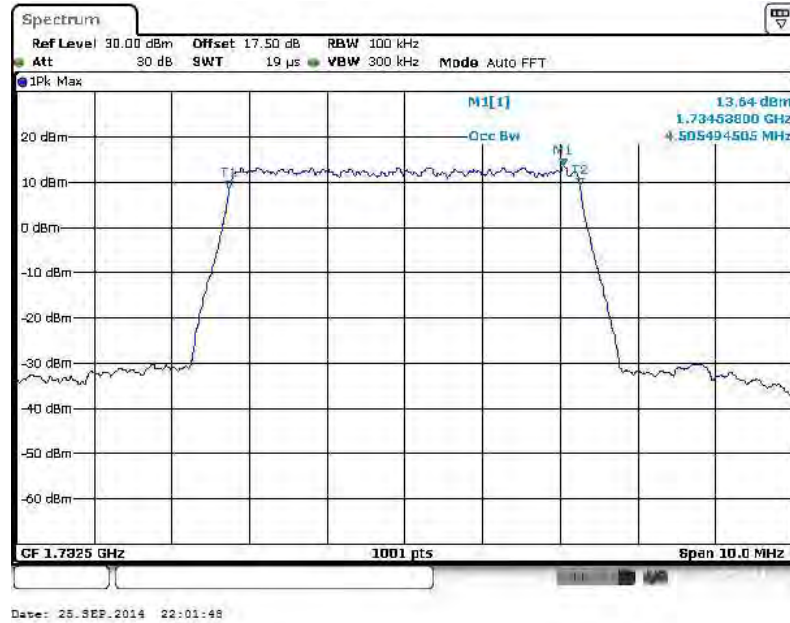

26dB Bandwidth Plot on Channel 20175

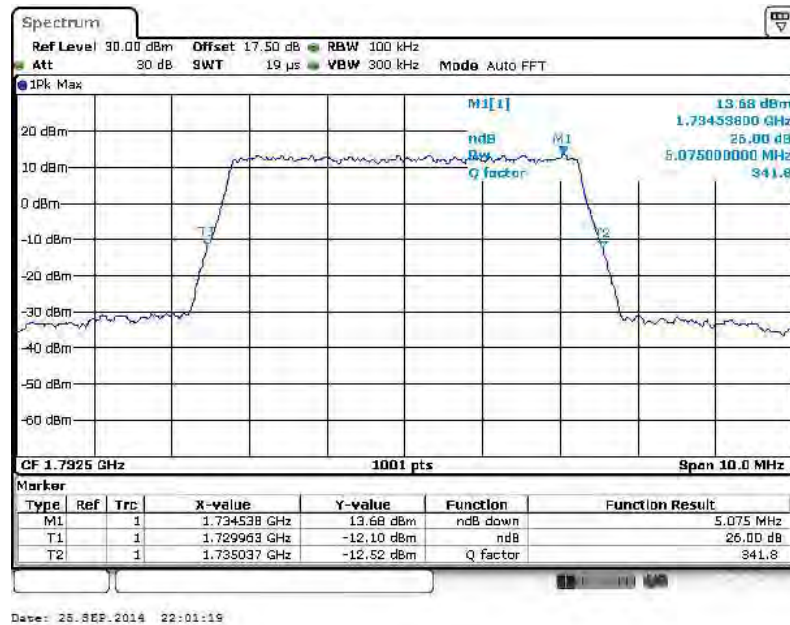



Band :	LTE Band 4	BW / Mod. :	5MHz / 16QAM
--------	------------	-------------	--------------

99% Occupied Bandwidth Plot on Channel 20175

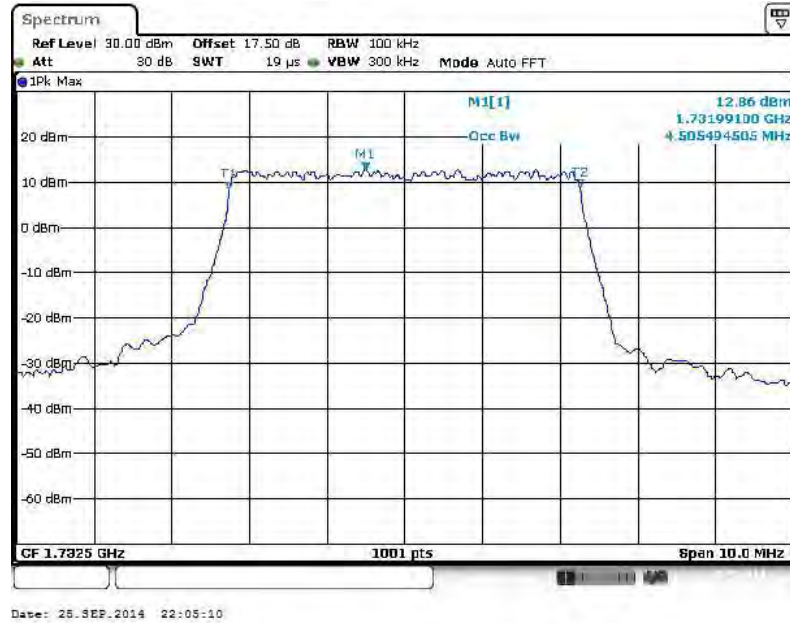

26dB Bandwidth Plot on Channel 20175

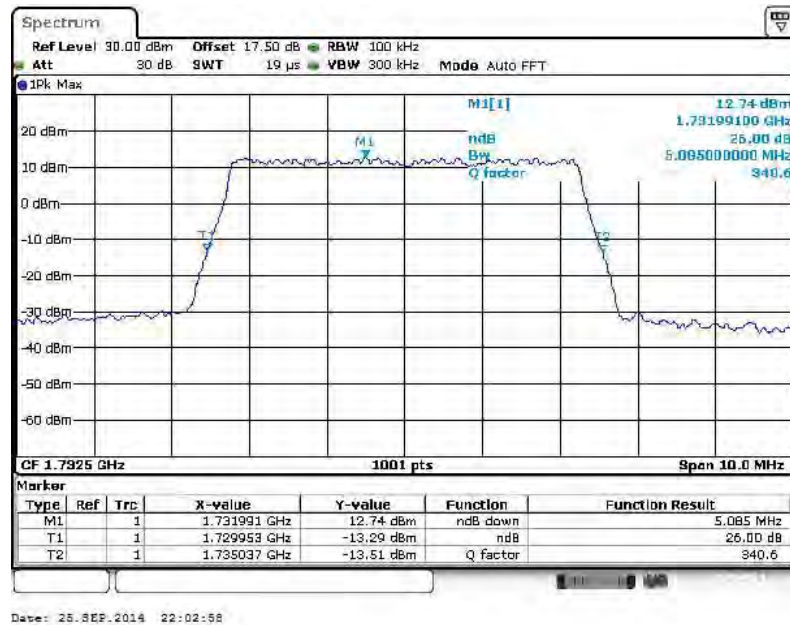



Band :	LTE Band 4	BW / Mod. :	10MHz / QPSK
--------	------------	-------------	--------------

99% Occupied Bandwidth Plot on Channel 20175

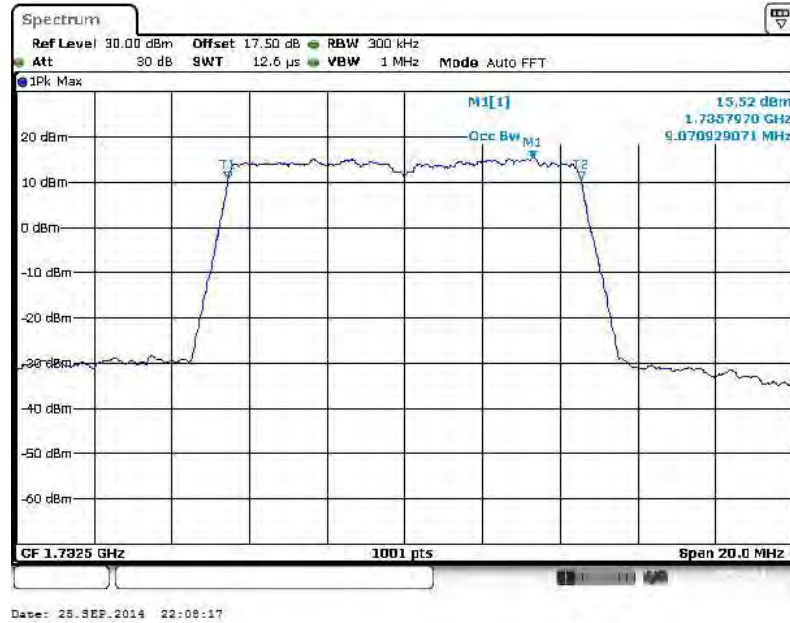

26dB Bandwidth Plot on Channel 20175

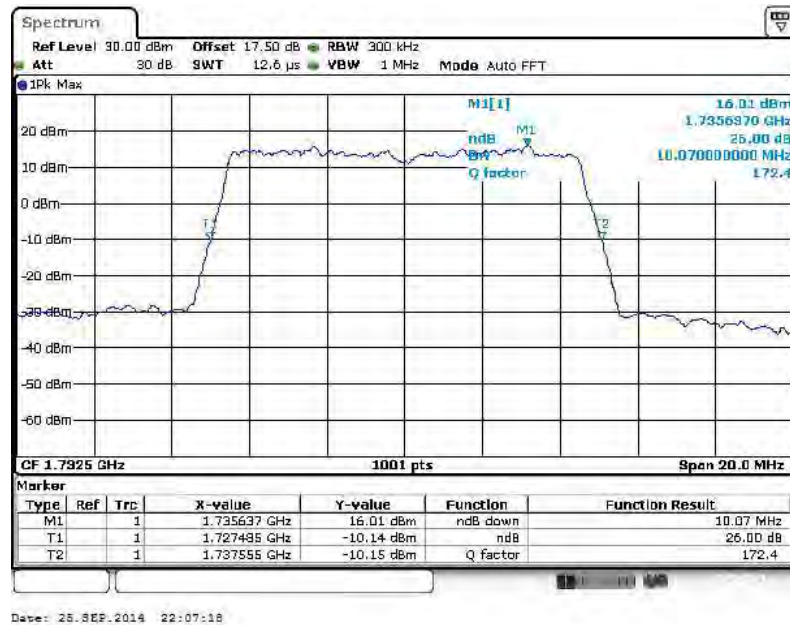



Band :	LTE Band 4	BW / Mod. :	10MHz / 16QAM
--------	------------	-------------	---------------

99% Occupied Bandwidth Plot on Channel 20175

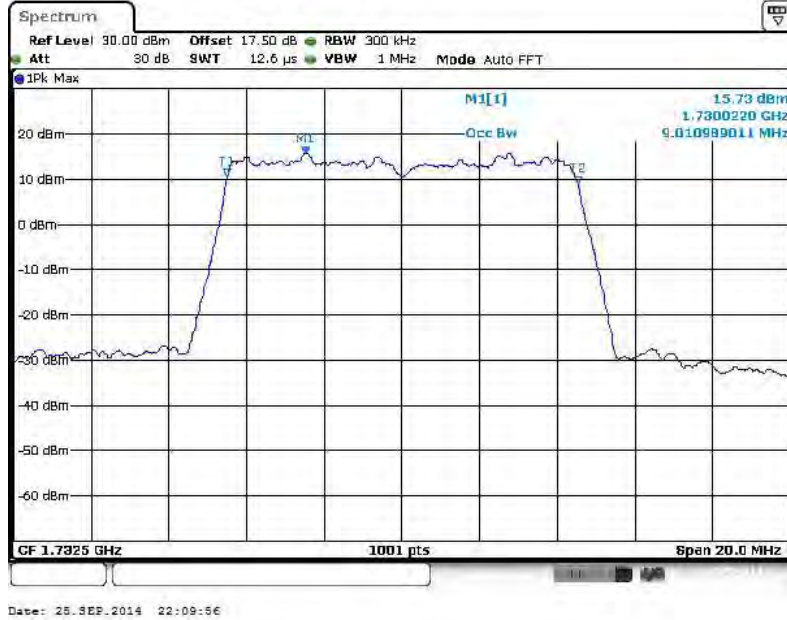

26dB Bandwidth Plot on Channel 20175

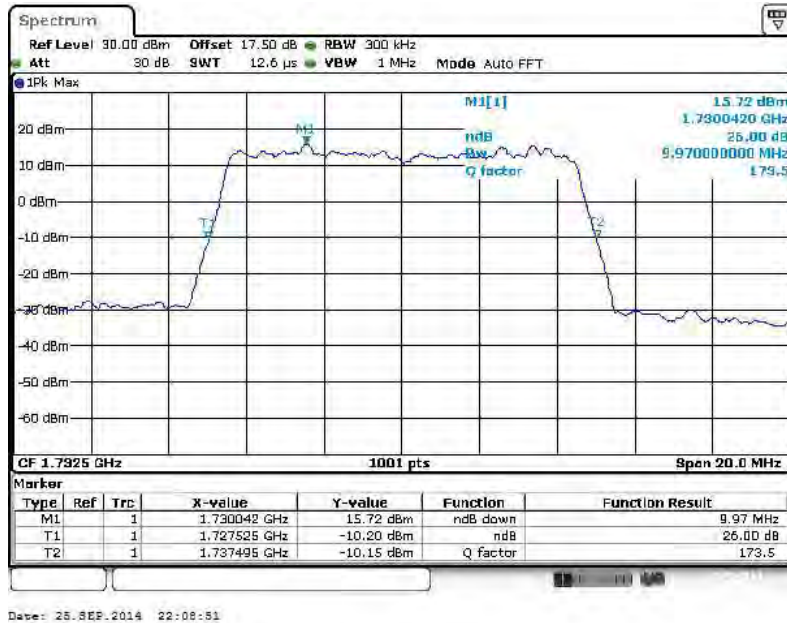



Band :	LTE Band 4	BW / Mod. :	15MHz / QPSK
--------	------------	-------------	--------------

99% Occupied Bandwidth Plot on Channel 20175

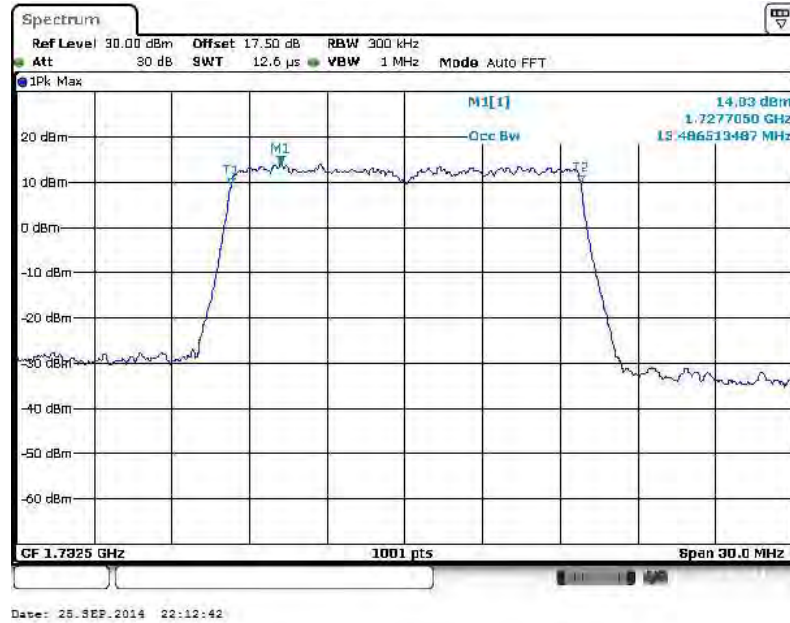

26dB Bandwidth Plot on Channel 20175

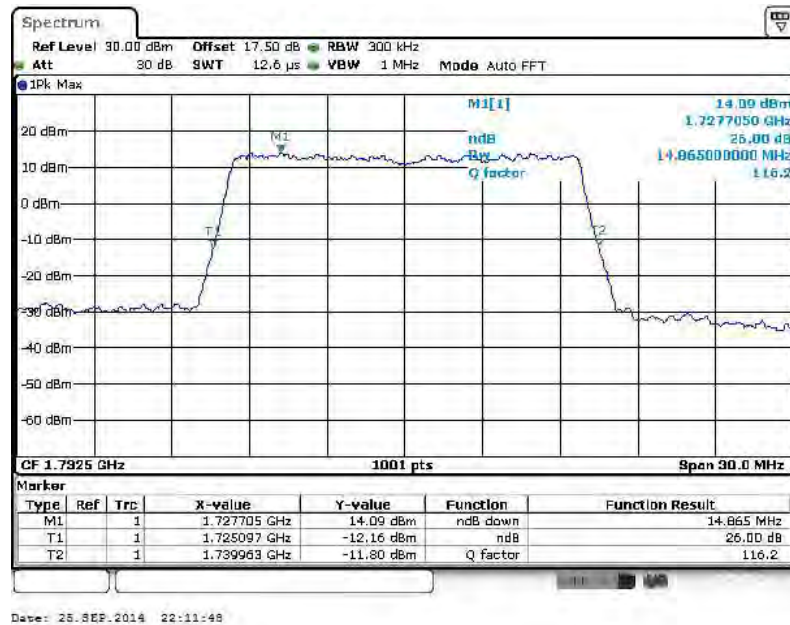



Band :	LTE Band 4	BW / Mod. :	15MHz / 16QAM
--------	------------	-------------	---------------

99% Occupied Bandwidth Plot on Channel 20175

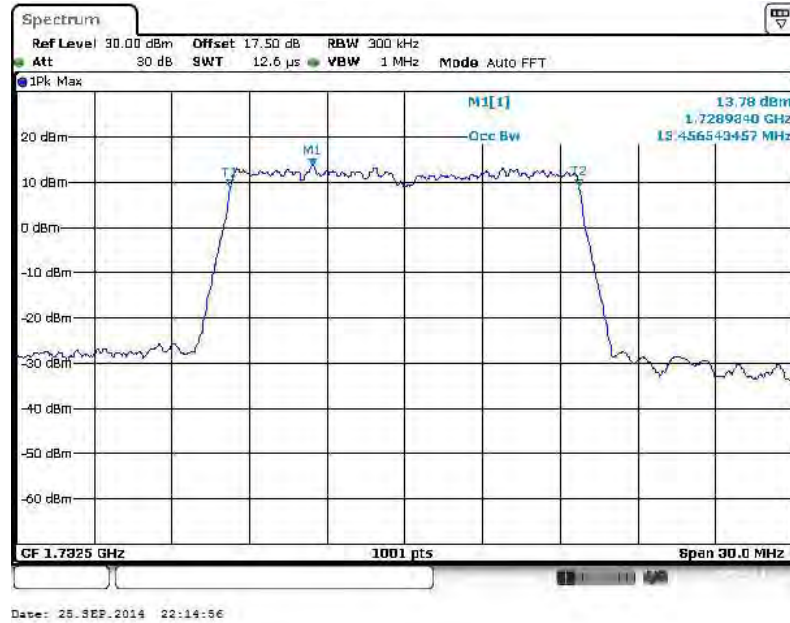

26dB Bandwidth Plot on Channel 20175

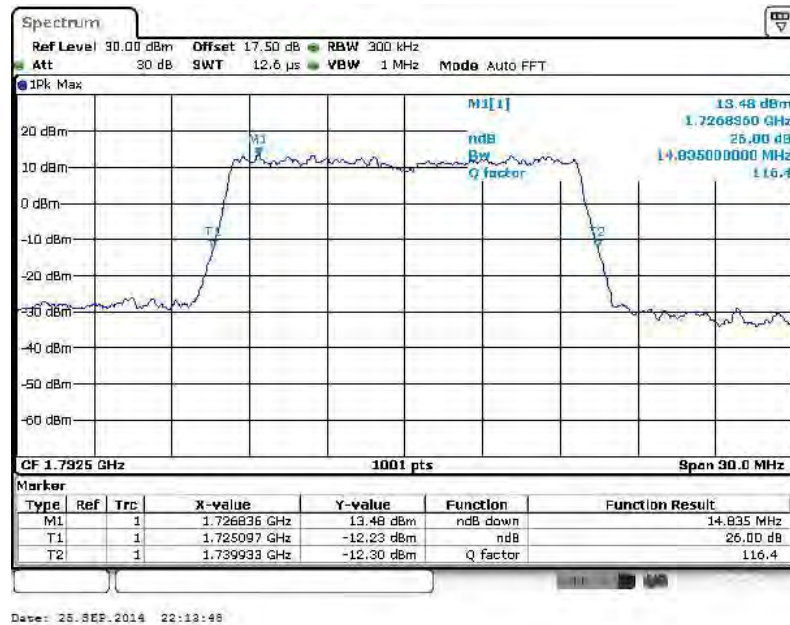



Band :	LTE Band 4	BW / Mod. :	20MHz / QPSK
--------	------------	-------------	--------------

99% Occupied Bandwidth Plot on Channel 20175

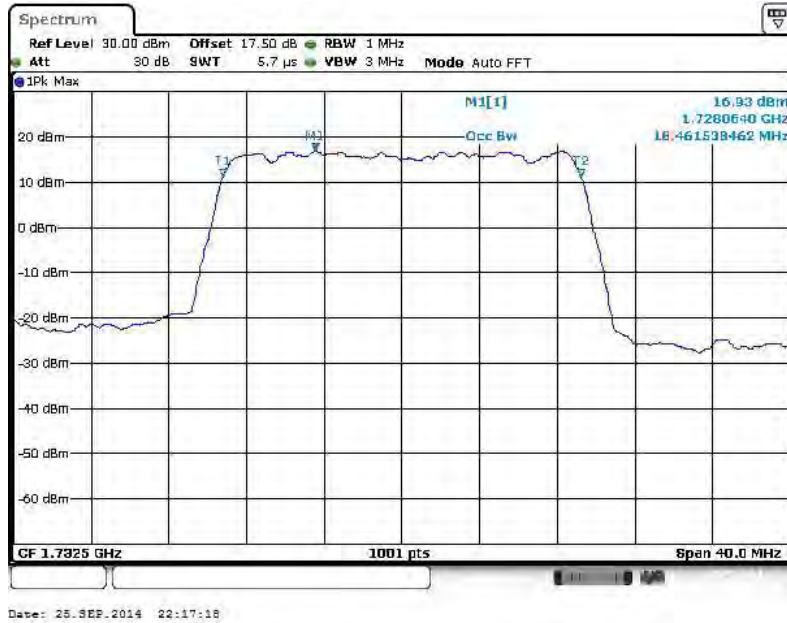

26dB Bandwidth Plot on Channel 20175

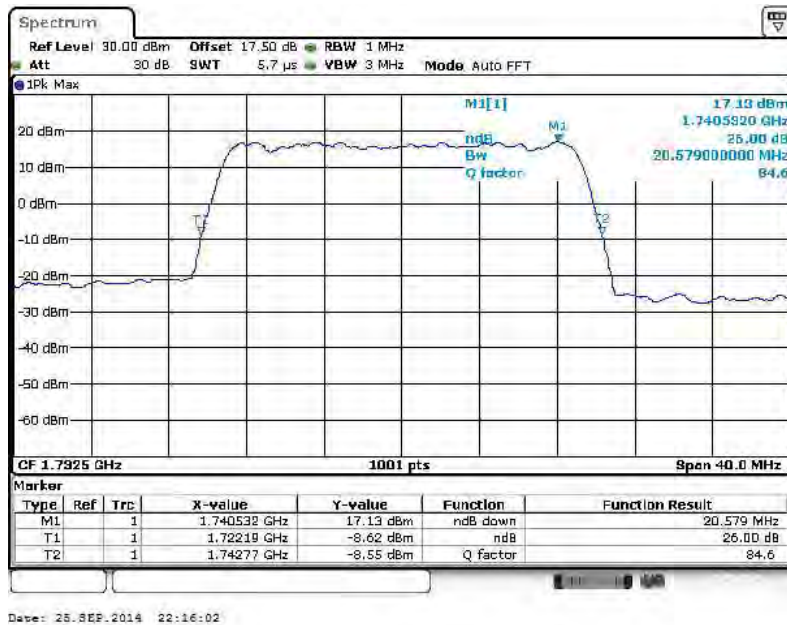



Band :	LTE Band 4	BW / Mod. :	20MHz / 16QAM
--------	------------	-------------	---------------

99% Occupied Bandwidth Plot on Channel 20175

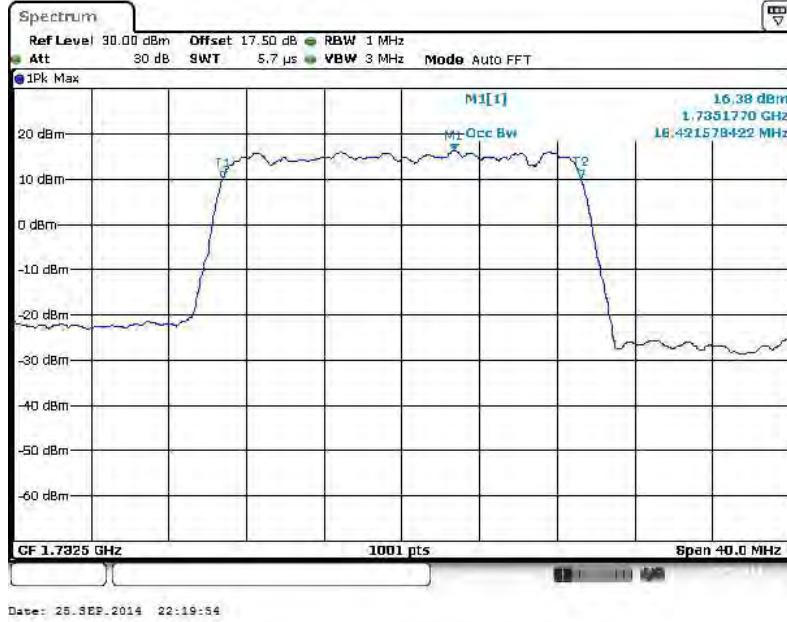

26dB Bandwidth Plot on Channel 20175

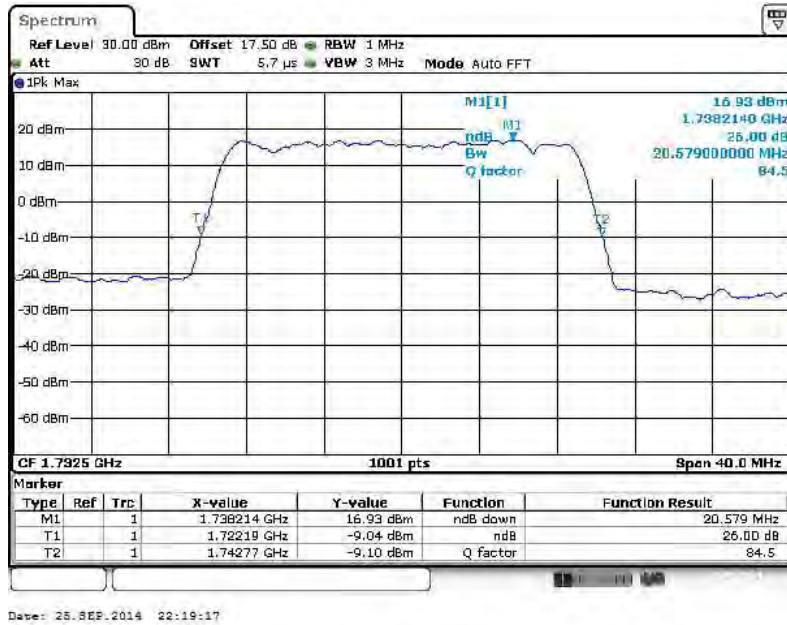



3.5 Conducted Band Edge Measurement

3.5.1 Description of Conducted Band Edge Measurement

24.238 (a)

For operations in the 1850-1910 and 1930-1990 MHz band, the FCC limit is $43 + 10\log_{10}(P[\text{Watts}])$ dB below the transmitter power $P(\text{Watts})$ in a 1MHz bandwidth. However, in the 1 MHz bands immediately outside and adjacent to the frequency block a resolution bandwidth of at least one percent of the emission bandwidth of the fundamental emission of the transmitter may be employed.

27.53 (h)

For operations in the 1710 – 1755 MHz band, the FCC limit is $43 + 10\log_{10}(P[\text{Watts}])$ dB below the transmitter power $P(\text{Watts})$ in a 1 MHz bandwidth. However, in the 1MHz bands immediately outside and adjacent to the licensee's frequency block, a resolution bandwidth of at least one percent of the emission bandwidth of the fundamental emission of the transmitter may be employed.

27.53 (m)(4)

For mobile digital stations, the attenuation factor shall be not less than $40 + 10 \log (P)$ dB on all frequencies between the channel edge and 5 megahertz from the channel edge, $43 + 10 \log (P)$ dB on all frequencies between 5 megahertz and X megahertz from the channel edge, and $55 + 10 \log (P)$ dB on all frequencies more than X megahertz from the channel edge, where X is the greater of 6 megahertz or the actual emission bandwidth as defined in paragraph (m)(6) of this section. In addition, the attenuation factor shall not be less that $43 + 10 \log (P)$ dB on all frequencies between 2490.5 MHz and 2496 MHz and $55 + 10 \log (P)$ dB at or below 2490.5 MHz. Mobile Satellite Service licensees operating on frequencies below 2495 MHz may also submit a documented interference complaint against BRS licensees operating on channel BRS Channel 1 on the same terms and conditions as adjacent channel BRS or EBS licensees.

3.5.2 Measuring Instruments

The measuring equipment is listed in the section 4 of this test report.

3.5.3 Test Procedures

1. The EUT was connected to spectrum analyzer and system simulator via a power divider.
2. The band edges of low and high channels for the highest RF powers were measured. Set RBW \geq 1% EBW in the 1MHz band immediately outside and adjacent to the band edge.
3. Set spectrum analyzer with RMS detector.
4. The RF fundamental frequency should be excluded against the limit line in the operating frequency band.
5. The limit line is derived from $43 + 10\log(P)$ dB below the transmitter power P(Watts)

$$= P(W) - [43 + 10\log(P)] \text{ (dB)}$$

$$= [30 + 10\log(P)] \text{ (dBm)} - [43 + 10\log(P)] \text{ (dB)}$$

$$= -13\text{dBm.}$$
 <For Band 7>

The limit line is derived from $55 + 10\log(P)$ dB below the transmitter power P(Watts)

$$= P(W) - [55 + 10\log(P)] \text{ (dB)}$$

$$= [30 + 10\log(P)] \text{ (dBm)} - [55 + 10\log(P)] \text{ (dB)}$$

$$= -25\text{dBm.}$$

3.5.4 Test Setup

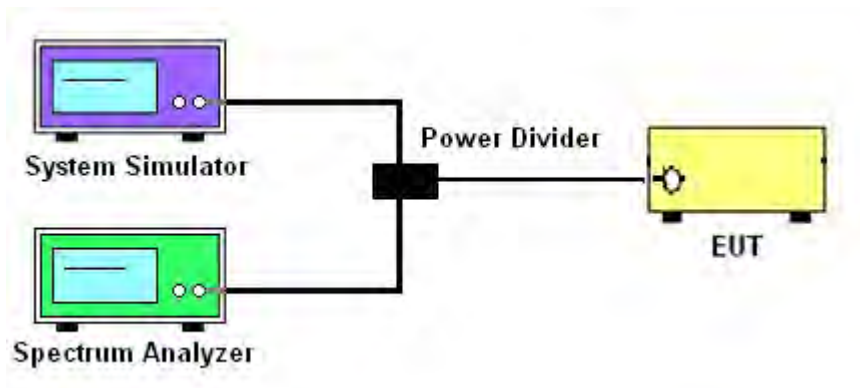



3.5.5 Test Result (Plots) of Conducted Band Edge

Band :	LTE Band 7	Band Width :	5MHz / QPSK
--------	------------	--------------	-------------

Lower Band Edge Plot for QPSK-RB Size 1, RB Offset 0

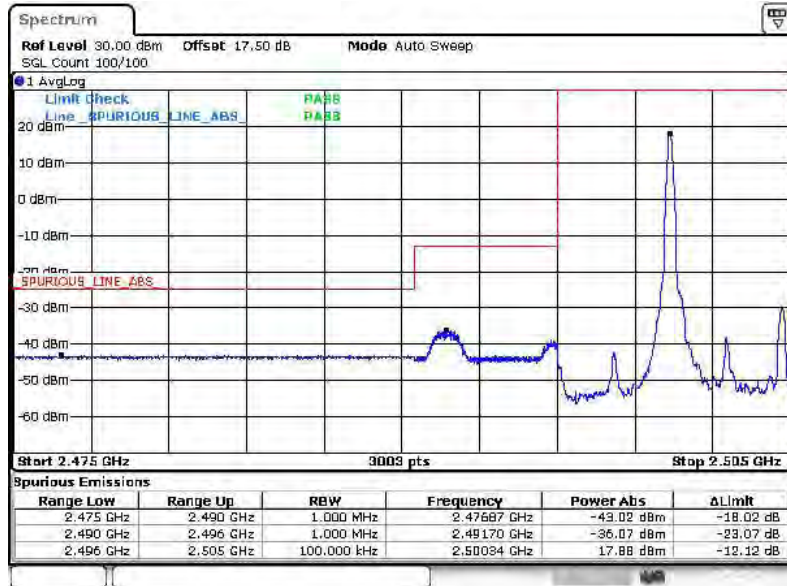

Date: 25 SEP. 2014 16:52:24

Lower Band Edge Plot for QPSK-RB Size 25, RB Offset 0

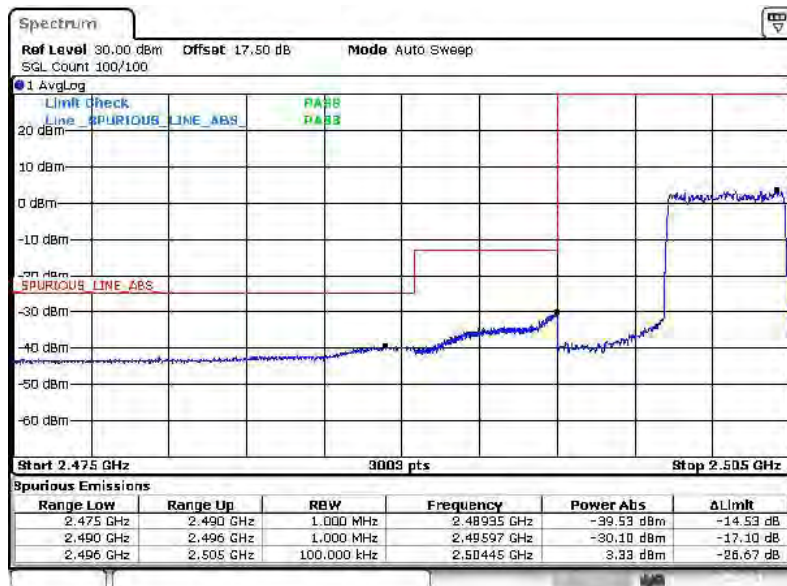

Date: 25 SEP. 2014 16:50:31



Higher Band Edge Plot for QPSK-RB Size 1, RB Offset 24

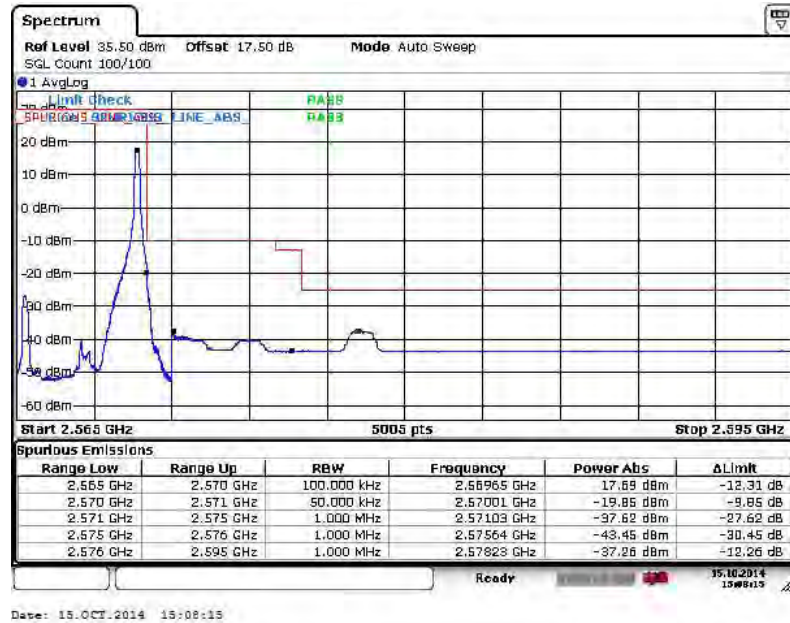

Higher Band Edge Plot for QPSK-RB Size 25, RB Offset 0

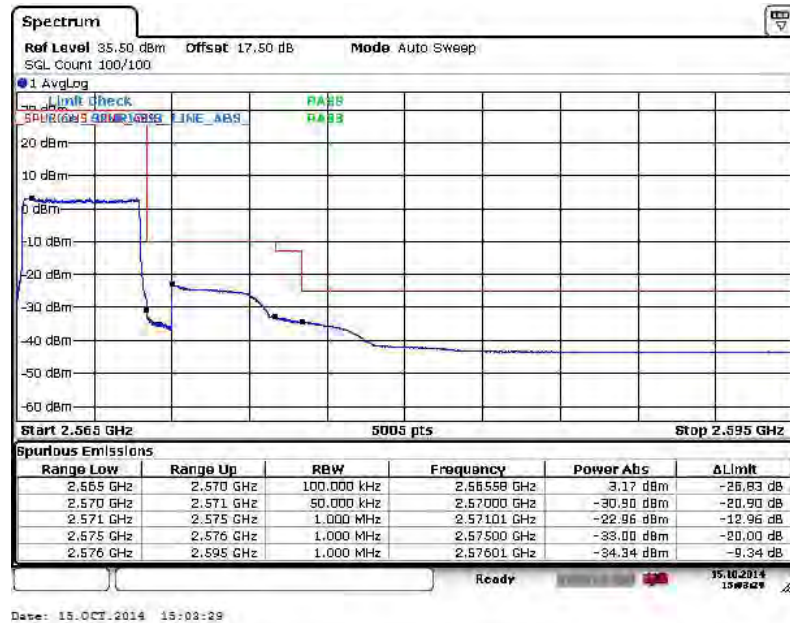



Band :	LTE Band 7	Band Width :	5MHz / 16QAM
---------------	------------	---------------------	--------------

Lower Band Edge Plot for 16QAM-RB Size 1, RB Offset 0

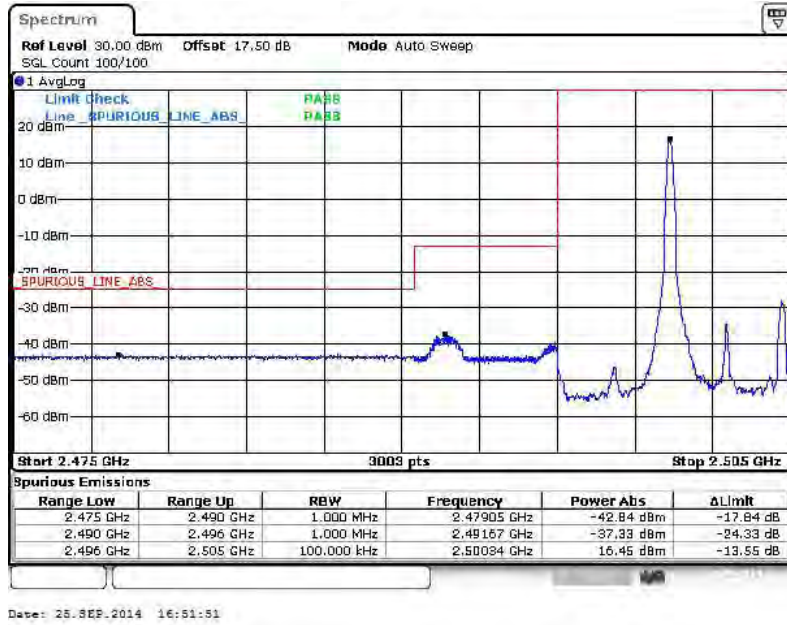

Lower Band Edge Plot for 16QAM-RB Size 25, RB Offset 0

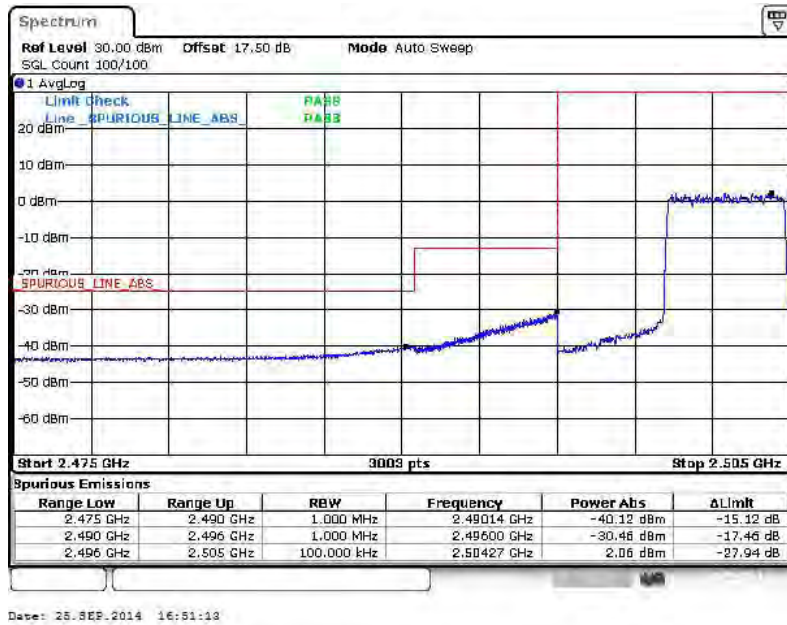



Higher Band Edge Plot for 16QAM-RB Size 1, RB Offset 24

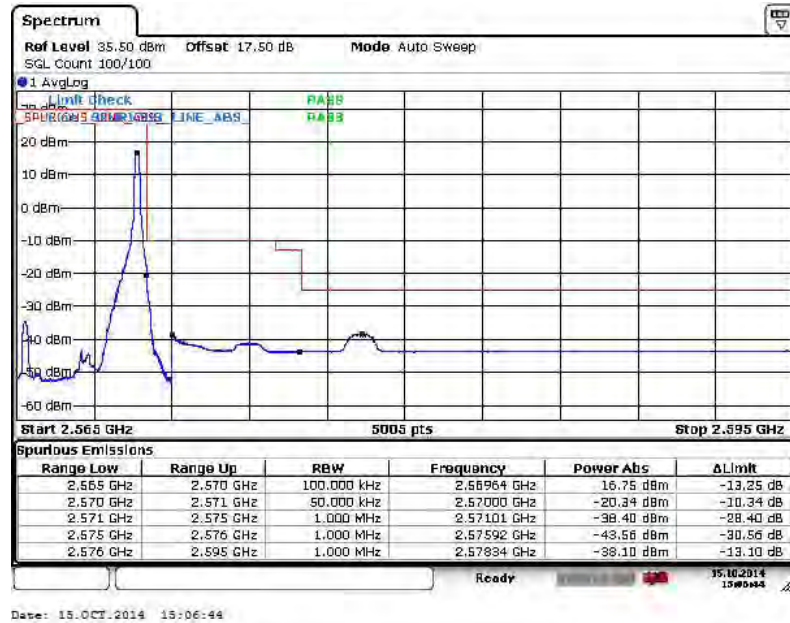

Higher Band Edge Plot for 16QAM-RB Size 25, RB Offset 0

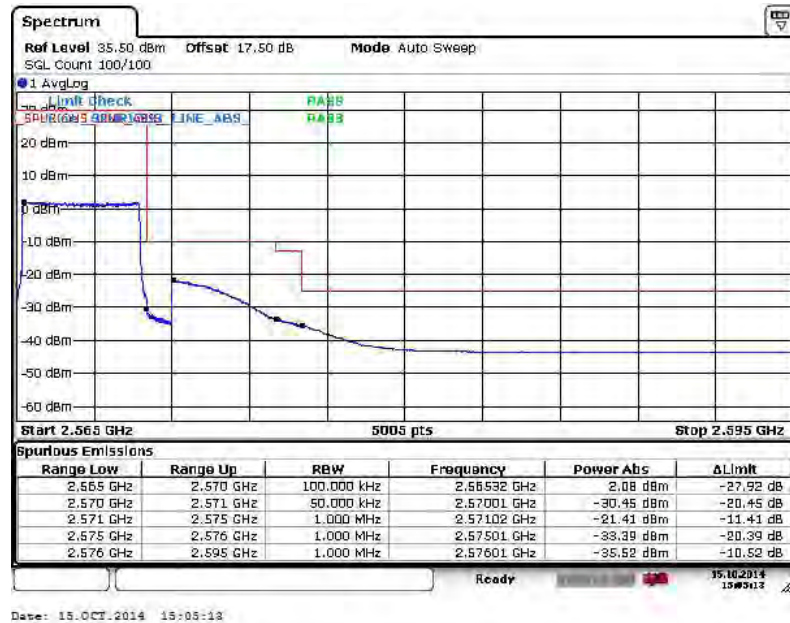



Band :	LTE Band 7	Band Width :	10MHz / QPSK
---------------	------------	---------------------	--------------

Lower Band Edge Plot for QPSK-RB Size 1, RB Offset 0

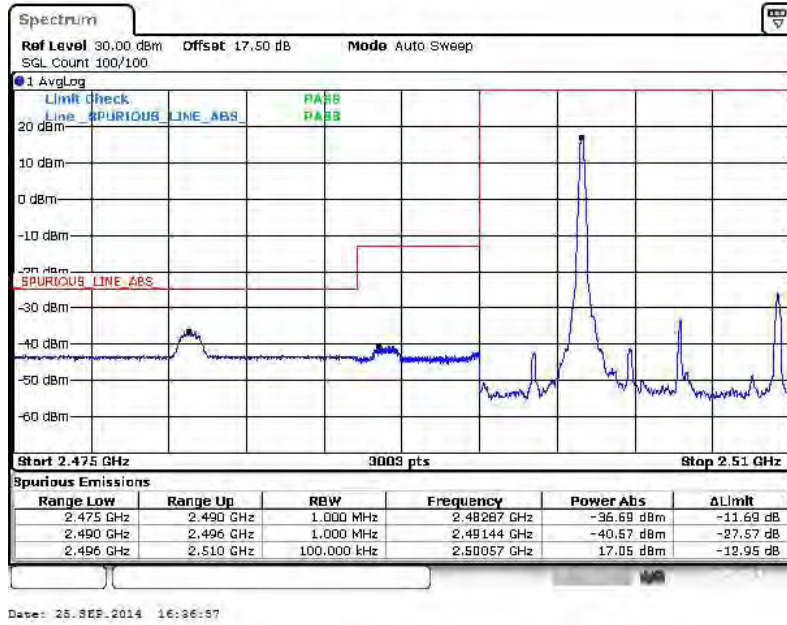

Lower Band Edge Plot for QPSK-RB Size 50, RB Offset 0

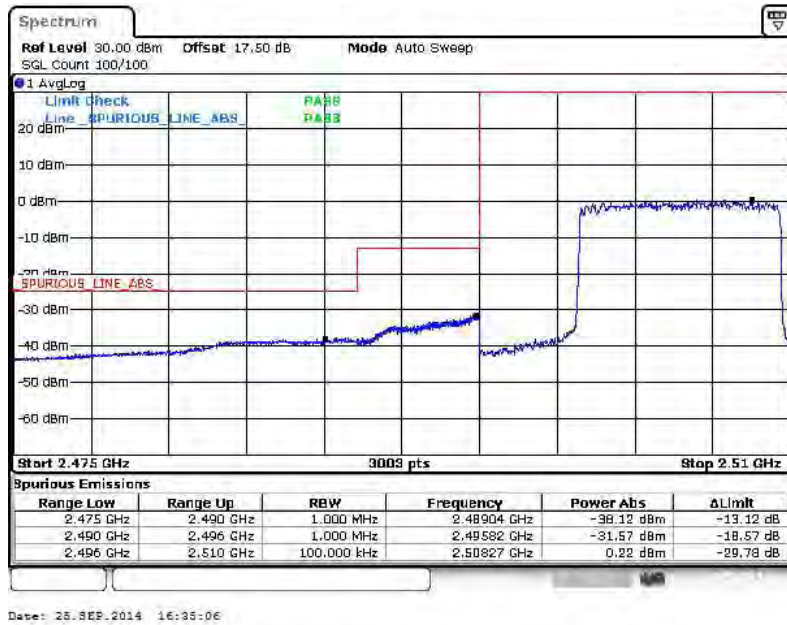



Higher Band Edge Plot for QPSK-RB Size 1, RB Offset 49

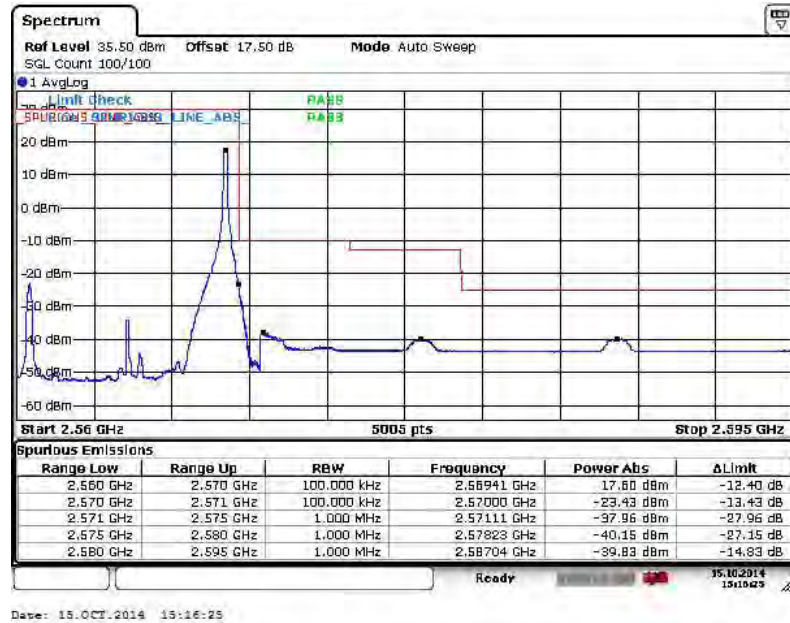

Higher Band Edge Plot for QPSK-RB Size 50, RB Offset 0

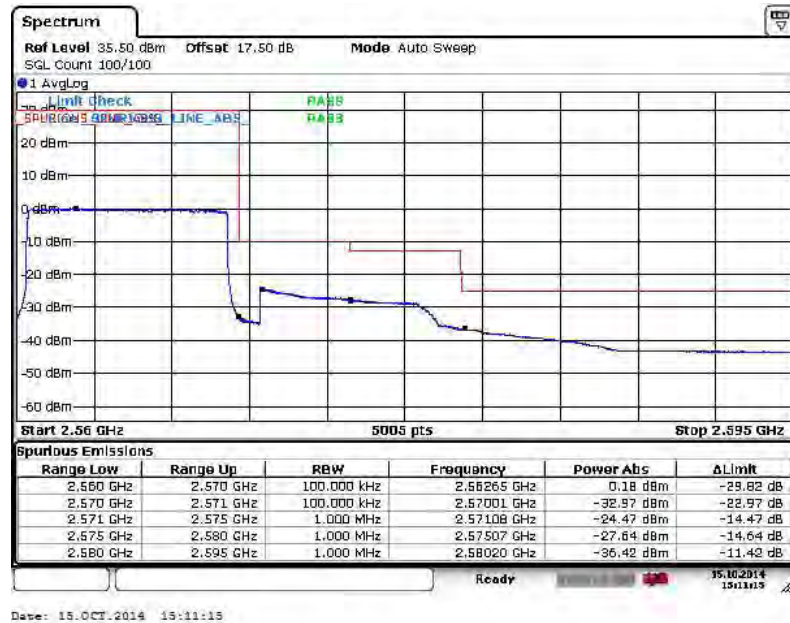



Band :	LTE Band 7	Band Width :	10MHz / 16QAM
--------	------------	--------------	---------------

Lower Band Edge Plot for 16QAM-RB Size 1, RB Offset 0

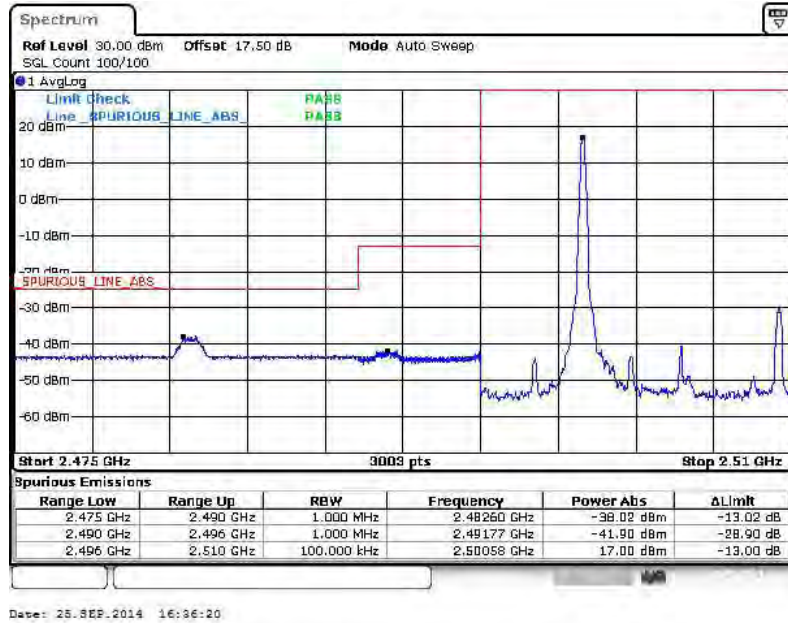

Lower Band Edge Plot for 16QAM-RB Size 50, RB Offset 0

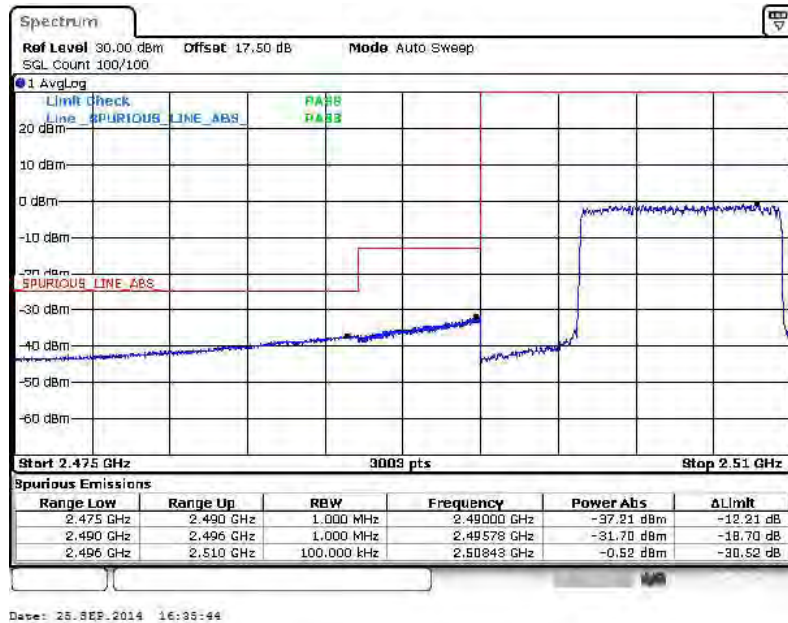



Higher Band Edge Plot for 16QAM-RB Size 1, RB Offset 49

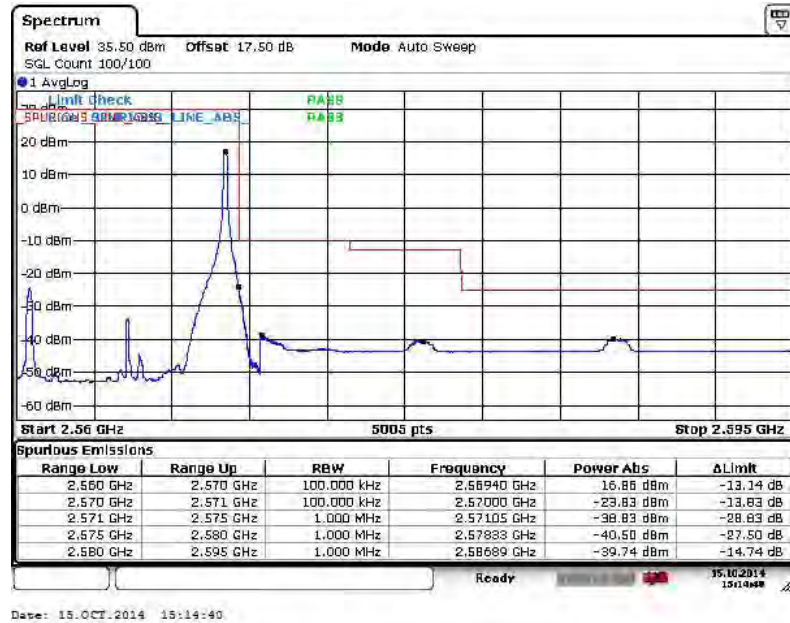

Higher Band Edge Plot for 16QAM-RB Size 50, RB Offset 0

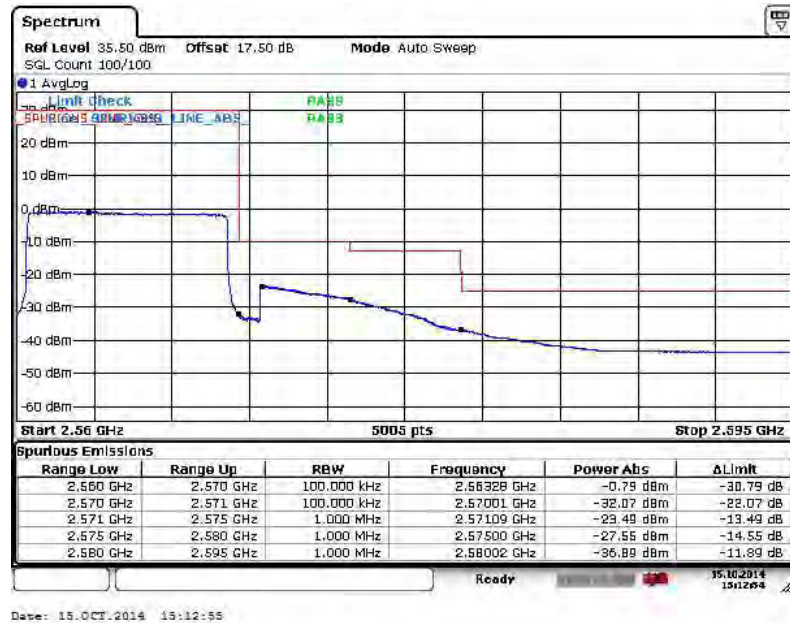



Band :	LTE Band 7	Band Width :	15MHz / QPSK
---------------	------------	---------------------	--------------

Lower Band Edge Plot for QPSK-RB Size 1, RB Offset 0

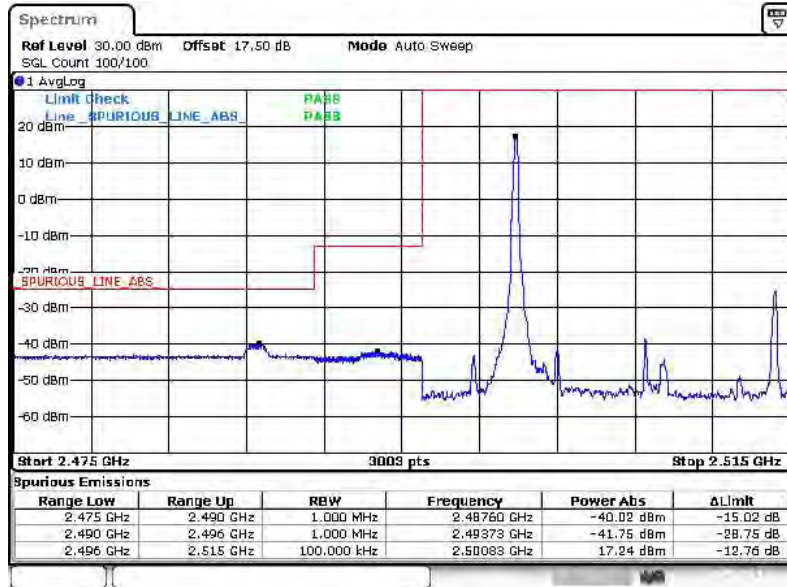

Date: 25. SEP. 2014 16:27:43

Lower Band Edge Plot for QPSK-RB Size 75, RB Offset 0

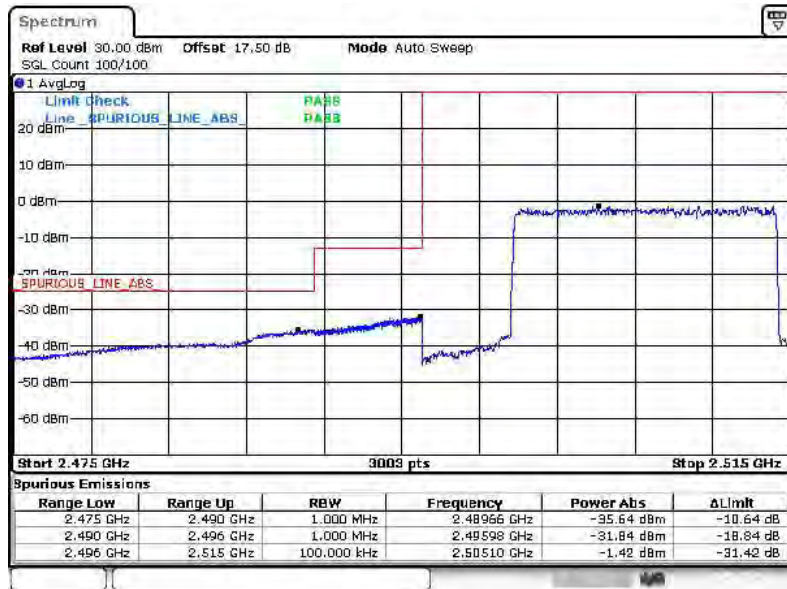

Date: 25. SEP. 2014 16:30:24



Higher Band Edge Plot for QPSK-RB Size 1, RB Offset 74

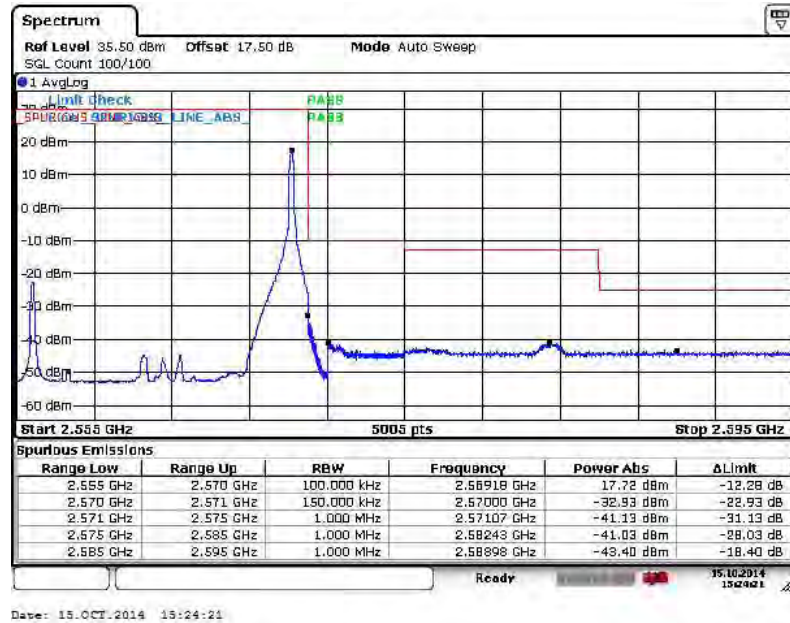

Higher Band Edge Plot for QPSK-RB Size 75, RB Offset 0

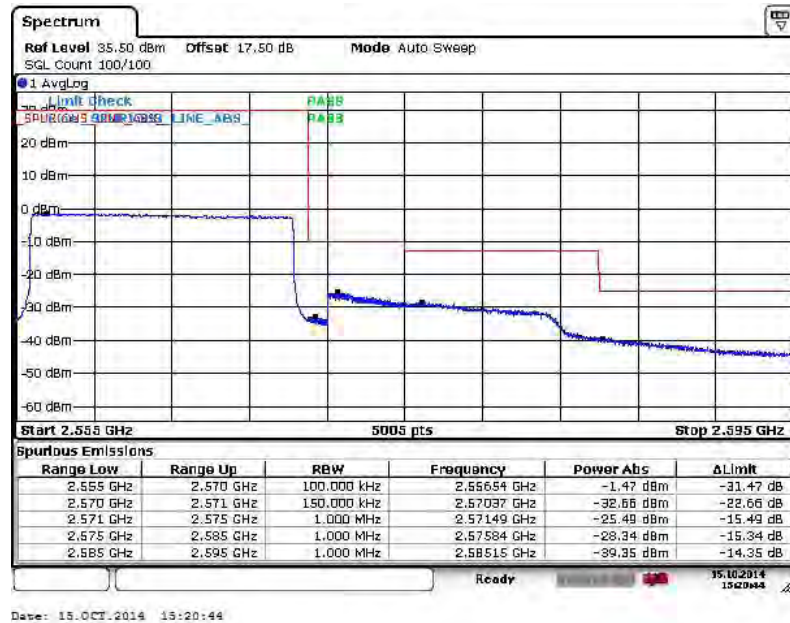



Band :	LTE Band 7	Band Width :	15MHz / 16QAM
--------	------------	--------------	---------------

Lower Band Edge Plot for 16QAM-RB Size 1, RB Offset 0

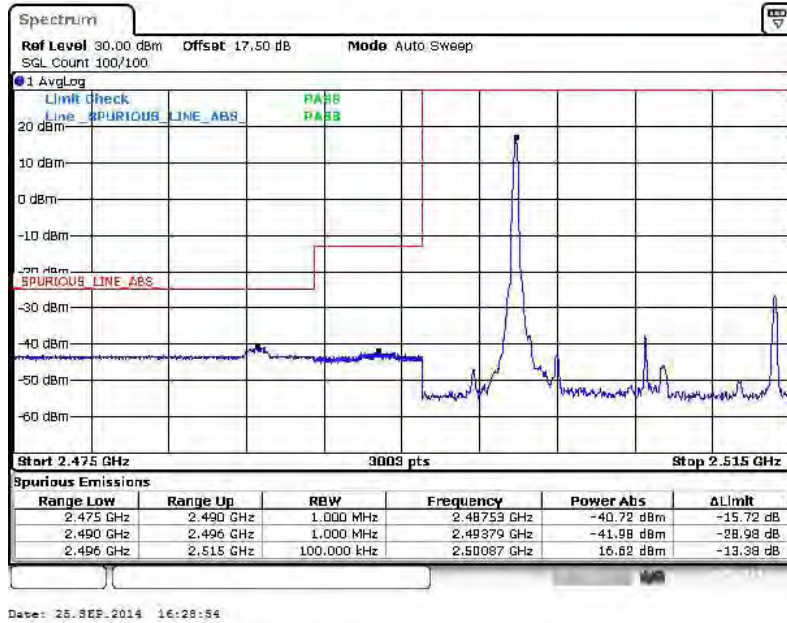

Lower Band Edge Plot for 16QAM-RB Size 75, RB Offset 0

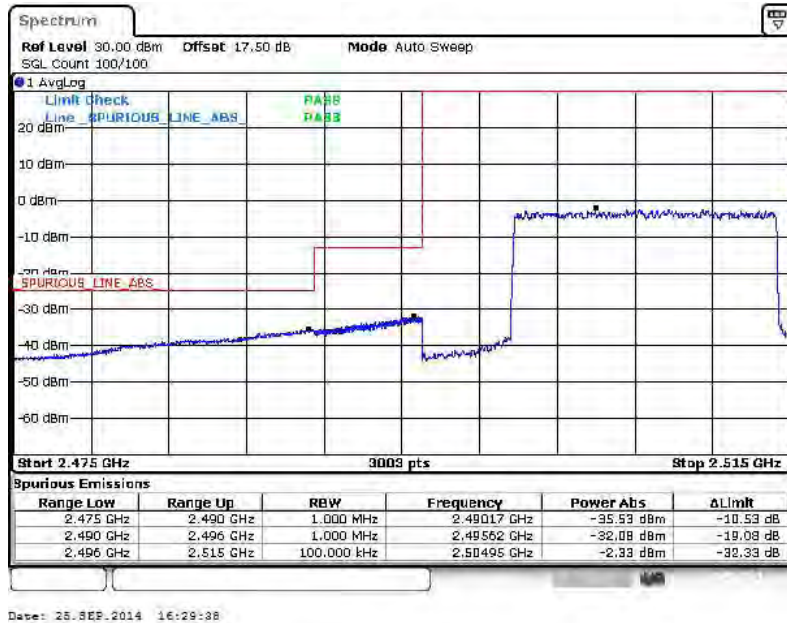



Higher Band Edge Plot for 16QAM-RB Size 1, RB Offset 74

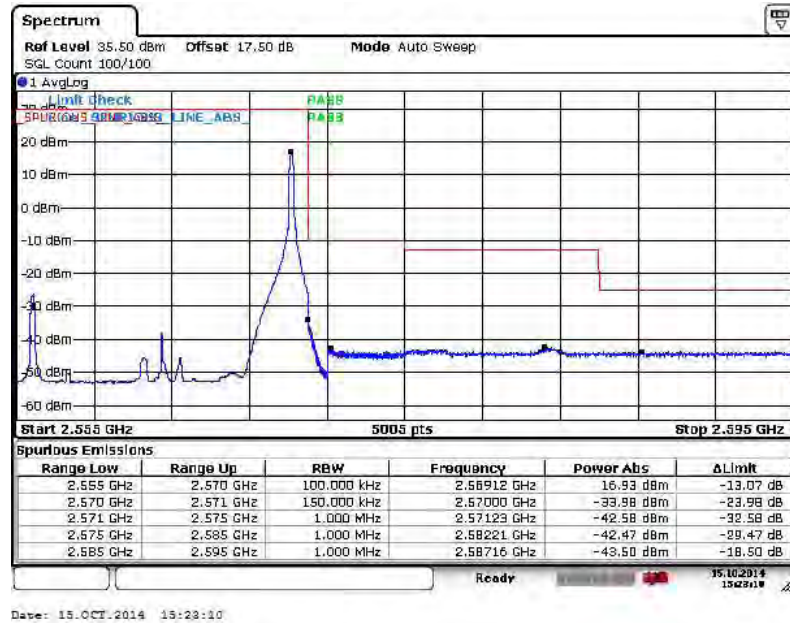

Higher Band Edge Plot for 16QAM-RB Size 75, RB Offset 0

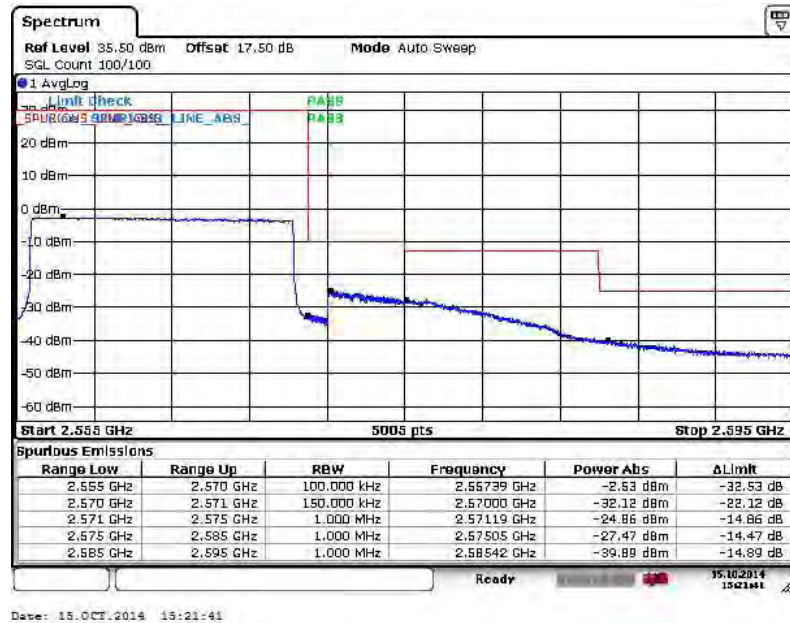



Band :	LTE Band 7	Band Width :	20MHz / QPSK
--------	------------	--------------	--------------

Lower Band Edge Plot for QPSK-RB Size 1, RB Offset 0

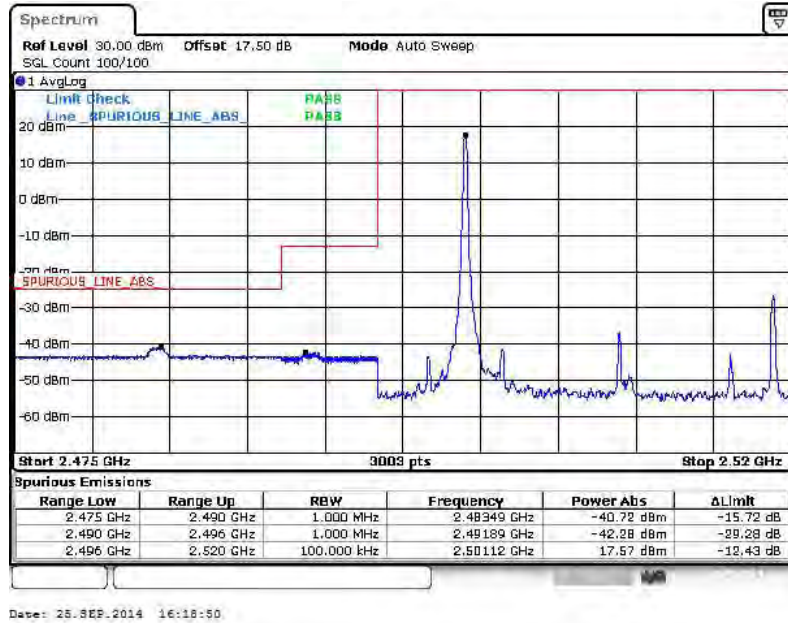

Lower Band Edge Plot for QPSK-RB Size 100, RB Offset 0

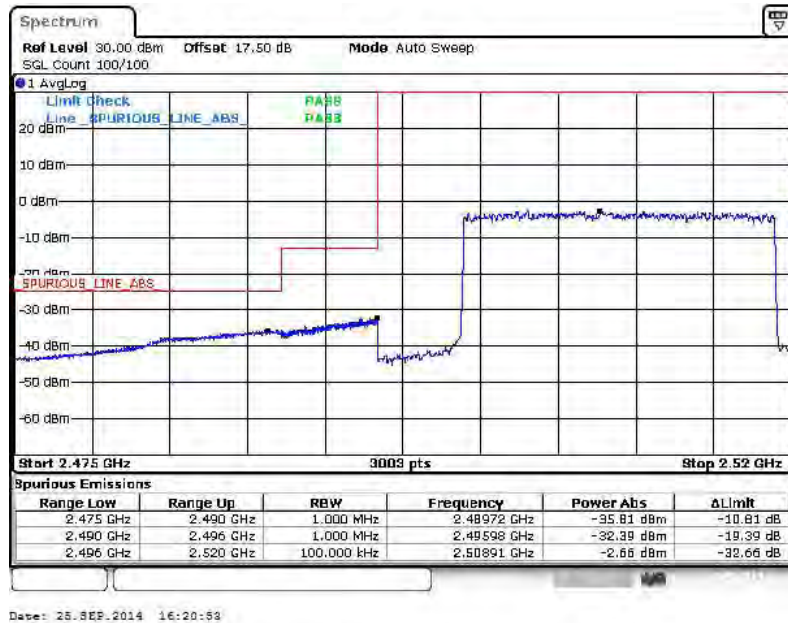



Higher Band Edge Plot for QPSK-RB Size 1, RB Offset 99

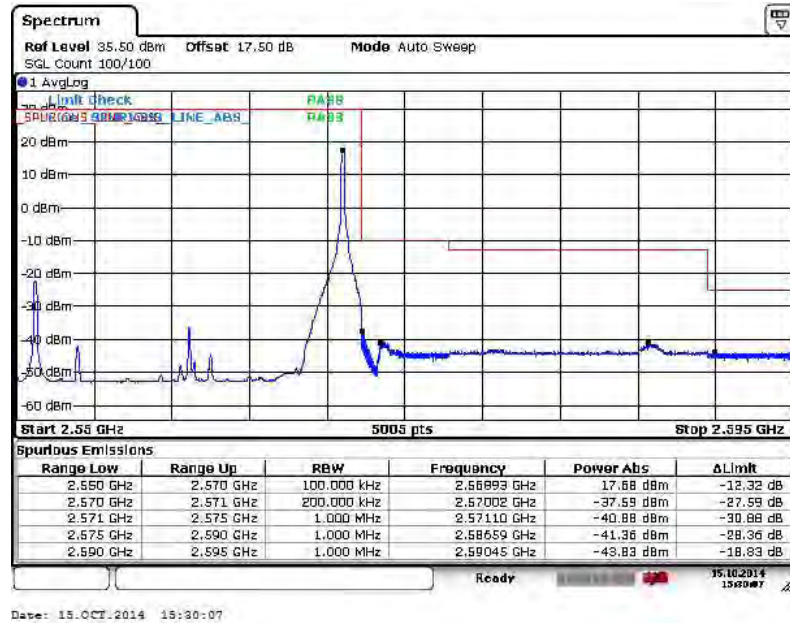

Higher Band Edge Plot for QPSK-RB Size 100, RB Offset 0

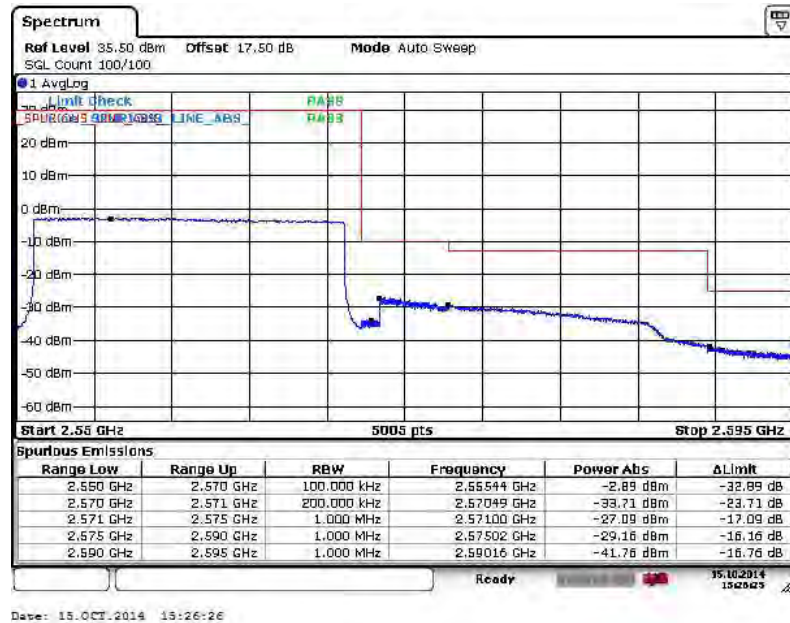



Band :	LTE Band 7	Band Width :	20MHz / 16QAM
---------------	------------	---------------------	---------------

Lower Band Edge Plot for 16QAM-RB Size 1, RB Offset 0

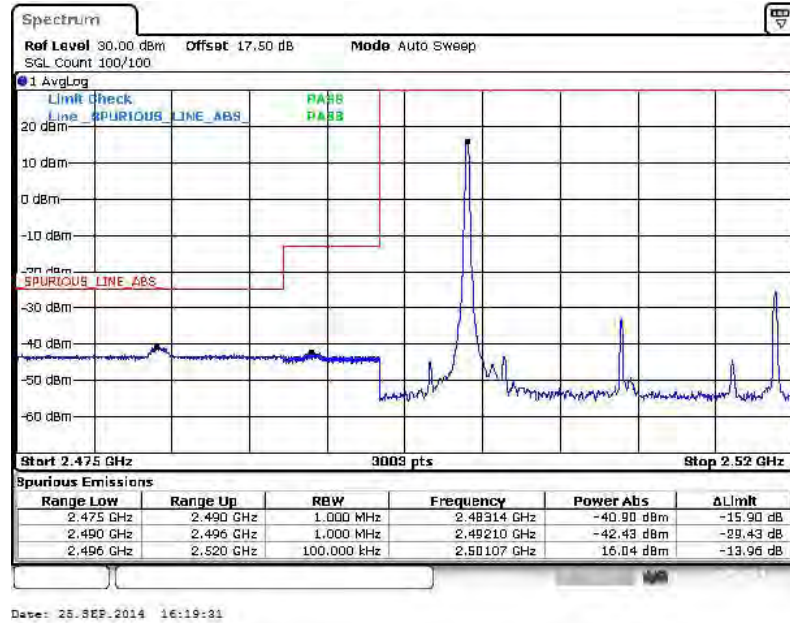

Lower Band Edge Plot for 16QAM-RB Size 100, RB Offset 0

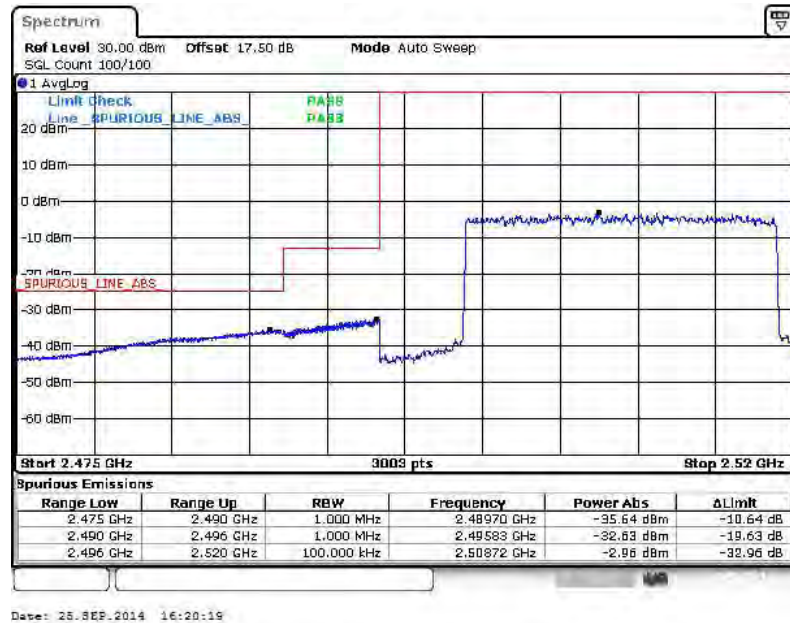



Higher Band Edge Plot for 16QAM-RB Size 1, RB Offset 99

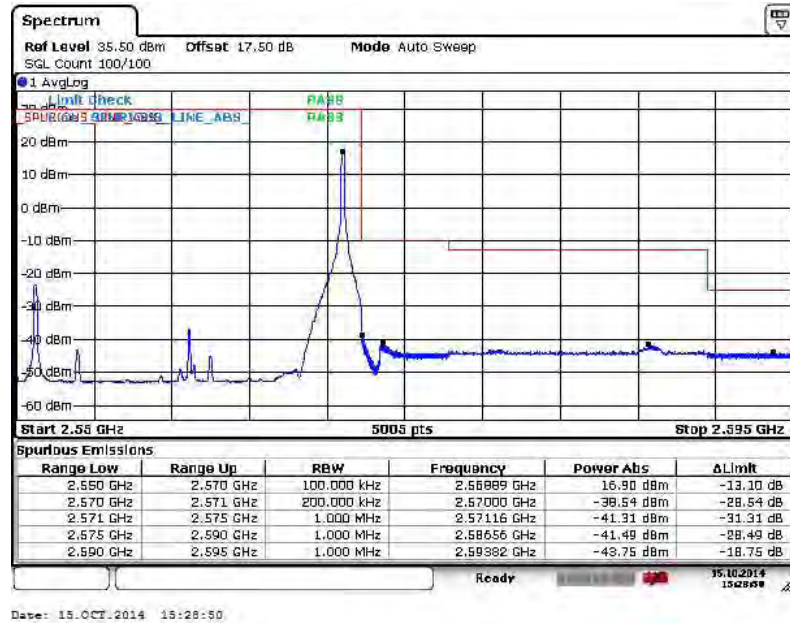

Higher Band Edge Plot for 16QAM-RB Size 100, RB Offset 0

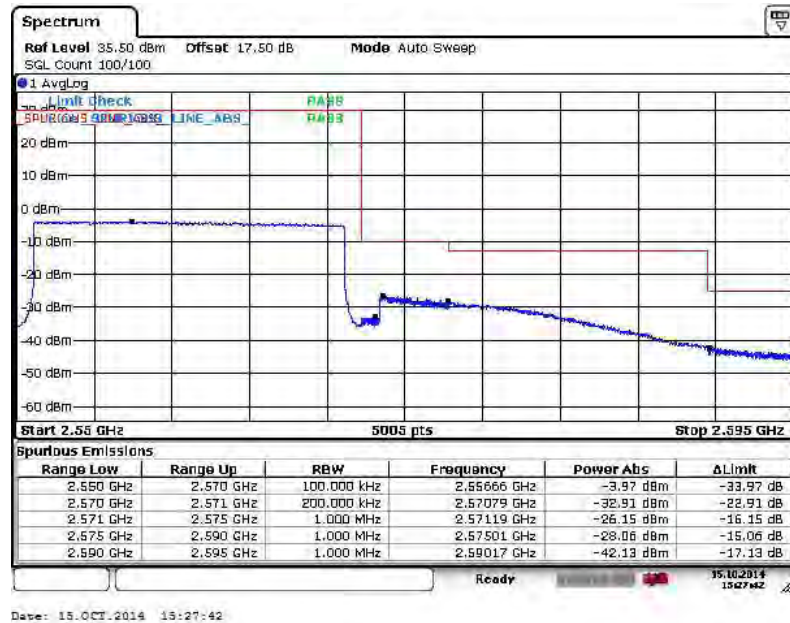



Band :	LTE Band 2	Band Width :	1.4MHz / QPSK
--------	------------	--------------	---------------

Lower Band Edge Plot for QPSK-RB Size 1, RB Offset 0



Lower Band Edge Plot for QPSK-RB Size 6, RB Offset 0





Higher Band Edge Plot for QPSK-RB Size 1, RB Offset 5

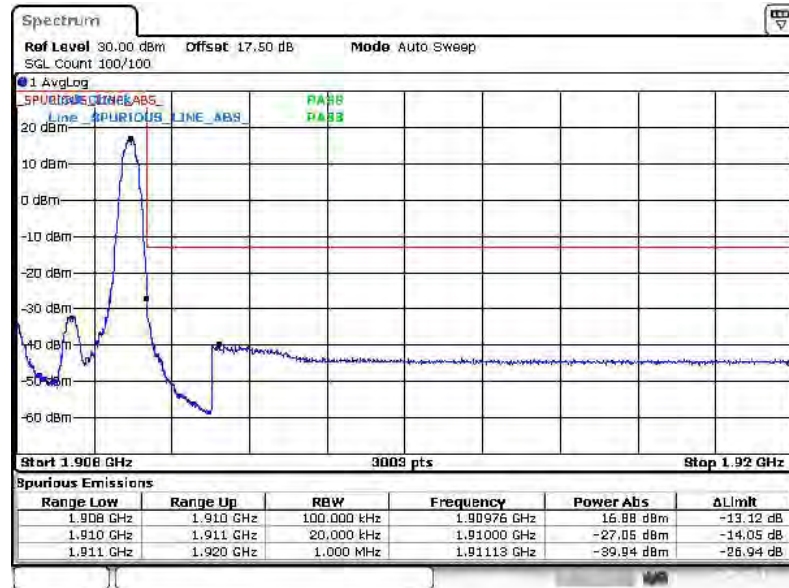

Date: 25-SEP-2014 18:27:11

Higher Band Edge Plot for QPSK-RB Size 6, RB Offset 0

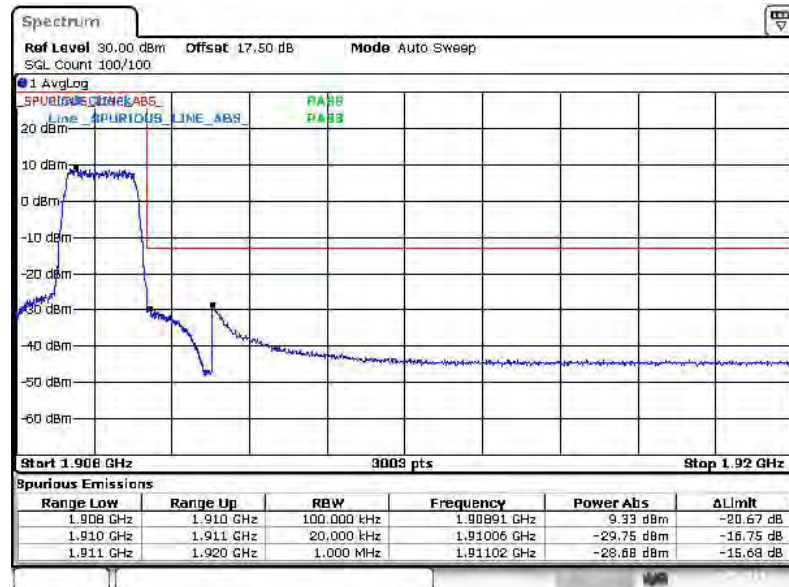

Date: 25-SEP-2014 18:29:00



Band :	LTE Band 2	Band Width :	1.4MHz / 16QAM
--------	------------	--------------	----------------

Lower Band Edge Plot for 16QAM -RB Size 1, RB Offset 0

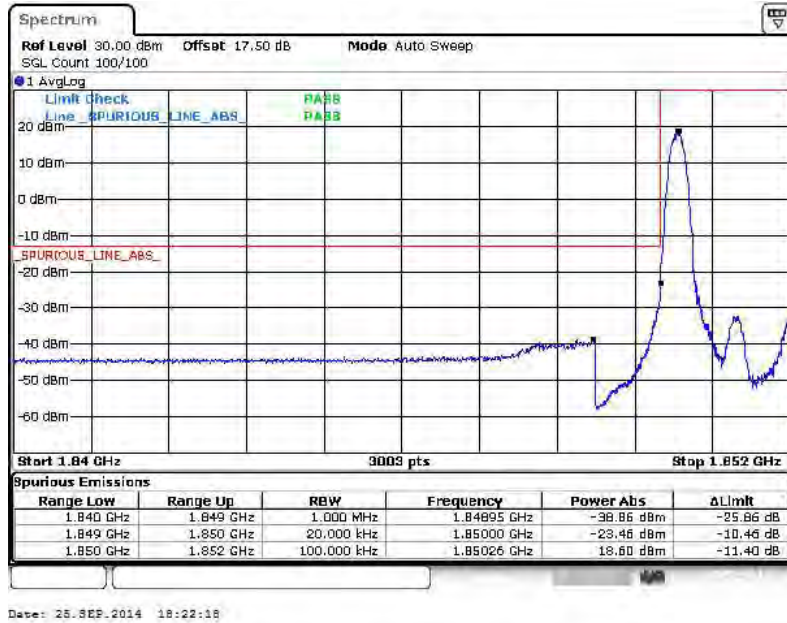

Lower Band Edge Plot for 16QAM -RB Size 6, RB Offset 0

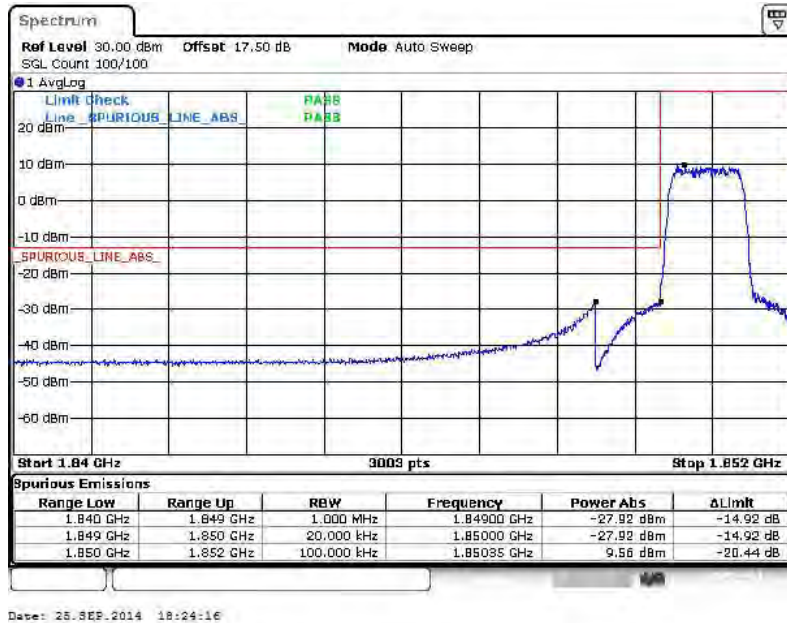



Higher Band Edge Plot for 16QAM -RB Size 1, RB Offset 5

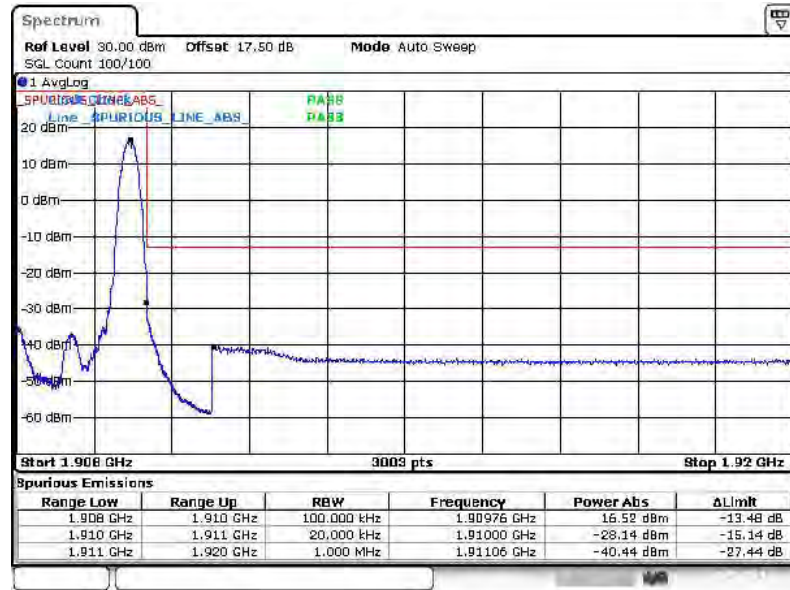

Date: 25-SEP-2014 18:30:27

Higher Band Edge Plot for 16QAM -RB Size 6, RB Offset 0



Date: 25-SEP-2014 18:33:01



Band :	LTE Band 2	Band Width :	3MHz / QPSK
--------	------------	--------------	-------------

Lower Band Edge Plot for QPSK-RB Size 1, RB Offset 0

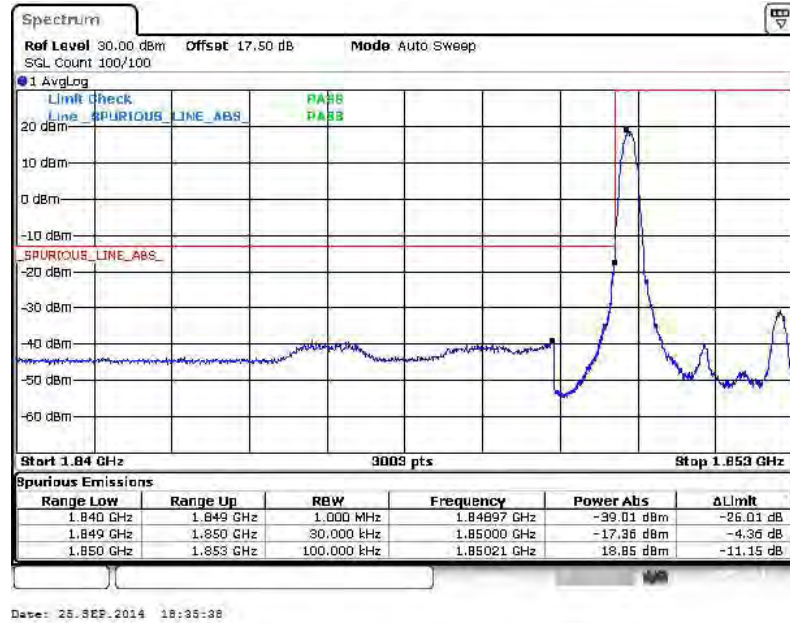

Lower Band Edge Plot for QPSK-RB Size 15, RB Offset 0

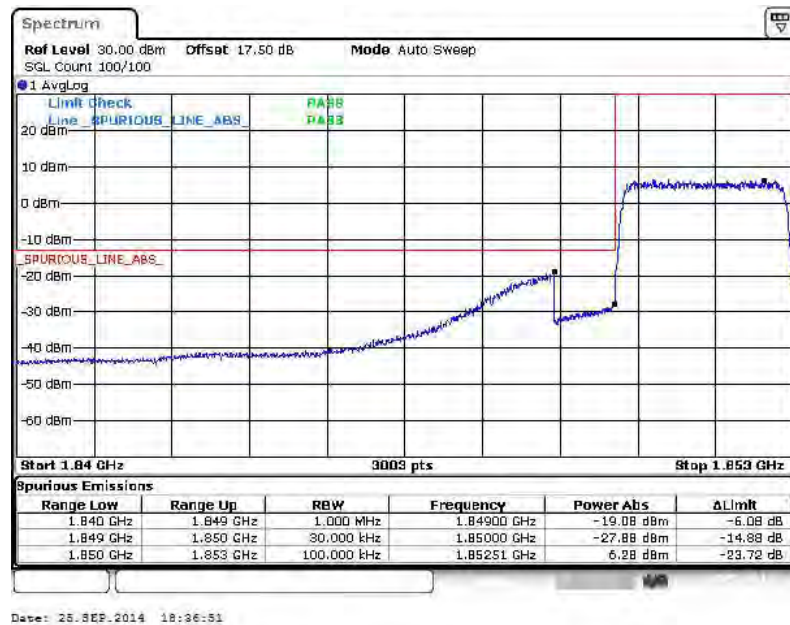



Higher Band Edge Plot for QPSK-RB Size 1, RB Offset 14

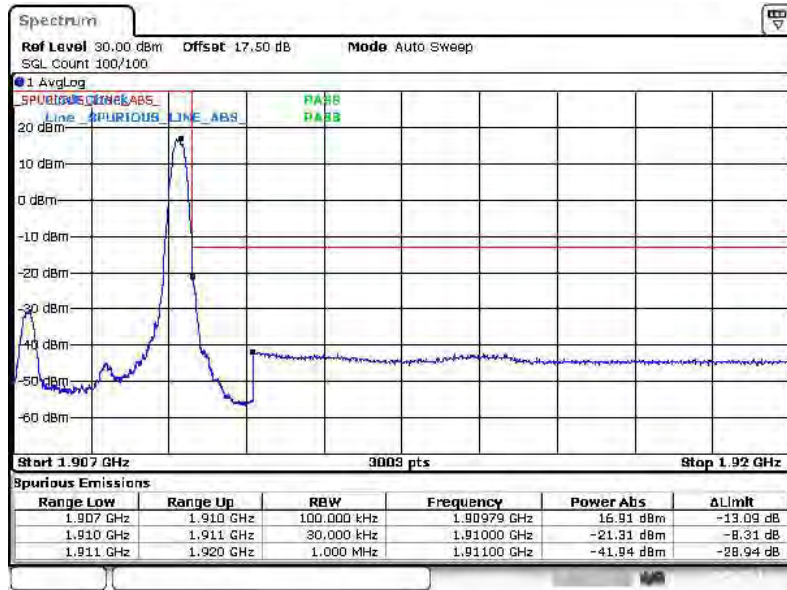

Date: 25-SEP-2014 18:38:10

Higher Band Edge Plot for QPSK-RB Size 15, RB Offset 0

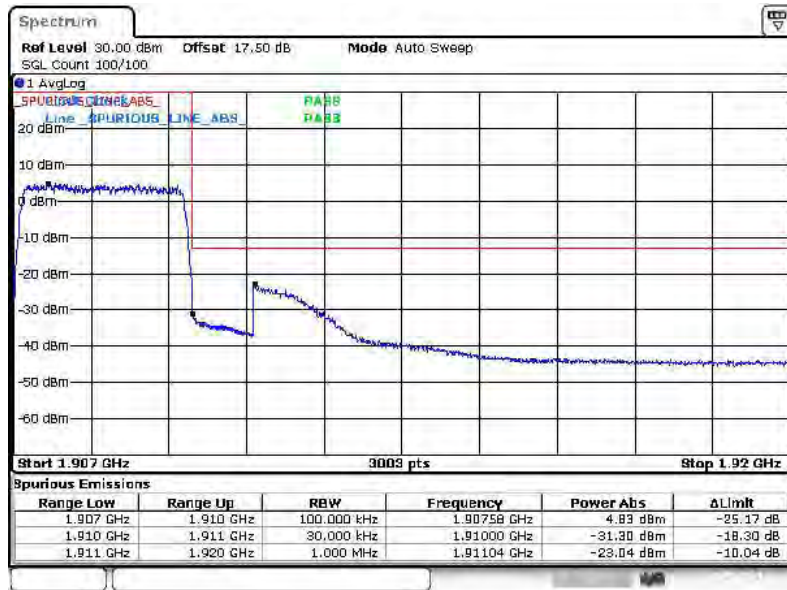

Date: 25-SEP-2014 18:39:30



Band :	LTE Band 2	Band Width :	3MHz / 16QAM
--------	------------	--------------	--------------

Lower Band Edge Plot for 16QAM -RB Size 1, RB Offset 0

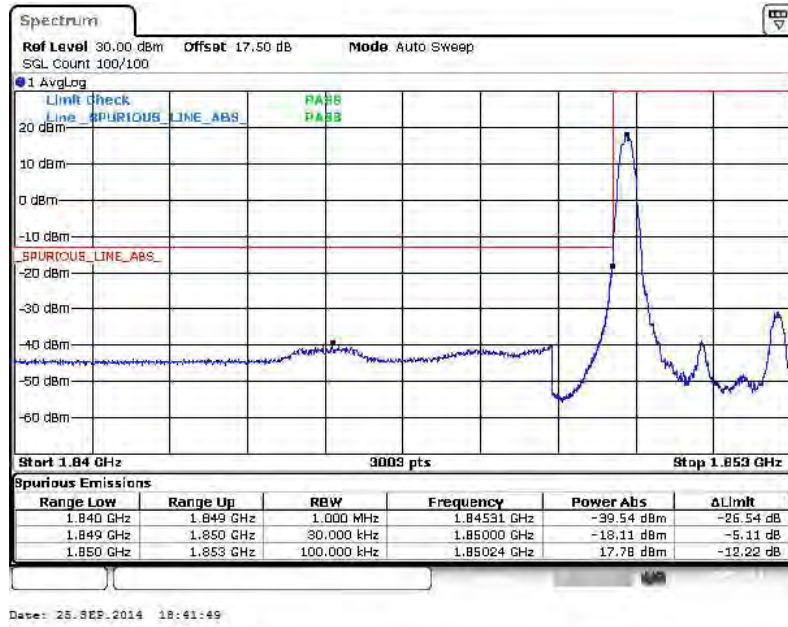

Lower Band Edge Plot for 16QAM -RB Size 15, RB Offset 0

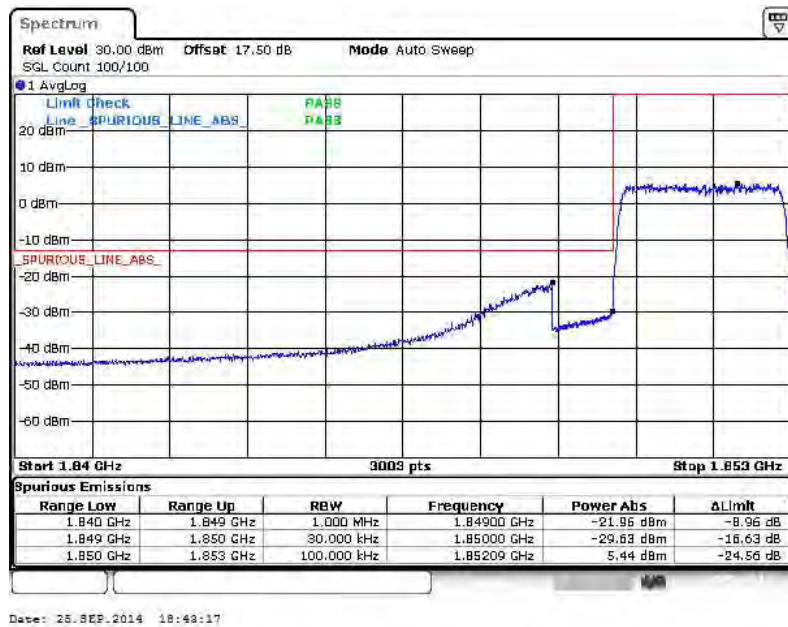



Higher Band Edge Plot for 16QAM -RB Size 1, RB Offset 14

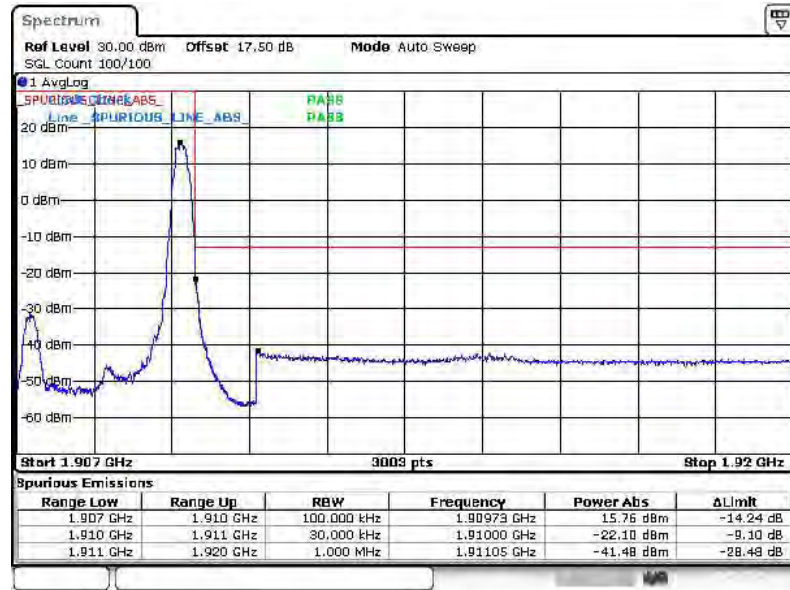

Date: 25-SEP-2014 18:44:55

Higher Band Edge Plot for 16QAM -RB Size 15, RB Offset 0

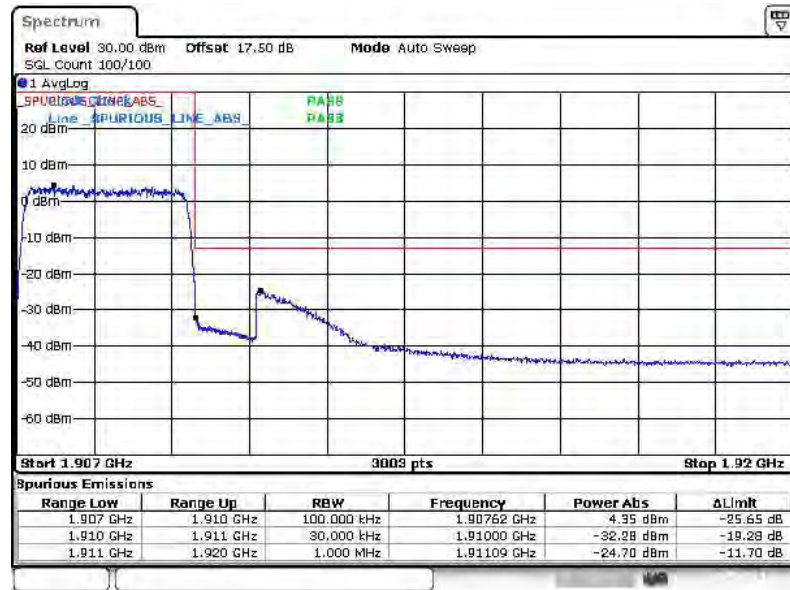

Date: 25-SEP-2014 18:46:49



Band :	LTE Band 2	Band Width :	5MHz / QPSK
--------	------------	--------------	-------------

Lower Band Edge Plot for QPSK-RB Size 1, RB Offset 0

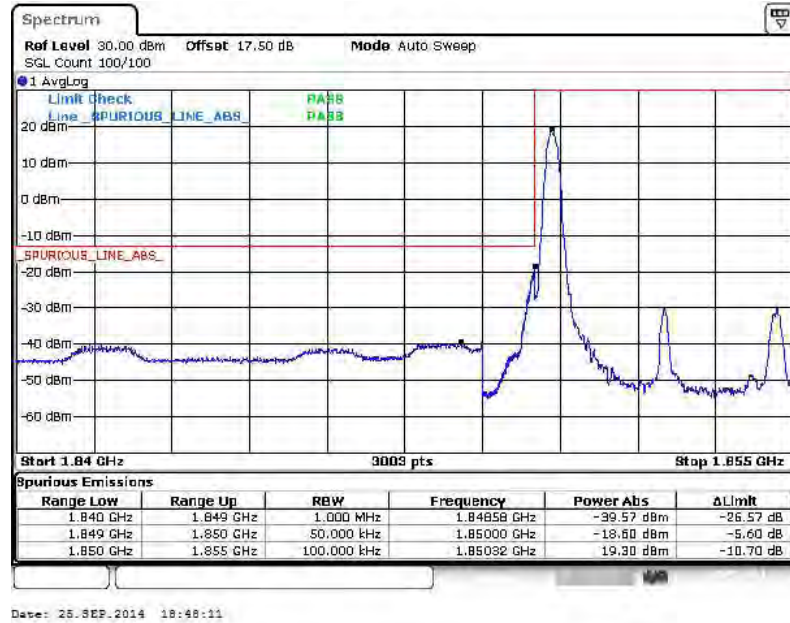

Lower Band Edge Plot for QPSK-RB Size 25, RB Offset 0

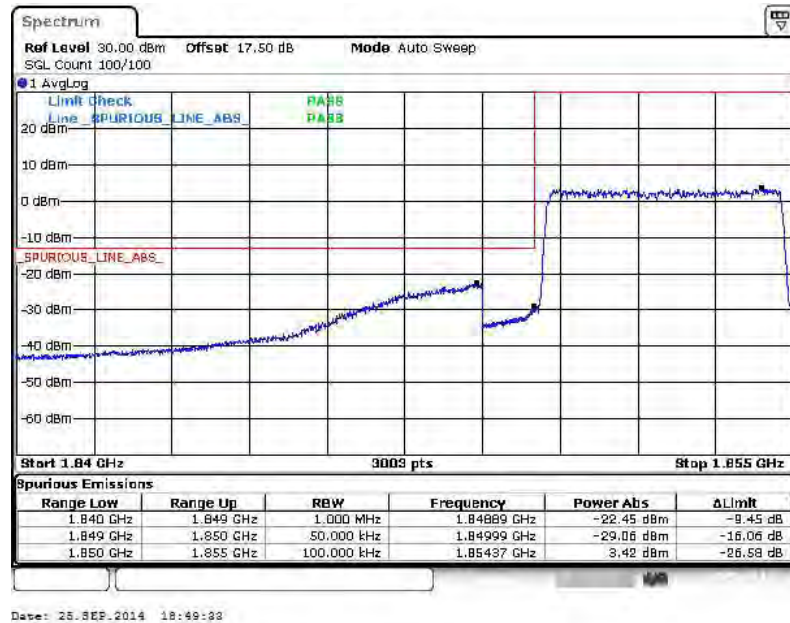



Higher Band Edge Plot for QPSK-RB Size 1, RB Offset 24

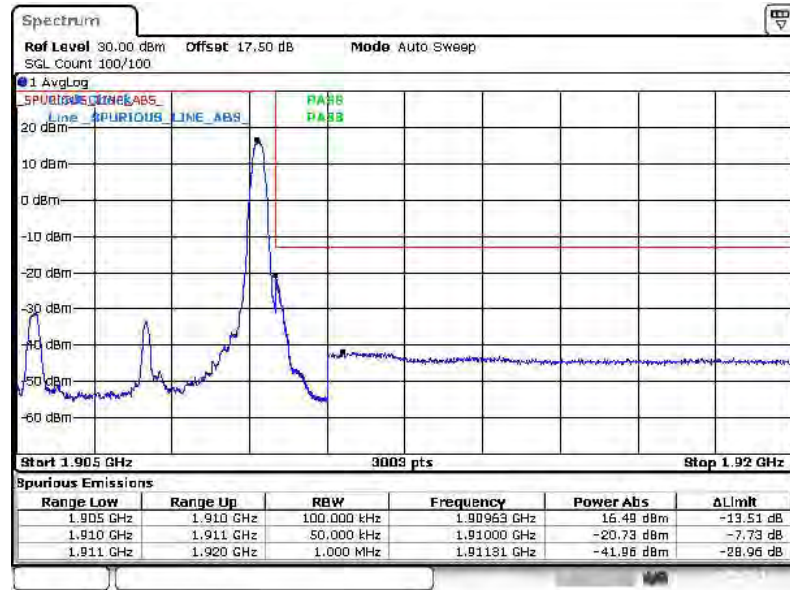

Date: 25-SEP-2014 18:50:19

Higher Band Edge Plot for QPSK-RB Size 25, RB Offset 0

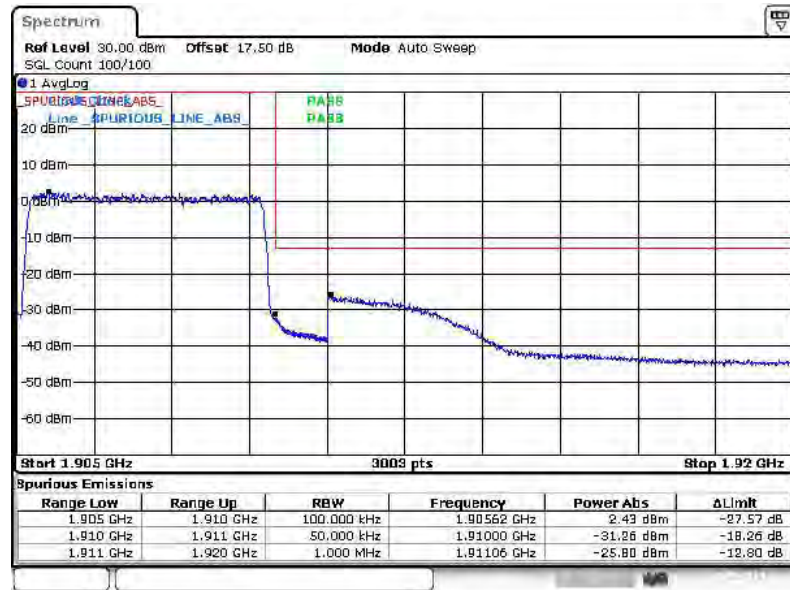

Date: 25-SEP-2014 18:51:08



Band :	LTE Band 2	Band Width :	5MHz / 16QAM
--------	------------	--------------	--------------

Lower Band Edge Plot for 16QAM-RB Size 1, RB Offset 0

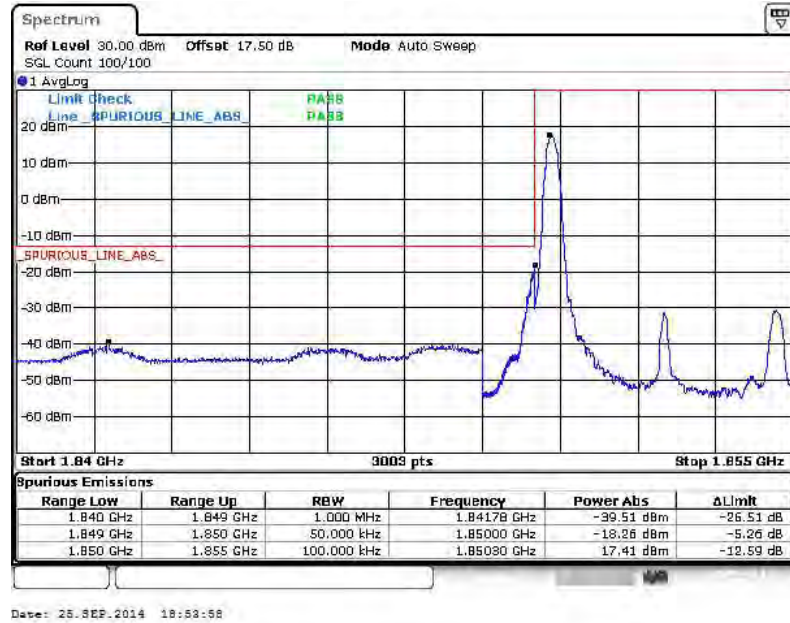

Lower Band Edge Plot for 16QAM-RB Size 25, RB Offset 0

