

FCC TEST REPORT (PART 24)

Product: Smartphone
Model Name: Ilium L1000
FCC ID: ZC4L1000
Applicant: Corporativo Lanix S.A. de C.V.
Address: Carretera Internacional Hermosillo-Nogales Km 8.5,
Hermosillo Sonora, Mexico
Manufacturer: Tinno Mobile Technology Corp.
4/F., H-3 Building, OCT Eastern Industrial Park. NO.1
Address: XiangShan East Road., Nan Shan District, Shenzhen, P.R.
China
Prepared by: Bureau Veritas Shenzhen Co., Ltd. Dongguan Branch
Lab Location: No. 34, Chenwulu Section, Guantai Rd., Houjie Town,
Dongguan City, Guangdong 523942, China
TEL: +86 769 8593 5656
FAX: +86 769 8593 1080
E-MAIL: customerservice.dg@cn.bureauveritas.com
Report No.: RF150304N017-4
Received Date: Mar. 04, 2015
Test Date: Mar. 05, 2015 ~ Mar. 19, 2015
Issued Date: Mar. 20, 2015

This report should not be used by the client to claim product certification, approval, or endorsement by A2LA or any government agencies.

This report is for your exclusive use. Any copying or replication of this report to or for any other person or entity, or use of our name or trademark, is permitted only with our prior written permission. This report sets forth our findings solely with respect to the test samples identified herein. The results set forth in this report are not indicative or representative of the quality or characteristics of the lot from which a test sample was taken or any similar or identical product unless specifically and expressly noted. Our report includes all of the tests requested by you and the results thereof based upon the information that you provided to us. You have 60 days from date of issuance of this report to notify us of any material error or omission caused by our negligence, provided, however, that such notice shall be in writing and shall specifically address the issue you wish to raise. A failure to raise such issue within the prescribed time shall constitute your unqualified acceptance of the completeness of this report, the tests conducted and the correctness of the report contents. Unless specific mention, the uncertainty of measurement has been explicitly taken into account to declare the compliance or non-compliance to the specification.

TABLE OF CONTENTS

RELEASE CONTROL RECORD	4
1 CERTIFICATION	5
2 SUMMARY OF TEST RESULTS.....	6
2.1 MEASUREMENT UNCERTAINTY	6
2.2 TEST SITE AND INSTRUMENTS.....	7
3 GENERAL INFORMATION.....	8
3.1 GENERAL DESCRIPTION OF EUT	8
3.2 CONFIGURATION OF SYSTEM UNDER TEST	10
3.3 DESCRIPTION OF SUPPORT UNITS.....	11
3.4 TEST ITEM AND TEST CONFIGURATION	11
3.5 EUT OPERATING CONDITIONS.....	14
3.6 GENERAL DESCRIPTION OF APPLIED STANDARDS	14
4 TEST TYPES AND RESULTS.....	15
4.1 OUTPUT POWER MEASUREMENT	15
4.1.1 LIMITS OF OUTPUT POWER MEASUREMENT	15
4.1.2 TEST PROCEDURES	15
4.1.3 TEST SETUP.....	16
4.1.4 TEST RESULTS	17
4.2 FREQUENCY STABILITY MEASUREMENT	27
4.2.1 LIMITS OF FREQUENCY STABILITY MEASUREMENT	27
4.2.2 TEST PROCEDURE.....	27
4.2.3 TEST SETUP.....	27
4.2.4 TEST RESULTS	28
4.3 OCCUPIED BANDWIDTH MEASUREMENT	30
4.3.1 TEST PROCEDURES	30
4.3.2 TEST SETUP.....	30
4.3.3 TEST RESULTS	31
4.4 BAND EDGE MEASUREMENT	39
4.4.1 LIMITS OF BAND EDGE MEASUREMENT	39
4.4.2 TEST SETUP.....	39
4.4.3 TEST PROCEDURES	39
4.4.4 TEST RESULTS	41
4.5 CONDUCTED SPURIOUS EMISSIONS	48
4.5.1 LIMITS OF CONDUCTED SPURIOUS EMISSIONS MEASUREMENT	48
4.5.2 TEST PROCEDURE.....	48
4.5.3 TEST SETUP.....	48
4.5.4 TEST RESULTS	49
4.6 RADIATED EMISSION MEASUREMENT	54
4.6.1 LIMITS OF RADIATED EMISSION MEASUREMENT	54
4.6.2 TEST PROCEDURES	54
4.6.3 DEVIATION FROM TEST STANDARD	54
4.6.4 TEST SETUP.....	55
4.6.5 TEST RESULTS	56



BUREAU
VERITAS

Test Report No.: RF150304N017-4

4.7	PEAK TO AVERAGE RATIO	66
4.7.1	LIMITS OF PEAK TO AVERAGE RATIO MEASUREMENT.....	76
4.7.2	TEST SETUP.....	76
4.7.3	TEST PROCEDURES	76
4.7.4	TEST RESULTS	77
5	INFORMATION ON THE TESTING LABORATORIES.....	83
6	APPENDIX A – MODIFICATIONS RECORDERS FOR ENGINEERING CHANGES TO THE EUT BY THE LAB.....	84



BUREAU
VERITAS

Test Report No.: RF150304N017-4

RELEASE CONTROL RECORD

ISSUE NO.	REASON FOR CHANGE	DATE ISSUED
RF150304N017-4	Original release	Mar. 20, 2015



BUREAU
VERITAS

Test Report No.: RF150304N017-4

1 CERTIFICATION

PRODUCT: Smartphone
BRAND NAME: LANIX
MODEL NAME: Ilium L1000
APPLICANT: Corporativo Lanix S.A. de C.V.
TESTED: Mar. 05, 2015 ~ Mar. 19, 2015
TEST SAMPLE: Production unit
STANDARDS: **FCC Part 24, Subpart E**

The above equipment has been tested by **Bureau Veritas Shenzhen Co., Ltd. Dongguan Branch**, and found compliance with the requirement of the above standards. The test record, data evaluation & Equipment Under Test (EUT) configurations represented herein are true and accurate accounts of the measurements of the sample's EMC characteristics under the conditions specified in this report.

TESTED BY :  , **DATE :** Mar. 20, 2015
Glyn He/ Project Engineer

APPROVED BY :  , **DATE :** Mar. 20, 2015
Sam Tung / Technical Manager



2 SUMMARY OF TEST RESULTS

The EUT has been tested according to the following specifications:

APPLIED STANDARD: FCC Part 24 & Part 2			
STANDARD SECTION	TEST TYPE	RESULT	REMARK
2.1046 24.232	Equivalent Isotropic Radiated Power	PASS	Meet the requirement of limit.
2.1055 24.235	Frequency Stability	PASS	Meet the requirement of limit.
2.1049 24.238(b)	Occupied Bandwidth	PASS	Meet the requirement of limit.
24.232(d)	Peak to average ratio	PASS	Meet the requirement of limit.
24.238(b)	Band Edge Measurements	PASS	Meet the requirement of limit.
2.1051 24.238	Conducted Spurious Emissions	PASS	Meet the requirement of limit.
2.1053 24.238	Radiated Spurious Emissions	PASS	Meet the requirement of limit. Minimum passing margin is -37.15dB at 5650.00MHz.

2.1 MEASUREMENT UNCERTAINTY

Where relevant, the following measurement uncertainty levels have been estimated for tests performed on the EUT as specified in CISPR 16-4-2:

MEASUREMENT	FREQUENCY	UNCERTAINTY
Conducted emissions	9kHz~30MHz	2.66dB
Radiated emissions	9KHz ~ 30MHz	2.74dB
	30MHz ~ 1GHz	3.55dB
	1GHz ~ 18GHz	4.84dB
	18GHz ~ 40GHz	1.94dB

This uncertainty represents an expanded uncertainty expressed at approximately the 95% confidence level using a coverage factor of k=2.



2.2 TEST SITE AND INSTRUMENTS

Equipment	Manufacturer	Model No.	Serial No.	Last Cal.	Next Cal.
EMI Test Receiver	Rohde&Schwarz	ESU 26	100005	May 13,14	May 12,15
GPS Generator+ Antenna	TOJOIN	GNSS-5000A	E1-010119	Aug. 08, 14	Aug. 07, 15
Bilog Antenna	Teseq	CBL 6111D	30643	Jul. 25, 14	Jul. 24, 15
Horn Antenna (1GHz -18GHz)	ETS -Lindgren	3117	00062558	May 30, 14	May 29, 16
Amplifier (9kHz-1GHz)	SONOMA	310D	186955	Mar. 05,15	Mar. 04, 16
Pre-Amplifier (18GHz-40GHz)	EMCI	EMC 184045	980102	Nov. 20,14	Nov. 19,15
Pre-Amplifier (100MHz-26.5GHz)	Agilent	8449B	3008A00409	May 13,14	May 12,15
GPS Generator+ Antenna	TOJOIN	GNSS-5000A	E1-010119	Aug. 08, 14	Aug. 07, 15
3m Semi-anechoic Chamber	ETS-LINDGREN	9m*6m*6m	NSEMC003	Apr. 19,14	Apr. 18,15
Test Software	ADT	ADT_Radiated_V7.6.15.9.2	N/A	N/A	N/A
Spectrum Analyzer (9KHz-25GHz)	Agilent	E7405A	MY45118807	May 13,14	May 12,15
Power Meter	Anritsu	ML2495A	1139001	Feb. 21,15	Feb. 20,16
Power Sensor	Anritsu	MA2411B	1126068	Feb. 21,15	Feb. 20,16
Digital Multimeter	FLUKE	15B	A1220010DG	Oct. 27,14	Oct. 26,15
Humid & Temp Programmable Tester	Haida	HD-2257	110807201	Sep.04,14	Sep. 03,15
Oscilloscope	Agilent	DSO9254A	MY51260160	Oct. 17, 14	Oct. 16, 15
Signal Analyzer	Rohde & Schwarz	FSV7	102331	Nov. 05,14	Nov. 04,15
Signal Generator	Agilent	N5183A	MY50140980	Nov. 05,14	Nov. 04,15
ESG Vector Signal Generator	Agilent	E4438C	MY49072505	Mar.13, 15	Mar.12, 16
BLUETOOTH TESTER	Rohde&Schwarz	CBT32	100811	Sep. 04,14	Sep. 03,15

- NOTE:** 1. The calibration interval of the above test instruments is 12 months or 24 months and the calibrations are traceable to CEPREI/CHINA, GRGT/CHINA and NIM/CHINA.
2. The test was performed in Dongguan 966 Chamber.
3. The horn antenna are used only for the measurement of emission frequency above 1GHz if tested.
4. The FCC Site Registration No. is 502831.



3 GENERAL INFORMATION

3.1 GENERAL DESCRIPTION OF EUT

PRODUCT	Smartphone	
MODEL NAME	Ilium L1000	
FCC ID	ZC4L1000	
POWER SUPPLY	5.0Vdc (adapter or host equipment) 3.8Vdc (battery)	
MODULATION TYPE	GSM, GPRS: GMSK EDGE: GMSK, 8PSK WCDMA : BPSK LTE Band 2: QPSK, 16QAM	
FREQUENCY RANGE	GSM, GPRS, EDGE: 1850.2MHz ~ 1909.8MHz	
	WCDMA: 1852.4MHz ~ 1907.6MHz	
	LTE Band 2 Channel Bandwidth: 1.4MHz	1850.7MHz ~ 1909.3MHz
	LTE Band 2 Channel Bandwidth: 3MHz	1851.5MHz ~ 1908.5MHz
	LTE Band 2 Channel Bandwidth: 5MHz	1852.5MHz ~ 1907.5MHz
	LTE Band 2 Channel Bandwidth: 10MHz	1855.0MHz ~ 1905.0MHz
	LTE Band 2 Channel Bandwidth: 15MHz	1857.5MHz ~ 1902.5MHz
	LTE Band 2 Channel Bandwidth: 20MHz	1860.0MHz ~ 1900.0MHz
MAX. EIRP POWER	GSM: 358mW	
	EDGE: 461mW	
	WCDMA: 167mW	
	LTE Band 2 Channel Bandwidth: 1.4MHz	102mW
	LTE Band 2 Channel Bandwidth: 3MHz	96mW
	LTE Band 2 Channel Bandwidth: 5MHz	107mW
	LTE Band 2 Channel Bandwidth: 10MHz	104mW
	LTE Band 2 Channel Bandwidth: 15MHz	107mW
LTE Band 2 Channel Bandwidth: 20MHz	106mW	
EMISSION DESIGNATOR	GSM	248KGXW



	EDGE	250KG7W
	WCDMA	4M16F9W
	LTE Band 2 Channel Bandwidth: 1.4MHz	1M09W7D
	LTE Band 2 Channel Bandwidth: 3MHz	2M68W7D
	LTE Band 2 Channel Bandwidth: 5MHz	4M49G7D
	LTE Band 2 Channel Bandwidth: 10MHz	8M97W7D
	LTE Band 2 Channel Bandwidth: 15MHz	13M4W7D
	LTE Band 2 Channel Bandwidth: 20MHz	18M0W7D
ANTENNA TYPE	Fixed Internal antenna with -1dBi gain	
HW VERSION	V1.0	
SW VERSION	ILIUM L1000_TELCEL_SW_01	
I/O PORTS	Refer to user's manual	
CABLE SUPPLIED	USB Cable: unshielded, detachable, 1.0m Earphone Cable: shielded, detachable, 1.0m	

NOTE:

- For a more detailed features description, please refer to the manufacturer's specifications or the user's manual.
- The EUT was powered by the following adapter:

ADAPTER	
BRAND:	LANIX
MODEL:	Ilium L1000-C
INPUT:	AC 100-240V, 150mA
OUTPUT:	DC 5V, 1000mA

- For the test results, the EUT had been tested with all conditions. But only the worst case was shown in test report.



3.2 CONFIGURATION OF SYSTEM UNDER TEST

FOR RADIATION EMISSION TEST

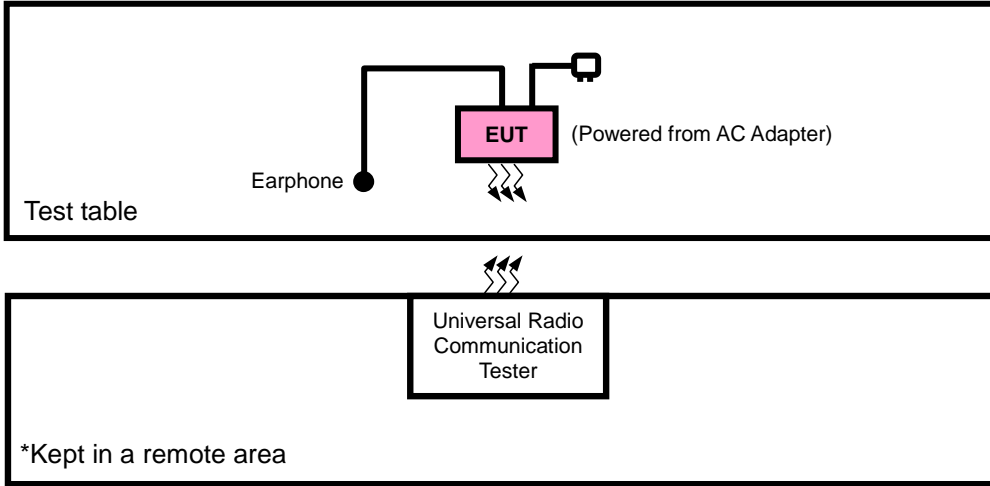

FOR E.I.R.P. TEST

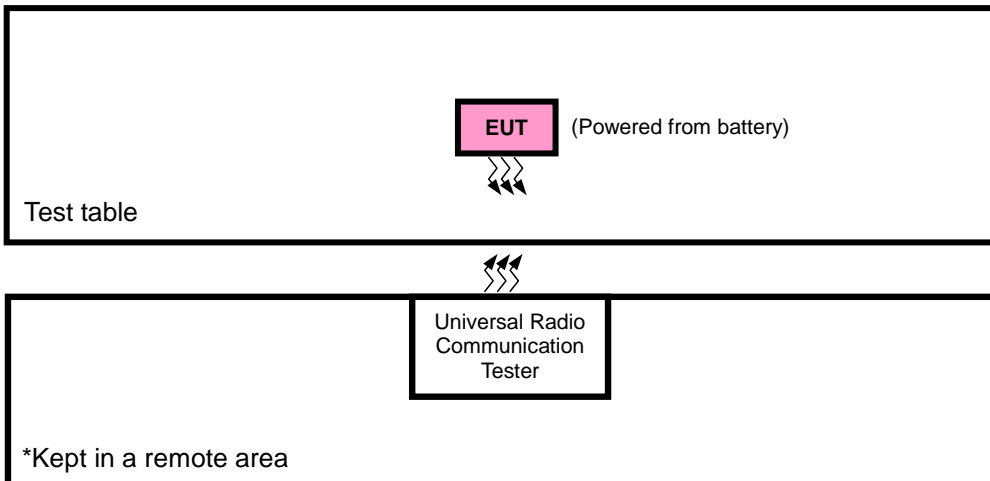



3.3 DESCRIPTION OF SUPPORT UNITS

The EUT has been tested as an independent unit together with other necessary accessories or support units. The following support units or accessories were used to form a representative test configuration during the tests.

NO.	PRODUCT	BRAND	MODEL NO.	SERIAL NO.	FCC ID
1	DC source	LONG WEI	PS-6403D	010934269	N/A
2	PC	HP	A6608CN	3CR83825X3	N/A

NO.	SIGNAL CABLE DESCRIPTION OF THE ABOVE SUPPORT UNITS
1	DC Line: Unshielded, Detachable 1.0m
2	AC Line: Unshielded, Detachable 1.5m

NOTE:

1. All power cords of the above support units are non shielded (1.8m).

3.4 TEST ITEM AND TEST CONFIGURATION

Pre-Scan has been conducted to determine the worst-case mode from all possible combinations between available modulations, data rates, XYZ axis and antenna ports. The worst case in EIRP and radiated emission was found when positioned on X-plane for GSM/EDGE/WCDMA and Z-plane for LTE. Following channel(s) was (were) selected for the final test as listed below:

EUT CONFIGURE MODE	DESCRIPTION
A	EUT + Adapter + Earphone with GSM ,WCDMA or LTE link
B	EUT + Battery+ Earphone with GSM ,WCDMA or LTE link

GSM MODE

EUT CONFIGURE MODE	TEST ITEM	AVAILABLE CHANNEL	TESTED CHANNEL	MODE
B	EIRP	512 to 810	512, 661, 810	GSM, EDGE
B	FREQUENCY STABILITY	512 to 810	661	GSM, EDGE
B	OCCUPIED BANDWIDTH	512 to 810	512, 661, 810	GSM, EDGE
B	PEAK TO AVERAGE RATIO	512 to 810	661	GSM, EDGE
B	BAND EDGE	512 to 810	512, 810	GSM, EDGE
B	CONDCUDED EMISSION	512 to 810	661	GSM, EDGE
A	RADIATED EMISSION	512 to 810	661	GSM, EDGE



WCDMA MODE

EUT CONFIGURE MODE	TEST ITEM	AVAILABLE CHANNEL	TESTED CHANNEL	MODE
B	EIRP	9262 to 9538	9262, 9400, 9538	WCDMA
B	FREQUENCY STABILITY	9262 to 9538	9400	WCDMA
B	OCCUPIED BANDWIDTH	9262 to 9538	9262, 9400, 9538	WCDMA
B	PEAK TO AVERAGE RATIO	9262 to 9538	9400	WCDMA
B	BAND EDGE	9262 to 9538	9262, 9538	WCDMA
B	CONDCUDED EMISSION	9262 to 9538	9400	WCDMA
A	RADIATED EMISSION	9262 to 9538	9400	WCDMA

LTE BAND 2

EUT CONFIGURE MODE	TEST ITEM	AVAILABLE CHANNEL	TESTED CHANNEL	CHANNEL BANDWIDTH	MODULATION	MODE
B	EIRP	18607 to 19193	18607, 18900, 19193	1.4MHz	QPSK, 16QAM	1 RB / 0 RB Offset
		18615 to 19185	18615, 18900, 19185	3MHz	QPSK, 16QAM	1 RB / 0 RB Offset
		18625 to 19175	18625, 18900, 19175	5MHz	QPSK, 16QAM	1 RB / 0 RB Offset
		18650 to 19150	18650, 18900, 19150	10MHz	QPSK, 16QAM	1 RB / 0 RB Offset
		18675 to 19125	18675, 18900, 19125	15MHz	QPSK, 16QAM	1 RB / 0 RB Offset
		18700 to 19100	18700, 18900, 19100	20MHz	QPSK, 16QAM	1 RB / 0 RB Offset
B	FREQUENCY STABILITY	18607 to 19193	18900	1.4MHz	QPSK	1 RB / 0 RB Offset
		18615 to 19185	18900	3MHz	QPSK	1 RB / 0 RB Offset
		18625 to 19175	18900	5MHz	QPSK	1 RB / 0 RB Offset
		18650 to 19150	18900	10MHz	QPSK	1 RB / 0 RB Offset
		18675 to 19125	18900	15MHz	QPSK	1 RB / 0 RB Offset
		18700 to 19100	18900	20MHz	QPSK	1 RB / 0 RB Offset
B	OCCUPIED BANDWIDTH	18607 to 19193	18607, 18900, 19193	1.4MHz	QPSK, 16QAM	6 RB / 0 RB Offset
		18615 to 19185	18615, 18900, 19185	3MHz	QPSK, 16QAM	15 RB / 0 RB Offset
		18625 to 19175	18625, 18900, 19175	5MHz	QPSK, 16QAM	25 RB / 0 RB Offset
		18650 to 19150	18650, 18900, 19150	10MHz	QPSK, 16QAM	50 RB / 0 RB Offset
		18675 to 19125	18675, 18900, 19125	15MHz	QPSK, 16QAM	75 RB / 0 RB Offset
		18700 to 19100	18700, 18900, 19100	20MHz	QPSK, 16QAM	100 RB / 0 RB Offset
B	PEAK TO AVERAGE RATIO	18607 to 19193	18607, 18900, 19193	1.4MHz	QPSK, 16QAM	1 RB / 0 RB Offset
		18615 to 19185	18615, 18900, 19185	3MHz	QPSK, 16QAM	1 RB / 0 RB Offset
		18625 to 19175	18625, 18900, 19175	5MHz	QPSK, 16QAM	1 RB / 0 RB Offset
		18650 to 19150	18650, 18900, 19150	10MHz	QPSK, 16QAM	1 RB / 0 RB Offset
		18675 to 19125	18675, 18900, 19125	15MHz	QPSK, 16QAM	1 RB / 0 RB Offset
		18700 to 19100	18700, 18900, 19100	20MHz	QPSK, 16QAM	1 RB / 0 RB Offset



B	BAND EDGE	18607 to 19193	18607	1.4MHz	QPSK	1 RB / 0 RB Offset 6 RB / 0 RB Offset		
			19193	1.4MHz	QPSK	1 RB / 5 RB Offset 6 RB / 0 RB Offset		
		18615 to 19185	18615	3MHz	QPSK	1 RB / 0 RB Offset 15 RB / 0 RB Offset		
			19185	3MHz	QPSK	1 RB / 14 RB Offset 15 RB / 0 RB Offset		
		18625 to 19175	18625	5MHz	QPSK	1 RB / 0 RB Offset 25 RB / 0 RB Offset		
			19175	5MHz	QPSK	1 RB / 24 RB Offset 25 RB / 0 RB Offset		
		18650 to 19150	18650	10MHz	QPSK	1 RB / 0 RB Offset 50 RB / 0 RB Offset		
			19150	10MHz	QPSK	1 RB / 49 RB Offset 50 RB / 0 RB Offset		
		18675 to 19125	18675	15MHz	QPSK	1 RB / 0 RB Offset 75 RB / 0 RB Offset		
			19125	15MHz	QPSK	1 RB / 74 RB Offset 75 RB / 0 RB Offset		
		18700 to 19100	18700	20MHz	QPSK	1 RB / 0 RB Offset 100 RB / 0 RB Offset		
			19100	20MHz	QPSK	1 RB / 99 RB Offset 100 RB / 0 RB Offset		
		B	CONDCUDETED EMISSION	18607 to 19193	18900	1.4MHz	QPSK	1 RB / 0 RB Offset
				18615 to 19185	18900	3MHz	QPSK	1 RB / 0 RB Offset
				18625 to 19175	18900	5MHz	QPSK	1 RB / 0 RB Offset
				18650 to 19150	18900	10MHz	QPSK	1 RB / 0 RB Offset
18675 to 19125	18900			15MHz	QPSK	1 RB / 0 RB Offset		
18700 to 19100	18900			20MHz	QPSK	1 RB / 0 RB Offset		
A	RADIATED EMISSION	18607 to 19193	18900	1.4MHz	QPSK	1 RB / 0 RB Offset		
		18615 to 19185	18900	3MHz	QPSK	1 RB / 0 RB Offset		
		18625 to 19175	18900	5MHz	QPSK	1 RB / 0 RB Offset		
		18650 to 19150	18900	10MHz	QPSK	1 RB / 0 RB Offset		
		18675 to 19125	18900	15MHz	QPSK	1 RB / 0 RB Offset		
		18700 to 19100	18900	20MHz	QPSK	1 RB / 0 RB Offset		

TEST CONDITION:

TEST ITEM	ENVIRONMENTAL CONDITIONS	INPUT POWER	TESTED BY
EIRP	25deg. C, 57%RH	5Vdc from adapter	Blue Zheng
FREQUENCY STABILITY	23deg. C, 61%RH	3.8Vdc from Battery	Yuqiang Yin
OCCUPIED BANDWIDTH	23deg. C, 61%RH	3.8Vdc from Battery	Yuqiang Yin
PEAK TO AVERAGE RATIO	23deg. C, 61%RH	3.8Vdc from Battery	Yuqiang Yin
BAND EDGE	23deg. C, 61%RH	3.8Vdc from Battery	Yuqiang Yin
CONDCUDETED EMISSION	23deg. C, 61%RH	3.8Vdc from Battery	Yuqiang Yin
RADIATED EMISSION	25deg. C, 57%RH	5Vdc from adapter	Blue Zheng



3.5 EUT OPERATING CONDITIONS

The EUT makes a call to the communication simulator. The communication simulator station system controlled a EUT to export maximum output power under transmission mode and specific channel frequency

3.6 GENERAL DESCRIPTION OF APPLIED STANDARDS

The EUT is a RF product. According to the specifications of the manufacturer, it must comply with the requirements of the following standards:

FCC 47 CFR Part 2

FCC 47 CFR Part 24

ANSI/TIA/EIA-603-C 2004

NOTE: All test items have been performed and recorded as per the above standards.



4 TEST TYPES AND RESULTS

4.1 OUTPUT POWER MEASUREMENT

4.1.1 LIMITS OF OUTPUT POWER MEASUREMENT

Mobile and portable stations are limited to 2 watts EIRP

4.1.2 TEST PROCEDURES

EIRP MEASUREMENT:

- a. All measurements were done at low, middle and high operational frequency range. RBW and VBW is 1MHz for GSM, GPRS & EDGE and 5MHz for WCDMA mode.
- b. Substitution method is used for E.I.R.P measurement. In the semi-anechoic chamber, EUT placed on the 0.8m height of Turn Table, rotated the table around 360 degrees to search the maximum radiation power and receiver antenna shall be rotated vertical and horizontal polarization and moved height from 1m to 4m to find the maximum polar radiated power. The “Read Value” is the spectrum reading the maximum power value.
- c. The substitution horn antenna is substituted for EUT at the same position and signals generator export the CW signal to the substitution antenna via a tx cable. Rotated the Turn Table and moved receiving antenna to find the maximum radiation power. Adjust output power level of S.G to get a Value of spectrum reading equal to “Read Value “ of step b. Record the power level of S.G
- d. $EIRP = \text{Output power level of S.G} - \text{TX cable loss} + \text{Antenna gain of substitution horn.}$

CONDUCTED POWER MEASUREMENT:

The EUT was set up for the maximum power with GSM, GPRS, EDGE & WCDMA link data modulation and link up with simulator. Set the EUT to transmit under low, middle and high channel and record the power level shown on simulator.



4.1.3 TEST SETUP

EIRP MEASUREMENT:

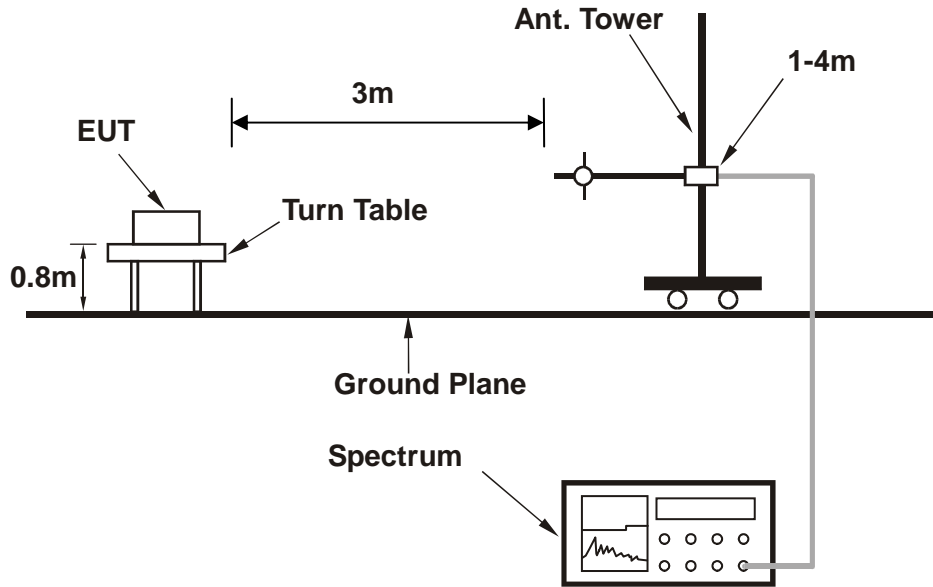

For the actual test configuration, please refer to the attached file (Test Setup Photo).

CONDUCTED POWER MEASUREMENT:

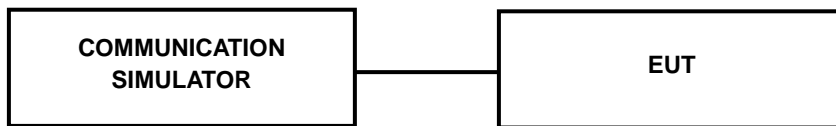

For the actual test configuration, please refer to the attached file (Test Setup Photo).



4.1.4 TEST RESULTS

CONDUCTED OUTPUT POWER (dBm)

Band	GSM1900		
Channel	512	661	810
Frequency (MHz)	1850.2	1880.0	1909.8
GSM	28.29	28.13	28.16
GPRS 8	28.24	28.03	28.04
GPRS 10	28.00	27.75	27.84
GPRS 11	27.93	27.78	27.79
GPRS 12	27.89	27.73	27.75
EDGE 8 (MCS9)	24.47	24.34	24.39
EDGE 10 (MCS9)	24.43	24.29	24.34
EDGE 11 (MCS9)	24.45	24.43	24.29
EDGE 12 (MCS9)	24.40	24.25	24.28

Band	WCDMA II		
Channel	9262	9400	9538
Frequency (MHz)	1852.4	1880.0	1907.6
RMC 12.2K	22.06	21.94	21.82
HSPA			
HSDPA Subtest-1	21.03	20.78	20.83
HSDPA Subtest-2	21.00	20.76	20.84
HSDPA Subtest-3	20.47	20.31	20.35
HSDPA Subtest-4	20.46	20.33	20.33
HSUPA Subtest-1	20.89	20.72	20.64
HSUPA Subtest-2	18.92	18.71	18.83
HSUPA Subtest-3	19.62	19.54	19.43
HSUPA Subtest-4	18.81	18.91	18.79
HSUPA Subtest-5	21.12	20.91	20.81



LTE Band 2							
BW	Modulation	RB Size	RB Offset	Low CH 18607	Mid CH 18900	High CH 19193	3GPP MPR (dB)
				Frequency 1850.7 MHz	Frequency 1880 MHz	Frequency 1909.3 MHz	
1.4MHz	QPSK	1	0	22.51	22.52	22.5	0
		1	2	22.46	22.42	22.36	0
		1	5	22.32	22.39	22.44	0
		3	0	22.49	22.5	22.48	0
		3	1	22.44	22.4	22.34	0
		3	3	22.3	22.37	22.42	0
		6	0	21.18	21.25	21.14	1
	16QAM	1	0	21.23	21.43	21.35	1
		1	2	21.31	21.42	21.33	1
		1	5	21.32	21.35	21.28	1
		3	0	21.2	21.4	21.32	1
		3	1	21.28	21.39	21.3	1
		3	3	21.29	21.32	21.25	1
		6	0	20.08	20.28	20.08	2



LTE Band 2							
BW	Modulation	RB Size	RB Offset	Low CH 18615	Mid CH 18900	High CH 19185	3GPP MPR (dB)
				Frequency 1851.5 MHz	Frequency 1880 MHz	Frequency 1908.5 MHz	
3 MHz	QPSK	1	0	22.57	22.58	22.56	0
		1	7	22.52	22.48	22.42	0
		1	14	22.38	22.45	22.5	0
		8	0	21.41	21.42	21.34	1
		8	3	21.4	21.36	21.2	1
		8	7	21.26	21.26	21.32	1
		15	0	21.24	21.31	21.2	1
	16QAM	1	0	21.29	21.49	21.41	1
		1	7	21.37	21.48	21.39	1
		1	14	21.38	21.41	21.34	1
		8	0	20.36	20.4	20.33	2
		8	3	20.3	20.25	20.22	2
		8	7	20.13	20.16	20.29	2
		15	0	20.14	20.34	20.14	2
BW	Modulation	RB Size	RB Offset	Low CH 18625	Mid CH 18900	High CH 19175	3GPP MPR (dB)
				Frequency 1852.5 MHz	Frequency 1880 MHz	Frequency 1907.5 MHz	
5 MHz	QPSK	1	0	22.6	22.61	22.59	0
		1	12	22.55	22.51	22.45	0
		1	24	22.41	22.48	22.53	0
		12	0	21.44	21.45	21.37	1
		12	6	21.43	21.39	21.23	1
		12	13	21.29	21.29	21.35	1
		25	0	21.27	21.34	21.23	1
	16QAM	1	0	21.32	21.52	21.44	1
		1	12	21.4	21.51	21.42	1
		1	24	21.41	21.44	21.37	1
		12	0	20.39	20.43	20.36	2
		12	6	20.33	20.28	20.25	2
		12	13	20.16	20.19	20.32	2
		25	0	20.17	20.37	20.17	2



LTE Band 2							
BW	Modulation	RB Size	RB Offset	Low CH 18650	Mid CH 18900	High CH 19150	3GPP MPR (dB)
				Frequency 1855 MHz	Frequency 1880 MHz	Frequency 1905 MHz	
10 MHz	QPSK	1	0	22.66	22.67	22.65	0
		1	24	22.61	22.57	22.51	0
		1	49	22.47	22.54	22.59	0
		25	0	21.5	21.51	21.43	1
		25	12	21.49	21.45	21.29	1
		25	25	21.35	21.35	21.41	1
		50	0	21.33	21.4	21.29	1
	16QAM	1	0	21.38	21.58	21.5	1
		1	24	21.46	21.57	21.48	1
		1	49	21.47	21.5	21.43	1
		25	0	20.45	20.49	20.42	2
		25	12	20.39	20.34	20.31	2
		25	25	20.22	20.25	20.38	2
		50	0	20.23	20.43	20.23	2
BW	Modulation	RB Size	RB Offset	Low CH 18675	Mid CH 18900	High CH 19125	3GPP MPR (dB)
				Frequency 1857.5 MHz	Frequency 1880 MHz	Frequency 1902.5 MHz	
15 MHz	QPSK	1	0	22.7	22.71	22.69	0
		1	37	22.65	22.61	22.55	0
		1	74	22.51	22.58	22.63	0
		36	0	21.54	21.55	21.47	1
		36	19	21.53	21.49	21.33	1
		36	39	21.39	21.39	21.45	1
		75	0	21.37	21.44	21.33	1
	16QAM	1	0	21.42	21.62	21.54	1
		1	37	21.5	21.61	21.52	1
		1	74	21.51	21.54	21.47	1
		36	0	20.49	20.53	20.46	2
		36	19	20.43	20.38	20.35	2
		36	39	20.26	20.29	20.42	2
		75	0	20.27	20.47	20.27	2



LTE Band 2							
BW	Modulation	RB Size	RB Offset	Low CH 18700	Mid CH 18900	High CH 19100	3GPP MPR (dB)
				Frequency 1860 MHz	Frequency 1880 MHz	Frequency 1900 MHz	
20MHz	QPSK	1	0	22.75	22.76	22.74	0
		1	50	22.7	22.66	22.6	0
		1	99	22.56	22.63	22.68	0
		50	0	21.59	21.6	21.52	1
		50	25	21.58	21.54	21.38	1
		50	50	21.44	21.44	21.5	1
		100	0	21.42	21.49	21.38	1
	16QAM	1	0	21.47	21.67	21.59	1
		1	50	21.55	21.66	21.57	1
		1	99	21.56	21.59	21.52	1
		50	0	20.54	20.58	20.51	2
		50	25	20.48	20.43	20.4	2
		50	50	20.31	20.34	20.47	2
		100	0	20.32	20.52	20.32	2



EIRP POWER (dBm)

GSM

Channel	Frequency (MHz)	LVL (dBm)	Correction Factor(dB)	EIRP(dBm)	EIRP(mW)	Polarization (H/V)
512	1850.2	-23.62	41.66	18.04	63.68	H
661	1880.0	-23.35	42.34	18.99	79.25	H
810	1909.8	-23.56	42.49	18.93	78.16	H
512	1850.2	-18.75	44.28	25.53	357.27	V
661	1880.0	-18.69	44.10	25.41	347.54	V
810	1909.8	-18.88	44.42	25.54	358.10	V

EDGE

Channel	Frequency (MHz)	LVL (dBm)	Correction Factor(dB)	EIRP(dBm)	EIRP(mW)	Polarization (H/V)
512	1850.2	-22.62	41.66	19.04	80.17	H
661	1880.0	-22.08	42.34	20.26	106.17	H
810	1909.8	-22.19	42.49	20.30	107.15	H
512	1850.2	-18.88	44.24	25.36	343.56	V
661	1880.0	-18.06	44.01	25.95	393.55	V
810	1909.8	-18.15	44.79	26.64	461.32	V

WCDMA

Channel	Frequency (MHz)	LVL (dBm)	Correction Factor(dB)	EIRP(dBm)	EIRP(mW)	Polarization (H/V)
9262	1852.4	-28.65	41.69	13.04	20.14	H
9400	1880.0	-28.31	42.34	14.03	25.29	H
9538	1907.6	-28.55	42.77	14.22	26.42	H
9262	1852.4	-22.49	44.24	21.75	149.62	V
9400	1880.0	-22.08	44.01	21.93	155.96	V
9538	1907.6	-22.55	44.79	22.24	167.49	V

- REMARKS:** 1. EIRP Output Power (dBm) = LVL (dBm) + Correction Factor (dB).
2. Correction factor (dB) = Free Space Loss + Antenna Factor + Cable Loss



LTE BAND 2

CHANNEL BANDWIDTH: 1.4MHz QPSK

Channel	Frequency (MHz)	LVL (dBm)	Correction Factor(dB)	EIRP(dBm)	EIRP(mW)	Polarization (H/V)	LIMIT (W)
18607	1850.7	-22.32	41.15	18.83	76.38	H	1
18900	1880.0	-22.24	41.89	19.65	92.26	H	1
19193	1909.3	-22.04	42.11	20.07	101.62	H	1
18607	1850.7	-30.77	43.87	13.10	20.42	V	1
18900	1880.0	-30.56	43.56	13.00	19.95	V	1
19193	1909.3	-30.41	44.35	13.94	24.77	V	1

NOTE: EIRP (dBm) = LVL (dBm) + Correction Factor (dB)

CHANNEL BANDWIDTH: 1.4MHz 16QAM

Channel	Frequency (MHz)	LVL (dBm)	Correction Factor(dB)	EIRP(dBm)	EIRP(mW)	Polarization (H/V)	LIMIT (W)
18607	1850.7	-23.00	41.15	18.15	65.31	H	1
18900	1880.0	-22.80	41.89	19.09	81.10	H	1
19193	1909.3	-22.66	42.11	19.45	88.10	H	1
18607	1850.7	-30.64	43.87	13.23	21.04	V	1
18900	1880.0	-30.48	43.56	13.08	20.32	V	1
19193	1909.3	-30.41	44.35	13.94	24.77	V	1

NOTE: EIRP (dBm) = LVL (dBm) + Correction Factor (dB)-2.15dB.

CHANNEL BANDWIDTH: 3MHz QPSK

Channel	Frequency (MHz)	LVL (dBm)	Correction Factor(dB)	EIRP(dBm)	EIRP(mW)	Polarization (H/V)	LIMIT (W)
18615	1851.5	-21.89	41.18	19.29	84.92	H	1
18900	1880.0	-22.05	41.89	19.84	96.38	H	1
19185	1908.5	-22.54	42.14	19.60	91.20	H	1
18615	1851.5	-31.24	43.77	12.53	17.91	V	1
18900	1880.0	-31.05	43.56	12.51	17.82	V	1
19185	1908.5	-30.86	44.31	13.45	22.13	V	1

NOTE: EIRP (dBm) = LVL (dBm) + Correction Factor (dB)



CHANNEL BANDWIDTH: 3MHz 16QAM

Channel	Frequency (MHz)	LVL (dBm)	Correction Factor(dB)	EIRP(dBm)	EIRP(mW)	Polarization (H/V)	LIMIT (W)
18615	1851.5	-23.18	41.18	18.00	63.10	H	1
18900	1880.0	-22.82	41.89	19.07	80.72	H	1
19185	1908.5	-22.64	42.14	19.50	89.13	H	1
18615	1851.5	-30.82	43.77	12.95	19.72	V	1
18900	1880.0	-30.50	43.56	13.06	20.23	V	1
19185	1908.5	-30.39	44.31	13.92	24.66	V	1

NOTE: EIRP (dBm) = LVL (dBm) + Correction Factor (dB)

CHANNEL BANDWIDTH: 5MHz QPSK

Channel	Frequency (MHz)	LVL (dBm)	Correction Factor(dB)	EIRP(dBm)	EIRP(mW)	Polarization (H/V)	LIMIT (W)
18625	1852.5	-21.69	41.27	19.58	90.78	H	1
18900	1880.0	-21.87	41.89	20.02	100.46	H	1
19175	1907.5	-21.98	42.29	20.31	107.40	H	1
18625	1852.5	-30.45	43.68	13.23	21.04	V	1
18900	1880.0	-30.62	43.56	12.94	19.68	V	1
19175	1907.5	-30.87	44.29	13.42	21.98	V	1

NOTE: EIRP (dBm) = LVL (dBm) + Correction Factor (dB)

CHANNEL BANDWIDTH: 5MHz 16QAM

Channel	Frequency (MHz)	LVL (dBm)	Correction Factor(dB)	EIRP(dBm)	EIRP(mW)	Polarization (H/V)	LIMIT (W)
18625	1852.5	-23.00	41.27	18.27	67.14	H	1
18900	1880.0	-22.90	41.89	18.99	79.25	H	1
19175	1907.5	-22.70	42.29	19.59	90.99	H	1
18625	1852.5	-30.64	43.68	13.04	20.14	V	1
18900	1880.0	-30.58	43.56	12.98	19.86	V	1
19175	1907.5	-30.45	44.29	13.84	24.21	V	1

NOTE: EIRP (dBm) = LVL (dBm) + Correction Factor (dB)



CHANNEL BANDWIDTH: 10MHz QPSK

Channel	Frequency (MHz)	LVL (dBm)	Correction Factor(dB)	EIRP(dBm)	EIRP(mW)	Polarization (H/V)	LIMIT (W)
18650	1855.0	-23.13	41.84	18.71	74.30	H	1
18900	1880.0	-22.92	41.89	18.97	78.89	H	1
19150	1905.0	-22.63	42.79	20.16	103.75	H	1
18650	1855.0	-30.77	43.61	12.84	19.23	V	1
18900	1880.0	-30.60	43.56	12.96	19.77	V	1
19150	1905.0	-30.38	44.21	13.83	24.15	V	1

NOTE: EIRP (dBm) = LVL (dBm) + Correction Factor (dB)

CHANNEL BANDWIDTH: 10MHz 16QAM

Channel	Frequency (MHz)	LVL (dBm)	Correction Factor(dB)	EIRP(dBm)	EIRP(mW)	Polarization (H/V)	LIMIT (W)
18650	1855.0	-22.78	41.84	19.06	80.54	H	1
18900	1880.0	-22.30	41.89	19.59	90.99	H	1
19150	1905.0	-22.66	42.79	20.13	103.04	H	1
18650	1855.0	-30.82	43.61	12.79	19.01	V	1
18900	1880.0	-30.62	43.56	12.94	19.68	V	1
19150	1905.0	-30.69	44.21	13.52	22.49	V	1

NOTE: EIRP (dBm) = LVL (dBm) + Correction Factor (dB)

CHANNEL BANDWIDTH: 15MHz QPSK

Channel	Frequency (MHz)	LVL (dBm)	Correction Factor(dB)	EIRP(dBm)	EIRP(mW)	Polarization (H/V)	LIMIT (W)
18675	1857.5	-22.85	42.23	19.38	86.70	H	1
18900	1880.0	-22.76	41.89	19.13	81.85	H	1
19125	1902.5	-22.39	42.67	20.28	106.66	H	1
18675	1857.5	-30.49	43.61	13.12	20.51	V	1
18900	1880.0	-30.44	43.56	13.12	20.51	V	1
19125	1902.5	-30.14	44.34	14.20	26.30	V	1

NOTE: EIRP (dBm) = LVL (dBm) + Correction Factor (dB)



CHANNEL BANDWIDTH: 15MHz 16QAM

Channel	Frequency (MHz)	LVL (dBm)	Correction Factor(dB)	EIRP(dBm)	EIRP(mW)	Polarization (H/V)	LIMIT (W)
18675	1857.5	-22.24	42.23	19.99	99.77	H	1
18900	1880.0	-22.56	41.89	19.33	85.70	H	1
19125	1902.5	-22.75	42.67	19.92	98.17	H	1
18675	1857.5	-30.87	43.61	12.74	18.79	V	1
18900	1880.0	-30.69	43.56	12.87	19.36	V	1
19125	1902.5	-30.45	44.34	13.89	24.49	V	1

NOTE: EIRP (dBm) = LVL (dBm) + Correction Factor (dB)

CHANNEL BANDWIDTH: 20MHz QPSK

Channel	Frequency (MHz)	LVL (dBm)	Correction Factor(dB)	EIRP(dBm)	EIRP(mW)	Polarization (H/V)	LIMIT (W)
18700	1860.0	-22.57	42.02	19.45	88.10	H	1
18900	1880.0	-22.34	41.89	19.55	90.16	H	1
19100	1900.0	-22.12	42.37	20.25	105.93	H	1
18700	1860.0	-30.21	43.83	13.62	23.01	V	1
18900	1880.0	-30.02	43.56	13.54	22.59	V	1
19100	1900.0	-29.87	44.74	14.87	30.69	V	1

NOTE: EIRP (dBm) = LVL (dBm) + Correction Factor (dB)

CHANNEL BANDWIDTH: 20MHz 16QAM

Channel	Frequency (MHz)	LVL (dBm)	Correction Factor(dB)	EIRP(dBm)	EIRP(mW)	Polarization (H/V)	LIMIT (W)
18700	1860.0	-23.50	42.02	18.52	71.12	H	1
18900	1880.0	-23.41	41.89	18.48	70.47	H	1
19100	1900.0	-22.95	42.37	19.42	87.50	H	1
18700	1860.0	-31.14	43.83	12.69	18.58	V	1
18900	1880.0	-31.09	43.56	12.47	17.66	V	1
19100	1900.0	-30.70	44.74	14.04	25.35	V	1

NOTE: EIRP (dBm) = LVL (dBm) + Correction Factor (dB)



4.2 FREQUENCY STABILITY MEASUREMENT

4.2.1 LIMITS OF FREQUENCY STABILITY MEASUREMENT

The frequency stability shall be sufficient to ensure that the fundamental emission stays within the authorized frequency block.

4.2.2 TEST PROCEDURE

- Device is placed at the oven room. The oven room could control the temperatures and humidity. Power warm up is at least 15 min and power applied should perform before recording frequency error.
- EUT is connected the external power supply to control the DC input power. The test voltage range is from minimum to maximum working voltage. Each step shall be record the frequency error rate.
- The temperature range step is 10 degrees in this test items. All temperature levels shall be hold the $\pm 0.5^{\circ}\text{C}$ during the measurement testing. The each temperature step shall be at least 0.5 hours, consider the EUT could be test under the stability condition.

NOTE: The frequency error was recorded frequency error from the communication simulator.

4.2.3 TEST SETUP

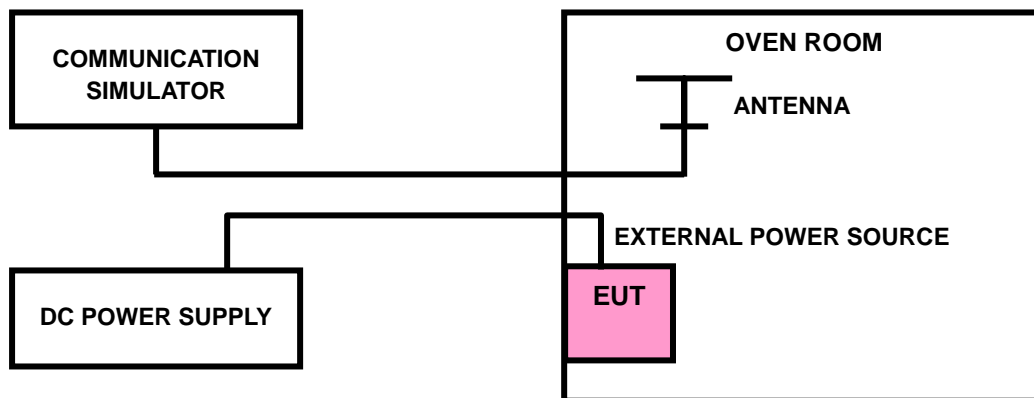



4.2.4 TEST RESULTS

FREQUENCY ERROR VS. VOLTAGE

VOLTAGE (Volts)	FREQUENCY ERROR (ppm)			LIMIT (ppm)
	GSM	EDGE	WCDMA	
3.8	-0.008	-0.008	0.008	2.5
3.4	-0.007	-0.008	0.007	2.5
4.35	-0.006	-0.007	0.006	2.5

NOTE: The applicant defined the normal working voltage of the battery is from 3.4Vdc to 4.35Vdc.

FREQUENCY ERROR vs. TEMPERATURE.

TEMP. (°C)	FREQUENCY ERROR (PPM)			LIMIT (PPM)
	GSM	EDGE	WCDMA	
-30	-0.013	-0.013	-0.009	2.5
-20	-0.010	-0.012	-0.008	2.5
-10	-0.010	-0.011	-0.007	2.5
0	-0.009	-0.010	-0.002	2.5
10	-0.009	-0.010	0.003	2.5
20	-0.008	-0.009	0.003	2.5
30	-0.008	-0.008	0.004	2.5
40	-0.007	-0.008	0.008	2.5
50	0.002	0.002	0.009	2.5
60	0.005	0.006	0.008	2.5



LTE BAND 2

AFC FREQUENCY ERROR vs. VOLTAGE							
VOLTAGE (Volts)	FREQUENCY ERROR (ppm)						LIMIT (ppm)
	1.4MHz	3MHz	5MHz	10MHz	15MHz	20MHz	
3.8	-0.010	-0.011	-0.009	0.004	-0.010	-0.010	2.5
3.4	-0.004	-0.008	0.002	0.005	-0.005	-0.004	2.5
4.35	0.006	0.004	0.008	0.007	0.003	0.003	2.5

NOTE: The applicant defined the normal working voltage of the battery is from 3.4Vdc to 4.35Vdc.

AFC FREQUENCY ERROR vs. TEMPERATURE							
TEMP. (°C)	FREQUENCY ERROR (ppm)						LIMIT (ppm)
	1.4MHz	3MHz	5MHz	10MHz	15MHz	20MHz	
-30	-0.007	-0.008	-0.007	-0.007	-0.007	-0.007	2.5
-20	-0.005	-0.007	-0.006	-0.006	-0.006	-0.006	2.5
-10	-0.004	-0.005	-0.005	-0.005	-0.005	-0.005	2.5
0	-0.003	-0.004	-0.004	-0.004	-0.004	-0.004	2.5
10	-0.002	-0.003	-0.003	-0.003	-0.003	-0.003	2.5
20	-0.001	-0.002	-0.002	-0.001	-0.001	-0.002	2.5
30	0.000	-0.001	-0.001	0.001	0.001	-0.001	2.5
40	0.001	0.001	0.001	0.002	0.003	0.001	2.5
50	0.002	0.003	0.003	0.003	0.005	0.003	2.5
60	0.003	0.004	0.005	0.004	0.006	0.004	2.5



4.3 OCCUPIED BANDWIDTH MEASUREMENT

4.3.1 TEST PROCEDURES

The EUT makes a call to the communication simulator. All measurements were done at low, middle and high operational frequency range. The communication simulator station system controlled a EUT to export maximum output power under transmission mode and specific channel frequency. Use OBW measurement function of Spectrum analyzer to measure 99 % occupied bandwidth.

4.3.2 TEST SETUP

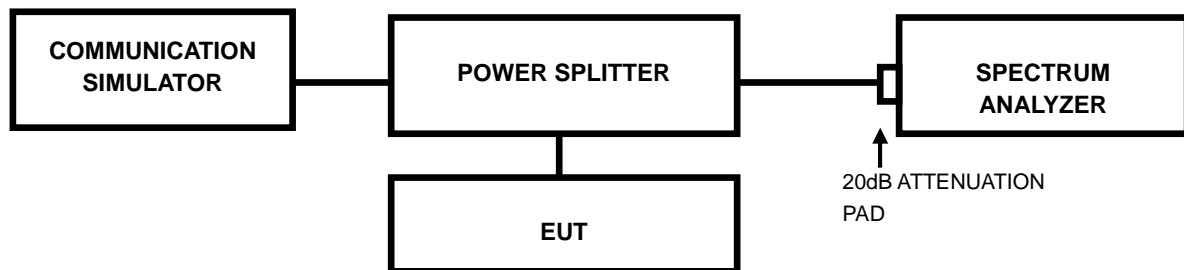



4.3.3 TEST RESULTS

CHANNEL	FREQUENCY (MHz)	99% OCCUPIED BANDWIDTH (kHz)		CHANNEL	FREQUENCY (MHz)	99% OCCUPIED BANDWIDTH (MHz)
		GSM	EDGE			WCDMA
512	1850.2	248.00	246.00	9262	1852.4	4.16
661	1880.0	244.00	246.00	9400	1880.0	4.16
810	1909.8	244.00	250.00	9538	1907.6	4.16

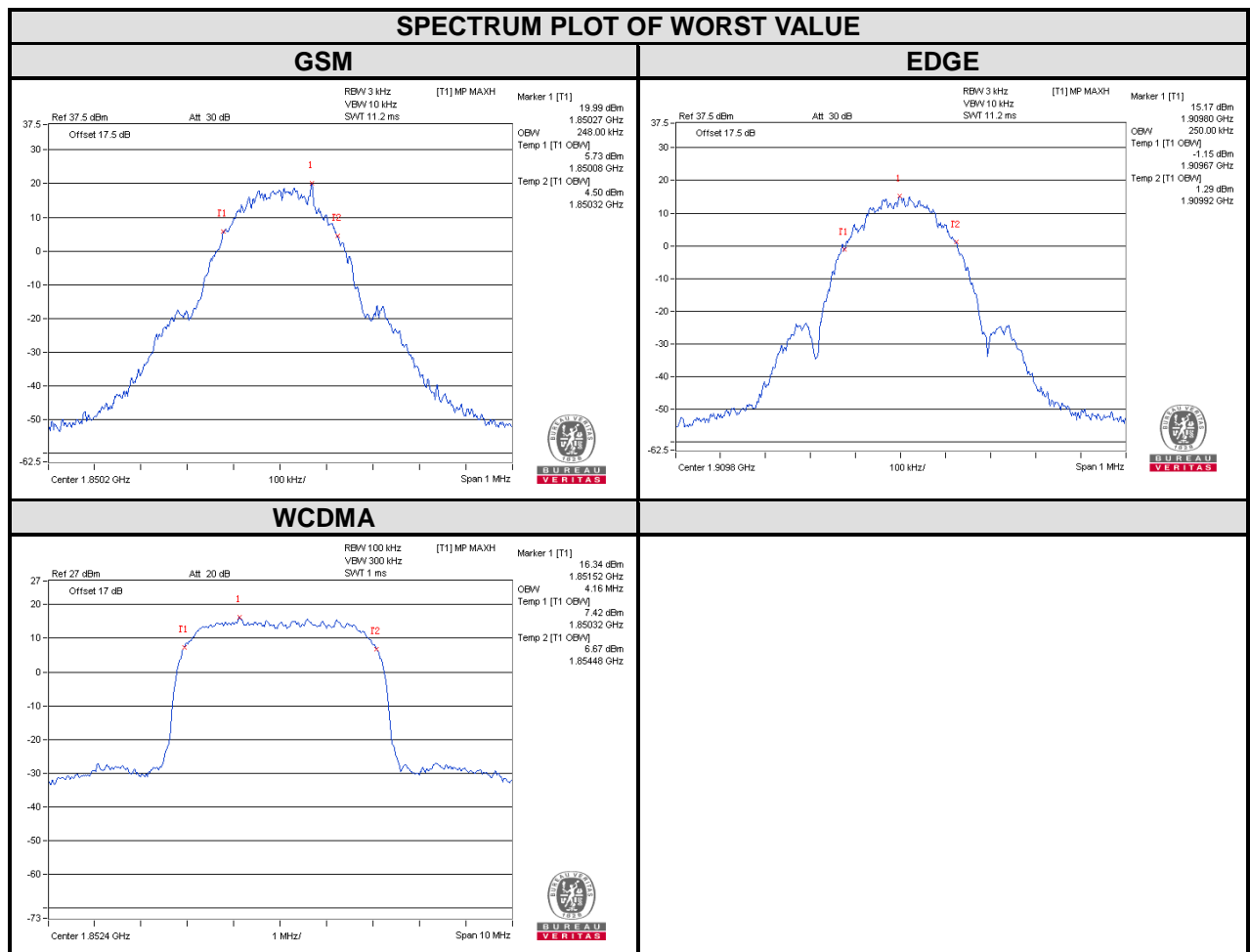



CHANNEL	FREQUENCY (MHz)	26dB BANDWIDTH (kHz)		CHANNEL	FREQUENCY (MHz)	26dB BANDWIDTH (MHz)
		GSM	EDGE			WCDMA
512	1850.2	325.728	314.538	9262	1852.4	4.683
661	1880.0	322.271	319.627	9400	1880.0	4.678
810	1909.8	317.781	322.063	9538	1907.6	4.683

SPECTRUM PLOT OF WORST VALUE

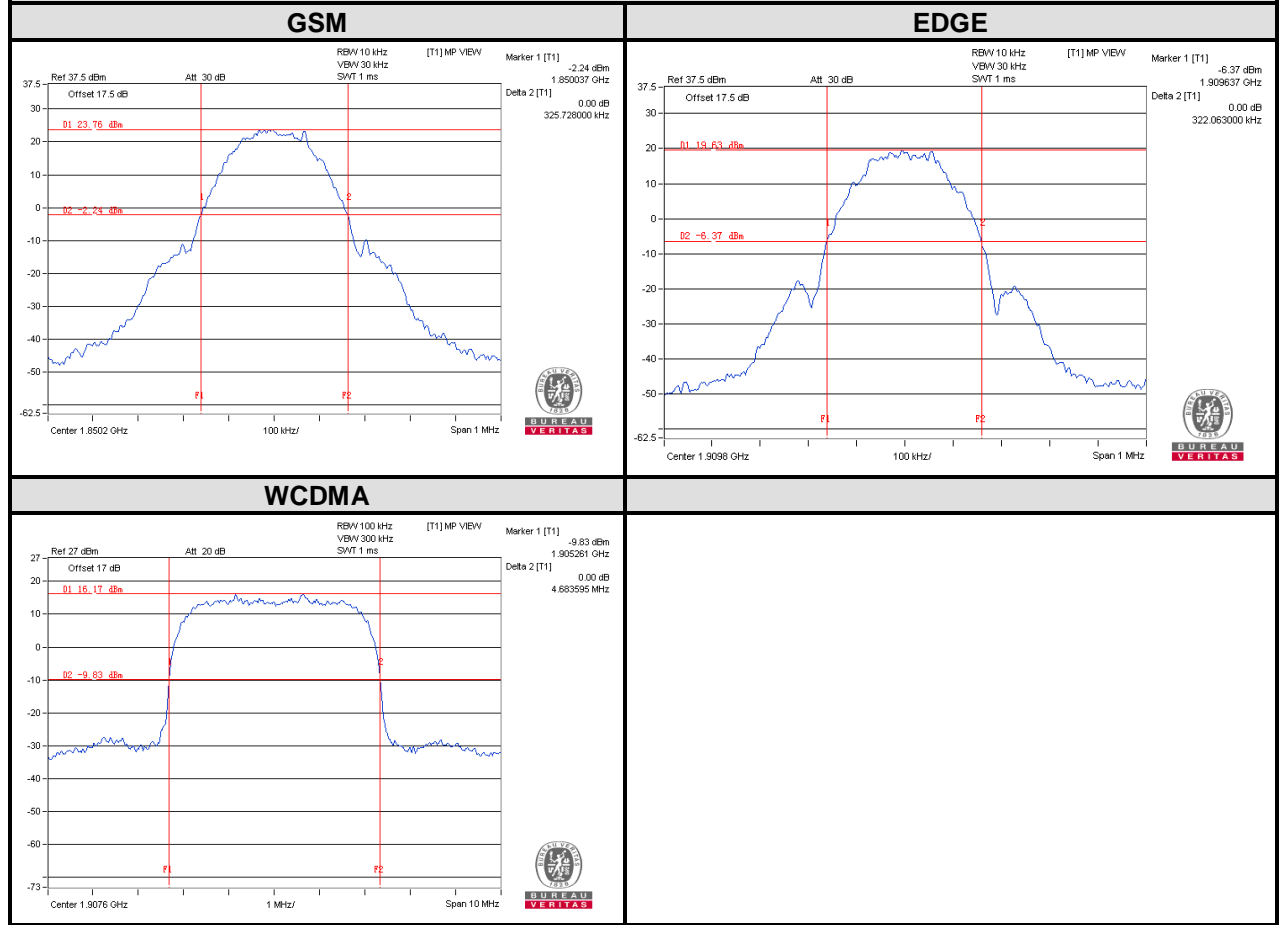



LTE band 2							
Channel Bandwidth : 1.4MHz							
Channel	Frequency (MHz)	99% Occupied bandwidth (MHz)		Channel	Frequency (MHz)	26 dB bandwidth (MHz)	
		QPSK	16QAM			QPSK	16QAM
18607	1850.7	1.08	1.09	18607	1850.7	1.27	1.29
18900	1880	1.09	1.08	18900	1880	1.27	1.28
19193	1909.3	1.09	1.09	19193	1909.3	1.27	1.28

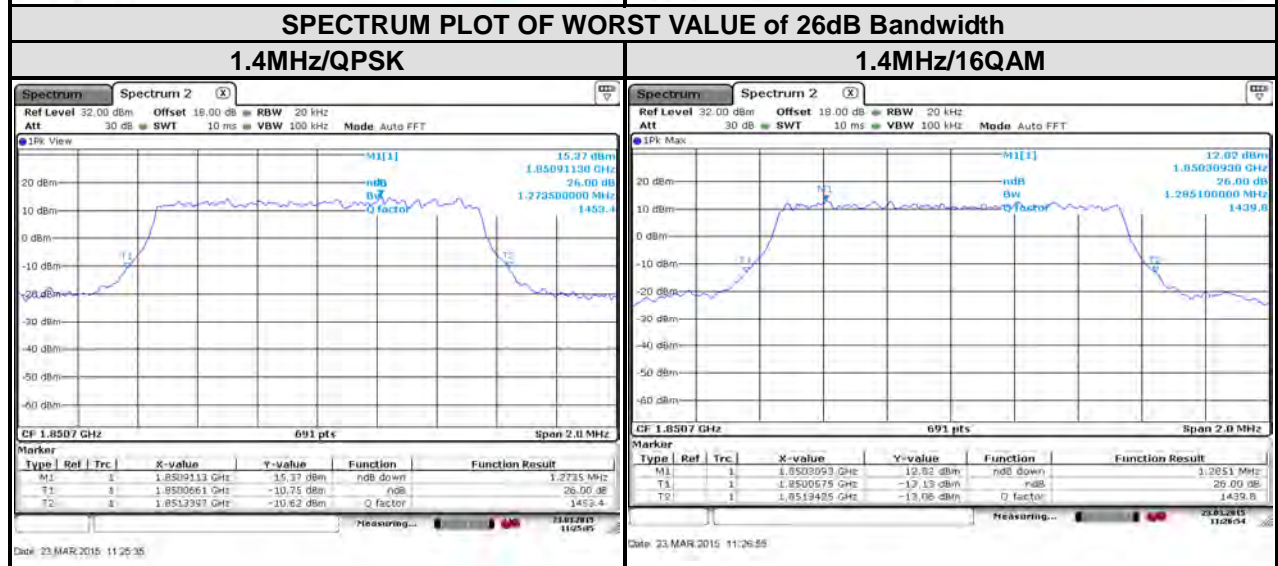
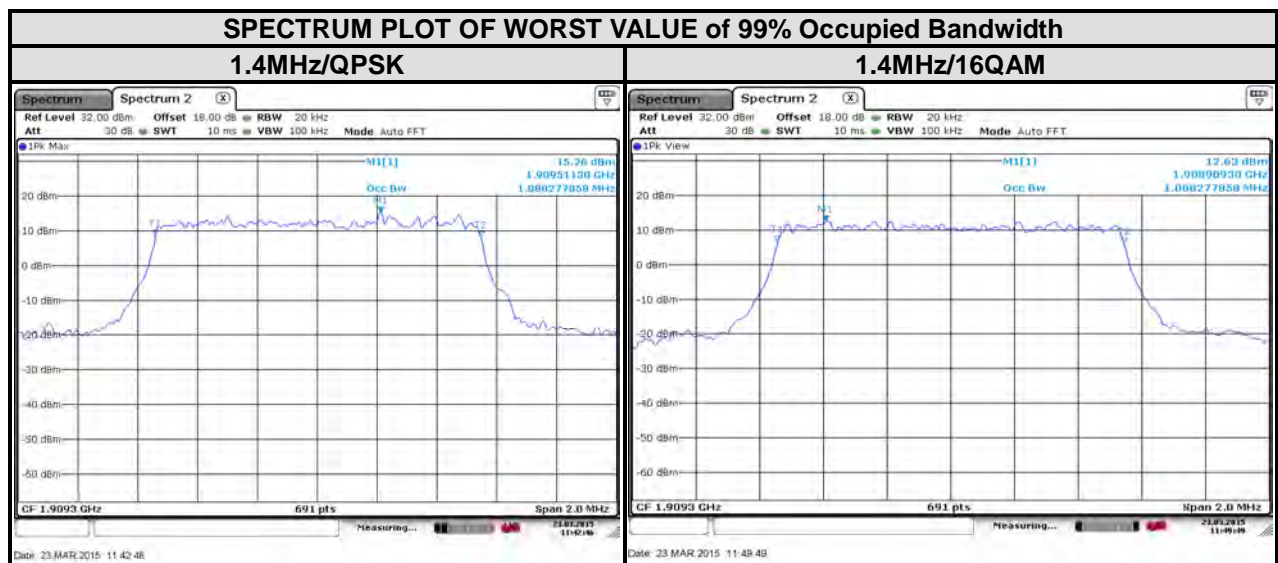



LTE band 2							
Channel Bandwidth : 3MHz							
Channel	Frequency (MHz)	99% Occupied bandwidth (MHz)		Channel	Frequency (MHz)	26 dB bandwidth (MHz)	
		QPSK	16QAM			QPSK	16QAM
18615	1851.5	2.68	2.68	18615	1851.5	2.96	2.94
18900	1880	2.68	2.68	18900	1880	2.93	2.92
19185	1908.5	2.68	2.68	19185	1908.5	2.96	2.92

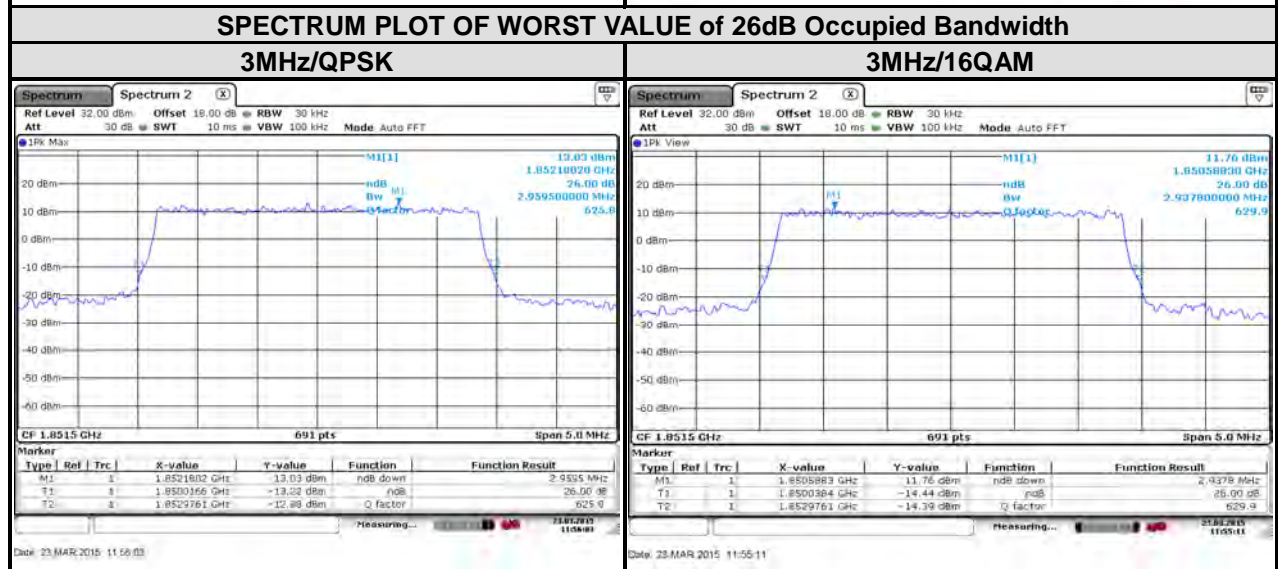
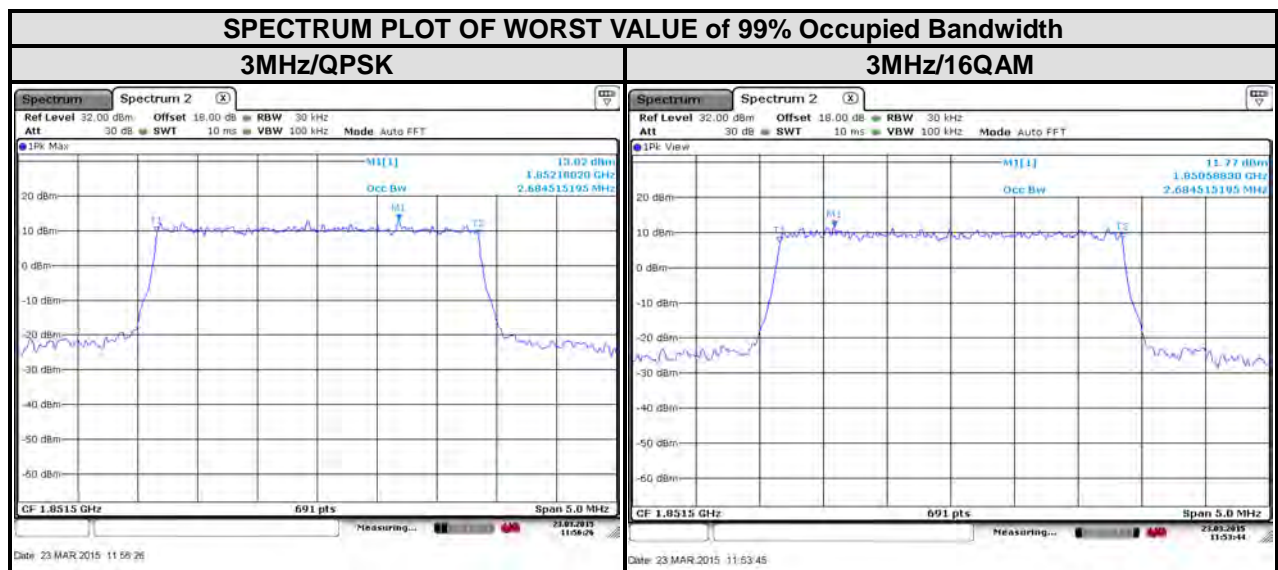



LTE band 2							
Channel Bandwidth : 5 MHz							
Channel	Frequency (MHz)	99% Occupied bandwidth (MHz)		Channel	Frequency (MHz)	26 dB bandwidth (MHz)	
		QPSK	16QAM			QPSK	16QAM
18625	1852.5	4.49	4.47	18625	1852.5	4.89	4.91
18900	1880	4.49	4.46	18900	1880	4.92	4.88
19175	1907.5	4.47	4.46	19175	1907.5	4.89	4.91

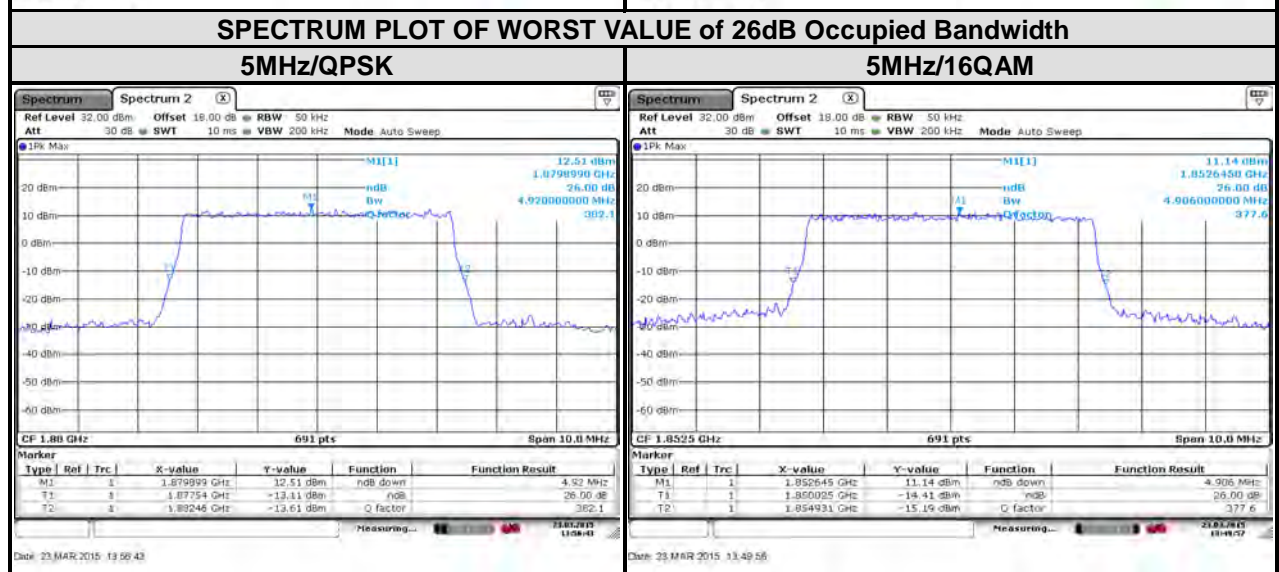
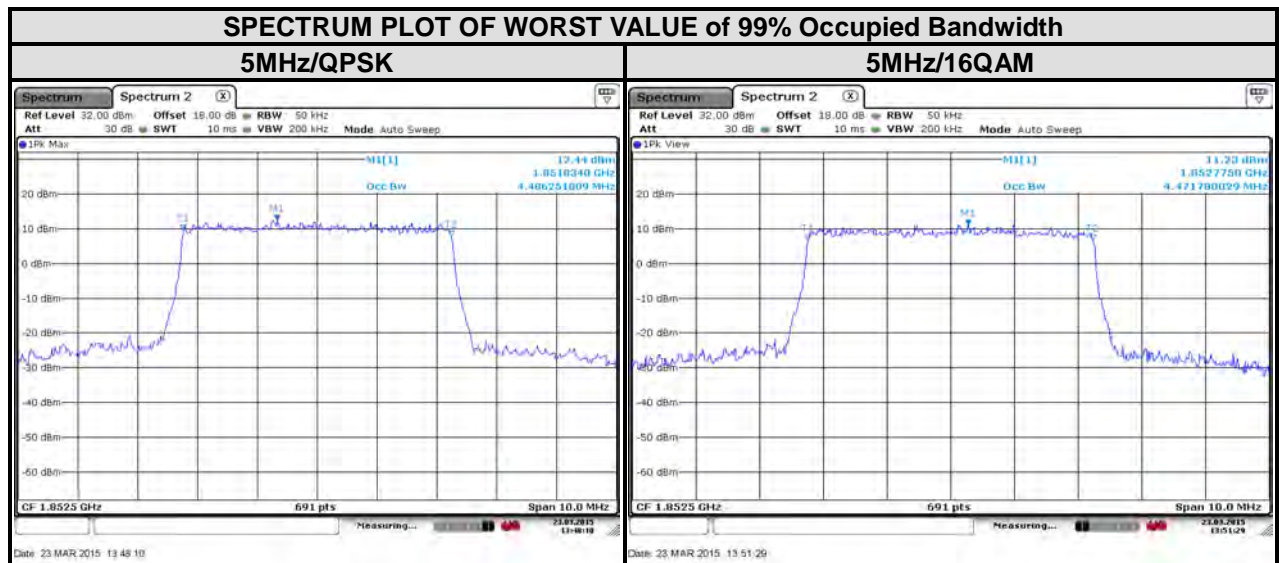



LTE band 2							
Channel Bandwidth : 10 MHz							
Channel	Frequency (MHz)	99% Occupied bandwidth (MHz)		Channel	Frequency (MHz)	26 dB bandwidth (MHz)	
		QPSK	16QAM			QPSK	16QAM
18650	1855	8.94	8.91	18650	1855	9.75	9.73
18900	1880	8.91	8.91	18900	1880	9.73	9.73
19150	1905	8.94	8.97	19150	1905	9.73	9.75

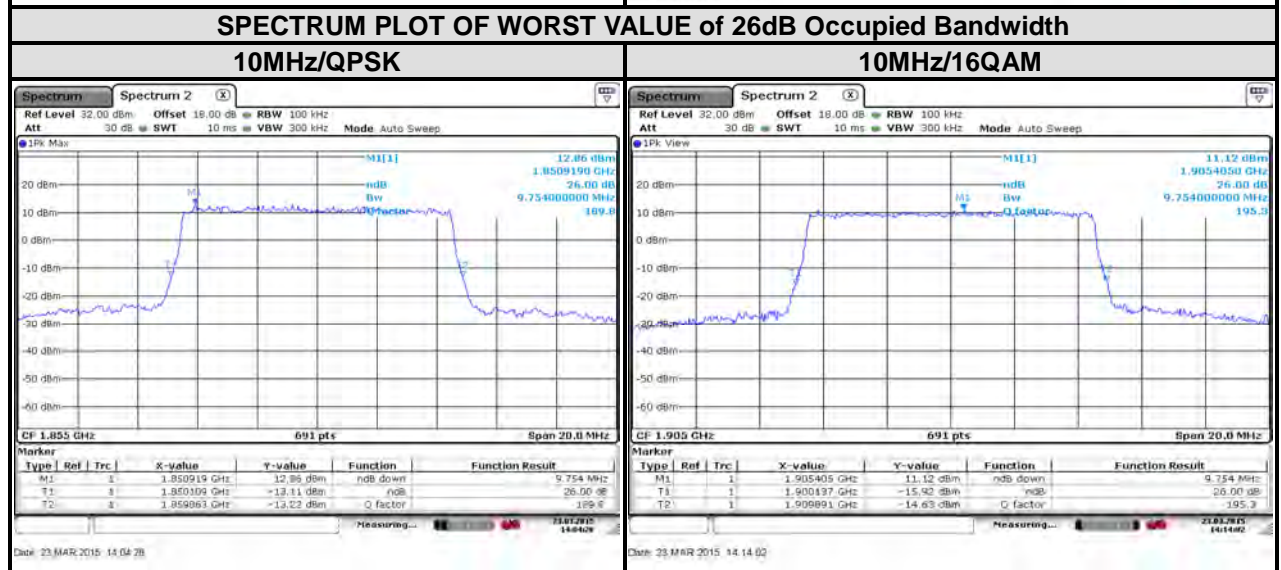
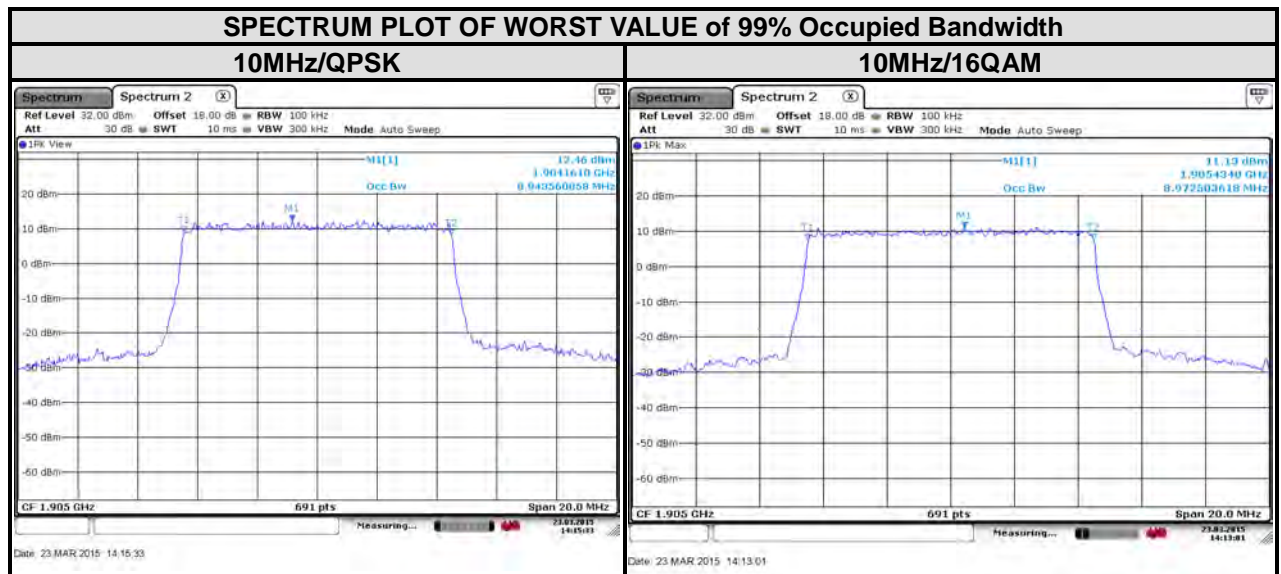



LTE band 2							
Channel Bandwidth : 15 MHz							
Channel	Frequency (MHz)	99% Occupied bandwidth (MHz)		Channel	Frequency (MHz)	26 dB bandwidth (MHz)	
		QPSK	16QAM			QPSK	16QAM
18675	1857.5	13.42	13.42	18675	1857.5	14.46	14.59
18900	1880	13.37	13.37	18900	1880	14.54	14.59
19125	1902.5	13.42	13.42	19125	1902.5	14.63	14.59

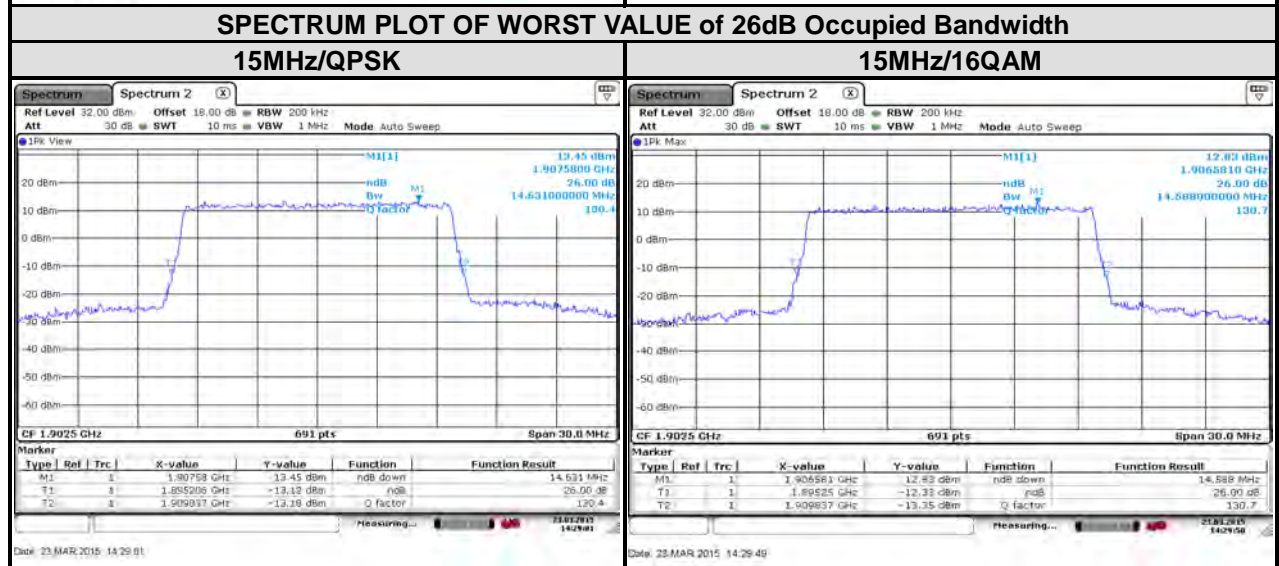
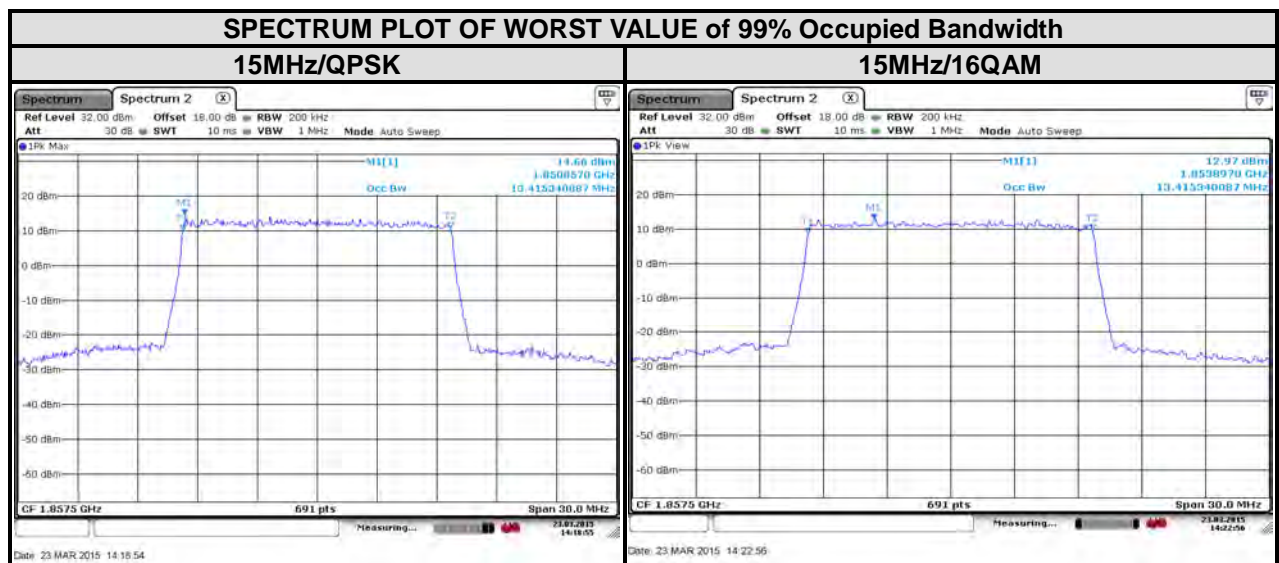



LTE band 2							
Channel Bandwidth : 20 MHz							
Channel	Frequency (MHz)	99% Occupied bandwidth (MHz)		Channel	Frequency (MHz)	26 dB bandwidth (MHz)	
		QPSK	16QAM			QPSK	16QAM
18700	1860	17.89	17.89	18700	1860	19.22	19.22
18900	1880	17.89	17.83	18900	1880	19.10	18.99
19100	1900	17.89	17.83	19100	1900	19.05	19.10

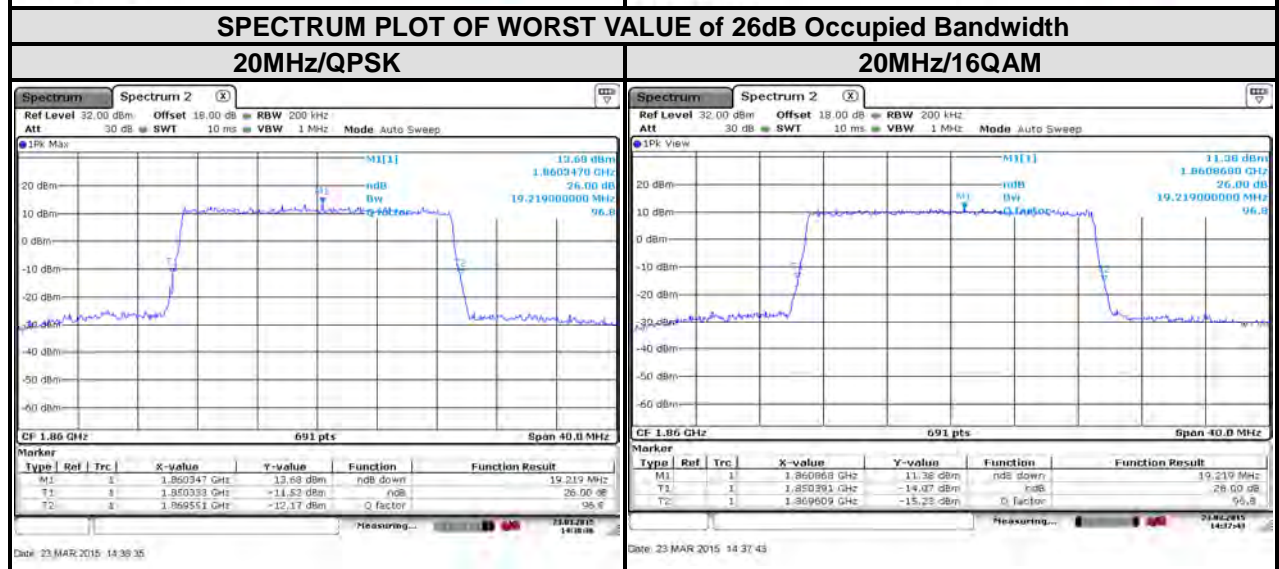
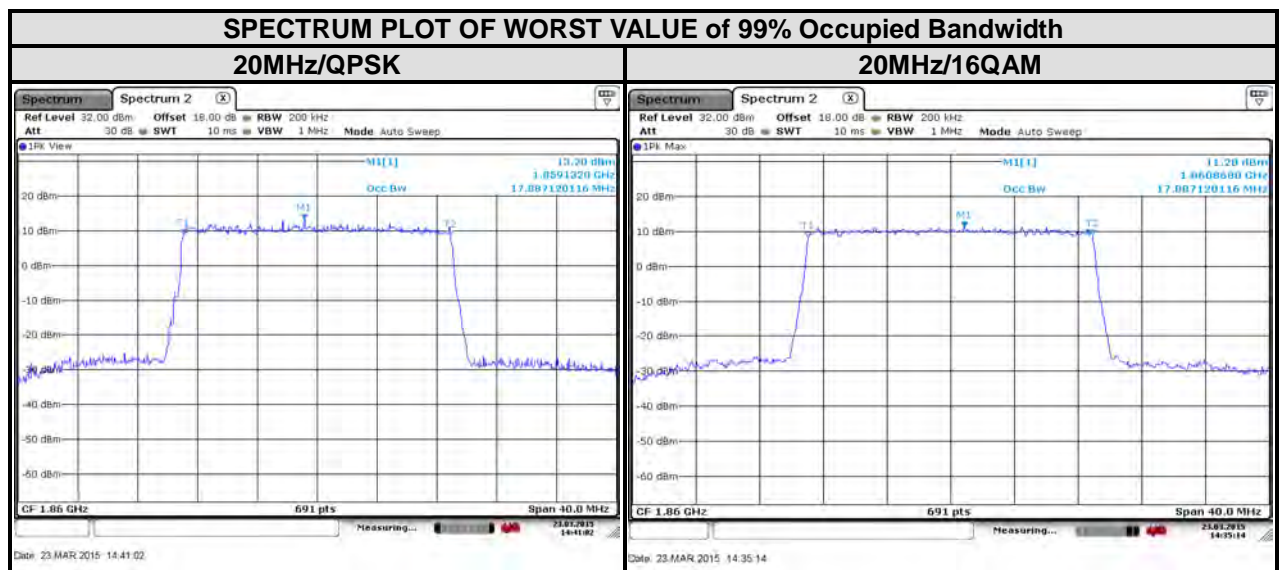

4.4 BAND EDGE MEASUREMENT

4.4.1 LIMITS OF BAND EDGE MEASUREMENT

Power of any emission outside of the authorized operating frequency ranges must be attenuated below the transmitting power (P) by a factor of at least $43 + 10 \log(P)$ dB. In the 1 MHz bands immediately outside and adjacent to the frequency block a resolution bandwidth of at least one percent of the emission bandwidth of the fundamental emission of the transmitter may be employed.

4.4.2 TEST SETUP

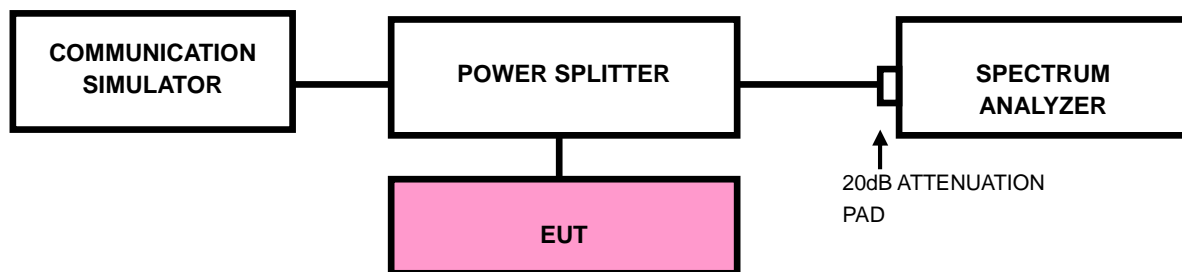

4.4.3 TEST PROCEDURES

- a. All measurements were done at low and high operational frequency range.
- b. The center frequency of spectrum is the band edge frequency and span is 1.5 MHz. RBW of the spectrum is 10kHz and VBW of the spectrum is 30kHz (GSM/GPRS/EDGE).
- c. The center frequency of spectrum is the band edge frequency and span is 10MHz. RB of the spectrum is 100kHz and VB of the spectrum is 300kHz (WCDMA).
- d. The center frequency of spectrum is the band edge frequency and span is 1~5 MHz. RB of the spectrum is 20kHz and VB of the spectrum is 100 kHz. (LTE bandwidth 1.4MHz)
- e. The center frequency of spectrum is the band edge frequency and span is 1~5 MHz. RB of the spectrum is 30kHz and VB of the spectrum is 100kHz. (LTE bandwidth 3MHz)
- f. The center frequency of spectrum is the band edge frequency and span is 1~5 MHz.



- RB of the spectrum is 50kHz and VB of the spectrum is 200kHz. (LTE bandwidth 5MHz)
- g. The center frequency of spectrum is the band edge frequency and span is 1~5 MHz. RB of the spectrum is 100kHz and VB of the spectrum is 300kHz. (LTE bandwidth 10MHz)
 - h. The center frequency of spectrum is the band edge frequency and span is 1~5 MHz. RB of the spectrum is 200kHz and VB of the spectrum is 1MHz. (LTE bandwidth 15MHz)
 - i. The center frequency of spectrum is the band edge frequency and span is 1~5 MHz. RB of the spectrum is 200kHz and VB of the spectrum is 1MHz. (LTE bandwidth 20MHz)
 - j. Record the max trace plot into the test report.



4.4.4. TEST RESULTS

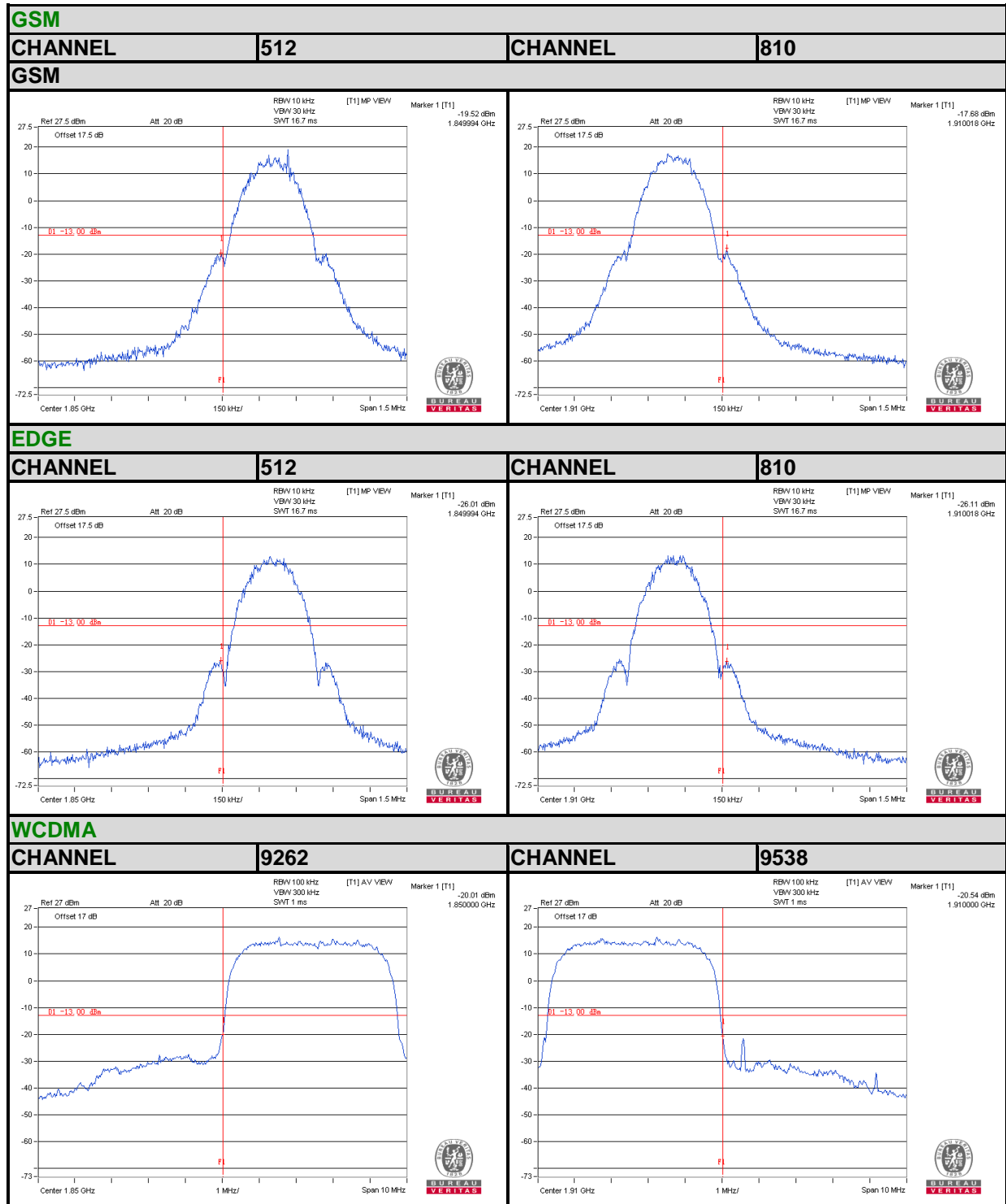



LTE BAND 2

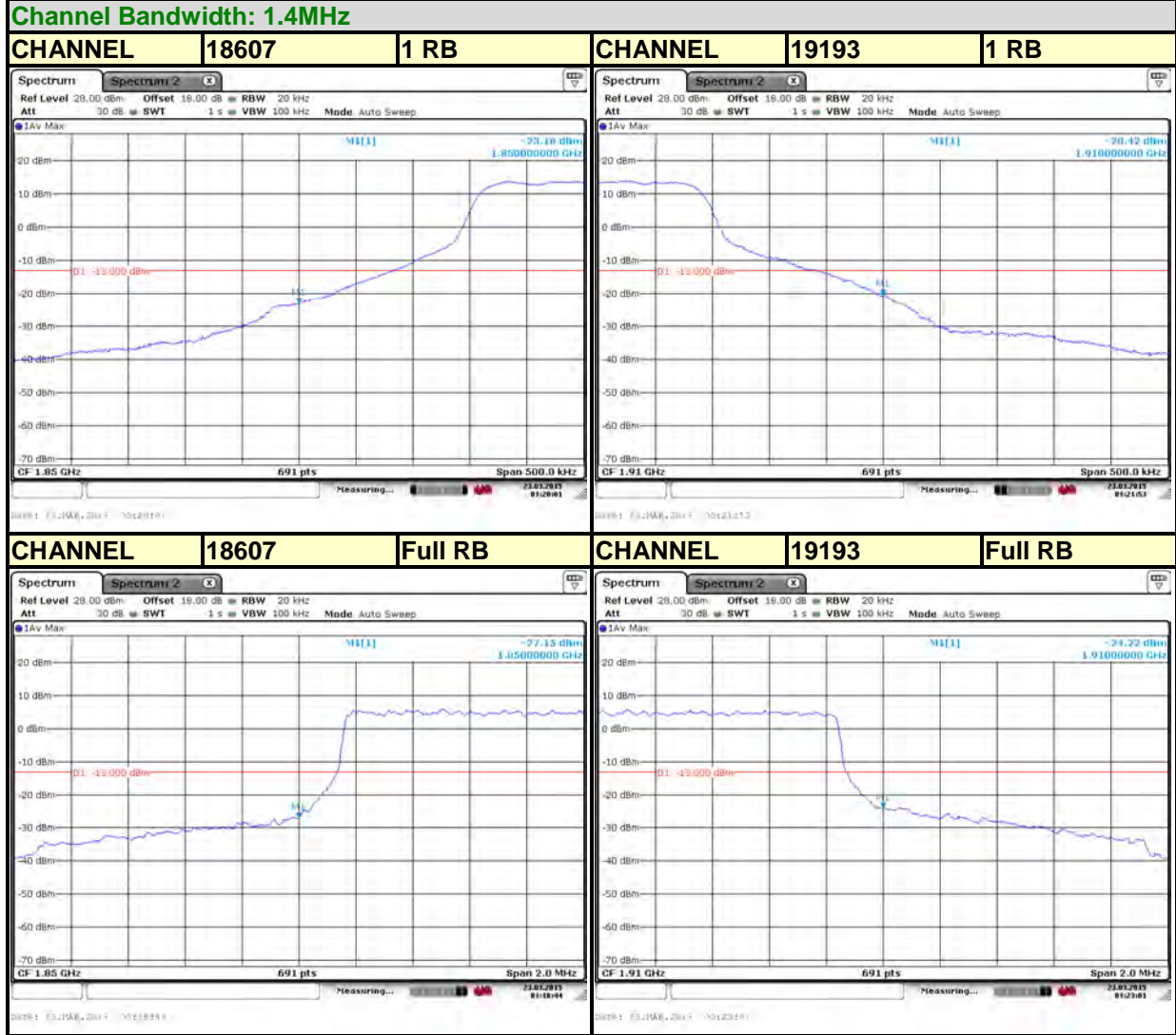



LTE BAND 2

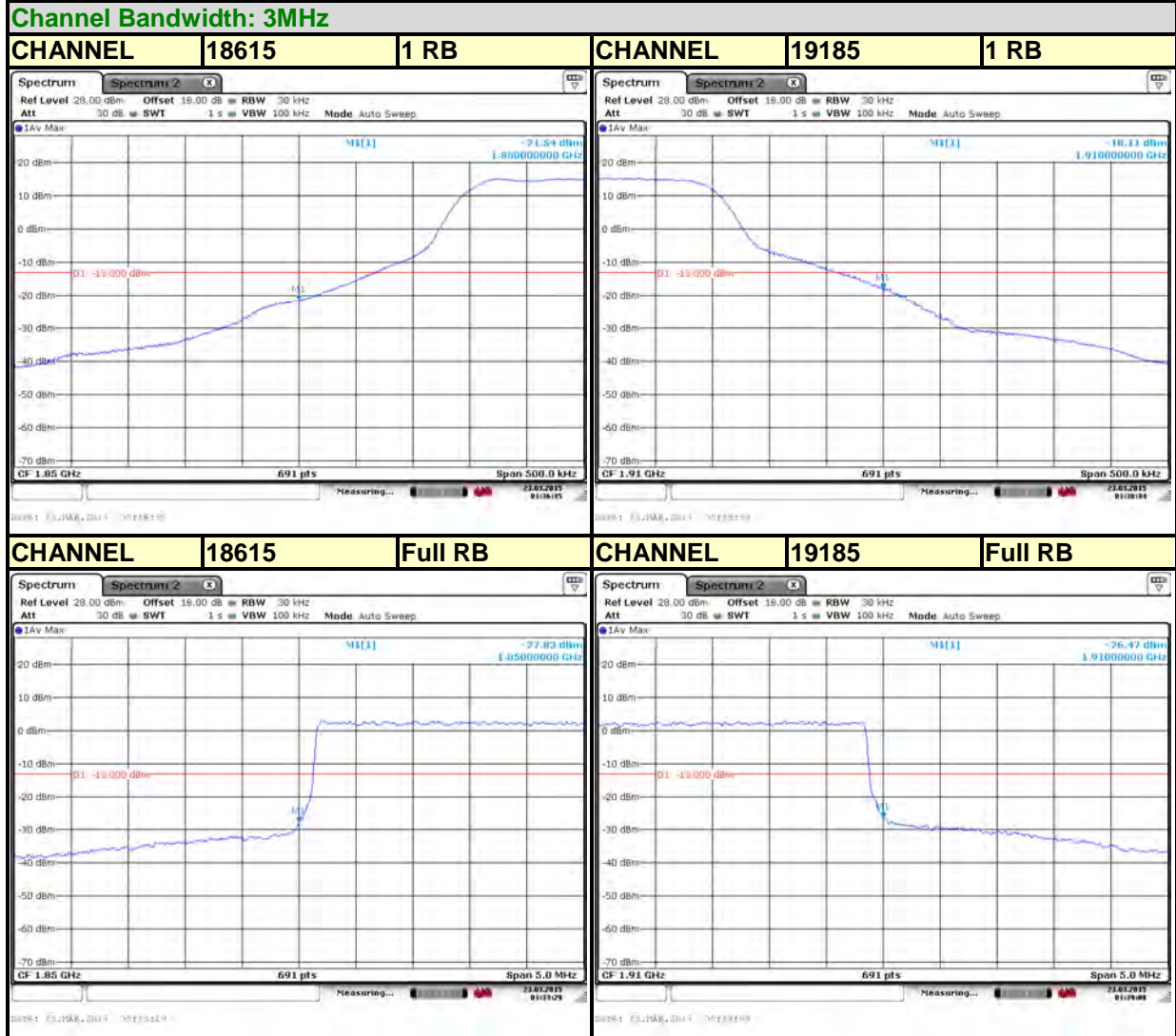



LTE BAND 2

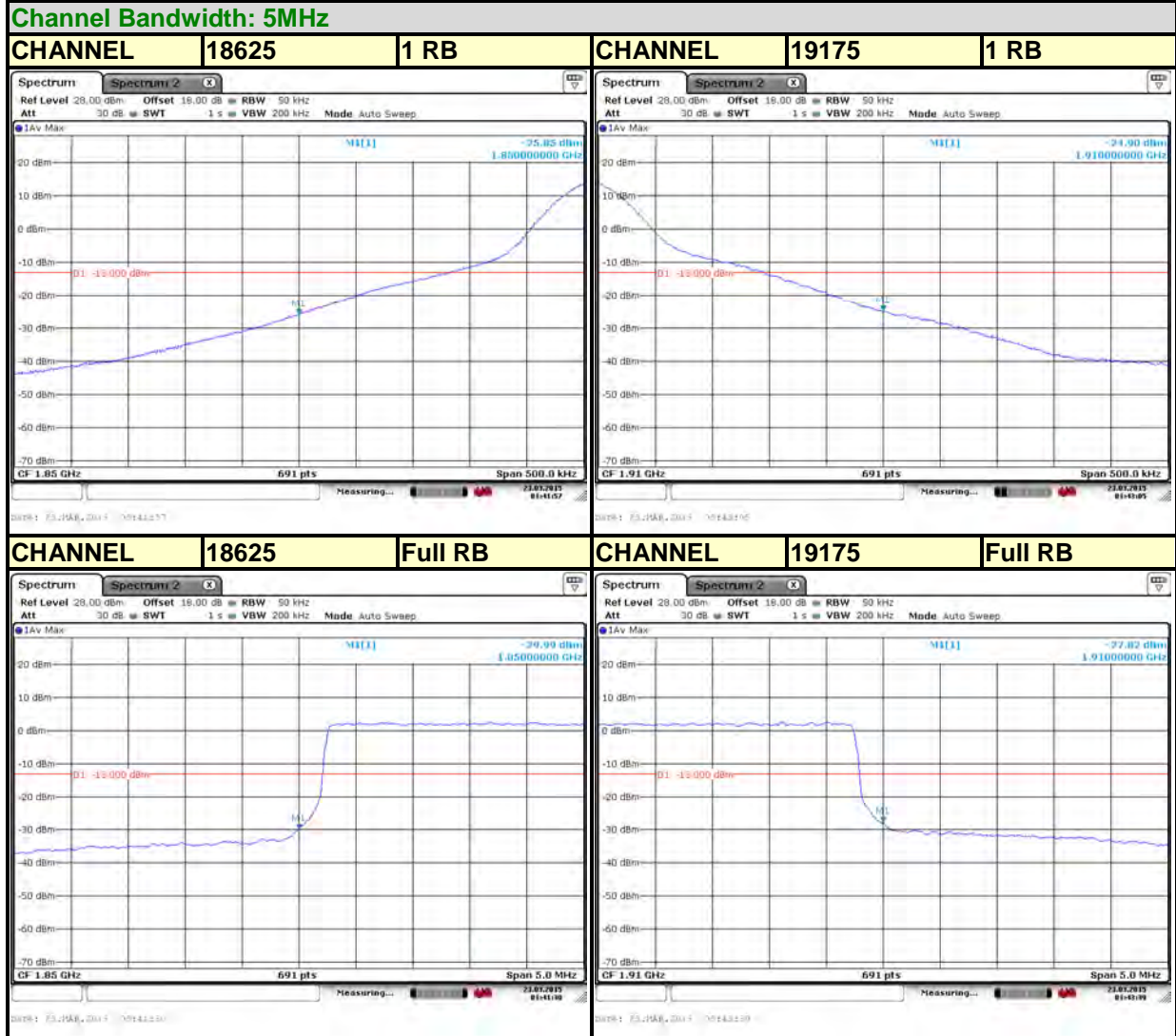



LTE BAND 2

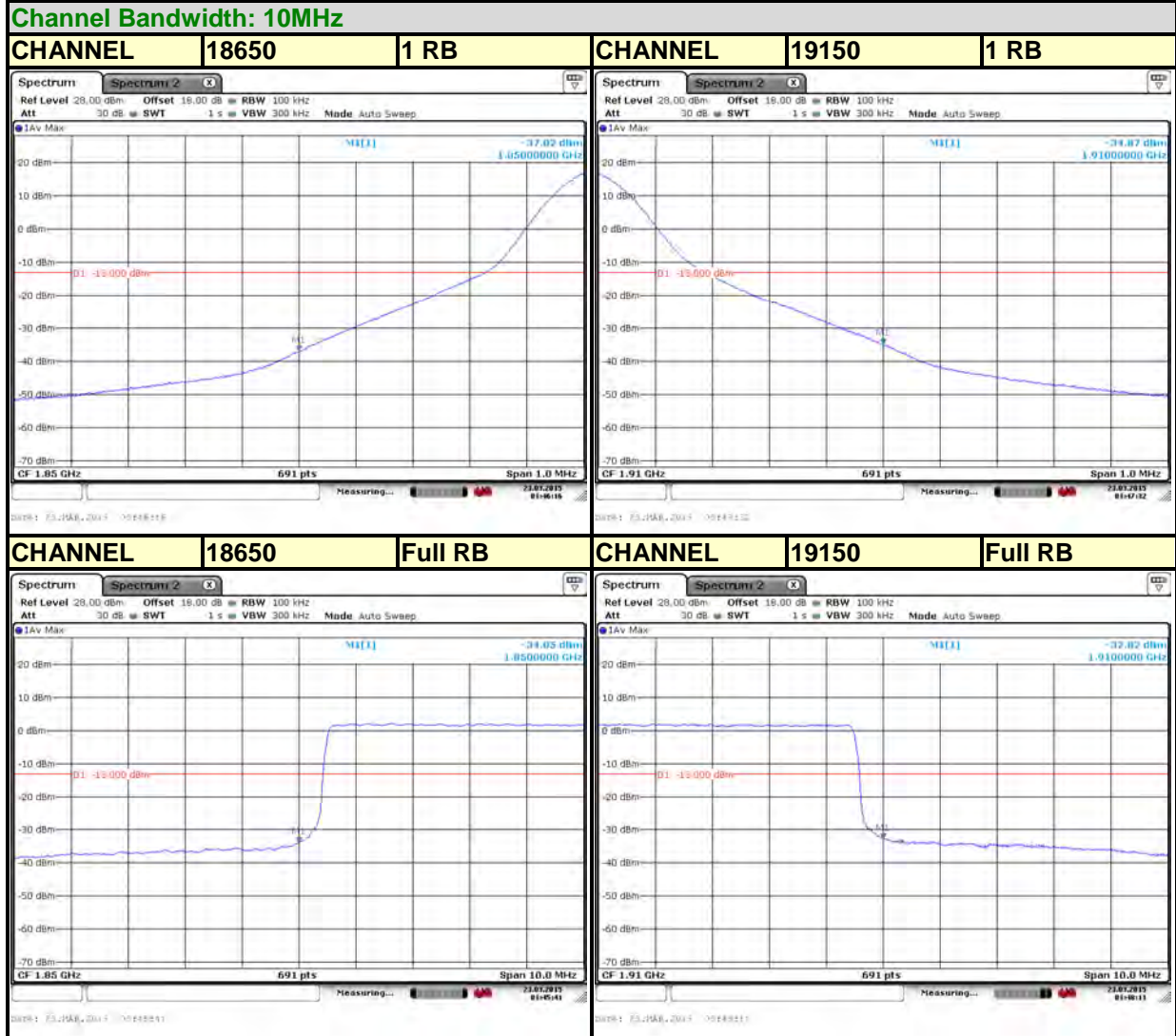



LTE BAND 2

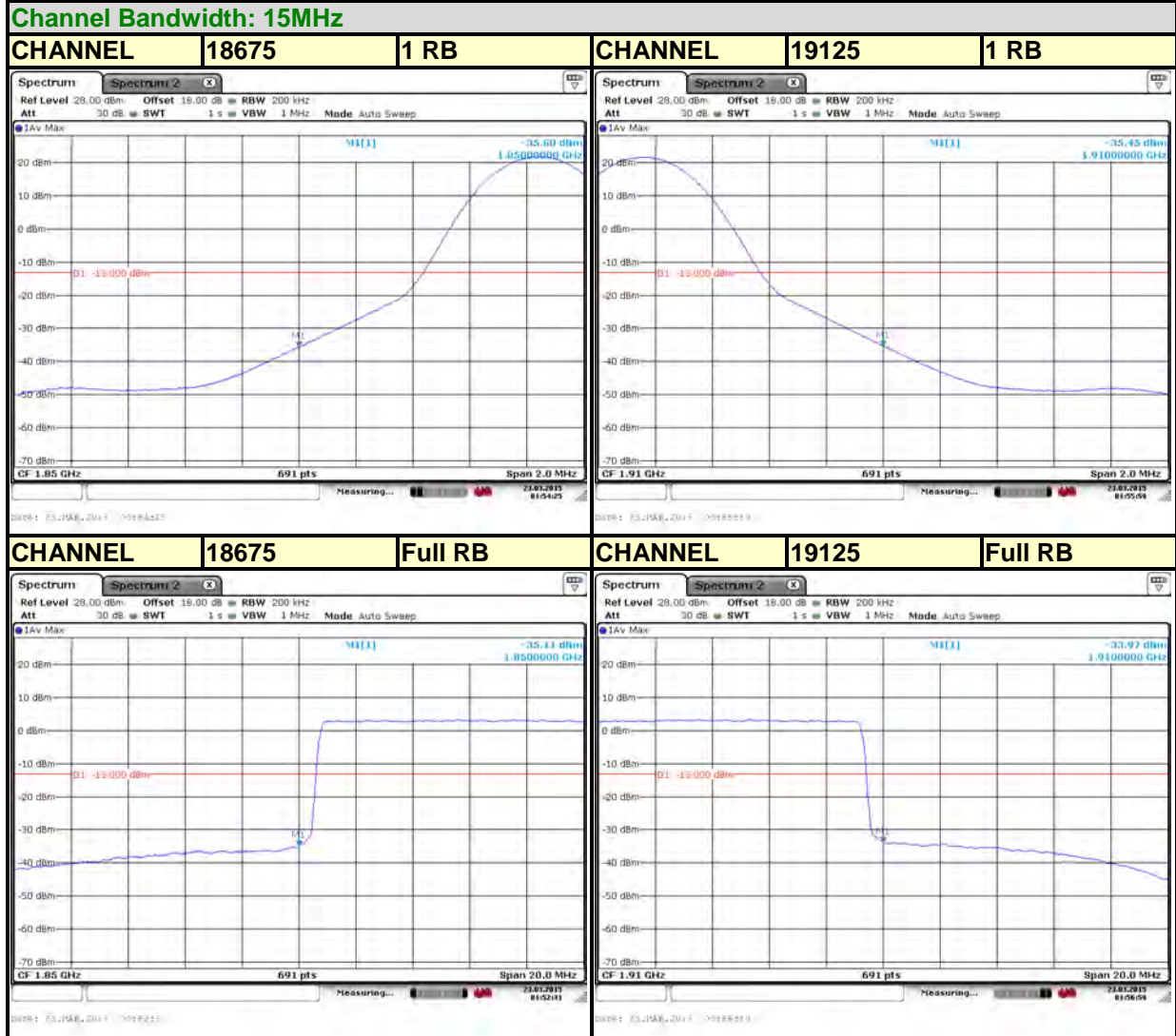



LTE BAND 2

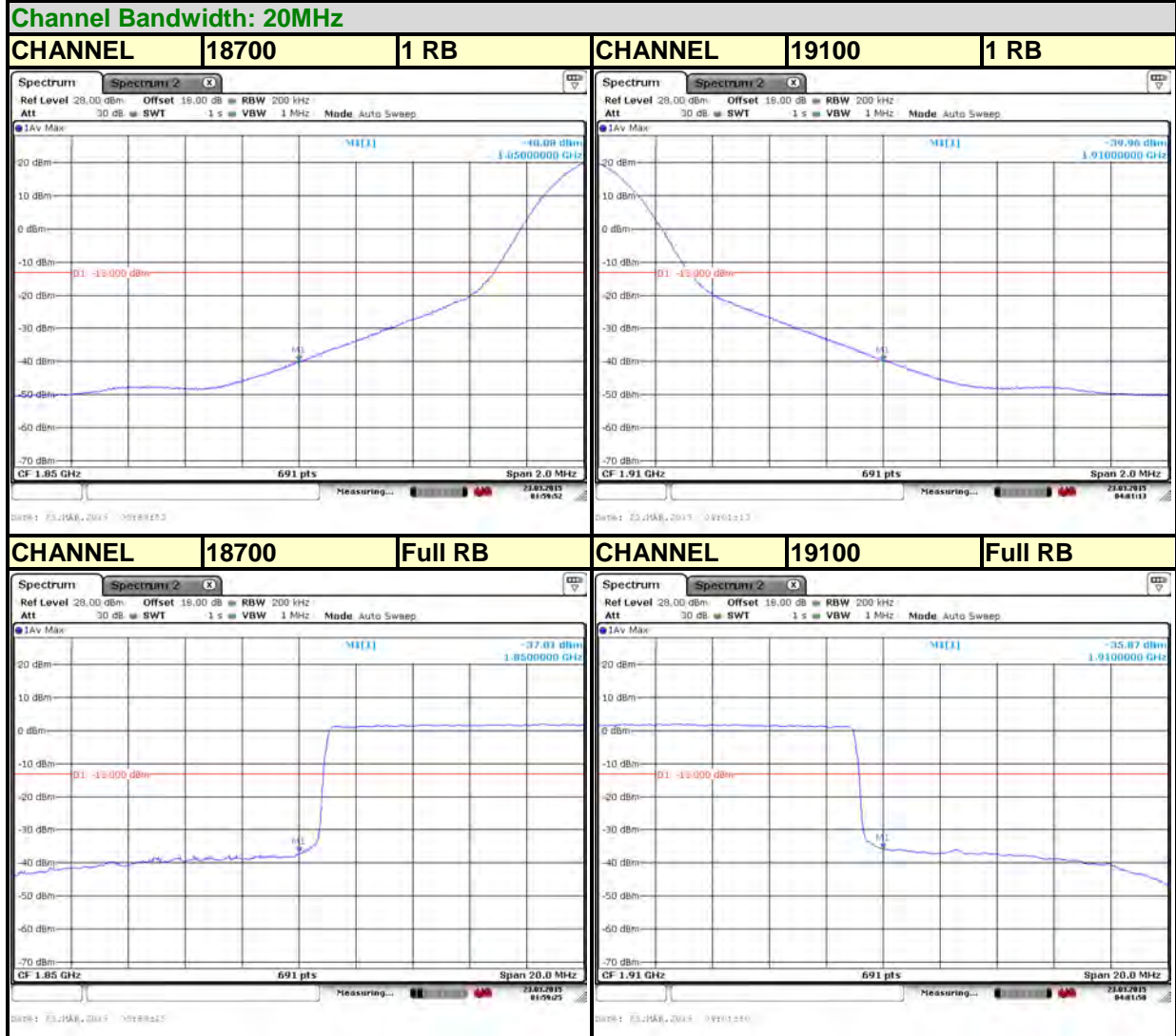



4.5 CONDUCTED SPURIOUS EMISSIONS

4.5.1 LIMITS OF CONDUCTED SPURIOUS EMISSIONS MEASUREMENT

The power of any emission outside of the authorized operating frequency ranges must be attenuated below the transmitting power (P) by a factor of at least $43 + 10 \log(P)$ dB. The emission limit equal to -13dBm .

4.5.2 TEST PROCEDURE

- a. The EUT makes a phone call to the communication simulator. All measurements were done at low, middle and high operational frequency range.
- b. Measuring frequency range is from 9 kHz to 19.1GHz. 20dB attenuation pad is connected with spectrum. RBW=1MHz and VBW=3MHz is used for conducted emission measurement.

4.5.3 TEST SETUP

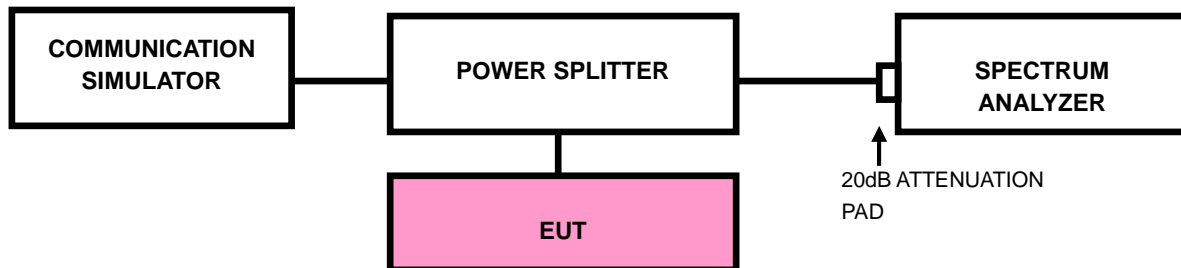



4.5.4 TEST RESULTS

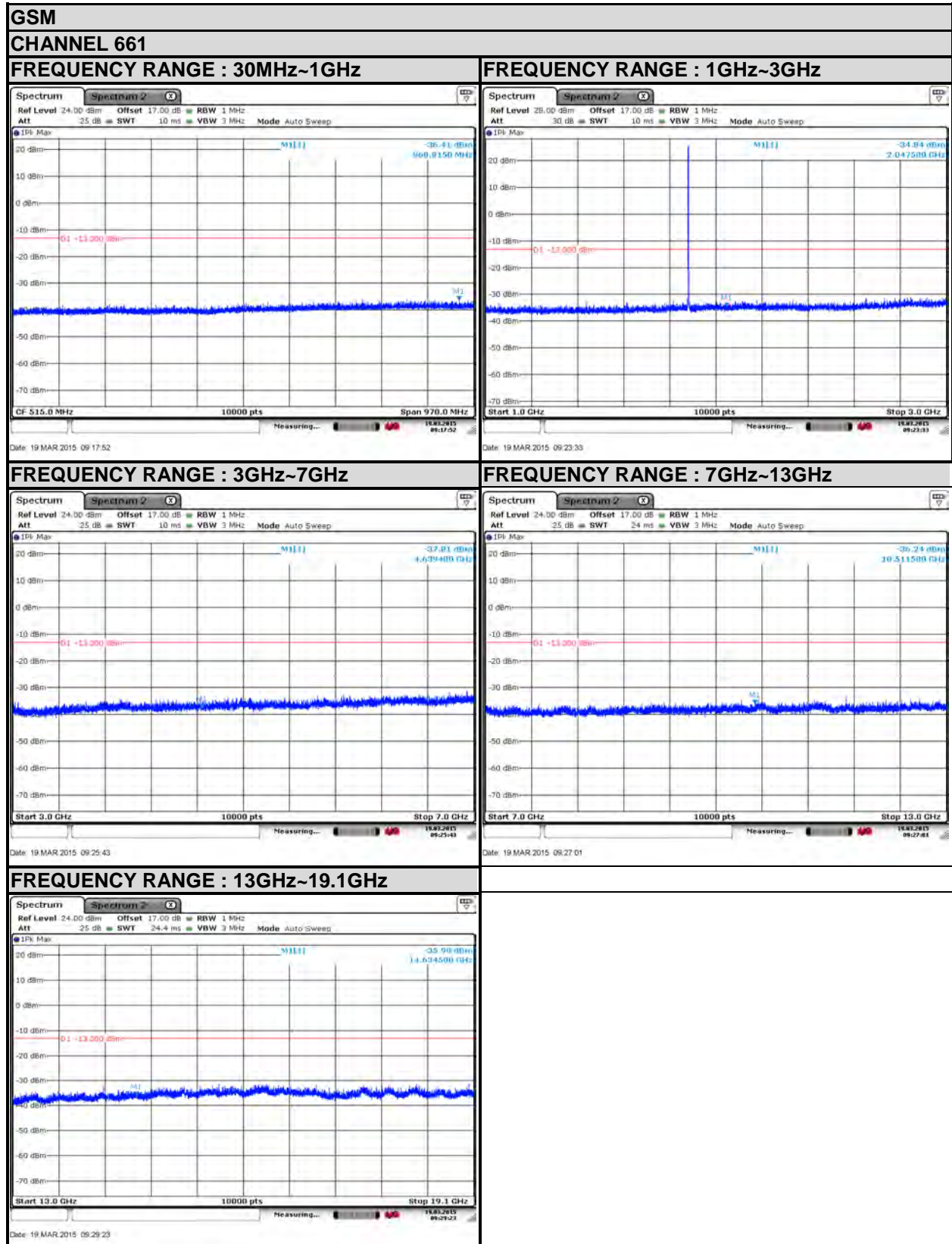

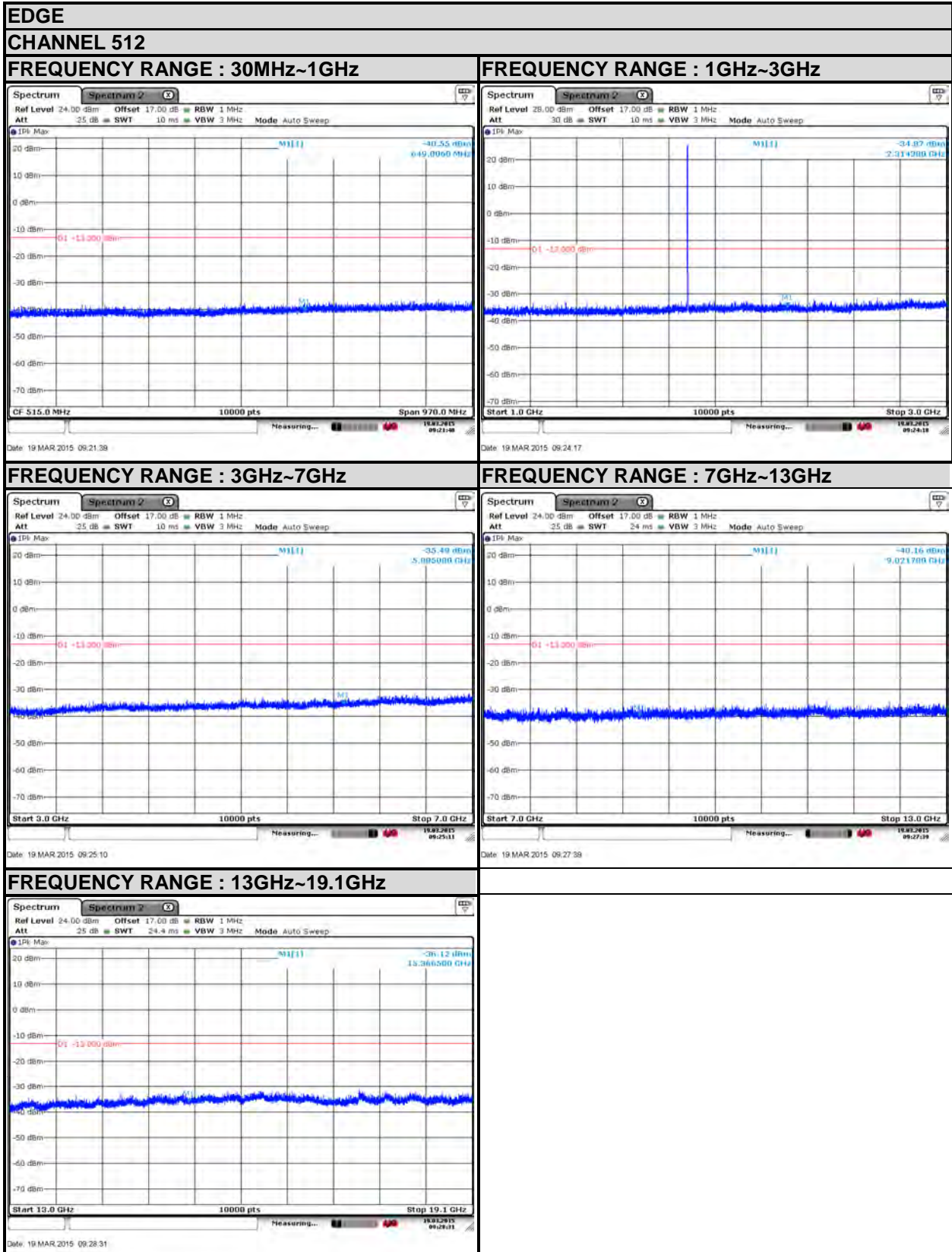

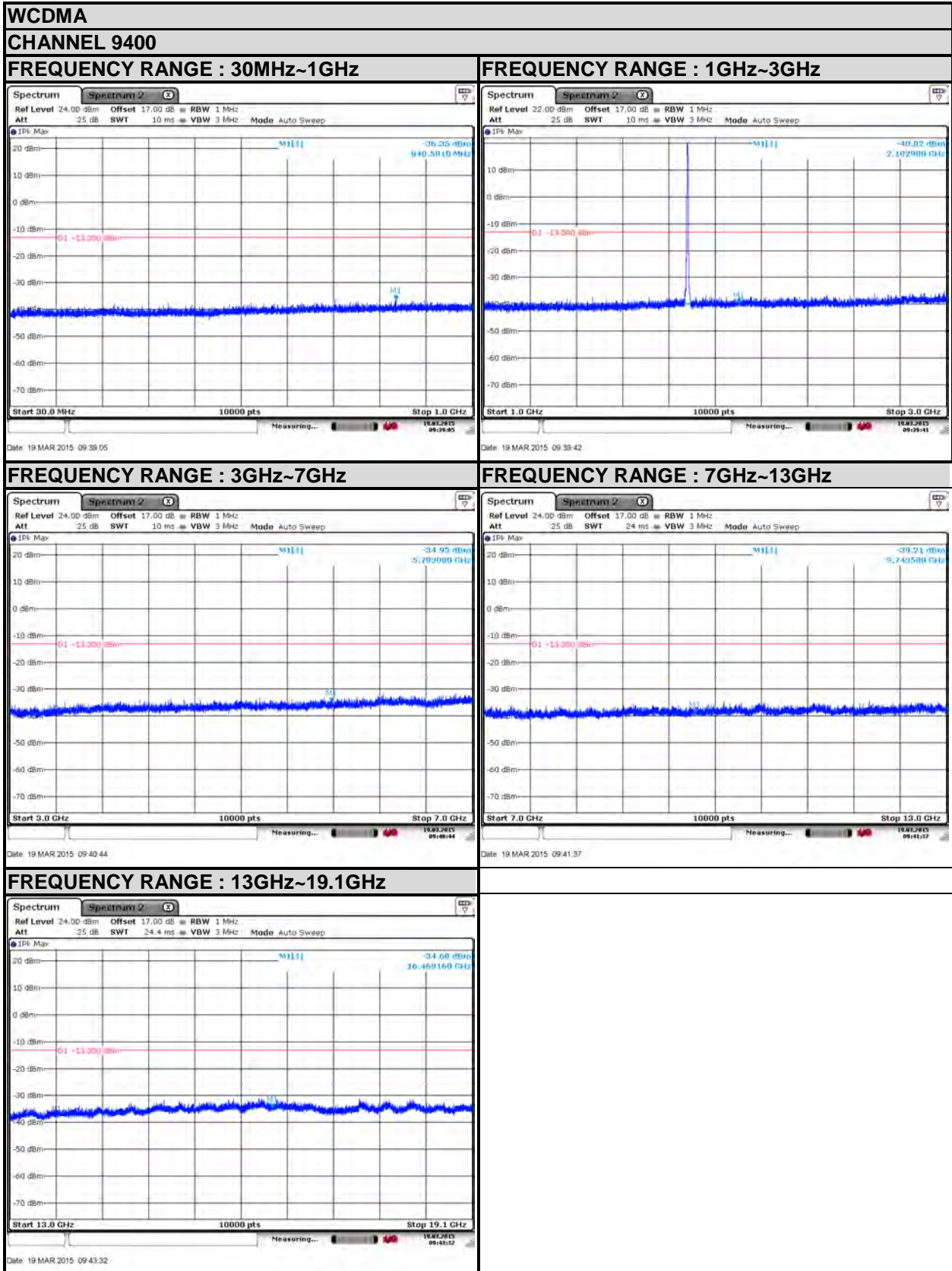



LTE BAND 2

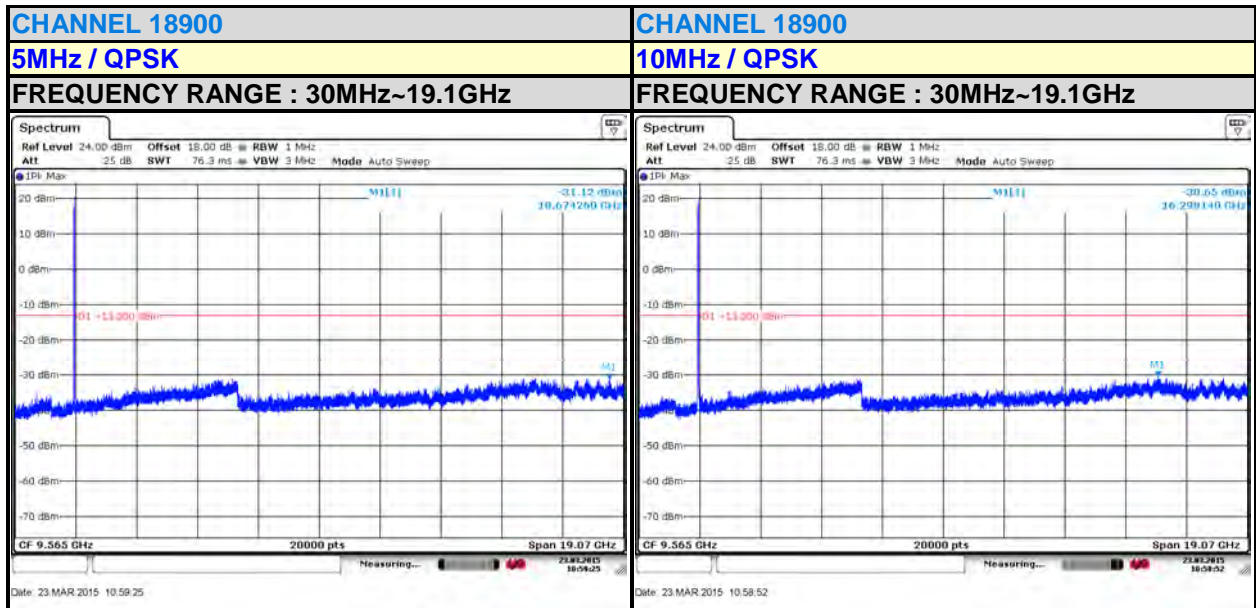
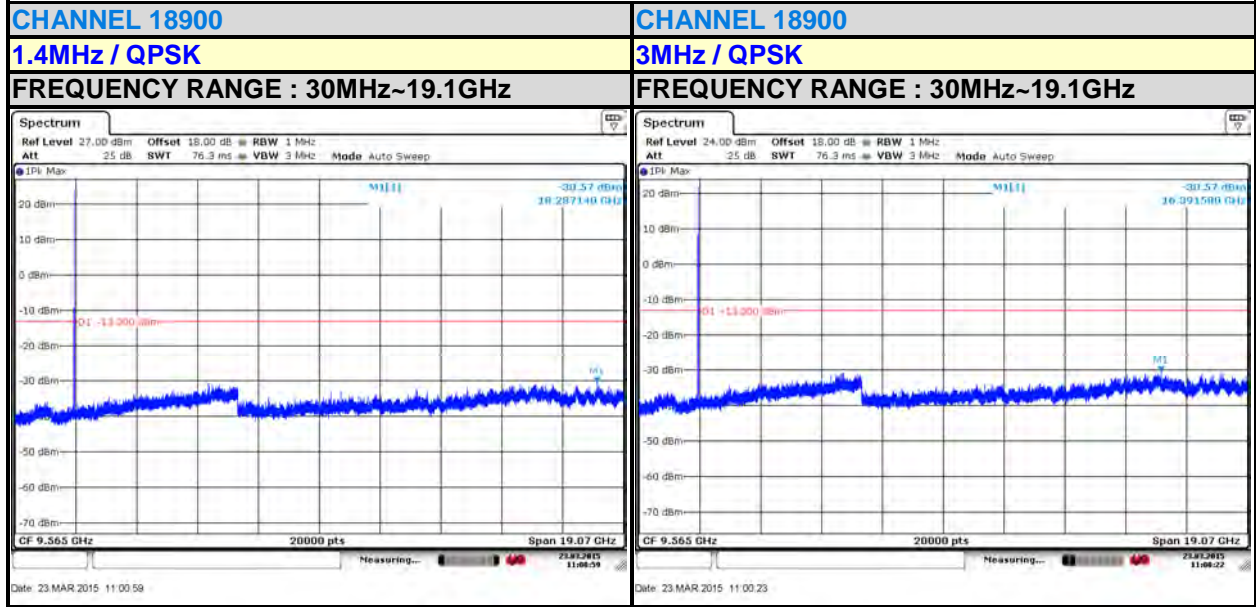

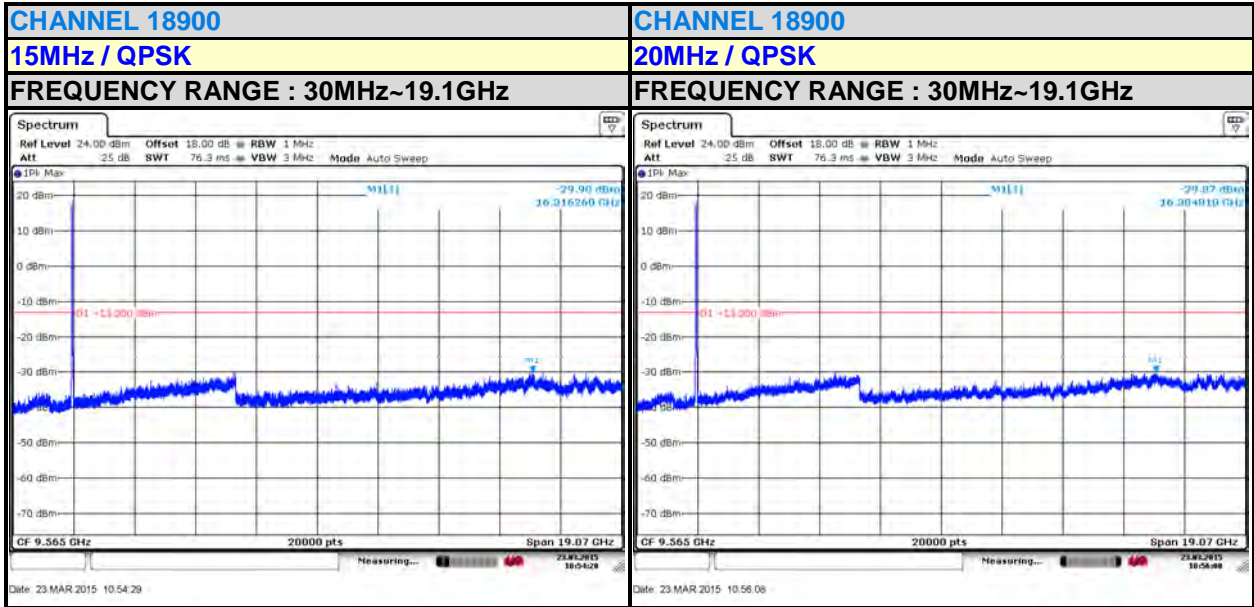



4.6 RADIATED EMISSION MEASUREMENT

4.6.1 LIMITS OF RADIATED EMISSION MEASUREMENT

The power of any emission outside of the authorized operating frequency ranges must be attenuated below the transmitting power (P) by a factor of at least $43 + 10 \log(P)$ dB. The emission limit equal to -13dBm .

4.6.2 TEST PROCEDURES

- a. Substitution method is used for E.I.R.P measurement. In the semi-anechoic chamber, EUT placed on the 0.8m height of Turn Table, rotated the table around 360 degrees to search the maximum radiation power and receiver antenna shall be rotated vertical and horizontal polarization and moved height from 1m to 4m to find the maximum polar radiated power. The “Read Value” is the spectrum reading the maximum power value.
- b. The substitution horn antenna is substituted for EUT at the same position and signals generator export the CW signal to the substitution antenna via a TX cable. Rotated the Turn Table and moved receiving antenna to find the maximum radiation power. Adjust output power level of S.G to get a Value of spectrum reading equal to “Read Value “ of step a. Record the power level of S.G
- c. $\text{EIRP} = \text{Output power level of S.G} - \text{TX cable loss} + \text{Antenna gain of substitution horn}$.

NOTE: The resolution bandwidth and video bandwidth of test receiver/spectrum analyzer is 1MHz/3MHz.

4.6.3 DEVIATION FROM TEST STANDARD

No deviation



4.6.4 TEST SETUP

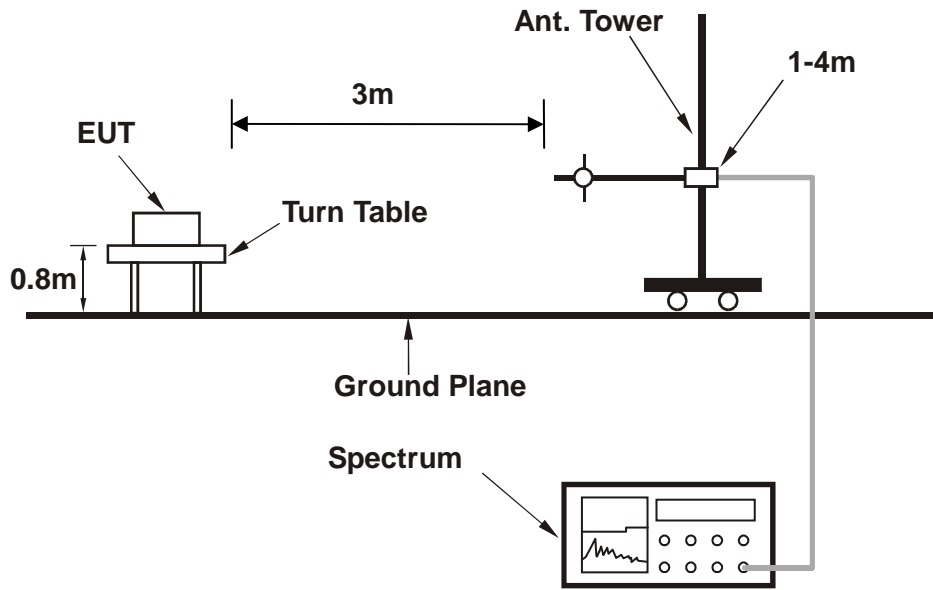

For the actual test configuration, please refer to the attached file (Test Setup Photo).



4.6.5 TEST RESULTS

BELOW 1GHz WORST-CASE DATA

PCS 1900:

MODE	TX channel 512	FREQUENCY RANGE	Below 1000MHz
ENVIRONMENTAL CONDITIONS	26deg. C, 56%RH	INPUT POWER	DC 5V from adapter
TESTED BY	Tyler Zhang		
ANTENNA POLARITY & TEST DISTANCE: HORIZONTAL AT 3 M			

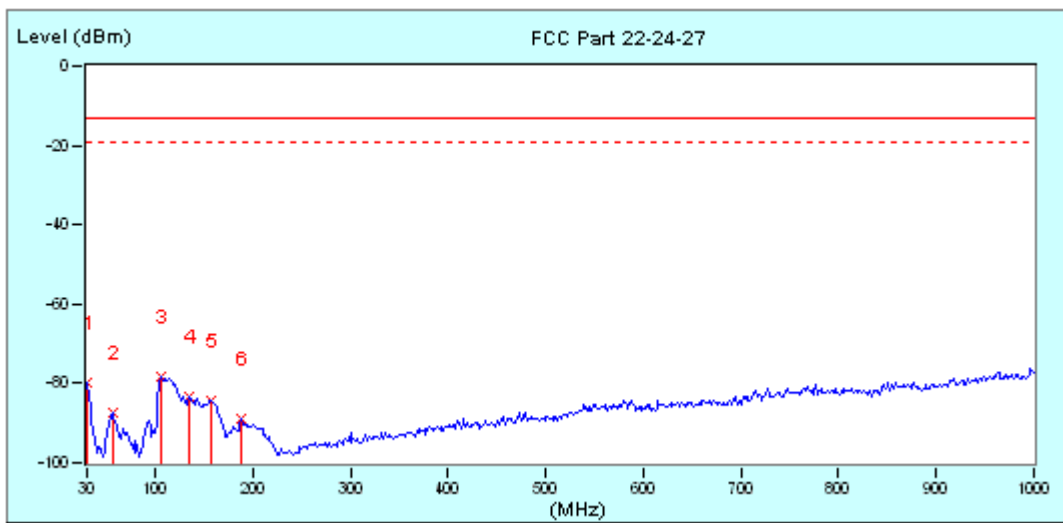

No.	Frequency MHz	Factor dB	Reading dBm	Emission dBm	Limit dBm	Margin dB	Tower / Table cm deg	
1	30.00	-12.27	-67.29	-79.56	-13.00	-66.56	100	0
2	55.87	-23.98	-63.59	-87.57	-13.00	-74.57	100	0
*	3	105.98	-19.42	-58.81	-78.23	-13.00	100	0
4	135.08	-18.16	-64.99	-83.15	-13.00	-70.15	100	0
5	157.72	-18.96	-65.21	-84.17	-13.00	-71.17	100	0
6	188.43	-20.63	-68.37	-89.00	-13.00	-76.00	100	0



MODE	TX channel 512	FREQUENCY RANGE	Below 1000MHz
ENVIRONMENTAL CONDITIONS	26deg. C, 56%RH	INPUT POWER	DC 5V from adapter
TESTED BY	Tyler Zhang		
ANTENNA POLARITY & TEST DISTANCE: VERTICAL AT 3 M			

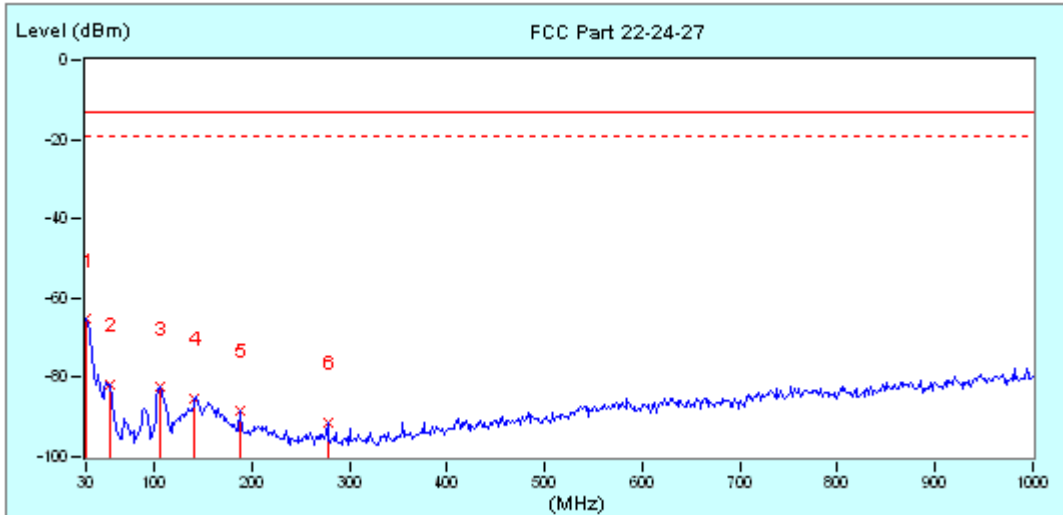

No.	Frequency MHz	Factor dB	Reading dBm	Emission dBm	Limit dBm	Margin dB	Tower / Table cm deg	
*	1	-12.27	-53.09	-65.36	-13.00	-52.36	100	0
	2	-23.47	-58.19	-81.66	-13.00	-68.66	100	0
	3	-19.42	-63.11	-82.53	-13.00	-69.53	100	0
	4	-18.18	-66.96	-85.14	-13.00	-72.14	100	0
	5	-20.63	-67.56	-88.19	-13.00	-75.19	100	0
	6	-16.02	-75.48	-91.50	-13.00	-78.50	100	0



ABOVE 1GHz DATA

PCS 1900:

MODE	TX channel 512	FREQUENCY RANGE	Below 1000MHz
ENVIRONMENTAL CONDITIONS	26deg. C, 56%RH	INPUT POWER	DC 5V from adapter
TESTED BY	Tyler Zhang		
ANTENNA POLARITY & TEST DISTANCE: HORIZONTAL AT 3 M			

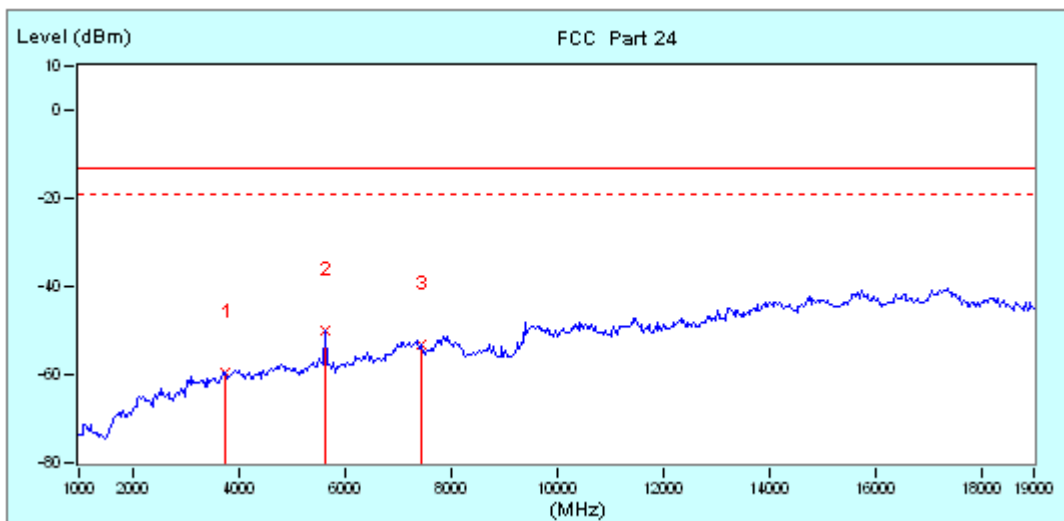

No.	Frequency MHz	Factor dB	Reading dBm	Emission dBm	Limit dBm	Margin dB	Tower / Table cm deg
1	3760.00 (PK)	6.96	-66.56	-59.60	-13.00	-46.60	100 0
*	5650.00 (PK)	11.16	-61.31	-50.15	-13.00	-37.15	100 0
3	7450.00 (PK)	11.76	-65.09	-53.33	-13.00	-40.33	100 0



MODE	TX channel 512	FREQUENCY RANGE	Below 1000MHz
ENVIRONMENTAL CONDITIONS	26deg. C, 56%RH	INPUT POWER	DC 5V from adapter
TESTED BY	Tyler Zhang		
ANTENNA POLARITY & TEST DISTANCE: VERTICAL AT 3 M			

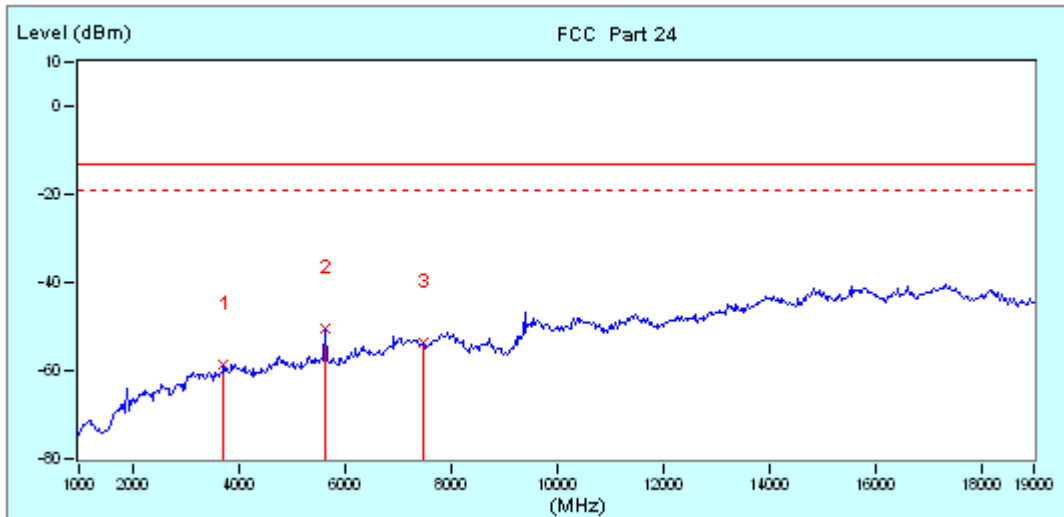

No.	Frequency MHz	Factor dB	Reading dBm	Emission dBm	Limit dBm	Margin dB	Tower / Table cm deg	
1	3730.00 (PK)	6.88	-65.74	-58.86	-13.00	-45.86	100	0
*	2	11.16	-61.47	-50.31	-13.00	-37.31	100	0
3	7480.00 (PK)	11.75	-65.24	-53.49	-13.00	-40.49	100	0



EDGE 1900:

MODE	TX channel 512	FREQUENCY RANGE	Below 1000MHz
ENVIRONMENTAL CONDITIONS	26deg. C, 56%RH	INPUT POWER	DC 5V from adapter
TESTED BY	Tyler Zhang		
ANTENNA POLARITY & TEST DISTANCE: HORIZONTAL AT 3 M			

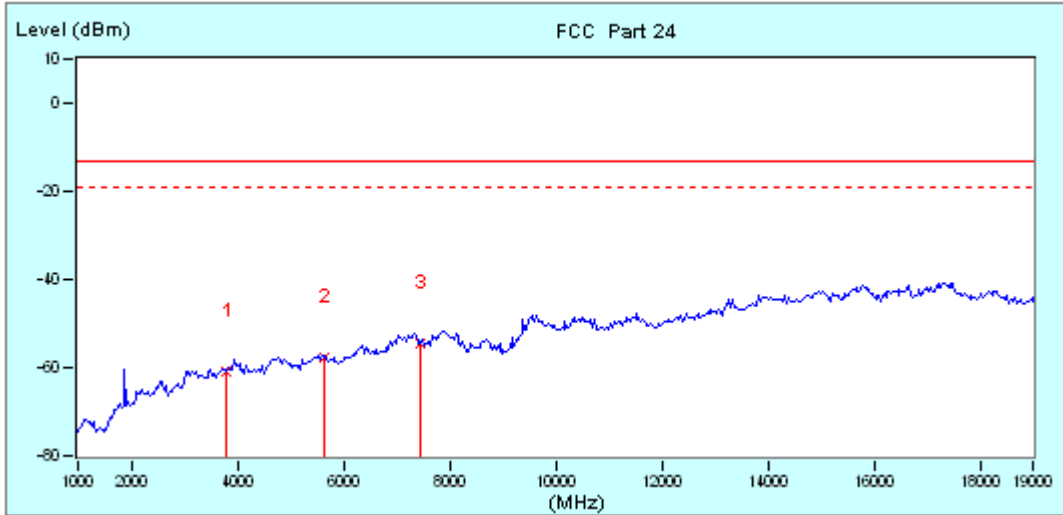

No.	Frequency MHz	Factor dB	Reading dBm	Emission dBm	Limit dBm	Margin dB	Tower / Table cm deg	
1	3786.67 (PK)	7.03	-67.94	-60.91	-13.00	-47.91	100	0
2	5623.33 (PK)	11.14	-68.66	-57.52	-13.00	-44.52	100	0
*	7460.00 (PK)	11.76	-66.21	-54.45	-13.00	-41.45	100	0



MODE	TX channel 512	FREQUENCY RANGE	Below 1000MHz
ENVIRONMENTAL CONDITIONS	26deg. C, 56%RH	INPUT POWER	DC 5V from adapter
TESTED BY	Tyler Zhang		
ANTENNA POLARITY & TEST DISTANCE: VERTICAL AT 3 M			

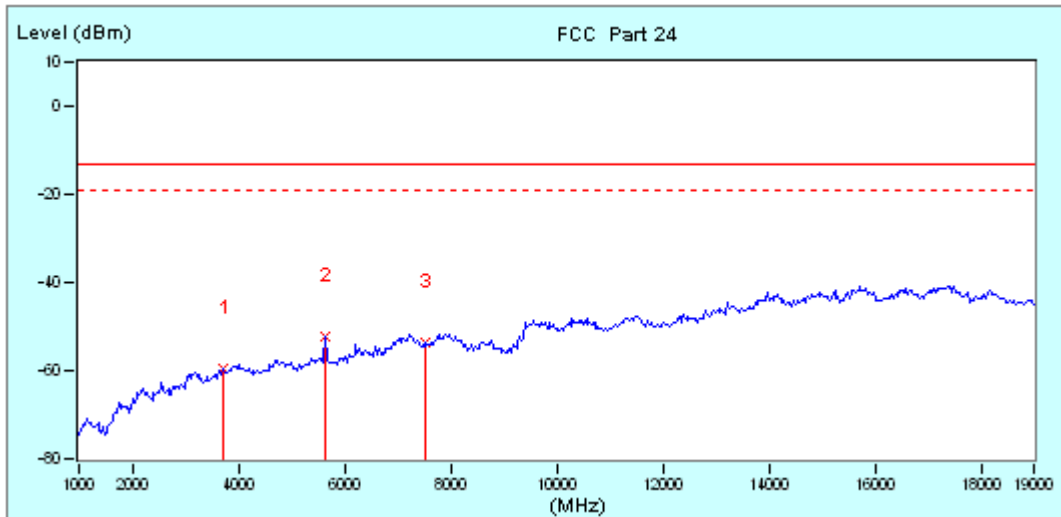

No.	Frequency MHz	Factor dB	Reading dBm	Emission dBm	Limit dBm	Margin dB	Tower / Table cm deg	
1	3730.00 (PK)	6.88	-66.64	-59.76	-13.00	-46.76	100	0
*	5650.00 (PK)	11.16	-63.29	-52.13	-13.00	-39.13	100	0
3	7510.00 (PK)	11.77	-65.22	-53.45	-13.00	-40.45	100	0



WCDMA Band II:

MODE	TX channel 9262	FREQUENCY RANGE	Below 1000MHz
ENVIRONMENTAL CONDITIONS	26deg. C, 56%RH	INPUT POWER	DC 5V from adapter
TESTED BY	Tyler Zhang		
ANTENNA POLARITY & TEST DISTANCE: HORIZONTAL AT 3 M			

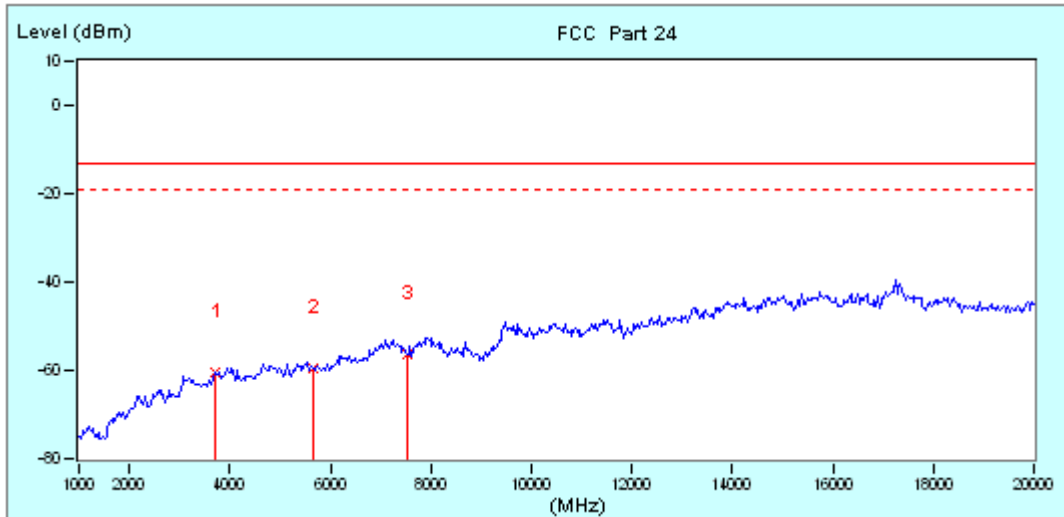

No.	Frequency MHz	Factor dB	Reading dBm	Emission dBm	Limit dBm	Margin dB	Tower / Table cm deg	
1	3723.33 (PK)	6.86	-67.30	-60.44	-13.00	-47.44	100	0
2	5655.00 (PK)	11.16	-70.68	-59.52	-13.00	-46.52	100	0
*	7523.33 (PK)	11.80	-68.22	-56.42	-13.00	-43.42	100	0



MODE	TX channel 9262	FREQUENCY RANGE	Below 1000MHz
ENVIRONMENTAL CONDITIONS	26deg. C, 56%RH	INPUT POWER	DC 5V from adapter
TESTED BY	Tyler Zhang		
ANTENNA POLARITY & TEST DISTANCE: VERTICAL AT 3 M			

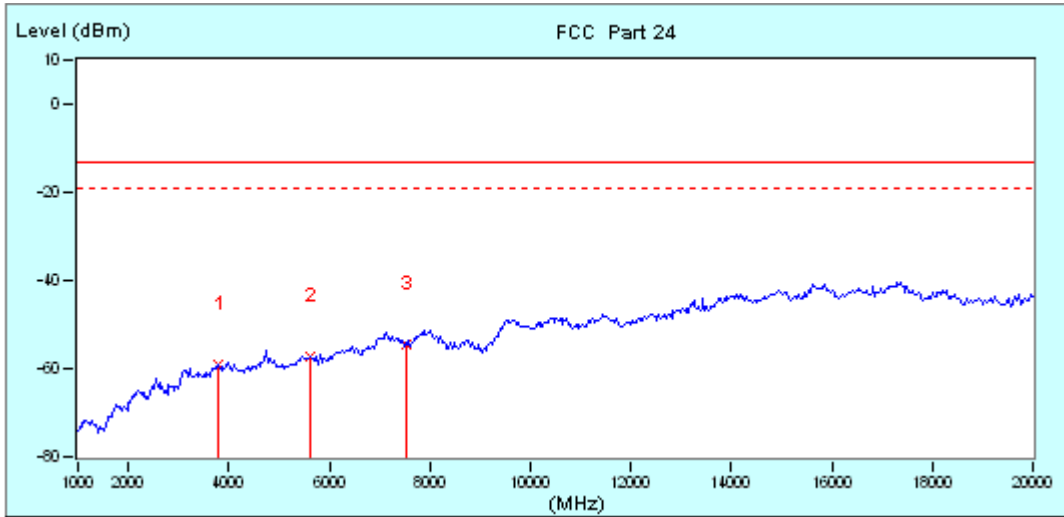

No.	Frequency MHz	Factor dB	Reading dBm	Emission dBm	Limit dBm	Margin dB	Tower / Table	
							cm	deg
1	3786.67 (PK)	7.03	-65.99	-58.96	-13.00	-45.96	100	0
2	5623.33 (PK)	11.14	-68.60	-57.46	-13.00	-44.46	100	0
*	7523.33 (PK)	11.80	-66.38	-54.58	-13.00	-41.58	100	0



LTE Band 2

CHANNEL BANDWIDTH: 1.4MHz / QPSK

MODE	TX channel 18900	FREQUENCY RANGE	Below 1000MHz
ENVIRONMENTAL CONDITIONS	26deg. C, 56%RH	INPUT POWER	DC 5V from adapter
TESTED BY	Tyler Zhang		
ANTENNA POLARITY & TEST DISTANCE: HORIZONTAL AT 3 M			

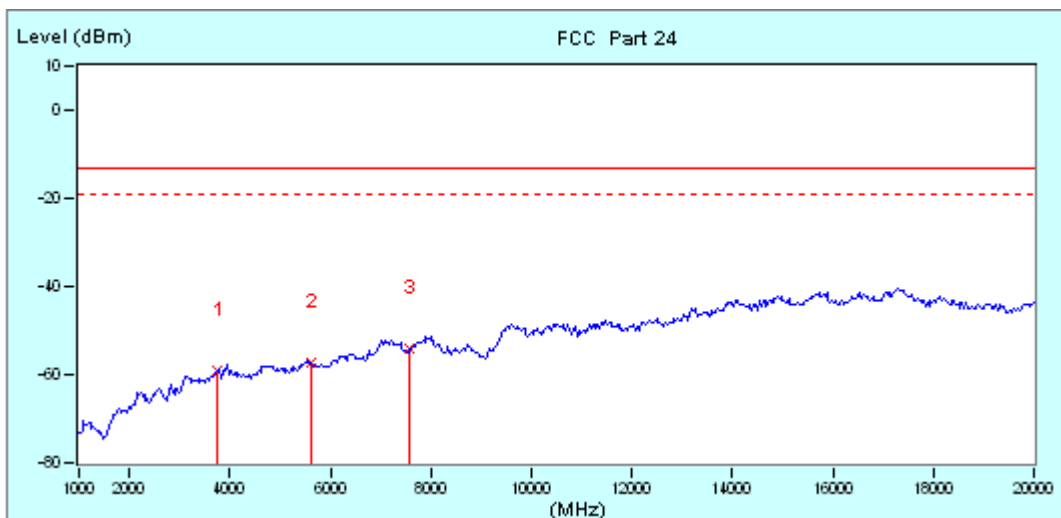

No.	Frequency MHz	Factor dB	Reading dBm	Emission dBm	Limit dBm	Margin dB	Tower / Table cm deg	
1	3755.00 (PK)	6.95	-66.13	-59.18	-13.00	-46.18	100	0
2	5623.33 (PK)	11.14	-68.58	-57.44	-13.00	-44.44	100	0
*	3	12.02	-65.98	-53.96	-13.00	-40.96	100	0



MODE	TX channel 18900	FREQUENCY RANGE	Below 1000MHz
ENVIRONMENTAL CONDITIONS	26deg. C, 56%RH	INPUT POWER	DC 5V from adapter
TESTED BY	Tyler Zhang		
ANTENNA POLARITY & TEST DISTANCE: VERTICAL AT 3 M			

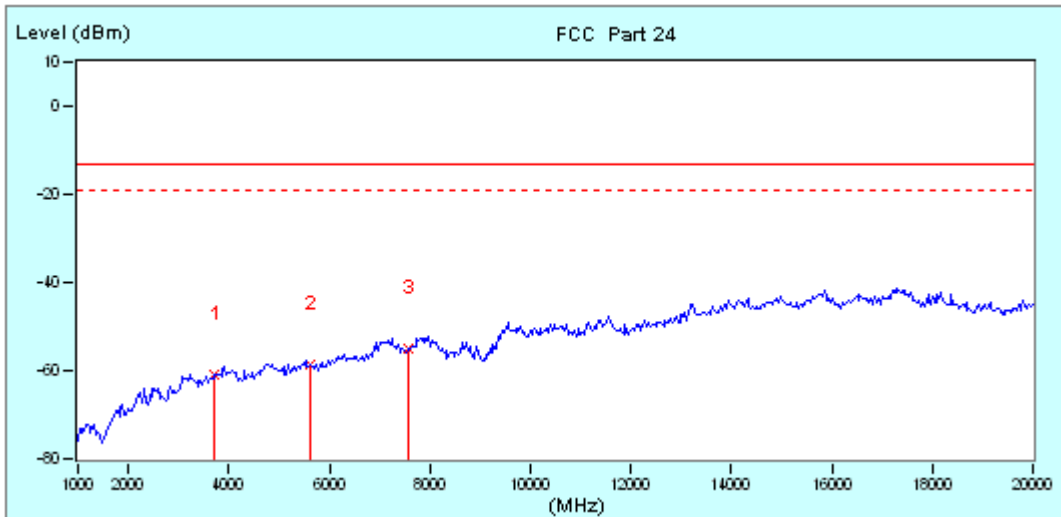

No.	Frequency MHz	Factor dB	Reading dBm	Emission dBm	Limit dBm	Margin dB	Tower / Table cm deg	
1	3723.33 (PK)	6.86	-67.68	-60.82	-13.00	-47.82	100	0
2	5623.33 (PK)	11.14	-69.79	-58.65	-13.00	-46.65	100	0
*	7586.67 (PK)	12.02	-67.14	-55.12	-13.00	-42.12	100	0



CHANNEL BANDWIDTH: 3MHz / QPSK

MODE	TX channel 18900	FREQUENCY RANGE	Below 1000MHz
ENVIRONMENTAL CONDITIONS	26deg. C, 56%RH	INPUT POWER	DC 5V from adapter
TESTED BY	Tyler Zhang		
ANTENNA POLARITY & TEST DISTANCE: HORIZONTAL AT 3 M			

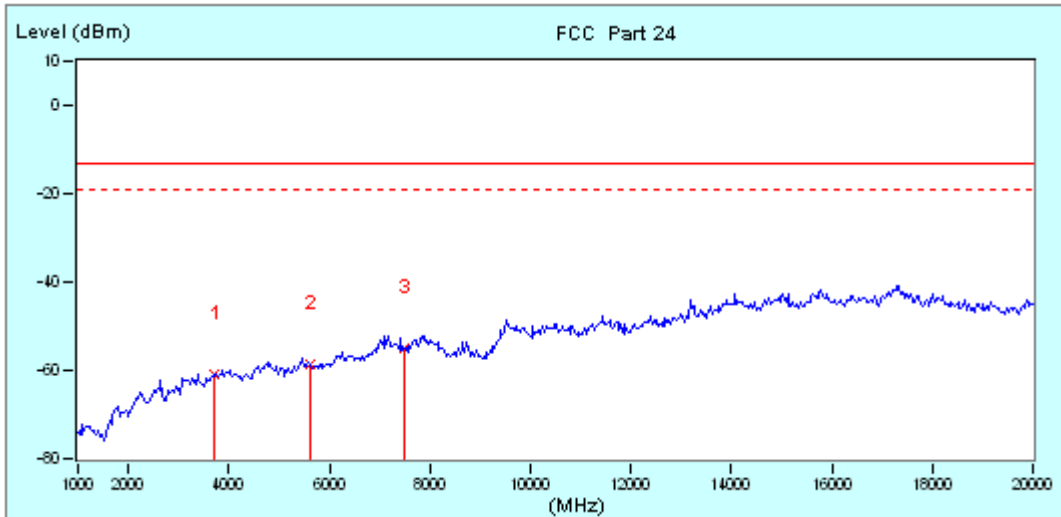

No.	Frequency MHz	Factor dB	Reading dBm	Emission dBm	Limit dBm	Margin dB	Tower / Table cm deg
1	3691.67 (PK)	6.78	-67.78	-61.00	-13.00	-48.00	100 0
2	5623.33 (PK)	11.14	-69.90	-58.76	-13.00	-45.76	100 0
* 3	7491.67 (PK)	11.73	-66.90	-55.17	-13.00	-42.17	100 0



MODE	TX channel 18900	FREQUENCY RANGE	Below 1000MHz
ENVIRONMENTAL CONDITIONS	26deg. C, 56%RH	INPUT POWER	DC 5V from adapter
TESTED BY	Tyler Zhang		
ANTENNA POLARITY & TEST DISTANCE: VERTICAL AT 3 M			

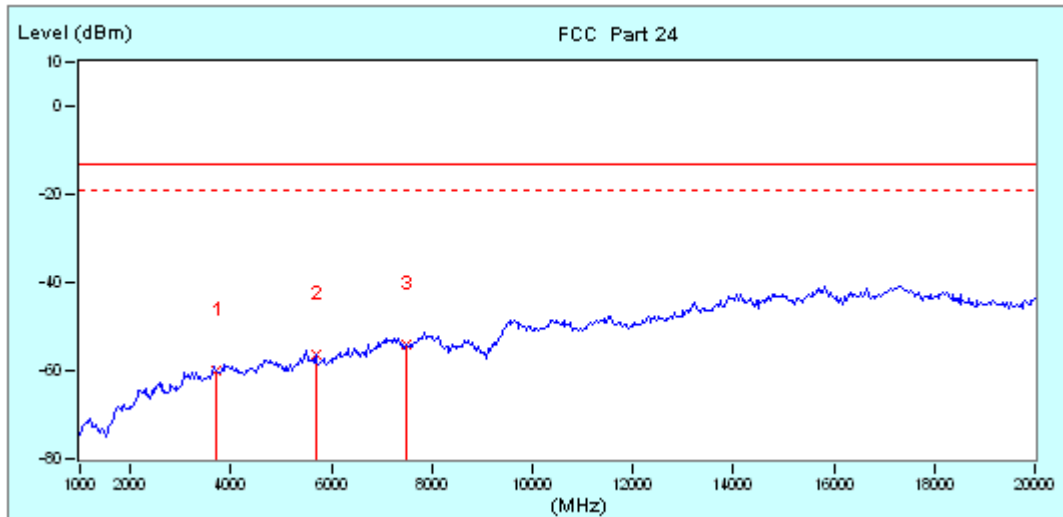

No.	Frequency MHz	Factor dB	Reading dBm	Emission dBm	Limit dBm	Margin dB	Tower / Table cm deg	
1	3723.33 (PK)	6.86	-66.85	-59.99	-13.00	-46.99	100	0
2	5686.67 (PK)	11.19	-67.71	-56.52	-13.00	-43.52	100	0
*	7491.67 (PK)	11.73	-65.84	-54.11	-13.00	-41.11	100	0



CHANNEL BANDWIDTH: 5MHz / QPSK

MODE	TX channel 18900	FREQUENCY RANGE	Below 1000MHz
ENVIRONMENTAL CONDITIONS	26deg. C, 56%RH	INPUT POWER	DC 5V from adapter
TESTED BY	Tyler Zhang		
ANTENNA POLARITY & TEST DISTANCE: HORIZONTAL AT 3 M			

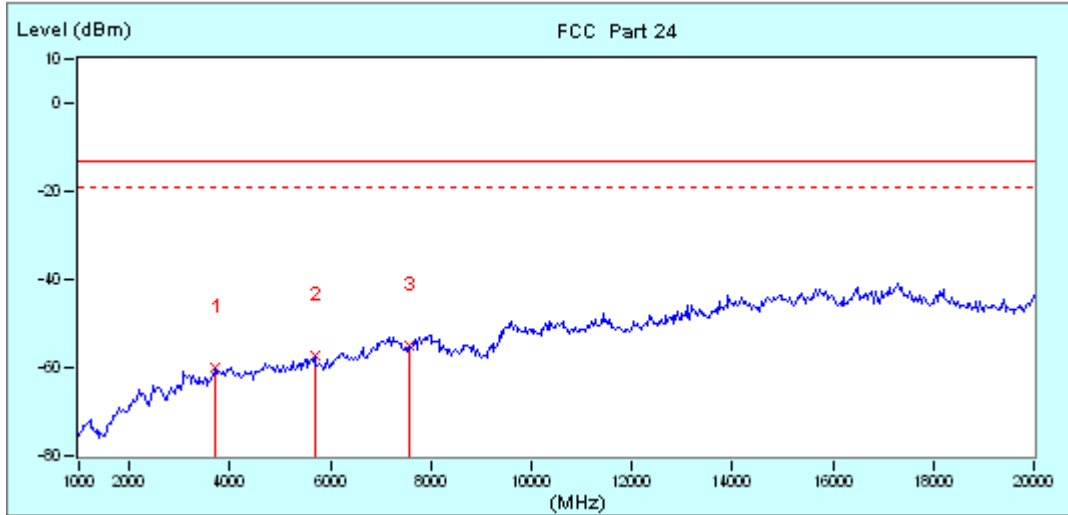

No.	Frequency MHz	Factor dB	Reading dBm	Emission dBm	Limit dBm	Margin dB	Tower / Table cm deg
1	3723.33 (PK)	6.86	-67.06	-60.20	-13.00	-47.20	100 0
2	5686.67 (PK)	11.19	-68.54	-57.35	-13.00	-44.35	100 0
*	7555.00 (PK)	11.91	-67.05	-55.14	-13.00	-42.14	100 0



MODE	TX channel 18900	FREQUENCY RANGE	Below 1000MHz
ENVIRONMENTAL CONDITIONS	26deg. C, 56%RH	INPUT POWER	DC 5V from adapter
TESTED BY	Tyler Zhang		
ANTENNA POLARITY & TEST DISTANCE: VERTICAL AT 3 M			

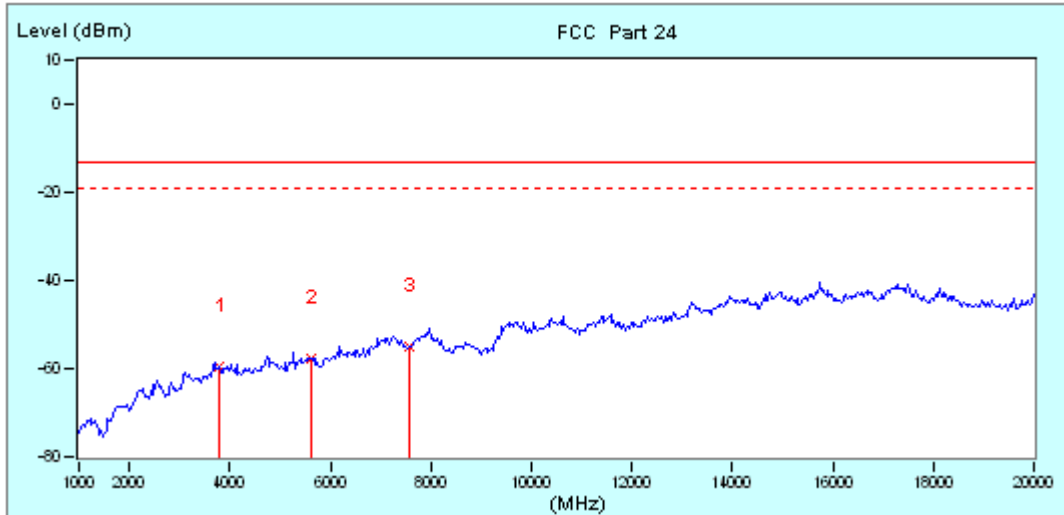

No.	Frequency MHz	Factor dB	Reading dBm	Emission dBm	Limit dBm	Margin dB	Tower / Table cm deg	
1	3786.67 (PK)	7.03	-66.57	-59.54	-13.00	-46.54	100	0
2	5623.33 (PK)	11.14	-69.05	-57.91	-13.00	-44.91	100	0
*	7555.00 (PK)	11.91	-66.93	-55.02	-13.00	-42.02	100	0



CHANNEL BANDWIDTH: 10MHz / QPSK

MODE	TX channel 18900	FREQUENCY RANGE	Below 1000MHz
ENVIRONMENTAL CONDITIONS	26deg. C, 56%RH	INPUT POWER	DC 5V from adapter
TESTED BY	Tyler Zhang		
ANTENNA POLARITY & TEST DISTANCE: HORIZONTAL AT 3 M			

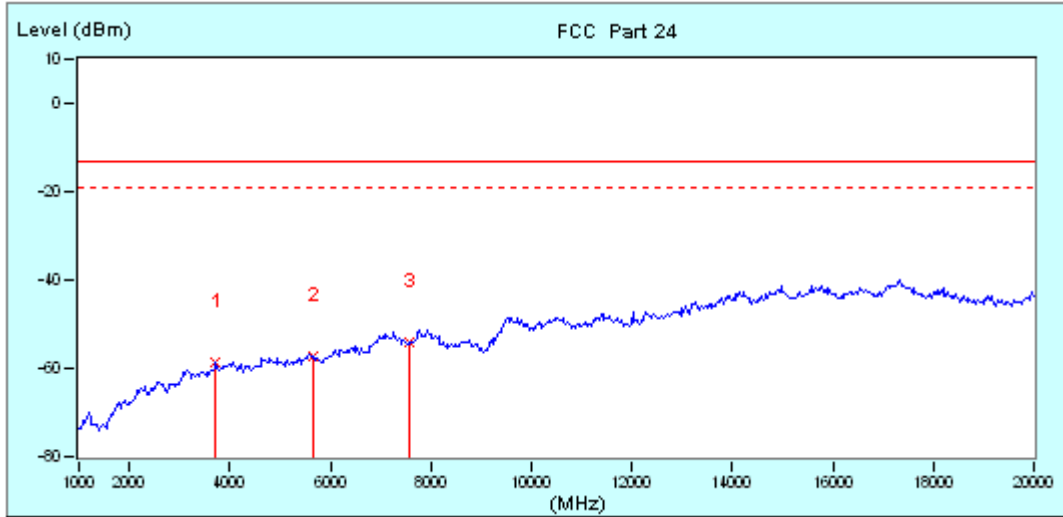

No.	Frequency MHz	Factor dB	Reading dBm	Emission dBm	Limit dBm	Margin dB	Tower / Table cm deg	
1	3723.33 (PK)	6.86	-65.43	-58.57	-13.00	-45.57	100	0
2	5655.00 (PK)	11.16	-68.46	-57.30	-13.00	-44.30	100	0
*	7586.67 (PK)	12.02	-66.33	-54.31	-13.00	-41.31	100	0



MODE	TX channel 18900	FREQUENCY RANGE	Below 1000MHz
ENVIRONMENTAL CONDITIONS	26deg. C, 56%RH	INPUT POWER	DC 5V from adapter
TESTED BY	Tyler Zhang		
ANTENNA POLARITY & TEST DISTANCE: VERTICAL AT 3 M			

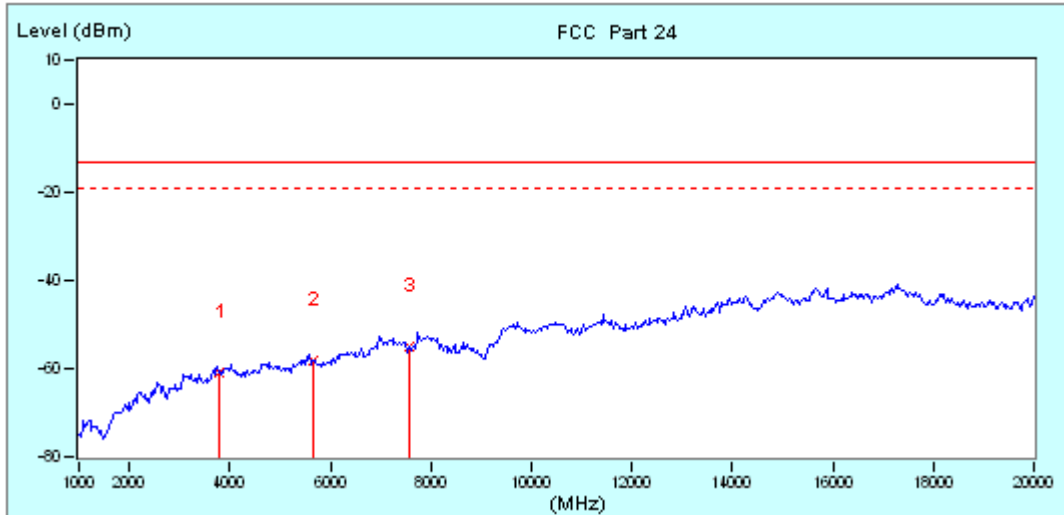

No.	Frequency MHz	Factor dB	Reading dBm	Emission dBm	Limit dBm	Margin dB	Tower / Table cm deg
1	3786.67 (PK)	7.03	-68.16	-61.13	-13.00	-48.13	100 0
2	5655.00 (PK)	11.16	-69.55	-58.39	-13.00	-45.39	100 0
*	7586.67 (PK)	12.02	-67.07	-55.05	-13.00	-42.05	100 0



CHANNEL BANDWIDTH: 15MHz / QPSK

MODE	TX channel 18900	FREQUENCY RANGE	Below 1000MHz
ENVIRONMENTAL CONDITIONS	26deg. C, 56%RH	INPUT POWER	DC 5V from adapter
TESTED BY	Tyler Zhang		
ANTENNA POLARITY & TEST DISTANCE: HORIZONTAL AT 3 M			

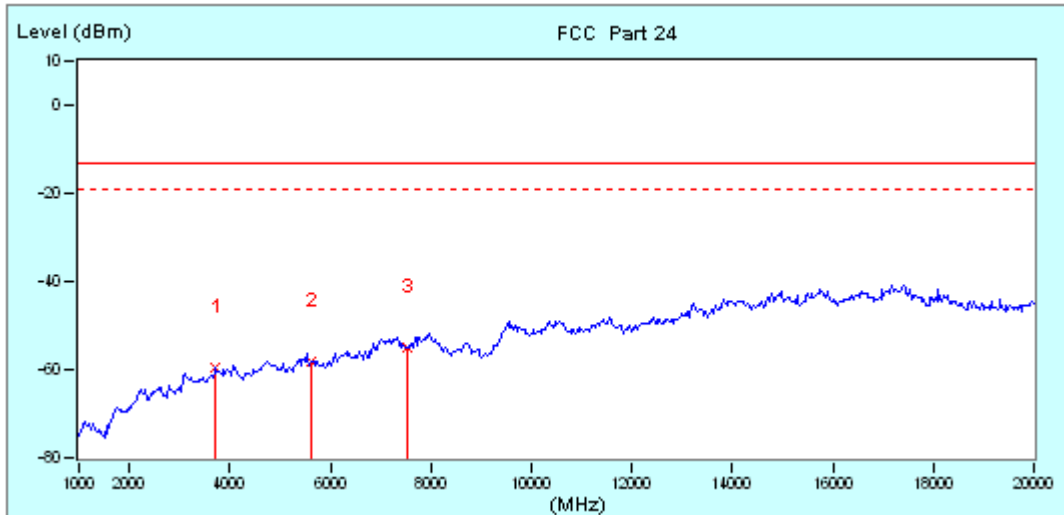

No.	Frequency MHz	Factor dB	Reading dBm	Emission dBm	Limit dBm	Margin dB	Tower / Table cm deg	
1	3723.33 (PK)	6.86	-66.61	-59.75	-13.00	-46.75	100	0
2	5623.33 (PK)	11.14	-69.35	-58.21	-13.00	-45.21	100	0
*	7523.33 (PK)	11.80	-66.98	-55.18	-13.00	-42.18	100	0



MODE	TX channel 18900	FREQUENCY RANGE	Below 1000MHz
ENVIRONMENTAL CONDITIONS	26deg. C, 56%RH	INPUT POWER	DC 5V from adapter
TESTED BY	Tyler Zhang		
ANTENNA POLARITY & TEST DISTANCE: VERTICAL AT 3 M			

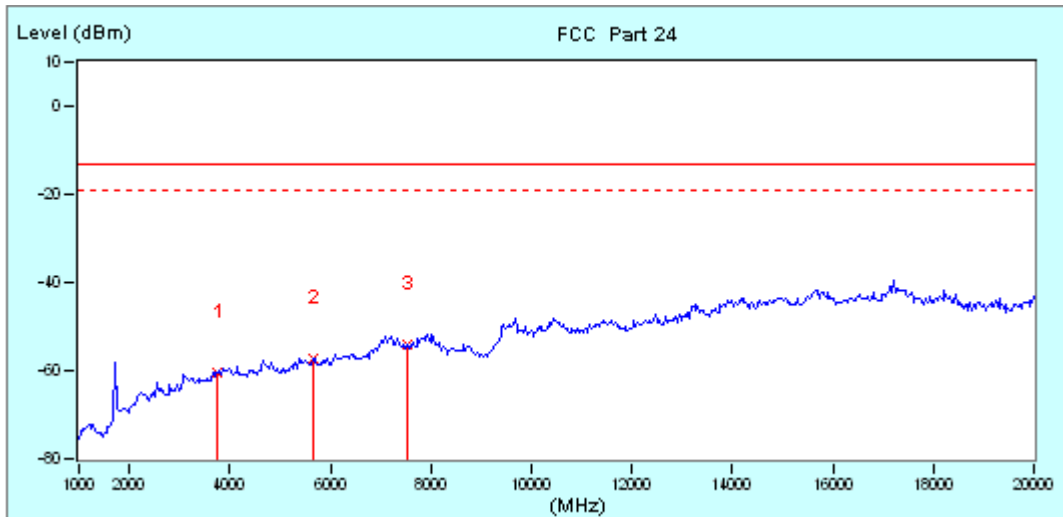

No.	Frequency MHz	Factor dB	Reading dBm	Emission dBm	Limit dBm	Margin dB	Tower / Table cm deg	
1	3755.00 (PK)	6.95	-67.31	-60.36	-13.00	-47.36	100	0
2	5655.00 (PK)	11.16	-68.41	-57.25	-13.00	-44.25	100	0
*	7523.33 (PK)	11.80	-66.11	-54.31	-13.00	-41.31	100	0



CHANNEL BANDWIDTH: 20MHz / QPSK

MODE	TX channel 18900	FREQUENCY RANGE	Below 1000MHz
ENVIRONMENTAL CONDITIONS	26deg. C, 56%RH	INPUT POWER	DC 5V from adapter
TESTED BY	Tyler Zhang		
ANTENNA POLARITY & TEST DISTANCE: HORIZONTAL AT 3 M			

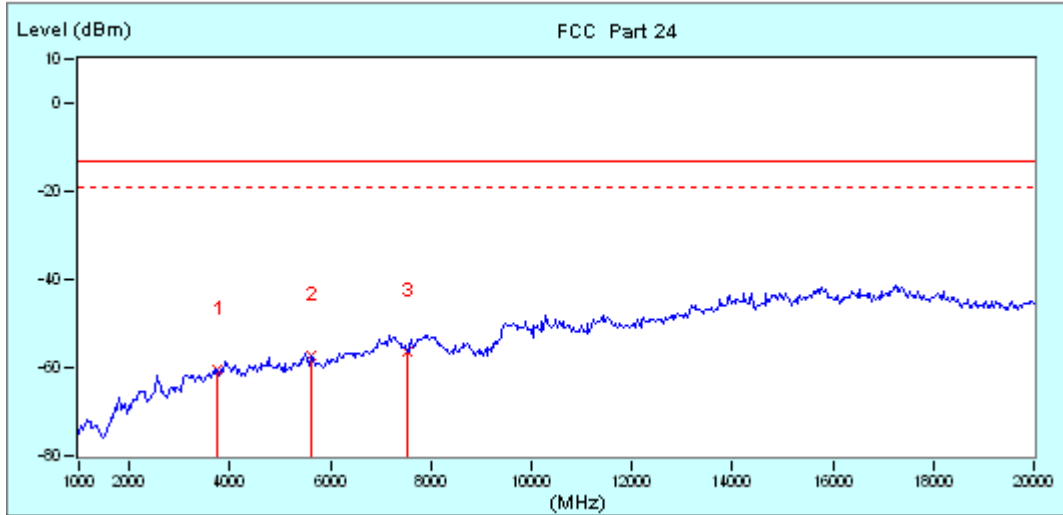

No.	Frequency MHz	Factor dB	Reading dBm	Emission dBm	Limit dBm	Margin dB	Tower / Table cm deg	
1	3755.00 (PK)	6.95	-67.42	-60.47	-13.00	-47.47	100	0
2	5623.33 (PK)	11.14	-68.22	-57.08	-13.00	-44.08	100	0
*	7523.33 (PK)	11.80	-68.03	-56.23	-13.00	-43.23	100	0



MODE	TX channel 18900	FREQUENCY RANGE	Below 1000MHz
ENVIRONMENTAL CONDITIONS	26deg. C, 56%RH	INPUT POWER	DC 5V from adapter
TESTED BY	Tyler Zhang		
ANTENNA POLARITY & TEST DISTANCE: VERTICAL AT 3 M			

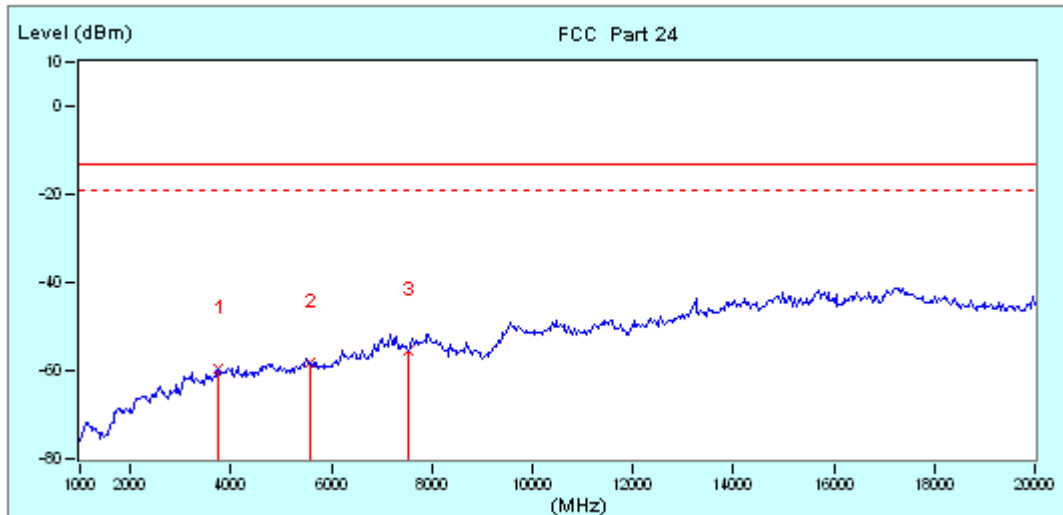

No.	Frequency MHz	Factor dB	Reading dBm	Emission dBm	Limit dBm	Margin dB	Tower / Table cm deg	
1	3755.00 (PK)	6.95	-66.66	-59.71	-13.00	-46.71	100	0
2	5591.67 (PK)	11.12	-69.43	-58.31	-13.00	-45.31	100	0
*	7523.33 (PK)	11.80	-67.20	-55.40	-13.00	-42.40	100	0



4.7 PEAK TO AVERAGE RATIO

4.7.1 LIMITS OF peak to average ratio MEASUREMENT

In measuring transmissions in this band using an average power technique, the peak to-average ratio (PAR) of the transmission may not exceed 13 dB

4.7.2 TEST SETUP

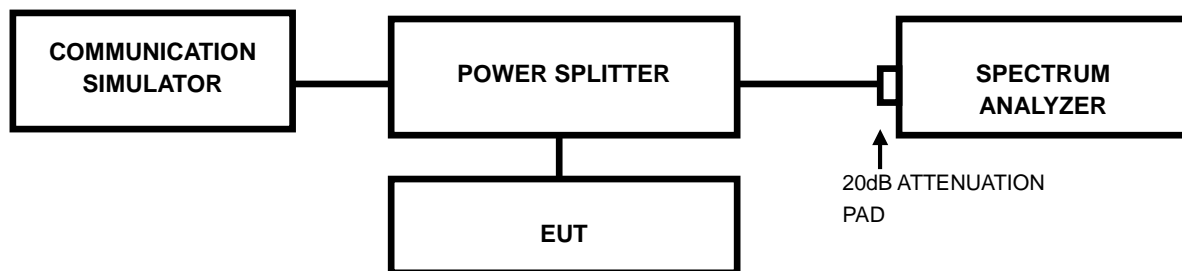

4.7.3 TEST PROCEDURES

1. Set resolution/measurement bandwidth \geq signal's occupied bandwidth;
2. Set the number of counts to a value that stabilizes the measured CCDF curve;
3. Record the maximum PAPR level associated with a probability of 0.1%.



4.7.4 TEST RESULTS

GSM

CHANNEL	FREQUENCY (MHz)	PEAK TO AVERAGE RATIO (dB)
661	1880	7.74

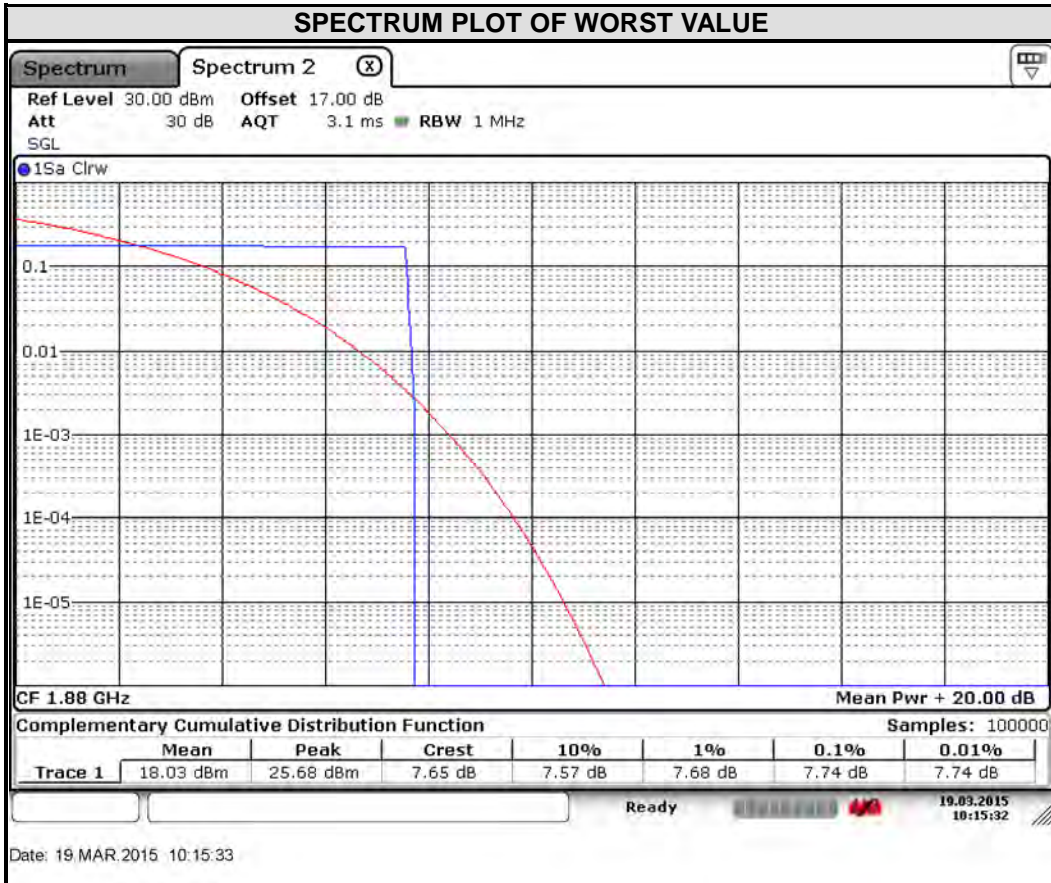

EDGE

CHANNEL	FREQUENCY (MHz)	PEAK TO AVERAGE RATIO (dB)
661	1880	8.72

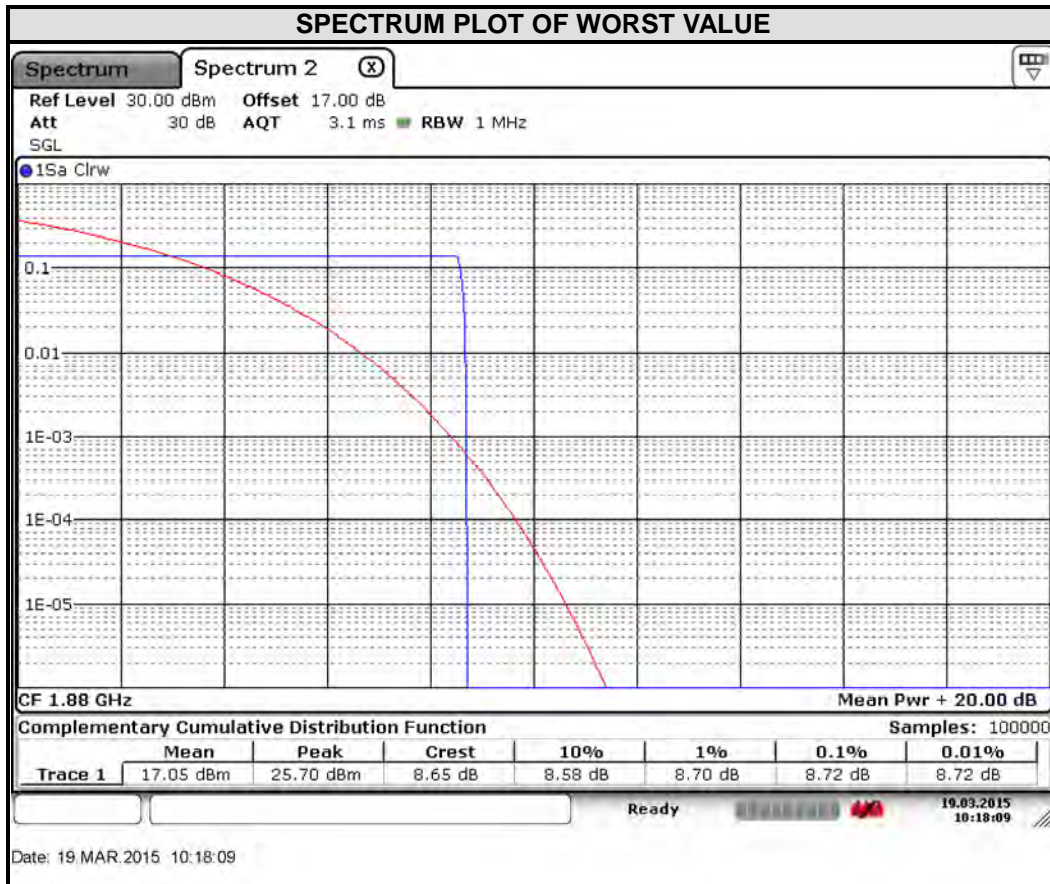



WCDMA

CHANNEL	FREQUENCY (MHz)	PEAK TO AVERAGE RATIO (dB)
9400	1880	3.33

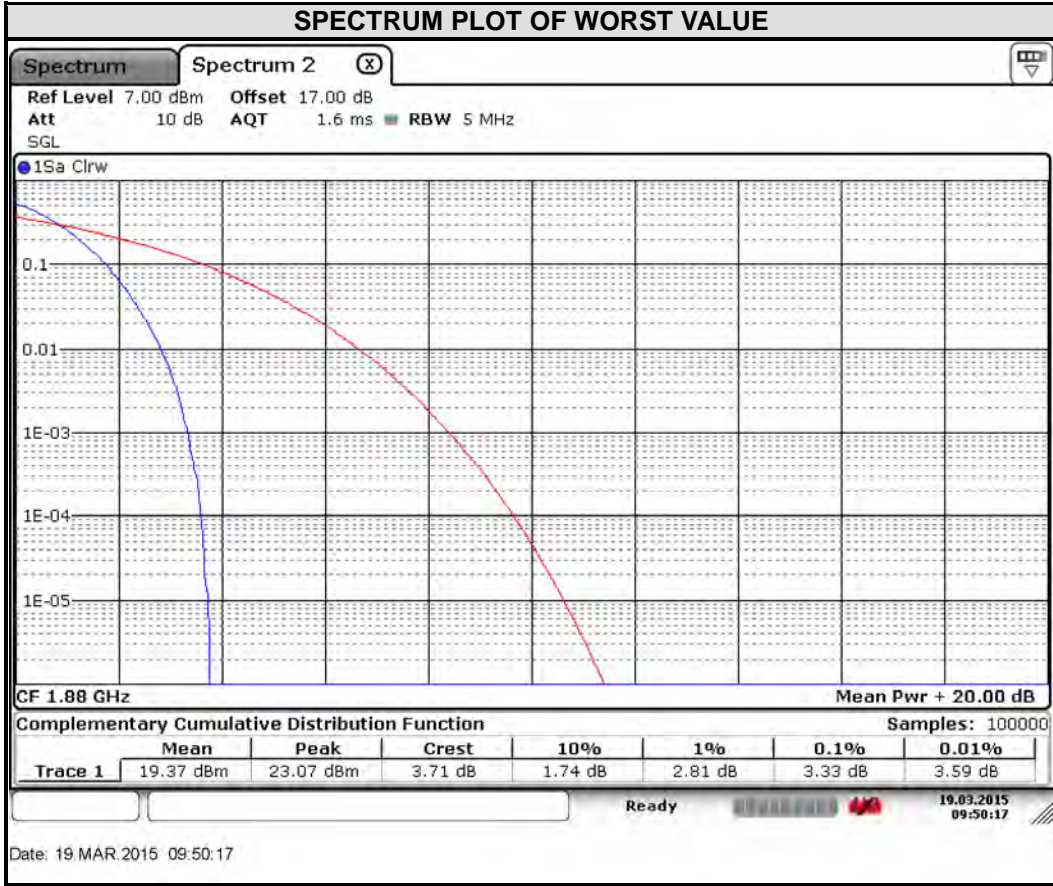



LTE BAND 2

CHANNEL BANDWIDTH: 1.4MHz				CHANNEL BANDWIDTH: 3MHz			
CHANNEL	FREQUENCY (MHz)	PEAK TO AVERAGE RATIO (dB)		CHANNEL	FREQUENCY (MHz)	PEAK TO AVERAGE RATIO (dB)	
		QPSK	16QAM			QPSK	16QAM
18607	1850.7	2.93	4.12	18615	1851.5	3.51	4.35
18900	1880	3.80	4.64	18900	1880	3.97	4.75
19193	1909.3	4.06	4.84	19185	1908.5	4.29	5.13

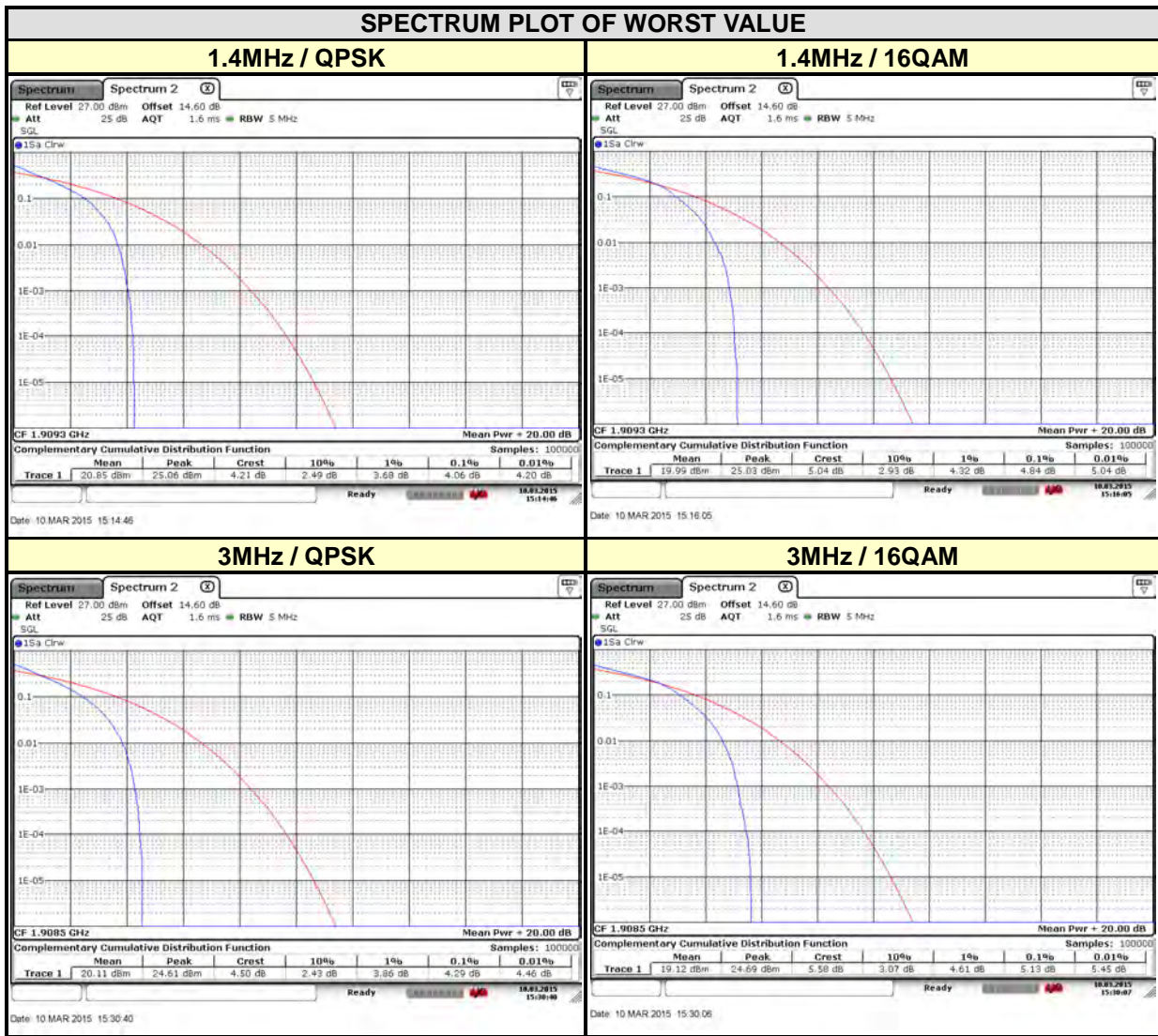



CHANNEL BANDWIDTH: 5MHz				CHANNEL BANDWIDTH: 10MHz			
CHANNEL	FREQUENCY (MHz)	PEAK TO AVERAGE RATIO (dB)		CHANNEL	FREQUENCY (MHz)	PEAK TO AVERAGE RATIO (dB)	
		QPSK	16QAM			QPSK	16QAM
18625	1852.5	3.74	4.84	18650	1855	4.52	5.42
18900	1880	4.03	5.13	18900	1880	4.23	5.16
19175	1907.5	4.20	5.13	19150	1905	4.58	5.45

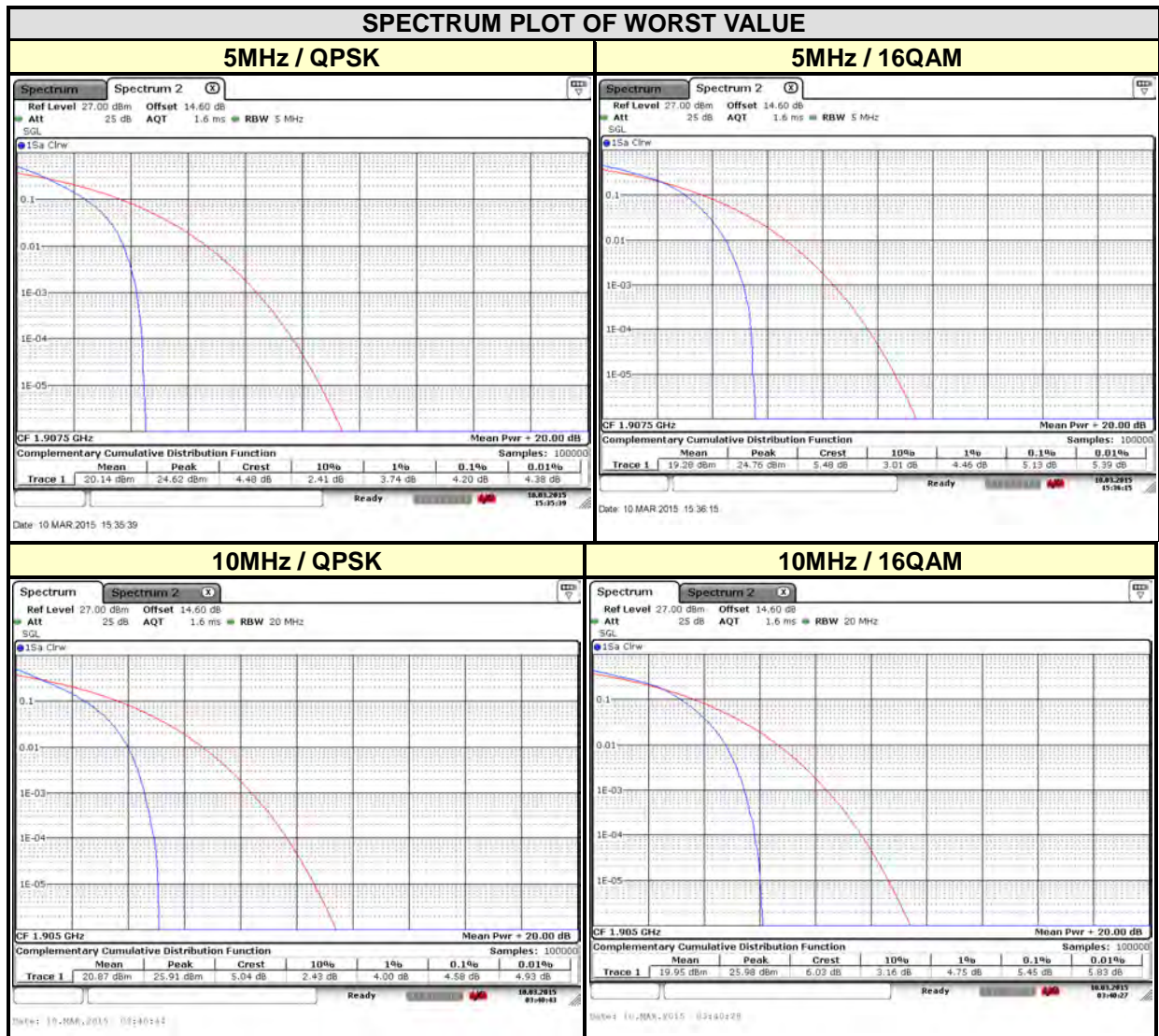



CHANNEL BANDWIDTH: 15MHz				CHANNEL BANDWIDTH: 20MHz			
CHANNEL	FREQUENCY (MHz)	PEAK TO AVERAGE RATIO (dB)		CHANNEL	FREQUENCY (MHz)	PEAK TO AVERAGE RATIO (dB)	
		QPSK	16QAM			QPSK	16QAM
18675	1857.5	4.49	5.62	18700	1860	4.70	5.65
18900	1880	4.43	5.22	18900	1880	4.32	5.25
19125	1902.5	4.78	5.54	19100	1900	4.61	5.65

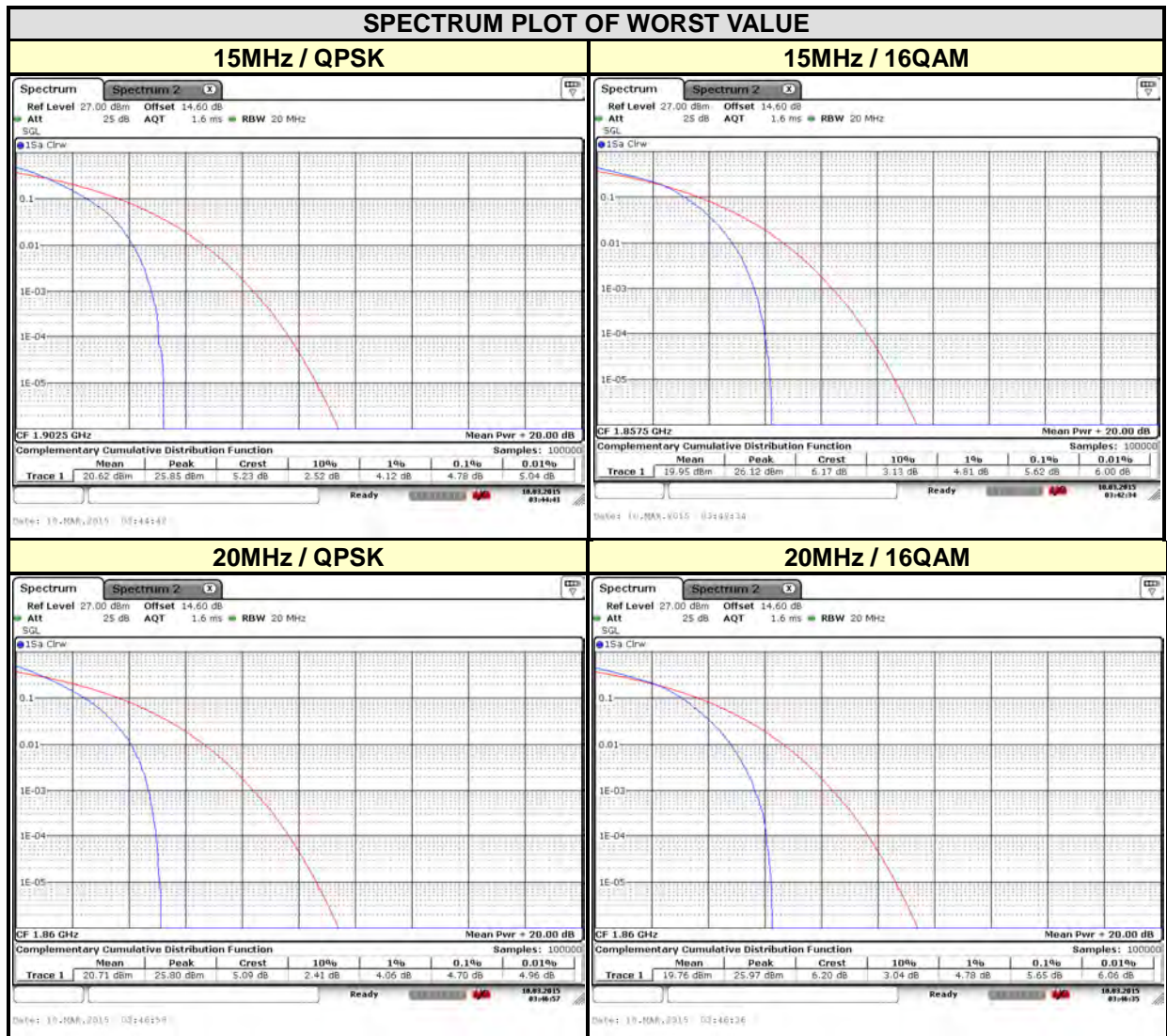



5 INFORMATION ON THE TESTING LABORATORIES

We, Bureau Veritas Shenzhen Co., Ltd. Dongguan Branch, were founded in 2002 to provide our best service in EMC, Radio, Telecom and Safety consultation. Our laboratories are accredited and approved according to ISO/IEC 17025.

If you have any comments, please feel free to contact us at the following:

Dongguan EMC/RF Lab:

Tel: +86-769-85935656

Fax: +86-769-85931080

Email: customerservice.dg@cn.bureauveritas.com

Web Site: www.adt.com.tw

The address and road map of all our labs can be found in our web site also.



6 APPENDIX A – MODIFICATIONS RECORDERS FOR ENGINEERING CHANGES TO THE EUT BY THE LAB

No any modifications are made to the EUT by the lab during the test.

---END---