



Test Report No.: RF190325W006-6



FCC TEST REPORT (PART 27)

Applicant:	Corporativo Lanix S.A. de C.V.
Address:	Carretera Internacional Hermosillo-Nogales Km 8.5, Hermosillo Sonora, Mexico

Manufacturer or Supplier:	Corporativo Lanix S.A. de C.V.
Address:	Carretera Internacional Hermosillo-Nogales Km 8.5, Hermosillo Sonora, Mexico
Product:	smartphone
Brand Name:	LANIX
Model Name:	Ilium Alpha 1s
FCC ID:	ZC4ALPHA1S
Date of tests:	Mar. 26, 2019 ~ Apr. 19, 2019

The tests have been carried out according to the requirements of the following standard:

- FCC Part 27, Subpart C, M
- FCC Part 2
- ANSI/TIA/EIA-603-D
- ANSI/TIA/EIA-603-E
- ANSI C63.26-2015

CONCLUSION: The submitted sample was found to COMPLY with the test requirement

Prepared by Roger Li Engineer / Mobile Department	Approved by Luke Lu Manager / Mobile Department
Date: Apr. 19, 2019	Date: Apr. 19, 2019

This report is governed by, and incorporates by reference, CPS Conditions of Service as posted at the date of issuance of this report at <http://www.bureauveritas.com/home/about-us/our-business/cps/about-us/terms-conditions> and is intended for your exclusive use. Any copying or replication of this report to or for any other person or entity, or use of our name or trademark, is permitted only with our prior written permission. This report sets forth our findings solely with respect to the test samples identified herein. The results set forth in this report are not indicative or representative of the quality or characteristics of the lot from which a test sample was taken or any similar or identical product unless specifically and expressly noted. Our report includes all of the tests requested by you and the results thereof based upon the information that you provided to us. Measurement uncertainty is only provided upon request for accredited tests. You have 60 days from date of issuance of this report to notify us of any material error or omission caused by our negligence or if you require measurement uncertainty; provided, however, that such notice shall be in writing and shall specifically address the issue you wish to raise. A failure to raise such issue within the prescribed time shall constitute your unqualified acceptance of the completeness of this report, the tests conducted and the correctness of the report contents.



TABLE OF CONTENTS

RELEASE CONTROL RECORD 4

1 SUMMARY OF TEST RESULTS 5

1.1 MEASUREMENT UNCERTAINTY 5

1.2 TEST SITE AND INSTRUMENTS 6

2 GENERAL INFORMATION 7

2.1 GENERAL DESCRIPTION OF EUT 7

2.2 CONFIGURATION OF SYSTEM UNDER TEST 9

2.3 DESCRIPTION OF SUPPORT UNITS 10

2.4 TEST ITEM AND TEST CONFIGURATION 10

2.5 GENERAL DESCRIPTION OF APPLIED STANDARDS 12

3 TEST TYPES AND RESULTS 13

3.1 OUTPUT POWER MEASUREMENT 13

3.1.1 LIMITS OF OUTPUT POWER MEASUREMENT 13

3.1.2 TEST PROCEDURES 13

3.1.3 TEST SETUP 14

3.1.4 TEST RESULTS 15

3.2 FREQUENCY STABILITY MEASUREMENT 20

3.2.1 LIMITS OF FREQUENCY STABILITY MEASUREMENT 20

3.2.2 TEST PROCEDURE 20

3.2.3 TEST SETUP 20

3.2.4 TEST RESULTS 21

3.3 OCCUPIED BANDWIDTH MEASUREMENT 25

3.3.1 LIMITS OF OCCUPIED BANDWIDTH MEASUREMENT 25

3.3.2 TEST SETUP 25

3.3.3 TEST PROCEDURES 25

3.3.4 TEST RESULTS 26

3.4 PEAK TO AVERAGE RATIO 28

3.4.1 LIMITS OF PEAK TO AVERAGE RATIO MEASUREMENT 28

3.4.2 TEST SETUP 28

3.4.3 TEST PROCEDURES 28

3.4.4 TEST RESULTS 29

3.5 BAND EDGE MEASUREMENT 31

3.5.1 LIMITS OF BAND EDGE MEASUREMENT 31

3.5.2 TEST SETUP 31

3.5.3 TEST PROCEDURES 32

3.5.4 TEST RESULTS 33

3.6 CONDUCTED SPURIOUS EMISSIONS 41

3.6.1 LIMITS OF CONDUCTED SPURIOUS EMISSIONS MEASUREMENT 41

3.6.2 TEST PROCEDURE 41

3.6.3 TEST SETUP 41

3.6.4 TEST RESULTS 42

3.7 RADIATED EMISSION MEASUREMENT 46

3.7.1 LIMITS OF RADIATED EMISSION MEASUREMENT 46

3.7.2 TEST PROCEDURES 46

3.7.3 DEVIATION FROM TEST STANDARD 46

3.7.4 TEST SETUP 47

3.7.5 TEST RESULTS 49



Test Report No.: RF190325W006-6

4	INFORMATION ON THE TESTING LABORATORIES	63
5	APPENDIX A – MODIFICATIONS RECORDERS FOR ENGINEERING CHANGES TO THE EUT BY THE LAB	64



Test Report No.: RF190325W006-6

RELEASE CONTROL RECORD

ISSUE NO.	REASON FOR CHANGE	DATE ISSUED
RF190325W006-6	Original release	Apr. 19, 2019

1 SUMMARY OF TEST RESULTS

The EUT has been tested according to the following specifications:

APPLIED STANDARD: FCC Part 27 & Part 2			
STANDARD SECTION	TEST TYPE AND LIMIT	RESULT	REMARK
2.1046 27.50(h)(2)	Equivalent Isotropically Radiated Power	PASS	Meet the requirement of limit.
2.1055 27.54	Frequency Stability	PASS	Meet the requirement of limit.
2.1049 27.53(m)(6)	Occupied Bandwidth	PASS	Meet the requirement of limit.
27.50(d)(5)	Peak to average ratio	PASS	Meet the requirement of limit.
2.1051 27.53(m)(4)(6)	Band Edge Measurements	PASS	Meet the requirement of limit.
2.1051 27.53(m)(4)(6)	Conducted Spurious Emissions	PASS	Meet the requirement of limit.
2.1053 27.53(m)(4)(6)	Radiated Spurious Emissions	PASS	Meet the requirement of limit. Minimum passing margin is -7.72dB at 45.12MHz.

1.1 MEASUREMENT UNCERTAINTY

Where relevant, the following measurement uncertainty levels have been estimated for tests performed on the EUT as specified in CISPR 16-4-2:

MEASUREMENT	UNCERTAINTY
Maximum Peak Output Power	±1dB
Frequency Stability	±39.27Hz
Radiated emissions	±4.48dB
Conducted emissions	±2 dB
Occupied Channel Bandwidth	±21.7KHz
Band Edge Measurements	±4.48dB
Peak to average ratio	±0.76dB

This uncertainty represents an expanded uncertainty expressed at approximately the 95% confidence level using a coverage factor of k=2.



1.2 TEST SITE AND INSTRUMENTS

Equipment	Manufacturer	Model No.	Serial No.	Last Cal.	Next Cal.
MXE EMI Receiver	KEYSIGHT	N9038A-544	MY54450026	Feb. 26,19	Feb. 25,20
EXA Signal Analyzer	KEYSIGHT	N9010A-526	MY54510322	Feb. 26,19	Feb. 25,20
Bilog Antenna 1	ETS-LINDGREN	3143B	00161964	Feb. 26,19	Feb. 25,20
Bilog Antenna 2	ETS-LINDGREN	3143B	00161965	Feb. 26,19	Feb. 25,20
Horn Antenna 1	ETS-LINDGREN	3117	00168728	Feb. 26,19	Feb. 25,20
Horn Antenna 2	ETS-LINDGREN	3117	00168692	Nov. 30, 18	Nov. 29, 19
Loop antenna	Daze	ZN30900A	0708	Oct. 23,18	Oct. 22, 19
Horn Antenna (18GHz-40GHz)	N/A	QWH-SL-18-40-K-SG/QMS-00361	15433	Nov. 21, 18	Nov. 20, 19
Radio Communication Analyzer	ANRITSU	MT8820C	6201465426	Feb. 26,19	Feb. 25,20
Signal Pre-Amplifier	EMSI	EMC 9135	980249	Jul. 09,18	Jul. 08,19
Signal Pre-Amplifier	EMSI	EMC 012645B	980257	Jul. 09,18	Jul. 08,19
Signal Pre-Amplifier	EMSI	EMC 184045B	980259	Jul. 09,18	Jul. 08,19
3m Semi-anechoic Chamber	ETS-LINDGREN	9m*6m*6m	Euroshieldpn-CT0001143-1216	Feb. 26,19	Feb. 25,20
Test Software	E3	V 9.160323	N/A	N/A	N/A
Test Software	ADT	ADT_Radiated_V7.6.15.9.2	N/A	N/A	N/A
10dB Attenuator	JFW/USA	50HF-010-SM A	1505	Jul. 09,18	Jul. 08,19
Power Meter	Anritsu	ML2495A	1506002	Feb. 26,19	Feb. 25,20
Power Sensor	Anritsu	MA2411B	1339352	Feb. 26,19	Feb. 25,20
Humid & Temp Programmable Tester	Juyi	ITH-120-45-CP-AR	IAA1504-001	Jul. 09,18	Jul. 08,19
MXG Analog Microwave Signal Generator	KEYSIGHT	N5183A	MY50143024	Feb. 26,19	Feb. 25,20

- NOTE:**
1. The calibration interval of the above test instruments is 12 months or 24 months and the calibrations are traceable to CEPREI/CHINA, GRGT/CHINA and NIM/CHINA.
 2. The test was performed in 3m Semi-anechoic Chamber and RF Oven Room.
 3. The horn antenna is used only for the measurement of emission frequency above 1GHz if tested.
 4. The FCC Site Registration No. is 525120; The Designation No. is CN1171.



2 GENERAL INFORMATION

2.1 GENERAL DESCRIPTION OF EUT

PRODUCT	smartphone	
MODEL NAME	Ilium Alpha 1s	
POWER SUPPLY	5.0Vdc (adapter or host equipment) 3.85Vdc (Li-ion, battery)	
MODULATION TECHNOLOGY	LTE Band 7	QPSK, 16QAM
FREQUENCY RANGE	LTE Band 7 Channel Bandwidth: 5MHz	2502.5MHz ~ 2567.5MHz
	LTE Band 7 Channel Bandwidth: 10MHz	2505MHz ~ 2565MHz
	LTE Band 7 Channel Bandwidth: 15MHz	2507.5MHz ~ 2562.5MHz
	LTE Band 7 Channel Bandwidth: 20MHz	2510MHz ~ 2560MHz
EMISSION DESIGNATOR	LTE Band 7 Channel Bandwidth: 5MHz	QPSK: 4M47G7D 16QAM: 4M47W7D
	LTE Band 7 Channel Bandwidth: 10MHz	QPSK: 8M95G7D 16QAM: 8M95W7D
	LTE Band 7 Channel Bandwidth: 15MHz	QPSK: 13M4G7D 16QAM: 13M4W7D
	LTE Band 7 Channel Bandwidth: 20MHz	QPSK: 17M9G7D 16QAM: 17M9W7D
MAX. EIRP POWER	LTE Band 7 Channel Bandwidth: 5MHz	145mW
	LTE Band 7 Channel Bandwidth: 10MHz	150mW
	LTE Band 7 Channel Bandwidth: 15MHz	145mW
	LTE Band 7 Channel Bandwidth: 20MHz	130mW
ANTENNA TYPE	Fixed Internal Antenna with -2.4dBi	
HW VERSION	V1.0	
SW VERSION	Ilium Alpha 1s_SW_01_V01	
I/O PORTS	Refer to user's manual	
DATA CABLE	USB cable: non-shielded, detachable, 1.0m Earphone cable: non-shielded, detachable, 1.2m	

NOTE:

1. For a more detailed features description, please refer to the manufacturer's specifications or the user's manual.



Test Report No.: RF190325W006-6

2. The EUT was powered by the following adapter:

ADAPTER	
BRAND:	Ianix
MODEL:	Alpha 1s-C
INPUT:	AC 100-240V, 250mA
OUTPUT:	DC 5V, 1550mA

3. The EUT matched the following USB cable and Earphone:

USB CABLE	
BRAND:	Ianix
MODEL:	Alpha 1s
SIGNAL LINE:	1.0 METER

EARPHONE	
BRAND:	Ianix
MODEL:	Alpha 1s
SIGNAL LINE:	1.2 METER

4. For the test results, the EUT had been tested with all conditions. But only the worst case was shown in test report.

2.2 CONFIGURATION OF SYSTEM UNDER TEST

FOR RADIATION EMISSION TEST

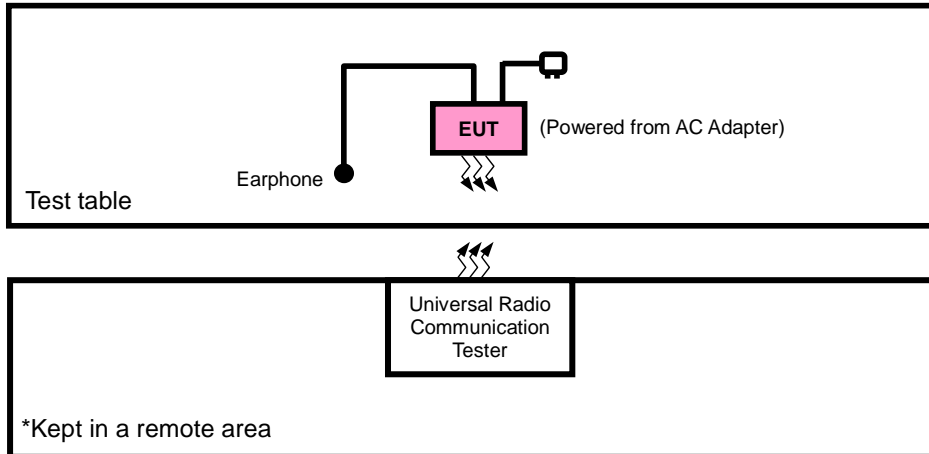

FOR CONDUCTED & E.I.R.P TEST

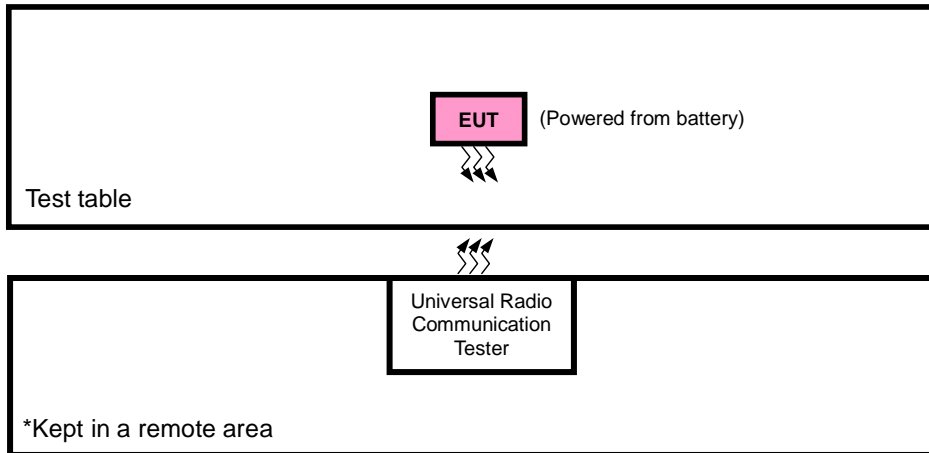



2.3 DESCRIPTION OF SUPPORT UNITS

The EUT has been tested as an independent unit together with other necessary accessories or support units. The following support units or accessories were used to form a representative test configuration during the tests.

NO.	PRODUCT	BRAND	MODEL NO.	SERIAL NO.	FCC ID
1	DC source	LONG WEI	PS-6403D	010934269	N/A
2	PC	HP	A6608CN	3CR83825X3	N/A

NO.	SIGNAL CABLE DESCRIPTION OF THE ABOVE SUPPORT UNITS
1	DC Line: Unshielded, Detachable 1.0m
2	AC Line: Unshielded, Detachable 1.5m

NOTE: All power cords of the above support units are non shielded (1.8m).

2.4 TEST ITEM AND TEST CONFIGURATION

Pre-Scan has been conducted to determine the worst-case mode from all possible combinations between available modulations, data rates, XYZ axis and antenna ports. The worst case was found when positioned on Y-plane for EIRP and X-axis for radiated emission. Following channel(s) was (were) selected for the final test as listed below:

EUT CONFIGURE MODE	DESCRIPTION
A	EUT + Adapter + USB Cable + Earphone with LTE link
B	EUT + Battery with LTE link



LTE BAND 7

EUT CONFIGURE MODE	TEST ITEM	AVAILABLE CHANNEL	TESTED CHANNEL	CHANNEL BANDWIDTH	MODULATION	MODE		
B	EIRP	20775 to 21425	20775, 21100, 21425	5MHz	QPSK, 16QAM	1 RB / 0 RB Offset		
		20800 to 21400	20800, 21100, 21400	10MHz	QPSK, 16QAM	1 RB / 0RB Offset		
		20825 to 21375	20825, 21100, 21375	15MHz	QPSK, 16QAM	1 RB / 0 RB Offset		
		20850 to 21350	20850, 21100, 21350	20MHz	QPSK, 16QAM	1 RB / 0 RB Offset		
B	FREQUENCY STABILITY	20775 to 21425	20775, 21425	5MHz	QPSK	1 RB / 0 RB Offset		
		20800 to 21400	20800, 21400	10MHz	QPSK	1 RB / 0RB Offset		
		20825 to 21375	20825, 21375	15MHz	QPSK	1 RB / 0 RB Offset		
		20850 to 21350	20850, 21350	20MHz	QPSK	1 RB / 0 RB Offset		
B	OCCUPIED BANDWIDTH	20775 to 21425	20775, 21100, 21425	5MHz	QPSK, 16QAM	25 RB / 0 RB Offset		
		20800 to 21400	20800, 21100, 21400	10MHz	QPSK, 16QAM	50 RB / 0 RB Offset		
		20825 to 21375	20825, 21100, 21375	15MHz	QPSK, 16QAM	75 RB / 0 RB Offset		
		20850 to 21350	20850, 21100, 21350	20MHz	QPSK, 16QAM	100 RB / 0 RB Offset		
B	PEAK TO AVERAGE RATIO	20775 to 21425	20775, 21100, 21425	5MHz	QPSK, 16QAM	1 RB / 0 RB Offset		
		20800 to 21400	20800, 21100, 21400	10MHz	QPSK, 16QAM	1 RB / 0RB Offset		
		20825 to 21375	20825, 21100, 21375	15MHz	QPSK, 16QAM	1 RB / 0 RB Offset		
		20850 to 21350	20850, 21100, 21350	20MHz	QPSK, 16QAM	1 RB / 0 RB Offset		
B	BAND EDGE	20775 to 21425	20775	5MHz	QPSK, 16QAM	1 RB / 0 RB Offset		
			21425	5MHz	QPSK, 16QAM	25 RB / 0 RB Offset 1 RB / 24 RB Offset		
		20800 to 21400	20800	10MHz	QPSK, 16QAM	1 RB / 0 RB Offset		
			21400	10MHz	QPSK, 16QAM	50 RB / 0 RB Offset 1 RB / 49 RB Offset		
		20825 to 21375	20825	15MHz	QPSK, 16QAM	1 RB / 0 RB Offset		
			21375	15MHz	QPSK, 16QAM	75 RB / 0 RB Offset 1 RB / 74 RB Offset		
		20850 to 21350	20850	20MHz	QPSK, 16QAM	1 RB / 0 RB Offset		
			21350	20MHz	QPSK, 16QAM	100 RB / 0 RB Offset 1 RB / 99 RB Offset		
		B	CONDCUDED EMISSION	20775 to 21425	20775, 21100, 21425	5MHz	QPSK	1 RB / 0 RB Offset
				20800 to 21400	20800, 21100, 21400	10MHz	QPSK	1 RB / 0RB Offset
				20825 to 21375	20825, 21100, 21375	15MHz	QPSK	1 RB / 0 RB Offset
				20850 to 21350	20850, 21100, 21350	20MHz	QPSK	1 RB / 0 RB Offset
A	RADIATED EMISSION	20775 to 21425	21100	5MHz	QPSK	1 RB / 0 RB Offset		
		20800 to 21400	20800, 21100, 21400	10MHz	QPSK	1 RB / 0RB Offset		
		20825 to 21375	21100	15MHz	QPSK	1 RB / 0 RB Offset		
		20850 to 21350	21100	20MHz	QPSK	1 RB / 0 RB Offset		

Note: This device was tested under all bandwidths, RB configurations and modulations. The worst case was found in QPSK modulation.



TEST CONDITION:

TEST ITEM	ENVIRONMENTAL CONDITIONS	INPUT POWER	TESTED BY
EIRP	24deg. C, 60%RH	3.85Vdc from Battery	Rose Ma
FREQUENCY STABILITY	24deg. C, 61%RH	DC 3.5V/3.8V/4.2V	Rain Wang
OCCUPIED BANDWIDTH	24deg. C, 61%RH	3.85Vdc from Battery	Rain Wang
PEAK TO AVERAGE RATIO	24deg. C, 61%RH	3.85Vdc from Battery	Rain Wang
BAND EDGE	24deg. C, 61%RH	3.85Vdc from Battery	Rain Wang
CONDCUETED EMISSION	24deg. C, 61%RH	3.85Vdc from Battery	Rain Wang
RADIATED EMISSION	24deg. C, 60%RH	5Vdc from adapter	Rose Ma

2.5 GENERAL DESCRIPTION OF APPLIED STANDARDS

The EUT is a RF product. According to the specifications of the manufacturer, it must comply with the requirements of the following standards:

FCC 47 CFR Part 2

FCC 47 CFR Part 27

KDB 971168 D01 Power Meas License Digital Systems v03r01

ANSI/TIA/EIA-603-D

ANSI/TIA/EIA-603-E

ANSI C63.26-2015

NOTE: All test items have been performed and recorded as per the above standards.



3 TEST TYPES AND RESULTS

3.1 OUTPUT POWER MEASUREMENT

3.1.1 LIMITS OF OUTPUT POWER MEASUREMENT

The radiated peak output power shall be according to the specific rule Part 27.50(h)(2) that “User stations are limited to 2 watts” and 27.50(i) specific that “Peak transmit power must be measure over any interval of continuous transmission using instrumentation calibration in terms of rms-equivalent voltage.”

3.1.2 TEST PROCEDURES

EIRP MEASUREMENT:

- a. All measurements were done at low, middle and high operational frequency range. RBW and VBW is 10MHz for LTE mode.
- b. Substitution method is used for E.I.R.P measurement. In the semi-anechoic chamber, EUT placed on the 0.8m height of Turn Table, rotated the table around 360 degrees to search the maximum radiation power and receiver antenna shall be rotated vertical and horizontal polarization and moved height from 1m to 4m to find the maximum polar radiated power. The “Read Value” is the spectrum reading the maximum power value.
- c. The substitution horn antenna is substituted for EUT at the same position and signals generator export the CW signal to the substitution antenna via a tx cable. Rotated the Turn Table and moved receiving antenna to find the maximum radiation power. Adjust output power level of S.G to get a Value of spectrum reading equal to “Read Value” of step b. Record the power level of S.G.
- d. $EIRP = \text{Output power level of S.G} - \text{TX cable loss} + \text{Antenna gain of substitution horn}.$

CONDUCTED POWER MEASUREMENT:

- a. The EUT was set up for the maximum power with LTE link data modulation and link up with simulator.
- b. Set the EUT to transmit under low, middle and high channel and record the power level shown on simulator.

3.1.3 TEST SETUP

EIRP / ERP Measurement:

<Radiated Emission below or equal 1 GHz>

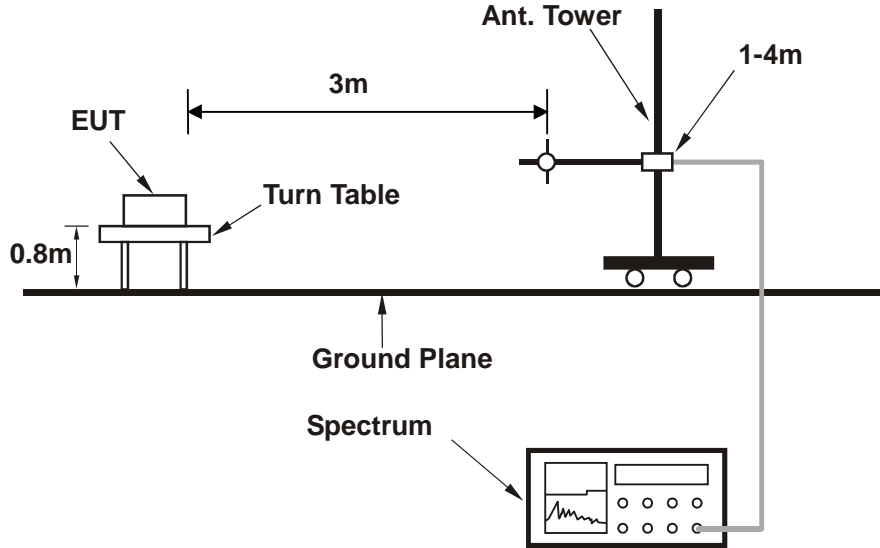

<Radiated Emission above 1 GHz>

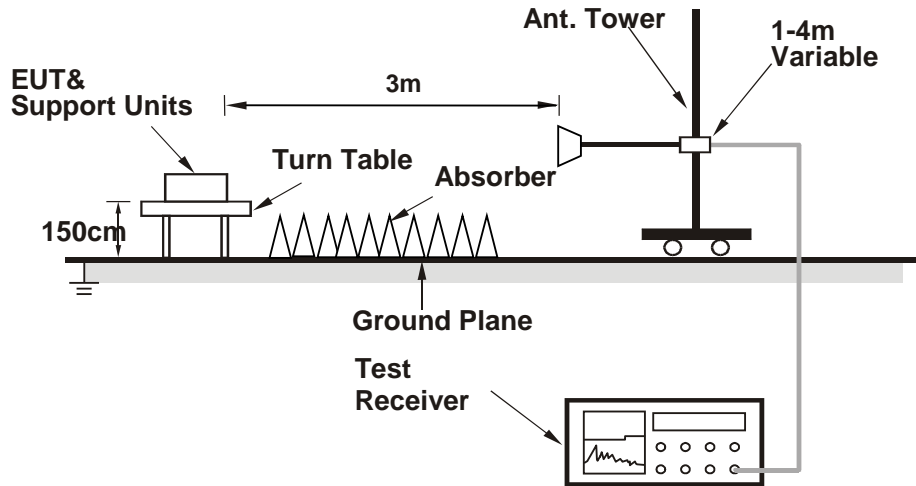

For the actual test configuration, please refer to the attached file (Test Setup Photo).

CONDUCTED POWER MEASUREMENT:

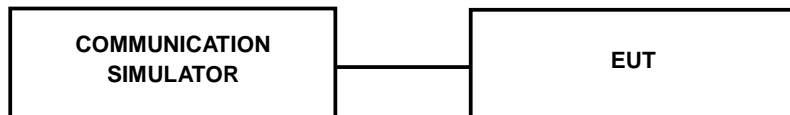



3.1.4 TEST RESULTS

AVERAGE CONDUCTED OUTPUT POWER (dBm)

LTE Band 7							
BW	Modulation	RB Size	RB Offset	Low CH 20775	Mid CH 21100	High CH 21425	MPR
				Frequency 2502.5 MHz	Frequency 2535 MHz	Frequency 2567.5 MHz	
5 MHz	QPSK	1	0	22.61	22.69	22.43	0
		1	12	22.53	22.61	22.35	0
		1	24	22.50	22.58	22.32	0
		12	0	21.66	21.74	21.48	1
		12	6	21.62	21.70	21.44	1
		12	13	21.56	21.64	21.38	1
		25	0	21.63	21.71	21.45	1
	16QAM	1	0	21.67	21.75	21.49	1
		1	12	21.76	21.84	21.58	1
		1	24	21.80	21.88	21.62	1
		12	0	20.70	20.78	20.52	2
		12	6	20.66	20.74	20.48	2
		12	13	20.74	20.82	20.56	2
		25	0	20.72	20.80	20.54	2
BW	Modulation	RB Size	RB Offset	Low CH 20800	Mid CH 21100	High CH 21400	MPR
				Frequency 2505 MHz	Frequency 2535 MHz	Frequency 2565 MHz	
10 MHz	QPSK	1	0	22.65	22.73	22.47	0
		1	24	22.57	22.65	22.39	0
		1	49	22.54	22.62	22.36	0
		25	0	21.70	21.78	21.52	1
		25	12	21.66	21.74	21.48	1
		25	25	21.60	21.68	21.42	1
		50	0	21.67	21.75	21.49	1
	16QAM	1	0	21.71	21.79	21.53	1
		1	24	21.80	21.88	21.62	1
		1	49	21.84	21.92	21.66	1
		25	0	20.74	20.82	20.56	2
		25	12	20.70	20.78	20.52	2
		25	25	20.78	20.86	20.60	2
		50	0	20.76	20.84	20.58	2



LTE Band 7							
BW	Modulation	RB Size	RB Offset	Low CH 20825	Mid CH 21100	High CH 21375	MPR
				Frequency 2507.5 MHz	Frequency 2535 MHz	Frequency 2562.5 MHz	
15 MHz	QPSK	1	0	22.71	22.79	22.53	0
		1	37	22.63	22.71	22.45	0
		1	74	22.60	22.68	22.42	0
		36	0	21.76	21.84	21.58	1
		36	19	21.72	21.80	21.54	1
		36	39	21.66	21.74	21.48	1
		75	0	21.73	21.81	21.55	1
	16QAM	1	0	21.77	21.85	21.59	1
		1	37	21.86	21.94	21.68	1
		1	74	21.90	21.98	21.72	1
		36	0	20.80	20.88	20.62	2
		36	19	20.76	20.84	20.58	2
		36	39	20.84	20.92	20.66	2
		75	0	20.82	20.90	20.64	2
BW	Modulation	RB Size	RB Offset	Low CH 20850	Mid CH 21100	High CH 21350	MPR
				Frequency 2510 MHz	Frequency 2535 MHz	Frequency 2560 MHz	
20 MHz	QPSK	1	0	22.74	22.82	22.56	0
		1	50	22.66	22.74	22.48	0
		1	99	22.63	22.71	22.45	0
		50	0	21.79	21.87	21.61	1
		50	25	21.75	21.83	21.57	1
		50	50	21.69	21.77	21.51	1
		100	0	21.76	21.84	21.58	1
	16QAM	1	0	21.80	21.88	21.62	1
		1	50	21.89	21.97	21.71	1
		1	99	21.93	22.01	21.75	1
		50	0	20.83	20.91	20.65	2
		50	25	20.79	20.87	20.61	2
		50	50	20.87	20.95	20.69	2
		100	0	20.85	20.93	20.67	2



Test Report No.: RF190325W006-6

EIRP

LTE BAND 7

CHANNEL BANDWIDTH: 5MHz QPSK

Channel	Frequency (MHz)	SPA LVL (dBm)	Correction Factor(dB)	EIRP(dBm)	EIRP(mW)	Polarization (H/V)	Limit (W)
20775	2502.5	-24.41	45.65	21.24	132.98	H	2
21100	2535.0	-24.42	46.04	21.62	145.04	H	2
21425	2567.5	-24.44	45.87	21.43	138.87	H	2
20775	2502.5	-31.53	47.03	15.50	35.47	V	2
21100	2535.0	-31.58	46.57	14.99	31.55	V	2
21425	2567.5	-30.60	46.98	16.38	43.45	V	2

CHANNEL BANDWIDTH: 5MHz 16QAM

Channel	Frequency (MHz)	SPA LVL (dBm)	Correction Factor(dB)	EIRP(dBm)	EIRP(mW)	Polarization (H/V)	Limit (W)
20775	2502.5	-25.24	45.65	20.41	109.85	H	2
21100	2535.0	-25.44	46.04	20.60	114.68	H	2
21425	2567.5	-25.54	45.87	20.33	107.80	H	2
20775	2502.5	-32.36	47.03	14.67	29.30	V	2
21100	2535.0	-32.60	46.57	13.97	24.95	V	2
21425	2567.5	-31.70	46.98	15.28	33.73	V	2

CHANNEL BANDWIDTH: 10MHz QPSK

Channel	Frequency (MHz)	SPA LVL (dBm)	Correction Factor(dB)	EIRP(dBm)	EIRP(mW)	Polarization (H/V)	Limit (W)
20800	2505.0	-24.22	45.65	21.43	138.96	H	2
21100	2535.0	-24.36	46.04	21.68	147.06	H	2
21400	2565.0	-24.31	46.07	21.76	149.80	H	2
20800	2505.0	-31.34	47.18	15.84	38.34	V	2
21100	2535.0	-31.52	46.57	15.05	31.99	V	2
21400	2565.0	-30.47	47.06	16.59	45.65	V	2



Test Report No.: RF190325W006-6

CHANNEL BANDWIDTH: 10MHz 16QAM

Channel	Frequency (MHz)	SPA LVL (dBm)	Correction Factor(dB)	EIRP(dBm)	EIRP(mW)	Polarization (H/V)	Limit (W)
20800	2505.0	-25.37	45.65	20.28	106.64	H	2
21100	2535.0	-25.46	46.04	20.58	114.16	H	2
21400	2565.0	-25.47	46.07	20.60	114.68	H	2
20800	2505.0	-32.49	47.18	14.69	29.42	V	2
21100	2535.0	-32.62	46.57	13.95	24.83	V	2
21400	2565.0	-31.63	47.06	15.43	34.95	V	2

CHANNEL BANDWIDTH: 15MHz QPSK

Channel	Frequency (MHz)	SPA LVL (dBm)	Correction Factor(dB)	EIRP(dBm)	EIRP(mW)	Polarization (H/V)	Limit (W)
20825	2507.5	-24.23	45.63	21.40	138.13	H	2
21100	2535.0	-24.43	46.04	21.61	144.71	H	2
21375	2562.5	-24.38	45.94	21.56	143.15	H	2
20825	2507.5	-31.35	47.39	16.04	40.17	V	2
21100	2535.0	-31.59	46.57	14.98	31.48	V	2
21375	2562.5	-30.54	47.00	16.46	44.25	V	2

CHANNEL BANDWIDTH: 15MHz 16QAM

Channel	Frequency (MHz)	SPA LVL (dBm)	Correction Factor(dB)	EIRP(dBm)	EIRP(mW)	Polarization (H/V)	Limit (W)
20825	2507.5	-25.09	45.63	20.54	113.32	H	2
21100	2535.0	-25.30	46.04	20.74	118.44	H	2
21375	2562.5	-25.23	45.94	20.71	117.71	H	2
20825	2507.5	-32.21	47.39	15.18	32.95	V	2
21100	2535.0	-32.46	46.57	14.11	25.76	V	2
21375	2562.5	-31.39	47.00	15.61	36.38	V	2



Test Report No.: RF190325W006-6

CHANNEL BANDWIDTH: 20MHz QPSK

Channel	Frequency (MHz)	SPA LVL (dBm)	Correction Factor(dB)	EIRP(dBm)	EIRP(mW)	Polarization (H/V)	Limit (W)
20850	2510.0	-24.81	45.80	20.99	125.57	H	2
21100	2535.0	-24.88	46.04	21.16	130.47	H	2
21350	2560.0	-24.96	45.83	20.87	122.26	H	2
20850	2510.0	-31.93	47.21	15.28	33.73	V	2
21100	2535.0	-32.04	46.57	14.53	28.35	V	2
21350	2560.0	-31.12	47.07	15.95	39.35	V	2

CHANNEL BANDWIDTH: 20MHz 16QAM

Channel	Frequency (MHz)	SPA LVL (dBm)	Correction Factor(dB)	EIRP(dBm)	EIRP(mW)	Polarization (H/V)	Limit (W)
20850	2510.0	-25.74	45.80	20.06	101.37	H	2
21100	2535.0	-25.95	46.04	20.09	101.98	H	2
21350	2560.0	-25.79	45.83	20.04	101.00	H	2
20850	2510.0	-32.86	47.21	14.35	27.23	V	2
21100	2535.0	-33.11	46.57	13.46	22.16	V	2
21350	2560.0	-31.95	47.07	15.12	32.50	V	2

REMARKS: 1. EIRP Output Power (dBm) = SPA LVL (dBm) + Correction Factor (dB).
 2. Correction factor (dB) = Free Space Loss + Antenna Factor + Cable Loss

3.2 FREQUENCY STABILITY MEASUREMENT

3.2.1 LIMITS OF FREQUENCY STABILITY MEASUREMENT

The frequency stability shall be sufficient to ensure that the fundamental emissions stay within the authorized bands of operation.

3.2.2 TEST PROCEDURE

- Device is placed at the oven room. The oven room could control the temperatures and humidity. Power warm up is at least 15 min and power applied should perform before recording frequency error.
- EUT is connected the external power supply to control the DC input power. The test voltage range is from minimum to maximum working voltage. Each step shall be record the frequency error rate.
- The temperature range step is 10 degrees in this test items. All temperature levels shall be hold the $\pm 0.5^{\circ}\text{C}$ during the measurement testing. The each temperature step shall be at least 0.5 hours, consider the EUT could be test under the stability condition.

NOTE: The frequency error was recorded frequency error from the communication simulator.

3.2.3 TEST SETUP

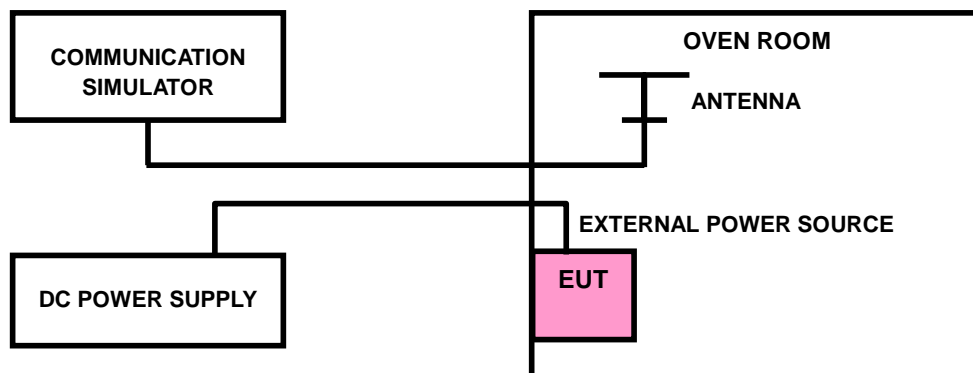



3.2.4 TEST RESULTS

LTE BAND 7

FREQUENCY ERROR VS. VOLTAGE

VOLTAGE (Volts)	5MHz		LIMIT (ppm)
	FREQUENCY ERROR (ppm)		
	Low Channel	High Channel	
3.8	0.0007	0.0007	2.5
3.5	-0.0010	-0.0008	2.5
4.2	0.0008	0.0007	2.5

NOTE: The applicant defined the normal working voltage of the battery is from 3.5Vdc to 4.2Vdc.

FREQUENCY ERROR vs. TEMPERATURE.

TEMP. (°C)	5MHz		LIMIT (ppm)
	FREQUENCY ERROR (ppm)		
	Low Channel	High Channel	
-30	-0.0050	-0.0050	2.5
-20	-0.0045	-0.0044	2.5
-10	-0.0039	-0.0038	2.5
0	-0.0036	-0.0036	2.5
10	-0.0028	-0.0028	2.5
20	-0.0024	-0.0023	2.5
30	-0.0017	-0.0017	2.5
40	-0.0010	-0.0010	2.5
50	-0.0002	-0.0002	2.5



FREQUENCY ERROR VS. VOLTAGE

VOLTAGE (Volts)	10MHz		LIMIT (ppm)
	FREQUENCY ERROR (ppm)		
	Low Channel	High Channel	
3.8	0.0008	0.0008	2.5
3.5	-0.0008	-0.0010	2.5
4.2	0.0009	0.0007	2.5

NOTE: The applicant defined the normal working voltage of the battery is from 3.5Vdc to 4.2Vdc.

FREQUENCY ERROR vs. TEMPERATURE.

TEMP. (°C)	10MHz		LIMIT (ppm)
	FREQUENCY ERROR (ppm)		
	Low Channel	High Channel	
-30	-0.0053	-0.0052	2.5
-20	-0.0047	-0.0045	2.5
-10	-0.0037	-0.0037	2.5
0	-0.0028	-0.0028	2.5
10	-0.0024	-0.0024	2.5
20	-0.0019	-0.0019	2.5
30	-0.0012	-0.0012	2.5
40	-0.0010	-0.0010	2.5
50	-0.0005	-0.0005	2.5



FREQUENCY ERROR VS. VOLTAGE

VOLTAGE (Volts)	15MHz		LIMIT (ppm)
	FREQUENCY ERROR (ppm)		
	Low Channel	High Channel	
3.8	0.0008	0.0006	2.5
3.5	-0.0009	-0.0009	2.5
4.2	-0.0007	0.0007	2.5

NOTE: The applicant defined the normal working voltage of the battery is from 3.5Vdc to 4.2Vdc.

FREQUENCY ERROR vs. TEMPERATURE.

TEMP. (°C)	15MHz		LIMIT (ppm)
	FREQUENCY ERROR (ppm)		
	Low Channel	High Channel	
-30	-0.0056	-0.0056	2.5
-20	-0.0051	-0.0052	2.5
-10	-0.0040	-0.0041	2.5
0	-0.0035	-0.0036	2.5
10	-0.0028	-0.0028	2.5
20	-0.0023	-0.0023	2.5
30	-0.0013	-0.0013	2.5
40	-0.0008	-0.0008	2.5
50	-0.0002	-0.0002	2.5



FREQUENCY ERROR VS. VOLTAGE

VOLTAGE (Volts)	20MHz		LIMIT (ppm)
	FREQUENCY ERROR (ppm)		
	Low Channel	High Channel	
3.8	0.0007	0.0007	2.5
3.5	-0.0007	-0.0010	2.5
4.2	0.0005	0.0007	2.5

NOTE: The applicant defined the normal working voltage of the battery is from 3.5Vdc to 4.2Vdc.

FREQUENCY ERROR vs. TEMPERATURE.

TEMP. (°C)	20MHz		LIMIT (ppm)
	FREQUENCY ERROR (ppm)		
	Low Channel	High Channel	
-30	-0.0055	-0.0055	2.5
-20	-0.0052	-0.0053	2.5
-10	-0.0046	-0.0046	2.5
0	-0.0040	-0.0041	2.5
10	-0.0029	-0.0029	2.5
20	-0.0024	-0.0024	2.5
30	-0.0017	-0.0017	2.5
40	-0.0012	-0.0012	2.5
50	-0.0003	-0.0003	2.5

3.3 OCCUPIED BANDWIDTH MEASUREMENT

3.3.1 LIMITS OF OCCUPIED BANDWIDTH MEASUREMENT

The width of a frequency band such that, below the lower and above the upper frequency limits, the mean powers emitted are each equal to a specified percentage 0.5 %of the total mean power of a given emission.

3.3.2 TEST SETUP

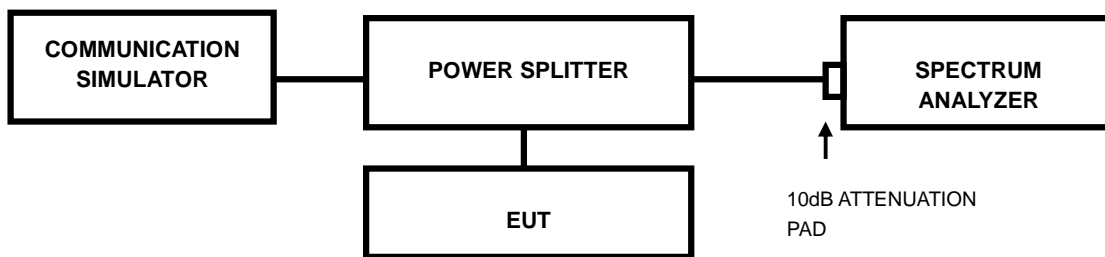

3.3.3 TEST PROCEDURES

- The conducted occupied bandwidth used the power splitter via EUT RF power connector between simulation base station and spectrum analyzer.
- Use OBW measurement function of Spectrum analyzer to measure 99 % occupied bandwidth.



3.3.4 TEST RESULTS

LTE BAND 7							
CHANNEL BANDWIDTH: 5MHz				CHANNEL BANDWIDTH: 10MHz			
CHANNEL	FREQUENCY (MHz)	99% OCCUPIED BANDWIDTH (MHz)		CHANNEL	FREQUENCY (MHz)	99% OCCUPIED BANDWIDTH (MHz)	
		QPSK	16QAM			QPSK	16QAM
20775	2502.5	4.47	4.47	20800	2505	8.93	8.95
21100	2535	4.47	4.47	21100	2535	8.95	8.92
21425	2567.5	4.47	4.47	21400	2565	8.95	8.93

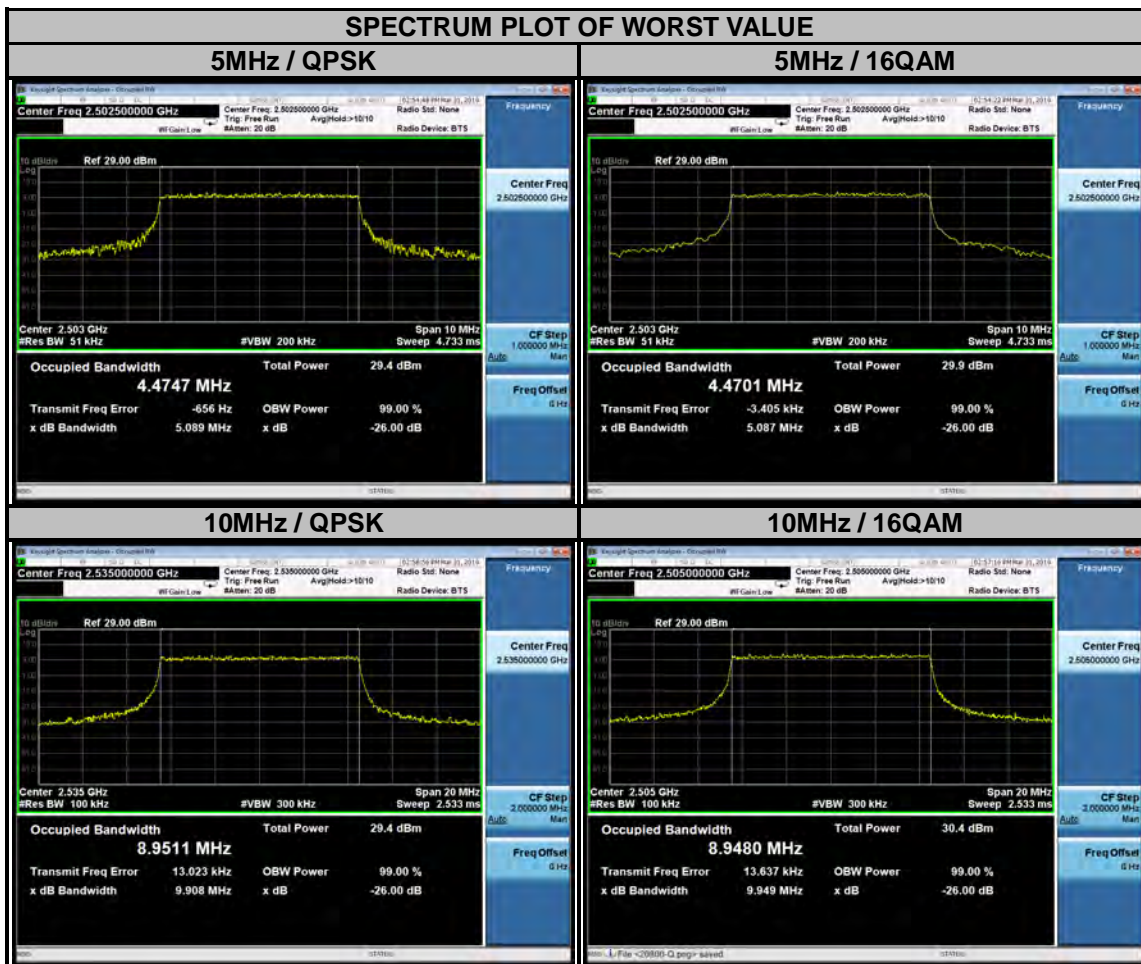



LTE BAND 7							
CHANNEL BANDWIDTH: 15MHz				CHANNEL BANDWIDTH: 20MHz			
CHANNEL	FREQUENCY (MHz)	99% OCCUPIED BANDWIDTH (MHz)		CHANNEL	FREQUENCY (MHz)	99% OCCUPIED BANDWIDTH (MHz)	
		QPSK	16QAM			QPSK	16QAM
20825	2507.5	13.39	13.41	20850	2510	17.88	17.86
21100	2535	13.41	13.41	21100	2535	17.87	17.90
21375	2562.5	13.40	13.41	21350	2560	17.90	17.88

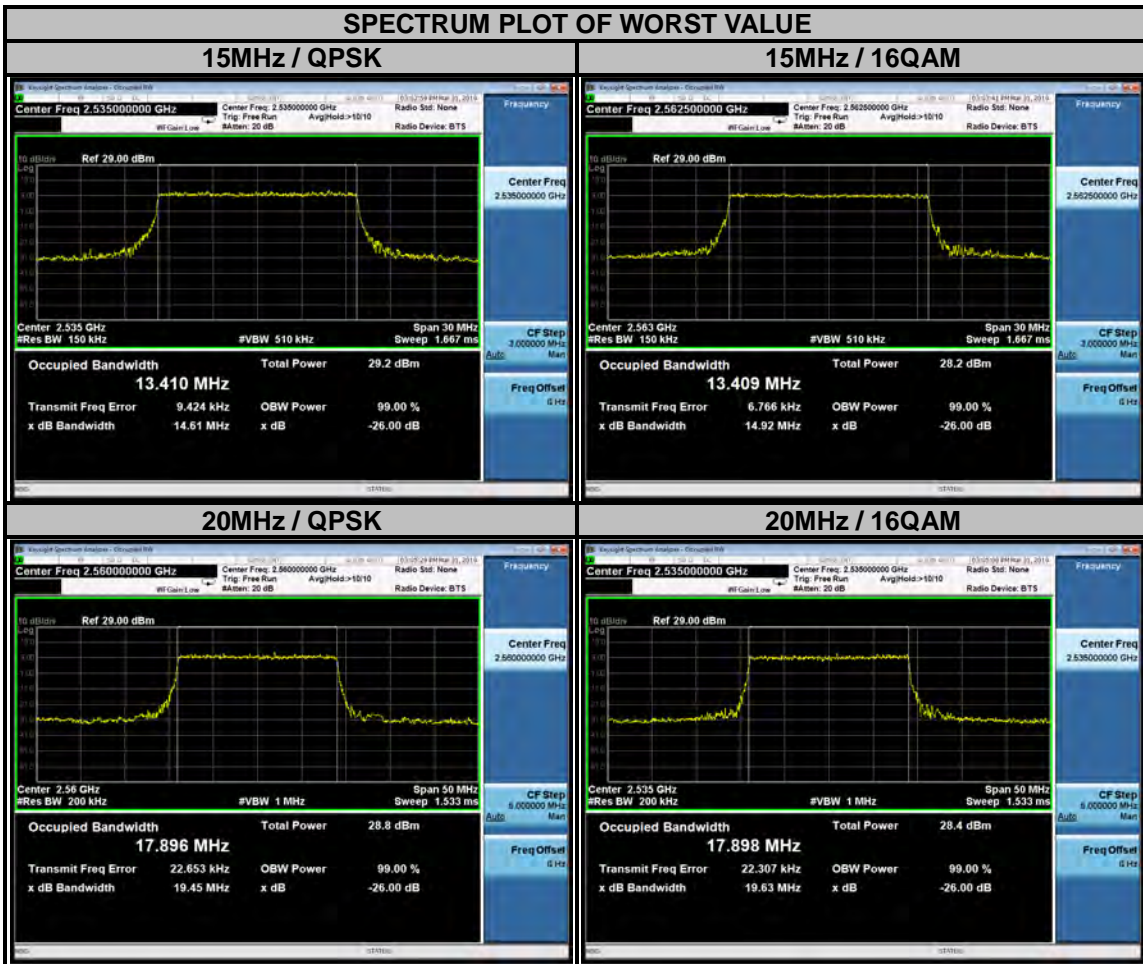

3.4 PEAK TO AVERAGE RATIO

3.4.1 LIMITS OF PEAK TO AVERAGE RATIO MEASUREMENT

In measuring transmissions in this band using an average power technique, the peak to-average ratio (PAR) of the transmission may not exceed 13 dB.

3.4.2 TEST SETUP

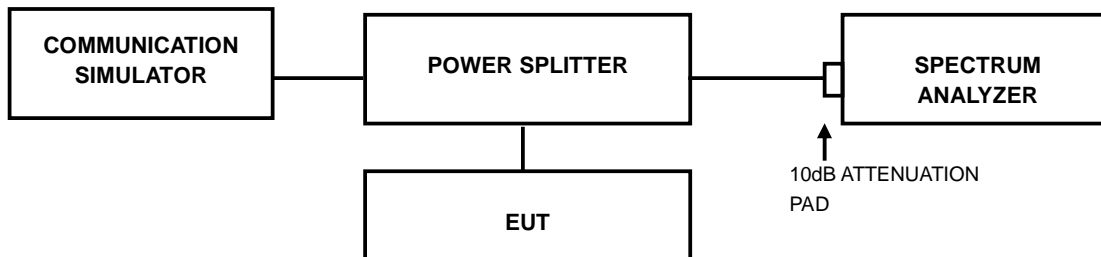

3.4.3 TEST PROCEDURES

1. Set resolution/measurement bandwidth \geq signal's occupied bandwidth;
2. Set the number of counts to a value that stabilizes the measured CCDF curve;
3. Record the maximum PAPR level associated with a probability of 0.1%.



3.4.4 TEST RESULTS

LTE BAND 7

CHANNEL BANDWIDTH: 5MHz				CHANNEL BANDWIDTH: 10MHz			
CHANNEL	FREQUENCY (MHz)	PEAK TO AVERAGE RATIO (dB)		CHANNEL	FREQUENCY (MHz)	PEAK TO AVERAGE RATIO (dB)	
		QPSK	16QAM			QPSK	16QAM
20775	2502.5	5.90	6.23	20800	2505	5.69	6.24
21100	2535	6.14	5.98	21100	2535	6.28	6.82
21425	2567.5	5.96	6.23	21400	2565	6.07	6.63

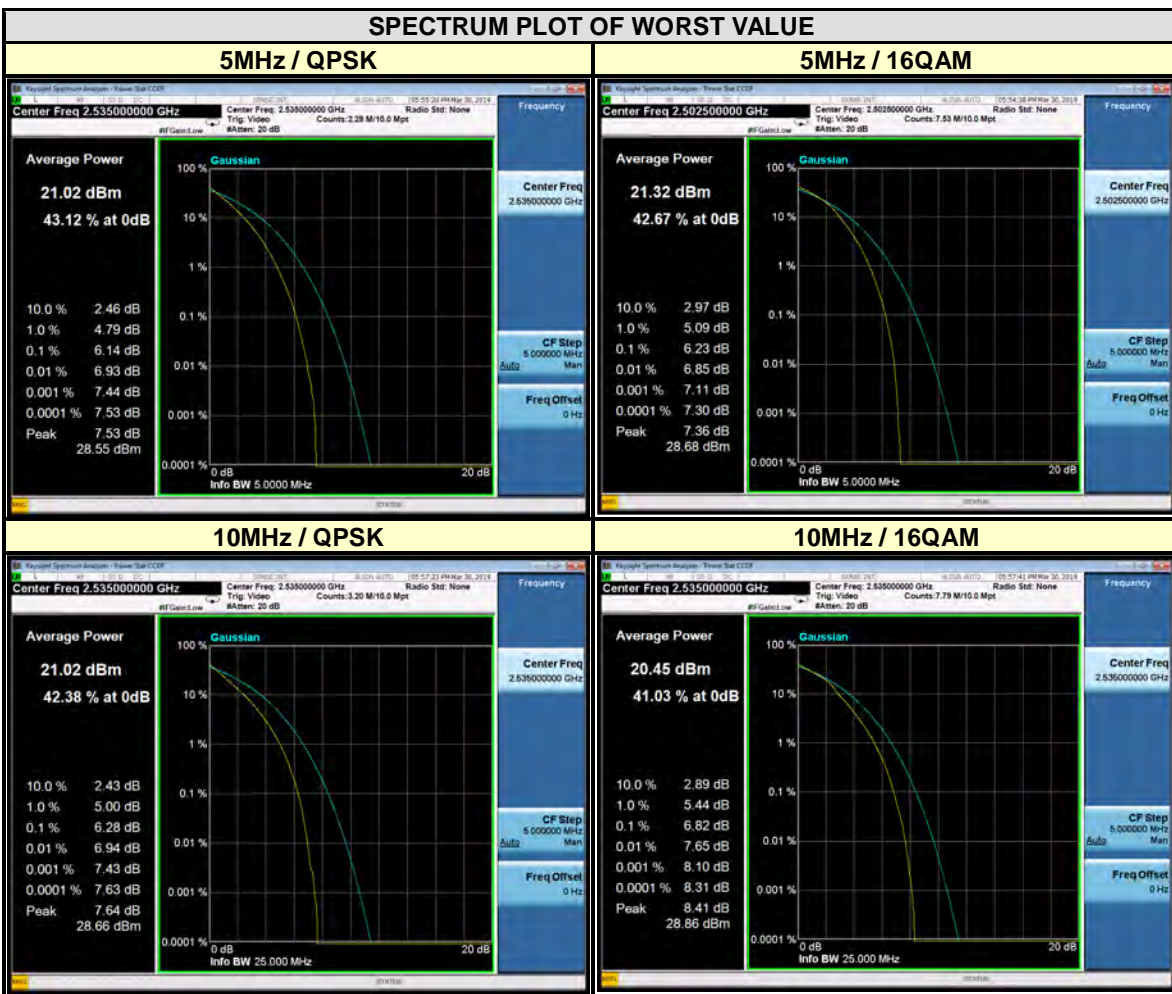



CHANNEL BANDWIDTH: 15MHz				CHANNEL BANDWIDTH: 20MHz			
CHANNEL	FREQUENCY (MHz)	PEAK TO AVERAGE RATIO (dB)		CHANNEL	FREQUENCY (MHz)	PEAK TO AVERAGE RATIO (dB)	
		QPSK	16QAM			QPSK	16QAM
20825	2507.5	5.73	6.32	20850	2510	5.79	6.38
21100	2535	6.16	6.72	21100	2535	6.08	6.71
21375	2562.5	5.99	6.27	21350	2560	6.01	6.64

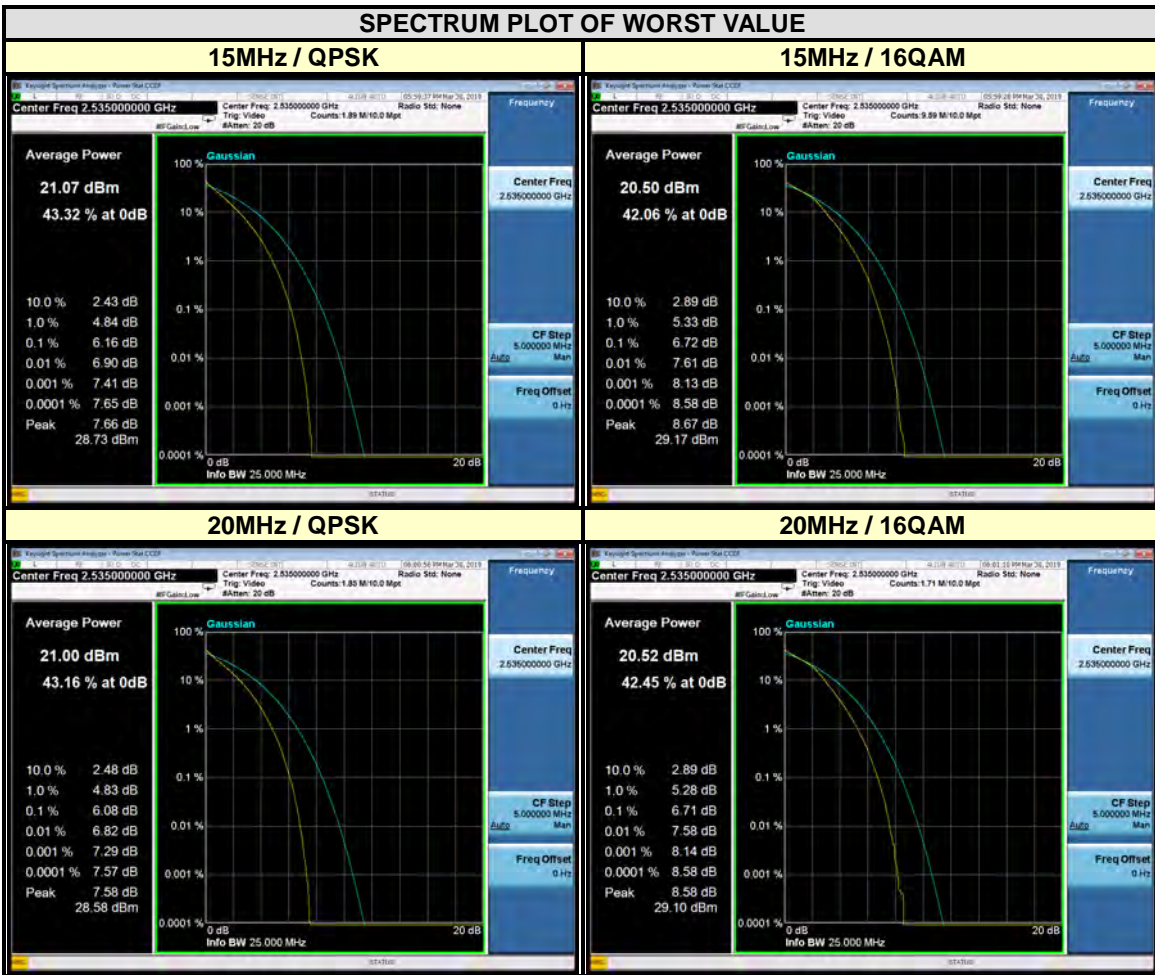

3.5 BAND EDGE MEASUREMENT

3.5.1 LIMITS OF BAND EDGE MEASUREMENT

According to FCC 27.53(m)(4) specified that For mobile digital stations, the attenuation factor shall be not less than $40 + 10 \log (P)$ dB on all frequencies between the channel edge and 5 megahertz from the channel edge, $43 + 10 \log (P)$ dB on all frequencies between 5 megahertz and X megahertz from the channel edge, and $55 + 10 \log (P)$ dB on all frequencies more than X megahertz from the channel edge, where X is the greater of 6 megahertz or the actual emission bandwidth as defined in paragraph (m)(6) of this section. In addition, the attenuation factor shall not be less that $43 + 10 \log (P)$ dB on all frequencies between 2490.5 MHz and 2496 MHz and $55 + 10 \log (P)$ dB at or below 2490.5 MHz. Mobile Satellite Service licensees operating on frequencies below 2495 MHz may also submit a documented interference complaint against BRS licensees operating on channel BRS Channel 1 on the same terms and conditions as adjacent channel BRS or EBS licensees. For mobile digital stations, in the 1 megahertz bands immediately outside and adjacent to the frequency block a resolution bandwidth of at least two percent may be employed.

3.5.2 TEST SETUP

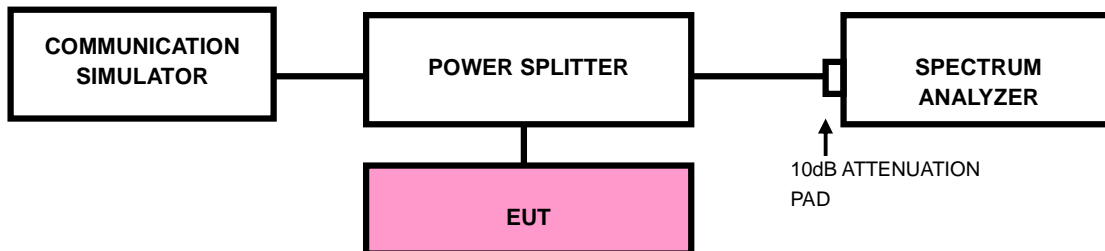



3.5.3 TEST PROCEDURES

- a. The EUT was set up for the maximum peak power with LTE link data modulation. The power was measured with R&S Spectrum Analyzer. All measurements were done at 2 channels (low and high operational frequency range.).
- b. The band edge measurement used the power splitter via EUT RF power connector between simulation base station and spectrum analyzer.
- c. The center frequency of spectrum is the band edge frequency and span is 35MHz. RBW of the spectrum is 100kHz and VBW of the spectrum is 300kHz (Channel bandwidth 5MHz).
- d. The center frequency of spectrum is the band edge frequency and span is 50MHz. RBW of the spectrum is 200kHz and VBW of the spectrum is 1MHz (Channel bandwidth 10MHz).
- e. The center frequency of spectrum is the band edge frequency and span is 60MHz. RBW of the spectrum is 300kHz and VBW of the spectrum is 1MHz (Channel bandwidth 15MHz).
- f. The center frequency of spectrum is the band edge frequency and span is 80MHz. RBW of the spectrum is 500kHz and VBW of the spectrum is 2MHz (Channel bandwidth 20MHz).
- g. Record the max trace plot into the test report.



3.5.4 TEST RESULTS

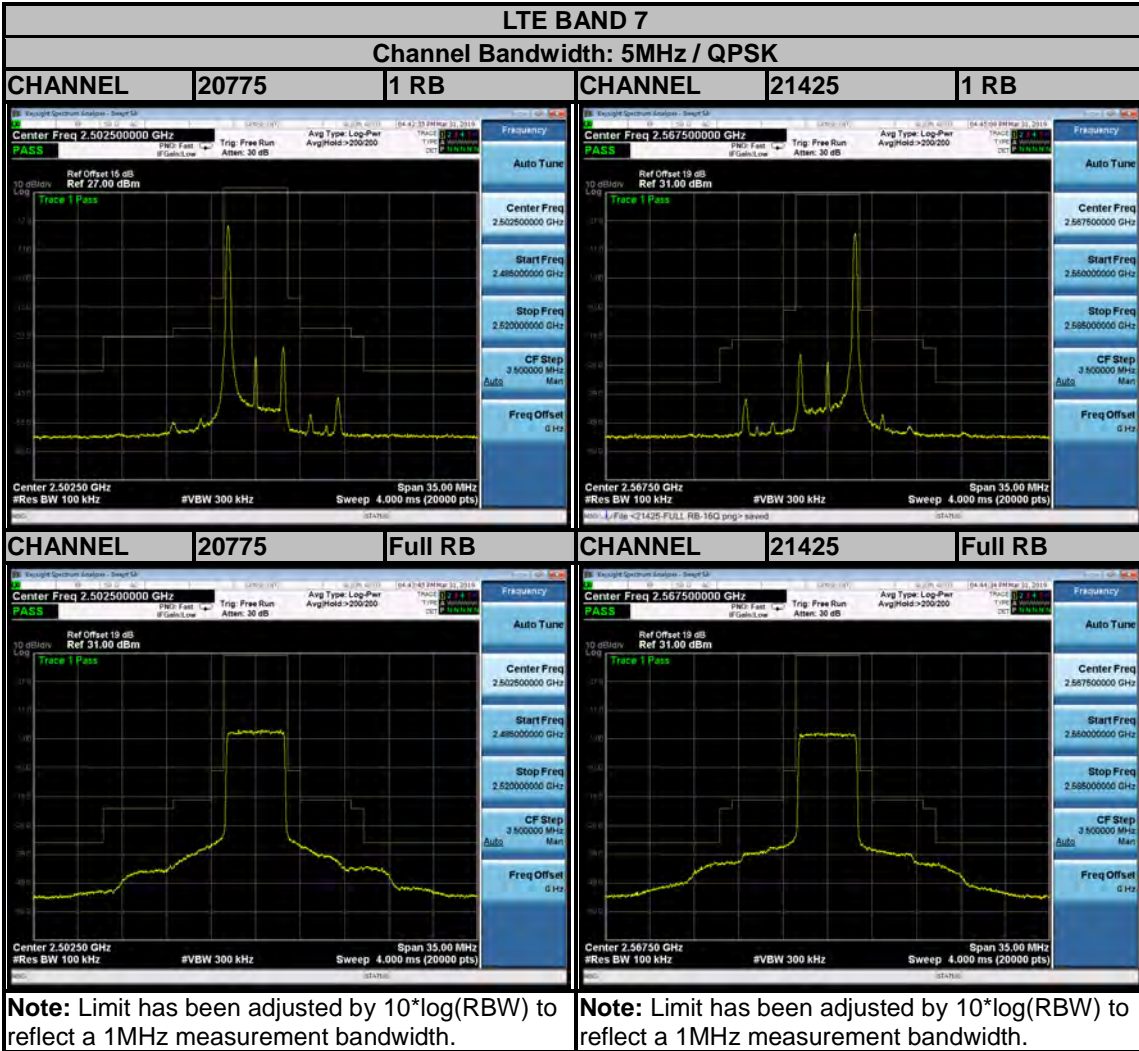



Test Report No.: RF190325W006-6

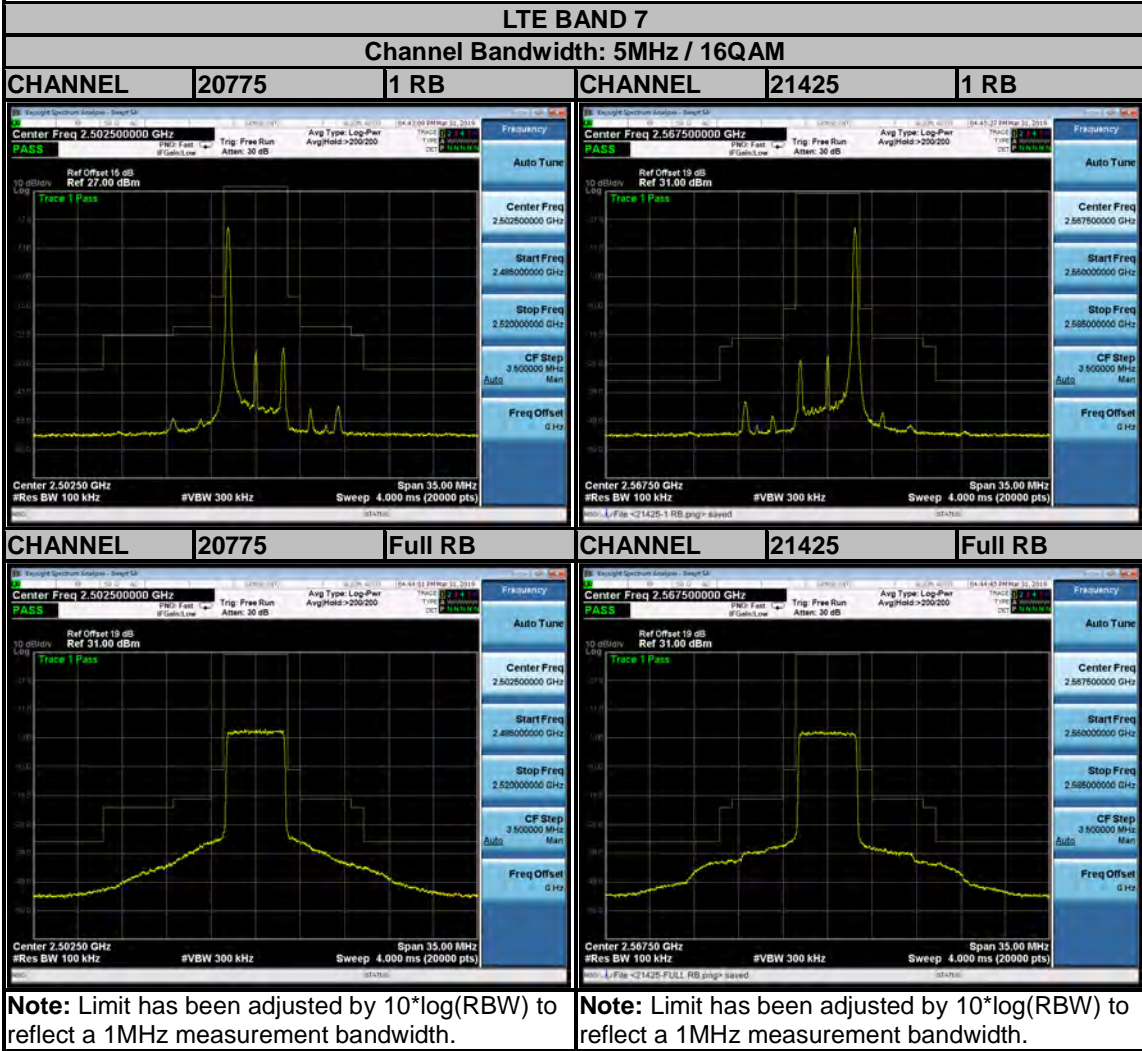

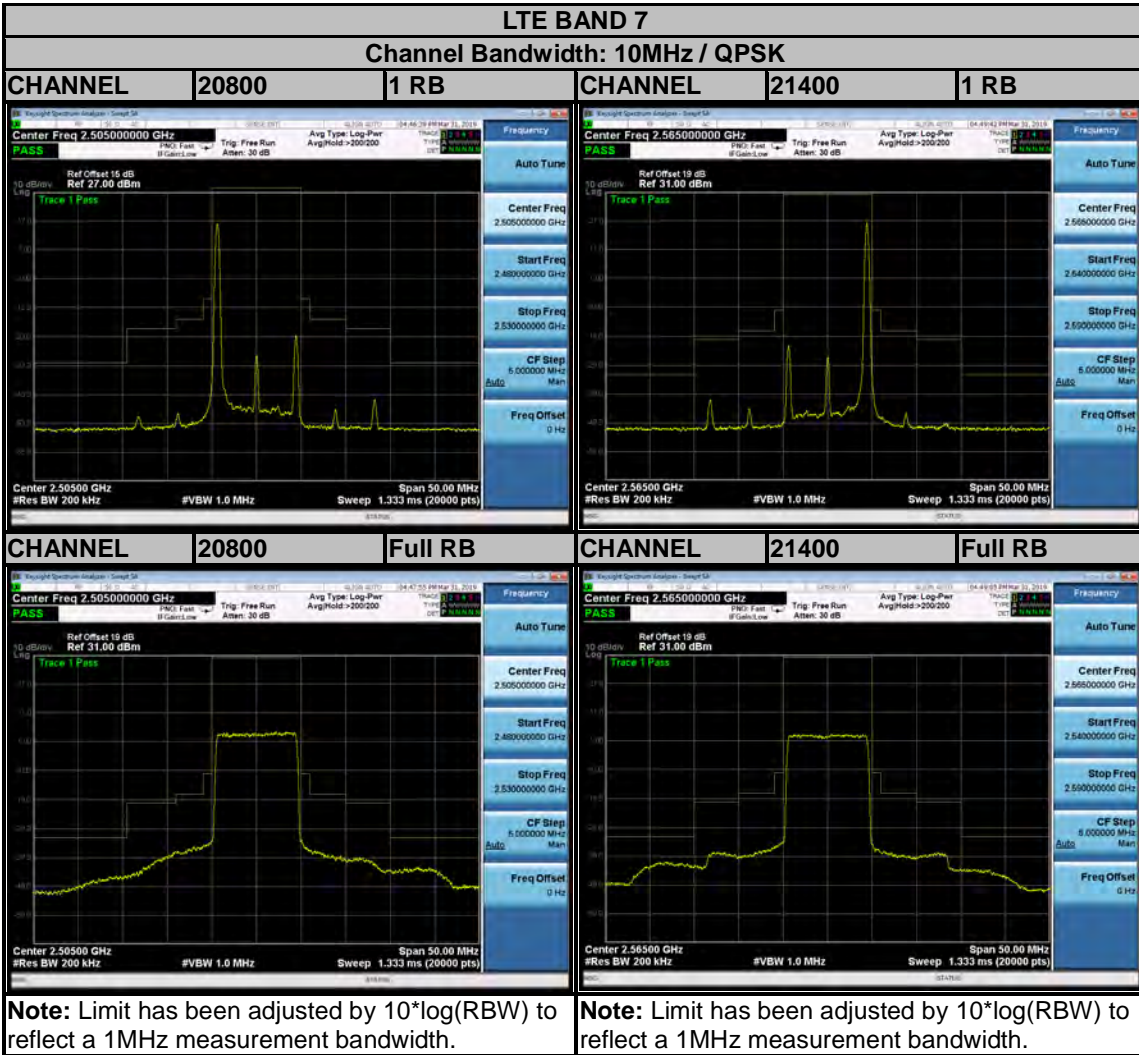



Test Report No.: RF190325W006-6

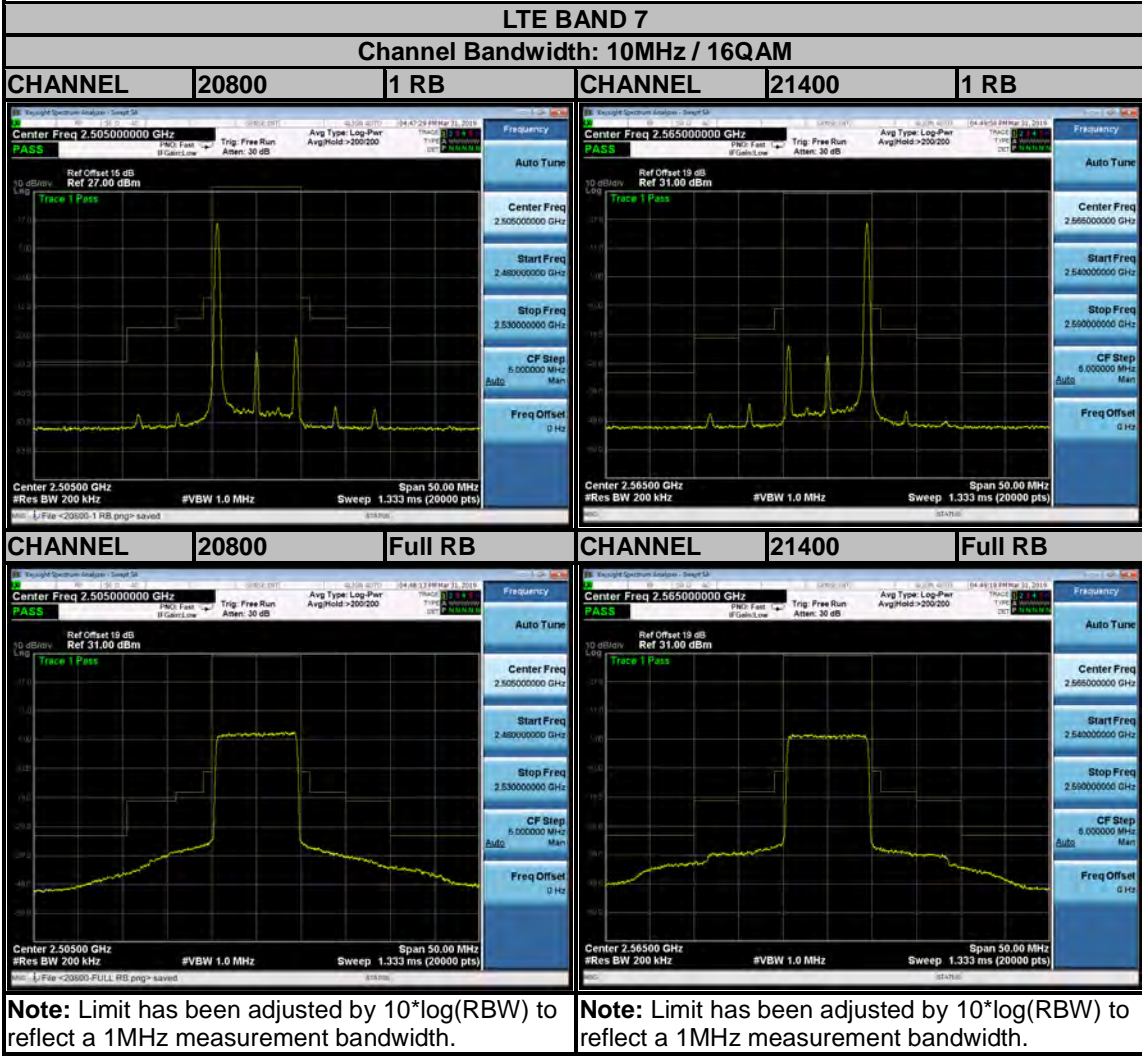



Test Report No.: RF190325W006-6

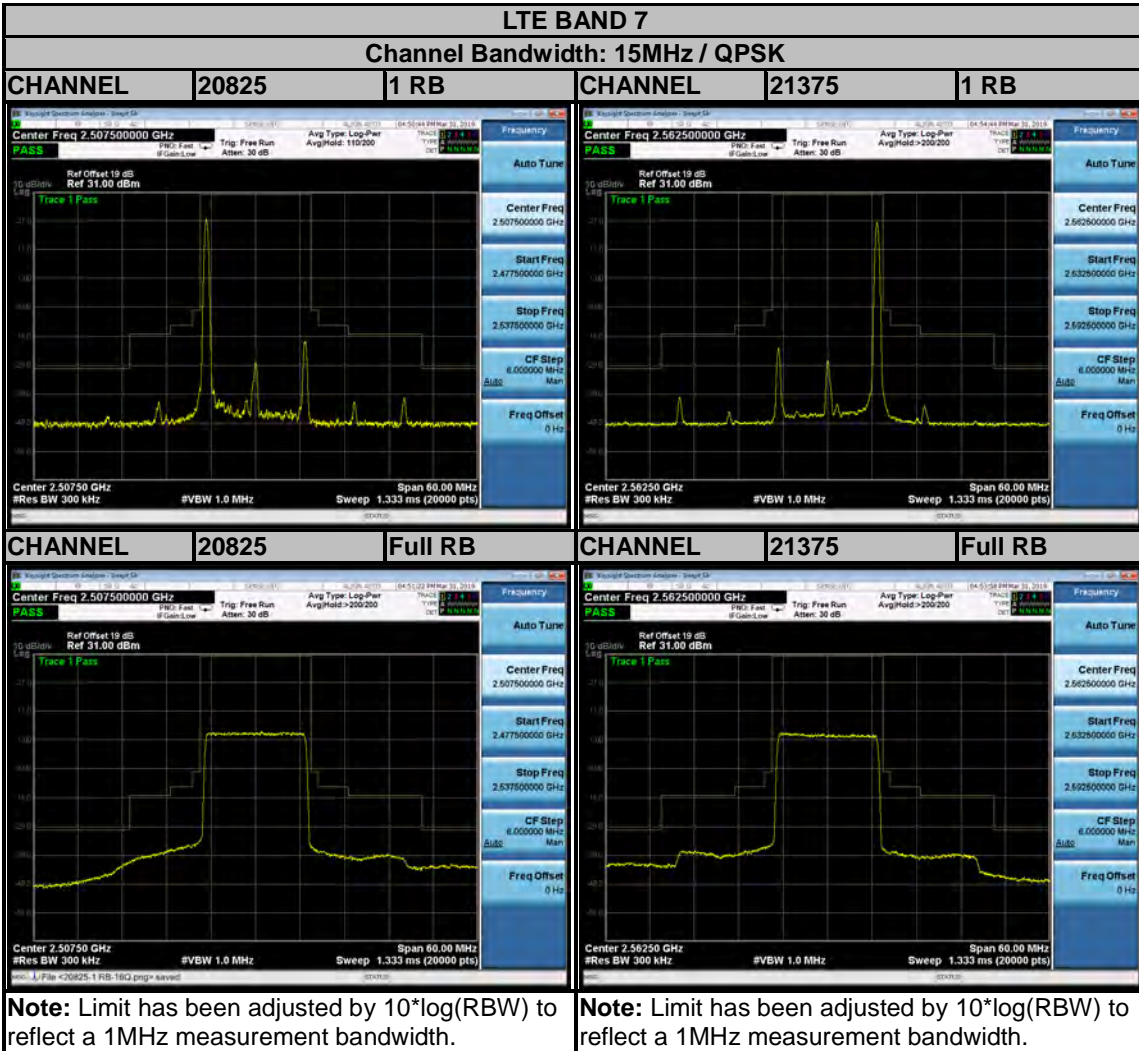



Test Report No.: RF190325W006-6

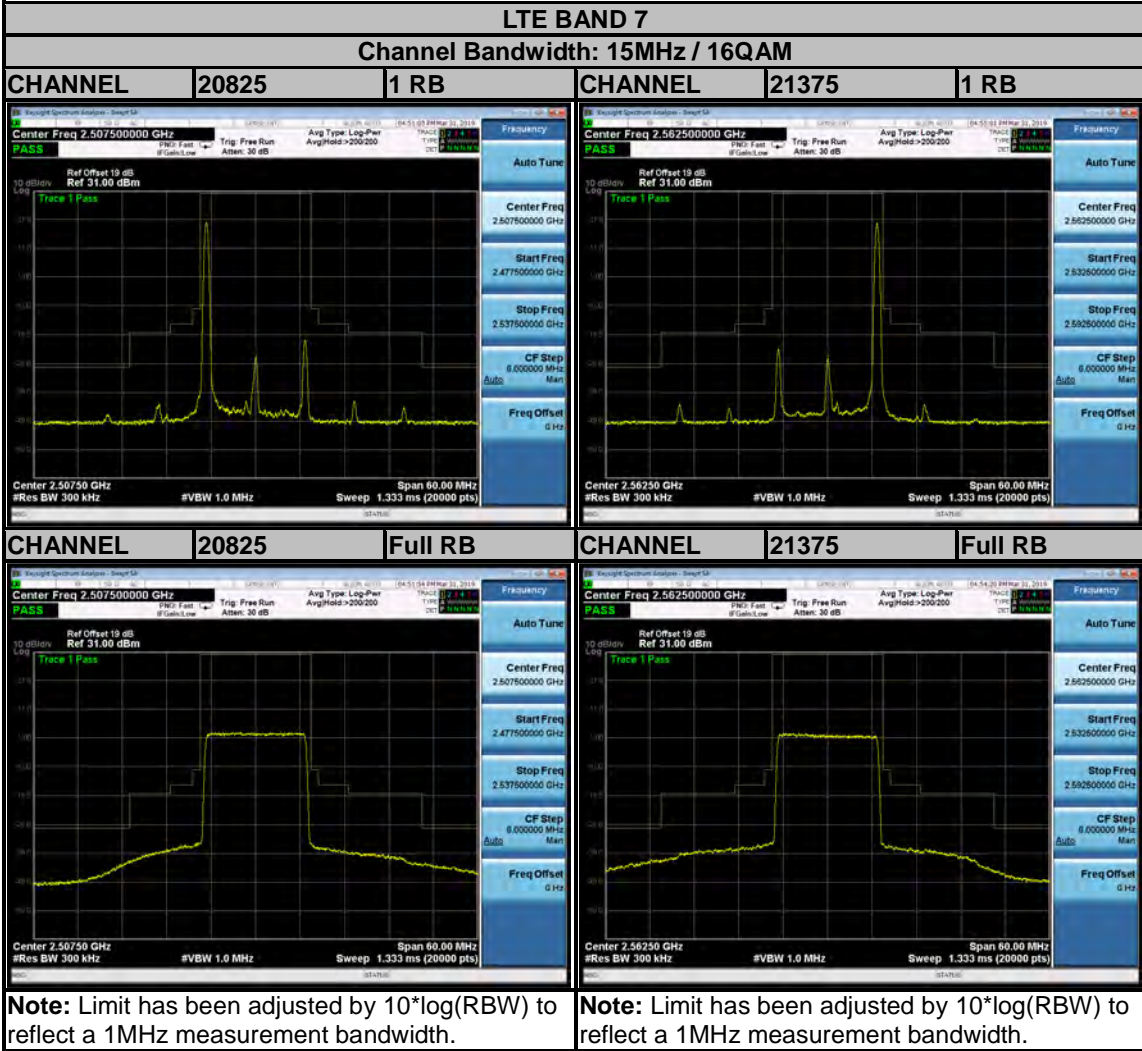



Test Report No.: RF190325W006-6

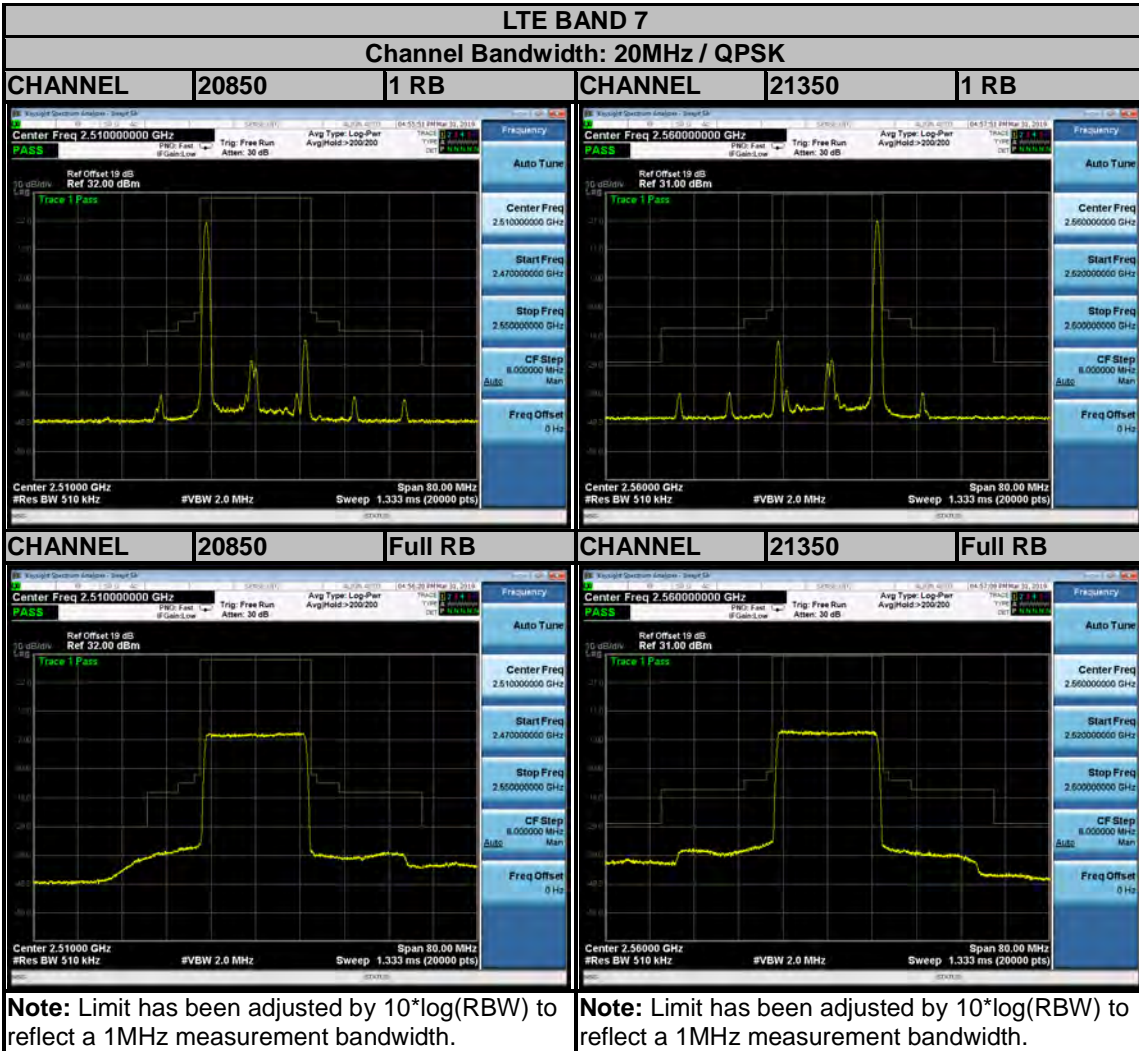



Test Report No.: RF190325W006-6



3.6 CONDUCTED SPURIOUS EMISSIONS

3.6.1 LIMITS OF CONDUCTED SPURIOUS EMISSIONS MEASUREMENT

The power of any emission outside a licensee's frequency block shall be attenuated below the transmitter power (P) by at least $55 + 10 \log_{10}(P)$ dB. The limit of emission is equal to -25dBm.

3.6.2 TEST PROCEDURE

- a. The EUT makes a phone call to the communication simulator. All measurements were done at low, middle and high operational frequency range.
- b. Measuring frequency range is from 30MHz to 26GHz for LTE Band 7. 10dB attenuation pad is connected with spectrum. RBW=1MHz and VBW=3MHz are used for conducted emission measurement.

3.6.3 TEST SETUP

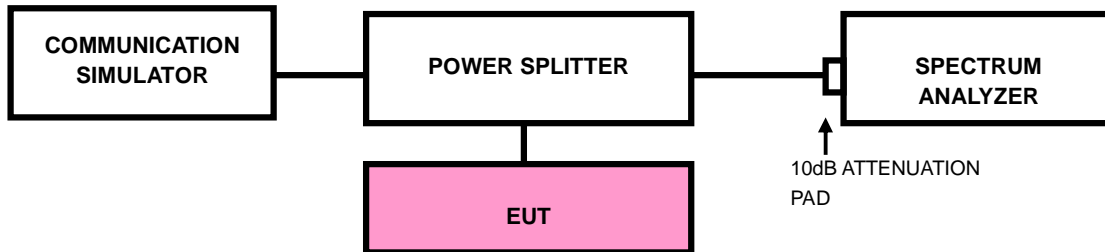



3.6.4 TEST RESULTS

LTE BAND 7

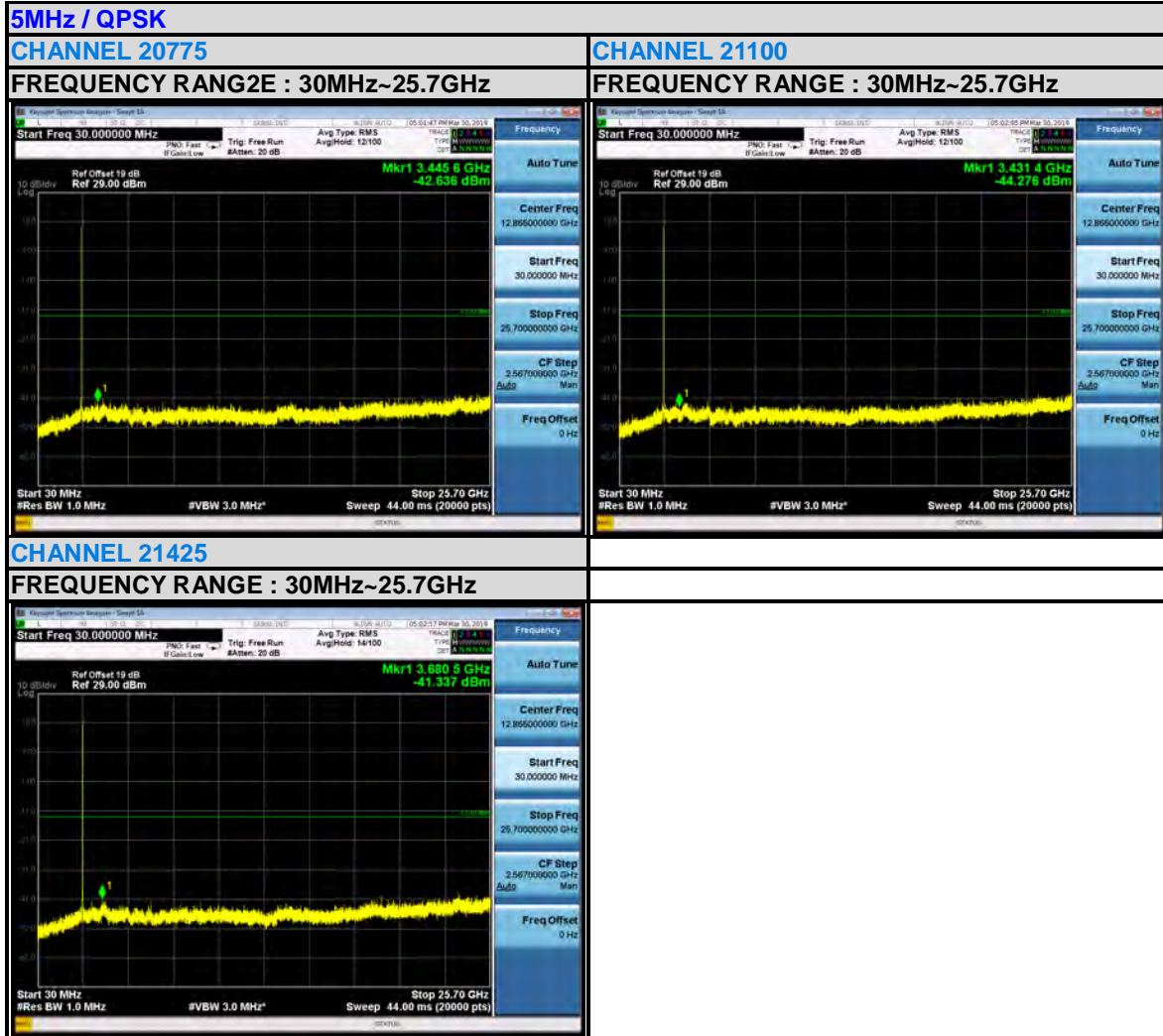



Test Report No.: RF190325W006-6

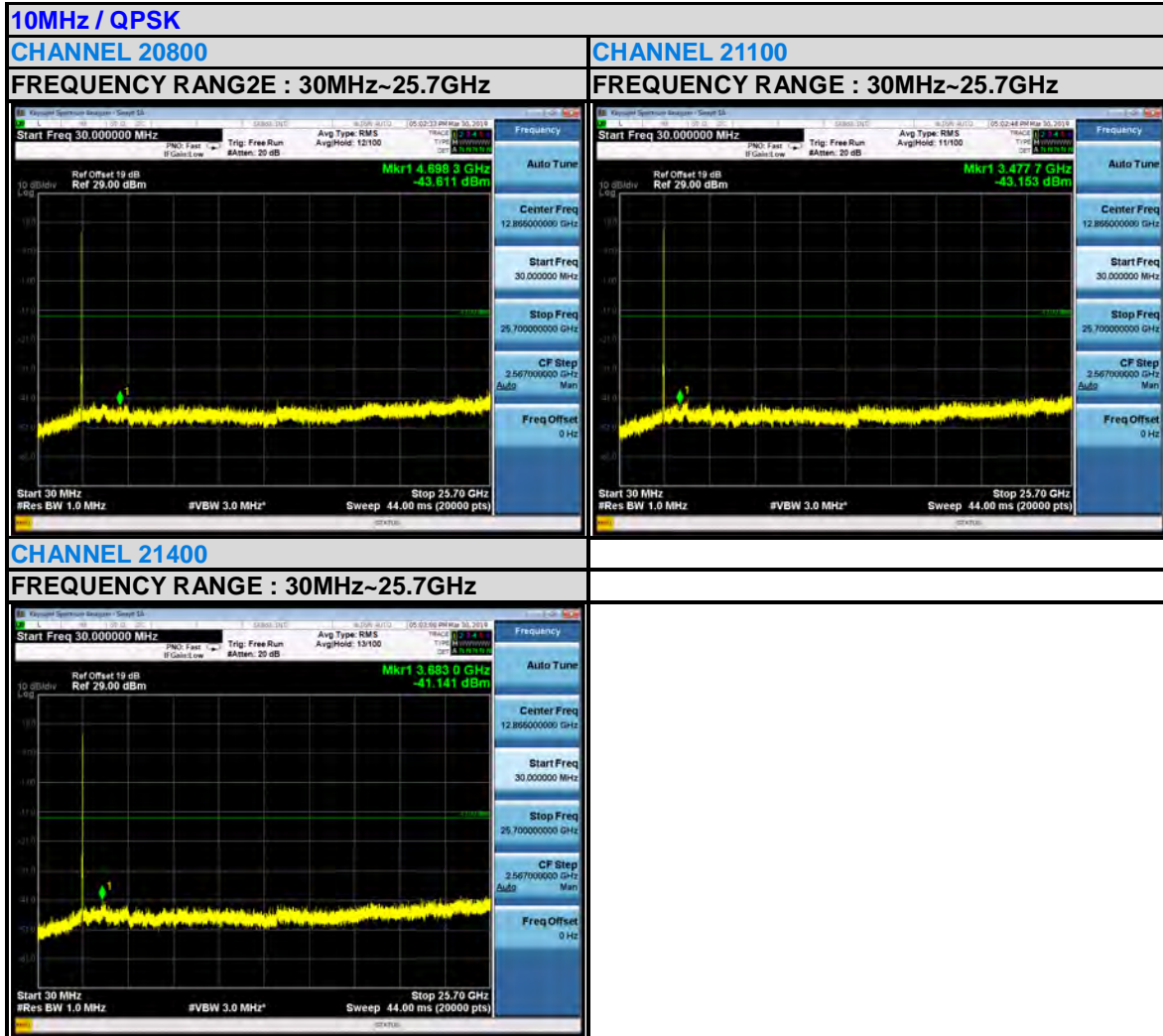



Test Report No.: RF190325W006-6

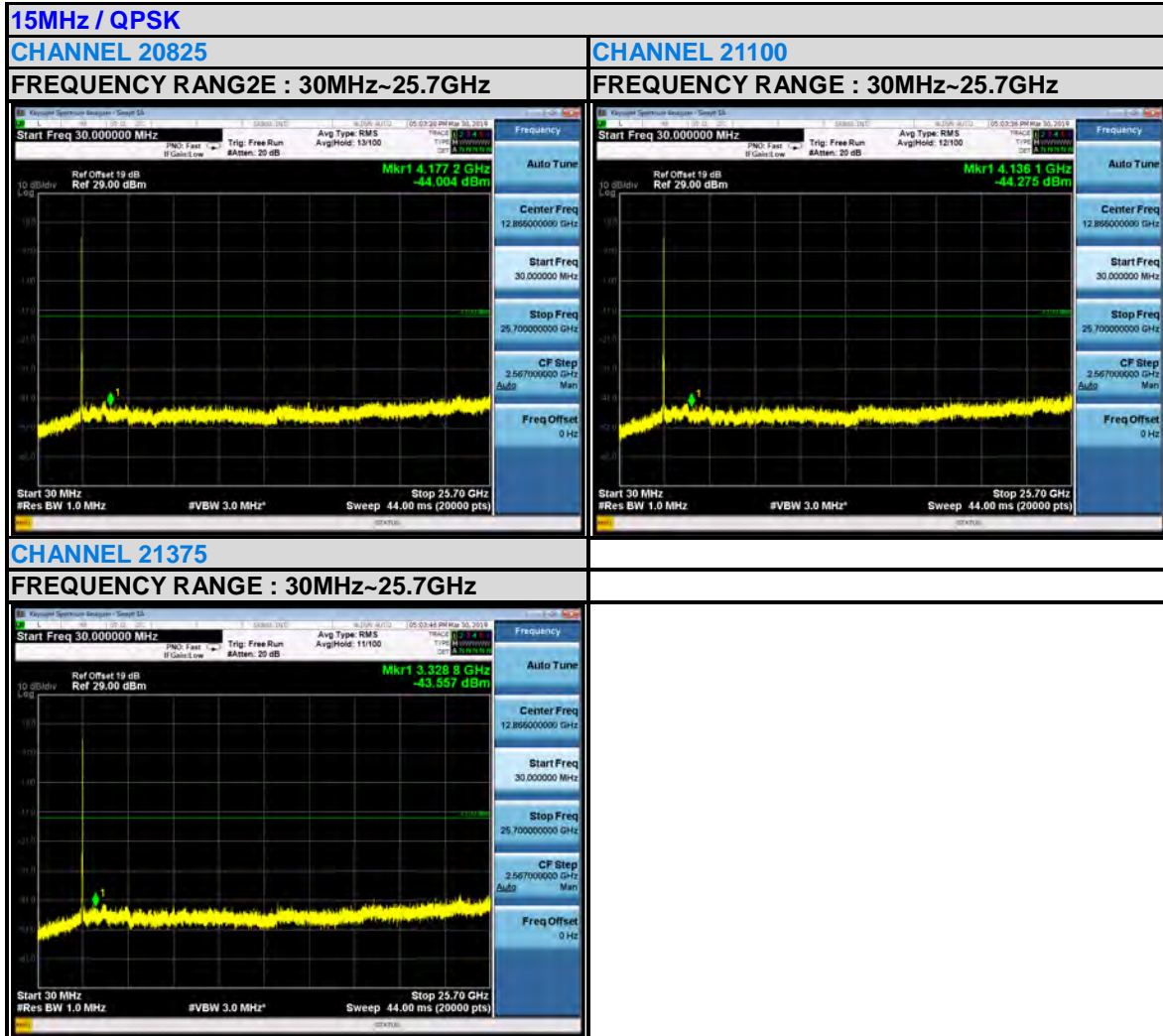



Test Report No.: RF190325W006-6

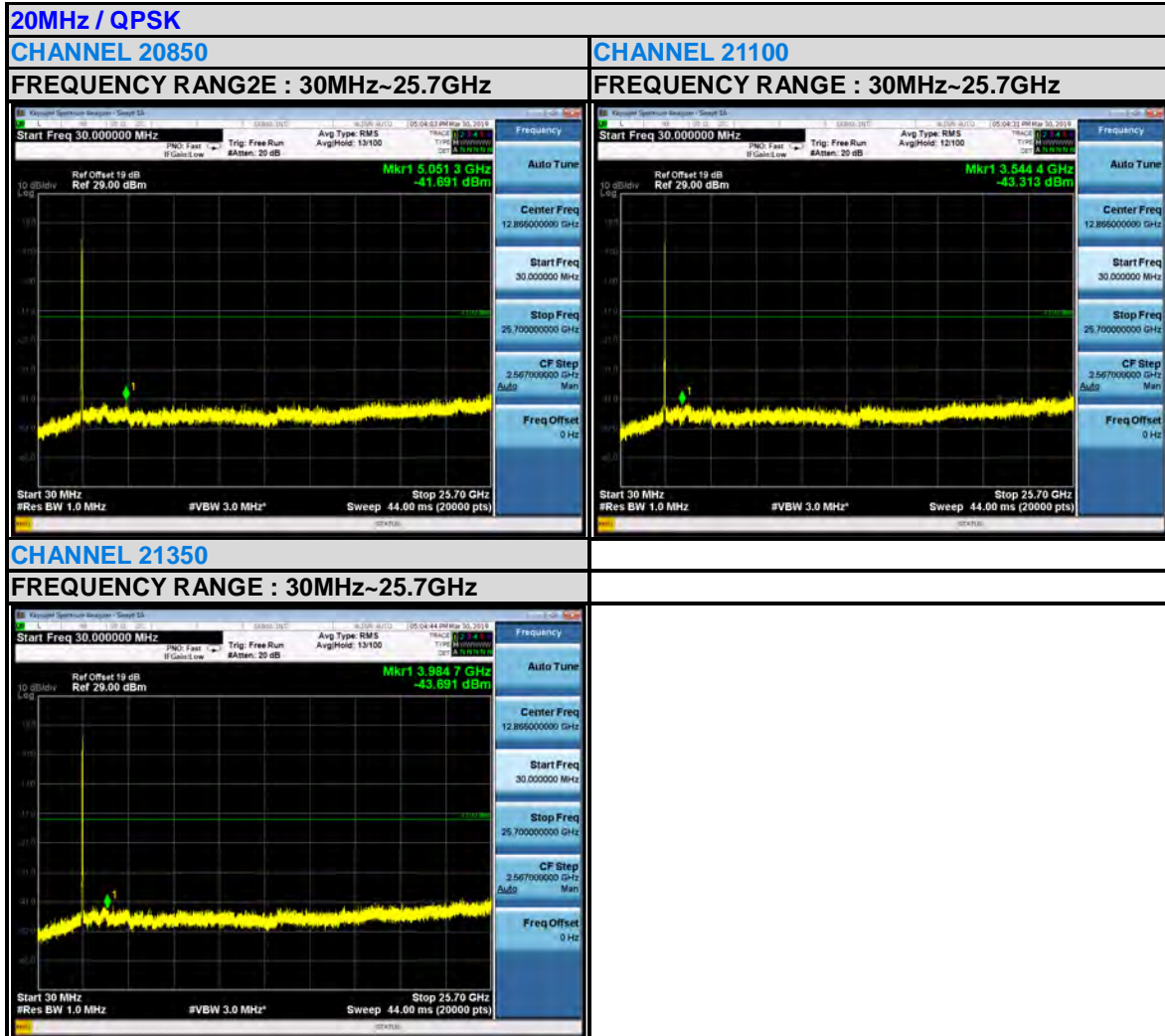



3.7 RADIATED EMISSION MEASUREMENT

3.7.1 LIMITS OF RADIATED EMISSION MEASUREMENT

The power of any emission outside a licensee's frequency block shall be attenuated below the transmitter power (P) by at least $55 + 10 \log_{10}(P)$ dB. The limit of emission is equal to -25dBm.

3.7.2 TEST PROCEDURES

- a. Substitution method is used for E.I.R.P measurement. In the semi-anechoic chamber, EUT placed on the 0.8m height of Turn Table, rotated the table around 360 degrees to search the maximum radiation power and receiver antenna shall be rotated vertical and horizontal polarization and moved height from 1m to 4m to find the maximum polar radiated power. The "Read Value" is the spectrum reading the maximum power value.
- b. The substitution horn antenna is substituted for EUT at the same position and signals generator export the CW signal to the substitution antenna via a TX cable. Rotated the Turn Table and moved receiving antenna to find the maximum radiation power. Adjust output power level of S.G to get a Value of spectrum reading equal to "Read Value " of step a. Record the power level of S.G.
- c. $EIRP = \text{Output power level of S.G} - \text{TX cable loss} + \text{Antenna gain of substitution horn}$.
- d. E.R.P power can be calculated form E.I.R.P power by subtracting the gain of dipole, $E.R.P \text{ power} = E.I.P.R \text{ power} - 2.15\text{dBi}$.

NOTE: The resolution bandwidth of spectrum analyzer is 1 MHz and the video bandwidth is 3 MHz.

3.7.3 DEVIATION FROM TEST STANDARD

No deviation

3.7.4 TEST SETUP

<Below 30MHz>

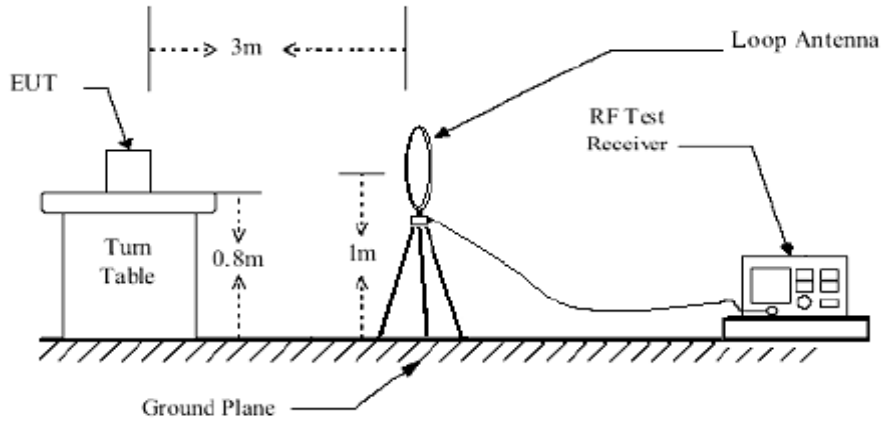

< Frequency Range 30MHz~1GHz >

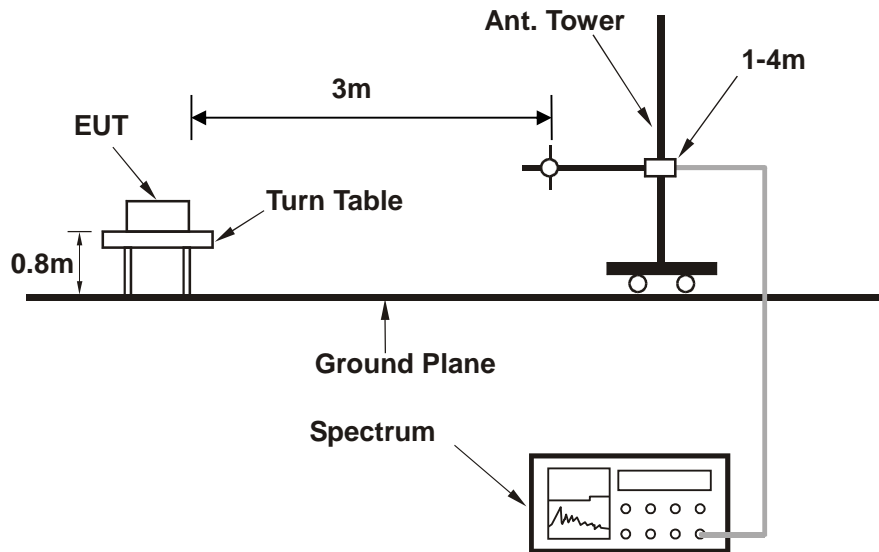

< Frequency Range above 1GHz >

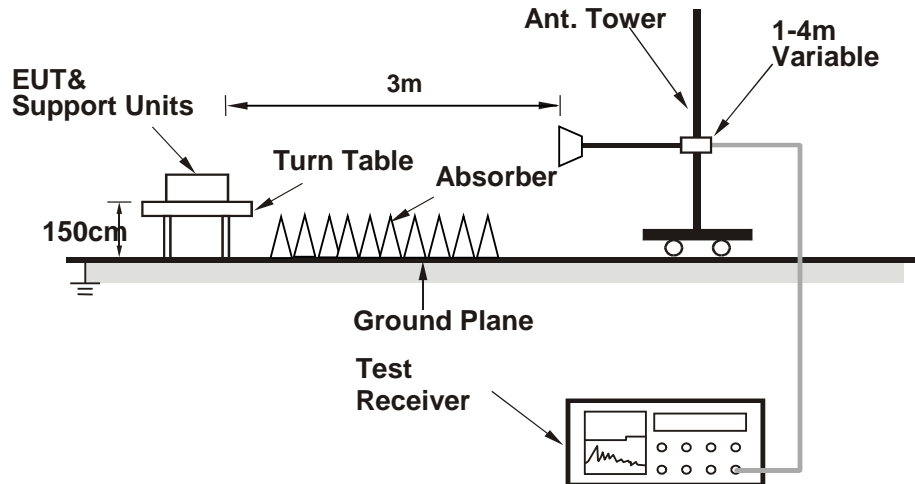

For the actual test configuration, please refer to the attached file (Test Setup Photo).



BUREAU VERITAS

Test Report No.: RF190325W006-6

3.7.5 TEST RESULTS

BELOW 1GHz WORST-CASE DATA

9 KHz – 30 MHz data: the amplitude of spurious emissions attenuated more than 20 dB below the permissible value is not required in the report.

30 MHz – 1GHz data:

LTE Band 7:

CHANNEL BANDWIDTH: 10MHz / QPSK

MODE	TX channel 21100	FREQUENCY RANGE	Below 1000MHz
ENVIRONMENTAL CONDITIONS	23deg. C, 70%RH	INPUT POWER	DC 5V from adapter
TESTED BY	Rose Ma		
ANTENNA POLARITY & TEST DISTANCE: HORIZONTAL AT 3 M			

	Freq	Level	Read Level	Limit Line	Over Limit	Factor	Remark	Pol/Phase
	MHz	dBm/m	dBm	dBm/m	dB	dB/m		
1	PP	45.120	-32.72	-40.31	-25.00	-7.72	7.59 Peak	Horizontal
2		135.640	-53.61	-35.66	-25.00	-28.61	-17.95 Peak	Horizontal
3		167.890	-58.77	-40.58	-25.00	-33.77	-18.19 Peak	Horizontal
4		225.160	-51.90	-35.15	-25.00	-26.90	-16.75 Peak	Horizontal
5		312.050	-56.15	-42.75	-25.00	-31.15	-13.40 Peak	Horizontal
6		412.510	-55.70	-45.25	-25.00	-30.70	-10.45 Peak	Horizontal

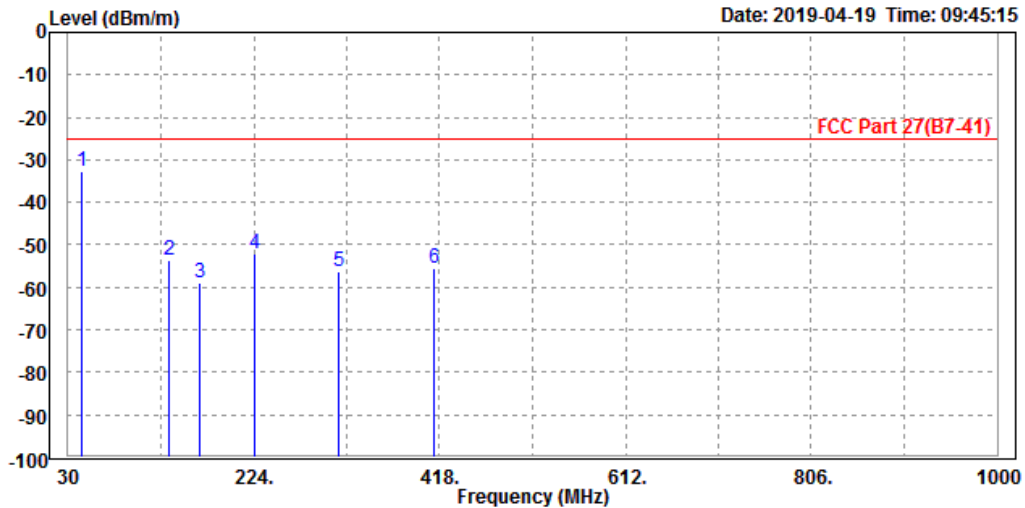



Test Report No.: RF190325W006-6

MODE	TX channel 21100	FREQUENCY RANGE	Below 1000MHz
ENVIRONMENTAL CONDITIONS	23deg. C, 70%RH	INPUT POWER	DC 5V from adapter
TESTED BY	Rose Ma		
ANTENNA POLARITY & TEST DISTANCE: VERTICAL AT 3 M			

	Freq	Level	Read Level	Limit Line	Over Limit	Factor	Remark	Pol/Phase
	MHz	dBm/m	dBm	dBm/m	dB	dB/m		
1	PP	60.350	-51.73	-39.24	-25.00	-26.73	-12.49 Peak	Vertical
2		108.450	-53.24	-41.45	-25.00	-28.24	-11.79 Peak	Vertical
3		146.180	-61.13	-45.16	-25.00	-36.13	-15.97 Peak	Vertical
4		255.180	-52.76	-41.26	-25.00	-27.76	-11.50 Peak	Vertical
5		289.850	-55.23	-43.89	-25.00	-30.23	-11.34 Peak	Vertical
6		330.180	-53.64	-42.45	-25.00	-28.64	-11.19 Peak	Vertical

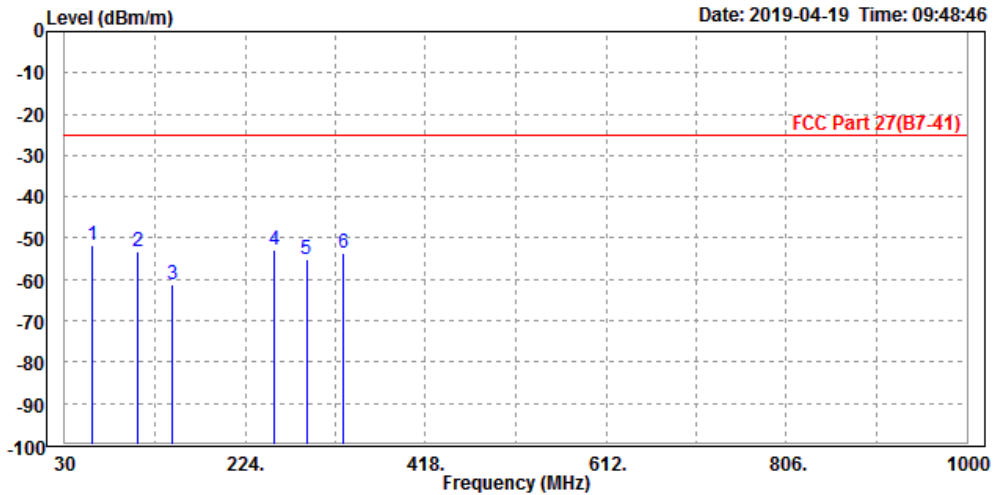



Test Report No.: RF190325W006-6

ABOVE 1GHz

Note: For higher frequency, the emission is too low to be detected.

LTE Band 7

CHANNEL BANDWIDTH: 5MHz / QPSK

MODE	TX channel 21100	FREQUENCY RANGE	Above 1000MHz
ENVIRONMENTAL CONDITIONS	23deg. C, 70%RH	INPUT POWER	DC 5V from adapter
TESTED BY	Rose Ma		
ANTENNA POLARITY & TEST DISTANCE: HORIZONTAL AT 3 M			

	Freq	Level	Read Level	Limit	Over Limit	Factor	Remark	Pol/Phase
	MHz	dBm/m	dBm	dBm/m	dB	dB/m		
1	PP 5070.000	-49.66	-58.12	-25.00	-24.66	8.46	Peak	Horizontal
2	7605.000	-54.29	-67.77	-25.00	-29.29	13.48	Peak	Horizontal

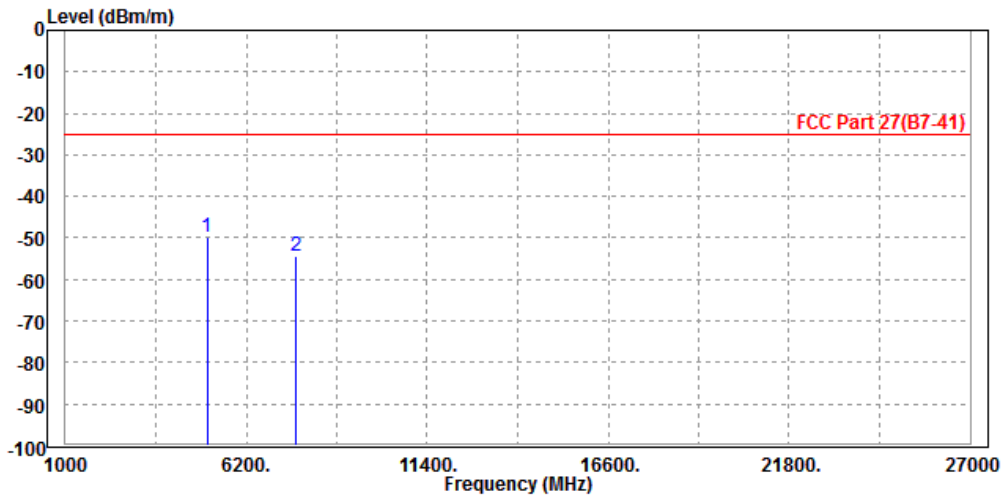



Test Report No.: RF190325W006-6

MODE	TX channel 21100	FREQUENCY RANGE	Above 1000MHz
ENVIRONMENTAL CONDITIONS	23deg. C, 70%RH	INPUT POWER	DC 5V from adapter
TESTED BY	Rose Ma		
ANTENNA POLARITY & TEST DISTANCE: VERTICAL AT 3 M			

	Freq	Level	Read Level	Limit Line	Over Limit	Factor	Remark	Pol/Phase
	MHz	dBm/m	dBm	dBm/m	dB	dB/m		
1	5070.000	-59.83	-67.82	-25.00	-34.83	7.99	Peak	Vertical
2	PP 7605.000	-45.95	-58.94	-25.00	-20.95	12.99	Peak	Vertical

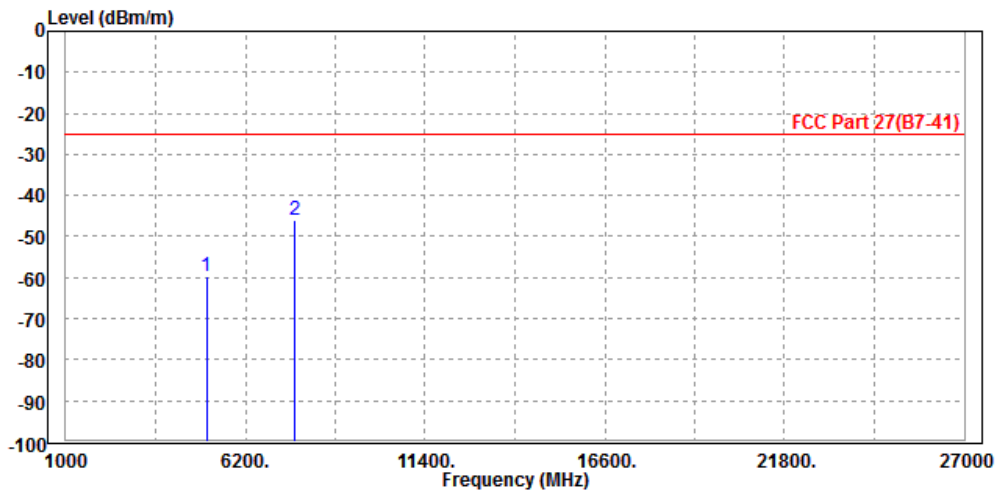



Test Report No.: RF190325W006-6

CHANNEL BANDWIDTH: 10MHz / QPSK

CH 20800

MODE	TX channel 20800	FREQUENCY RANGE	Above 1000MHz
ENVIRONMENTAL CONDITIONS	23deg. C, 70%RH	INPUT POWER	DC 5V from adapter
TESTED BY	Rose Ma		
ANTENNA POLARITY & TEST DISTANCE: HORIZONTAL AT 3 M			

	Freq	Level	Read Level	Limit Line	Over Limit	Factor	Remark	Pol/Phase
	MHz	dBm/m	dBm	dBm/m	dB	dB/m		
1	5010.000	-49.95	-58.34	-25.00	-24.95	8.39	Peak	Horizontal
2 PP	7515.000	-49.62	-62.97	-25.00	-24.62	13.35	Peak	Horizontal

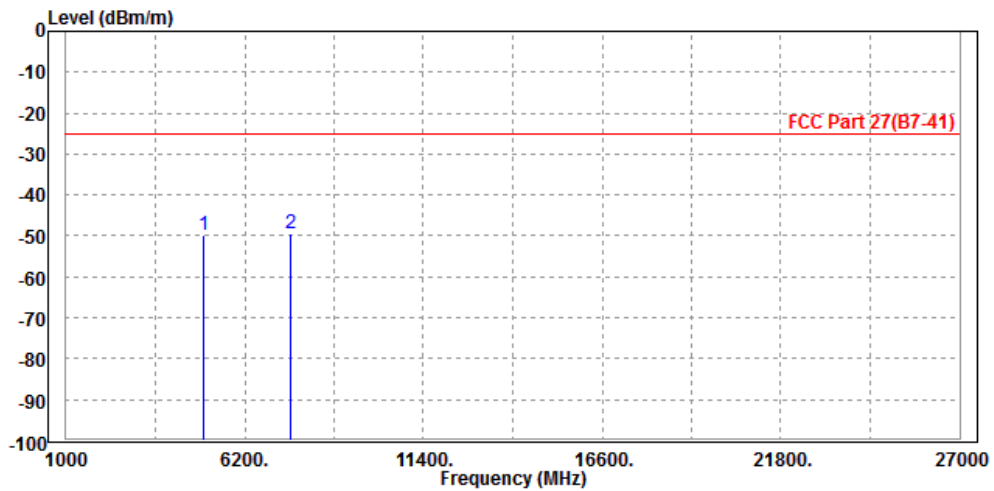



Test Report No.: RF190325W006-6

MODE	TX channel 20800	FREQUENCY RANGE	Above 1000MHz
ENVIRONMENTAL CONDITIONS	23deg. C, 70%RH	INPUT POWER	DC 5V from adapter
TESTED BY	Rose Ma		
ANTENNA POLARITY & TEST DISTANCE: VERTICAL AT 3 M			

	Freq	Level	Read Level	Limit Line	Over Limit	Factor	Remark	Pol/Phase
	MHz	dBm/m	dBm	dBm/m	dB	dB/m		
1	PP 5010.000	-49.64	-57.63	-25.00	-24.64	7.99	Peak	Vertical
2	7515.000	-51.76	-64.59	-25.00	-26.76	12.83	Peak	Vertical

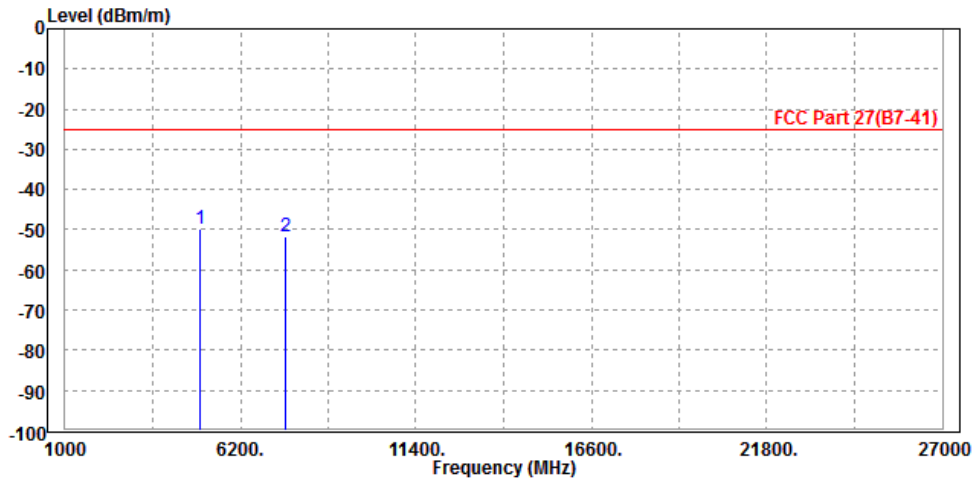



Test Report No.: RF190325W006-6

CH 21100

MODE	TX channel 21100	FREQUENCY RANGE	Above 1000MHz
ENVIRONMENTAL CONDITIONS	23deg. C, 70%RH	INPUT POWER	DC 5V from adapter
TESTED BY	Rose Ma		
ANTENNA POLARITY & TEST DISTANCE: HORIZONTAL AT 3 M			

	Freq	Level	Read Level	Limit Line	Over Limit	Factor	Remark	Pol/Phase
	MHz	dBm/m	dBm	dBm/m	dB	dB/m		
1	PP 5070.000	-49.42	-57.88	-25.00	-24.42	8.46	Peak	Horizontal
2	7605.000	-49.76	-63.24	-25.00	-24.76	13.48	Peak	Horizontal

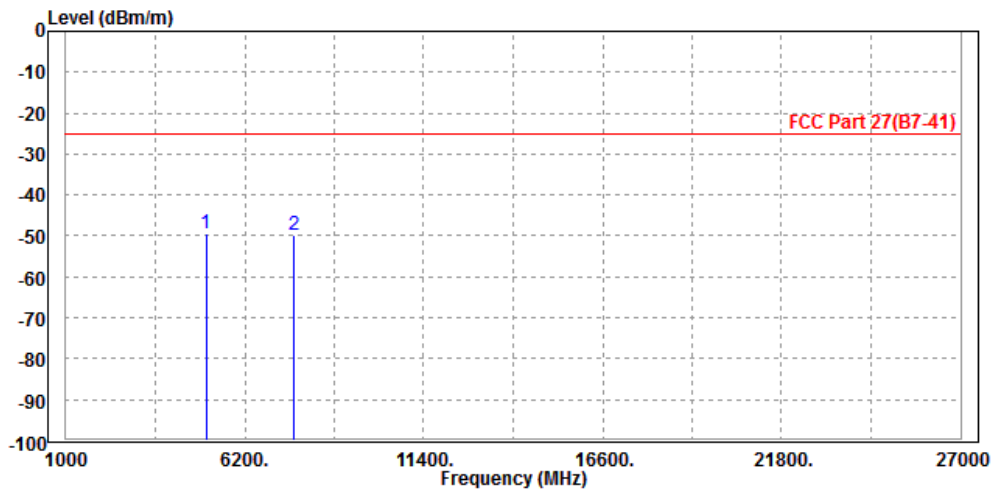



Test Report No.: RF190325W006-6

MODE	TX channel 21100	FREQUENCY RANGE	Above 1000MHz
ENVIRONMENTAL CONDITIONS	23deg. C, 70%RH	INPUT POWER	DC 5V from adapter
TESTED BY	Rose Ma		
ANTENNA POLARITY & TEST DISTANCE: VERTICAL AT 3 M			

	Freq	Level	Read Level	Limit Line	Over Limit	Factor	Remark	Pol/Phase
	MHz	dBm/m	dBm	dBm/m	dB	dB/m		
1	PP 5070.000	-45.27	-53.26	-25.00	-20.27	7.99	Peak	Vertical
2	7605.000	-54.86	-67.85	-25.00	-29.86	12.99	Peak	Vertical

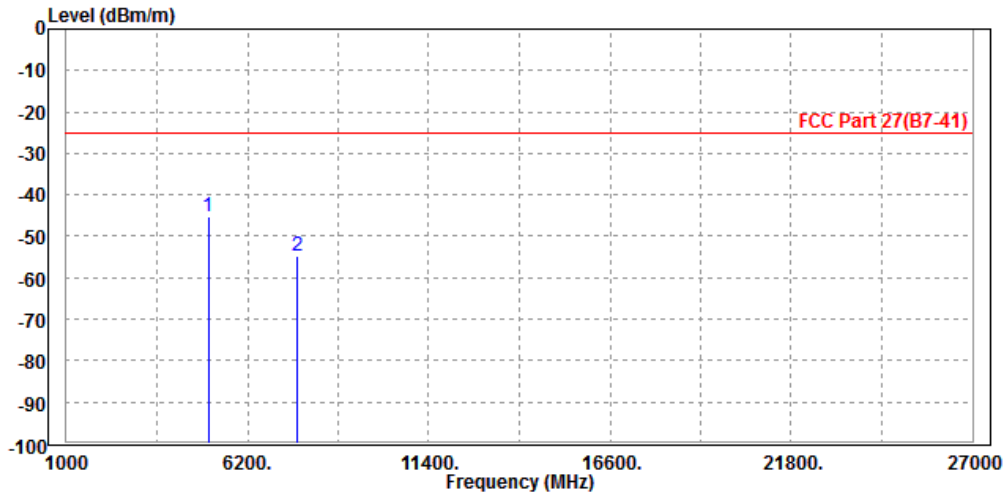



Test Report No.: RF190325W006-6

CH 21400

MODE	TX channel 21400	FREQUENCY RANGE	Above 1000MHz
ENVIRONMENTAL CONDITIONS	23deg. C, 70%RH	INPUT POWER	DC 5V from adapter
TESTED BY	Rose Ma		
ANTENNA POLARITY & TEST DISTANCE: HORIZONTAL AT 3 M			

	Freq	Level	Read Level	Limit Line	Over Limit	Factor	Remark	Pol/Phase
	MHz	dBm/m	dBm	dBm/m	dB	dB/m		
1	PP 5130.000	-50.79	-59.32	-25.00	-25.79	8.53	Peak	Horizontal
2	7695.000	-56.26	-69.87	-25.00	-31.26	13.61	Peak	Horizontal

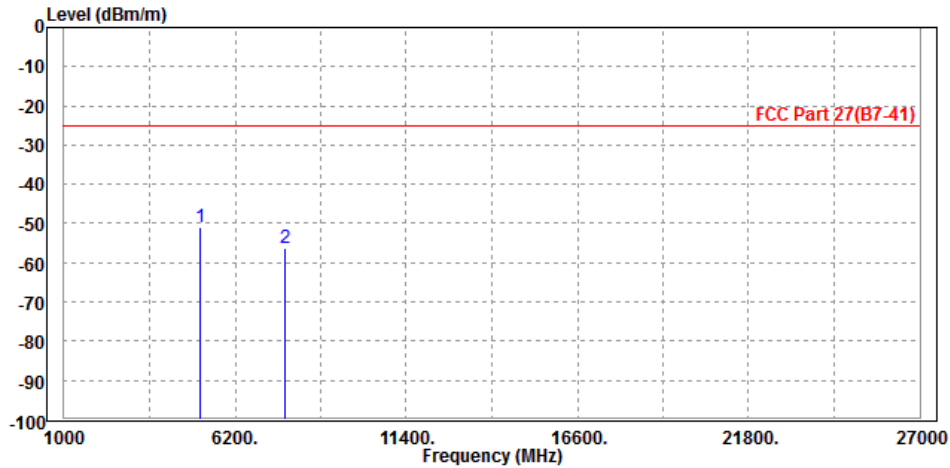



Test Report No.: RF190325W006-6

MODE	TX channel 21400	FREQUENCY RANGE	Above 1000MHz
ENVIRONMENTAL CONDITIONS	23deg. C, 70%RH	INPUT POWER	DC 5V from adapter
TESTED BY	Rose Ma		
ANTENNA POLARITY & TEST DISTANCE: VERTICAL AT 3 M			

	Freq	Level	Read Level	Limit Line	Over Limit	Factor	Remark	Pol/Phase
	MHz	dBm/m	dBm	dBm/m	dB	dB/m		
1	PP 5130.000	-50.44	-58.43	-25.00	-25.44	7.99	Peak	Vertical
2	7695.000	-53.06	-66.21	-25.00	-28.06	13.15	Peak	Vertical

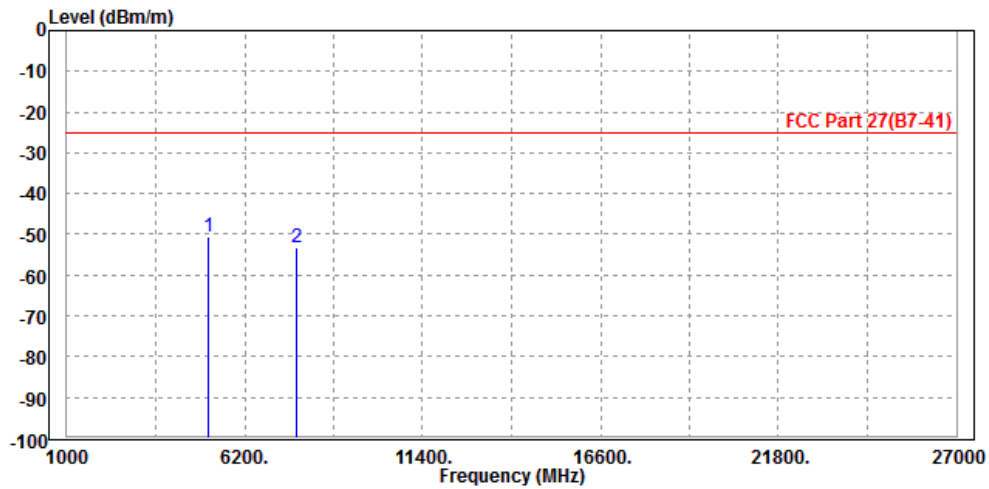



Test Report No.: RF190325W006-6

CHANNEL BANDWIDTH: 15MHz / QPSK

MODE	TX channel 21100	FREQUENCY RANGE	Above 1000MHz
ENVIRONMENTAL CONDITIONS	23deg. C, 70%RH	INPUT POWER	DC 5V from adapter
TESTED BY	Rose Ma		
ANTENNA POLARITY & TEST DISTANCE: HORIZONTAL AT 3 M			

	Freq	Level	Read Level	Limit Line	Over Limit	Factor	Remark	Pol/Phase
	MHz	dBm/m	dBm	dBm/m	dB	dB/m		
1	5070.000	-56.81	-65.27	-25.00	-31.81	8.46	Peak	Horizontal
2 PP	7605.000	-46.77	-60.25	-25.00	-21.77	13.48	Peak	Horizontal

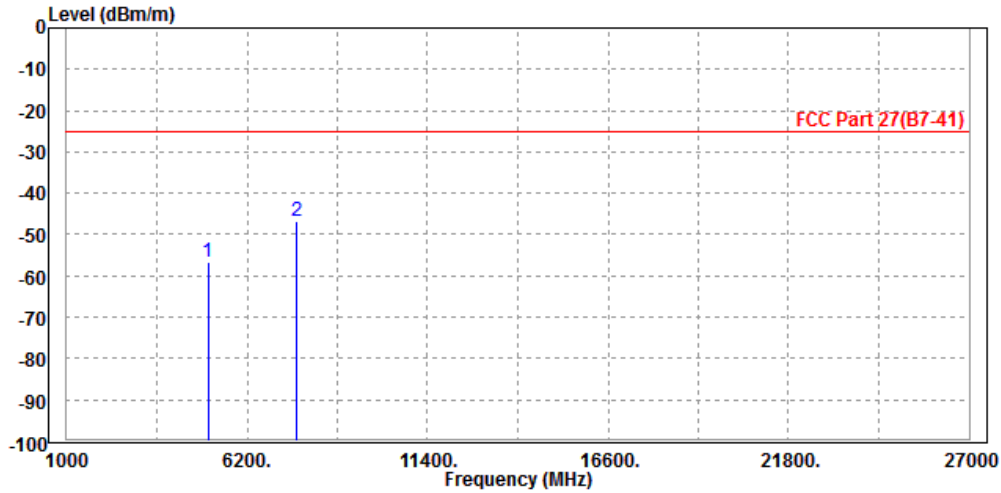



Test Report No.: RF190325W006-6

MODE	TX channel 21100	FREQUENCY RANGE	Above 1000MHz
ENVIRONMENTAL CONDITIONS	23deg. C, 70%RH	INPUT POWER	DC 5V from adapter
TESTED BY	Rose Ma		
ANTENNA POLARITY & TEST DISTANCE: VERTICAL AT 3 M			

	Freq	Level	Read Level	Limit Line	Over Limit	Factor	Remark	Pol/Phase
	MHz	dBm/m	dBm	dBm/m	dB	dB/m		
1	5070.000	-49.68	-57.67	-25.00	-24.68	7.99	Peak	Vertical
2	7605.000	-52.94	-65.93	-25.00	-27.94	12.99	Peak	Vertical

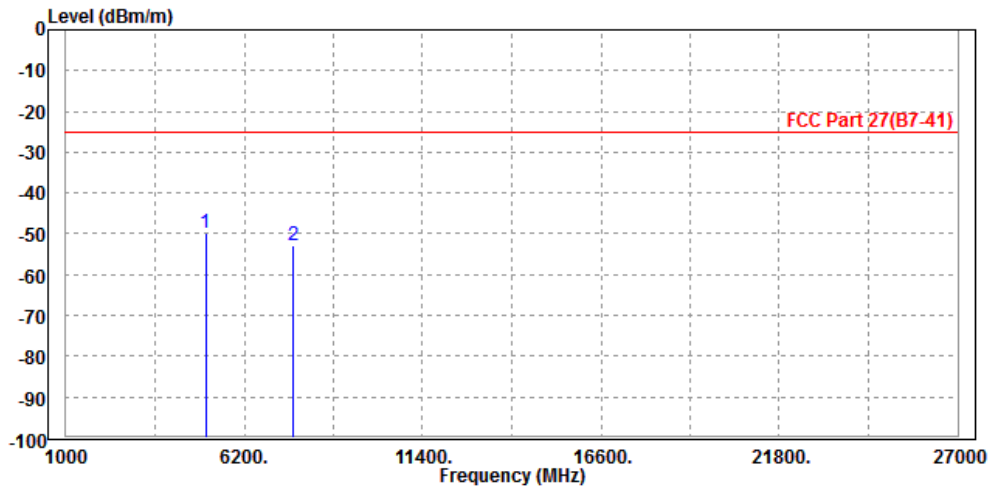



Test Report No.: RF190325W006-6

CHANNEL BANDWIDTH: 20MHz / QPSK

MODE	TX channel 21100	FREQUENCY RANGE	Above 1000MHz
ENVIRONMENTAL CONDITIONS	23deg. C, 70%RH	INPUT POWER	DC 5V from adapter
TESTED BY	Rose Ma		
ANTENNA POLARITY & TEST DISTANCE: HORIZONTAL AT 3 M			

	Freq	Level	Read Level	Limit Line	Over Limit	Factor	Remark	Pol/Phase
	MHz	dBm/m	dBm	dBm/m	dB	dB/m		
1	PP 5070.000	-50.81	-59.27	-25.00	-25.81	8.46	Peak	Horizontal
2	7605.000	-55.87	-69.35	-25.00	-30.87	13.48	Peak	Horizontal

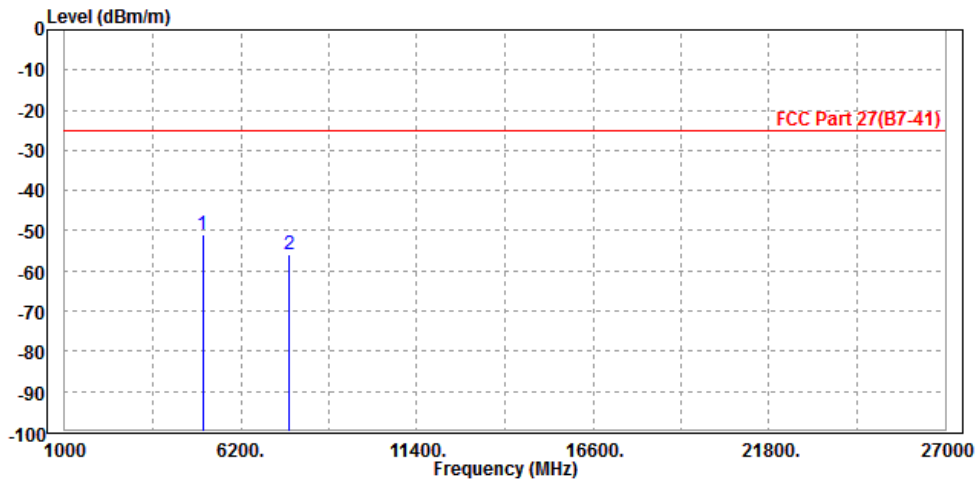



Test Report No.: RF190325W006-6

MODE	TX channel 21100	FREQUENCY RANGE	Above 1000MHz
ENVIRONMENTAL CONDITIONS	23deg. C, 70%RH	INPUT POWER	DC 5V from adapter
TESTED BY	Rose Ma		
ANTENNA POLARITY & TEST DISTANCE: VERTICAL AT 3 M			

	Freq	Level	Read Level	Limit Line	Over Limit	Factor	Remark	Pol/Phase
	MHz	dBm/m	dBm	dBm/m	dB	dB/m		
1	PP 5070.000	-48.33	-56.32	-25.00	-23.33	7.99	Peak	Vertical
2	7605.000	-52.38	-65.37	-25.00	-27.38	12.99	Peak	Vertical

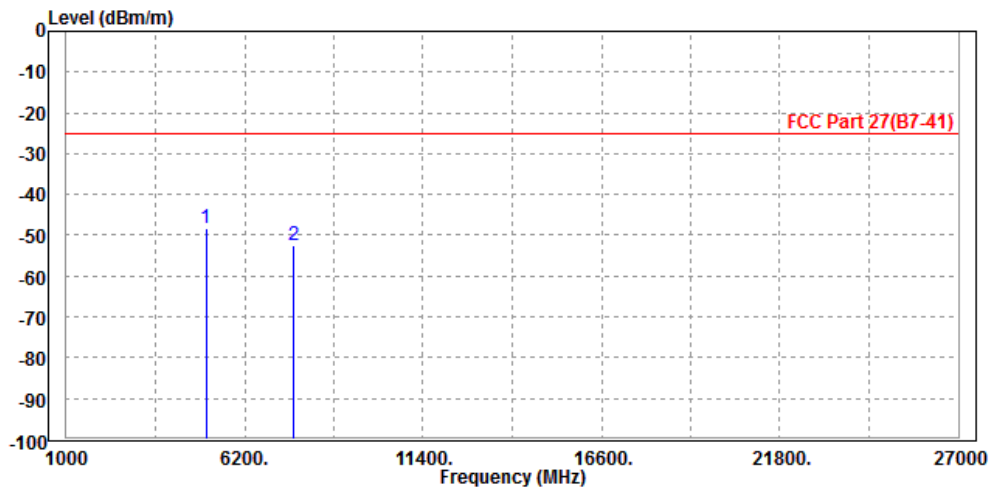



Test Report No.: RF190325W006-6

4 INFORMATION ON THE TESTING LABORATORIES

We, BV 7LAYERS COMMUNICATIONS TECHNOLOGY (SHENZHEN) CO. LTD., were founded in 2015 to provide our best service in EMC, Radio, Telecom and Safety consultation. Our laboratories are accredited and approved according to ISO/IEC 17025.

If you have any comments, please feel free to contact us at the following:

Shenzhen EMC/RF Lab:

Tel: +86-755-88696566

Fax: +86-755-88696577

Email: customerservice.dg@cn.bureauveritas.com

Web Site: www.adt.com.tw

The address and road map of all our labs can be found in our web site also.



Test Report No.: RF190325W006-6

5 APPENDIX A – MODIFICATIONS RECORDERS FOR ENGINEERING CHANGES TO THE EUT BY THE LAB

No any modifications are made to the EUT by the lab during the test.

---END---