



# FCC RADIO TEST REPORT

## FCC ID: ZBXMT-WN713NM

**Product :** 150M WIRELESS USB MODULE

**Trade Name :** N/A

**Model Name :** MT-WN713NM

**Serial Model :** N/A

**Report No. :** NTEK-2012NT0702319F

### Prepared for

SHENZHEN MTN ELECTRONICS CO.,LTD.

MTN Industrial Park, No.3 Fuhua Road ,Pingxi Neighborhood, Pingdi Town  
Longgang Distric,Shenzhen, Guangdong, China

### Prepared by

NTEK Testing Technology Co., Ltd.

1/F, Building E, Fenda Science Park, Sanwei Community,Xixiang Street  
Bao'an District, Shenzhen P.R. China

Tel.: +86-0755-61156588 Fax.: +86-0755-61156599

Website:www.ntek.org.cn

## TEST RESULT CERTIFICATION

**Applicant's name** ..... : SHENZHEN MTN ELECTRONICS CO.,LTD.  
**Address** ..... : MTN Industrial Park, No.3 Fuhua Road ,Pingxi Neighborhood,  
Pingdi Town, Longgang Distric, Shenzhen, Guangdong, China  
**Manufacture's Name**..... : SHENZHEN MTN ELECTRONICS CO.,LTD.  
**Address** ..... : MTN Industrial Park, No.3 Fuhua Road ,Pingxi Neighborhood,  
Pingdi Town, Longgang Distric, Shenzhen, Guangdong, China

### Product description

**Product name** ..... : 150M WIRELESS USB MODULE  
**Model and/or type reference** : MT-WN713NM  
**Serial Model** : N/A

**Standards** ..... : FCC Part15.247

**Test procedure** ..... ANSI C63.4-2003

This device described above has been tested by NTEK, and the test results show that the equipment under test (EUT) is in compliance with the FCC requirements. And it is applicable only to the tested sample identified in the report.

This report shall not be reproduced except in full, without the written approval of NTEK, this document may be altered or revised by NTEK, personal only, and shall be noted in the revision of the document.

**Date of Test** ..... :

**Date (s) of performance of tests** ..... : 06 July. 2012 ~13 July. 2012

**Date of Issue**..... : 13 July. 2012

**Test Result**..... : **Pass**

**Testing Engineer** : Apple Huang  
(Apple Huang)

**Technical Manager** : Tom Zhang  
(Tom Zhang)

**Authorized Signatory** : Bovey Yang  
(Bovey Yang)

**Table of Contents**

	<b>Page</b>
<b>1 . SUMMARY OF TEST RESULTS</b>	<b>5</b>
1.1 TEST FACILITY	6
1.2 MEASUREMENT UNCERTAINTY	6
<b>2 . GENERAL INFORMATION</b>	<b>7</b>
2.1 GENERAL DESCRIPTION OF EUT	7
2.2 DESCRIPTION OF TEST MODES	9
2.3 BLOCK DIGRAM SHOWING THE CONFIGURATION OF SYSTEM TESTED	10
2.4 DESCRIPTION OF SUPPORT UNITS(CONDUCTED MODE)	11
2.5 EQUIPMENTS LIST FOR ALL TEST ITEMS	12
<b>3 . EMC EMISSION TEST</b>	<b>13</b>
3.1 CONDUCTED EMISSION MEASUREMENT	13
3.1.1 POWER LINE CONDUCTED EMISSION LIMITS	13
3.1.2 TEST PROCEDURE	14
3.1.3 DEVIATION FROM TEST STANDARD	14
3.1.4 TEST SETUP	14
3.1.5 EUT OPERATING CONDITIONS	14
3.1.6 TEST RESULTS	15
3.2 RADIATED EMISSION MEASUREMENT	17
3.2.1 RADIATED EMISSION LIMITS	17
3.2.2 TEST PROCEDURE	18
3.2.3 DEVIATION FROM TEST STANDARD	18
3.2.4 TEST SETUP	19
3.2.5 EUT OPERATING CONDITIONS	20
3.2.6 TEST RESULTS (BETWEEN 9KHZ – 30 MHZ)	21
3.2.7 TEST RESULTS (BETWEEN 30MHZ – 1GHZ)	22
3.2.8 TEST RESULTS (ABOVE 1000 MHZ)	24
<b>4 . POWER SPECTRAL DENSITY TEST</b>	<b>54</b>
4.1 APPLIED PROCEDURES / LIMIT	54
4.1.1 TEST PROCEDURE	54
4.1.2 DEVIATION FROM STANDARD	54
4.1.3 TEST SETUP	54
4.1.4 EUT OPERATION CONDITIONS	54
4.1.5 TEST RESULTS	55
<b>5 . BANDWIDTH TEST</b>	<b>61</b>
5.1 APPLIED PROCEDURES / LIMIT	61
5.1.1 TEST PROCEDURE	61

**Table of Contents**

	<b>Page</b>
5.1.2 DEVIATION FROM STANDARD	61
5.1.3 TEST SETUP	61
5.1.4 EUT OPERATION CONDITIONS	61
5.1.5 TEST RESULTS	62
<b>6 . PEAK OUTPUT POWER TEST</b>	<b>68</b>
6.1 APPLIED PROCEDURES / LIMIT	68
6.1.1 TEST PROCEDURE	68
6.1.2 DEVIATION FROM STANDARD	68
6.1.3 TEST SETUP	68
6.1.4 EUT OPERATION CONDITIONS	68
6.1.5 TEST RESULTS	69
<b>7 . ANTENNA REQUIREMENT</b>	<b>70</b>
7.1 STANDARD REQUIREMENT	70
7.2 EUT ANTENNA	70
<b>8 . EUT TEST PHOTO</b>	<b>71</b>
<b>APPENDIX-PHOTOGRAPHS OF EUT CONSTRUCTIONAL DETAILS</b>	

### 1. SUMMARY OF TEST RESULTS

Test procedures according to the technical standards:

<b>FCC Part15 (15.247) , Subpart C</b>			
Standard Section	Test Item	Judgment	Remark
15.207	Conducted Emission	PASS	
15.247 (a)(2)	6dB Bandwidth	PASS	
15.247 (b)	Peak Output Power	PASS	
15.247 (c)	Radiated Spurious Emission	PASS	
15.247 (d)	Power Spectral Density	PASS	
15.205	Band Edge Emission	PASS	
15.203	Antenna Requirement	PASS	

**NOTE:**

(1) "N/A" denotes test is not applicable in this Test Report

**1.1 TEST FACILITY**

NTEK Testing Technology Co., Ltd  
 Add. : 1/F, Building E, Fenda Science Park, Sanwei Community, Xixiang Street, Bao'an District, Shenzhen P.R. China.  
 FCC Registration No.:238937; IC Registration No.:9270A-1  
 CNAS Registration No.:L5516

**1.2 MEASUREMENT UNCERTAINTY**

The reported uncertainty of measurement  $y \pm U$ , where expanded uncertainty  $U$  is based on a standard uncertainty multiplied by a coverage factor of  $k=2$ , providing a level of confidence of approximately 95 %.

No.	Item	Uncertainty
1	Conducted Emission Test	$\pm 1.38\text{dB}$
2	RF power,conducted	$\pm 0.16\text{dB}$
3	Spurious emissions,conducted	$\pm 0.21\text{dB}$
4	All emissions,radiated(<1G)	$\pm 4.68\text{dB}$
5	All emissions,radiated(>1G)	$\pm 4.89\text{dB}$
6	Temperature	$\pm 0.5^\circ\text{C}$
7	Humidity	$\pm 2\%$

## 2. GENERAL INFORMATION

### 2.1 GENERAL DESCRIPTION OF EUT

Equipment	150M WIRELESS USB MODULE	
Trade Name	N/A	
Model Name	MT-WN713NM	
Serial Model	N/A	
Model Difference	N/A	
Product Description	The EUT is a 150M WIRELESS USB MODULE	
	Operation Frequency:	2412~2462 MHz
	Modulation Type:	CCK/OFDM/DBPSK/DAPSK
	Bit Rate of Transmitter	802.11b:11/5.5/2/1 Mbps 802.11g:54/48/36/24/18/12/9/6 Mbps 802.11n:150/144.44/130/117/115.56/104/86.67/78/52/6.5 Mbps
	Number Of Channel	11 CH, Please see Note 2.
	Antenna Designation:	Please see Note 3.
	Output Power(Conducted):	802.11b: 16.54 dBm (Max.) 802.11g: 14.71 dBm (Max.) 802.11n: 14.56 dBm (Max.)
	Antenna Gain (dBi)	1.3dbi
	EIRP	802.11b: 17.84 dBm (Max.) 802.11g: 16.01 dBm (Max.) 802.11n: 15.86 dBm (Max.)
	Based on the application, features, or specification exhibited in User's Manual, the EUT is considered as an ITE/Computing Device. More details of EUT technical specification, please refer to the User's Manual.	
Channel List	Please refer to the Note 2.	
Power	DC 5V(USB) from PC	
Battery	N/A	
Connecting I/O Port(s)	Please refer to the User's Manual	

Note

:

1. For a more detailed features description, please refer to the manufacturer's specifications or the User's Manual.

2.

Channel List for 802.11b/g/n(20MHz)							
Channel	Frequency (MHz)	Channel	Frequency (MHz)	Channel	Frequency (MHz)	Channel	Frequency (MHz)
01	2412	04	2427	07	2442	10	2457
02	2417	05	2432	08	2447	11	2462
03	2422	06	2437	09	2452		

3.

Table for Filed Antenna

Ant	Brand	Model Name	Antenna Type	Connector	Gain (dBi)	NOTE
	N/A	N/A	PCB antenna	N/A	1.3	N/A



## 2.2 DESCRIPTION OF TEST MODES

To investigate the maximum EMI emission characteristics generates from EUT, the test system was pre-scanning tested base on the consideration of following EUT operation mode or test configuration mode which possible have effect on EMI emission level. Each of these EUT operation mode(s) or test configuration mode(s) mentioned above was evaluated respectively.

Pretest Mode	Description
Mode 1	802.11b CH1/ CH6/ CH11
Mode 2	802.11g CH1/ CH6/ CH11
Mode 3	802.11n CH1/ CH6/ CH11
Mode 4	NORMAL LINK

For Conducted Emission	
Final Test Mode	Description
Mode 4	NORMAL LINK

For Radiated Emission	
Final Test Mode	Description
Mode 1	802.11b CH1/ CH6/ CH11
Mode 2	802.11g CH1/ CH6/ CH11
Mode 3	802.11n CH1/ CH6/ CH11

Note:

- (1) The measurements are performed at the highest, middle, lowest available channels.
- (2) The measurements are performed at all Bit Rate of Transmitter, the worst data was reported

### 2.3 BLOCK DIGRAM SHOWING THE CONFIGURATION OF SYSTEM TESTED

Conducted Emission Test

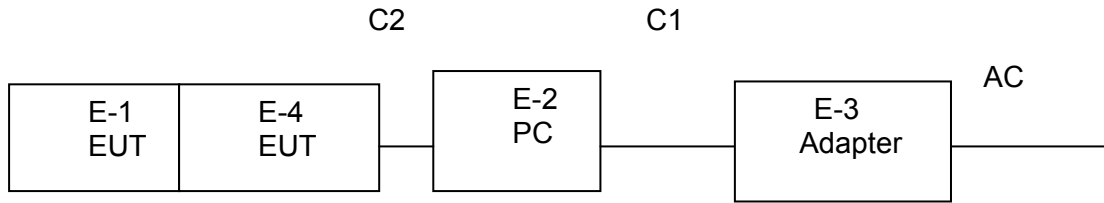

Radiated Spurious Emission Test

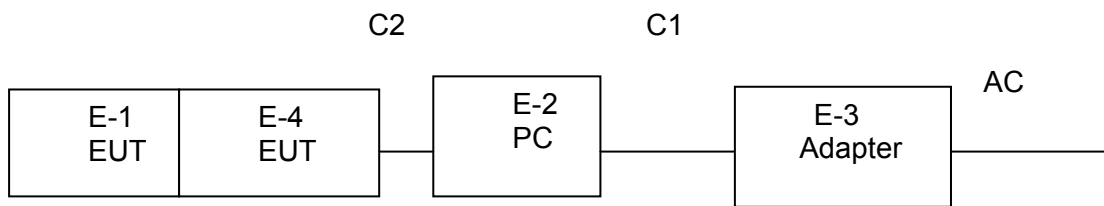

**2.4 DESCRIPTION OF SUPPORT UNITS(CONDUCTED MODE)**

The EUT has been tested as an independent unit together with other necessary accessories or support units. The following support units or accessories were used to form a representative test configuration during the tests.

Item	Equipment	Mfr/Brand	Model/Type No.	Series No.	Note
E-1	150M WIRELESS USB MODULE	N/A	MT-WN713NM	N/A	EUT
E-2	Notebook computer	IBM	2366	N/A	
E-3	Adapter	IBM	08K8202	N/A	
E-4	Control frame	N/A	MN-713NM-V2.0	N/A	

Item	Shielded Type	Ferrite Core	Length	Note
C1	NO	NO	0.8M	
C2	NO	NO	0.4M	

**Note:**

- (1) The support equipment was authorized by Declaration of Confirmation.
- (2) For detachable type I/O cable should be specified the length in cm in 『Length』 column.
- (3) The control frame can control transmit of EUT by PC(USB).

**2.5 EQUIPMENTS LIST FOR ALL TEST ITEMS**

**Radiation Test equipment**

Item	Kind of Equipment	Manufacturer	Type No.	Serial No.	Calibrated until
1	Spectrum Analyzer	Agilent	E4407B	160400005	Jul. 06. 2013
2	Test Receiver	R&S	ESPI	101318	Jul. 06. 2013
3	Bilog Antenna	TESEQ	CBL6111D	31216	Jul. 06. 2013
4	50Ω Coaxial Switch	Anritsu	MP59B	6200264416	Jul. 06. 2013
5	Spectrum Analyzer	ADVANTEST	R3132	150900201	Jul. 06. 2013
6	Horn Antenna	EM	EM-AH-10180	2011071402	Jul. 06. 2013
7	Horn Ant	Schwarzbeck	BBHA 9170	9170-181	Jul. 06. 2013
8	Amplifier	EM	EM-30180	060538	Jul. 06. 2013
9	Loop Antenna	ARA	PLA-1030/B	1029	Jul. 06. 2013
10	Power Meter	R&S	NRVS	100696	Jul. 06. 2013

**Conduction Test equipment**

Item	Kind of Equipment	Manufacturer	Type No.	Serial No.	Calibrated until
1	Test Receiver	R&S	ESCI	101160	Jul. 06. 2013
2	LISN	R&S	ENV216	101313	Jul. 06. 2013
3	LISN	EMCO	3816/2	00042990	Jul. 06. 2013
4	50Ω Coaxial Switch	Anritsu	MP59B	6200264417	Jul. 06. 2013
5	Passive Voltage Probe	R&S	ESH2-Z3	100196	Jul. 06. 2013
6	Absorbing clamp	R&S	MOS-21	100423	Jul. 06. 2013

### 3. EMC EMISSION TEST

#### 3.1 CONDUCTED EMISSION MEASUREMENT

##### 3.1.1 POWER LINE CONDUCTED EMISSION Limits (Frequency Range 150KHz-30MHz)

FREQUENCY (MHz)	Class A (dBuV)		Class B (dBuV)		Standard
	Quasi-peak	Average	Quasi-peak	Average	
0.15 -0.5	79.00	66.00	66 - 56 *	56 - 46 *	CISPR
0.50 -5.0	73.00	60.00	56.00	46.00	CISPR
5.0 -30.0	73.00	60.00	60.00	50.00	CISPR

0.15 -0.5	79.00	66.00	66 - 56 *	56 - 46 *	FCC
0.50 -5.0	73.00	60.00	56.00	46.00	FCC
5.0 -30.0	73.00	60.00	60.00	50.00	FCC

Note:

- (1) The tighter limit applies at the band edges.
- (2) The limit of " \* " marked band means the limitation decreases linearly with the logarithm of the frequency in the range.

The following table is the setting of the receiver

Receiver Parameters	Setting
Attenuation	10 dB
Start Frequency	0.15 MHz
Stop Frequency	30 MHz
IF Bandwidth	9 kHz

**3.1.2 TEST PROCEDURE**

- a. The EUT was placed 0.4 meters from the horizontal ground plane with EUT being connected to the power mains through a line impedance stabilization network (LISN). All other support equipments powered from additional LISN(s). The LISN provide 50 Ohm/ 50uH of coupling impedance for the measuring instrument.
- b. Interconnecting cables that hang closer than 40 cm to the ground plane shall be folded back and forth in the center forming a bundle 30 to 40 cm long.
- c. I/O cables that are not connected to a peripheral shall be bundled in the center. The end of the cable may be terminated, if required, using the correct terminating impedance. The overall length shall not exceed 1 m.
- d. LISN at least 80 cm from nearest part of EUT chassis.
- e. For the actual test configuration, please refer to the related Item –EUT Test Photos.

**3.1.3 DEVIATION FROM TEST STANDARD**

No deviation

**3.1.4 TEST SETUP**

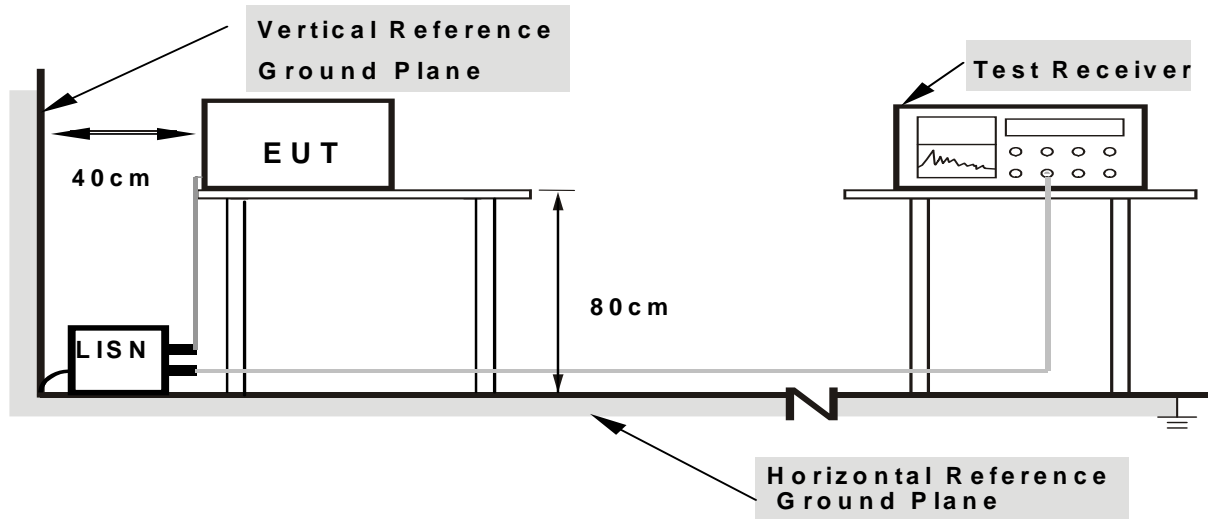

- Note:**
- 1. Support units were connected to second LISN.
  - 2. Both of LISNs (AMN) are 80 cm from EUT and at least 80 from other units and other metal planes

**3.1.5 EUT OPERATING CONDITIONS**

The EUT was configured for testing in a typical fashion (as a customer would normally use it). The EUT has been programmed to continuously transmit during test. This operating condition was tested and used to collect the included data.

### 3.1.6 TEST RESULTS

EUT :	150M WIRELESS USB MODULE	Model Name. :	MT-WN713NM
Temperature :	26 °C	Relative Humidity :	54%
Pressure :	1010hPa	Phase :	L
Test Voltage :	DC 5.0V connect to PC	Test Mode :	Mode 4

Frequency (MHz)	Meter Reading (dBμV)	Factor (dB)	Emission Level (dBμV)	Limits (dBμV)	Margin (dB)	Detector Type
0.1539	28.25	11.03	39.28	55.78	-16.5	AVG
0.17	40.77	10.35	51.12	64.96	-13.84	peak
1.446	35.62	10.45	46.07	56	-9.93	peak
1.446	25.01	10.45	35.46	46	-10.54	AVG

**Remark:**

1. All readings are Quasi-Peak and Average values.
2. Factor = Insertion Loss + Cable Loss.

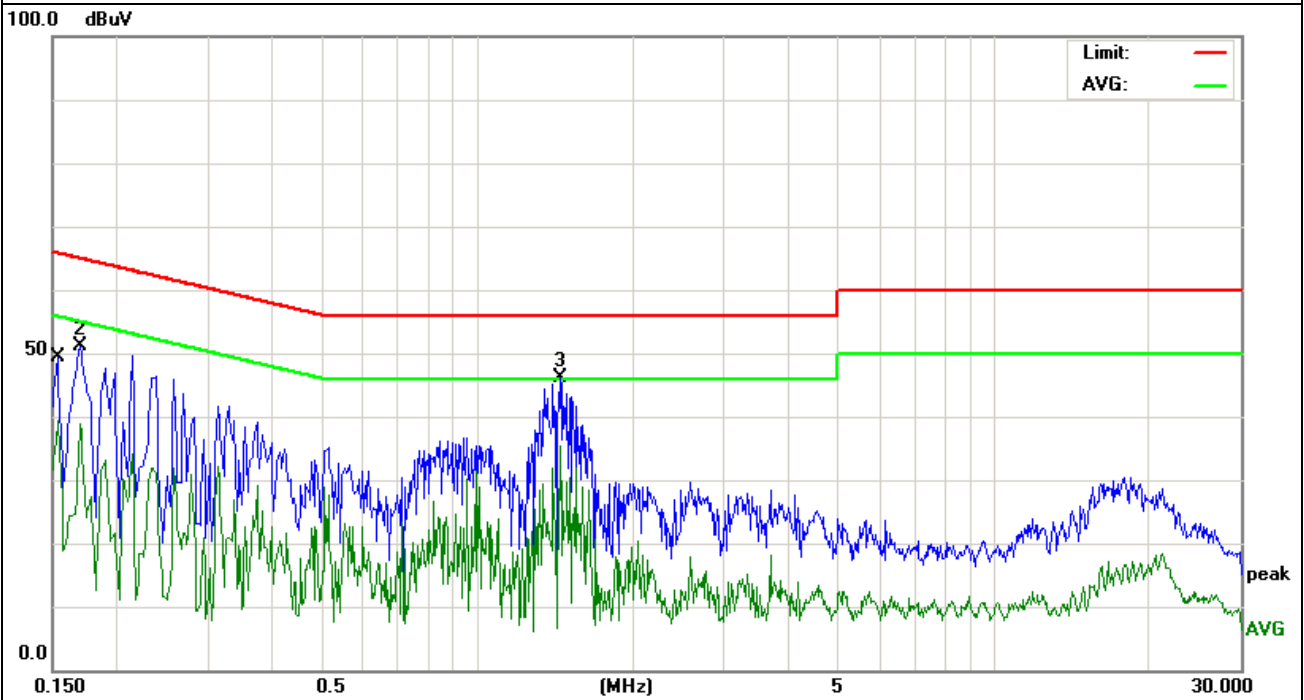

EUT :	150M WIRELESS USB MODULE	Model Name. :	MT-WN713NM
Temperature :	26 °C	Relative Humidity :	54%
Pressure :	1010hPa	Phase :	N
Test Voltage :	DC 5.0V connect to PC	Test Mode :	Mode 4

Frequency (MHz)	Meter Reading (dBμV)	Factor (dB)	Emission Level (dBμV)	Limits (dBμV)	Margin (dB)	Detector Type
0.166	39.39	10.45	49.84	65.15	-15.31	peak
0.194	29.18	10.44	39.62	53.86	-14.24	AVG
1.406	32.55	10.41	42.96	56	-13.04	peak
1.45	27.07	10.41	37.48	46	-8.52	AVG

Remark:

1. All readings are Quasi-Peak and Average values.
2. Factor = Insertion Loss + Cable Loss.

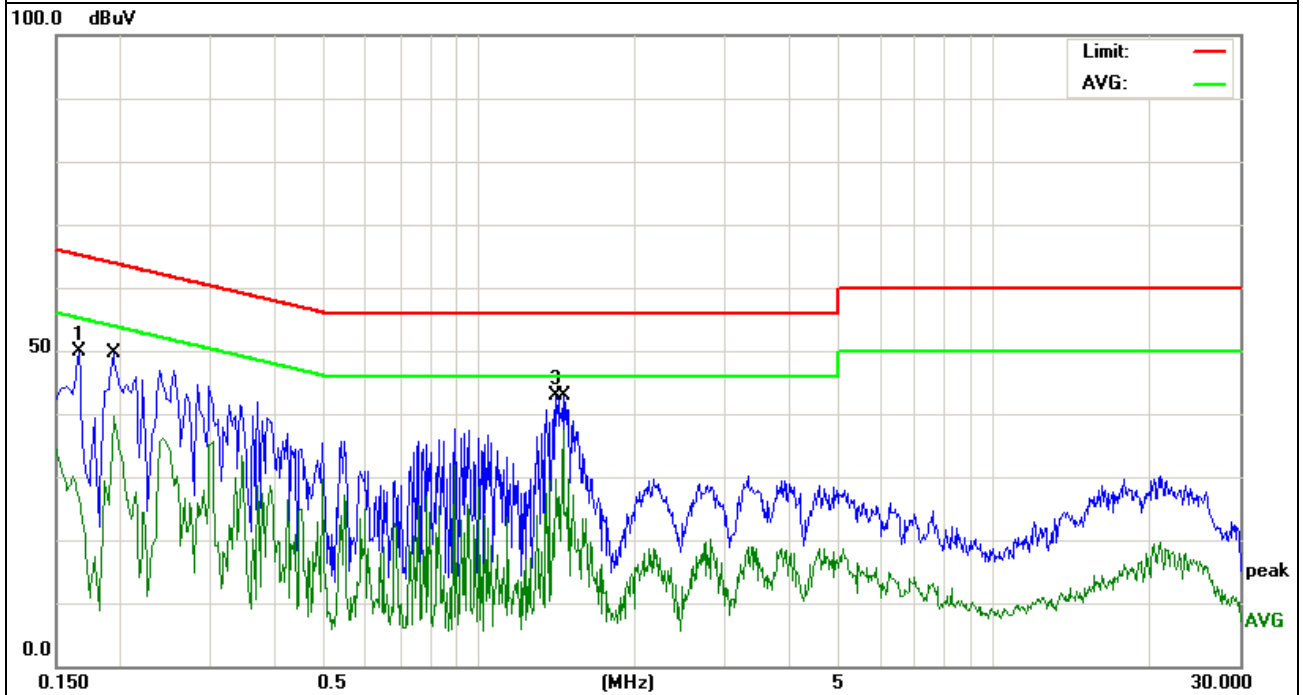



### 3.2 RADIATED EMISSION MEASUREMENT

#### 3.2.1 RADIATED EMISSION LIMITS (Frequency Range 9kHz-1000MHz)

20dBc in any 100 kHz bandwidth outside the operating frequency band. In case the emission fall within the restricted band specified on 15.205(a), then the 15.209(a) limit in the table below has to be followed.

Frequencies (MHz)	Field Strength (microrvolts/meter)	Measurement Distance (meters)
0.009~0.490	2400/F(KHz)	300
0.490~1.705	24000/F(KHz)	30
1.705~30.0	30	30
30~88	100	3
88~216	150	3
216~960	200	3
Above 960	500	3

#### LIMITS OF RADIATED EMISSION MEASUREMENT (Above 1000MHz)

FREQUENCY (MHz)	Class A (dBuV/m) (at 3M)		Class B (dBuV/m) (at 3M)	
	PEAK	AVERAGE	PEAK	AVERAGE
Above 1000	80	60	74	54

Notes:

- (1) The limit for radiated test was performed according to FCC PART 15C.
- (2) The tighter limit applies at the band edges.
- (3) Emission level (dBuV/m)=20log Emission level (uV/m).

Spectrum Parameter	Setting
Attenuation	Auto
Start Frequency	1000 MHz
Stop Frequency	10th carrier harmonic
RB / VB (emission in restricted band)	1 MHz / 1 MHz for Peak, 1 MHz / 10Hz for Average

Receiver Parameter	Setting
Attenuation	Auto
Start ~ Stop Frequency	9kHz~150kHz / RB 200Hz for QP
Start ~ Stop Frequency	150kHz~30MHz / RB 9kHz for QP
Start ~ Stop Frequency	30MHz~1000MHz / RB 120kHz for QP

### 3.2.2 TEST PROCEDURE

- a. The measuring distance of at 3 m shall be used for measurements at frequency up to 1GHz. For frequencies above 1GHz, any suitable measuring distance may be used.
- b. The EUT was placed on the top of a rotating table 0.8 meters above the ground at a 3 meter open area test site. The table was rotated 360 degrees to determine the position of the highest radiation.
- c. The height of the equipment or of the substitution antenna shall be 0.8 m; the height of the test antenna shall vary between 1 m to 4 m. Both horizontal and vertical polarizations of the antenna are set to make the measurement.
- d. The initial step in collecting conducted emission data is a spectrum analyzer peak detector mode pre-scanning the measurement frequency range. Significant peaks are then marked and then Quasi Peak detector mode re-measured.
- e. If the Peak Mode measured value compliance with and lower than Quasi Peak Mode Limit, the EUT shall be deemed to meet QP Limits and then no additional QP Mode measurement performed.
- f. For the actual test configuration, please refer to the related Item –EUT Test Photos.

Note:

Both horizontal and vertical antenna polarities were tested and performed pretest to three orthogonal axis. The worst case emissions were reported

### 3.2.3 DEVIATION FROM TEST STANDARD

No deviation

**3.2.4 TEST SETUP**

(A) Radiated Emission Test-Up Frequency Below 30MHz

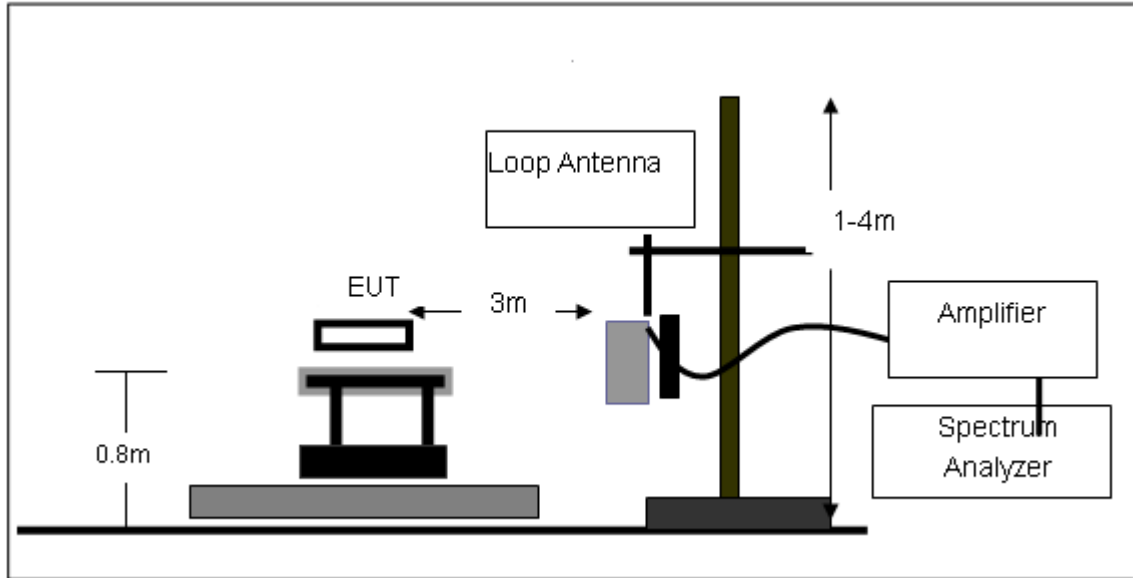

(B) Radiated Emission Test-Up Frequency 30MHz~1GHz

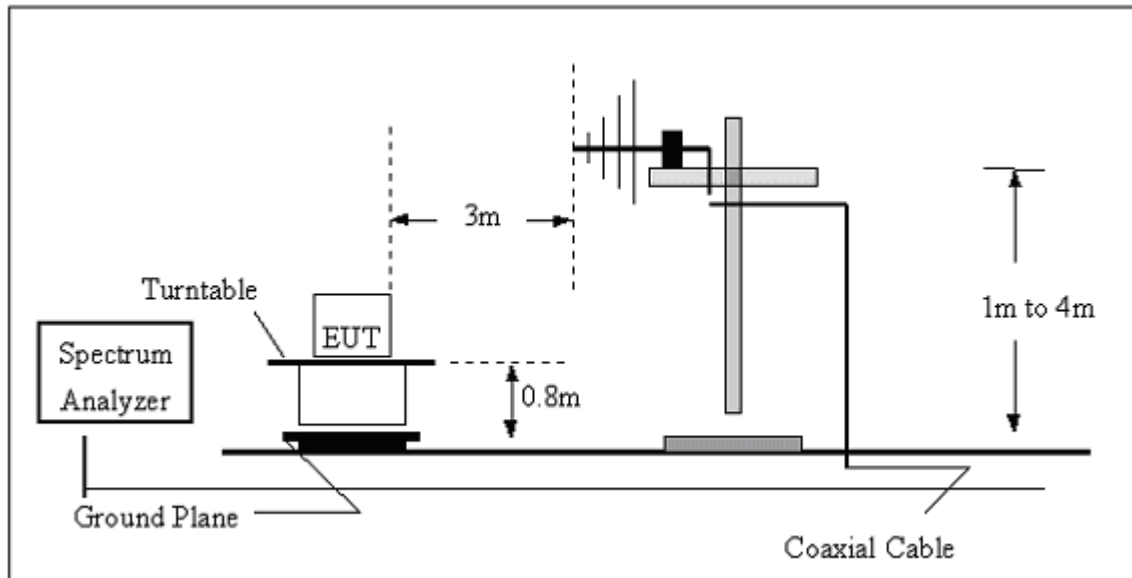

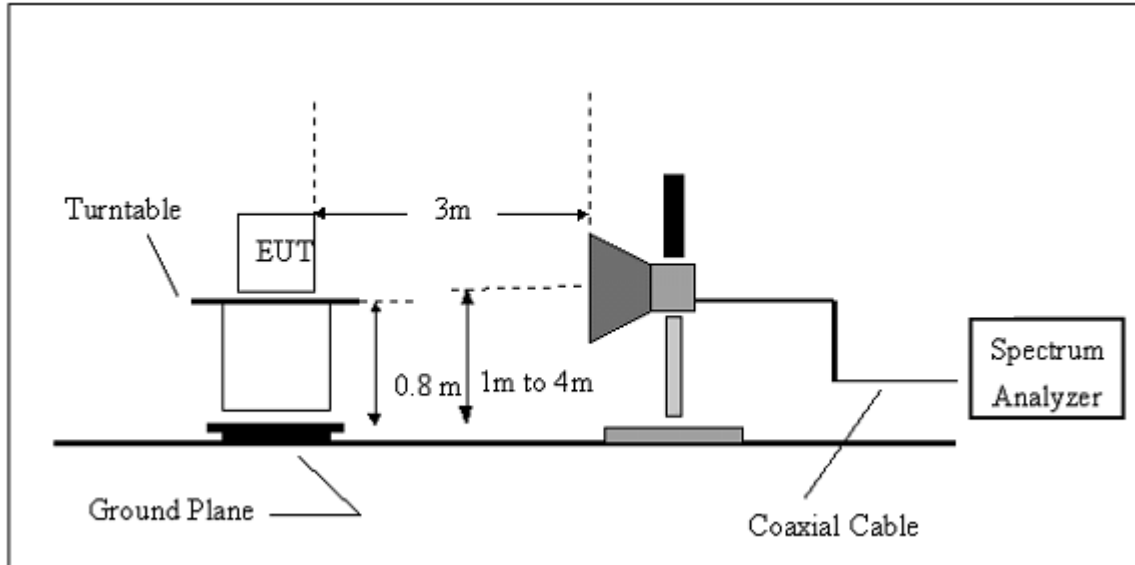
**(C) Radiated Emission Test-Up Frequency Above 1GHz****3.2.5 EUT OPERATING CONDITIONS**

The EUT tested system was configured as the statements of 2.4 Unless otherwise a special operating condition is specified in the follows during the testing.

**3.2.6 TEST RESULTS (BETWEEN 9KHZ – 30 MHZ)**

EUT:	150M WIRELESS USB MODULE	Model Name. :	MT-WN713NM
Temperature:	20 °C	Relative Humidity:	48%
Pressure:	1010 hPa	Test Voltage :	DC 5.0V
Test Mode :	TX	Polarization :	--

Freq.	Reading	Limit	Margin	State
(MHz)	(dBuV/m)	(dBuV/m)	(dB)	P/F
--	--	--	--	PASS
--	--	--	--	PASS

**NOTE:**

The amplitude of spurious emissions which are attenuated by more than 20dB below the permissible value has no need to be reported.

Distance extrapolation factor =  $20 \log (\text{specific distance}/\text{test distance})(\text{dB})$ ;

Limit line = specific limits(dBuv) + distance extrapolation factor.

### 3.2.7 TEST RESULTS (BETWEEN 30MHZ – 1GHZ)

EUT :	150M WIRELESS USB MODULE	Model Name :	MT-WN713NM
Temperature :	20 °C	Relative Humidity :	48%
Pressure :	1010 hPa	Test Voltage :	DC 5.0V
Test Mode :	TX	Polarization :	Horizontal

Frequency (MHz)	Meter Reading (dBµV)	Factor (dB)	Emission Level (dBµV/m)	Limits (dBµV/m)	Margin (dB)	Detector Type
41.2765	16.78	12.63	29.41	40	-10.59	QP
102.3597	17.57	10.79	28.36	43.5	-15.14	QP
169.0054	21.83	10.11	31.94	43.5	-11.56	QP
311.0867	18.74	14.61	33.35	46	-12.65	QP
467.2349	18.54	18.49	37.03	46	-8.97	QP
729.3583	15.28	23.86	39.14	46	-6.86	QP

Remark:  
Factor = Antenna Factor + Cable Loss – Pre-amplifier.

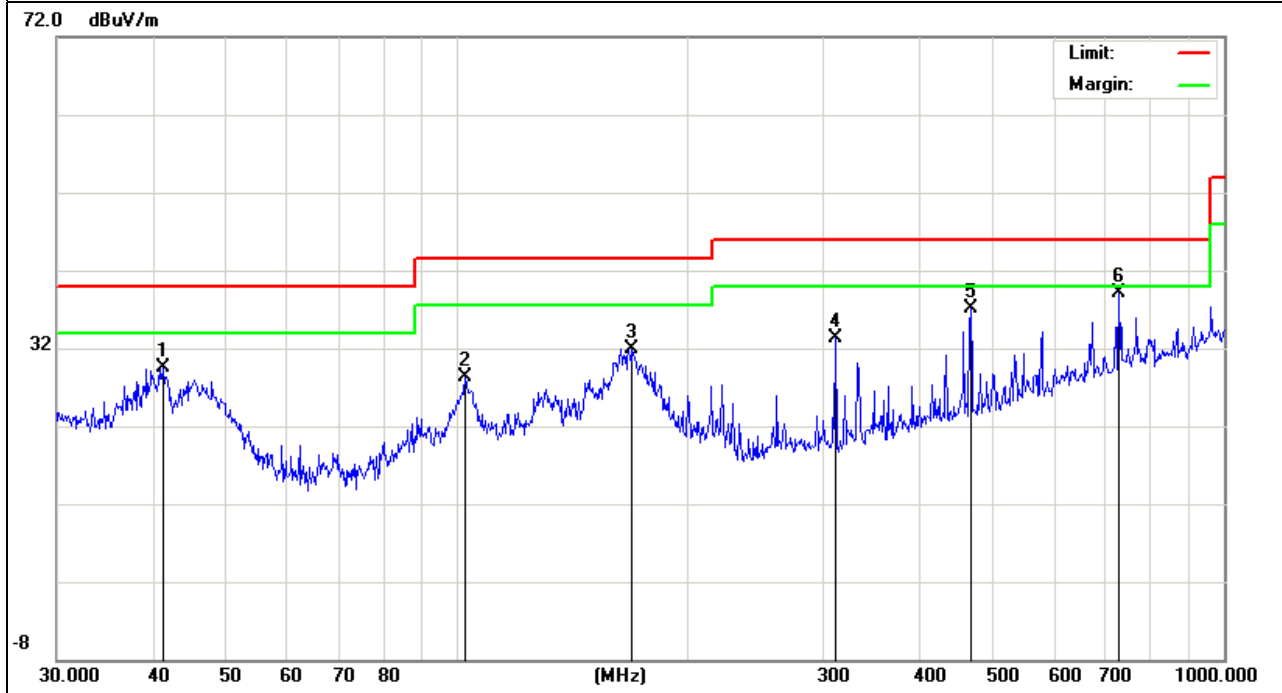

EUT :	150M WIRELESS USB MODULE	Model Name :	MT-WN713NM
Temperature :	20 °C	Relative Humidity :	48%
Pressure :	1010 hPa	Test Voltage :	DC 5.0V
Test Mode :	TX	Polarization :	Vertical

Frequency (MHz)	Meter Reading (dBμV)	Factor (dB)	Emission Level (dBμV/m)	Limits (dBμV/m)	Margin (dB)	Detector Type
50.586	12.99	7.9	20.89	40	-19.11	QP
99.8777	13.32	10.63	23.95	43.5	-19.55	QP
199.2855	21.75	8.71	30.46	43.5	-13.04	QP
364.2595	20.12	15.7	35.82	46	-10.18	QP
467.2349	14.56	18.49	33.05	46	-12.95	QP
729.3583	10.94	23.86	34.8	46	-11.2	QP

Remark:

Factor = Antenna Factor + Cable Loss – Pre-amplifier.

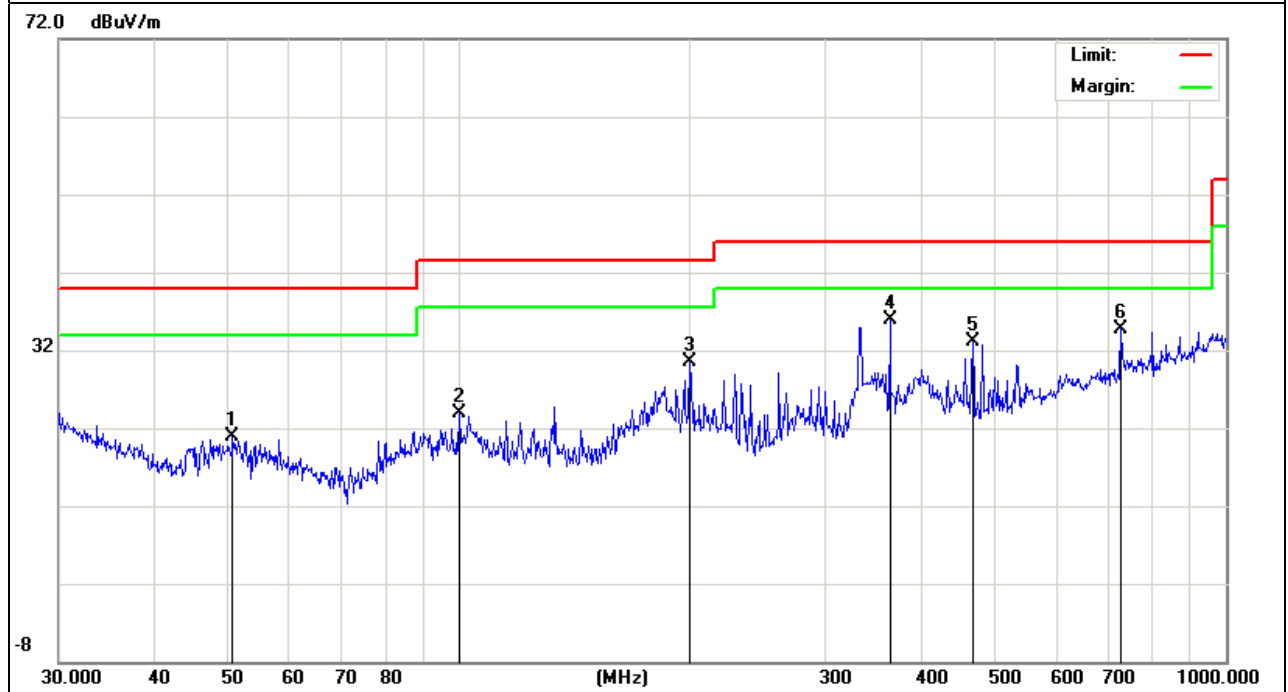

### 3.2.8 TEST RESULTS (ABOVE 1000 MHZ)

EUT :	150M WIRELESS USB MODULE	Model Name :	MT-WN713NM
Temperature :	20 °C	Relative Humidity :	48%
Pressure :	1010 hPa	Test Voltage :	DC 5.0V
Test Mode :	CH1 (802.11b Mode)	Polarization :	Horizontal

Frequency (MHz)	Meter Reading (dBμV)	Factor (dB)	Emission Level (dBμV/m)	Limits (dBμV/m)	Margin (dB)	Detector Type
4824	59.33	2.6	61.93	74	-12.07	peak
4824	38.88	2.6	41.48	54	-12.52	AVG
7236	55.26	4.59	59.85	74	-14.15	peak
7236	39.67	4.59	44.26	54	-9.74	AVG

Remark:  
Factor = Antenna Factor + Cable Loss – Pre-amplifier.

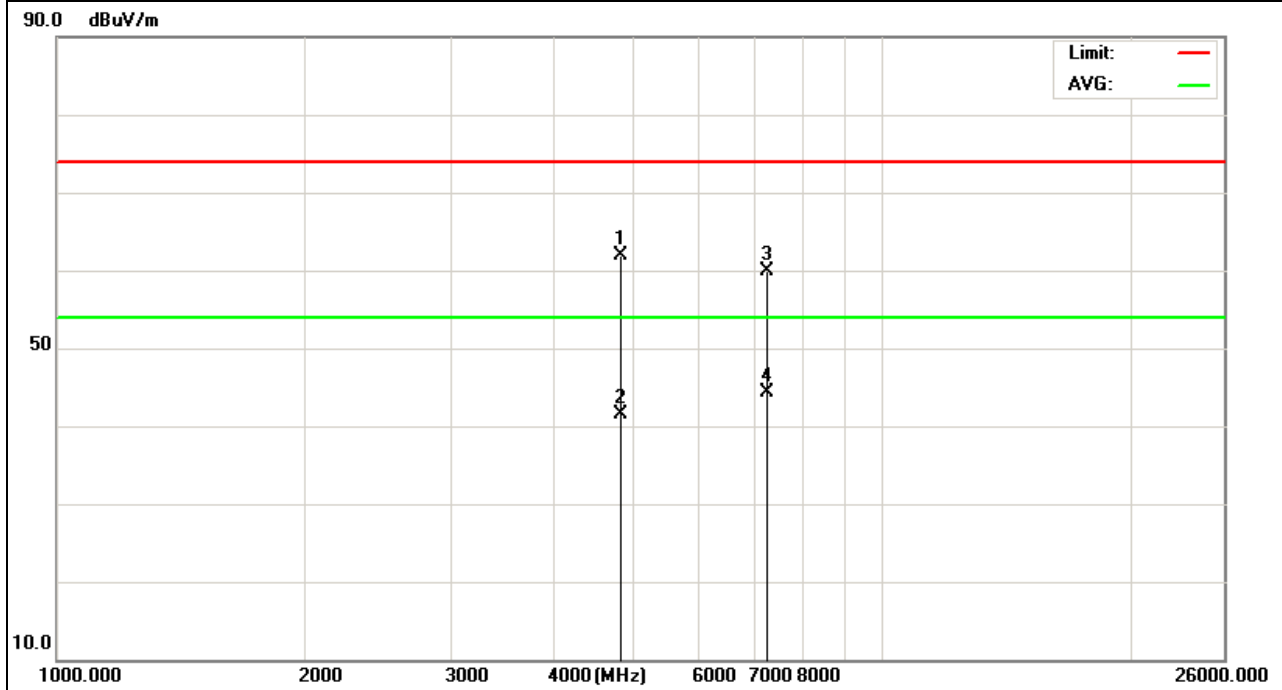



EUT :	150M WIRELESS USB MODULE	Model Name :	MT-WN713NM
Temperature :	20 °C	Relative Humidity :	48%
Pressure :	1010 hPa	Test Voltage :	DC 5.0V
Test Mode :	CH1 (802.11b Mode)	Polarization :	Vertical

Frequency (MHz)	Meter Reading (dBµV)	Factor (dB)	Emission Level (dBµV/m)	Limits (dBµV/m)	Margin (dB)	Detector Type
4824	57.89	2.6	60.49	74	-13.51	peak
4824	38.87	2.6	41.47	54	-12.53	AVG
7236	51.69	4.59	56.28	74	-17.72	peak
7236	31.24	4.59	35.83	54	-18.17	AVG

Remark:  
 Factor = Antenna Factor + Cable Loss – Pre-amplifier.

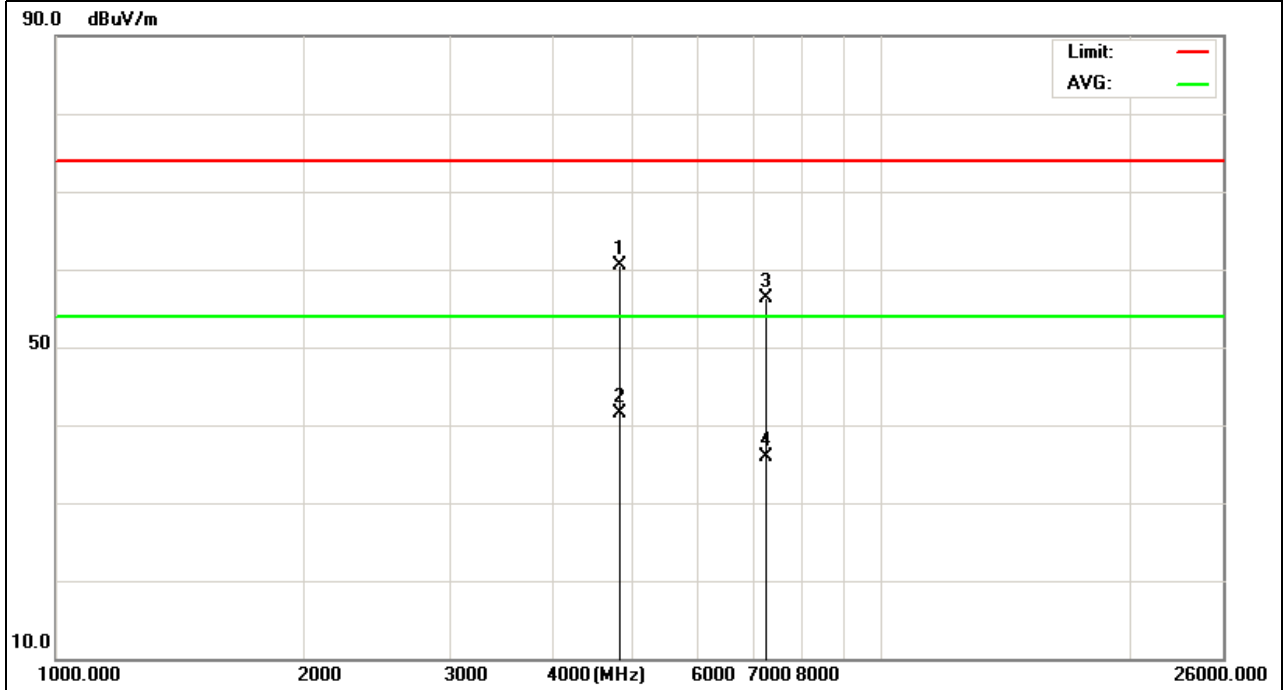

EUT :	150M WIRELESS USB MODULE	Model Name :	MT-WN713NM
Temperature :	20 °C	Relative Humidity :	48%
Pressure :	1010 hPa	Test Voltage :	DC 5.0V
Test Mode :	CH6 (802.11b Mode)	Polarization :	Horizontal

Frequency (MHz)	Meter Reading (dBμV)	Factor (dB)	Emission Level (dBμV/m)	Limits (dBμV/m)	Margin (dB)	Detector Type
4874	61.66	2.6	64.26	74	-9.74	peak
4874	43.32	2.6	45.92	54	-8.08	AVG
7311	56.67	4.93	61.6	74	-12.4	peak
7311	37.36	4.93	42.29	54	-11.71	AVG

Remark:  
 Factor = Antenna Factor + Cable Loss – Pre-amplifier.

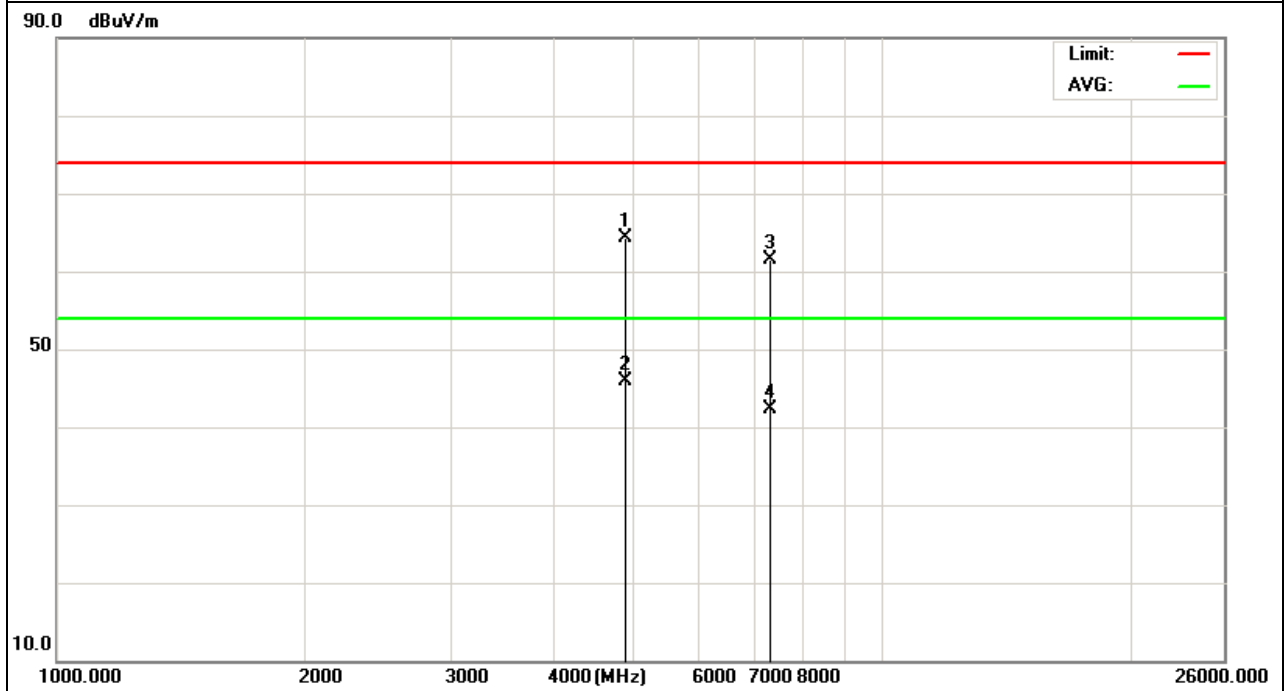

EUT :	150M WIRELESS USB MODULE	Model Name :	MT-WN713NM
Temperature :	20 °C	Relative Humidity :	48%
Pressure :	1010 hPa	Test Voltage :	DC 5.0V
Test Mode :	CH6 (802.11b Mode)	Polarization :	Vertical

Frequency (MHz)	Meter Reading (dBμV)	Factor (dB)	Emission Level (dBμV/m)	Limits (dBμV/m)	Margin (dB)	Detector Type
4874	57.89	2.6	60.49	74	-13.51	peak
4874	42.42	2.6	45.02	54	-8.98	AVG
7311	51.55	4.93	56.48	74	-17.52	peak
7311	40.56	4.93	45.49	54	-8.51	AVG

Remark:

Factor = Antenna Factor + Cable Loss – Pre-amplifier.

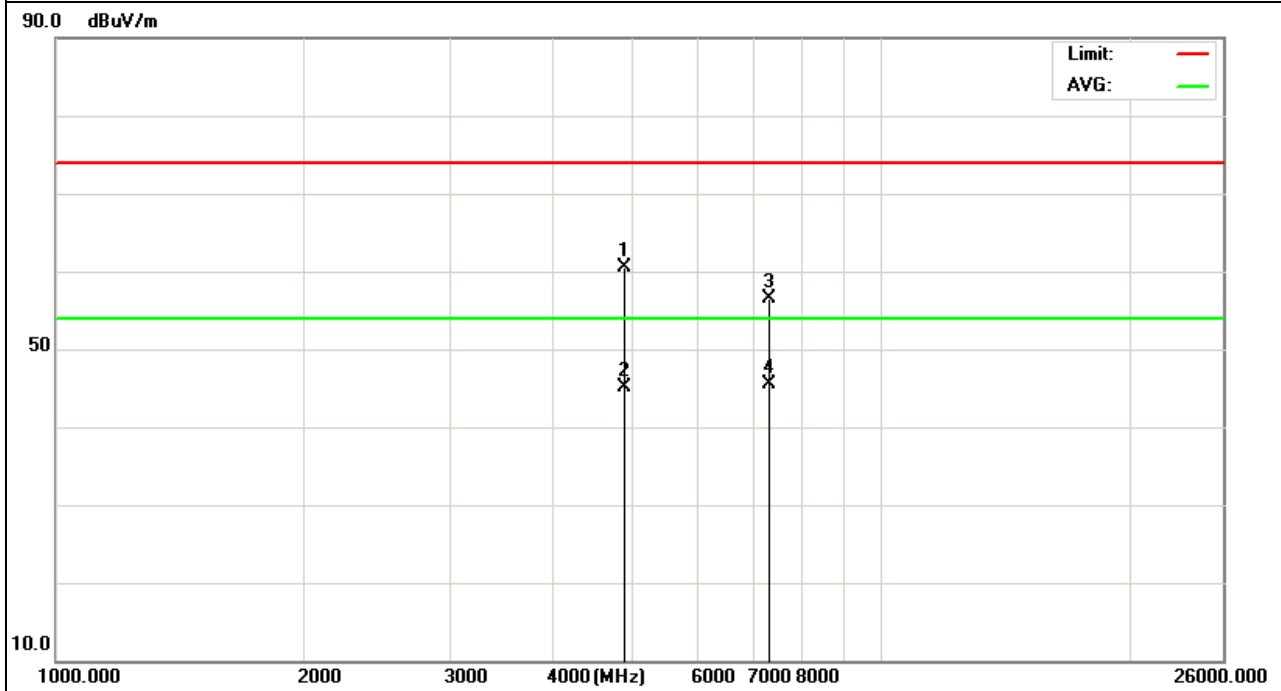

EUT :	150M WIRELESS USB MODULE	Model Name :	MT-WN713NM
Temperature :	20 °C	Relative Humidity :	48%
Pressure :	1010 hPa	Test Voltage :	DC 5.0V
Test Mode :	CH11 (802.11b Mode)	Polarization :	Horizontal

Frequency (MHz)	Meter Reading (dBµV)	Factor (dB)	Emission Level (dBµV/m)	Limits (dBµV/m)	Margin (dB)	Detector Type
4924	54.77	2.64	57.41	74	-16.59	peak
4924	37.76	2.64	40.4	54	-13.6	AVG
7386	45.88	4.83	50.71	74	-23.29	peak
7386	31.22	4.83	36.05	54	-17.95	AVG

Remark:

- Factor = Antenna Factor + Cable Loss – Pre-amplifier.
- No emission detected above 18GHz

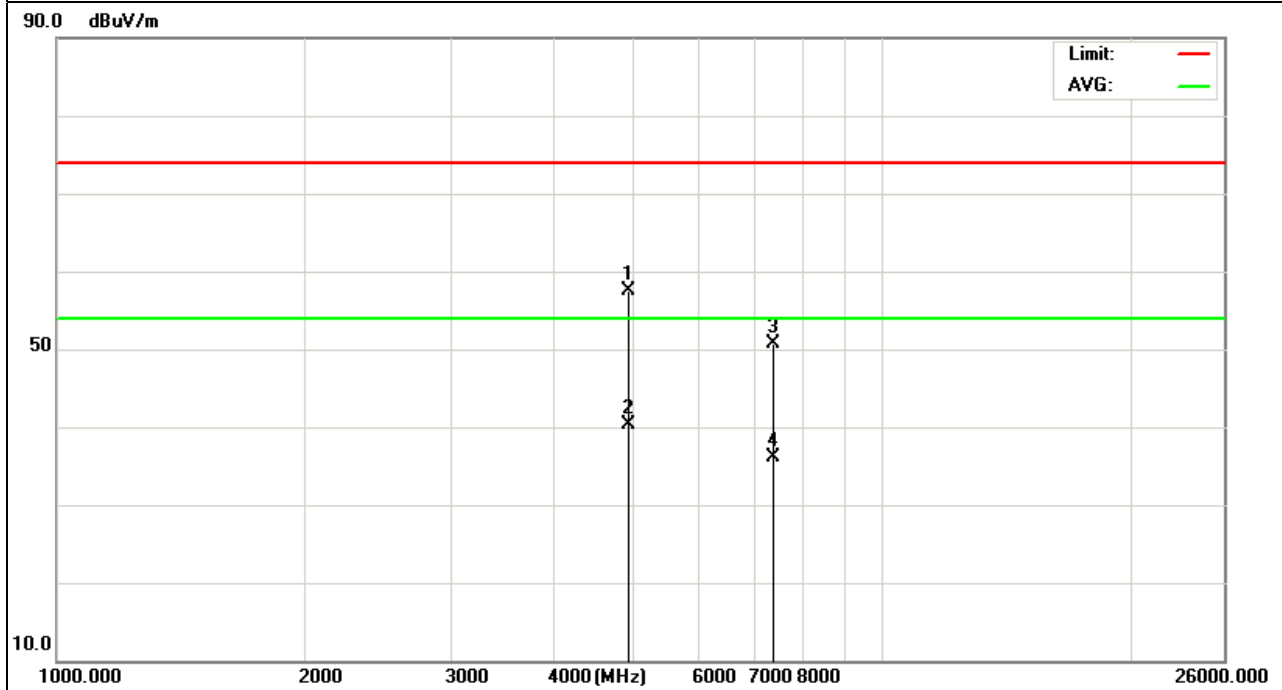

EUT :	150M WIRELESS USB MODULE	Model Name :	MT-WN713NM
Temperature :	20 °C	Relative Humidity :	48%
Pressure :	1010 hPa	Test Voltage :	DC 5.0V
Test Mode :	CH11 (802.11b Mode)	Polarization :	Vertical

Frequency (MHz)	Meter Reading (dBμV)	Factor (dB)	Emission Level (dBμV/m)	Limits (dBμV/m)	Margin (dB)	Detector Type
4924	57.89	2.64	60.53	74	-13.47	peak
4924	43.45	2.64	46.09	54	-7.91	AVG
7386	51.09	4.83	55.92	74	-18.08	peak
7386	40.44	4.83	45.27	54	-8.73	AVG

Remark:  
Factor = Antenna Factor + Cable Loss – Pre-amplifier.

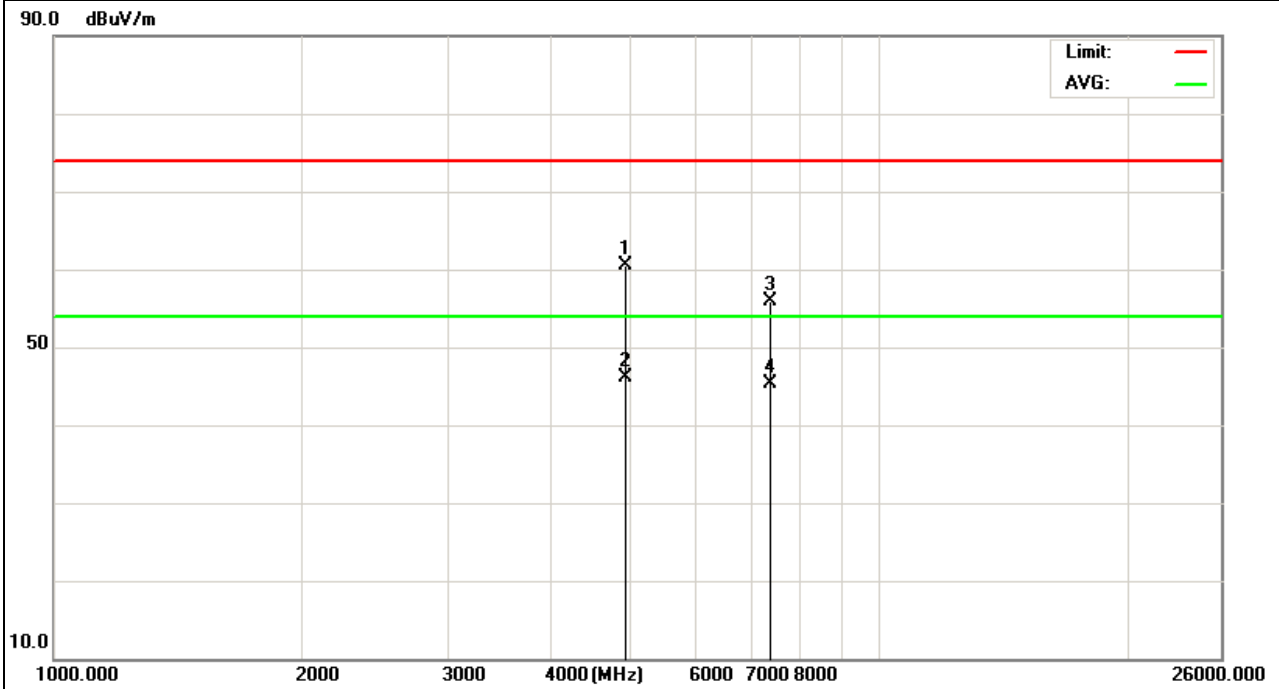

EUT :	150M WIRELESS USB MODULE	Model Name :	MT-WN713NM
Temperature :	20 °C	Relative Humidity :	48%
Pressure :	1010 hPa	Test Voltage :	DC 5.0V
Test Mode :	CH1 (802.11g Mode)	Polarization :	Horizontal

Frequency (MHz)	Meter Reading (dBµV)	Factor (dB)	Emission Level (dBµV/m)	Limits (dBµV/m)	Margin (dB)	Detector Type
4824	58.78	2.6	61.38	74	-12.62	peak
4824	38.32	2.6	40.92	54	-13.08	AVG
7236	53.36	4.59	57.95	74	-16.05	peak
7236	34.99	4.59	39.58	54	-14.42	AVG

Remark:  
Factor = Antenna Factor + Cable Loss – Pre-amplifier.

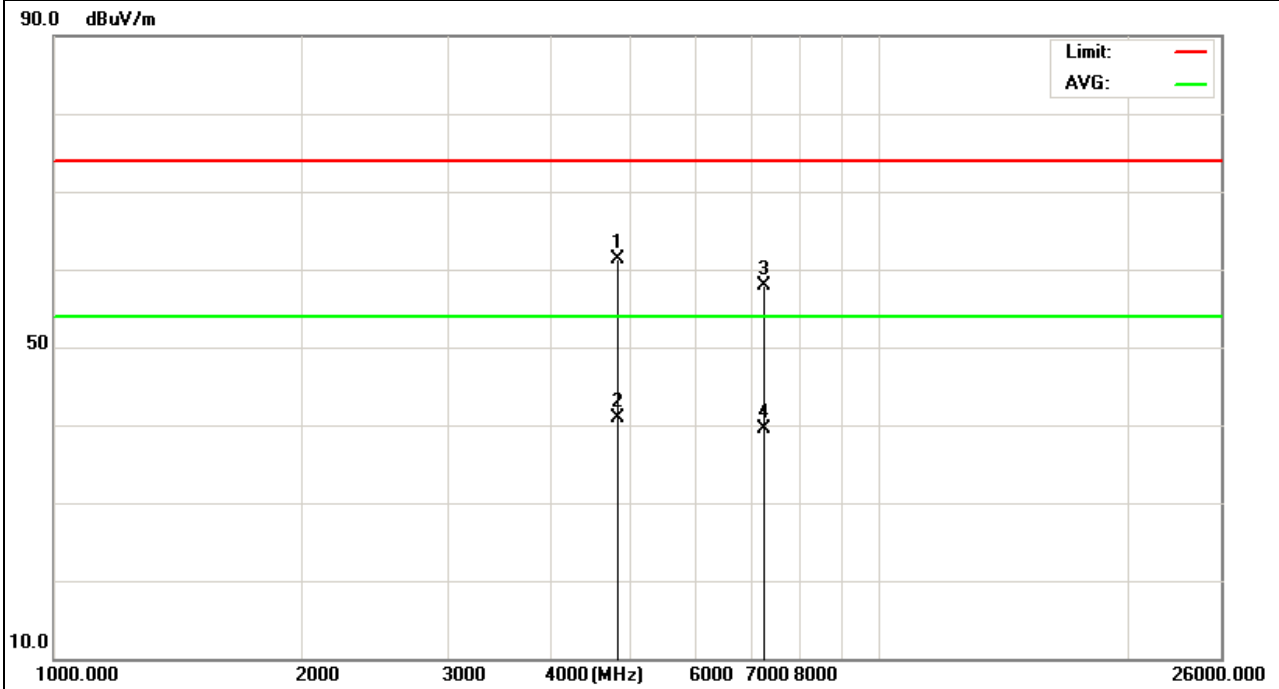

EUT :	150M WIRELESS USB MODULE	Model Name :	MT-WN713NM
Temperature :	20 °C	Relative Humidity :	48%
Pressure :	1010 hPa	Test Voltage :	DC 5.0V
Test Mode :	CH1 (802.11g Mode)	Polarization :	Vertical

Frequency (MHz)	Meter Reading (dBμV)	Factor (dB)	Emission Level (dBμV/m)	Limits (dBμV/m)	Margin (dB)	Detector Type
4824	54.88	2.6	57.48	74	-16.52	peak
4824	34.87	2.6	37.47	54	-16.53	AVG
7236	49.78	4.59	54.37	74	-19.63	peak
7236	31.09	4.59	35.68	54	-18.32	AVG

Remark:  
Factor = Antenna Factor + Cable Loss – Pre-amplifier.

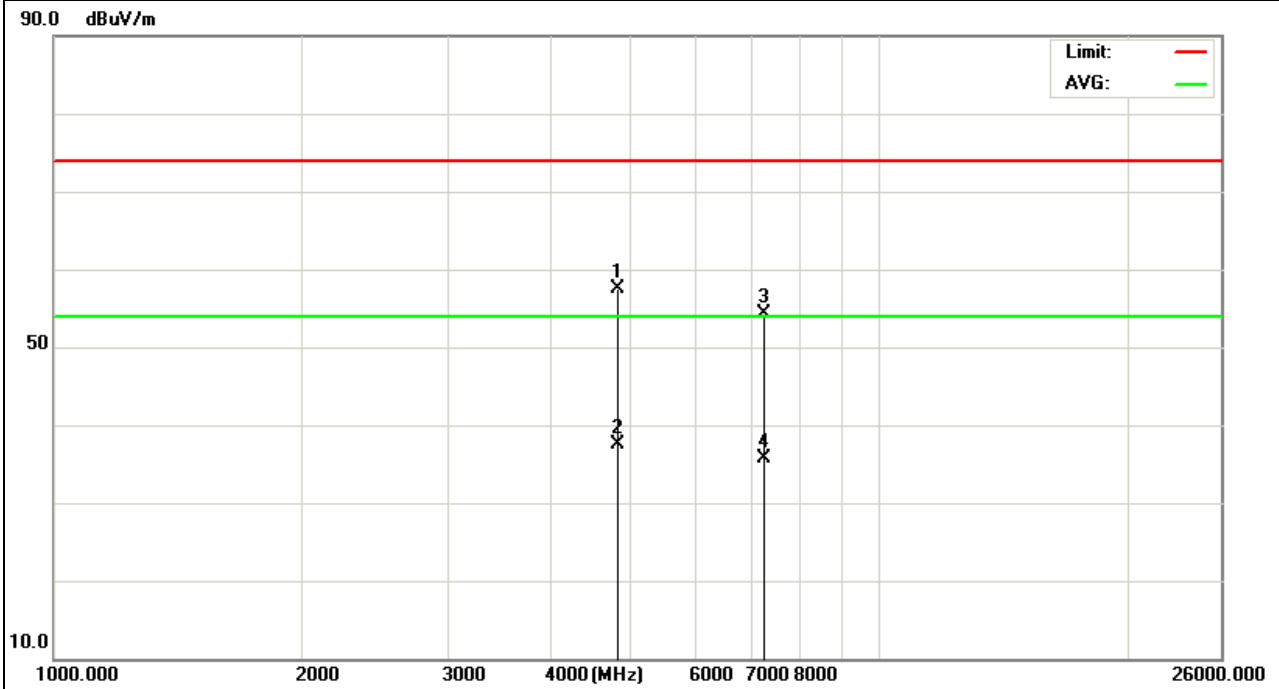

EUT :	150M WIRELESS USB MODULE	Model Name :	MT-WN713NM
Temperature :	20 °C	Relative Humidity :	48%
Pressure :	1010 hPa	Test Voltage :	DC 5.0V
Test Mode :	CH6 (802.11g Mode)	Polarization :	Horizontal

Frequency (MHz)	Meter Reading (dBμV)	Factor (dB)	Emission Level (dBμV/m)	Limits (dBμV/m)	Margin (dB)	Detector Type
4874	58.54	2.57	61.11	74	-12.89	peak
4874	37.76	2.57	40.33	54	-13.67	AVG
7311	52.45	4.93	57.38	74	-16.62	peak
7311	33.12	4.93	38.05	54	-15.95	AVG

Remark:  
 Factor = Antenna Factor + Cable Loss – Pre-amplifier.

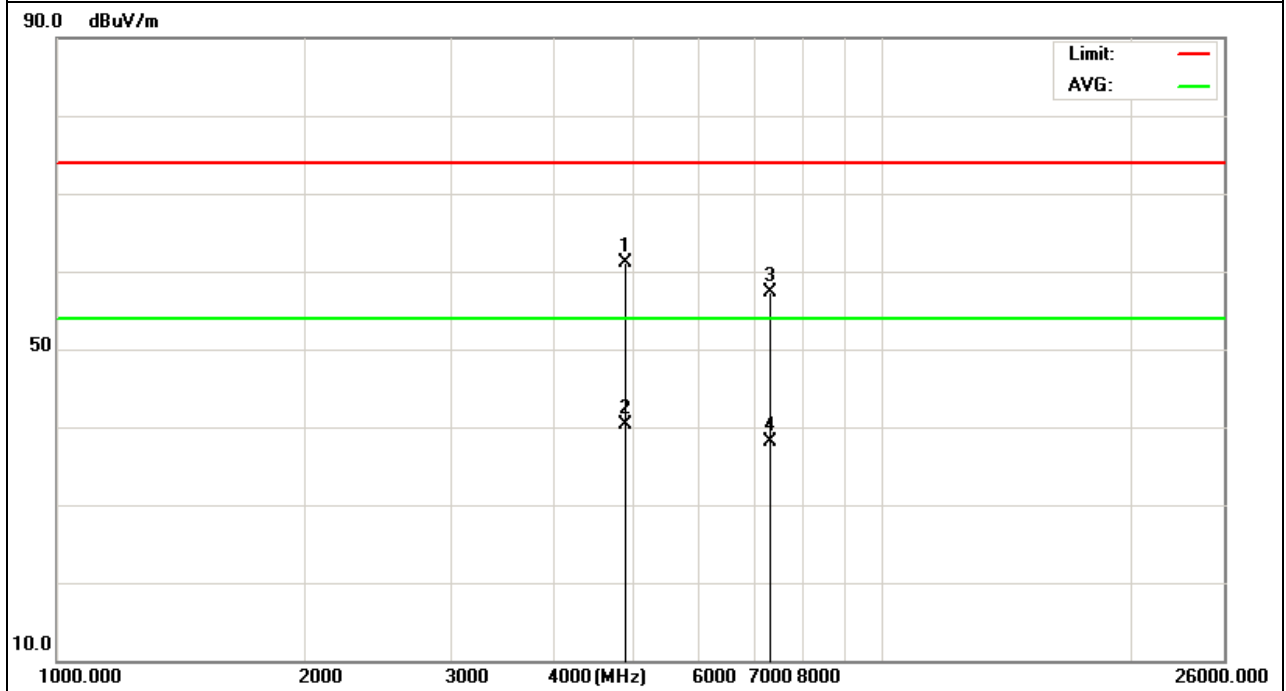



EUT :	150M WIRELESS USB MODULE	Model Name :	MT-WN713NM
Temperature :	20 °C	Relative Humidity :	48%
Pressure :	1010 hPa	Test Voltage :	DC 5.0V
Test Mode :	CH6 (802.11g Mode)	Polarization :	Vertical

Frequency (MHz)	Meter Reading (dBμV)	Factor (dB)	Emission Level (dBμV/m)	Limits (dBμV/m)	Margin (dB)	Detector Type
4874	56.95	2.6	59.55	74	-14.45	peak
4874	37.74	2.6	40.34	54	-13.66	AVG
7311	49.09	4.93	54.02	74	-19.98	peak
7311	31.89	4.93	36.82	54	-17.18	AVG

Remark:  
 Factor = Antenna Factor + Cable Loss – Pre-amplifier.

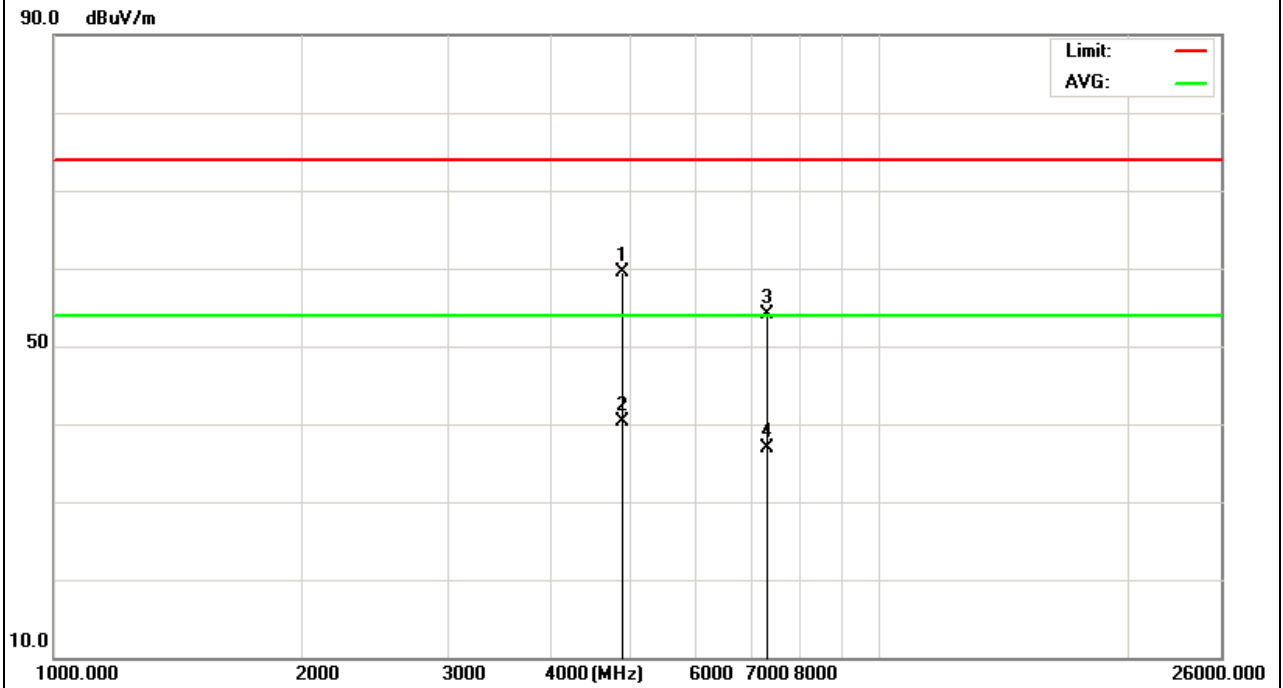

EUT :	150M WIRELESS USB MODULE	Model Name :	MT-WN713NM
Temperature :	20 °C	Relative Humidity :	48%
Pressure :	1010 hPa	Test Voltage :	DC 5.0V
Test Mode :	CH11 (802.11g Mode)	Polarization :	Horizontal

Frequency (MHz)	Meter Reading (dBμV)	Factor (dB)	Emission Level (dBμV/m)	Limits (dBμV/m)	Margin (dB)	Detector Type
4924	56.85	2.6	59.45	74	-14.55	peak
4924	39.06	2.6	41.66	54	-12.34	AVG
7386	48.45	4.93	53.38	74	-20.62	peak
7386	30.88	4.93	35.81	54	-18.19	AVG

Remark:  
Factor = Antenna Factor + Cable Loss – Pre-amplifier.

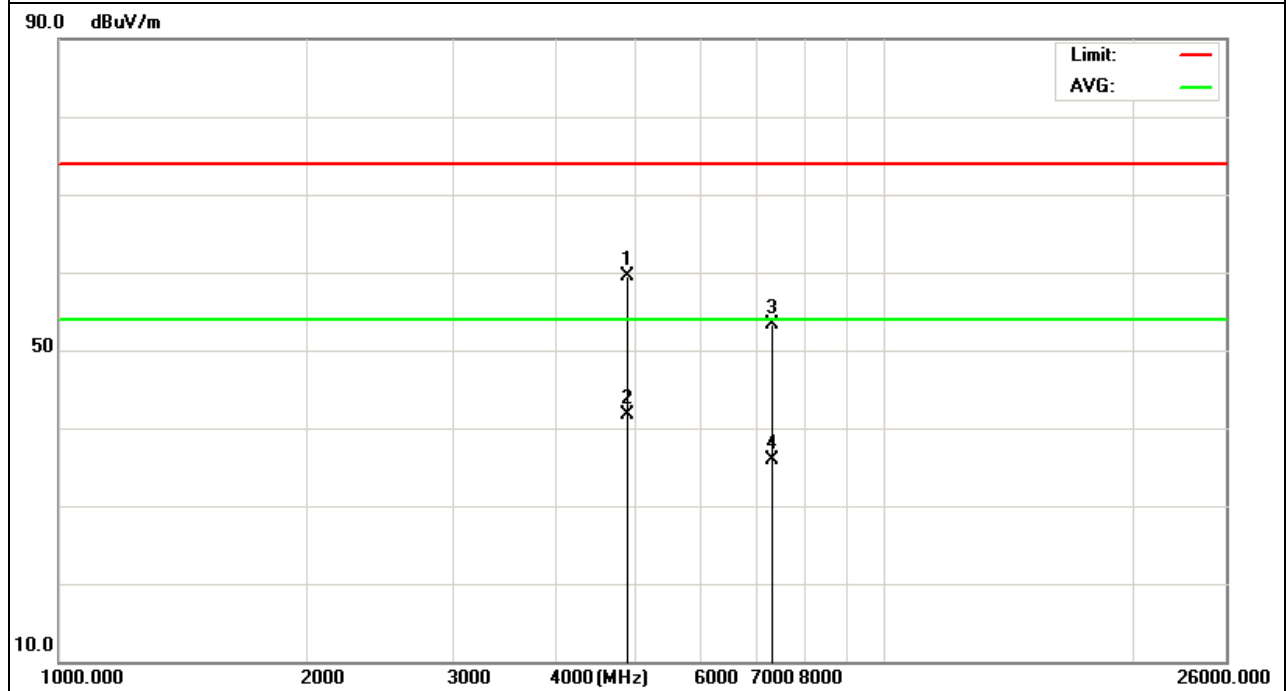

EUT :	150M WIRELESS USB MODULE	Model Name :	MT-WN713NM
Temperature :	20 °C	Relative Humidity :	48%
Pressure :	1010 hPa	Test Voltage :	DC 5.0V
Test Mode :	CH11(802.11g Mode)	Polarization :	Vertical

Frequency (MHz)	Meter Reading (dBμV)	Factor (dB)	Emission Level (dBμV/m)	Limits (dBμV/m)	Margin (dB)	Detector Type
4924	57.79	2.6	60.39	74	-13.61	peak
4924	40.02	2.6	42.62	54	-11.38	AVG
7386	51.22	4.83	56.05	74	-17.95	peak
7386	31.76	4.83	36.59	54	-17.41	AVG

Remark:  
Factor = Antenna Factor + Cable Loss – Pre-amplifier.

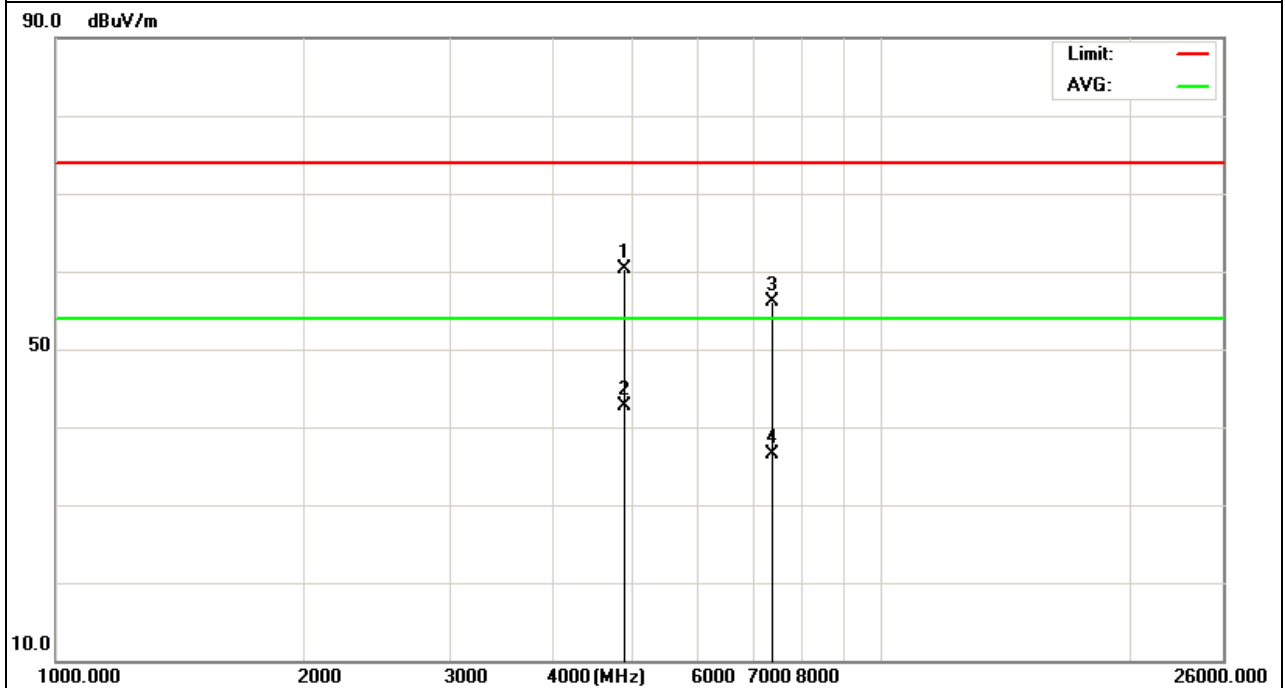

EUT :	150M WIRELESS USB MODULE	Model Name :	MT-WN713NM
Temperature :	20 °C	Relative Humidity :	48%
Pressure :	1010 hPa	Test Voltage :	DC 5.0V
Test Mode :	CH1 (802.11n/20M Mode)	Polarization :	Horizontal

Frequency (MHz)	Meter Reading (dBµV)	Factor (dB)	Emission Level (dBµV/m)	Limits (dBµV/m)	Margin (dB)	Detector Type
4824	59.33	2.6	61.93	74	-12.07	peak
4824	38.88	2.6	41.48	54	-12.52	AVG
7236	55.26	4.59	59.85	74	-14.15	peak
7236	39.67	4.59	44.26	54	-9.74	AVG

Remark:  
Factor = Antenna Factor + Cable Loss – Pre-amplifier.

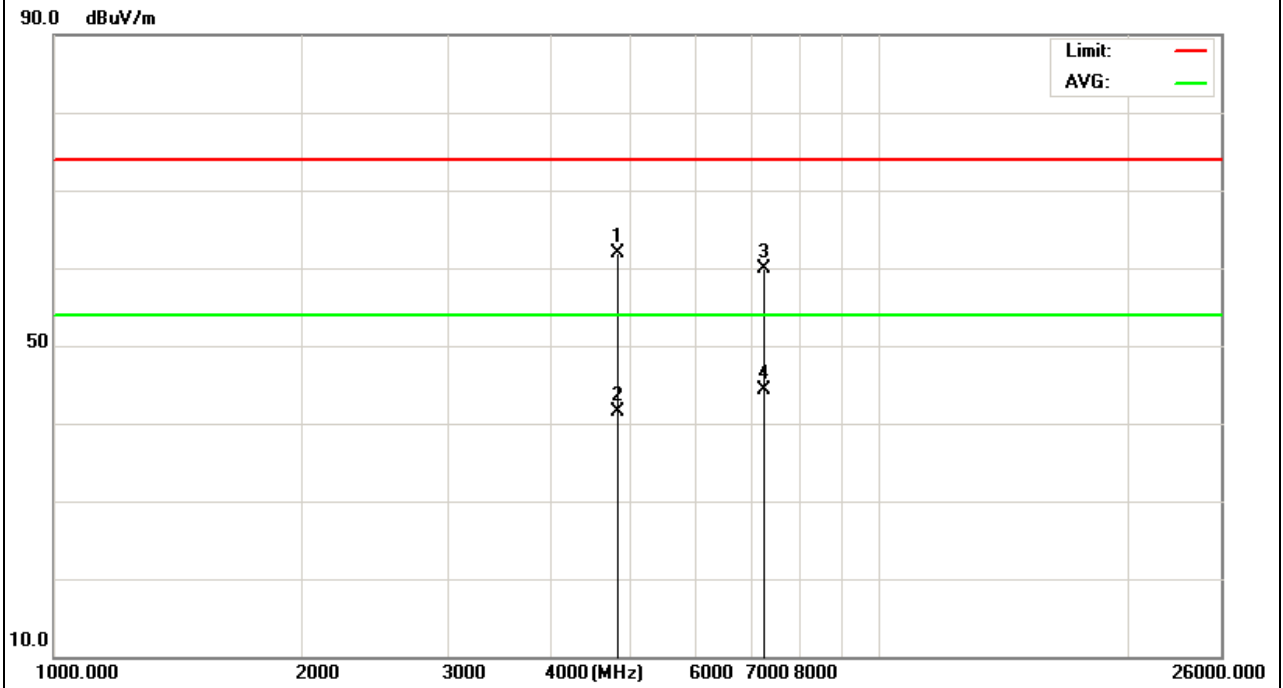

EUT :	150M WIRELESS USB MODULE	Model Name :	MT-WN713NM
Temperature :	20 °C	Relative Humidity :	48%
Pressure :	1010 hPa	Test Voltage :	DC 5.0V
Test Mode :	CH1 (802.11n/20M Mode)	Polarization :	Vertical

Frequency (MHz)	Meter Reading (dBµV)	Factor (dB)	Emission Level (dBµV/m)	Limits (dBµV/m)	Margin (dB)	Detector Type
4824	57.89	2.6	60.49	74	-13.51	peak
4824	38.87	2.6	41.47	54	-12.53	AVG
7236	51.69	4.59	56.28	74	-17.72	peak
7236	31.24	4.59	35.83	54	-18.17	AVG

Remark:  
Factor = Antenna Factor + Cable Loss – Pre-amplifier.

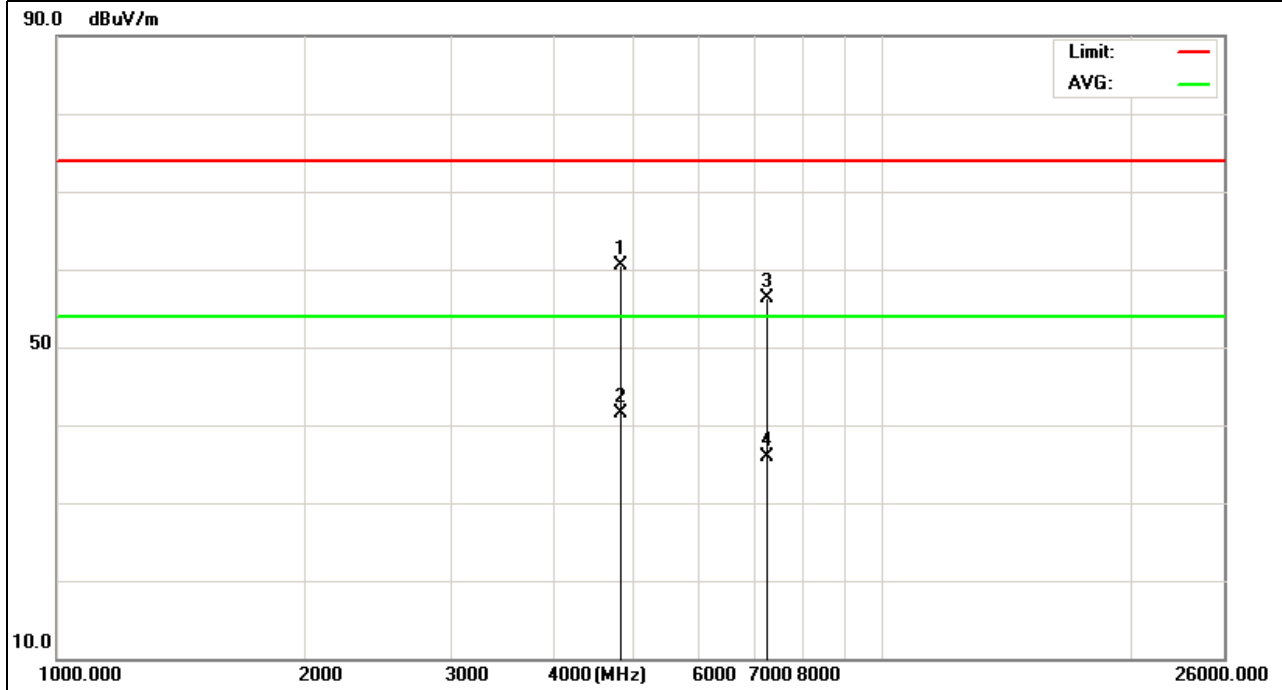

EUT :	150M WIRELESS USB MODULE	Model Name :	MT-WN713NM
Temperature :	20 °C	Relative Humidity :	48%
Pressure :	1010 hPa	Test Voltage :	DC 5.0V
Test Mode :	CH6 (802.11n/20M Mode)	Polarization :	Horizontal

Frequency (MHz)	Meter Reading (dBμV)	Factor (dB)	Emission Level (dBμV/m)	Limits (dBμV/m)	Margin (dB)	Detector Type
4874	61.66	2.6	64.26	74	-9.74	peak
4874	43.32	2.6	45.92	54	-8.08	AVG
7311	56.67	4.93	61.6	74	-12.4	peak
7311	37.36	4.93	42.29	54	-11.71	AVG

Remark:  
 Factor = Antenna Factor + Cable Loss – Pre-amplifier.

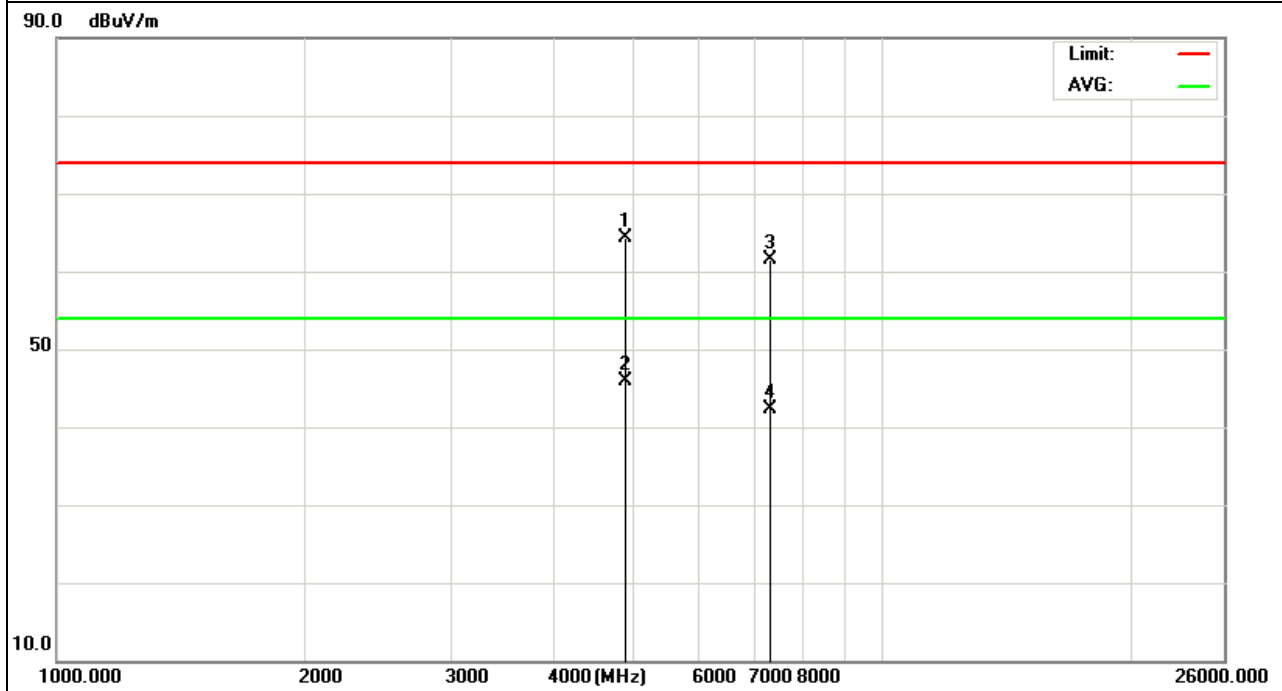

EUT :	150M WIRELESS USB MODULE	Model Name :	MT-WN713NM
Temperature :	20 °C	Relative Humidity :	48%
Pressure :	1010 hPa	Test Voltage :	DC 5.0V
Test Mode :	CH6 (802.11n/20M Mode)	Polarization :	Vertical

Frequency (MHz)	Meter Reading (dBμV)	Factor (dB)	Emission Level (dBμV/m)	Limits (dBμV/m)	Margin (dB)	Detector Type
4874	57.89	2.6	60.49	74	-13.51	peak
4874	42.42	2.6	45.02	54	-8.98	AVG
7311	51.55	4.93	56.48	74	-17.52	peak
7311	40.56	4.93	45.49	54	-8.51	AVG

Remark:

Factor = Antenna Factor + Cable Loss – Pre-amplifier.

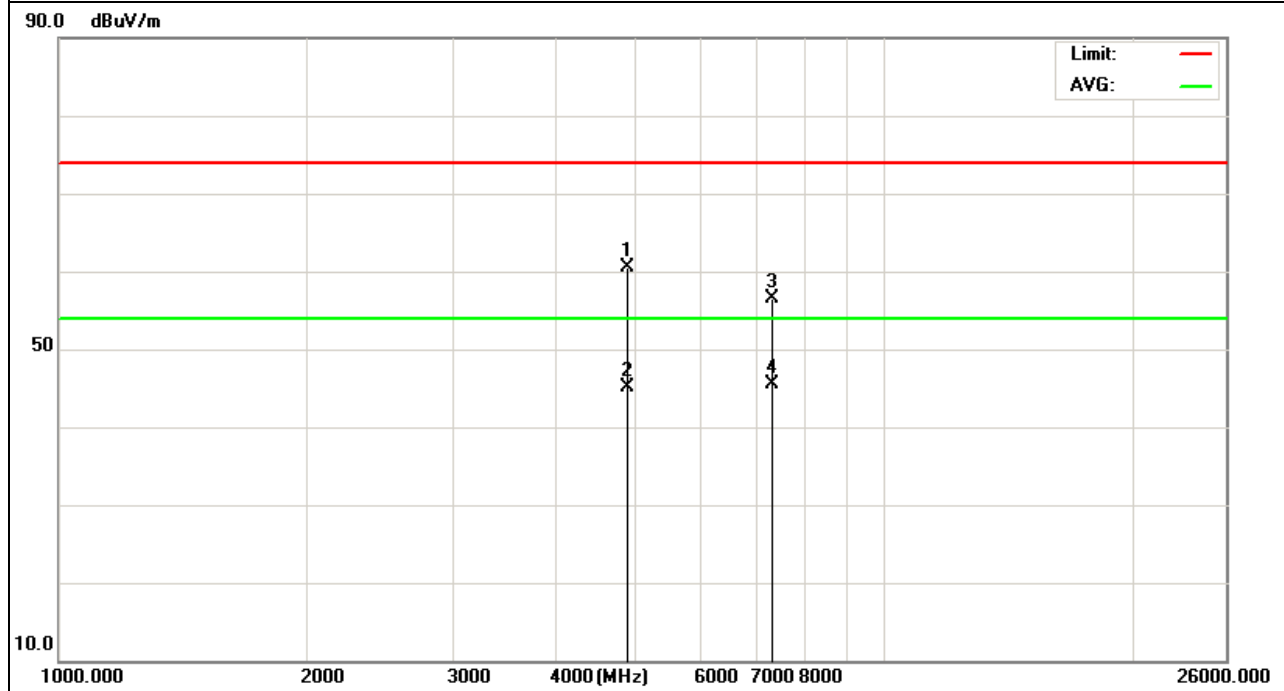

EUT :	150M WIRELESS USB MODULE	Model Name :	MT-WN713NM
Temperature :	20 °C	Relative Humidity :	48%
Pressure :	1010 hPa	Test Voltage :	DC 5.0V
Test Mode :	CH11 (802.11n/20M Mode)	Polarization :	Horizontal

Frequency (MHz)	Meter Reading (dBμV)	Factor (dB)	Emission Level (dBμV/m)	Limits (dBμV/m)	Margin (dB)	Detector Type
4924	57.89	2.64	60.53	74	-13.47	peak
4924	43.45	2.64	46.09	54	-7.91	AVG
7386	51.09	4.83	55.92	74	-18.08	peak
7386	40.44	4.83	45.27	54	-8.73	AVG

Remark:

- 3. Factor = Antenna Factor + Cable Loss – Pre-amplifier.
- 4. No emission detected above 18GHz

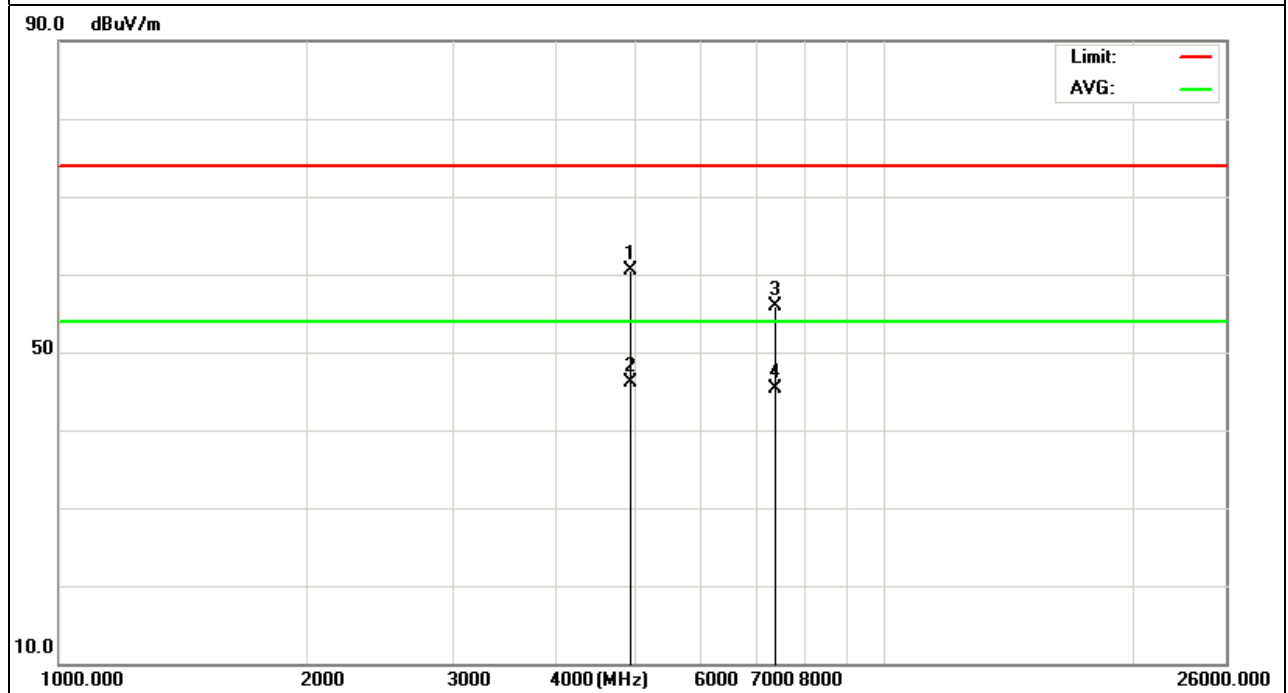



EUT :	150M WIRELESS USB MODULE	Model Name :	MT-WN713NM
Temperature :	20 °C	Relative Humidity :	48%
Pressure :	1010 hPa	Test Voltage :	DC 5.0V
Test Mode :	CH11 (802.11n/20M Mode)	Polarization :	Vertical

Frequency (MHz)	Meter Reading (dBμV)	Factor (dB)	Emission Level (dBμV/m)	Limits (dBμV/m)	Margin (dB)	Detector Type
4924	54.77	2.64	57.41	74	-16.59	peak
4924	37.76	2.64	40.4	54	-13.6	AVG
7386	45.88	4.83	50.71	74	-23.29	peak
7386	31.22	4.83	36.05	54	-17.95	AVG

Remark:  
 Factor = Antenna Factor + Cable Loss – Pre-amplifier.

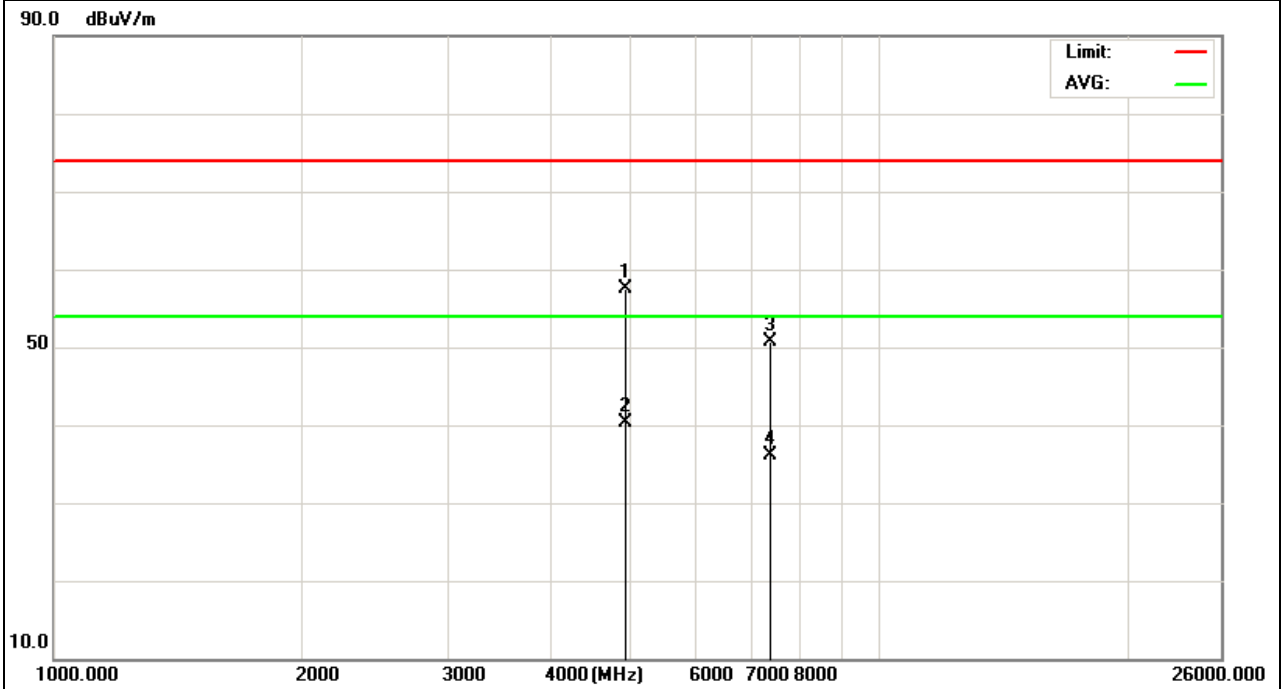

**Band Edge Emission:**

EUT :	150M WIRELESS USB MODULE	Model Name :	MT-WN713NM
Temperature :	20 °C	Relative Humidity :	48%
Pressure :	1010 hPa	Test Voltage :	DC 5.0V
Test Mode :	CH1(802.11b Mode)	Polarization :	Horizontal

Frequency (MHz)	Meter Reading (dBμV)	Factor (dB)	Emission Level (dBμV/m)	Limits (dBμV/m)	Margin (dB)	Detector Type
2398	80.47	-13	67.47	74	-6.53	peak
2398	58.87	-13	45.87	54	-8.13	AVG
2400	75.43	-12.99	62.44	74	-11.56	peak
2400	54.44	-12.99	41.45	54	-12.55	AVG

Remark:  
 Factor = Antenna Factor + Cable Loss – Pre-amplifier.

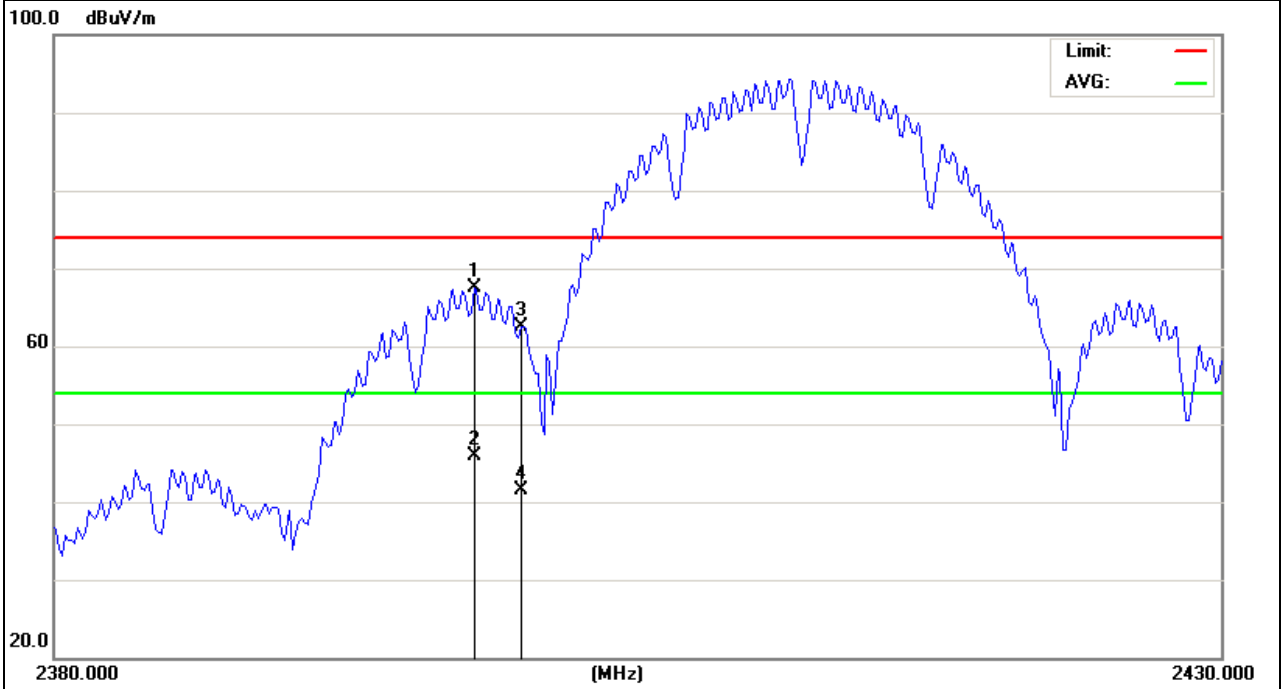

EUT :	150M WIRELESS USB MODULE	Model Name :	MT-WN713NM
Temperature :	20 °C	Relative Humidity :	48%
Pressure :	1010 hPa	Test Voltage :	DC 5.0V
Test Mode :	CH1(802.11b Mode)	Polarization :	Vertical

Frequency (MHz)	Meter Reading (dBμV)	Factor (dB)	Emission Level (dBμV/m)	Limits (dBμV/m)	Margin (dB)	Detector Type
2397.5	84.73	-13.01	71.72	74	-2.28	peak
2397.5	63.22	-13.01	50.21	54	-3.79	AVG
2400	78.53	-12.99	65.54	74	-8.46	peak
2400	57.57	-12.99	44.58	54	-9.42	AVG

Remark:  
Factor = Antenna Factor + Cable Loss – Pre-amplifier.

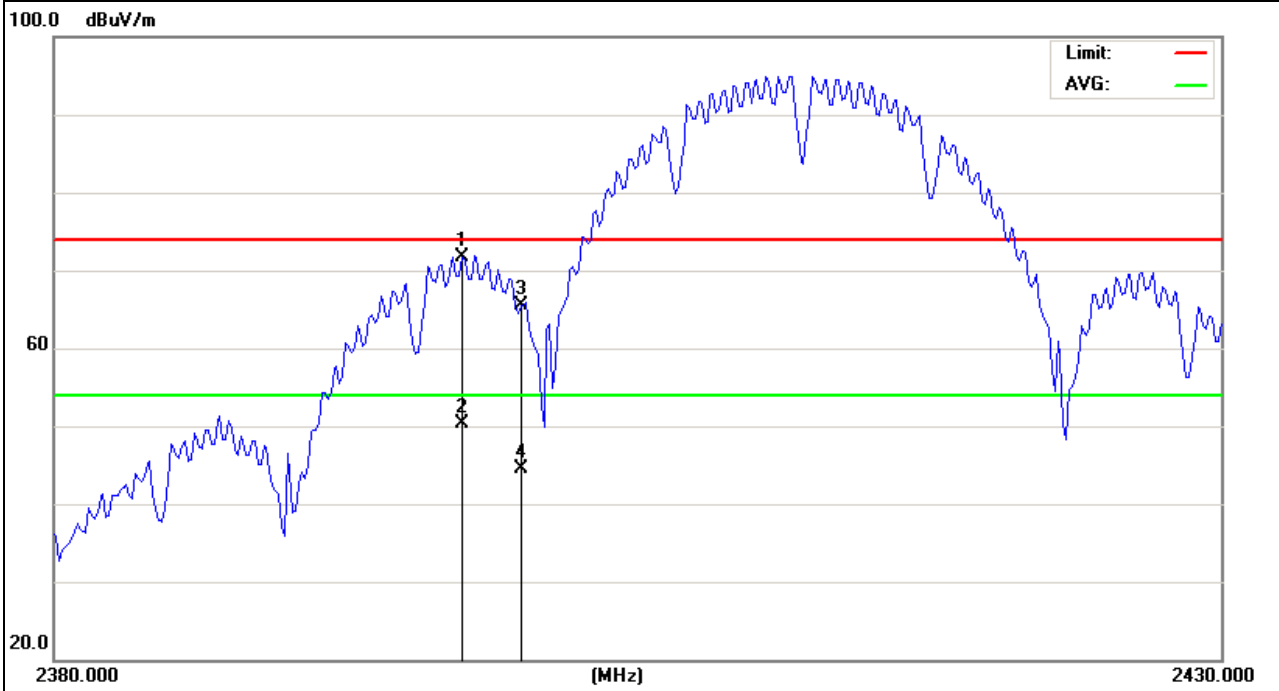

EUT :	150M WIRELESS USB MODULE	Model Name :	MT-WN713NM
Temperature :	20 °C	Relative Humidity :	48%
Pressure :	1010 hPa	Test Voltage :	DC 5.0V
Test Mode :	CH11(802.11b Mode)	Polarization :	Horizontal

Frequency (MHz)	Meter Reading (dBµV)	Factor (dB)	Emission Level (dBµV/m)	Limits (dBµV/m)	Margin (dB)	Detector Type
2483.5	63.61	-12.78	50.83	74	-23.17	peak

Remark:  
 Factor = Antenna Factor + Cable Loss – Pre-amplifier.

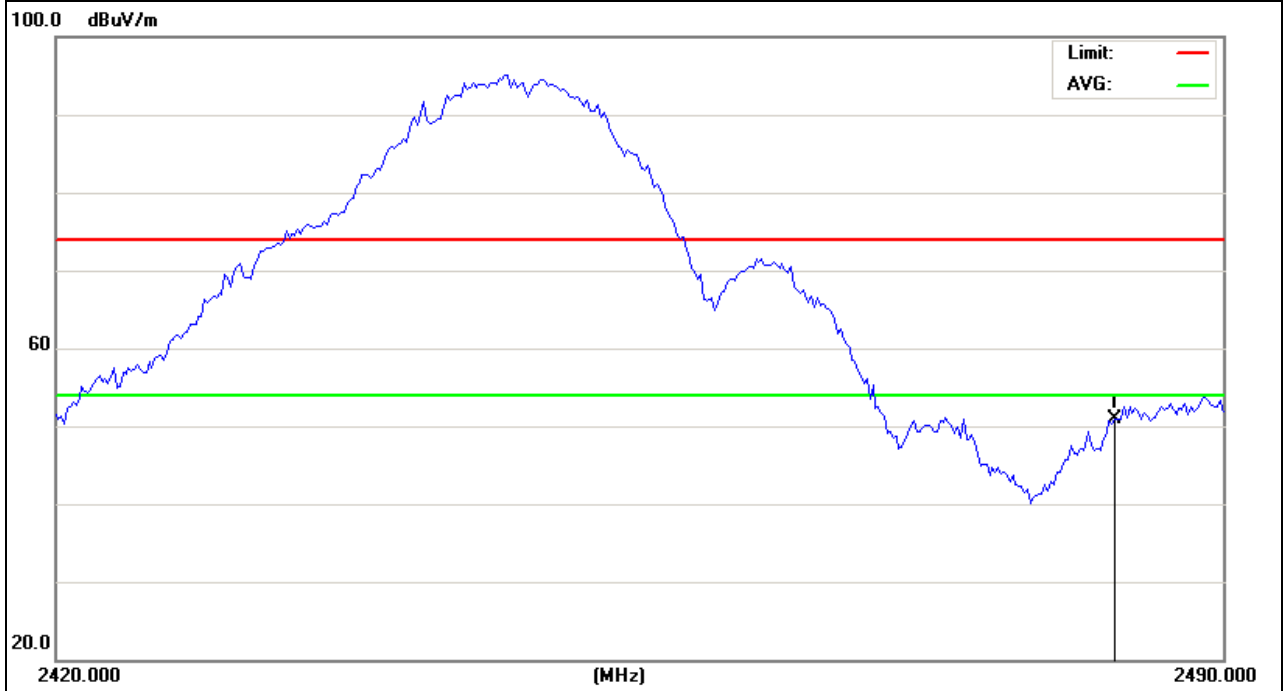

EUT :	150M WIRELESS USB MODULE	Model Name :	MT-WN713NM
Temperature :	20 °C	Relative Humidity :	48%
Pressure :	1010 hPa	Test Voltage :	DC 5.0V
Test Mode :	CH11(802.11b Mode)	Polarization :	Vertical

Frequency (MHz)	Meter Reading (dBμV)	Factor (dB)	Emission Level (dBμV/m)	Limits (dBμV/m)	Margin (dB)	Detector Type
2483.5	61.06	-12.78	48.28	74	-25.72	peak

Remark:  
Factor = Antenna Factor + Cable Loss – Pre-amplifier.

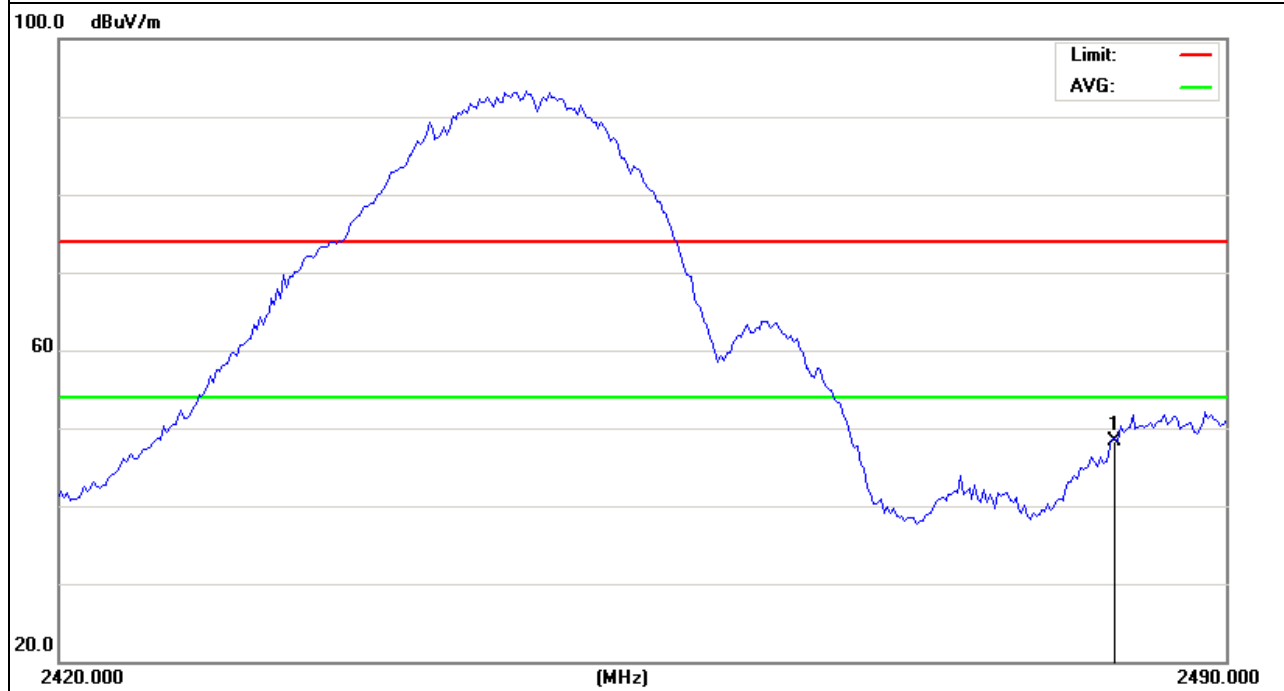

EUT :	150M WIRELESS USB MODULE	Model Name :	MT-WN713NM
Temperature :	20 °C	Relative Humidity :	48%
Pressure :	1010 hPa	Test Voltage :	DC 5.0V
Test Mode :	CH1(802.11g Mode)	Polarization :	Horizontal

Frequency (MHz)	Meter Reading (dBμV)	Factor (dB)	Emission Level (dBμV/m)	Limits (dBμV/m)	Margin (dB)	Detector Type
2400	80.81	-12.99	67.82	74	-6.18	peak
2400	60.96	-12.99	47.97	54	-6.03	AVG

Remark:  
Factor = Antenna Factor + Cable Loss – Pre-amplifier.

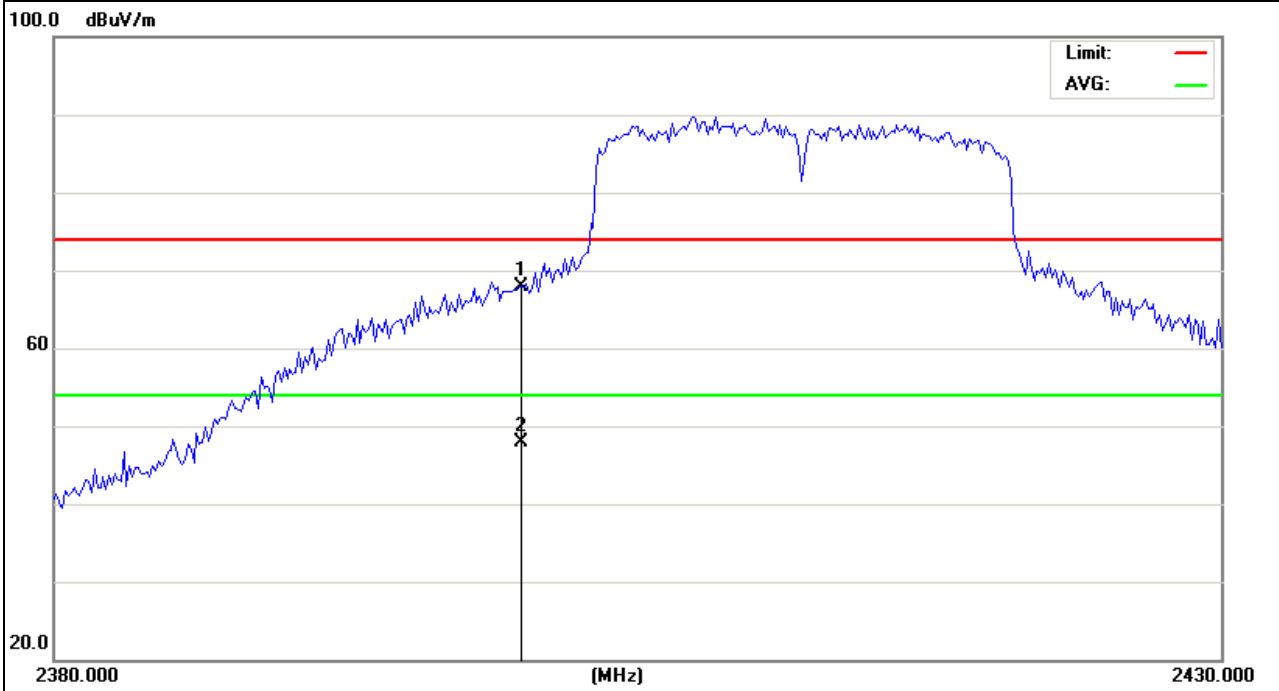

EUT :	150M WIRELESS USB MODULE	Model Name :	MT-WN713NM
Temperature :	20 °C	Relative Humidity :	48%
Pressure :	1010 hPa	Test Voltage :	DC 5.0V
Test Mode :	CH1(802.11g Mode)	Polarization :	Vertical

Frequency (MHz)	Meter Reading (dBμV)	Factor (dB)	Emission Level (dBμV/m)	Limits (dBμV/m)	Margin (dB)	Detector Type
2400	80.81	-12.99	67.82	74	-6.18	peak
2400	61.87	-12.99	48.88	54	-5.12	AVG

Remark:  
Factor = Antenna Factor + Cable Loss – Pre-amplifier.

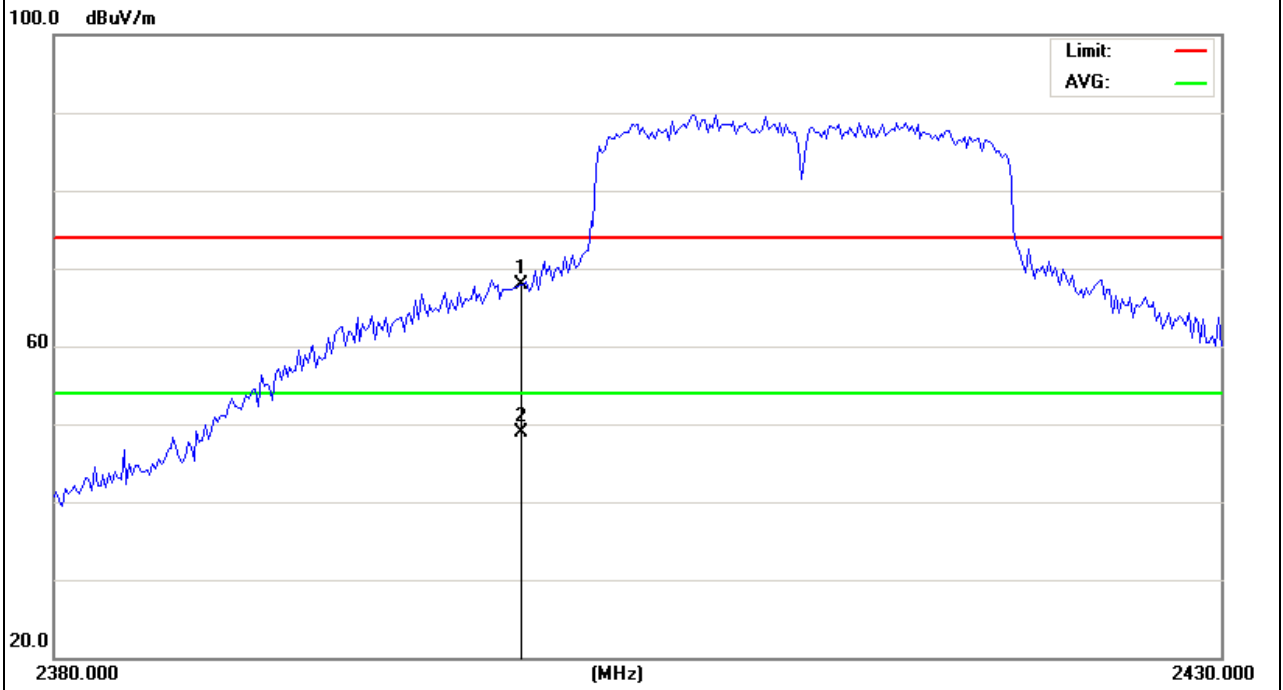

EUT :	150M WIRELESS USB MODULE	Model Name :	MT-WN713NM
Temperature :	20 °C	Relative Humidity :	48%
Pressure :	1010 hPa	Test Voltage :	DC 5.0V
Test Mode :	CH11(802.11g Mode)	Polarization :	Horizontal

Frequency (MHz)	Meter Reading (dBμV)	Factor (dB)	Emission Level (dBμV/m)	Limits (dBμV/m)	Margin (dB)	Detector Type
2483.5	58.1	-12.78	45.32	74	-28.68	peak

Remark:  
 Factor = Antenna Factor + Cable Loss – Pre-amplifier.

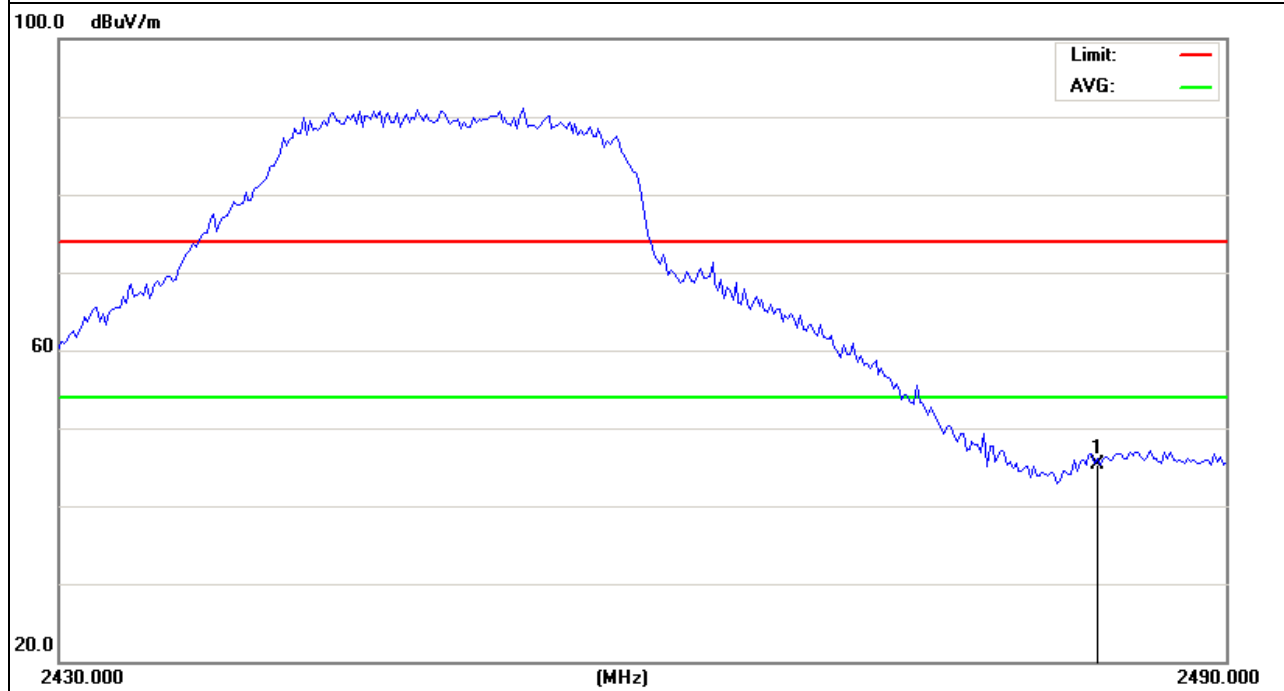



EUT :	150M WIRELESS USB MODULE	Model Name :	MT-WN713NM
Temperature :	20 °C	Relative Humidity :	48%
Pressure :	1010 hPa	Test Voltage :	DC 5.0V
Test Mode :	CH11(802.11g Mode)	Polarization :	Vertical

Frequency (MHz)	Meter Reading (dBμV)	Factor (dB)	Emission Level (dBμV/m)	Limits (dBμV/m)	Margin (dB)	Detector Type
2483.5	56.78	-12.78	44	74	-30	peak

Remark:  
Factor = Antenna Factor + Cable Loss – Pre-amplifier.

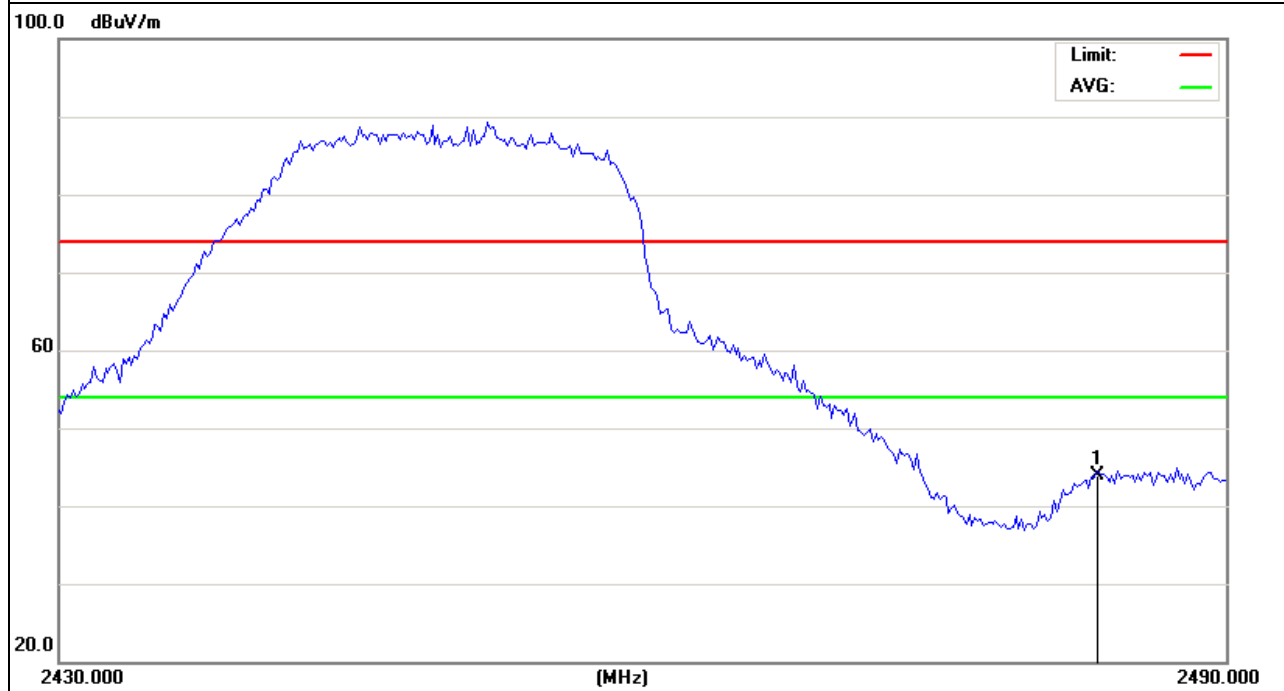

EUT :	150M WIRELESS USB MODULE	Model Name :	MT-WN713NM
Temperature :	20 °C	Relative Humidity :	48%
Pressure :	1010 hPa	Test Voltage :	DC 5.0V
Test Mode :	CH1(802.11n Mode/20MHz)	Polarization :	Horizontal

Frequency (MHz)	Meter Reading (dBμV)	Factor (dB)	Emission Level (dBμV/m)	Limits (dBμV/m)	Margin (dB)	Detector Type
2400	78.94	-12.99	65.95	74	-8.05	peak
2400	57.09	-12.99	44.1	54	-9.9	AVG

Remark:  
Factor = Antenna Factor + Cable Loss – Pre-amplifier.

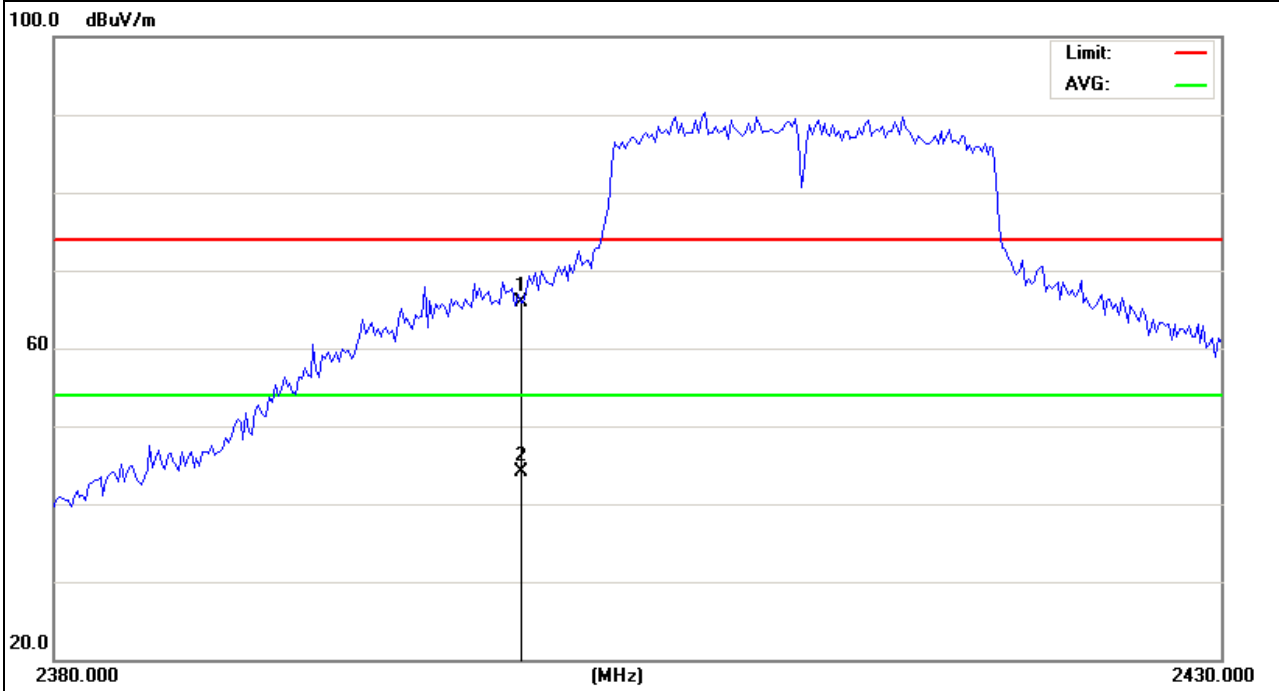

EUT :	150M WIRELESS USB MODULE	Model Name :	MT-WN713NM
Temperature :	20 °C	Relative Humidity :	48%
Pressure :	1010 hPa	Test Voltage :	DC 5.0V
Test Mode :	CH1(802.11n Mode/20MHz)	Polarization :	Vertical

Frequency (MHz)	Meter Reading (dBµV)	Factor (dB)	Emission Level (dBµV/m)	Limits (dBµV/m)	Margin (dB)	Detector Type
2400	73.97	-12.99	60.98	74	-13.02	peak
2400	55.22	-12.99	42.23	54	-11.77	AVG

Remark:  
Factor = Antenna Factor + Cable Loss – Pre-amplifier.

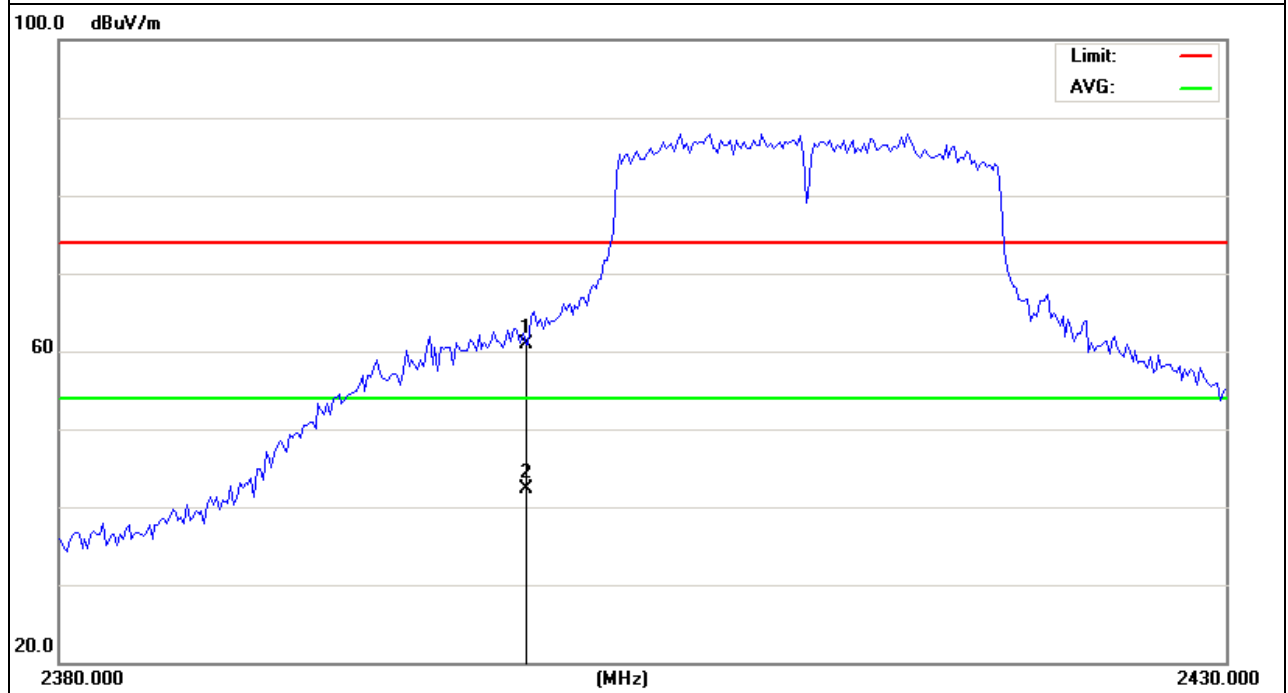

EUT :	150M WIRELESS USB MODULE	Model Name :	MT-WN713NM
Temperature :	20 °C	Relative Humidity :	48%
Pressure :	1010 hPa	Test Voltage :	DC 5.0V
Test Mode :	CH11(802.11n Mode/20MHz)	Polarization :	Horizontal

Frequency (MHz)	Meter Reading (dBμV)	Factor (dB)	Emission Level (dBμV/m)	Limits (dBμV/m)	Margin (dB)	Detector Type
2483.5	52.44	-12.78	39.66	74	-34.34	peak

Remark:  
Factor = Antenna Factor + Cable Loss – Pre-amplifier.

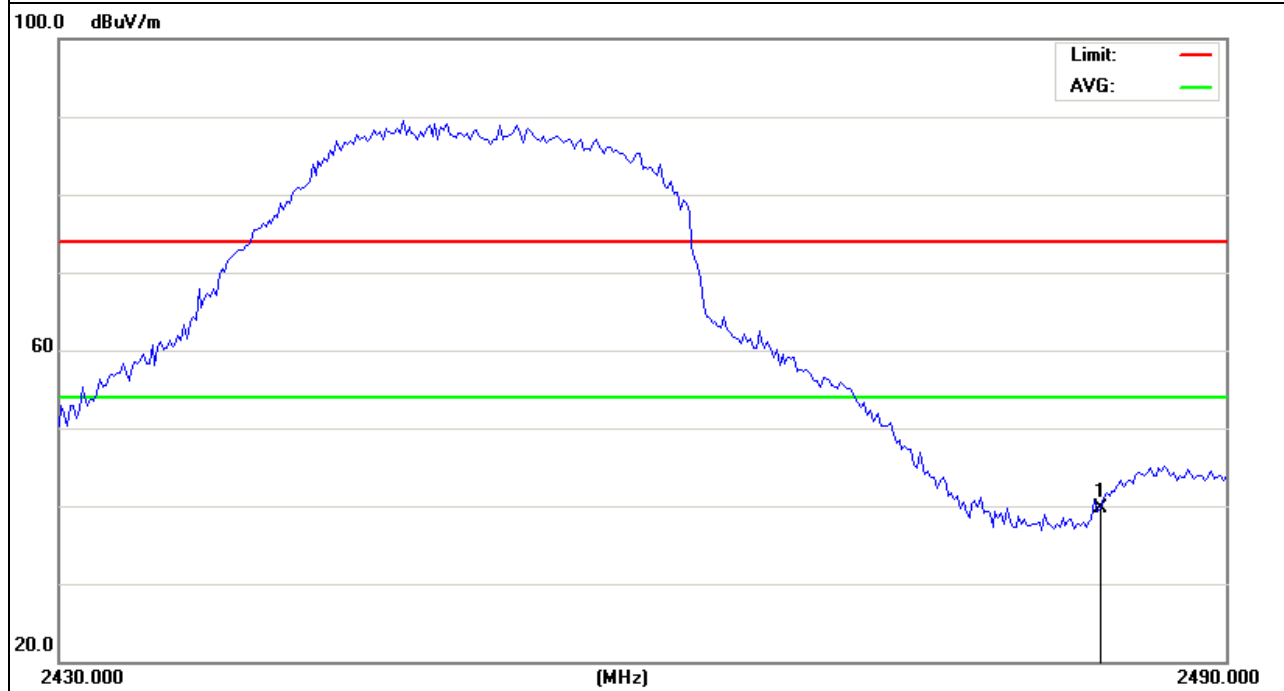

EUT :	150M WIRELESS USB MODULE	Model Name :	MT-WN713NM
Temperature :	20 °C	Relative Humidity :	48%
Pressure :	1010 hPa	Test Voltage :	DC 5.0V
Test Mode :	CH11(802.11n Mode/20MHz)	Polarization :	Vertical

Frequency (MHz)	Meter Reading (dBμV)	Factor (dB)	Emission Level (dBμV/m)	Limits (dBμV/m)	Margin (dB)	Detector Type
2483.55	58.31	-12.78	45.53	74	-28.47	peak

Remark:  
Factor = Antenna Factor + Cable Loss – Pre-amplifier.

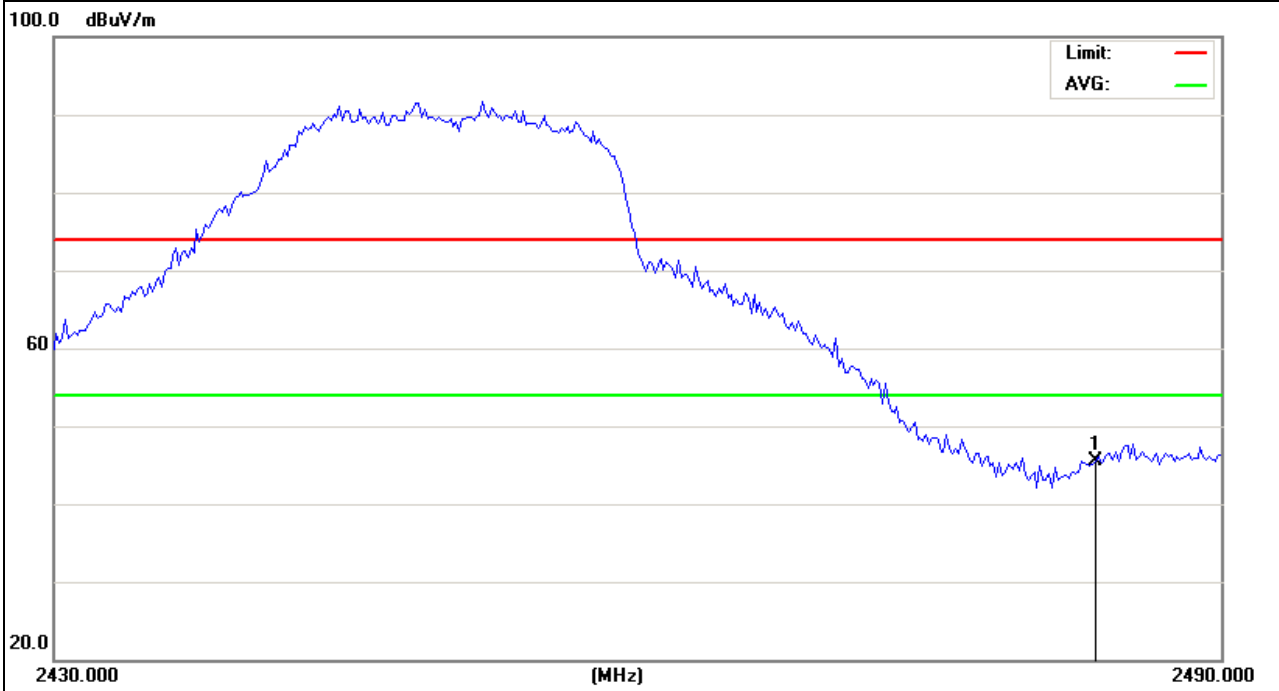

#### 4. POWER SPECTRAL DENSITY TEST

##### 4.1 APPLIED PROCEDURES / LIMIT

FCC Part15 (15.247) , Subpart C				
Section	Test Item	Limit	Frequency Range (MHz)	Result
15.247	Power Spectral Density	8 dBm (in any 3KHz)	2400-2483.5	PASS

##### 4.1.1 TEST PROCEDURE

1. The testing follows Measurement Procedure PKPSD of FCC KDB Publication No. 558074 D01 DTS Meas. Guidance v01.
2. The RF output of EUT was connected to the spectrum analyzer by a low loss cable. The path loss was compensated to the results for each measurement.
3. Record the measurement data derived from spectrum analyzer.
4. Make the measurement with the spectrum analyzer's resolution bandwidth (RBW) = 100 KHz. Video bandwidth (VBW) >= 300 KHz In order to make an accurate measurement, set the span to 5-30% greater than Emission Bandwidth (EBW)
5. Detector = peak, Sweep time = auto couple, Trace mode = max hold, Allow trace to fully stabilize. Use the peak marker function to determine the maximum power level in any 100 kHz band segment within the fundamental EBW.
6. Scale the observed power level to an equivalent value in 3 kHz by adjusting (reducing) the measured power by a bandwidth correction factor (BWCF) where  $BWCF = 10\log(3\text{ kHz}/100\text{ kHz}) = -15.2\text{ dB}$ .

##### 4.1.2 DEVIATION FROM STANDARD

No deviation.

##### 4.1.3 TEST SETUP



##### 4.1.4 EUT OPERATION CONDITIONS

The EUT tested system was configured as the statements of 2.1 Unless otherwise a special operating condition is specified in the follows during the testing.

### 4.1.5 TEST RESULTS

EUT :	150M WIRELESS USB MODULE	Model Name :	MT-WN713NM
Temperature :	25 °C	Relative Humidity :	60%
Pressure :	1015 hPa	Test Voltage :	DC 5.0V
Test Mode :	TX b Mode /CH01, CH06, CH11		

Frequency	Power Density (dBm)	PSD/3KHz (dBm)	Limit (dBm)	Result
2412 MHz	-0.31	-15.51	8	<b>PASS</b>
2437 MHz	-0.99	-16.19	8	<b>PASS</b>
2462 MHz	-1.46	-16.66	8	<b>PASS</b>

**Note:**

BWCF =  $10\log(3\text{ kHz}/100\text{ kHz}) = -15.2\text{ dB}$ .

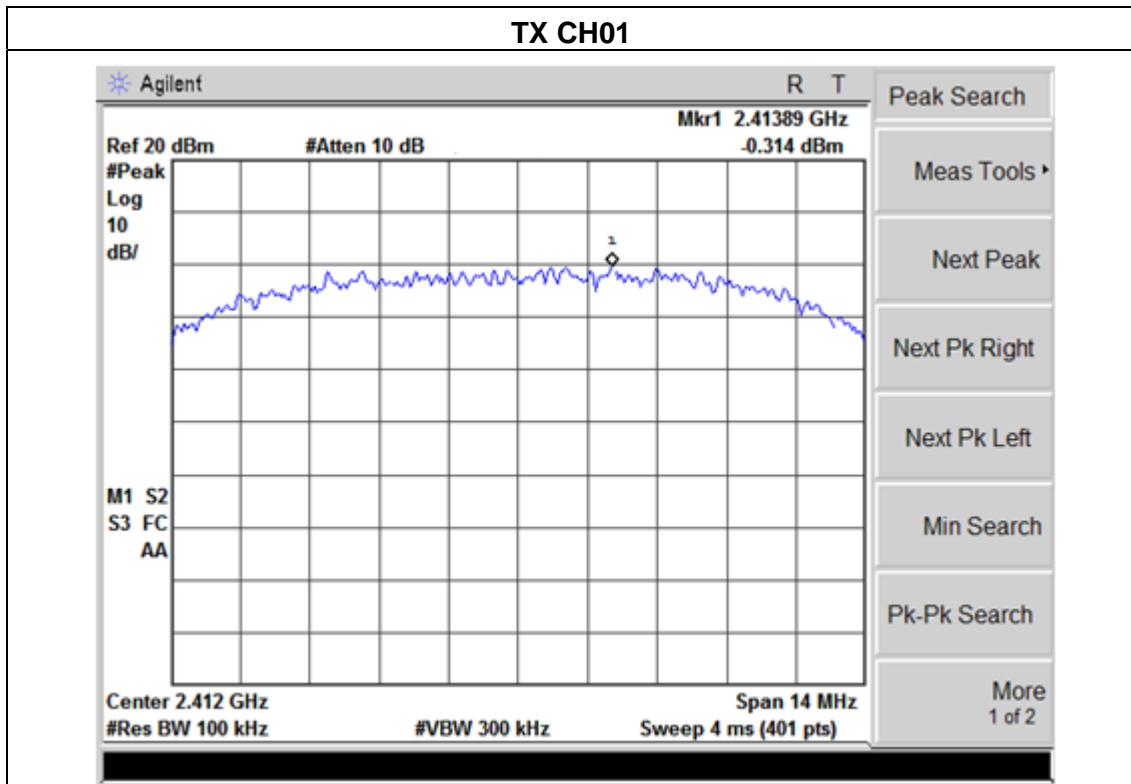

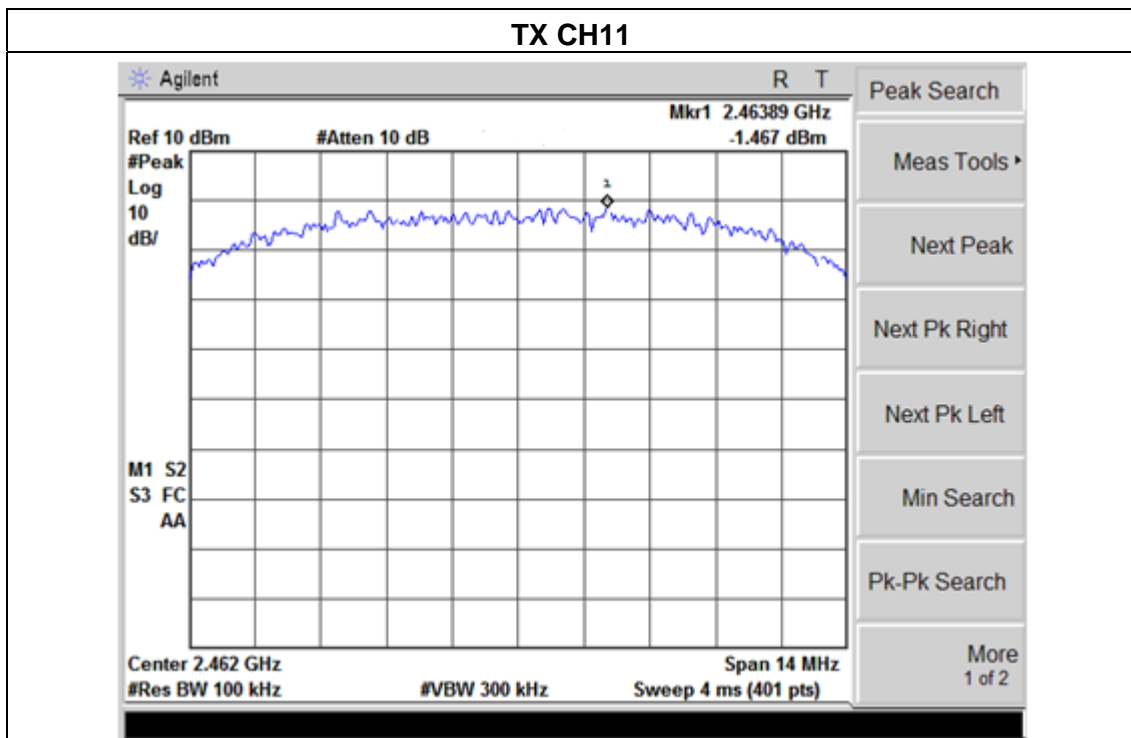
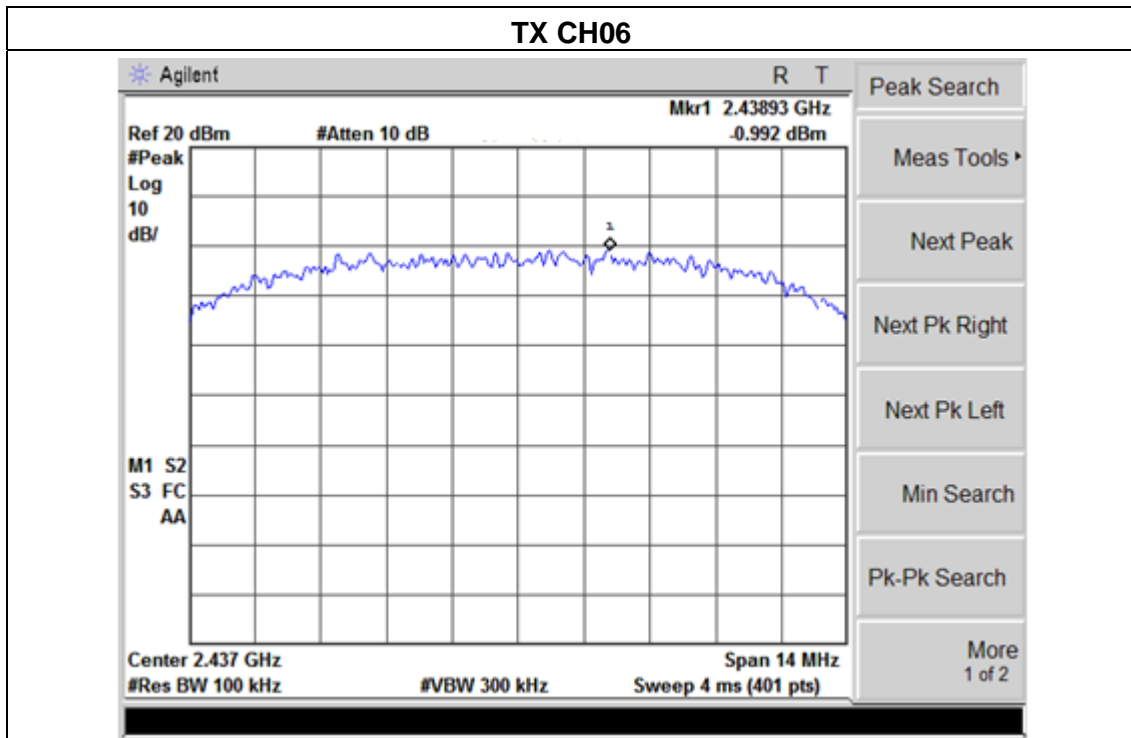



EUT :	150M WIRELESS USB MODULE	Model Name :	MT-WN713NM
Temperature :	25 °C	Relative Humidity :	60%
Pressure :	1015 hPa	Test Voltage :	DC 5.0V
Test Mode :	TX g Mode /CH01, CH06, CH11		

Frequency	Power Density (dBm)	PSD/3KHz (dBm)	Limit (dBm)	Result
2412 MHz	-4.90	-20.10	8	<b>PASS</b>
2437 MHz	-5.83	-21.03	8	<b>PASS</b>
2462 MHz	-6.28	-21.48	8	<b>PASS</b>

**Note:**

BWCF =  $10\log(3\text{ kHz}/100\text{ kHz}) = -15.2\text{ dB}$ .

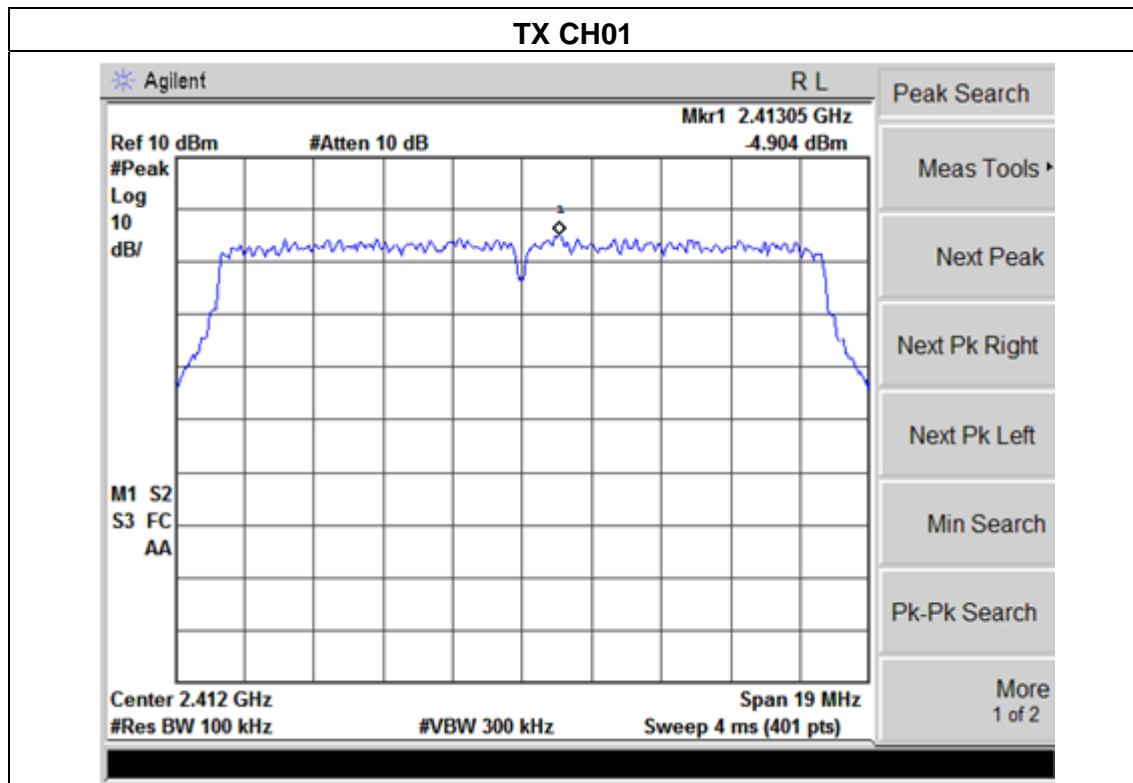

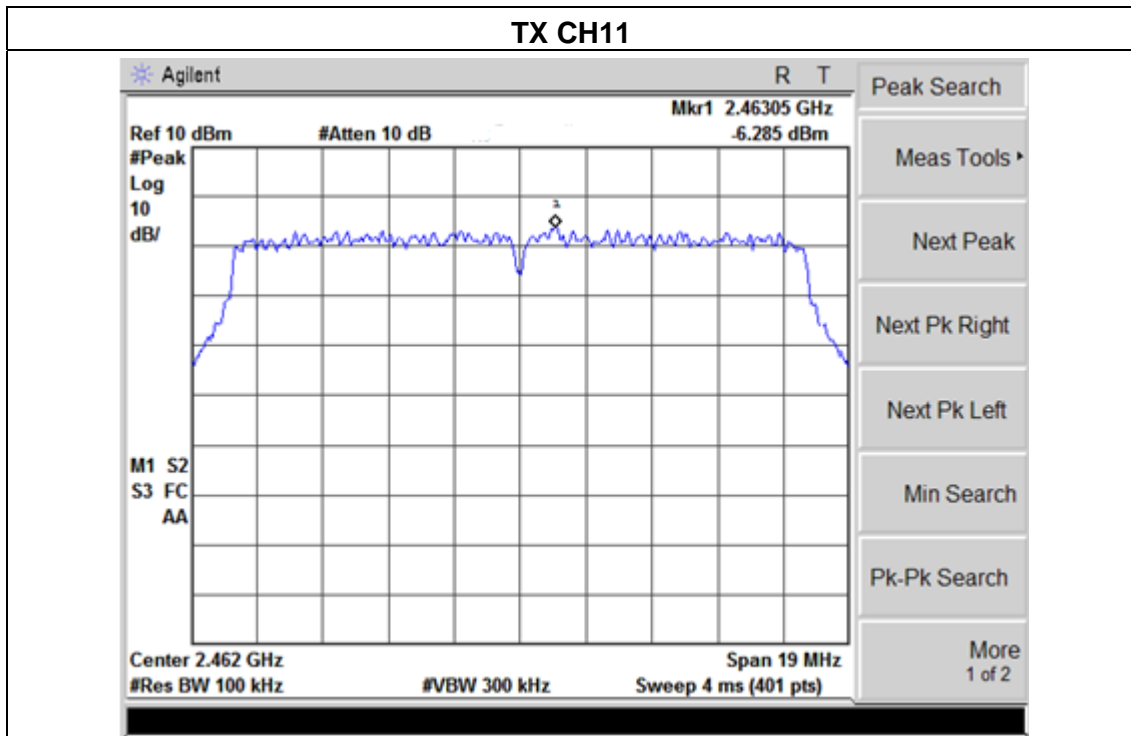
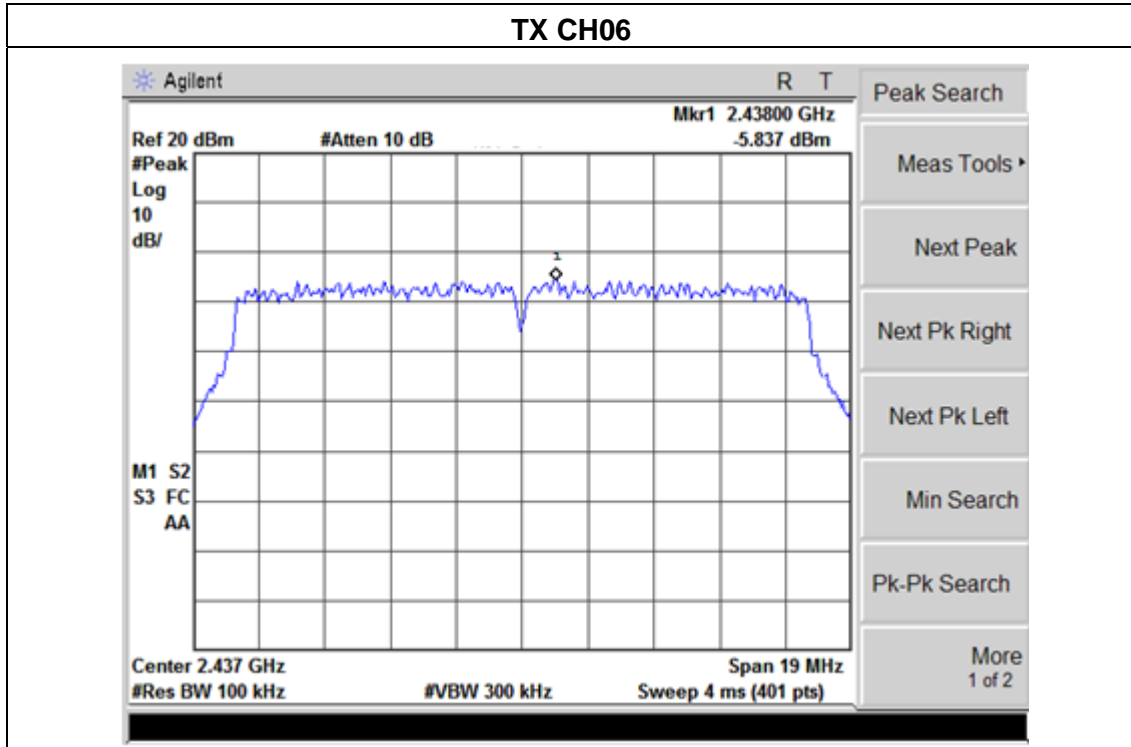

EUT :	150M WIRELESS USB MODULE	Model Name :	MT-WN713NM
Temperature :	25 °C	Relative Humidity :	60%
Pressure :	1015 hPa	Test Voltage :	DC 5.0V
Test Mode :	TX n Mode(20M) /CH01, CH06, CH11		

Frequency	Power Density (dBm)	PSD/3KHz (dBm)	Limit (dBm)	Result
2412 MHz	-5.56	-20.70	8	<b>PASS</b>
2437 MHz	-5.83	-21.03	8	<b>PASS</b>
2462 MHz	-6.28	-21.48	8	<b>PASS</b>

**Note:**

1. BWCF =  $10\log(3\text{ kHz}/100\text{ kHz}) = -15.2\text{ dB}$ .

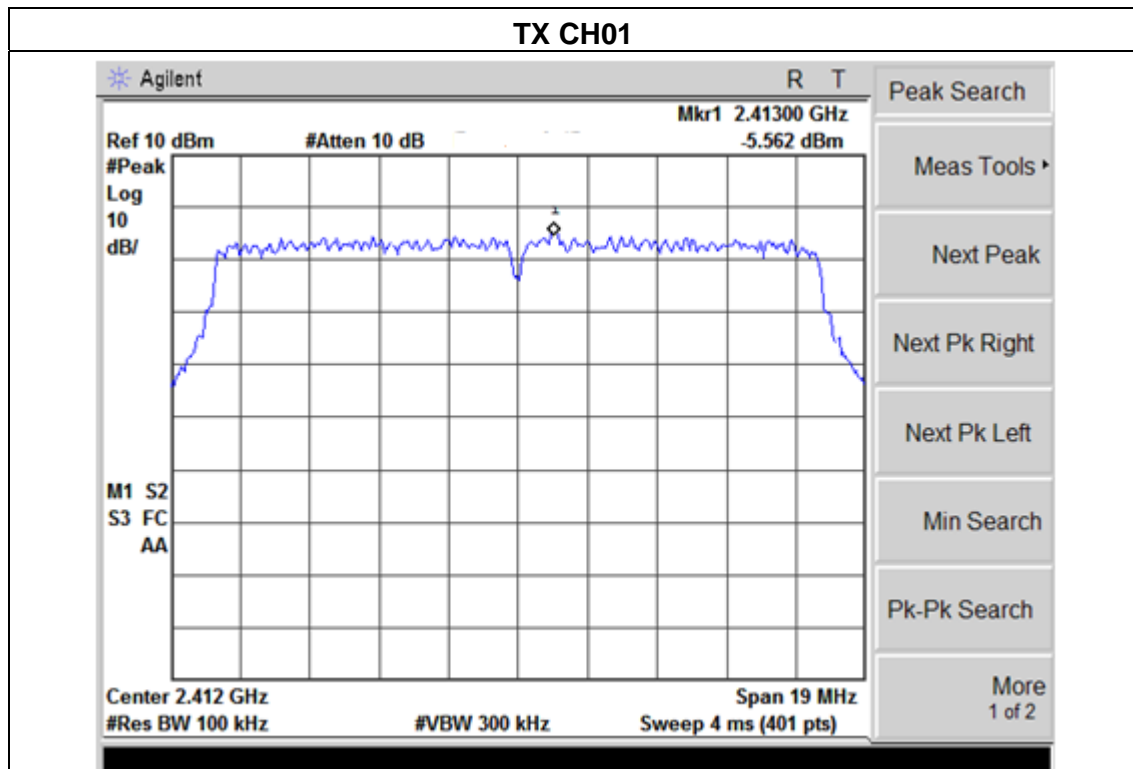

### TX CH06

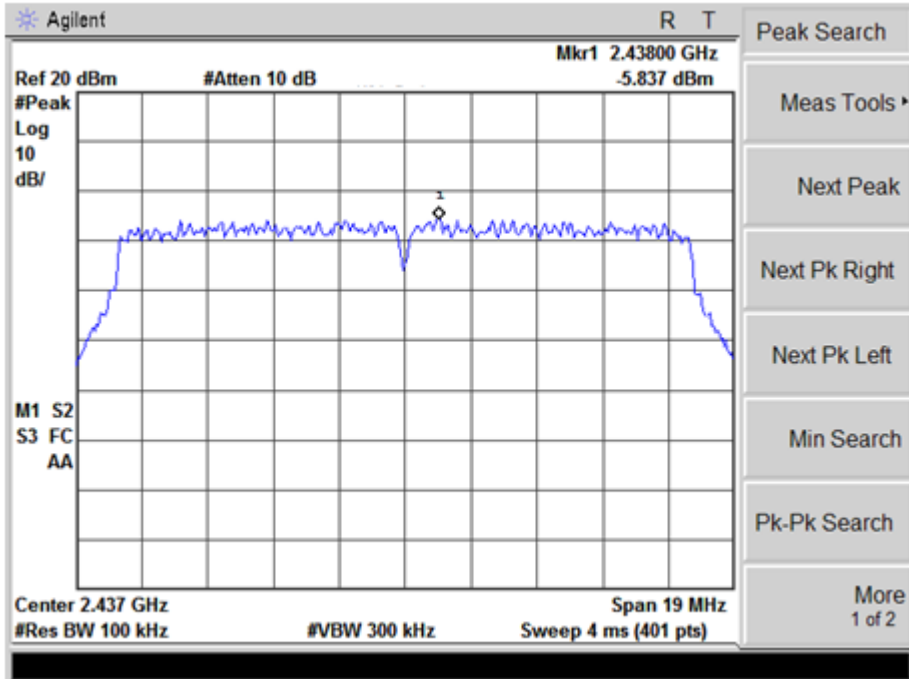

### TX CH11

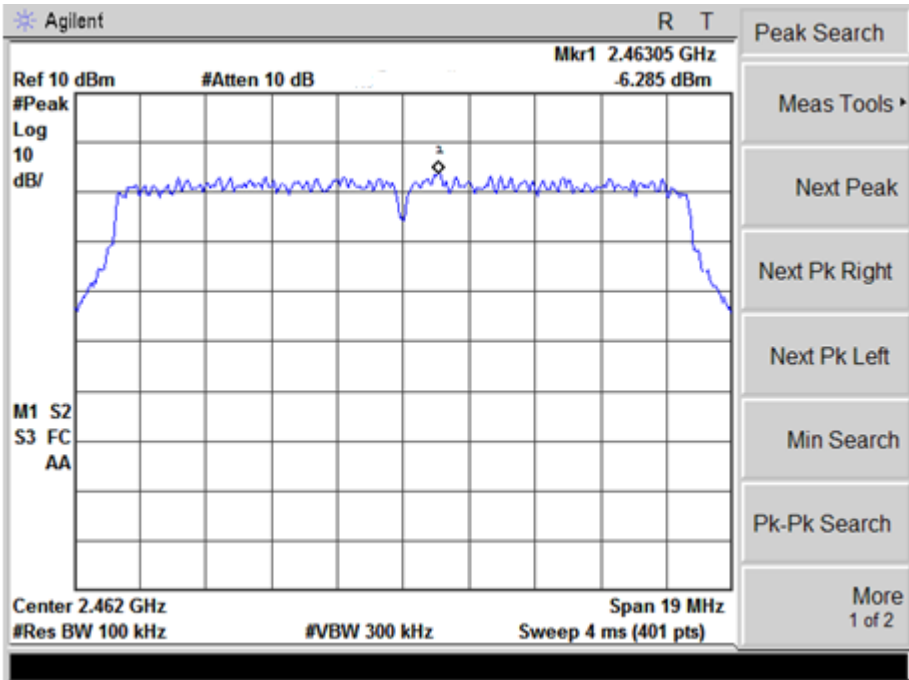

## 5. BANDWIDTH TEST

### 5.1 APPLIED PROCEDURES / LIMIT

FCC Part15 (15.247) , Subpart C				
Section	Test Item	Limit	Frequency Range (MHz)	Result
15.247(a)(2)	Bandwidth	$\geq 500\text{KHz}$ (6dB bandwidth)	2400-2483.5	PASS

Spectrum Parameter	Setting
Attenuation	Auto
Span Frequency	$>$ Measurement Bandwidth or Channel Separation
RB	30 kHz (20dB Bandwidth) / 100 kHz (Channel Separation)
VB	100 kHz (20dB Bandwidth) / 300 kHz (Channel Separation)
Detector	Peak
Trace	Max Hold
Sweep Time	Auto

#### 5.1.1 TEST PROCEDURE

- a.
1. The testing follows FCC KDB Publication No. 558074 D01 DTS Meas. Guidance v01.
  2. The RF output of EUT was connected to the spectrum analyzer by a low loss cable. The path loss was compensated to the results for each measurement.
  3. Make the measurement with the spectrum analyzer's resolution bandwidth (RBW) = 1-5% of the emission bandwidth (EBW). Set the Video bandwidth (VBW)  $\geq 3 * \text{RBW}$ . In order to make an accurate measurement. The 6 dB bandwidth must be greater than 500 KHz.
  4. The marker-delta reading at this point is the 6 dB bandwidth of the emission.

#### 5.1.2 DEVIATION FROM STANDARD

No deviation.

#### 5.1.3 TEST SETUP



#### 5.1.4 EUT OPERATION CONDITIONS

The EUT tested system was configured as the statements of 2.4 Unless otherwise a special operating condition is specified in the follows during the testing.

### 5.1.5 TEST RESULTS

EUT :	150M WIRELESS USB MODULE	Model Name :	MT-WN713NM
Temperature :	25 °C	Relative Humidity :	60%
Pressure :	1012 hPa	Test Voltage :	DC 5.0V
Test Mode :	TX b Mode /CH01, CH06, CH11		

Frequency	6dB Bandwidth (MHz)	99% Occupied BW (MHz)	Channel Separation (MHz)	Result
2412 MHz	11.54	14.01	>=500KHz	<b>PASS</b>
2437 MHz	11.54	14.07	>=500KHz	<b>PASS</b>
2462 MHz	11.66	14.05	>=500KHz	<b>PASS</b>

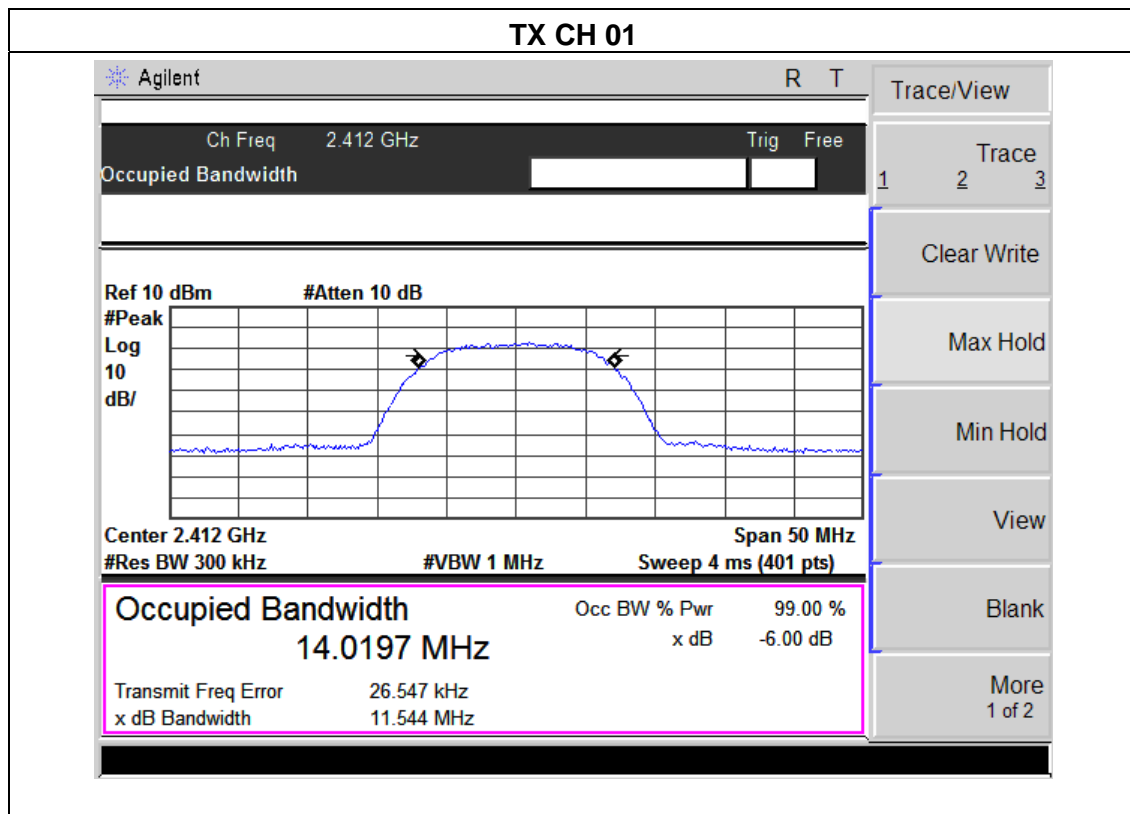

### TX CH 06

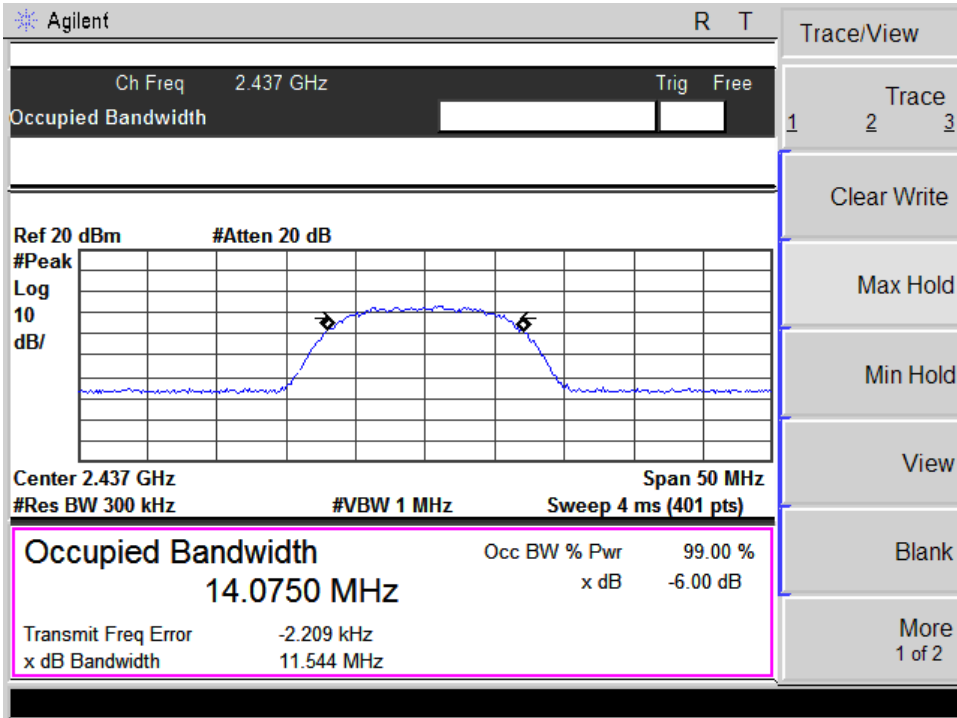

### TX CH 11

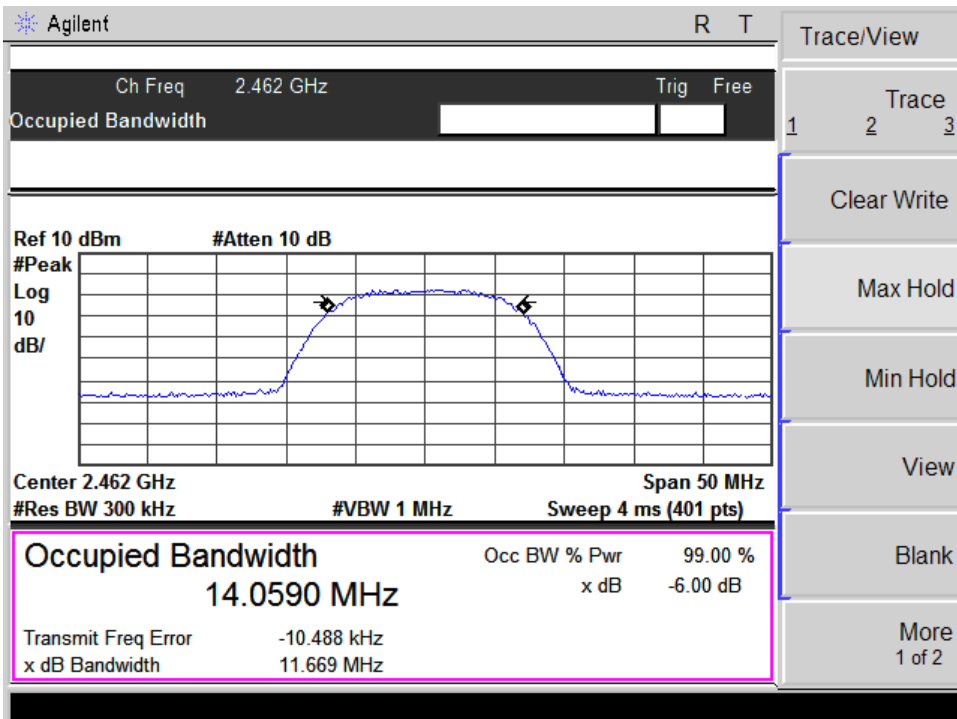

EUT :	150M WIRELESS USB MODULE	Model Name :	MT-WN713NM
Temperature :	25 °C	Relative Humidity :	60%
Pressure :	1012 hPa	Test Voltage :	DC 5.0V
Test Mode :	TX g Mode /CH01, CH06, CH11		

Frequency	6dB Bandwidth (MHz)	99% Occupied BW (MHz)	Channel Separation (MHz)	Result
2412 MHz	16.44	16.55	>=500KHz	<b>PASS</b>
2437 MHz	16.51	16.55	>=500KHz	<b>PASS</b>
2462 MHz	16.61	16.54	>=500KHz	<b>PASS</b>

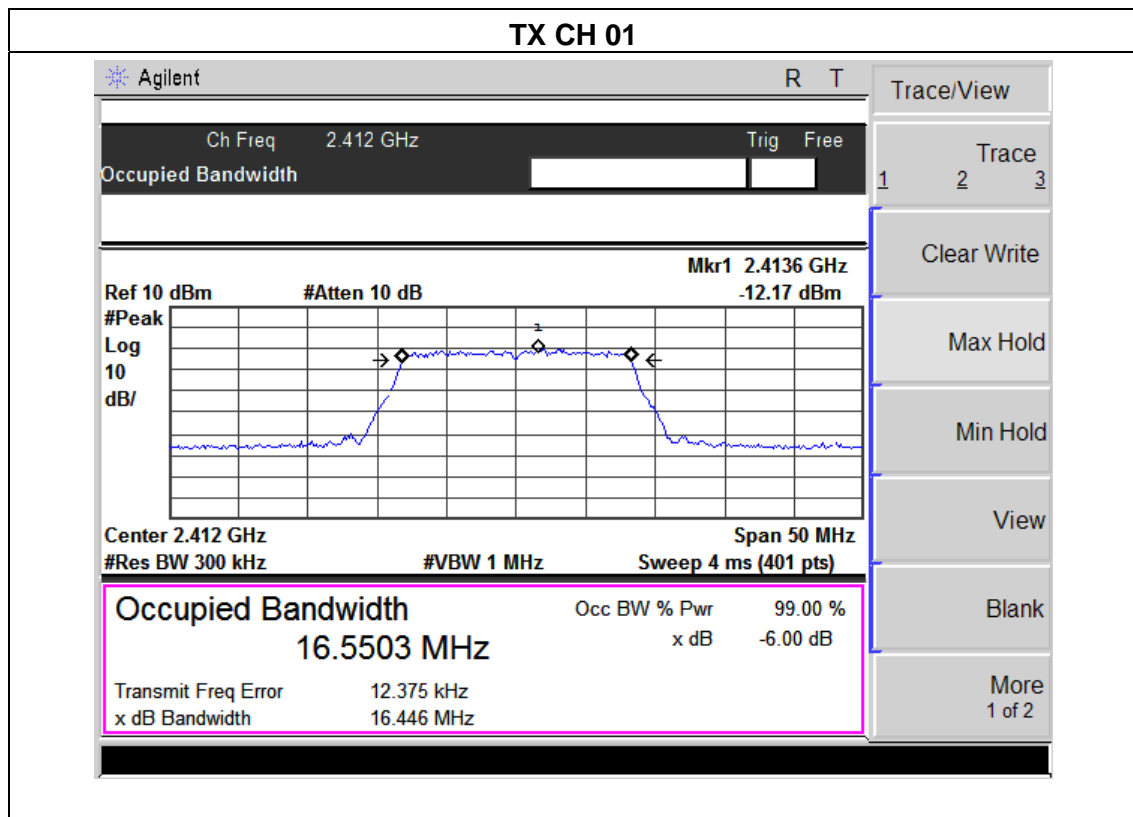



### TX CH 06

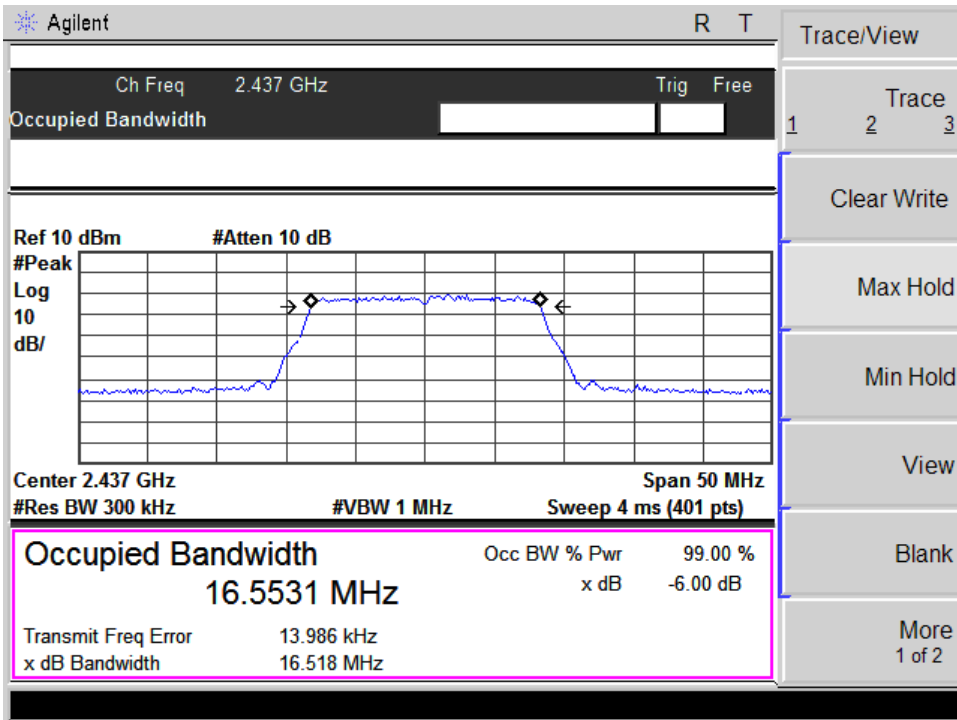

### TX CH 11

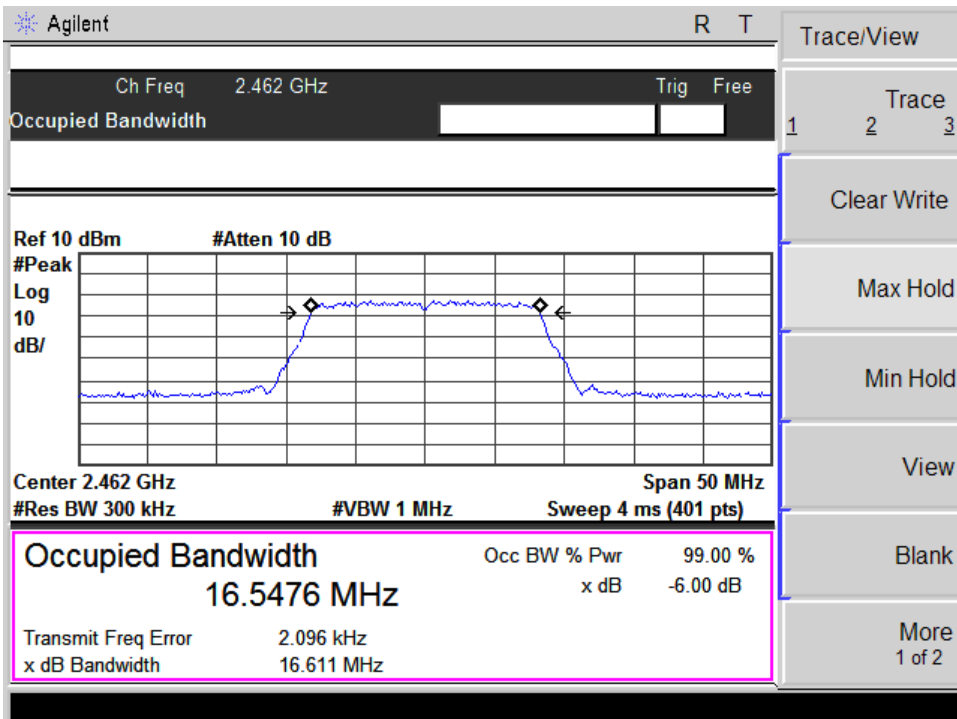

EUT :	150M WIRELESS USB MODULE	Model Name :	MT-WN713NM
Temperature :	25 °C	Relative Humidity :	60%
Pressure :	1012 hPa	Test Voltage :	DC 5.0V
Test Mode :	TX n Mode(20M) /CH01, CH06, CH11		

Frequency	6dB Bandwidth (MHz)	99% Occupied BW (MHz)	Channel Separation (MHz)	Result
2412 MHz	17.42	17.46	>=500KHz	<b>PASS</b>
2437 MHz	17.44	17.49	>=500KHz	<b>PASS</b>
2462 MHz	17.43	17.50	>=500KHz	<b>PASS</b>

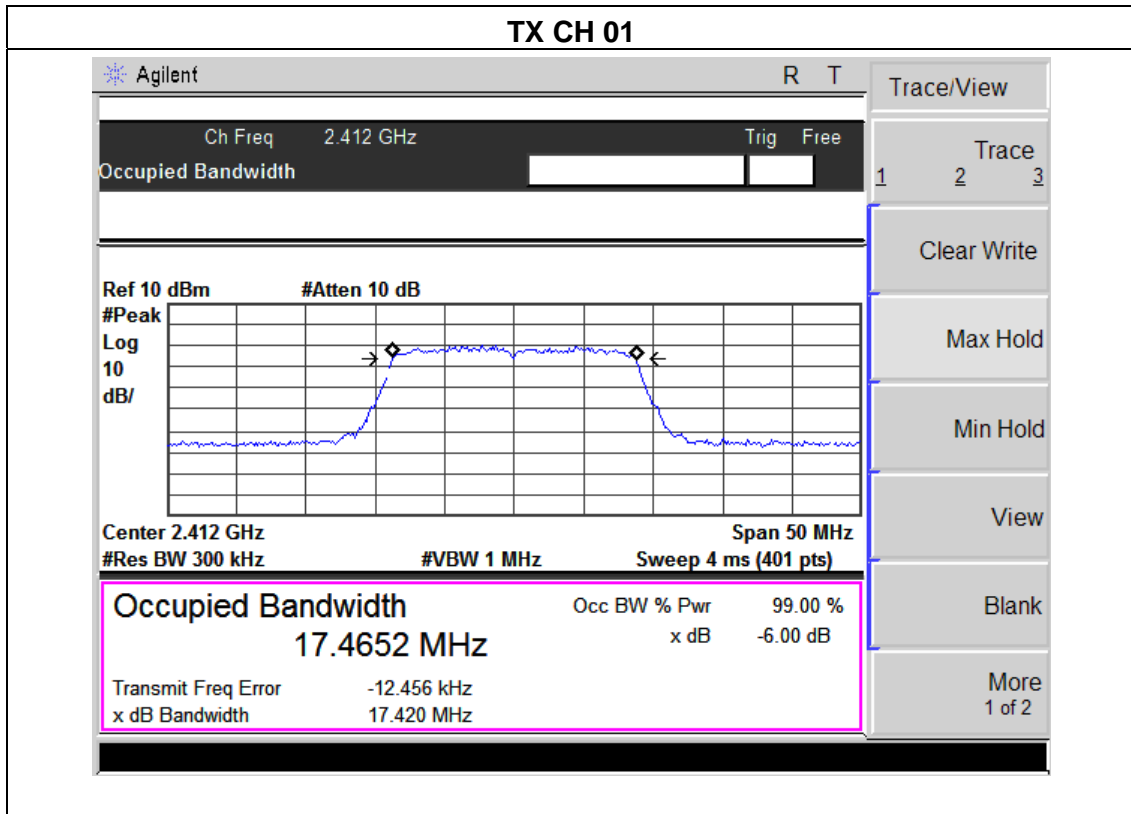

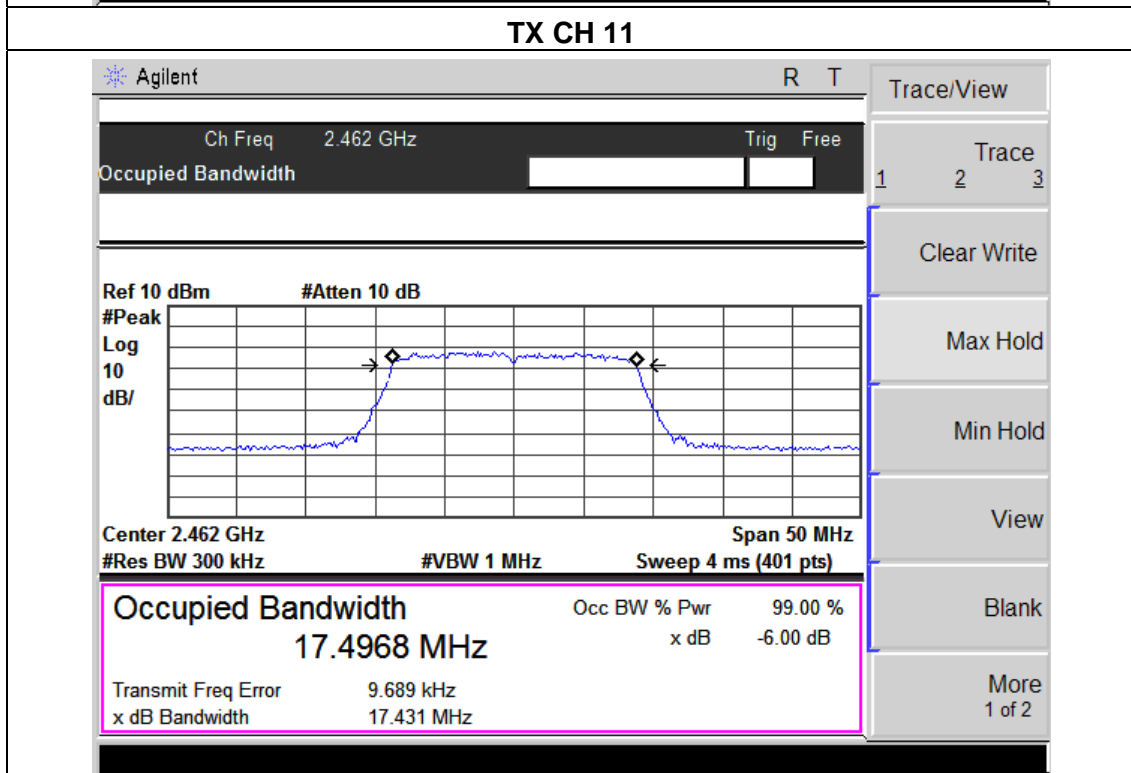
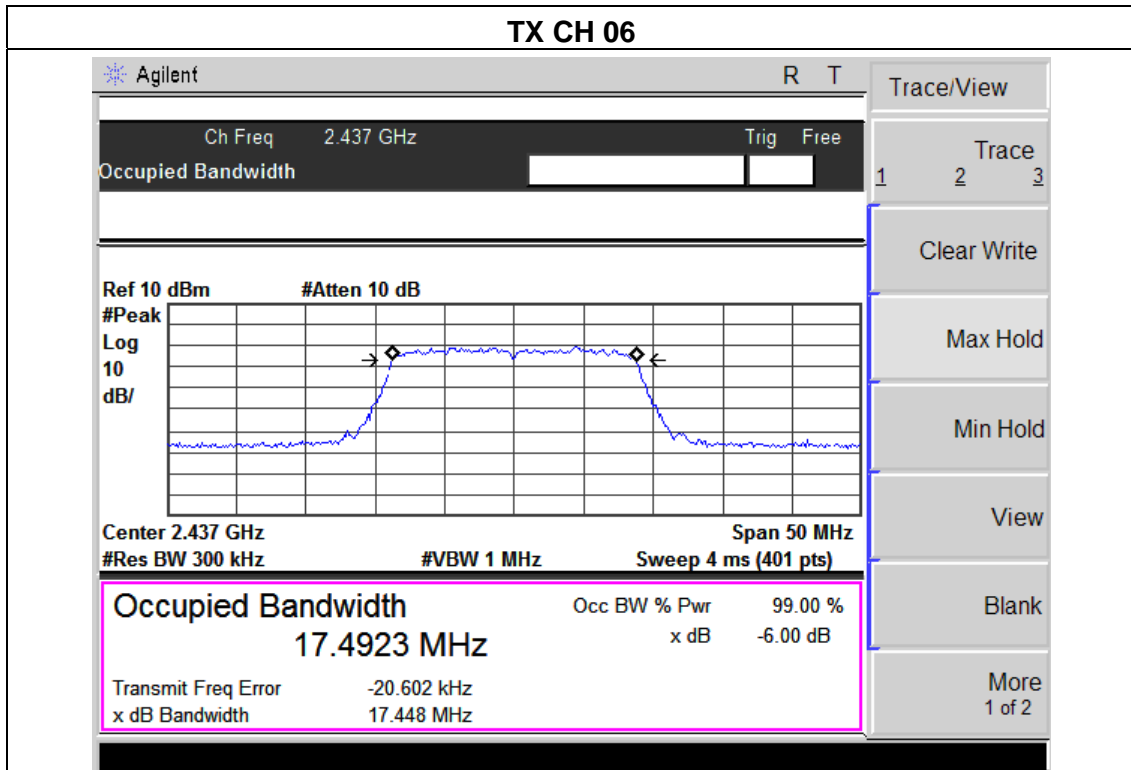

**6. PEAK OUTPUT POWER TEST**

**6.1 APPLIED PROCEDURES / LIMIT**

FCC Part15 (15.247) , Subpart C				
Section	Test Item	Limit	Frequency Range (MHz)	Result
15.247(b)(3)	Peak Output Power	1 watt or 30dBm	2400-2483.5	PASS

**6.1.1 TEST PROCEDURE**

- a. The EUT was directly connected to the Power meter

**6.1.2 DEVIATION FROM STANDARD**

No deviation.

**6.1.3 TEST SETUP**



**6.1.4 EUT OPERATION CONDITIONS**

The EUT tested system was configured as the statements of 2.4 Unless otherwise a special operating condition is specified in the follows during the testing.

**6.1.5 TEST RESULTS**

EUT :	150M WIRELESS USB MODULE	Model Name :	MT-WN713NM
Temperature :	25 °C	Relative Humidity :	60%
Pressure :	1012 hPa	Test Voltage :	DC 5.0V
Test Mode :	TX b/g/n(20M) Mode /CH01, CH06, CH11		

<b>TX 802.11b Mode</b>					
Test Channe	Frequency	Peak output power. Antenna port	Antenna Gain	EIRP	LIMIT
	(MHz)	(dBm)	dBi	dBm	dBm
CH01	2412	16.23	1.3	17.53	30
CH06	2437	16.08	1.3	17.38	30
CH11	2462	<b>16.54</b>	1.3	<b>17.84</b>	30
<b>TX 802.11g Mode</b>					
CH01	2412	14.46	1.3	15.76	30
CH06	2437	14.51	1.3	15.81	30
CH11	2462	14.71	1.3	16.01	30
<b>TX 802.11n/20M Mode</b>					
CH01	2412	14.38	1.3	15.68	30
CH06	2437	14.37	1.3	15.67	30
CH11	2462	14.56	1.3	15.86	30

## **7. ANTENNA REQUIREMENT**

### **7.1 STANDARD REQUIREMENT**

15.203 requirement: For intentional device, according to 15.203: an intentional radiator shall be designed to ensure that no antenna other than that furnished by the responsible party shall be used with the device.

### **7.2 EUT ANTENNA**

The EUT antenna is PCB antenna. It comply with the standard requirement.

**8. EUT TEST PHOTO**

**Radiated Measurement Photos**

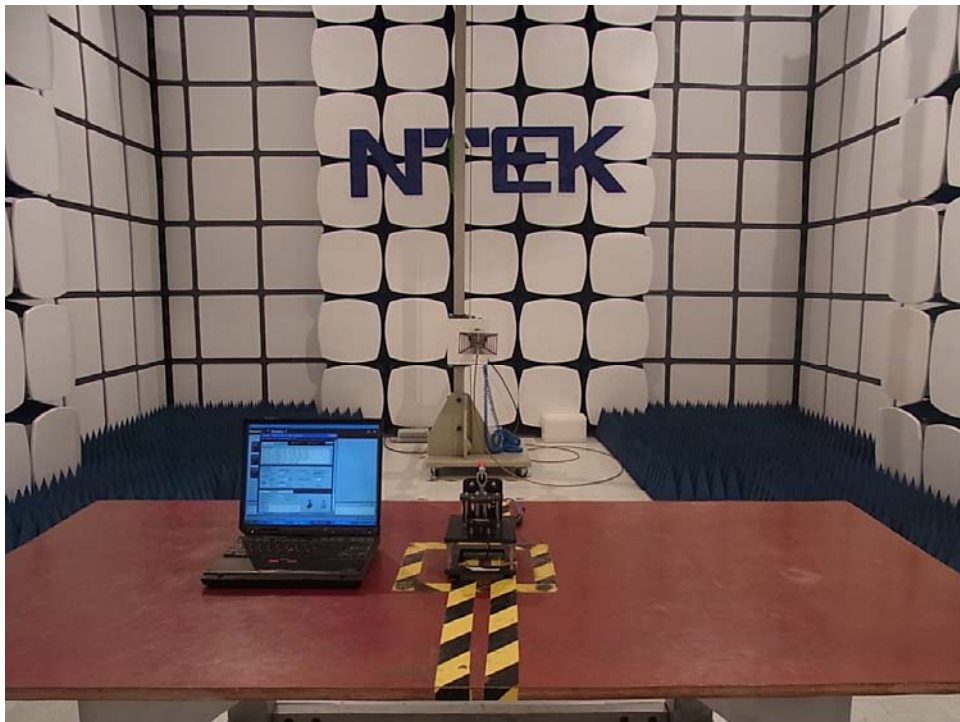
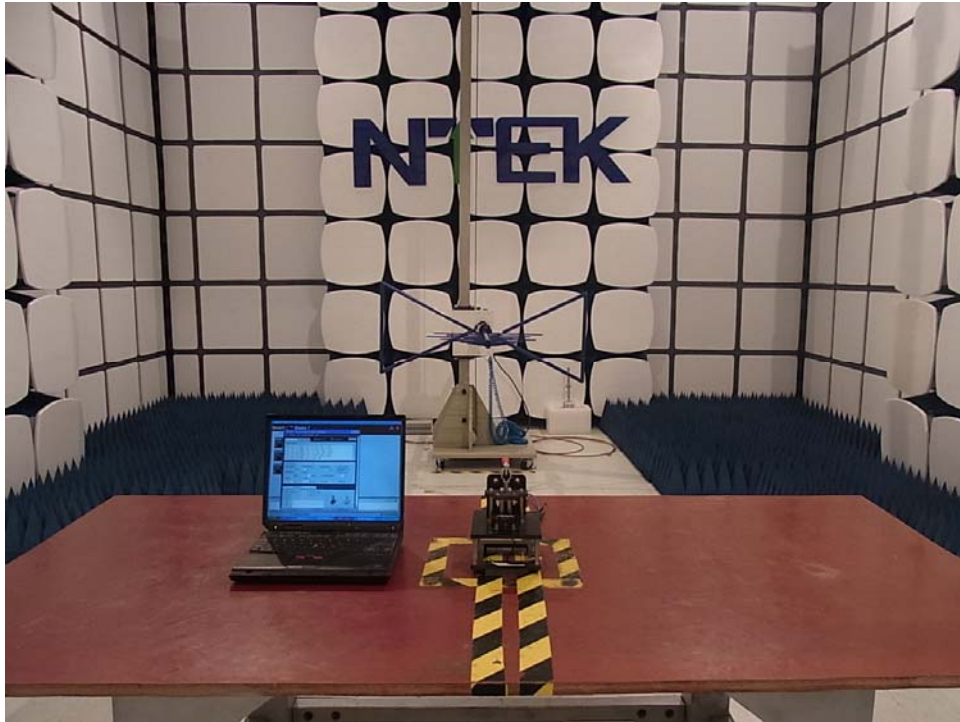

**Conducted Measurement Photos**

