

LABELS
Dimensions:
 - Product label : 18 x 90 mm
 - 2 x FCC labels : 10 x 40 mm
 - Packaging label & GTIN : 100 x 70 mm
 - UL label : 12,7 x 25,4 mm
 - (BIS label : 14,5 x 18,1 mm)
 - (Korean KC logo : 3,6 x 5,4 mm)

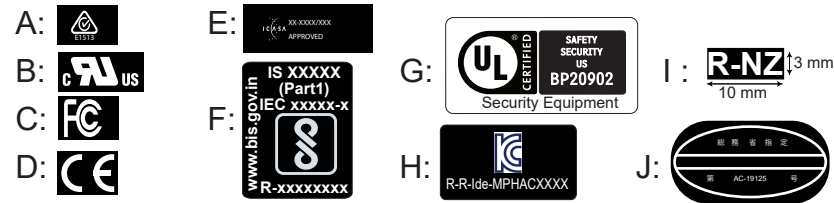

Material: Polypropylene White, inked in black
 Adhesive on the back of the label 3M 467

Printing color : White for Product label
 Black for FCC and packagings labels

P/N, Model, Symbols, Labels, Input
 and Commercial name : see table
 S/N : YYWWSMA00NNNNK
 YY : Year
 WW : Week
 S : Factory (S for SER)
 MP : MorphoWave Compact Product
 00 : Fixed
 NNNN : Serial number 4 characters
 (generated by the production unit)
 K : Checksum

Pack Number is generated by the production unit.

The labels are printed by thermal transfer
 process. To guarantee marking quality,
 (according to UL969), use appropriate
 transfer ribbon with labels.

! For good reading: Let minimum distance
 between label edge and barcodes : 1 mm

Symbol is defined by Directive 2000/96/CE.
 Minimal dimensions are 4,9x7mm:

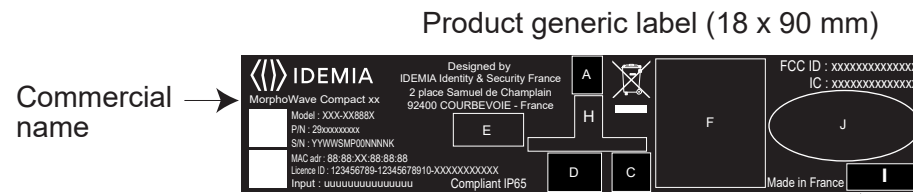

Product label location

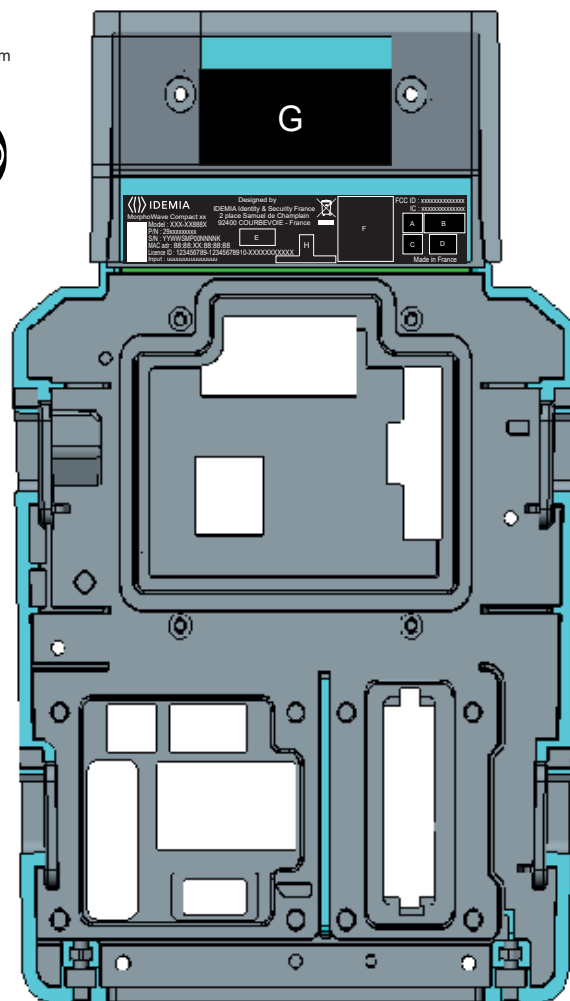

2 x FCC labels (10 x 40 mm)

This device complies with Part 15 of the FCC Rules. Operation is subject to the following two conditions:
 (1) This device may not cause harmful interference,
 and (2) this device must accept any interference
 received, including interference that may cause
 undesired operation.

Utiliser avec une alimentation à puissance limitée
 certifiée UL ou IEC 60950-1.
 For use with UL or IEC 60950-1 certified limited
 power source.

Symbols
 to be place
 according table

FCC labels location

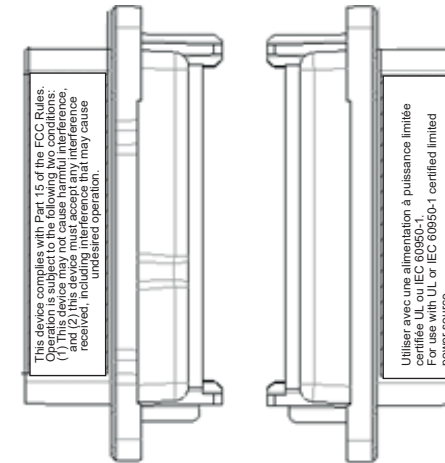

Packaging label (100 x 70 mm)

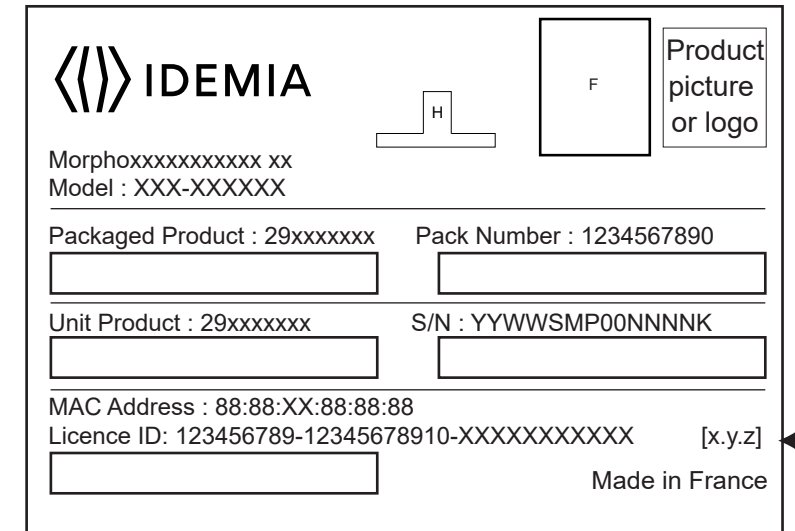

4

← Software release

3

Packaging GTIN label (100 x 70 mm)

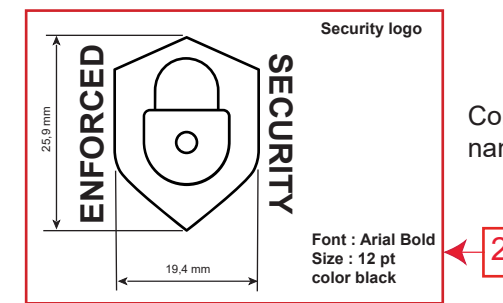

Commercial name

20

20

GTIN BARCODE
 (Type EAN-13)
 See number in table

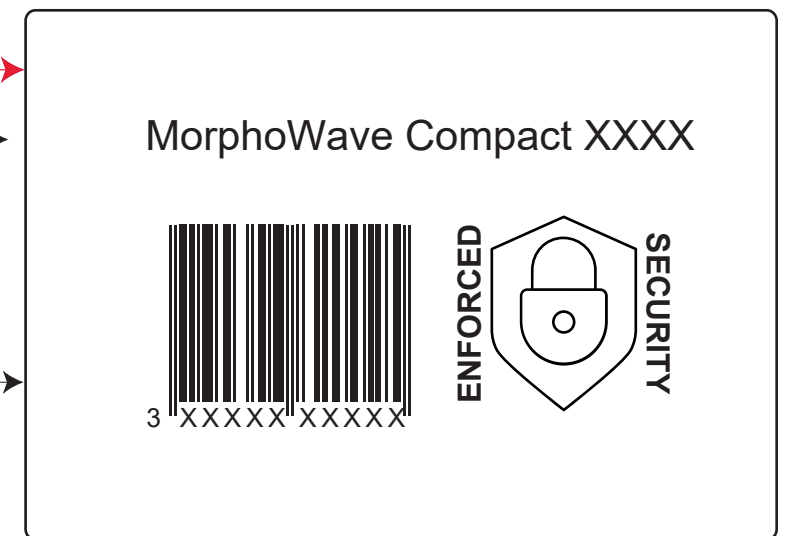

2

Symbols and additional Labels

Commercial name	Model	P/N ; Unit Product	Packaged product	Input	FC	NZ	CE	UL	BIS	UL	Observations	GTIN Code	ICASA
MorphoWave Compact MD	MPH-AC004A	293721205	293722301	Input 12V-24V --- 2,5A max or PoE+ 48V ---30w max	X	X	X	X	X	X	FCC ID: ZBW-MPHAC004A // IC = 11472A-MPHAC004A	3760306620261	TA-2018/2224
MorphoWave Compact MDPI	MPH-AC004B	293719304	293722319	Input 12V-24V --- 2,5A max or PoE+ 48V ---30w max	X	X	X	X	X	X	Contains FCC ID: JQ6-SE3210 // Contains IC = 2236B-SE3210	3760306620278	TA-2018/2225
MorphoWave Compact MDPI-M	MPH-AC004C	293771234	293771247	Input 12V-24V --- 2,5A max or PoE+ 48V ---30w max	X	X	X	X	X	X	Contains FCC ID: JQ6-SE3210 and FCC ID: JQ6-XTENDER Contains IC: 2236B-SE3210 and IC: 2236B-XTENDER	3760306620353	
MorphoWave Compact MD	MPH-AC004A	293773233	293773212	Input 12V-24V --- 2,5A max or PoE+ 48V ---30w max	X	X	X	X	X	X	FCC ID: ZBW-MPHAC004A // IC = 11472A-MPHAC004A	3760306620360	
MorphoWave Compact MDPI	MPH-AC004B	293773241	293773220	Input 12V-24V --- 2,5A max or PoE+ 48V ---30w max	X	X	X	X	X	X	Contains FCC ID: JQ6-SE3210 // Contains IC = 2236B-SE3210	3760306620377	
MorphoWave Compact MDPI-M	MPH-AC004C	293773275	293773254	Input 12V-24V --- 2,5A max or PoE+ 48V ---30w max	X	X	X	X	X	X	Contains FCC ID: JQ6-SE3210 and FCC ID: JQ6-XTENDER Contains IC: 2236B-SE3210 and IC: 2236B-XTENDER	3760306620384	

Important notes

Export control Not applicable

← 20 corrections done on this drawing revision **!** Number of warnings : 1

The concentrations of the substances object of the directives European 2011/65/UE - RoHS and 1907/2006/CE - REACH must be lower than the specified thresholds:
 . 2015/863/UE Annex II and 2011/65/UE Annex III & IV
 . 1907/2006/CE - REACH: substances and threshold of communication of information to the customer specified in article 33

ETABLI DRAWN	NOM / NAME Renaud JEAN	DATE 06/10/2022	VERIFIE CHECKED	NOM / NAME Franck GARDET	DATE 06/10/2022
LIBELLE DENOMINATION Etiquettes Generique MorphoWave Compact MorphoWave Compact Generic labels					
---	Adobe - ILLUSTRATOR	A3	1/1	6000032883	R40 000 20
REFERENCE ARTICLE PART NUMBER	ECHELLE SCALE	FORMAT SIZE	FEUILLE SHEET	NUMERO DU DOCUMENT DRAWING NUMBER	TYPE PART VERS.

1