

Test Report No.:		12030804.fcc03	Page 1 of 36
<i>Client:</i>	Plugwise B.V. Wattstraat 56, 2171TR Sassenheim		
<i>Test Item:</i>	Digital Transmission System (DTS) Plugwise System Wireless light and motion detector, ZigBee device		
<i>Identification:</i>	<i>Serial No.:</i> ----		
<i>Project No.:</i>	12030804	<i>Date of Receipt:</i>	2012-04-20
<i>Testing Location:</i>	TÜV Rheinland EPS B.V. Eiberkamp 10 9351VT Leek		
<i>Test Specification:</i>	FCC 47 CFR Part 15, Subpart C, Section 15.247 (October 1, 2010) ANSI C63.4-2009 KDB Publication No. 558074 D01: Measurement of Digital Transmission Systems Operating under Section 15.247 (January 18, 2012)		
<i>Test Result:</i>	The test item passed the test specification(s).		
<i>Testing Laboratory:</i>	TÜV Rheinland EPS B.V. Smidshornerweg 18 9822 TL Niekerk		
<i>Tested by:</i>			<i>Reviewed by:</i>
2012-09-10	R. van der Meer / Inspector	2012-09-10	O. Hoekstra / Reviewer
<i>Date</i>	<i>Name/Position</i>	<i>Signature</i>	<i>Date</i>
			<i>Name/Position</i>
			<i>Signature</i>
<i>Other Aspects:</i> N/A			
<i>Abbreviations:</i> P(ass) = passed F(ail) = failed N/A = not applicable N/T = not tested			
This report shall not be reproduced, except in full, without the written permission of TÜV Rheinland EPS B.V. The test results relate only to the item(s) tested.			

Test Report No.:

12030804.fcc03

Page 2 of 36

TEST SUMMARY

5.1.1 VOLTAGE REQUIREMENTS

RESULT: PASS

5.1.2 ANTENNA REQUIREMENTS

RESULT: PASS

5.1.3 RESTRICTED BANDS OF OPERATION

RESULT: PASS

5.2.1 CONDUCTED OUTPUT POWER

RESULT: PASS

5.2.2 6dB BANDWIDTH

RESULT: PASS

5.2.3 CONDUCTED SPURIOUS EMISSION

RESULT: PASS

5.2.4 PEAK POWER SPECTRAL DENSITY

RESULT: PASS

5.2.5 BAND EDGE CONDUCTED EMISSIONS

RESULT: Pass

5.2.6 RADIATED SPURIOUS EMISSIONS OF TRANSMITTER

RESULT: PASS

5.3.1 AC POWER LINE CONDUCTED EMISSION OF TRANSMITTER

RESULT: Not Applicable – EUT is battery operated

Contents

1.	GENERAL REMARKS	4
1.1	COMPLEMENTARY MATERIALS	4
2.	TEST SITES	4
2.1	TEST FACILITIES	4
2.2	LIST OF TEST AND MEASUREMENT INSTRUMENTS	5
2.3	MEASUREMENT UNCERTAINTY	6
3.	GENERAL PRODUCT INFORMATION	7
3.1	PRODUCT FUNCTION AND INTENDED USE	7
3.2	SYSTEM DETAILS	7
3.3	CLOCK FREQUENCIES	8
3.4	COUNTERMEASURES TO ACHIEVE EMC COMPLIANCE	8
4.	TEST SET-UP AND OPERATION MODES	9
4.1	TEST METHODOLOGY	9
4.2	OPERATION MODES	9
4.3	PHYSICAL CONFIGURATION FOR TESTING	9
4.4	TEST SOFTWARE	10
4.5	SPECIAL ACCESSORIES AND AUXILIARY EQUIPMENT	11
5.	TEST RESULTS RADIO	13
5.1	TECHNICAL REQUIREMENTS	13
5.1.1	<i>Voltage Requirements</i>	<i>13</i>
5.1.2	<i>Antenna Requirements</i>	<i>13</i>
5.1.3	<i>Restricted Bands of Operation</i>	<i>14</i>
5.2	CONDUCTED MEASUREMENTS AT ANTENNA PORT	15
5.2.1	<i>Conducted Output Power</i>	<i>15</i>
5.2.2	<i>6dB Bandwidth</i>	<i>17</i>
5.2.3	<i>Conducted Spurious Emission</i>	<i>20</i>
5.2.4	<i>Peak Power Spectral Density</i>	<i>24</i>
5.2.5	<i>Band Edge Conducted Emissions</i>	<i>27</i>
5.2.6	<i>Radiated Spurious Emissions of Transmitter</i>	<i>30</i>
5.3	AC POWER LINE CONDUCTED MEASUREMENTS	35
5.3.1	<i>AC Power Line Conducted Emission of Transmitter</i>	<i>35</i>
6.	LIST OF TABLES	36
7.	LIST OF FIGURES	36

Test Report No.:

12030804.fcc03

Page 4 of 36

1. General Remarks

1.1 Complementary Materials

There is no attachment to this test report.

2. Test Sites

2.1 Test Facilities

The Federal Communications Commission and Industry Canada has reviewed the technical characteristics of the test facilities at TÜV Rheinland EPS B.V., located in Leek, 9351VT Eiberkamp 10, The Netherlands, and has found these test facilities to be in compliance with the requirements of 47 CFR Part 15, section 2.948, (10-1-09 edition).

The description of the test facilities has been filed at the Office of the Federal Communications Commission under registration number 90828. The facility has been added to the list of laboratories performing these test services for the public on a fee basis.

The description of the test facilities has been filed to Industry Canada under registration number 2932G-2. The facility has been added to the list of laboratories performing these test services for the public on a fee basis.

Normal test conditions:

Temperature (*)	: +15°C to +35°C
Relative humidity(*)	: 20 % to 75 %
Supply voltage	: 120VAC/60Hz
Air pressure	: 950 – 1050 hPa

When it was impracticable to carry out the tests under these conditions, a note to this effect stating the ambient temperature and relative humidity during the tests are stated separately.

Test Report No.:

12030804.fcc03

Page 5 of 36

2.2 List of Test and Measurement Instruments

Table 1: List of Test and Measurement Equipment

Kind of Equipment	Manufacturer	Model Name	Inventory number	Calibration date (mm/yyyy)	Calibration due date (mm/yyyy)
For Antenna Port Conducted Emission					
Spectrum Analyzer	Rohde & Schwarz	FSP40	99538	11/2011	11/2012
Temperature-Humiditymeter	Extech	SD500	99857	02/2012	02/2013
For Radiated Emission					
Measurement Receiver	Rohde & Schwarz	ESCI	99699	02/2012	02/2013
RF Cable S-AR	Gigalink	APG0500	99858	02/2012	02/2013
Controller	Heinrich Deisel	4630-100	99107	N/A	N/A
Test facility	Comtest	FCC listed: 90828	99580	02/2012	02/2015
Spectrum Analyzer	Rohde & Schwarz	FSP40	99538	11/2011	11/2012
Controller	EMCS	DOC202	99608	N/A	N/A
Antenna mast	EMCS	AP-4702C	99609	N/A	N/A
Temperature-Humiditymeter	Extech	SD500	99855	02/2012	02/2013
Guidehorn 1-18 GHz	EMCO	3115	12484	04/2012	04/2013
Guidehorn 18-26.5 GHz	EMCO	RA42-K-F-4B-C	12488	04/2012	04/2013
Biconilog Testantenna	Chase	CBL 6111B	15633	01/2012	01/2013
2.4 GHz bandreject filter	BSC	XN-1783	14450	N/A	N/A
Bandpass filter 4-10 GHz	Reactel	7AS-7G-6G-511	99076	N/A	N/A
Bandpass filter 10-26 GHz	Reactel	9HS-10G/26.5G-S11	99136	N/A	N/A
Preamplifier 0.5 - 18 GHz	Miteq	AMF-5D-005180-28-13p	99596	N/A	N/A

Conformance of the used measurement and test equipment with the requirements of ISO/IEC 17025:2005 has been confirmed before testing.

Test Report No.:

12030804.fcc03

Page 6 of 36

2.3 Measurement Uncertainty

Table 2: Emission Measurement Uncertainty

Measurement Type	Frequency	Uncertainty
Antenna Port Conducted Emission	< 1GHz	±0.5dB
	> 1GHz	±0.7dB
Radiated Emission	150kHz - 30MHz	±5.0dB
	30MHz - 1GHz	±5.0dB
	> 1GHz	±5.5dB

3. General Product Information

3.1 Product Function and Intended Use

The brand Plugwise model Switch, hereafter referred to as EUT, is a digitally modulated transmitter intended to be used in a Plugwise network. A Plugwise network is a dynamic structure of Plugwise components that measure energy consumption, switch appliances on or off and save energy. The different components perform their tasks independently and connect with each other via ZigBee. It operates in the 2400 – 2483.5 frequency band (it actually uses the frequency range of 2405 – 2480 MHz).

The content of this report and measurement results have not been changed other than the way of presenting the data.

3.2 System Details

Details and an overview of the system and all of its components, as it has been tested, may be found below.

EUT	:	Digital Transmission System (DTS) (Plugwise System Wireless light and motion detector, ZigBee device)
Manufacturer	:	Applied Micro Electronics "AME" BV
Brand	:	Plugwise
Model	:	Switch
Serial number	:	--
MAC	:	
Voltage input rating	:	2.4 – 3.3 V battery powered (2* AAA)
Voltage output rating	:	--
Current input rating	:	--
Antenna	:	Integral, integrated on the PCB
Operating frequency	:	2405 – 2480 MHz
Modulation	:	O-QPSK
Remarks	:	n.a.

Test Report No.:

12030804.fcc03

Page 8 of 36

Table 3: Interfaces present on the EUT

No interfaces present on the EUT.

3.3 Clock Frequencies

The highest clock frequency generated by the EUT is 24.000 MHz.

3.4 Countermeasures to achieve EMC Compliance

No additional measures were employed to achieve compliance.

4. Test Set-up and Operation Modes

4.1 Test Methodology

The test methodology used is based on the requirements of 47 CFR Part 15, Sections 15.31, 15.33, 15.35, 15.205, 15.207, 15.209, 15.247 and KDB Publication No. 558074 D01: Measurement of Digital Transmission Systems Operating under Section 15.247.

The test methods, which have been used, are based on ANSI C63.4-2009.

For details, see under each test item.

4.2 Operation Modes

Testing was performed at the lowest operating frequency (2405MHz), at the operating frequency in the middle of the specified frequency band (2440MHz) and at the highest operating frequency (2480MHz).

The basic operation modes used for testing are:

- A. EUT transmits (TX mode), with full power, at lowest channel, Channel 11 (2405MHz), a continuous modulated signal streaming called "Burst Mode".
- B. EUT transmits (TX mode), with full power, at middle channel, Channel 18 (2440MHz), a continuous modulated signal streaming called "Burst Mode".
- C. EUT transmits (TX mode), with full power, at highest channel, Channel 26 (2480MHz), a continuous modulated signal streaming called "Burst Mode".

4.3 Physical Configuration for Testing

The EUT was tested on a stand-alone basis (only attached to the test jig) and the test system was configured in a typical fashion (as a customer would normally use it).

The justification and manipulation of cables and equipment in order to simulate a worst-case behavior of the test setup has been carried out as prescribed in ANSI C63.4:2009.

Figure 1: Test Setup Diagram

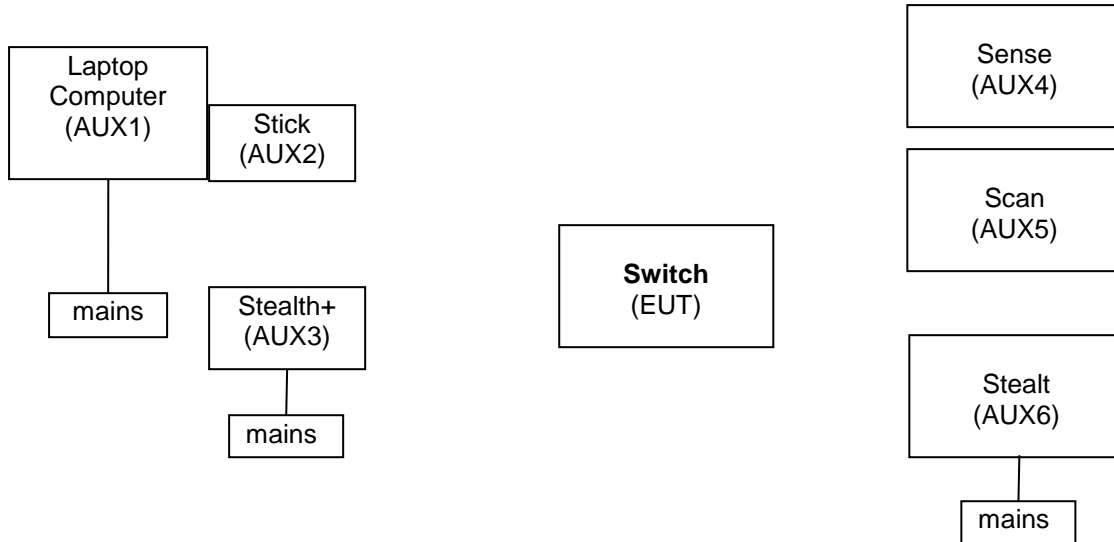

Notes:

For antenna conducted measurements, the antenna was replaced by a 50Ω antenna connector and a short RF cable.

For more details, refer to the document: Test Set-Up Photographs document.

4.4 Test Software

The EUT was provided by the manufacturer with suitable software to allow operation in all the required modes.

Software used for testing: Plugwise Easy Tool, Build date: 5/26/2011.

This software was running on a laptop computer (AUX1). It was used to enable the test operation modes listed in section 4.2 as appropriate.

4.5 Special Accessories and Auxiliary Equipment

The product has been tested together with the following additional accessories:

1. AUX1
Product: Laptop Computer
Brand: Lenovo
Model: 9456-HTG
Serial Number: L3-BF847 07/02
Remark: property TR-EPS, host for testsoftware and AUX2

2. AUX2
Product: ZigBee module, USB Stick
Brand: Plugwise
Model: Stick
Rated Voltage: 3.3 - 5Vdc (USB powered)
Antenna: Internal, integrated on the PCB
Remarks: FCC ID: ZB9-STICK, connects to AUX1

3. AUX3
Product: ZigBee module
Manufacturer: Plugwise
Brand: Stealth+
Rated Voltage: 100 – 240 Vac
Antenna: Internal, integrated on the PCB
Remarks: FCC ID: ZB9-STEALTH-PLUS

4. AUX4
Product: ZigBee module
Brand: Plugwise
Model: Sense
Rated Voltage: 3.6 Vdc, battery powered
Antenna: Internal, integrated on the PCB
Remarks: FCC ID: ZB9-SENSE

5. AUX5
Product: ZigBee module
Brand: Plugwise
Model: Scan
Rated Voltage: 3.6 Vdc, battery powered
Antenna: Internal, integrated on the PCB
Remarks: FCC ID: ZB9-SCAN

Test Report No.:

12030804.fcc03

Page 12 of 36

6. AUX6

Product:	ZigBee module
Brand:	Plugwise
Model:	Stealth
Rated Voltage:	100 – 240 Vac
Antenna:	Internal, integrated on the PCB
Remarks:	FCC ID: ZB9-STEALTH

Test Report No.:

12030804.fcc03

Page 13 of 36

5. Test Results

5.1 Technical Requirements

5.1.1 Voltage Requirements

RESULT: Pass

Requirements:

FCC 15.31(e)

For intentional radiators, measurements of the variation of the input power or the radiated signal level of the fundamental frequency component of the emission, as appropriate, shall be performed with the supply voltage varied between 85% and 115% of the nominal rated supply voltage. For battery operated equipment, the equipment tests shall be performed using a new battery.

Verdict:

New batteries have been used during all testing.

5.1.2 Antenna Requirements

RESULT: Pass

Requirements:

FCC 15.203

An intentional radiator shall be designed to ensure that no antenna other than that furnished by the responsible party shall be used with the device.

Verdict:

The EUT has an internal antenna which is not user accessible. Hence it complies with the requirements.

Test Report No.:

12030804.fcc03

Page 14 of 36

5.1.3 Restricted Bands of Operation

RESULT: Pass

Requirements:

FCC 15.205

Only spurious emissions are permitted in any of the restricted frequency bands, unless otherwise specified.

Verdict:

The EUT operation frequency range is 2405 MHz - 2480 MHz. Therefore only spurious emissions may be found in the restricted bands of operation and the EUT complies with the restricted frequency band requirement.

5.2 Conducted Measurements at Antenna Port

5.2.1 Conducted Output Power

RESULT: Pass

Date of testing: 2012-06-11

Requirements:

FCC 15.247(b)(3)

For systems using digital modulation in the 2400-2483.5MHz band, the maximum peak output power is 1W (+30dBm).

Test procedure:

ANSI C63.4-2009 and KDB Publication No. 558074 D01: Measurement of Digital Transmission Systems Operating under Section 15.247.

The maximum peak output power (conducted) was measured at the antenna connector with a spectrum analyzer. The final measurement takes into account the loss generated by all the involved cables.

Table 4: Conducted Output Power

Frequency [MHz]	Reading [dBm]	Correction Factor [dB]	Output Power [dBm]	Output Power [mW]	Limit [dBm]	Limit [mW]	Margin [dB]
2405	-0.74	1.0	+0.26	1.06	+30	1000	-29.74
2440	-1.19	1.0	-0.19	0.96	+30	1000	-30.19
2480	-2.87	1.0	-1.87	0.65	+30	1000	-31.87

Notes: Output power = Reading + Correction factor

Correction factor = Total cable loss

mW = 10 ^ (dBm/10)

dBm = 10 x log(mW)

Test Report No.:

12030804.fcc03

Page 16 of 36



RBW 3 MHz Marker 1 [T1]
VBW 10 MHz 0.26 dBm
Ref 11 dBm *Att 20 dB SWT 2.5 ms 510.000000 μ s

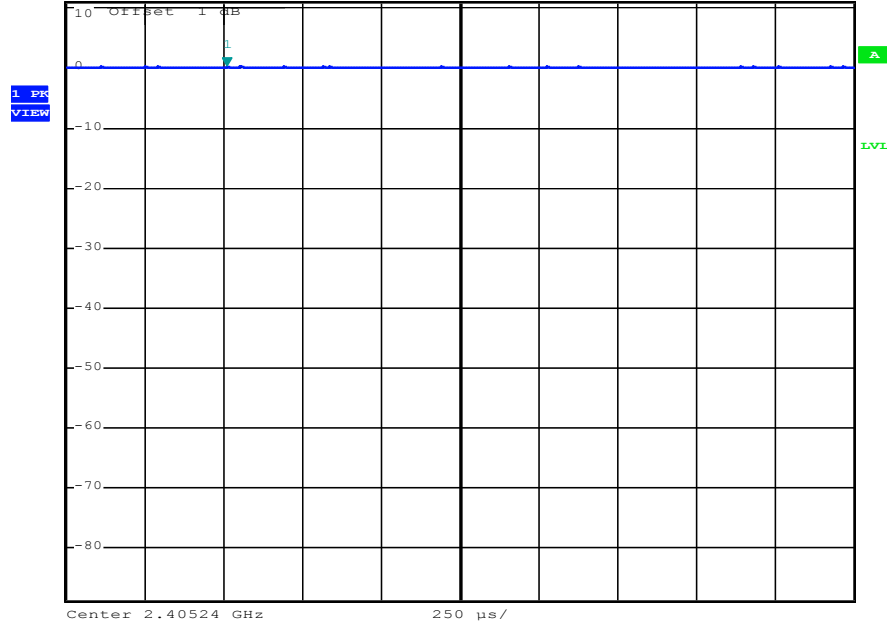

Date: 11.JUN.2012 11:19:08



11.Jun 12 12:10 RBW 3 MHz Marker 1 [T1]
Ref 10 dBm *Att 20 dB VBW 10 MHz -0.19 dBm
SWT 2.5 ms 265.000000 μ s

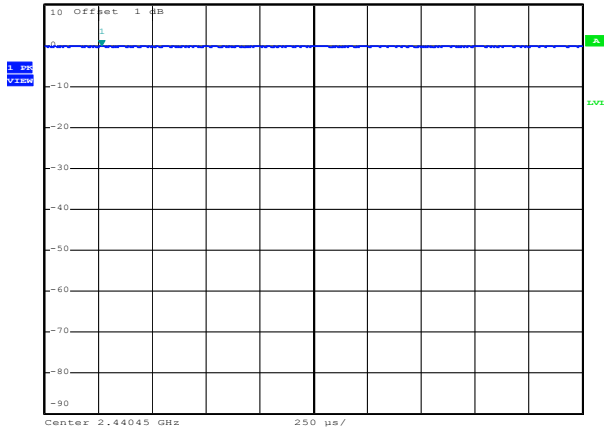

Date: 11.JUN.2012 12:10:15



11.Jun 12 13:53 RBW 3 MHz Marker 1 [T1]
Ref 10 dBm *Att 20 dB VBW 10 MHz -1.87 dBm
SWT 2.5 ms 550.000000 μ s

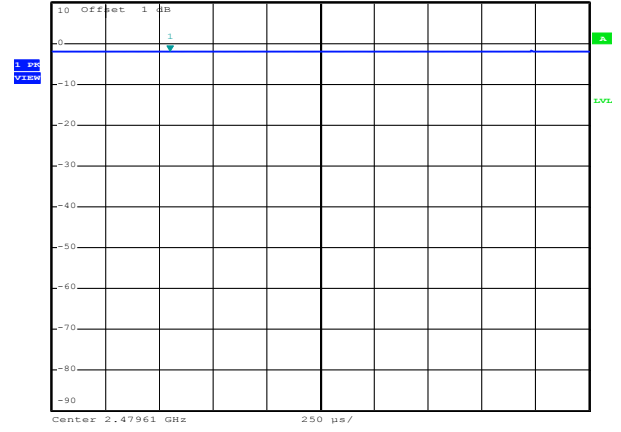

Date: 11.JUN.2012 13:53:54

Figure 2: Peak power plots,

Figures showing plots of the Peak Power outputs, correction factors included in the reading.

Test Report No.:

12030804.fcc03

Page 17 of 36

5.2.2 6dB Bandwidth

RESULT: Pass

Date of testing: 2012-06-11

Requirements:

FCC 15.247(a)(2)

For systems using digital modulation in the 2400-2483.5MHz band, the 6dB bandwidth shall be at least 500kHz.

Test procedure:

ANSI C63.4-2009 and KDB Publication No. 558074 D01: Measurement of Digital Transmission Systems Operating under Section 15.247.

A spectrum analyzer was connected to the antenna port of the EUT. The spectrum analyzer resolution bandwidth was set to 100kHz and the span to 5 MHz. Any emissions directly related to the transmitter function located in these bands meet the General radiated emissions limits of 15.209.

Test Report No.:

12030804.fcc03

Page 18 of 36

Table 5: 6dB Bandwidth

Operating Frequency [MHz]	6dB Bandwidth [kHz]	Limit [kHz]
2405	940	500
2440	1460	500
2480	1200	500

Figure 3: 6dB Bandwidth, Mode A (2405MHz)

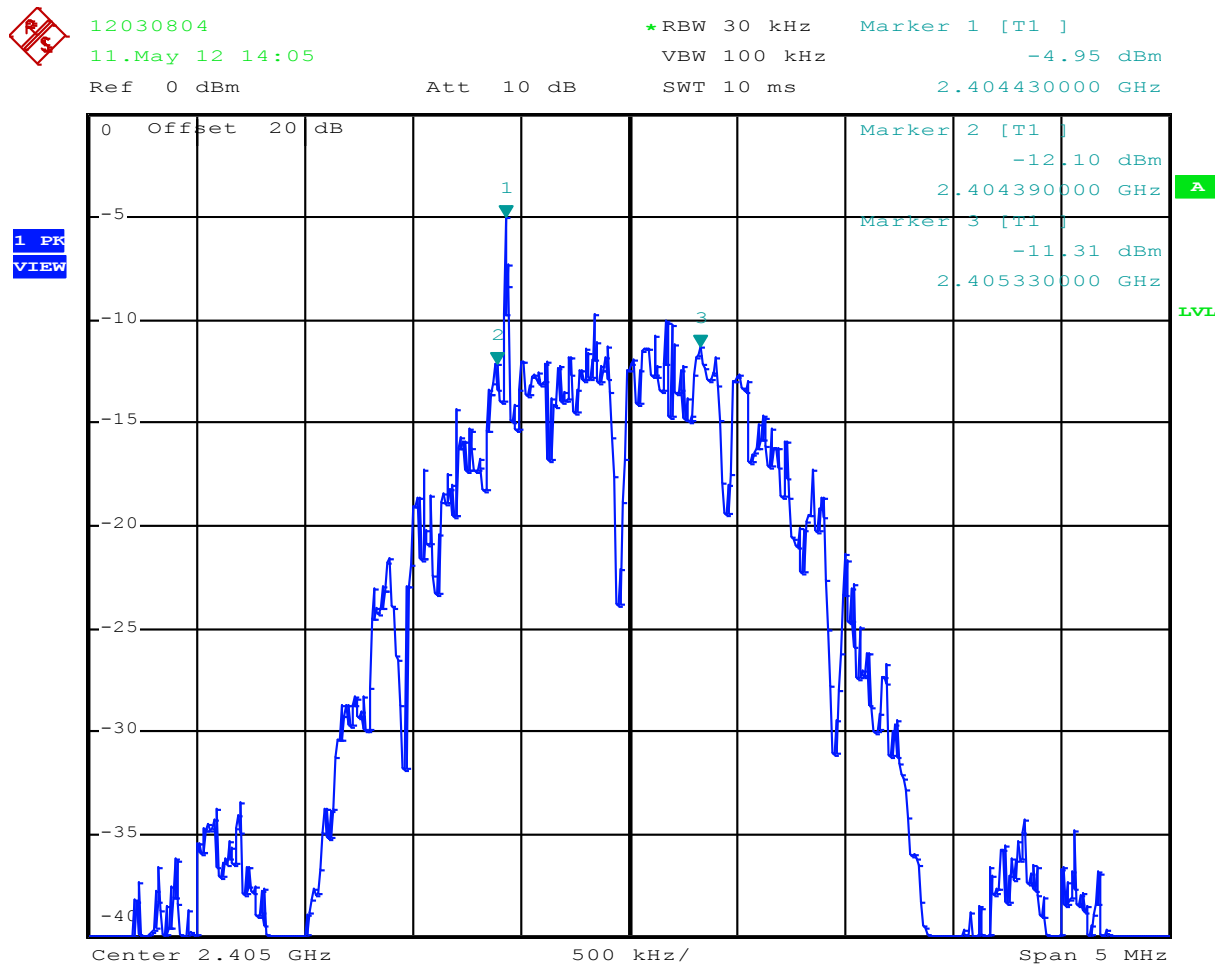

Date: 11.MAY.2012 14:05:48

Test Report No.:

12030804.fcc03

Page 19 of 36

Figure 4: 6dB Bandwidth, Mode B (2440MHz)

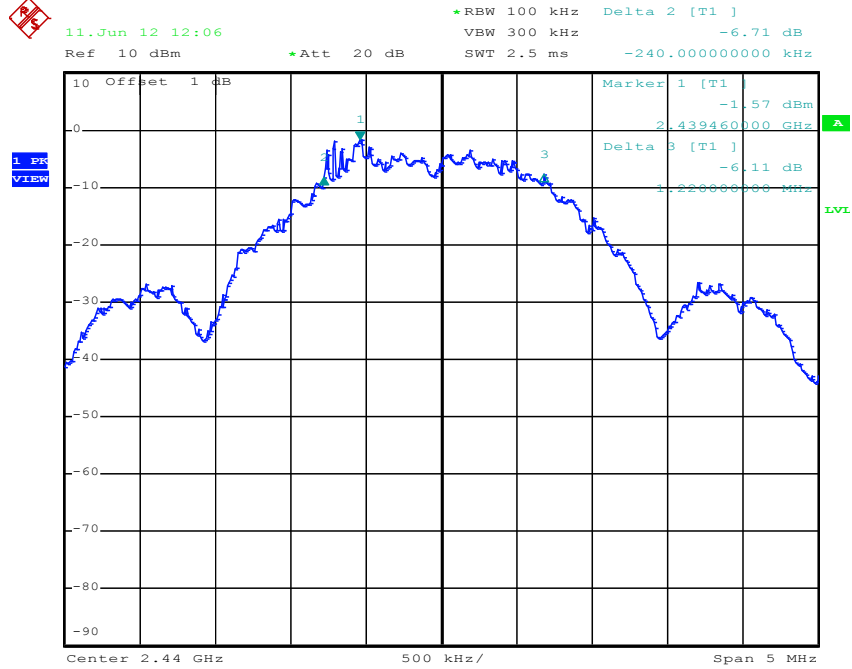

Date: 11.JUN.2012 12:06:35

Figure 5: 6dB Bandwidth, Mode C (2480MHz)

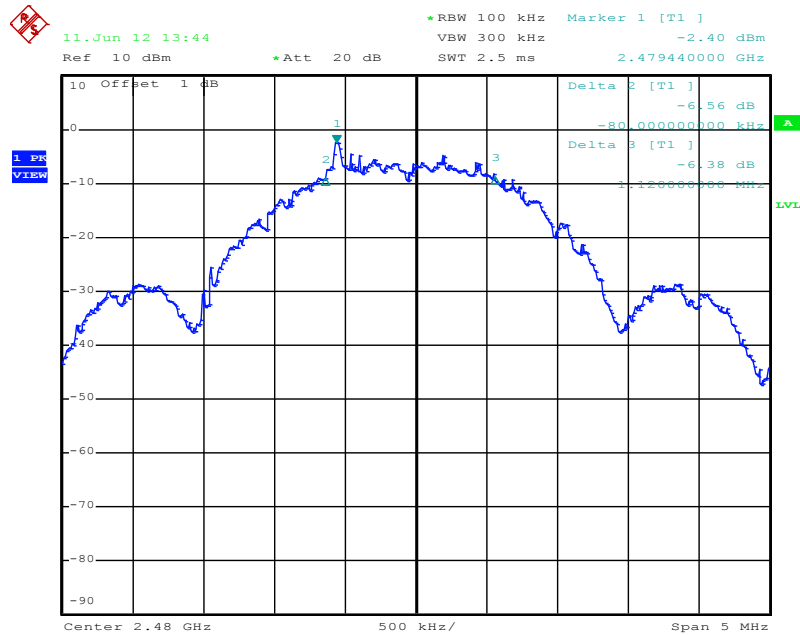

Date: 11.JUN.2012 13:44:39

Test Report No.:

12030804.fcc03

Page 20 of 36

5.2.3 Conducted Spurious Emission

RESULT: Pass

Date of testing:

2012-06-28

Requirements:

FCC 15.247(d)

In any 100kHz bandwidth outside the frequency band, the RF power shall be at least 20dB below that of the maximum in-band 100kHz emission.

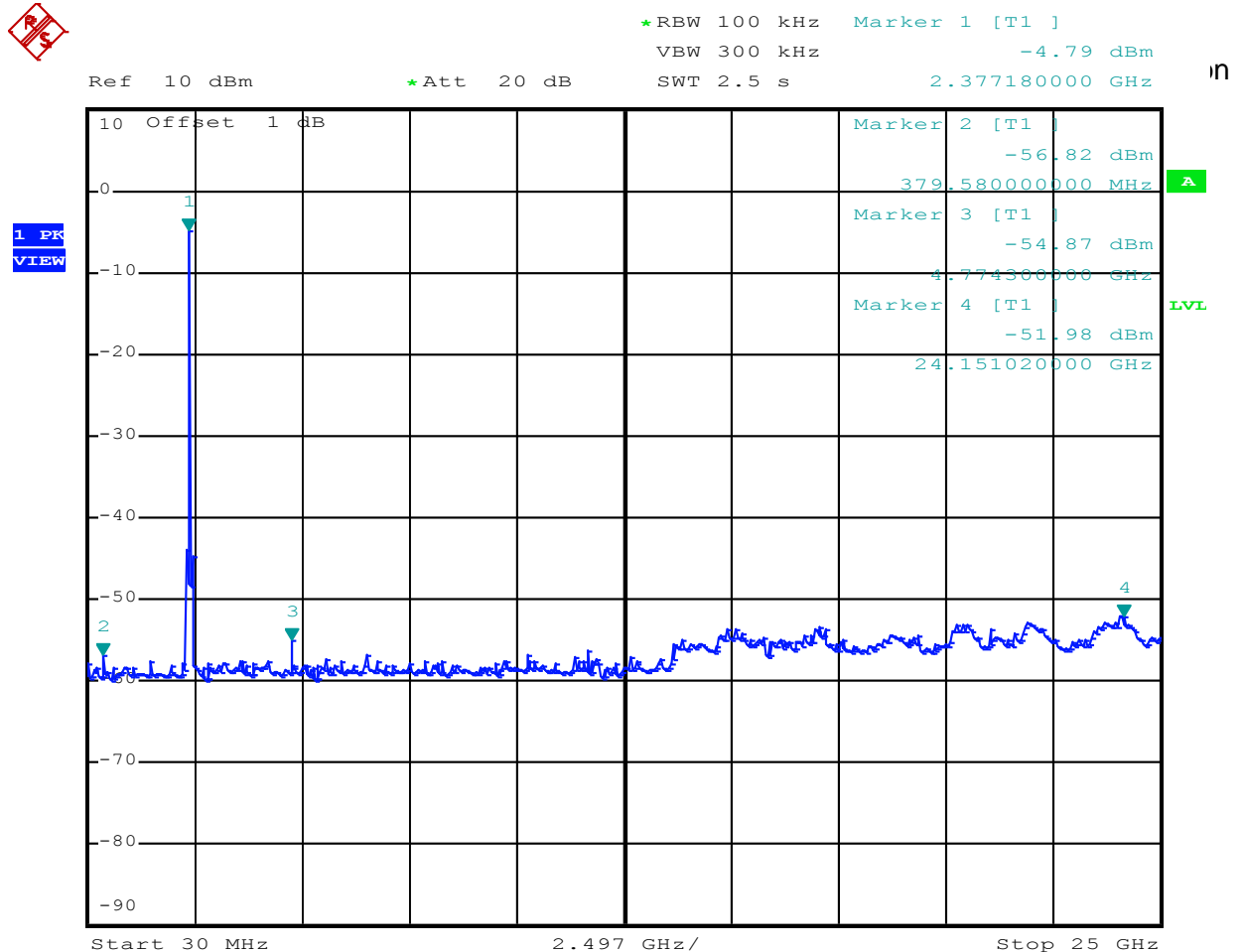

Date: 28.JUN.2012 14:02:13

Test Report No.:

12030804.fcc03

Page 22 of 36

Figure 7: Conducted Spurious Emission, 30MHz - 25GHz, Mode B (2440MHz)

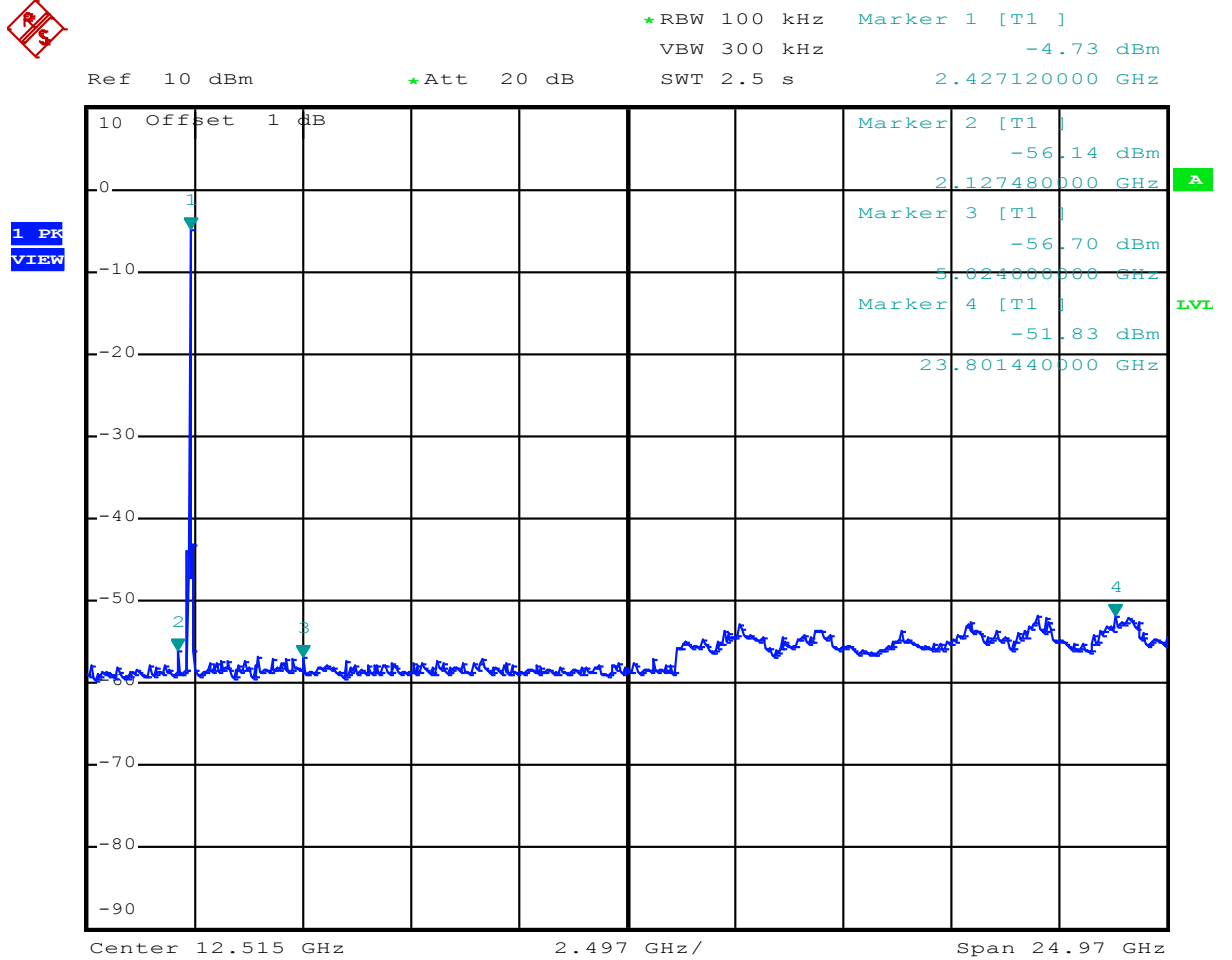

Date: 28.JUN.2012 14:06:19

Test Report No.:

12030804.fcc03

Page 23 of 36

Figure 8: Conducted Spurious Emission, 30MHz - 25GHz, Mode C (2480MHz)

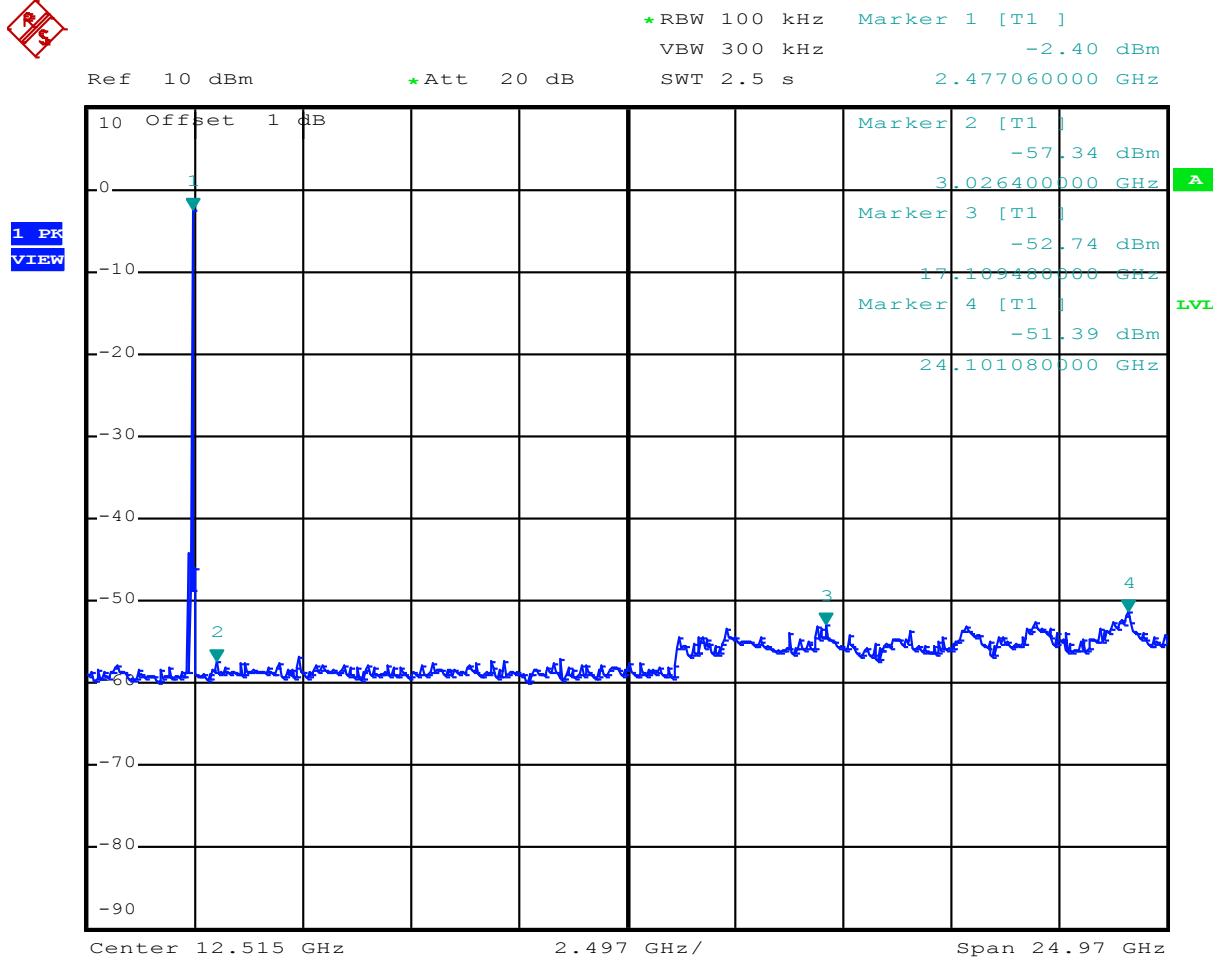

Date: 28.JUN.2012 14:08:58

Test Report No.:

12030804.fcc03

Page 24 of 36

5.2.4 Peak Power Spectral Density

RESULT: Pass

Date of testing: 2012-06-11

Requirements:

FCC 15.247(e)

For digitally modulated systems, the power spectral density (PSD) conducted from the intentional radiator to the antenna shall not be greater than 8dBm in any 3kHz band during any time interval of continuous transmission.

Test procedure:

ANSI C63.4-2009 and KDB Publication No. 558074 D01: Measurement of Digital Transmission Systems Operating under Section 15.247.

A spectrum analyzer was connected to the antenna port of the EUT. The analyzer resolution bandwidth was set to 3kHz and the video bandwidth was set to 10kHz. The sweep time was set to 500s.

The final measurement takes into account the loss generated by all the involved cables.

Figure 10: Power Spectral Density, Mode B (2440MHz)



Date: 11.JUN.2012 12:12:45

Figure 11: Power Spectral Density, Mode C (2480MHz)

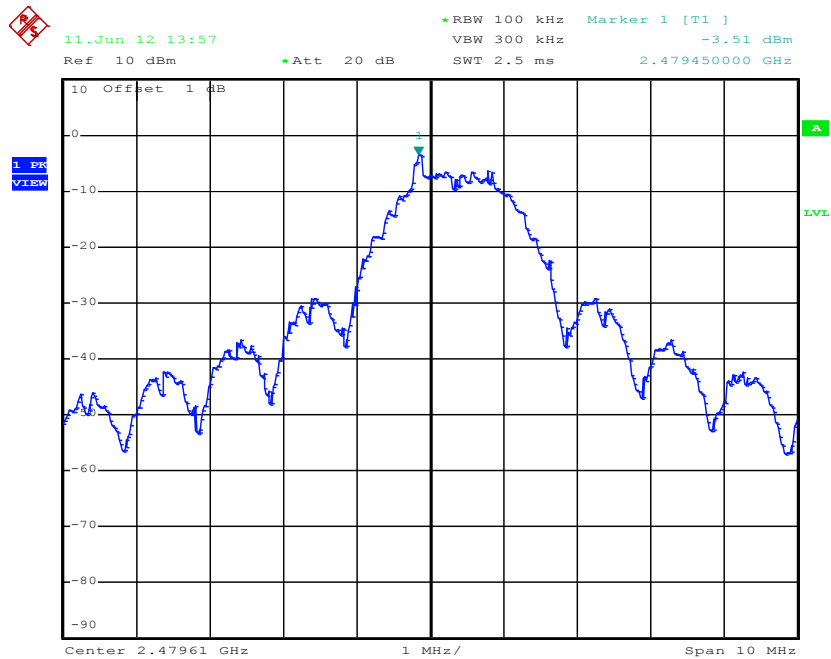

Date: 11.JUN.2012 13:57:51

Test Report No.:

12030804.fcc03

Page 27 of 36

5.2.5 Band Edge Conducted Emissions

RESULT: Pass

Date of testing: 2012-09-10

Requirements:

FCC 15.205, FCC 15.209 and FCC 15.247(d)

In any 100 kHz bandwidth outside the frequency band in which the spread spectrum or digitally modulated intentional radiator is operating, the radio frequency power that is produced by the intentional radiator shall be at least 20 dB below that in the 100 kHz bandwidth within the band that contains the highest level of the desired power, based on either an RF conducted or a radiated measurement, provided the transmitter demonstrates compliance with the peak conducted power limits.

Test procedure:

ANSI C63.4-2009 and KDB Publication No. 558074 D01: Measurement of Digital Transmission Systems Operating under Section 15.247.

Measurements were performed using a spectrum analyzer with a suitable span to encompass the peak of the fundamental and using the following settings:

RBW = 100kHz, VBW = 100kHz.

The highest emission amplitudes relative to the appropriate limit were measured and recorded in this report.

Results: All out of band spurious emissions are more than 20 dB below the fundamental. See Figures 12 and 13 on the following pages.

Figure 12: Band Edge Conducted Emission, Spectral Diagram, Mode A (2405MHz)

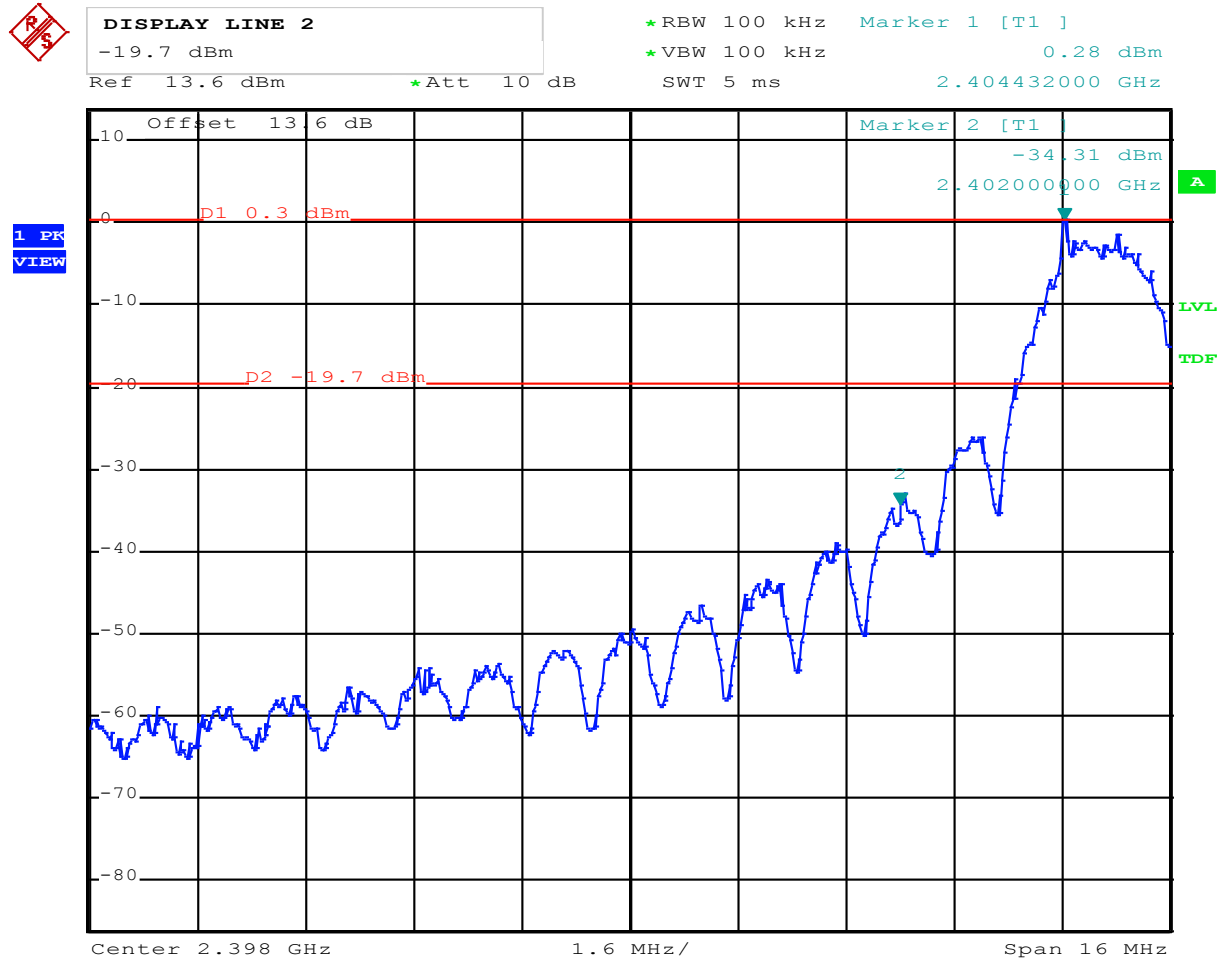

Date: 10.SEP.2012 10:41:42

Lower authorized band edge attenuation is more than the required 20dB.

Figure 13: Band Edge Conducted Emission, Spectral Diagram, Mode C (2480MHz)



Date: 10.SEP.2012 10:48:07

Higher authorized band edge attenuation is more than the required 20dB.

Test Report No.:

12030804.fcc03

Page 30 of 36

5.2.6 Radiated Spurious Emissions of Transmitter

RESULT: Pass

Date of testing: 2012-05-23 and 2012-06-22

Frequency range: 30MHz - 25GHz

Requirements:

FCC 15.205, FCC 15.209 and FCC 15.247(d)

Radiated emissions which fall in the restricted bands, as defined in FCC 15.205(a), must comply with the radiated emission limits specified in FCC 15.209(a).

Radiated emissions which fall outside the operation frequency band and outside restricted bands shall either meet the limit specified in FCC 15.209(a) or be attenuated at least 20dB below the power level in the 100kHz bandwidth within the band that contains the highest level of the desired power (the less severe limit applies).

Test procedure:

ANSI C63.4-2009 and KDB Publication No. 558074 D01: Measurement of Digital Transmission Systems Operating under Section 15.247.

The EUT was placed on a nonconductive turntable 0.8m above the ground plane. Before final measurements of radiated emissions were performed, the EUT was scanned to determine its emission spectrum profile. The physical arrangement of the test system, the associated cabling and the EUT orientation (X, Y, Z) were varied in order to ensure that maximum emission amplitudes were attained.

The spectrum was examined from 30MHz to the 10th harmonic of the highest fundamental transmitter frequency (25GHz). Final radiated emission measurements were made at 3m distance.

At each frequency where a spurious emission was found, the EUT was rotated 360° and the antenna was raised and lowered from 1 to 4m in order to determine the emission's maximum level. Measurements were taken using both horizontal and vertical antenna polarizations.

The highest emission amplitudes relative to the appropriate limit were recorded in this report. Field strength values of radiated emissions at frequencies not listed in the tables are more than 20 dB below the applicable limit.

Test Report No.:

12030804.fcc03

Page 31 of 36

Table 7: Radiated Emission, Quasi Peak Data, 30MHz - 1GHz, Horizontal and Vertical Antenna Orientations

Freq. [MHz]	Antenna Orientation	Reading QP [dB μ V]	Factor [dB(1/m)]	Level QP [dB μ V/m]	Limit [dB μ V/m]	Margin QP [dB]
119.240	Vertical	-1.0	11.7	10.7	43.5	-32.8
161.920	Vertical	1.9	10.6	12.5	43.5	-21.0
165.800	Horizontal	0.4	10.4	10.8	43.5	-32.7
173.560	Horizontal	9.1	10.1	19.2	43.5	-24.3
239.520	Vertical	2.1	13.2	15.3	46.0	-30.7
565.440	Horizontal	-0.5	22.3	21.8	46.0	-24.2

- Note:
- Level QP = Reading QP + Factor
 - Tested in Mode A (2405MHz), Mode B (2440MHz) and Mode C (2480MHz), highest values noted.
 - Quasi Peak detector used with a bandwidth of 120 kHz

Table 8: Radiated Emission, Average Data, 1 - 25GHz, Horizontal and Vertical Antenna Orientations, Mode A (2405MHz)

Freq. [MHz]	Antenna Orientation	Reading AV [dBµV]	Factor [dB(1/m)]	Level AV [dBµV/m]	Limit [dBµV/m]	Margin AV [dB]
1722	Vertical	10.3	11.1	21.4	54	-32.6
1855	Vertical	11.0	11.1	22.1	54	-31.9
2120	Vertical	14.4	7.6	22.0	54	-32.0
2253	Vertical	20.2	3.8	24.0	54	-30.0
2287	Vertical	21.4	3.8	25.2	54	-28.8
4800	Vertical	44.5	0.5	45.0	54	-9.0

Note: - Level AV = Reading AV + Factor
 - Average detector used with a bandwidth of 1 MHz.

Table 9: Radiated Emission, Peak Data, 1 - 25GHz, Horizontal and Vertical Antenna Orientations, Mode A (2405MHz)

Freq. [MHz]	Antenna Orientation	Reading PK [dBµV]	Factor [dB(1/m)]	Level PK [dBµV/m]	Limit [dBµV/m]	Margin PK [dB]
1722	Vertical	19.2	11.1	30.3	74	-43.7
1855	Vertical	16.6	11.1	27.7	74	-46.3
2120	Vertical	24.5	7.6	32.1	74	-41.9
2253	Vertical	27.2	3.8	31.0	74	-43.0
2287	Vertical	29.2	3.8	33.0	74	-41.0
4800	Vertical	53.1	0.5	53.6	74	-20.4

Note: - Level PK = Reading PK + Factor
 - Peak detector used with a bandwidth of 1 MHz

Table 10: Radiated Emission, Average Data, 1 - 25GHz, Horizontal and Vertical Antenna Orientations, Mode B (2440MHz)

Freq. [MHz]	Antenna Orientation	Reading AV [dBµV]	Factor [dB(1/m)]	Level AV [dBµV/m]	Limit [dBµV/m]	Margin AV [dB]
1722	Vertical	13.1	11.1	24.2	54	-29.8
1855	Vertical	11.9	11.1	23.0	54	-31.0
2120	Horizontal	16.2	7.6	23.8	54	-30.2
2253	Vertical	19.3	3.8	23.1	54	-30.9
2287	Vertical	18.8	3.8	22.6	54	-31.4
4800	Vertical	27.1	0.5	27.6	54	-26.4

Note: - Level AV = Reading AV + Factor
 - Average detector used with a bandwidth of 1 MHz

Table 11: Radiated Emission, Peak Data, 1 - 25GHz, Horizontal and Vertical Antenna Orientations, Mode B (2440MHz)

Freq. [MHz]	Antenna Orientation	Reading PK [dBµV]	Factor [dB(1/m)]	Level PK [dBµV/m]	Limit [dBµV/m]	Margin PK [dB]
1722	Vertical	20.0	11.1	31.1	74	-42.9
1855	Vertical	17.6	11.1	28.7	74	-45.3
2120	Horizontal	24.3	7.6	31.9	74	-42.1
2253	Vertical	28.7	3.8	32.5	74	-41.5
2287	Vertical	30.4	3.8	34.2	74	-39.8
4800	Vertical	54.8	0.5	55.3	74	-18.7

Note: - Level PK = Reading PK + Factor
 - Peak detector used with a bandwidth of 1 MHz

Test Report No.:

12030804.fcc03

Page 34 of 36

Table 12: Radiated Emission, Average Data, 1 - 25GHz, Horizontal and Vertical Antenna Orientations, Mode C (2480MHz)

Freq. [MHz]	Antenna Orientation	Reading AV [dBµV]	Factor [dB(1/m)]	Level AV [dBµV/m]	Limit [dBµV/m]	Margin AV [dB]
1722	Vertical	15.3	11.1	26.4	54	-27.6
1855	Vertical	14.7	11.1	25.8	54	-28.2
2120	Horizontal	19.8	7.6	27.4	54	-26.6
2287	Vertical	23.2	3.8	27.0	54	-27.0
4800	Vertical	31.1	0.5	31.6	54	-22.4
12000	Horizontal	30.1	6.4	36.5	54	-17.5

Note: - Level AV = Reading AV + Factor
 - Average detector used with a bandwidth of 1 MHz

Table 13: Radiated Emission, Peak Data, 1 - 25GHz, Horizontal and Vertical Antenna Orientations, Mode C (2480MHz)

Freq. [MHz]	Antenna Orientation	Reading PK [dBµV]	Factor [dB(1/m)]	Level PK [dBµV/m]	Limit [dBµV/m]	Margin PK [dB]
1722	Vertical	21.9	11.1	33.0	74	-41.0
1855	Vertical	23.7	11.1	34.8	74	-39.2
2120	Horizontal	24.3	7.6	31.9	74	-42.1
2287	Vertical	30.0	3.8	33.8	74	-40.2
4800	Vertical	37.8	0.5	38.3	74	-35.7
12000	Horizontal	36.0	6.4	42.4	74	-31.6

Note: - Level PK = Reading PK + Factor
 - Peak detector used with a bandwidth of 1 MHz

Test Report No.:

12030804.fcc03

Page 35 of 36

5.3 AC Power Line Conducted Measurements

5.3.1 AC Power Line Conducted Emission of Transmitter

RESULT: Not Applicable – EUT is battery operated

6. List of Tables

2.2 List of Test and Measurement Instruments Table 1: List of Test and Measurement Equipment ...	5
Table 2: Emission Measurement Uncertainty	6
Table 3: Interfaces present on the EUT	8
Table 4: Conducted Output Power	15
Table 5: 6dB Bandwidth	18
Table 6: Peak Power Spectral Density.....	25
Table 7: Radiated Emission, Quasi Peak Data, 30MHz - 1GHz, Horizontal and Vertical Antenna Orientations	31
Table 8: Radiated Emission, Average Data, 1 - 25GHz, Horizontal and Vertical Antenna Orientations, Mode A (2405MHz)	32
Table 9: Radiated Emission, Peak Data, 1 - 25GHz, Horizontal and Vertical Antenna Orientations, Mode A (2405MHz)	32
Table 10: Radiated Emission, Average Data, 1 - 25GHz, Horizontal and Vertical Antenna Orientations, Mode B (2440MHz)	33
Table 11: Radiated Emission, Peak Data, 1 - 25GHz, Horizontal and Vertical Antenna Orientations, Mode B (2440MHz)	33
Table 12: Radiated Emission, Average Data, 1 - 25GHz, Horizontal and Vertical Antenna Orientations, Mode C (2480MHz)	34
Table 13: Radiated Emission, Peak Data, 1 - 25GHz, Horizontal and Vertical Antenna Orientations, Mode C (2480MHz)	34

7. List of Figures

Figure 1: Test Setup Diagram	10
Figure 2: Peak power plots,.....	16
Figure 3: 6dB Bandwidth, Mode A (2405MHz).....	18
Figure 4: 6dB Bandwidth, Mode B (2440MHz).....	19
Figure 5: 6dB Bandwidth, Mode C (2480MHz)	19
Figure 6: Conducted Spurious Emission, 30MHz - 25GHz, Mode A (2405MHz)	21
Figure 7: Conducted Spurious Emission, 30MHz - 25GHz, Mode B (2440MHz)	22
Figure 8: Conducted Spurious Emission, 30MHz - 25GHz, Mode C (2480MHz)	23
Figure 9: Power Spectral Density, Mode A (2405MHz)	25
Figure 10: Power Spectral Density, Mode B (2440MHz)	26
Figure 11: Power Spectral Density, Mode C (2480MHz)	26
Figure 12: Band Edge Conducted Emission, Spectral Diagram, Mode A (2405MHz).....	28
Figure 13: Band Edge Conducted Emission, Spectral Diagram, Mode C (2480MHz).....	29