



FCC TEST REPORT

According to

FCC 47 CFR PART 22 SUBPART H AND PART 24 SUBPART E

Applicant	:	Beijing InHand Networks Technology Co., Ltd
Address	:	WestWing 11 th Floor, Buiding G, Wangjing Science Park, Chaoyang District, Beijing.
Manufacturer	:	Beijing InHand Networks Technology Co., Ltd
Address	:	WestWing 11 th Floor, Buiding G, Wangjing Science Park, Chaoyang District, Beijing.
Equipment	:	Industrial Cellular Router
Model No.	:	IR701GS55, IR711GS55, IR721GS55, IR731GS55, IR741GS55, IR751GS55, IR761GS55, IR771GS55, IR781GS55, IR791GS55
FCC ID	:	ZAZR7X1GS

- The test result refers exclusively to the test presented test model / sample.
- Without written approval of **CerpPASS Technology Corp.** the test report shall not be reproduced except in full.
- The test report must not be used by the clients to claim product certification approval by **NVLAP** or any agency of the Government.



Table of Contents

- 1. Report of Measurements and Examinations 6
- 2. Test Configuration of Equipment under Test 7
 - 2.1. Feature of Equipment under Test 7
 - 2.2. Test Manner 8
 - 2.3. Description of Test System 8
 - 2.4. General Information of Test 8
 - 2.5. Measurement Uncertainty 9
- 3. Test of Conducted Emission 10
 - 3.1. Test Limit..... 10
 - 3.2. Test Procedures..... 10
 - 3.3. Typical Test Setup..... 11
 - 3.4. Measurement Equipment 11
 - 3.5. Test Result and Data 12
- 4. FIELD STRENGTH OF SPURIOUS RADIATION MEASUREMENT 14
 - 4.1. Test Limit..... 14
 - 4.2. Test Procedures..... 14
 - 4.3. Typical Test Setup..... 14
 - 4.4. Measurement Equipment 16
 - 4.5. Test Result and Data 17
- 5. Occupied Bandwidth 29
 - 5.1. Test Limit..... 29
 - 5.2. Test Procedures..... 29
 - 5.3. Test Setup Layout..... 29
 - 5.4. Measurement Equipment 29
 - 5.5. Test Result and Data 30
- 6. Maximum Peak Output Power 34
 - 6.1. Test Limit..... 34
 - 6.2. Test Procedure 34
 - 6.3. Test Setup Layout..... 34
 - 6.4. Measurement Equipment 34
 - 6.5. Test Result and Data 35
- 7. ERP & EIRP MEASUREMENT 36
 - 7.1. Test Limit..... 36
 - 7.2. Test Procedure 36
 - 7.3. Test Setup Layout..... 37
 - 7.4. Measurement Equipment 38
 - 7.5. Test Result and Data 39
- 8. OUT OF BAND EMISSION AT ANTENNA TERMINALS 40
 - 8.1. Test Limit..... 40
 - 8.2. Test Procedure 40
 - 8.3. Test Setup Layout..... 40
 - 8.4. Measurement Equipment 40
 - 8.5. Test Result and Data 41



9. FREQUENCY STABILITY V.S. TEMPERATURE MEASUREMENT 47

9.1. Test Limit..... 47

9.2. Test Procedure 47

9.3. Test Setup Layout..... 47

9.4. Measurement Equipment 47

9.5. Test Result and Data 48

10. REQUENCY STABILITY V.S. VOLTAGE MEASUREMENT..... 49

10.1. Test Limit..... 49

10.2. Test Procedure 49

10.3. Test Setup Layout..... 49

10.4. Measurement Equipment 49

10.5. Test Result and Data 50



FCC TEST REPORT

according to

FCC 47 CFR PART 22 SUBPART H AND PART 24 SUBPART E

Applicant	:	Beijing InHand Networks Technology Co., Ltd
Address	:	WestWing 11 th Floor, Buiding G, Wangjing Science Park, Chaoyang District, Beijing.
Manufacturer	:	Beijing InHand Networks Technology Co., Ltd
Address	:	WestWing 11 th Floor, Buiding G, Wangjing Science Park, Chaoyang District, Beijing.
Equipment	:	Industrial Cellular Router
Model No.	:	IR701GS55, IR711GS55, IR721GS55, IR731GS55, IR741GS55, IR751GS55, IR761GS55, IR771GS55, IR781GS55, IR791GS55
FCC ID	:	ZAZR7X1GS

I HEREBY CERTIFY THAT :

The measurements shown in this test report were made in accordance with the procedures given in **ANSI C63.4 – 2003** and the energy emitted by this equipment was **passed** **FCC Rule FCC PART 22 Subpart H and PART 24 Subpart E** in both radiated and conducted emission limits.

Testing was carried out on Nov 14, 2011- Nov 21, 2011 at **CerpPASS Technology Corp.**

Documented By:

Jeff Fang/ Administration

Approved By:

Miro Chueh / Technical director



1. Report of Measurements and Examinations

FCC 47 CFR PART 22 SUBPART H AND PART 24 SUBPART E ANSI C63.4: 2003		
Test Parameter	Test Performed	Remark
Conducted Emission	YES	PASS
Field Strength of Spurious Radiation Measurement	YES	PASS
Occupied Bandwidth	YES	PASS
Maximum Peak Output Power	YES	PASS
ERP & EIRP Measurement	YES	PASS
Out of Band Emission at Antenna Terminals	YES	PASS
Frequency Stability V.S. Temperature Measurement	YES	PASS
Requency Stability V.S. Voltage Measurement	YES	PASS



2. Test Configuration of Equipment under Test

2.1. Feature of Equipment under Test

Industrial Cellular Router	Model No:	IR701GS55, IR711GS55, IR721GS55, IR731GS55, IR741GS55, IR751GS55, IR761GS55, IR771GS55, IR781GS55, IR791GS55
Power supply	Input:	+12-48V \square 0.4-0.1A
Remark	They are identical except the Software. This is only to satisfy the different requirements of the client. IR791GS55 was selected as the test model and its data have been recorded in this report.	

Spreading	GPRS: GMSK
Frequency Range	GPRS:850: 824 ~ 849 MHz GPRS:1900: 1850 ~ 1910 MHz
Antenna Type	Dipole
Antenna Gain	0.5 dBi



2.2. Test Manner

Test Manner	
a	During testing, the interface cables and equipment positions were varied according to 47 CFR, Part 2, PART 22 Subpart H and PART 24 Subpart E.
b	Adjust the EUT at the test mode and the test channel. Then test.
The test modes:	
<p>The EUT had been tested under operating condition.</p> <p>After verification, all tests were carried out with the worst case test modes as shown below except radiated spurious emission below 1GHz and power line conducted emissions below 30MHz, which worst case was in normal link mode only.</p> <p>EUT staying in continuous transmitting mode was programmed.</p> <p>GPRS 850: Channel Low (CH128), Channel Mid (CH190) and Channel High (CH251) were chosen for full testing.</p> <p>GPRS 1900: Channel Low (CH512), Channel Mid (CH661) and Channel High (CH810) were chosen for full testing.</p>	

2.3. Description of Test System

No.	Device	Manufacturer	Model No.	Description
1	LCD Monitor	CHI-MEI	CT-730D	N/A
2	USB Keyboard	DELL	SK-8115	N/A
3	PC	Dell	DCSM	N/A
4	USB Mouse	DELL	G0K02XYK	N/A



2.4. General Information of Test

Test Site:	CerpPASS Technology Corp.
Performand Location :	No.66,Tangzhuang Road, Suzhou Industrial Park, Jiangsu 215006, China
NVLAP LAB Code :	200814-0
FCC Registration Number :	916572, 331395
IC Registration Number :	7290A-1, 7290A-2
VCCI Registration Number :	T-1945 for Telecommunication Test C-2919 for Conducted emission test R-2670 for Radiated emission test below 1GHz G-227 for Radiated emission test above 1GHz

Laboratory accreditation



2.5. Measurement Uncertainty

Measurement Item	Measurement Frequency	Polarization	Uncertainty
Conducted Emission	9 kHz ~ 30 MHz	LINE/NEUTRAL	±2.71 dB
Radiated Emission	30 MHz ~ 25GHz	Vertical	±4.11 dB
		Horizontal	±4.10 dB
Occupied Bandwidth	---	---	±7500 Hz
Maximum Peak Output Power	---	---	±1.4 dB
Band Edges	---	---	±2.2 dB
Power Spectral Density	---	---	±2.2 dB



3. Test of Conducted Emission

3.1. Test Limit

Conducted Emissions were measured from 150 kHz to 30 MHz with a bandwidth of 9 KHz on the 120 VAC power and return leads of the EUT according to the methods defined in ANSI C63.4-2003 Section 3.1. The EUT was placed on a nonmetallic stand in a shielded room 0.8 meters above the ground plane as shown in section 2.2. The interface cables and equipment positioning were varied within limits of reasonable applications to determine the position produced maximum conducted emissions.

Frequency (MHz)	Quasi Peak (dB μ V)	Average (dB μ V)
0.15 – 0.5	66-56*	56-46*
0.5 – 5.0	56	46
5.0 – 30.0	60	50

*Decreases with the logarithm of the frequency.

3.2. Test Procedures

1. The EUT was placed on a table, which is 0.8m above ground plane.
2. Maximum procedure was performed on the six highest emissions to ensure EUT compliance.
3. Repeat above procedures until all frequency measured were complete.



3.3. Typical Test Setup

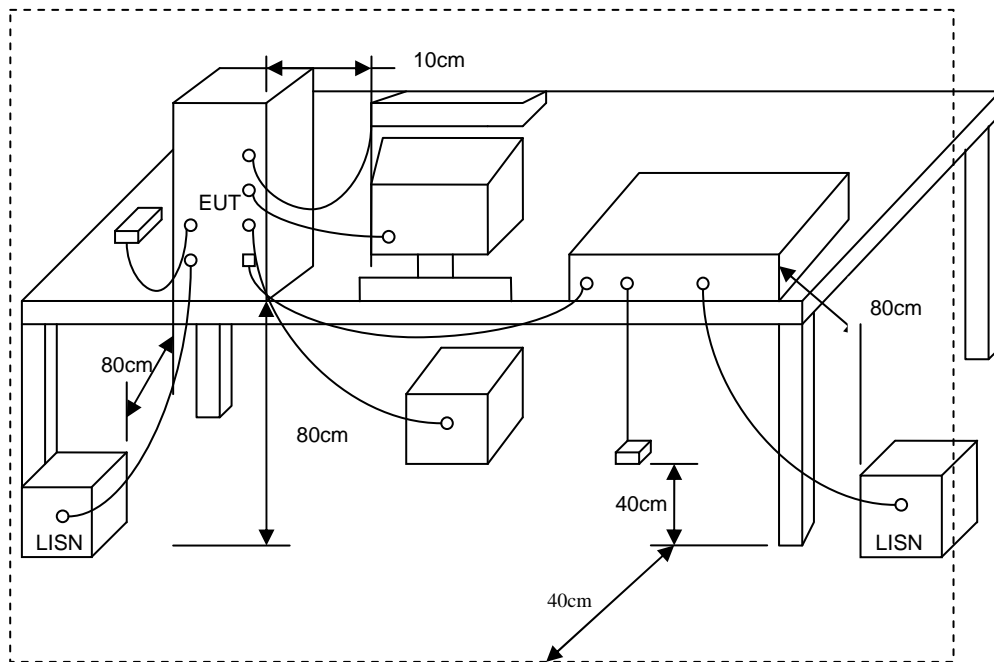

3.4. Measurement Equipment

Instrument	Manufacturer	Model No.	Serial No.	Calibration Date
Test Receiver	R&S	ESCI	100565	2011.01.15
AMN	R&S	ESH2-Z5	100182	2011.03.14
Two-Line V-Network	R&S	ENV216	100325	2011.03.14
ISN	FCC	FCC-TLISN-T2-02	20379	2011.03.14
ISN	FCC	FCC-TLISN-T4-02	20380	2011.03.14
ISN	FCC	FCC-TLISN-T8-02	20381	2011.03.14
Attenuator	R&S	ESH3-Z2	100529	2011.03.14
Temperature/ Humidity Meter	Zhicheng	ZC1-11	CEP-TH-004	2011.03.14



3.5. Test Result and Data

Test Mode :	Normal Link	Phase :	Line
Temperature :	20°C	Humidity:	51%
Pressur(mbar) :	1002	Date:	2011/11/14

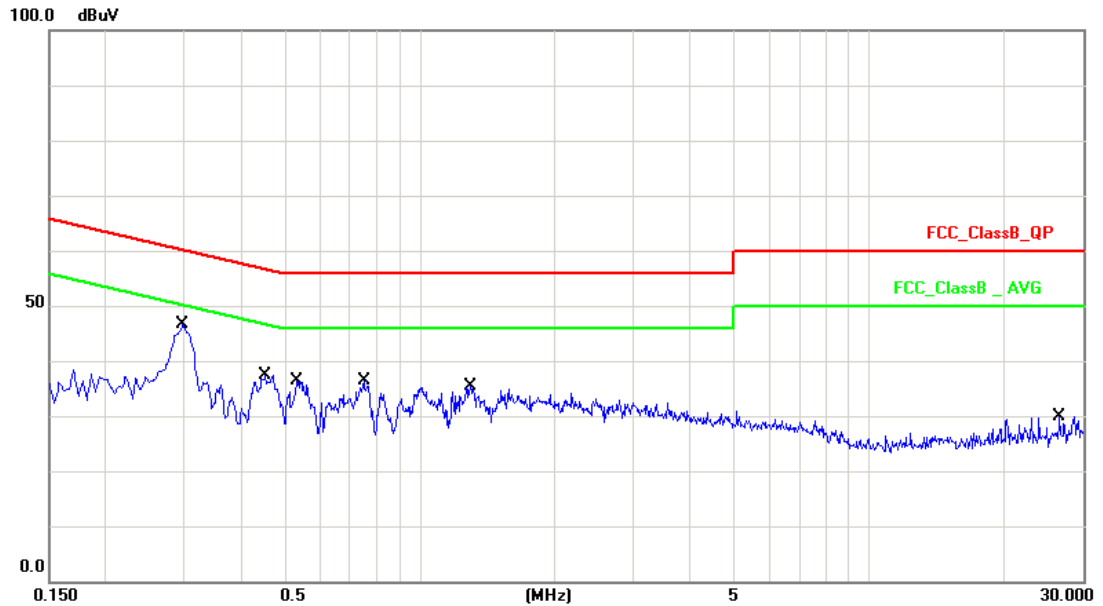

No.	Frequency (MHz)	Factor (dB)	Reading (dBuV)	Level (dBuV)	Limit (dBuV)	Margin (dB)	Detector
1	0.2980	19.87	23.53	43.40	60.30	-16.90	QP
2	0.2980	19.87	13.76	33.63	50.30	-16.67	AVG
3	0.4540	19.85	15.02	34.87	56.80	-21.93	QP
4	0.4540	19.85	7.44	27.29	46.80	-19.51	AVG
5	0.5340	19.85	12.90	32.75	56.00	-23.25	QP
6	0.5340	19.85	5.61	25.46	46.00	-20.54	AVG
7	0.7539	19.82	12.10	31.92	56.00	-24.08	QP
8	0.7539	19.82	4.00	23.82	46.00	-22.18	AVG
9	1.3020	19.74	11.47	31.21	56.00	-24.79	QP
10	1.3020	19.74	4.32	24.06	46.00	-21.94	AVG
11	26.6100	19.57	6.05	25.62	60.00	-34.38	QP
12	26.6100	19.57	2.43	22.00	50.00	-28.00	AVG

Note: Measurement Level = Reading Level + Correct Factor



Test Mode :	Normal Link	Phase :	Neutral
Temperature :	20°C	Humidity :	51%
Pressur(mbar) :	1002	Date :	2011/11/14

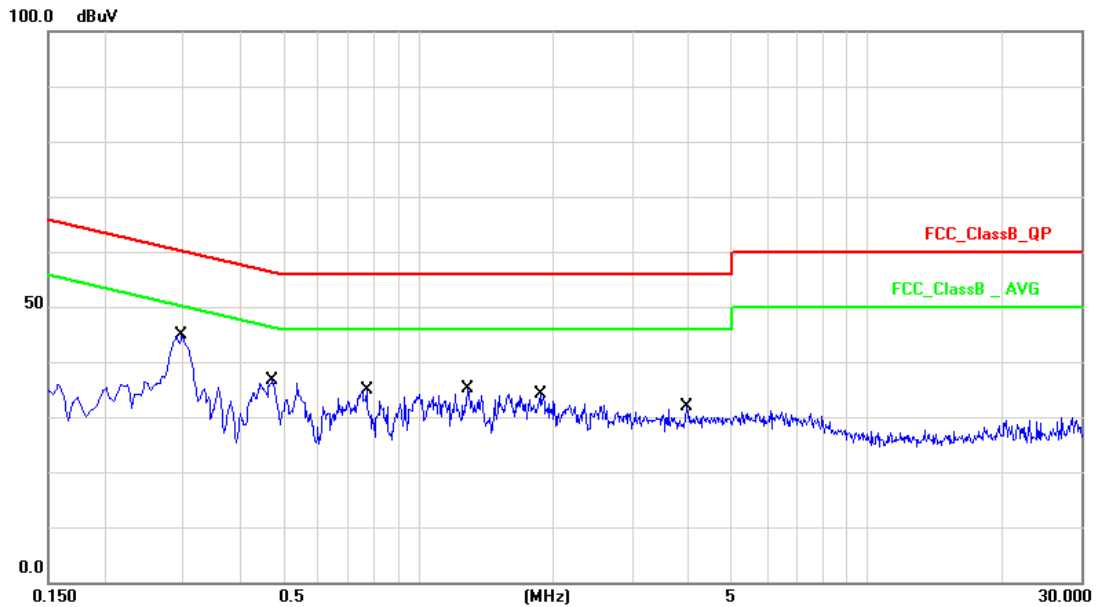

No.	Frequency (MHz)	Factor (dB)	Reading (dBuV)	Level (dBuV)	Limit (dBuV)	Margin (dB)	Detector
1	0.2980	19.51	22.29	41.80	60.30	-18.50	QP
2	0.2980	19.51	13.57	33.08	50.30	-17.22	AVG
3	0.4740	19.50	13.42	32.92	56.44	-23.52	QP
4	0.4740	19.50	6.14	25.64	46.44	-20.80	AVG
5	0.7700	19.48	11.04	30.52	56.00	-25.48	QP
6	0.7700	19.48	3.69	23.17	46.00	-22.83	AVG
7	1.2940	19.46	10.16	29.62	56.00	-26.38	QP
8	1.2940	19.46	3.75	23.21	46.00	-22.79	AVG
9	1.8820	19.50	8.20	27.70	56.00	-28.30	QP
10	1.8820	19.50	2.60	22.10	46.00	-23.90	AVG
11	3.9700	19.59	5.97	25.56	56.00	-30.44	QP
12	3.9700	19.59	-0.23	19.36	46.00	-26.64	AVG

Note: Measurement Level = Reading Level + Correct Factor



4. FIELD STRENGTH OF SPURIOUS RADIATION MEASUREMENT

4.1. Test Limit

According to FCC §2.1053.

4.2. Test Procedures

The EUT was placed on a non-conductive, the measurement antenna was placed at a distance of 3 meters from the EUT. During the tests, the antenna height and the EUT azimuth were varied in order to identify the maximum level of emissions from the EUT. This maximization process was repeated with the EUT positioned in each of its three orthogonal orientations.

The frequency range up to tenth harmonic was investigated for each of three fundamental frequency (low, middle and high channels). Once spurious emission were identified, the power of the emission was determined using the substitution method.

The spurious emissions attenuation was calculated as the difference between radiated power at the fundamental frequency and the spurious emissions frequency.

$$\text{ERP} = \text{S.G. output (dBm)} + \text{Antenna Gain (dBd)} - \text{Cable (dB)}$$

$$\text{EIRP} = \text{S.G. output (dBm)} + \text{Antenna Gain (dBi)} - \text{Cable (dB)}$$

4.3. Typical Test Setup

Below 1 GHz

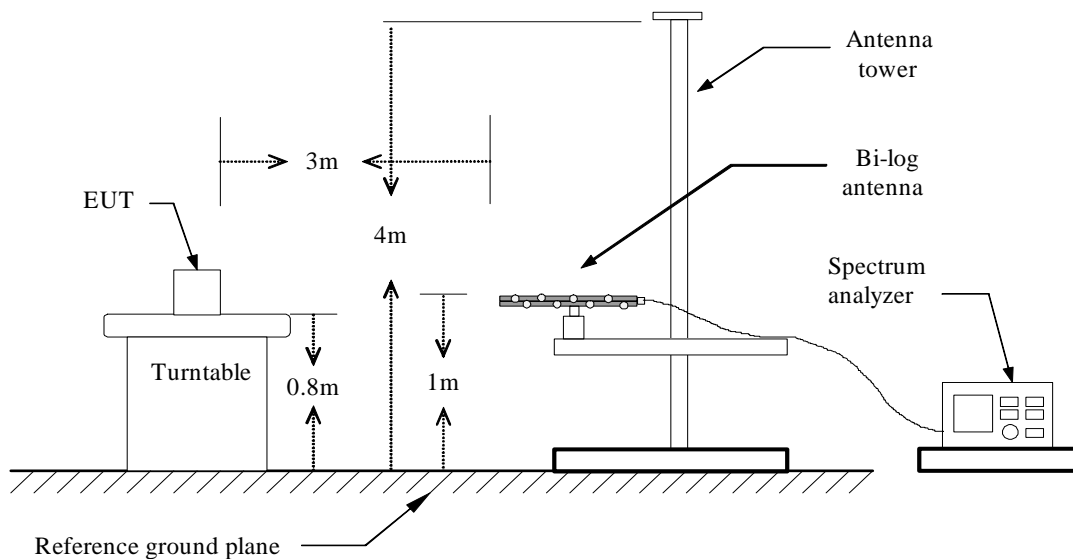



Above 1 GHz

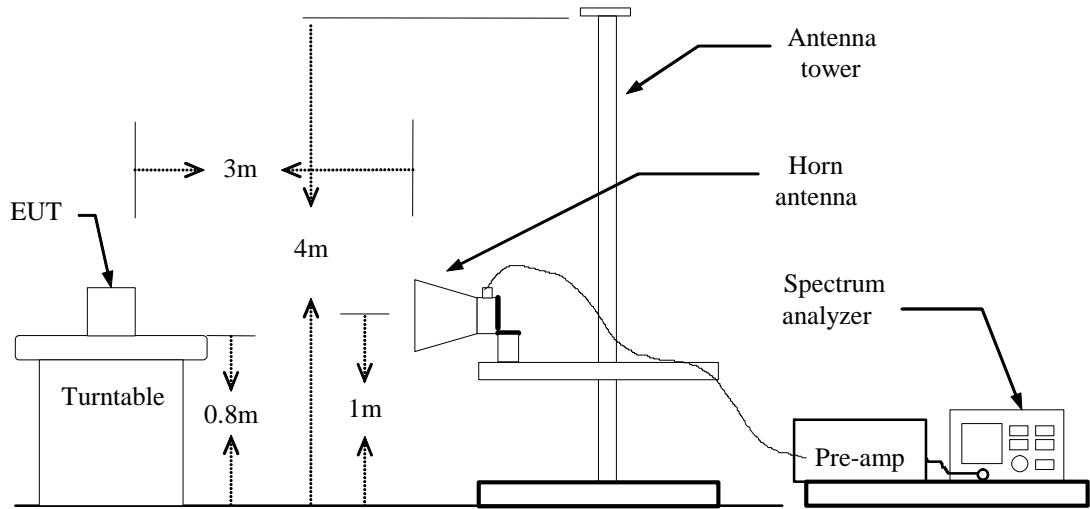

Substituted Method Test Set-up

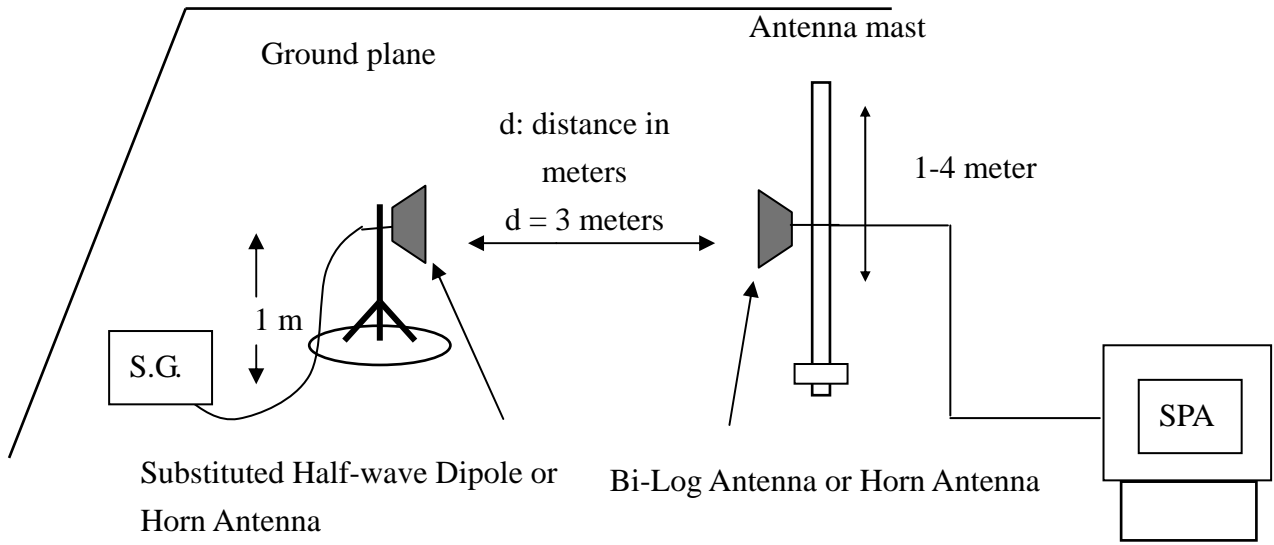



4.4. Measurement Equipment

Instrument	Model No.	Manufacturer	Serial No.	Calibration Date
EMI Test Receiver	R&S	ESCI	101183	2011.05.11
H64 Amplifier	HP	8447F	3113A05582	2011.08.14
Preamplifier	Agilent	8449B	3008A02342	2011.02.10
Ultra Broadband Antenna	R&S	HL562	100363	2011.05.07
Broad-Band Horn Antenna	Schwarzbeck	BBHA9120D	9120D-619	2011.05.07
Spectrum Analyzer	R&S	FSP40	100324	2011.08.14
Temperature/ Humidity Meter	Zhicheng	ZC1-11	CEP-TH-002	2011.08.17



4.5. Test Result and Data

Radiated Spurious Emission Measurement Result / Under 1GHz:

Engineer : Jeff	Time : 2011-11-21
Site : EMC Lab AC 102	Margin : 6
Limit : FCC_Part22&24	Probe : VERTICAL/ HORIZONTAL
EUT : Industrial Cellular Router	Note : GPRS 850 / TX / CH 128

Frequency (MHz)	Antenna Polarization	Reading (dBm)	Correction Factor (dB)	Emission level (dBm)	Limit (dBm)	Margin (dB)
30.00	V	-35.25	-17.68	-52.93	-13.00	-39.93
53.90	V	-40.77	-13.00	-53.77	-13.00	-40.77
110.51	V	-49.74	-5.90	-55.64	-13.00	-42.64
498.24	V	-48.36	-3.61	-51.97	-13.00	-38.97
666.32	V	-50.36	-1.93	-52.29	-13.00	-39.29
897.18	V	-54.28	2.00	-52.28	-13.00	-39.28
97.90	H	-54.25	0.03	-54.22	-13.00	-41.22
239.52	H	-47.58	-8.30	-55.88	-13.00	-42.88
480.08	H	-53.69	-3.61	-57.30	-13.00	-44.30
666.32	H	-52.36	-1.56	-53.92	-13.00	-40.92
750.71	H	-55.41	0.23	-55.18	-13.00	-42.18
897.18	H	-56.47	2.13	-54.34	-13.00	-41.34

Note:

1. All Readings below 1GHz are Quasi-Peak, above are performed with peak and/or average measurements as necessary.
2. Measurement Level = Reading Level + Correct Factor



Engineer : Jeff	Time : 2011-11-21
Site : EMC Lab AC 102	Margin : 6
Limit : FCC_Part22&24	Probe : VERTICAL/ HORIZONTAL
EUT : Industrial Cellular Router	Note : GPRS 850 / TX / CH 190

Frequency (MHz)	Antenna Polarization	Reading (dBm)	Correction Factor (dB)	Emission level (dBm)	Limit (dBm)	Margin (dB)
32.12	V	-36.25	-17.68	-53.93	-13.00	-40.93
54.36	V	-41.02	-13.00	-54.02	-13.00	-41.02
111.02	V	-48.58	-5.90	-54.48	-13.00	-41.48
489.26	V	-47.33	-3.61	-50.94	-13.00	-37.94
662.36	V	-49.69	-1.93	-51.62	-13.00	-38.62
897.35	V	-53.68	2.00	-51.68	-13.00	-38.68
98.05	H	-53.41	0.03	-53.38	-13.00	-40.38
241.36	H	-47.39	-8.30	-55.69	-13.00	-42.69
482.31	H	-54.25	-3.61	-57.86	-13.00	-44.86
662.87	H	-51.36	-1.56	-52.92	-13.00	-39.92
751.34	H	-54.25	0.23	-54.02	-13.00	-41.02
899.29	H	-54.33	2.13	-52.20	-13.00	-39.20

Note:

1. All Readings below 1GHz are Quasi-Peak, above are performed with peak and/or average measurements as necessary.
2. Measurement Level = Reading Level + Correct Factor



Engineer : Jeff	Time : 2011-11-21
Site : EMC Lab AC 102	Margin : 6
Limit : FCC_Part22&24	Probe : VERTICAL/ HORIZONTAL
EUT : Industrial Cellular Router	Note : GPRS 850 / TX / CH 251

Frequency (MHz)	Antenna Polarization	Reading (dBm)	Correction Factor (dB)	Emission level (dBm)	Limit (dBm)	Margin (dB)
31.28	V	-35.14	-17.68	-52.82	-13.00	-39.82
53.44	V	-40.36	-13.00	-53.36	-13.00	-40.36
112.41	V	-47.36	-5.90	-53.26	-13.00	-40.26
488.02	V	-46.28	-3.61	-49.89	-13.00	-36.89
663.74	V	-48.62	-1.93	-50.55	-13.00	-37.55
895.69	V	-52.45	2.00	-50.45	-13.00	-37.45
97.32	H	-52.14	0.03	-52.11	-13.00	-39.11
242.31	H	-46.02	-8.30	-54.32	-13.00	-41.32
483.62	H	-51.36	-3.61	-54.97	-13.00	-41.97
665.32	H	-50.36	-1.56	-51.92	-13.00	-38.92
753.02	H	-53.02	0.23	-52.79	-13.00	-39.79
897.02	H	-53.15	2.13	-51.02	-13.00	-38.02

Note:

1. All Readings below 1GHz are Quasi-Peak, above are performed with peak and/or average measurements as necessary.
2. Measurement Level = Reading Level + Correct Factor



Engineer : Jeff	Time :2011-11-21
Site : EMC Lab AC 102	Margin : 6
Limit : FCC_Part22&24	Probe : VERTICAL/ HORIZONTAL
EUT : Industrial Cellular Router	Note : GPRS 1900 / TX / CH 512

Frequency (MHz)	Antenna Polarization	Reading (dBm)	Correction Factor (dB)	Emission level (dBm)	Limit (dBm)	Margin (dB)
134.01	V	-39.41	-13.88	-53.29	-13.00	-40.29
226.89	V	-54.25	2.13	-52.12	-13.00	-39.12
400.00	V	-47.32	-5.36	-52.68	-13.00	-39.68
500.74	V	-49.42	-4.51	-53.93	-13.00	-40.93
697.54	V	-53.61	-0.93	-54.54	-13.00	-41.54
801.65	V	-52.52	0.54	-51.98	-13.00	-38.98
102.41	H	-39.41	-15.14	-54.55	-13.00	-41.55
194.21	H	-42.41	-13.34	-55.75	-13.00	-42.75
400.74	H	-48.64	-5.41	-54.05	-13.00	-41.05
460.51	H	-51.73	-4.18	-55.91	-13.00	-42.91
724.31	H	-55.56	0.22	-55.34	-13.00	-42.34
801.65	H	-55.62	1.22	-54.40	-13.00	-41.40

Note:

1. All Readings below 1GHz are Quasi-Peak, above are performed with peak and/or average measurements as necessary.
2. Measurement Level = Reading Level + Correct Factor



Engineer : Jeff	Time : 2011-11-21
Site : EMC Lab AC 102	Margin : 6
Limit : FCC_Part22&24	Probe : VERTICAL/ HORIZONTAL
EUT : Industrial Cellular Router	Note : GPRS 1900 / TX / CH 661

Frequency (MHz)	Antenna Polarization	Reading (dBm)	Correction Factor (dB)	Emission level (dBm)	Limit (dBm)	Margin (dB)
133.87	V	-40.32	-13.88	-54.20	-13.00	-41.20
225.14	V	-54.98	2.13	-52.85	-13.00	-39.85
403.02	V	-48.96	-5.36	-54.32	-13.00	-41.32
501.36	V	-51.36	-4.51	-55.87	-13.00	-42.87
694.25	V	-54.02	-0.93	-54.95	-13.00	-41.95
800.36	V	-53.69	0.54	-53.15	-13.00	-40.15
105.36	H	-38.47	-15.14	-53.61	-13.00	-40.61
195.36	H	-41.29	-13.34	-54.63	-13.00	-41.63
403.62	H	-52.98	-5.41	-58.39	-13.00	-45.39
461.58	H	-53.25	-4.18	-57.43	-13.00	-44.43
725.36	H	-56.41	0.22	-56.19	-13.00	-43.19
802.36	H	-56.48	1.22	-55.26	-13.00	-42.26

Note:

1. All Readings below 1GHz are Quasi-Peak, above are performed with peak and/or average measurements as necessary.
2. Measurement Level = Reading Level + Correct Factor



Engineer : Jeff	Time : 2011-11-21
Site : EMC Lab AC 102	Margin : 6
Limit : FCC_Part22&24	Probe : VERTICAL/ HORIZONTAL
EUT : Industrial Cellular Router	Note : GPRS 1900 / TX / CH 810

Frequency (MHz)	Antenna Polarization	Reading (dBm)	Correction Factor (dB)	Emission level (dBm)	Limit (dBm)	Margin (dB)
135.76	V	-38.58	-13.88	-52.46	-13.00	-39.46
205.24	V	-52.07	2.13	-49.94	-13.00	-36.94
401.16	V	-57.02	-5.36	-62.38	-13.00	-49.38
500.27	V	-50.32	-4.51	-54.83	-13.00	-41.83
695.43	V	-54.02	-0.93	-54.95	-13.00	-41.95
801.15	V	-52.14	0.54	-51.60	-13.00	-38.60
116.43	H	-39.25	-15.14	-54.39	-13.00	-41.39
194.57	H	-39.37	-13.34	-52.71	-13.00	-39.71
400.58	H	-53.24	-5.41	-58.65	-13.00	-45.65
500.68	H	-52.78	-4.18	-56.96	-13.00	-43.96
698.58	H	-55.25	0.22	-55.03	-13.00	-42.03
799.75	H	-54.31	1.22	-53.09	-13.00	-40.09

Note:

1. All Readings below 1GHz are Quasi-Peak, above are performed with peak and/or average measurements as necessary.
2. Measurement Level = Reading Level + Correct Factor



Above 1G:

Engineer : Jeff	Time : 2011-11-21
Site : EMC Lab AC 102	Margin : 6
Limit : FCC_Part22&24	Probe : VERTICAL/ HORIZONTAL
EUT : Industrial Cellular Router	Note : GPRS 850 / TX / CH 128

Frequency (MHz)	Antenna Polarization	Reading (dBm)	Correction Factor (dB)	Emission level (dBm)	Limit (dBm)	Margin (dB)
1648.36	V	-50.25	-2.12	-52.37	-13.00	-39.37
7002.36	V	-69.35	16.11	-53.24	-13.00	-40.24
1648.69	H	-52.23	-2.23	-54.46	-13.00	-41.46
7000.32	H	-68.24	12.80	-55.44	-13.00	-42.44

Note:

1. All Readings below 1GHz are Quasi-Peak, above are performed with peak and/or average measurements as necessary.
2. Measurement Level = Reading Level + Correct Factor



Engineer : Jeff	Time : 2011-11-21
Site : EMC Lab AC 102	Margin : 6
Limit : FCC_Part22&24	Probe : VERTICAL/ HORIZONTAL
EUT : Industrial Cellular Router	Note : GPRS 850 / TX / CH 190

Frequency (MHz)	Antenna Polarization	Reading (dBm)	Correction Factor (dB)	Emission level (dBm)	Limit (dBm)	Margin (dB)
1672.25	V	-50.25	-2.15	-52.40	-13.00	-39.40
7001.32	V	-70.36	16.11	-54.25	-13.00	-41.25
1670.25	H	-51.69	-2.26	-53.95	-13.00	-40.95
7001.33	H	-71.02	12.80	-58.22	-13.00	-45.22

Note:

1. All Readings below 1GHz are Quasi-Peak, above are performed with peak and/or average measurements as necessary.
2. Measurement Level = Reading Level + Correct Factor



Engineer : Jeff	Time : 2011-11-21
Site : EMC Lab AC 102	Margin : 6
Limit : FCC_Part22&24	Probe : VERTICAL/ HORIZONTAL
EUT : Industrial Cellular Router	Note : GPRS 850 / TX / CH 251

Frequency (MHz)	Antenna Polarization	Reading (dBm)	Correction Factor (dB)	Emission level (dBm)	Limit (dBm)	Margin (dB)
1695.28	V	-50.02	-2.17	-52.19	-13.00	-39.19
7002.36	V	-68.25	16.11	-52.14	-13.00	-39.14
1696.25	H	-51.03	-2.28	-53.31	-13.00	-40.31
7002.47	H	-69.45	12.80	-56.65	-13.00	-43.65

Note:

1. All Readings below 1GHz are Quasi-Peak, above are performed with peak and/or average measurements as necessary.
2. Measurement Level = Reading Level + Correct Factor



Engineer : Jeff	Time : 2011-11-21
Site : EMC Lab AC 102	Margin : 6
Limit : FCC_Part22&24	Probe : VERTICAL/ HORIZONTAL
EUT : Industrial Cellular Router	Note : GPRS 1900 / TX / CH 512

Frequency (MHz)	Antenna Polarization	Reading (dBm)	Correction Factor (dB)	Emission level (dBm)	Limit (dBm)	Margin (dB)
5395.45	V	-60.25	9.29	-50.96	-13.00	-37.96
7133.55	V	-69.25	16.11	-53.14	-13.00	-40.14
5437.57	H	-62.25	10.66	-51.59	-13.00	-38.59
7621.58	H	-70.39	15.68	-54.71	-13.00	-41.71

Note:

1. All Readings below 1GHz are Quasi-Peak, above are performed with peak and/or average measurements as necessary.
2. Measurement Level = Reading Level + Correct Factor



Engineer : Jeff	Time : 2011-11-21
Site : EMC Lab AC 102	Margin : 6
Limit : FCC_Part22&24	Probe : VERTICAL/ HORIZONTAL
EUT : Industrial Cellular Router	Note : GPRS 1900 / TX / CH 661

Frequency (MHz)	Antenna Polarization	Reading (dBm)	Correction Factor (dB)	Emission level (dBm)	Limit (dBm)	Margin (dB)
5640.00	V	-60.75	10.72	-50.03	-13.00	-37.03
7348.21	V	-66.36	12.48	-53.88	-13.00	-40.88
5640.24	H	-63.35	11.26	-52.09	-13.00	-39.09
7307.22	H	-71.69	16.21	-55.48	-13.00	-42.48

Note:

1. All Readings below 1GHz are Quasi-Peak, above are performed with peak and/or average measurements as necessary.
2. Measurement Level = Reading Level + Correct Factor



Engineer : Jeff	Time : 2011-11-21
Site : EMC Lab AC 102	Margin : 6
Limit : FCC_Part22&24	Probe : VERTICAL/ HORIZONTAL
EUT : Industrial Cellular Router	Note : GPRS 1900 / TX / CH 810

Frequency (MHz)	Antenna Polarization	Reading (dBm)	Correction Factor (dB)	Emission level (dBm)	Limit (dBm)	Margin (dB)
5161.00	V	-61.57	8.99	-52.58	-13.00	-39.58
7075.55	V	-70.25	16.21	-54.04	-13.00	-41.04
5192.42	H	-64.25	9.68	-54.57	-13.00	-41.57
7073.25	H	-72.36	16.21	-56.15	-13.00	-43.15

Note:

1. All Readings below 1GHz are Quasi-Peak, above are performed with peak and/or average measurements as necessary.
2. Measurement Level = Reading Level + Correct Factor



5. Occupied Bandwidth

5.1. Test Limit

According to §FCC 2.1049.

5.2. Test Procedures

The EUT's output RF connector was connected with a short cable to the spectrum analyzer, RBW was set to about 1% of emission BW, VBW is set to 3 times the RBW, -26dBc display line was placed on the screen (or 99% bandwidth), the occupied bandwidth is the delta frequency between the two points where the display line intersects the signal trace.

5.3. Test Setup Layout

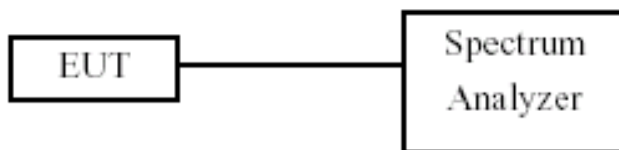

5.4. Measurement Equipment

Instrument/Ancillary	Model No.	Manufacturer	Serial No.	Calibration Date
Spectrum Analyzer	R&S	FSP40	100324	2011.08.14
Temperature/ Humidity Meter	Zhicheng	ZC1-11	CEP-TH-002	2011.08.17



5.5. Test Result and Data

Test Item	Occupied Bandwidth
Test Mode	GPRS 850
Test Date	2011-11-16

Channel No.	Frequency (MHz)	Measurement Level (kHz)
128	824.20	244.00
190	836.40	242.00
251	848.80	244.00

Channel 128

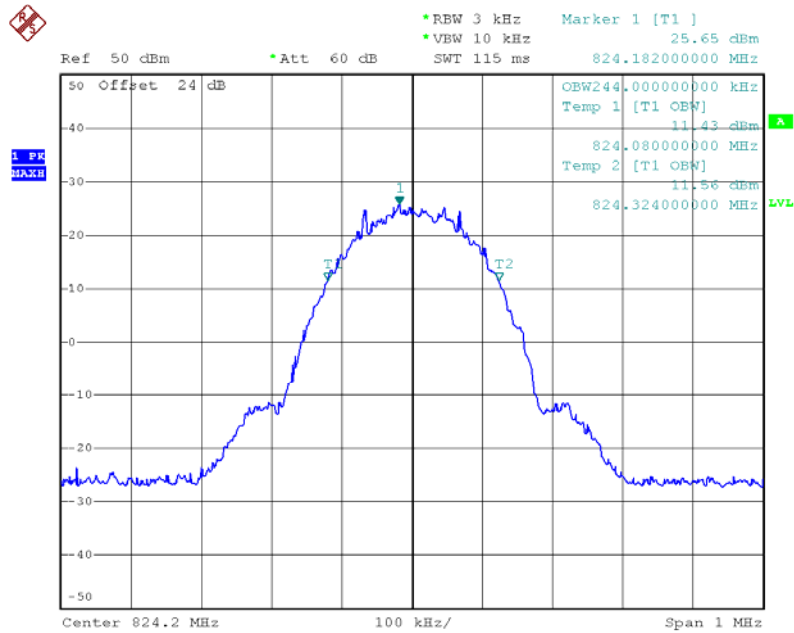

Date: 16.NOV.2011 11:02:14



Channel 190

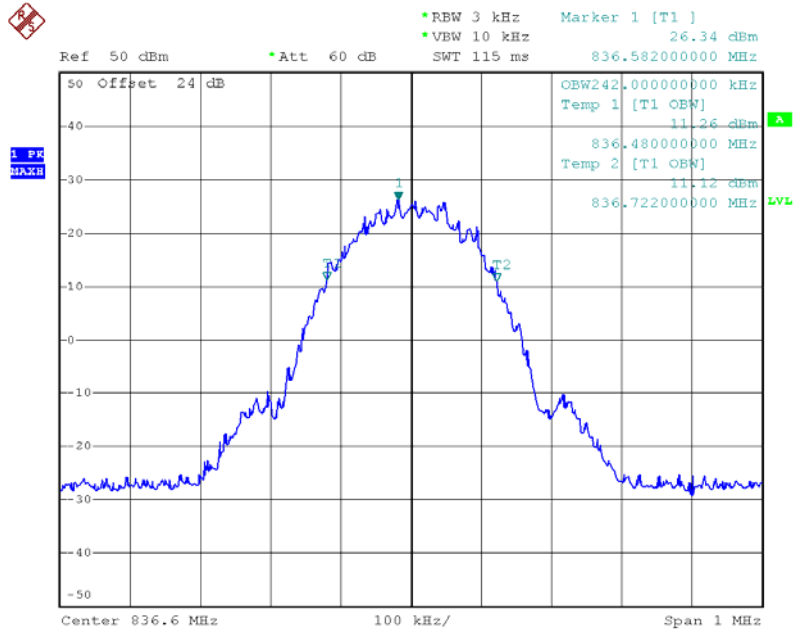

Date: 16.NOV.2011 11:03:56

Channel 251

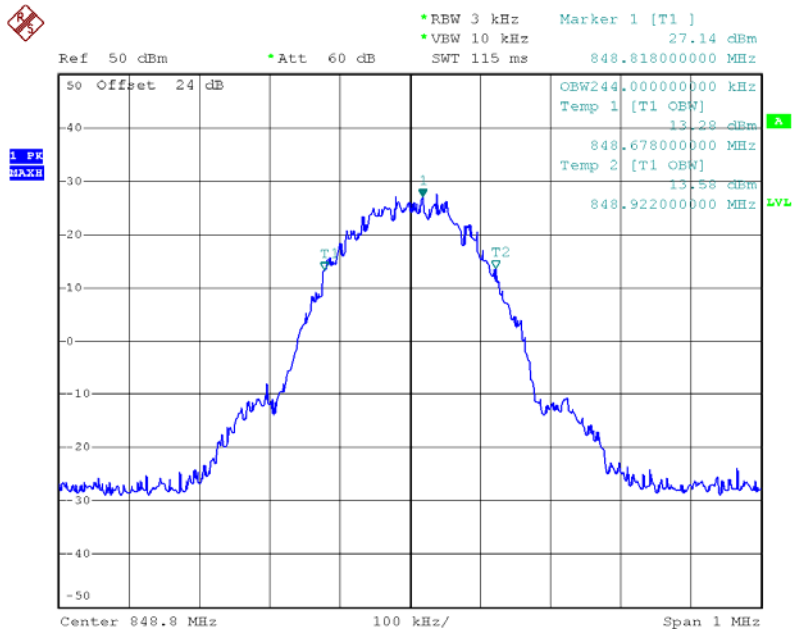

Date: 16.NOV.2011 11:04:51



Test Item	Occupied Bandwidth
Test Mode	GPRS 1900
Test Date	2011-11-16

Channel No.	Frequency (MHz)	Measurement Level (kHz)
512	1850.20	248.00
661	1880.00	242.00
810	1909.80	242.00

Channel 512

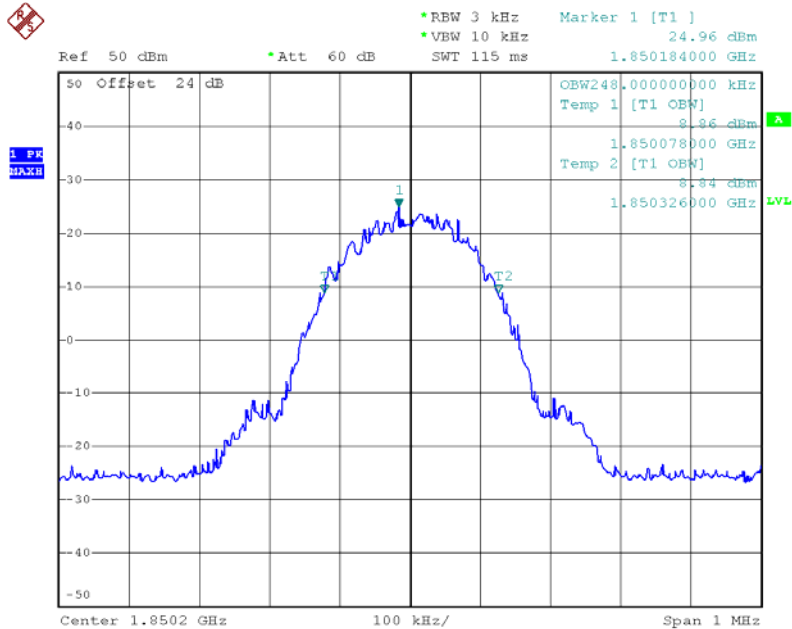

Date: 16.NOV.2011 11:13:12



Channel 661

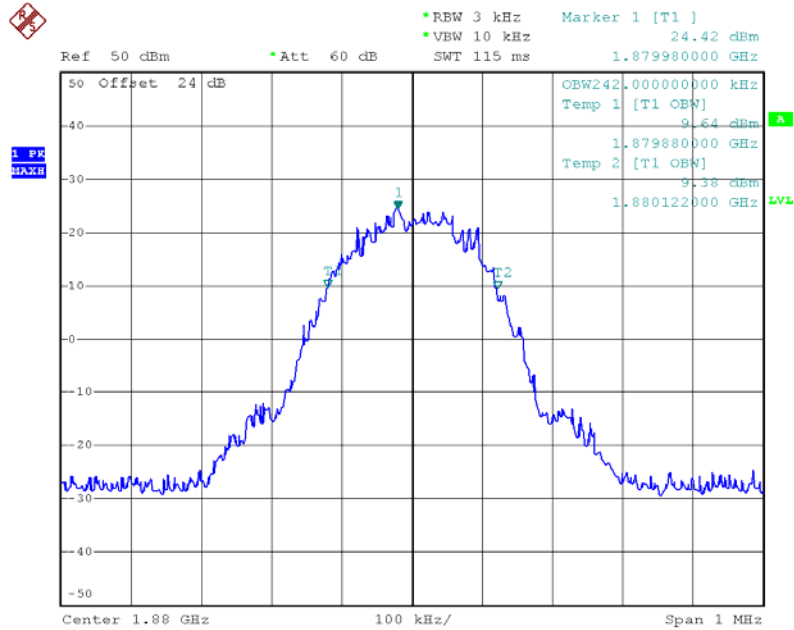

Date: 16.NOV.2011 11:13:47

Channel 810

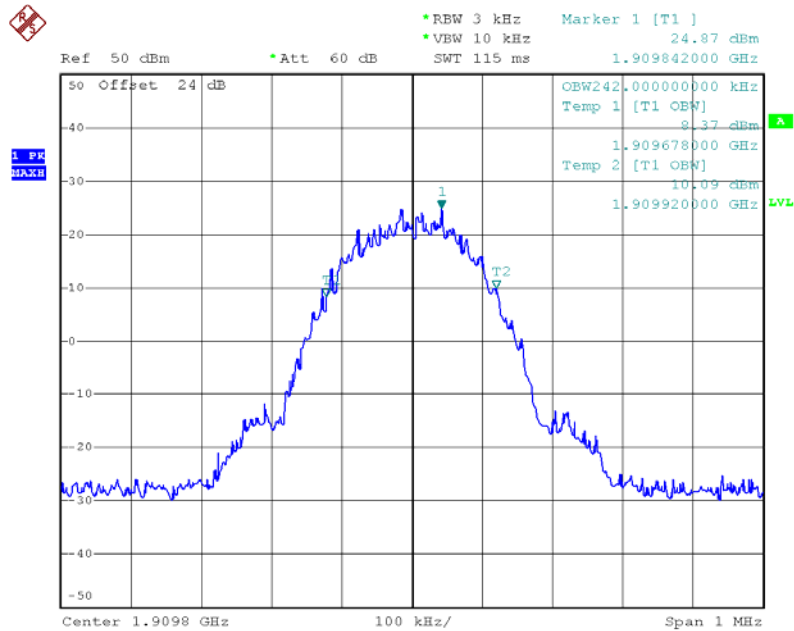

Date: 16.NOV.2011 11:15:14



6. Maximum Peak Output Power

6.1. Test Limit

According to FCC §2.1046.

6.2. Test Procedure

The transmitter output was connected to a calibrated attenuator, the other end of which was connected to a power meter. Transmitter output was read off the power meter in dBm. The power output at the transmitter antenna port was determined by adding the value of the attenuator to the power meter reading.

6.3. Test Setup Layout

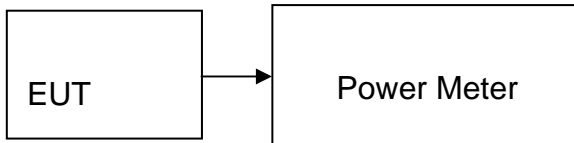

6.4. Measurement Equipment

Instrument/Ancillary	Model No.	Manufacturer	Serial No.	Calibration Date
Power Meter	NRP	R&S	CCE013	2011.01.15
Power Sensor	NRP-Z91	R&S	100385	2011.01.15
Temperature/ Humidity Meter	Zhicheng	ZC1-11	CEP-TH-002	2011.08.17



6.5. Test Result and Data

Test Item	Maximum Peak Output Power
Test Mode	GPRS 850
Test Date	2011-11-16

Channel No.	Frequency (MHz)	Measurement (dBm)
128	824.20	31.15
190	836.40	32.02
251	848.80	33.19

Test Item	Maximum Peak Output Power
Test Mode	GPRS 1900
Test Date	2011-11-16

Channel No.	Frequency (MHz)	Measurement (dBm)
512	1850.20	28.87
661	1880.00	29.67
810	1910.00	28.84



7. ERP & EIRP MEASUREMENT

7.1. Test Limit

According to FCC §2.1046

FCC 22.913(a): The Effective Radiated Power (ERP) of mobile transmitters must not exceed 7 Watts.

FCC 24.232(b): The equivalent Isotropic Radiated Power (EIRP) must not exceed 2 Watts.

7.2. Test Procedure

The EUT was placed on a non-conductive turntable using a non-conductive support. The radiated emission at the fundamental frequency was measured at 3 m with a test antenna and EMI spectrum analyzer.

During the measurement of the EUT, the resolution bandwidth was set to 3MHz and the average bandwidth was set to 3MHz. The highest emission was recorded with the rotation of the turntable and the lowering of the test antenna. The reading was recorded and the field strength (E in dBuV/m) was calculated.

ERP in frequency band 824-849MHz, and EIRP in frequency band 1850 –1910MHz were measured using a substitution method. The EUT was replaced by half-wave dipole (824-849MHz) or horn antenna (1850-1910MHz) connected to a signal generator. The spectrum analyzer reading was recorded and ERP/EIRP was calculated as follows:

$$\text{ERP} = \text{S.G. output (dBm)} + \text{Antenna Gain (dBd)} - \text{Cable (dB)}$$

$$\text{EIRP} = \text{S.G. output (dBm)} + \text{Antenna Gain (dBi)} - \text{Cable (dB)}$$



7.3. Test Setup Layout

Below 1 GHz

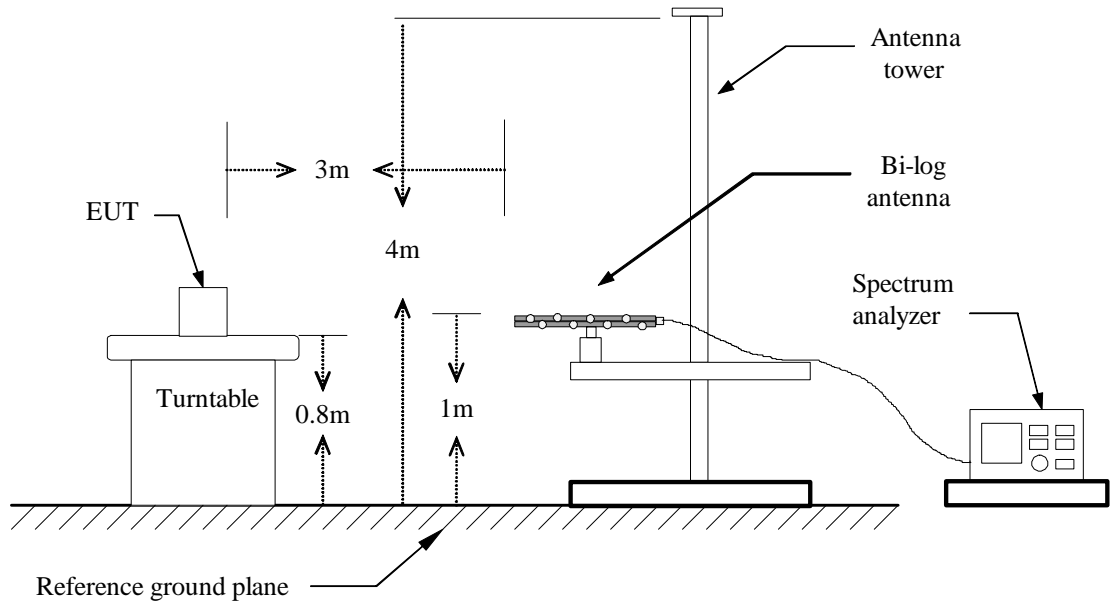

Above 1 GHz

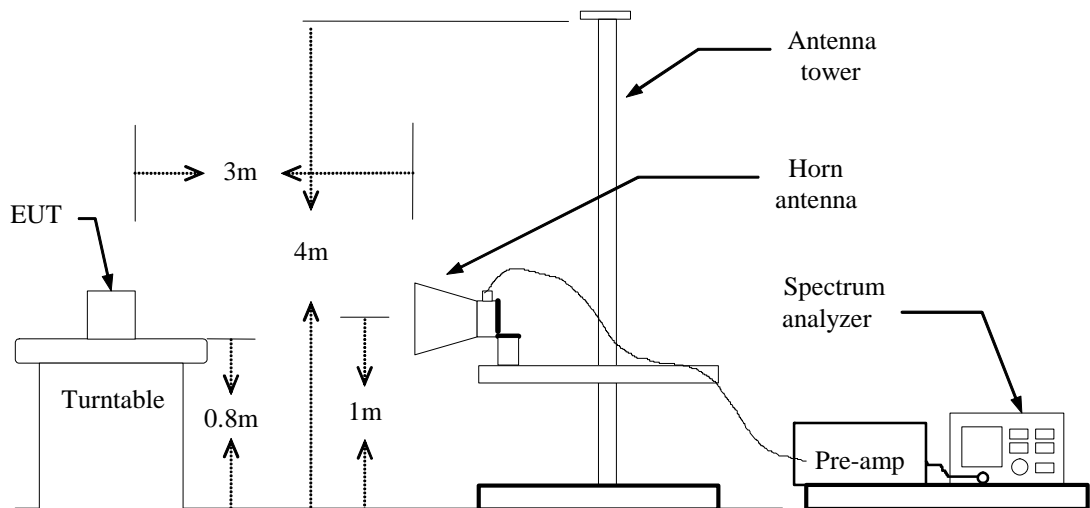



For Substituted Method Test Set-UP

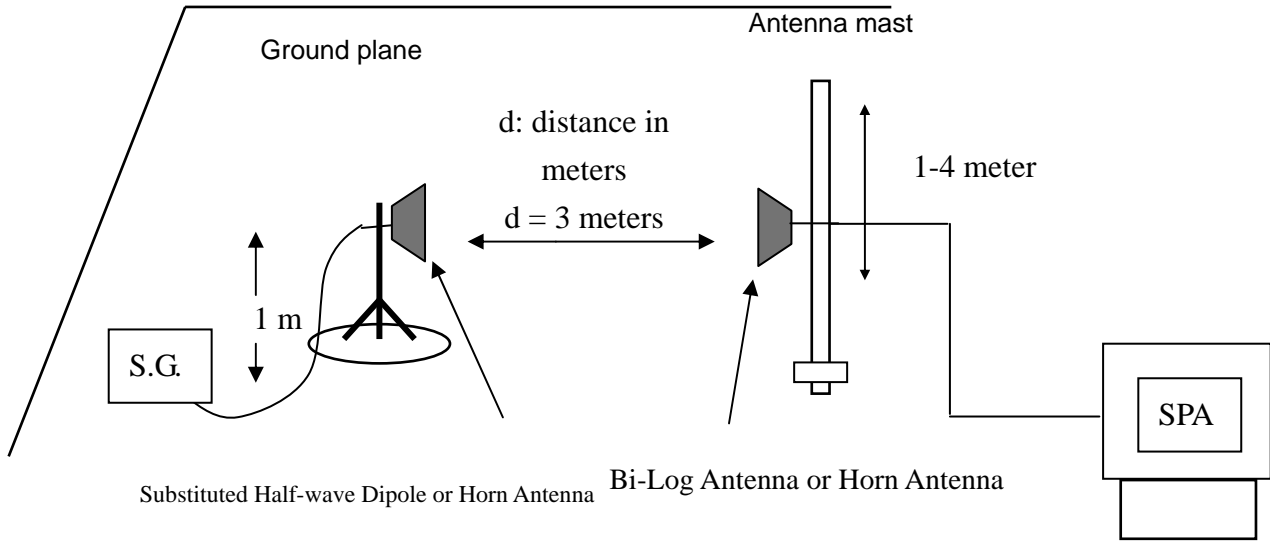

7.4. Measurement Equipment

Instrument/Ancillary	Model No.	Manufacturer	Serial No.	Calibration Date
Spectrum Analyzer	R&S	FSP40	100324	2011.08.14
H64 Amplifier	HP	8447F	3113A05582	2011.08.14
Preamplifier	Agilent	8449B	ED-HE-EMI-077	2011.02.10
Broad-Band Horn Antenna	Schwarzbeck	BBHA9120D	9120D-619	2011.11.10
Temperature/Humidity Meter	Zhicheng	ZC1-11	CEP-TH-002	2011.08.17



7.5. Test Result and Data

GPRS 850 TEST DATA

Channel	Frequency (MHz)	Antenna Pol.	Reading level (dB)	Correction Factor (dB)	Emission level (dBm)	Limit (dBm)	Margin (dB)
128	824.2	V	31.75	1.01	32.76	38.5	-5.74
	824.2	H	30.64	0.96	31.60	38.5	-6.9
190	836.6	V	31.75	1.77	33.52	38.5	-4.98
	836.6	H	31.26	1.46	32.72	38.5	-5.78
251	848.8	V	29.64	1.85	31.49	38.5	-7.01
	848.8	H	29.75	1.54	31.29	38.5	-7.21

GPRS 1900 TEST DATA

Channel	Frequency (MHz)	Antenna Pol.	Reading level (dB)	Correction Factor (dB)	Emission level (dBm)	Limit (dBm)	Margin (dB)
512	1850.20	V	26.75	-1.7	25.05	33	-7.95
	1850.20	H	25.05	-1.74	23.31	33	-9.69
661	1880.00	V	25.31	-1.71	23.60	33	-9.4
	1880.00	H	24.60	-1.76	22.84	33	-10.16
810	1909.80	V	22.84	-1.67	21.17	33	-11.83
	1909.80	H	21.17	-1.42	19.75	33	-13.25



8. OUT OF BAND EMISSION AT ANTENNA TERMINALS

8.1. Test Limit

According to FCC §2.1051, FCC §22.917, FCC §24.238(a).

Out of Band Emissions: The mean power of emission must be attenuated below the mean power of the non-modulated carrier (P) on any frequency twice or more than twice the fundamental frequency by at least $43 + 10 \log P$ dB.

Mobile Emissions in Base Frequency Range: The mean power of any emissions appearing in the base station frequency range from cellular mobile transmitters operated must be attenuated to a level not exceed -80 dBm at the transmit antenna connector.

Band Edge Requirements: In the 1MHz bands immediately outside and adjacent to the frequency block, a resolution bandwidth of at least 1% of the emission bandwidth of the fundamental emission of the transmitter may be employed to measure the Out of band Emission.

8.2. Test Procedure

The RF output of the transceiver was connected to a spectrum analyzer through appropriate attenuation. The resolution bandwidth of the spectrum analyzer was set at 1MHz, sufficient scans were taken to show the out of band Emissions if any up to 10th harmonic.

For the out of band: Set the RBW, VBW = 1MHz, Start=30MHz, Stop= 10 th harmonic. Limit = -13dBm

Band Edge Requirements (824 MHz and 849 MHz /1850MHz and 1910MHz): In the 1 MHz bands immediately outside and adjacent to the frequency block, a resolution bandwidth of at least 1 percent of the emission bandwidth of the fundamental emission of the transmitter may be employed to measure the out of band Emissions. Limit, -13dBm.

8.3. Test Setup Layout

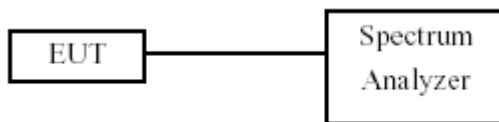

8.4. Measurement Equipment

Instrument/Ancillary	Model No.	Manufacturer	Serial No.	Calibration Date
Spectrum Analyzer	R&S	FSP40	100324	2011.08.14
Temperature/ Humidity Meter	Zhicheng	ZC1-11	CEP-TH-002	2011.08.17



8.5. Test Result and Data

Test Item	Conducted spurious emissions, 30MHz - 20GHz
Test Mode	GPRS 850
Test Date	2011-11-16

Channel 128

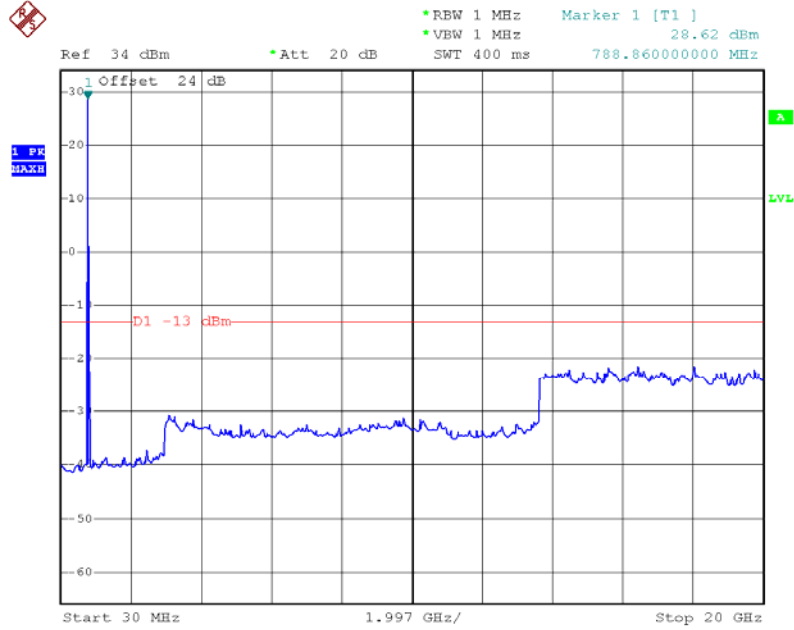

Date: 16.NOV.2011 11:44:43



Channel 190

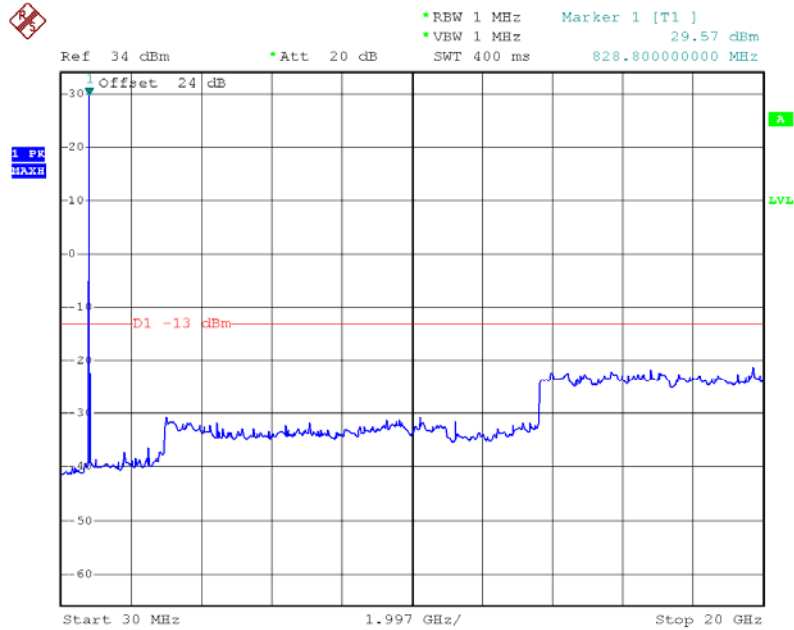

Date: 16.NOV.2011 11:43:35

Channel 251

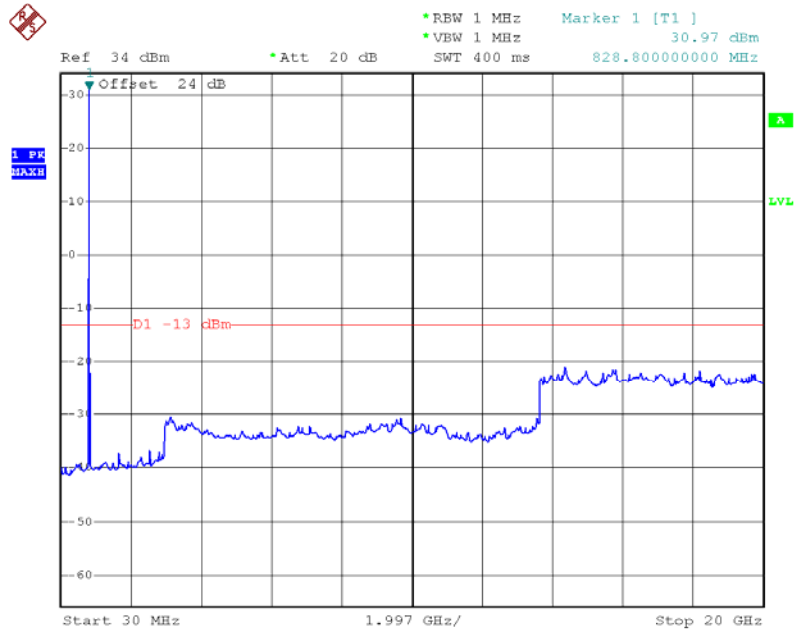

Date: 16.NOV.2011 11:42:56



Test Item	Conducted spurious emissions, 30MHz - 20GHz
Test Mode	GPRS 1900
Test Date	2011-11-16

Channel 512

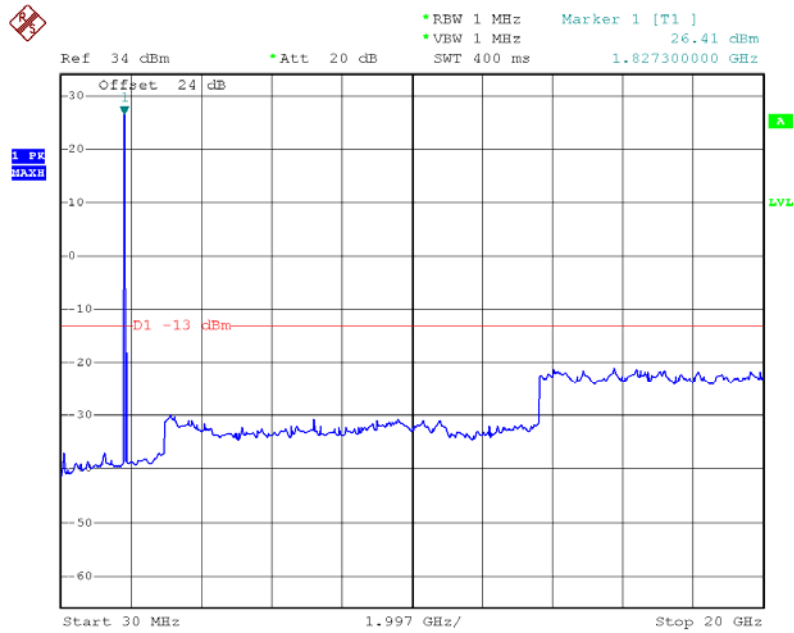

Date: 16.NOV.2011 11:26:38



Channel 661

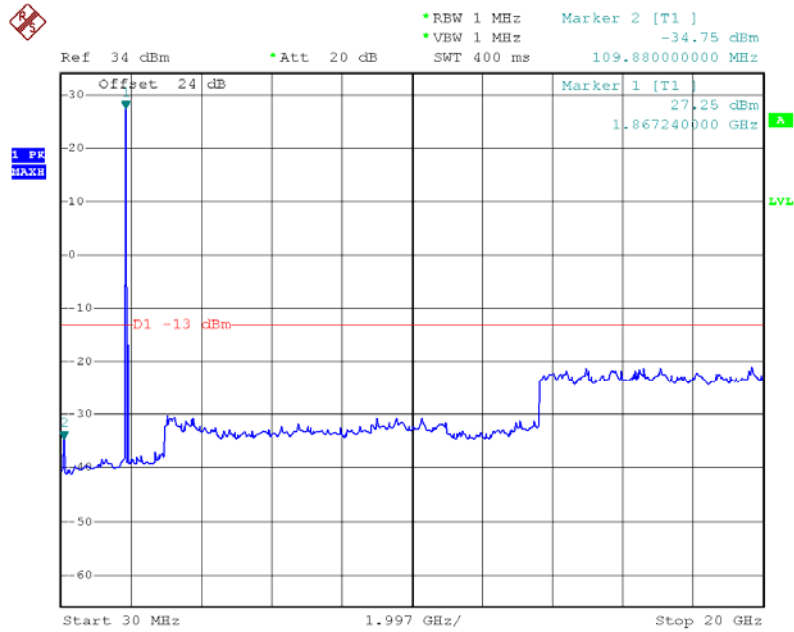

Date: 16.NOV.2011 11:28:07

Channel 810

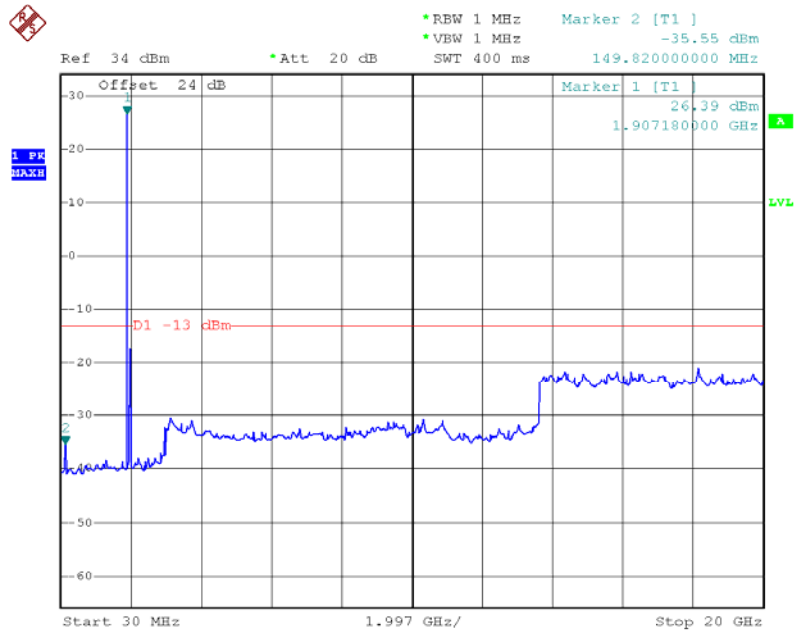

Date: 16.NOV.2011 11:29:32



Test Item	Band Edge emissions
Test Mode	GPRS 850
Test Date	2011-11-16

Channel 128

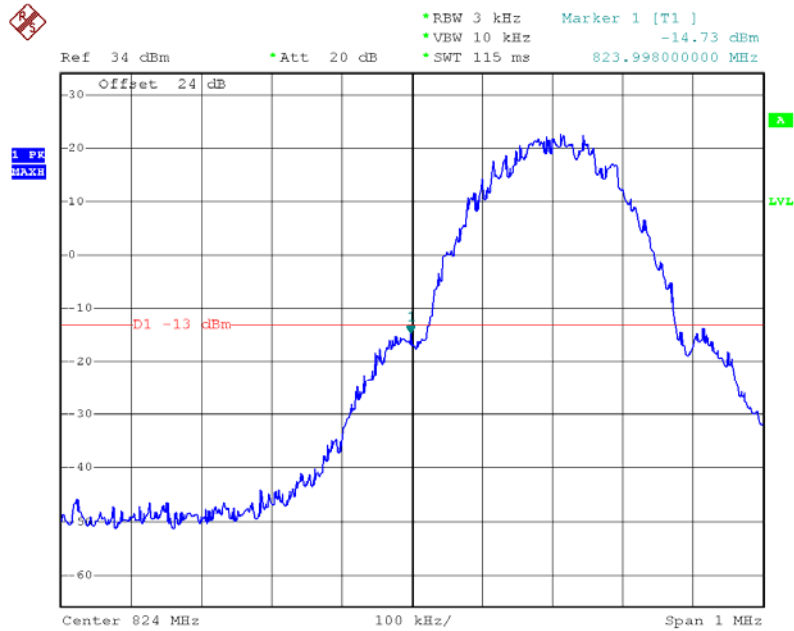

Date: 16.NOV.2011 11:38:40

Channel 251

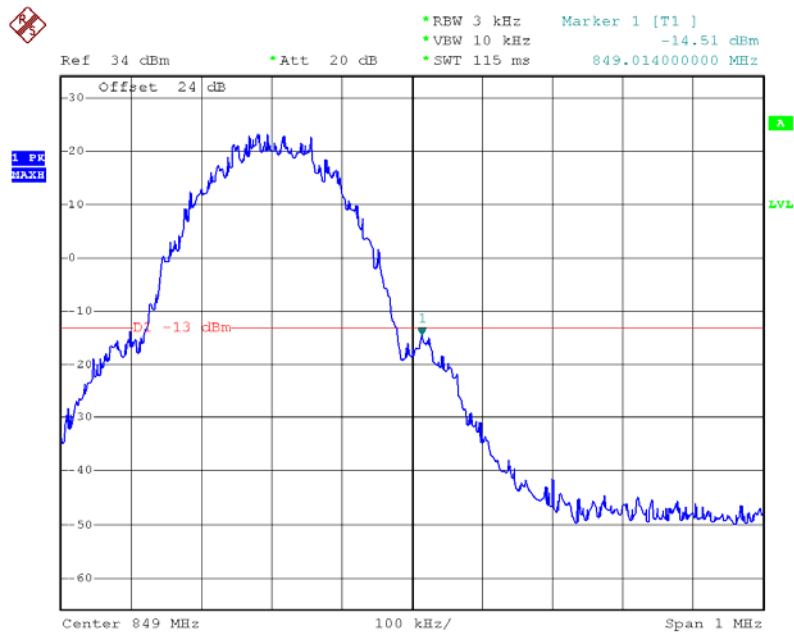

Date: 16.NOV.2011 11:40:40



Test Item	Band Edge emissions
Test Mode	GPRS 1900
Test Date	2011-11-16

Channel 512

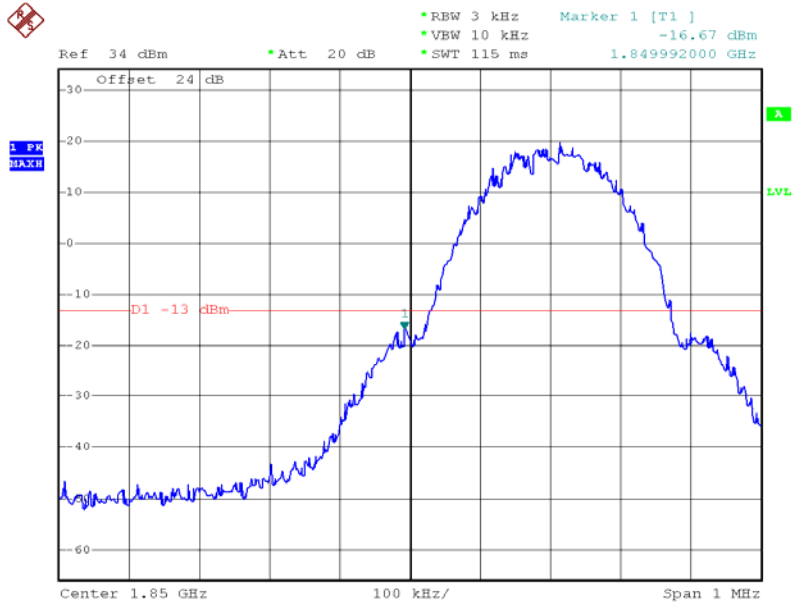

Date: 16.NOV.2011 11:31:45

Channel 810

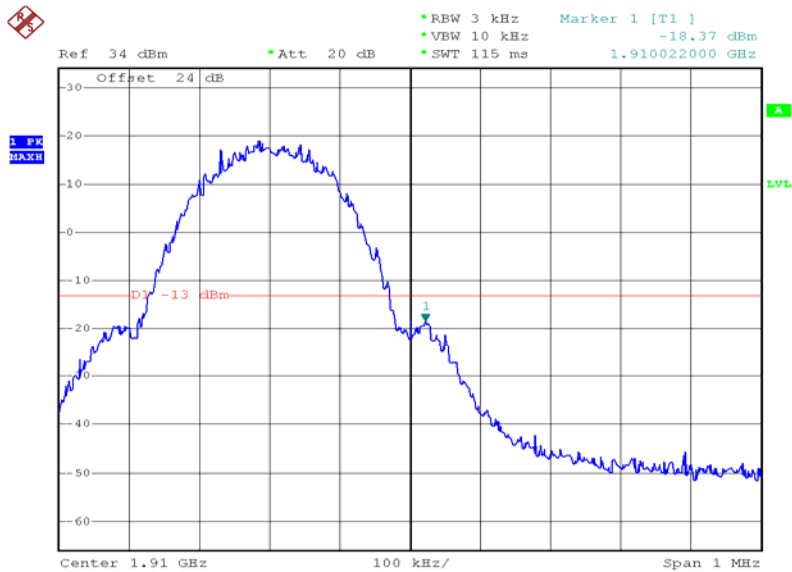

Date: 16.NOV.2011 11:30:45



9. FREQUENCY STABILITY V.S. TEMPERATURE MEASUREMENT

9.1. Test Limit

According to FCC §2.1055, FCC §22.355, .FCC §24.235.

Frequency Tolerance: 2.5 ppm

9.2. Test Procedure

The equipment under test was connected to an external AC or DC power supply and input rated voltage. RF output was connected to a frequency counter or spectrum analyzer via feed through attenuators. The EUT was placed inside the temperature chamber. Set the spectrum analyzer RBW low enough to obtain the desired frequency resolution and measure EUT 20°C operating frequency as reference frequency. Turn EUT off and set the chamber temperature to -30°C. After the temperature stabilized for approximately 30 minutes recorded the frequency. Repeat step measure with 10°C increased per stage until the highest temperature of +50°C reached.

9.3. Test Setup Layout

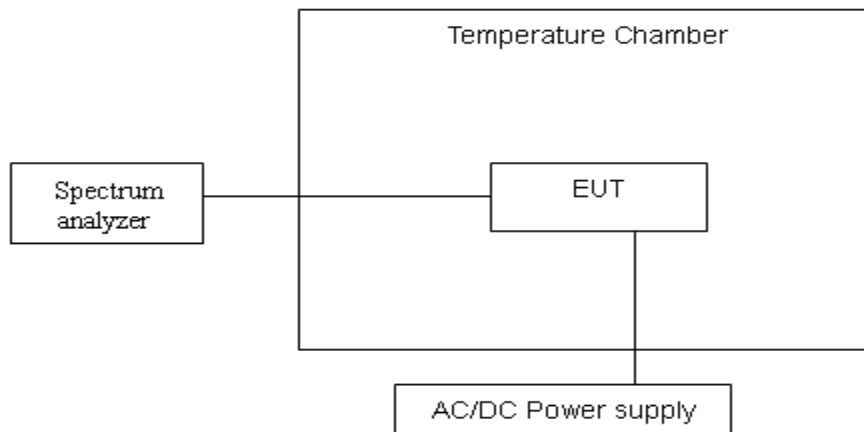

9.4. Measurement Equipment

Instrument/Ancillary	Model No.	Manufacturer	Serial No.	Calibration Date
Spectrum Analyzer	R&S	FSP40	100324	2011.08.14
Temperature/ Humidity Meter	Zhicheng	ZC1-11	CEP-TH-002	2011.08.17



9.5. Test Result and Data

Test Item	Power Spectral Density
Test Mode	GPRS 850 Channel 190
Test Date	2011-11-21

Reference Frequency: GPRS Mid Channel 836.6 MHz @ 20°C				
Limit: +/- 2.5 ppm = 2090 Hz				
Power Supply Vac	Environment Temperature (°C)	Frequency (Hz)	Delta (Hz)	Limit (Hz)
30	50	83660018	33	2090
	40	83660020	35	
	30	83660024	39	
	20	83659985	0	
	10	83660014	29	
	0	83660017	32	
	-10	83660010	25	
	-20	83660023	38	
	-25	83660024	39	

Test Item	Power Spectral Density
Test Mode	GPRS 1900 Channel 661
Test Date	2011-11-21

Reference Frequency: GPRS Mid Channel 1880 MHz @ 20°C				
Limit: ± 2.5 ppm = 4700 Hz				
Power Supply Vac	Environment Temperature (°C)	Frequency (Hz)	Delta (Hz)	Limit (Hz)
30	45	1880000050	96	4700
	40	1880000047	93	
	30	1880000051	97	
	20	1879999954	0	
	10	1880000045	91	
	0	1880000052	98	
	-10	1880000047	93	
	-20	1880000051	97	
	-25	1880000046	92	



10. REQUENCY STABILITY V.S. VOLTAGE MEASUREMENT

10.1. Test Limit

According to FCC §2.1055, FCC §22.355, .FCC §24.235.

10.2. Test Procedure

Set chamber temperature to 20°C. Use a variable AC power supply / DC power source to power the EUT and set the voltage to rated voltage. Set the spectrum analyzer RBW low enough to obtain the desired frequency resolution and recorded the frequency.

Reduce the input voltage to specify extreme voltage variation ($\pm 10\%$) and endpoint, record the maximum frequency change.

10.3. Test Setup Layout

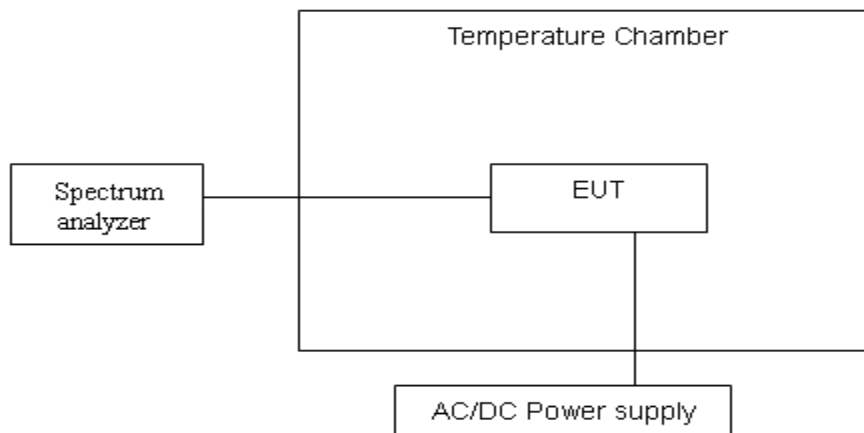

10.4. Measurement Equipment

Instrument/Ancillary	Model No.	Manufacturer	Serial No.	Calibration Date
Spectrum Analyzer	R&S	FSP40	100324	2011.08.14
Temperature/ Humidity Meter	Zhicheng	ZC1-11	CEP-TH-002	2011.08.17



10.5.Test Result and Data

Test Item	Power Spectral Density
Test Mode	GPRS 850 Channel 190
Test Date	2011-11-21

Reference Frequency: GPRS Mid Channel 836.6 MHz @ 20°C				
Limit: ± 2.5 ppm = 2090Hz				
Power Supply Vac	Environment Temperature (°C)	Frequency (Hz)	Delta (Hz)	Limit (Hz)
52.8	20	83599987	2	2090
30		83599985	0	
10.8		83599982	-3	

Test Item	Power Spectral Density
Test Mode	GPRS 1900 Channel 661
Test Date	2011-11-21

Reference Frequency: GPRS Mid Channel 1880 MHz @ 20°C				
Limit: ± 2.5 ppm = 4700 Hz				
Power Supply Vac	Environment Temperature (°C)	Frequency (Hz)	Delta (Hz)	Limit (Hz)
52.8	20	1879999950	-4	4700
30		1879999954	0	
10.8		1879999951	-3	