

CONTRACT NO. 025104		COMPANY NAME Texas Instruments			
APPROVALS	DATE	DWG CC2540 Sensor Node			
DRAWN	AAC	SIZE	FSCM NO.	DWG NO.	REV.
CHECKED		A4			1.2
ISSUED		SCALE		SHEET 1(3)	

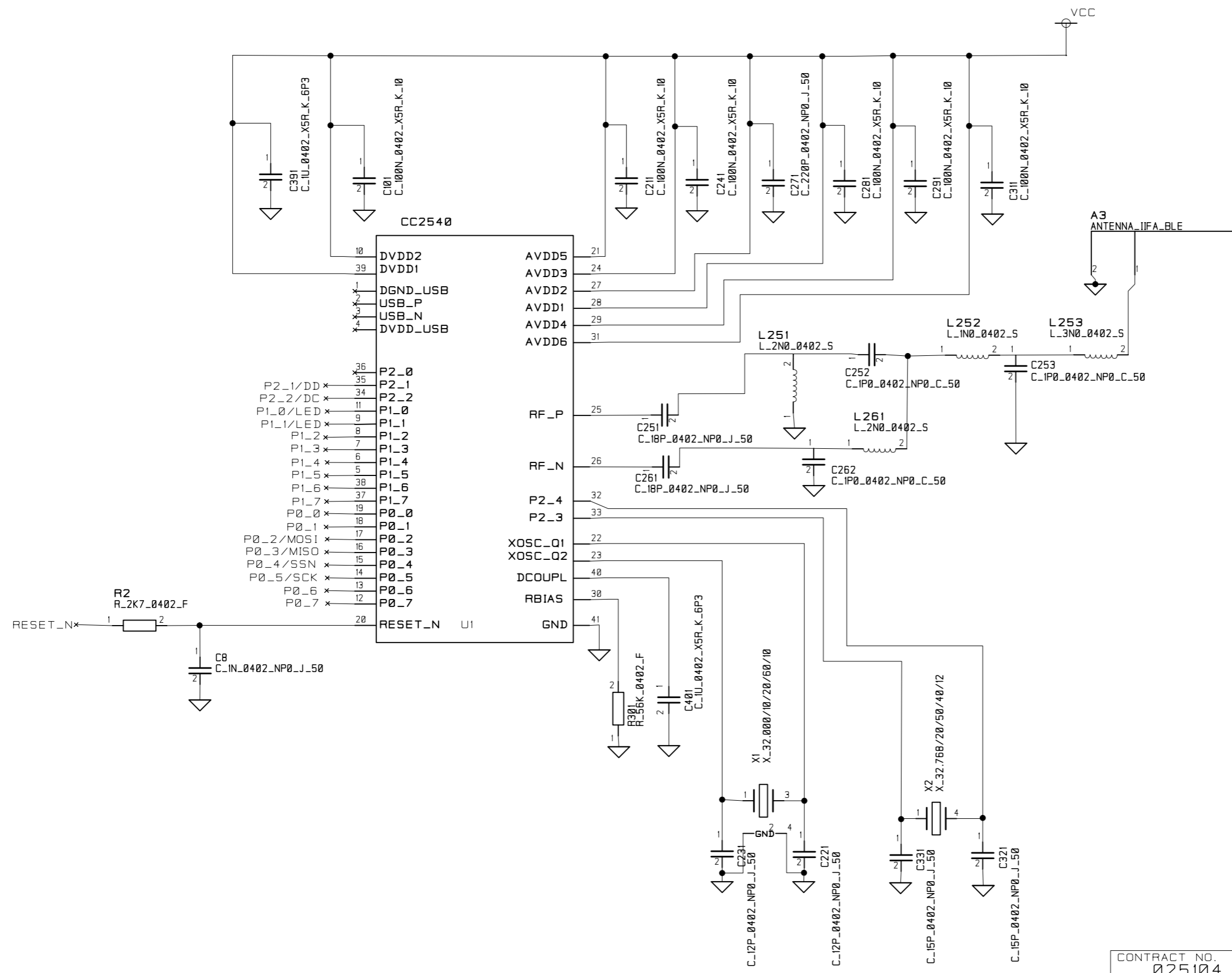

Not mount: R10

CONTRACT NO. 025104		COMPANY NAME Texas Instruments			
APPROVALS	DATE	DWG CC2540 RF-SOC			
DRAWN	AAC	SIZE	FSCM NO.	DWG NO.	REV. 1.2
CHECKED		A4			
ISSUED		SCALE			SHEET 3(3)

SoC Debug/Flash

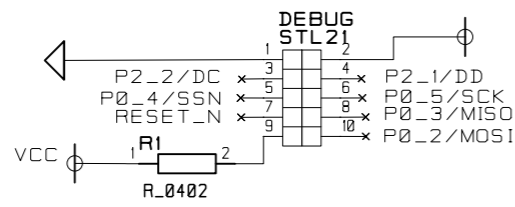

Additional testpins

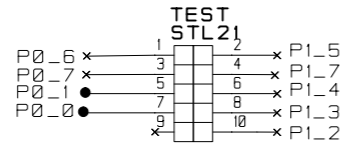

Coin Cell Batt.

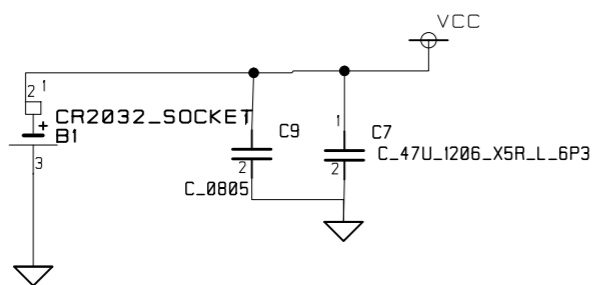

Not mount: C9

Leds

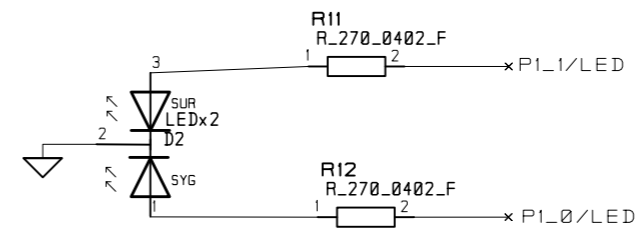

Buttons

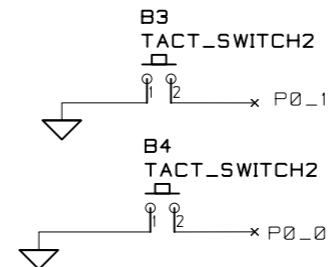

Buzzer

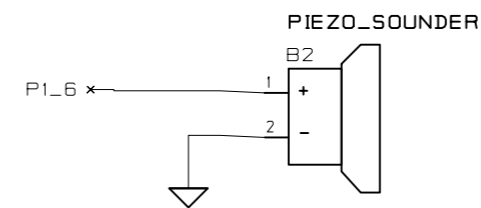

Acc meter

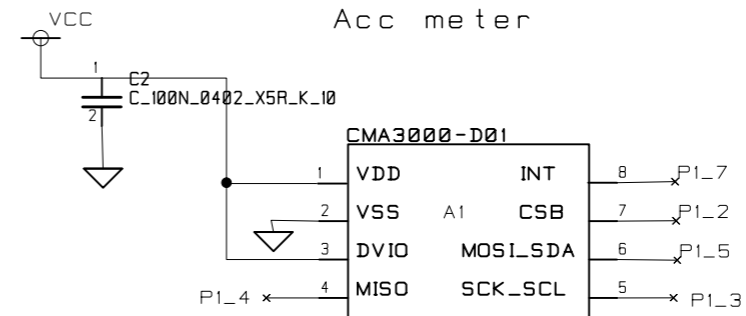

CONTRACT NO. 025104		COMPANY NAME Texas Instruments			
APPROVALS	DATE	DWG CC2540 Sensor Node			
DRAWN	AAC	SIZE	FSCM NO.	DWG NO.	REV. 1.2
CHECKED		A4			
ISSUED		SCALE			SHEET 4 (3)