

FIDUCIAL_MARK_IMM
FM3

FIDUCIAL_MARK_IMM
FM2

FIDUCIAL_MARK_IMM
FM1

BATTERY SOLUTION

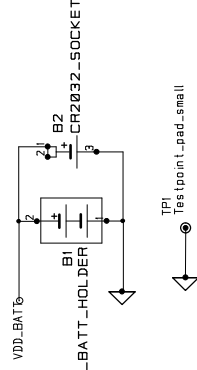

POWER SUPPLY JUMPER

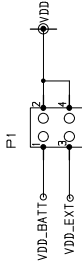

PINROW_SMD_2X2-2.54MM
Default jumper setting: 1-2

GREEN LED

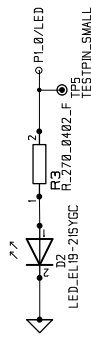

RED LED

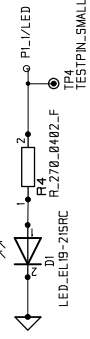

PUSH BUTTONS

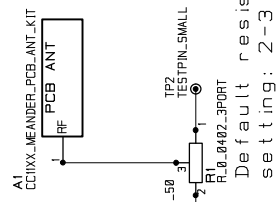
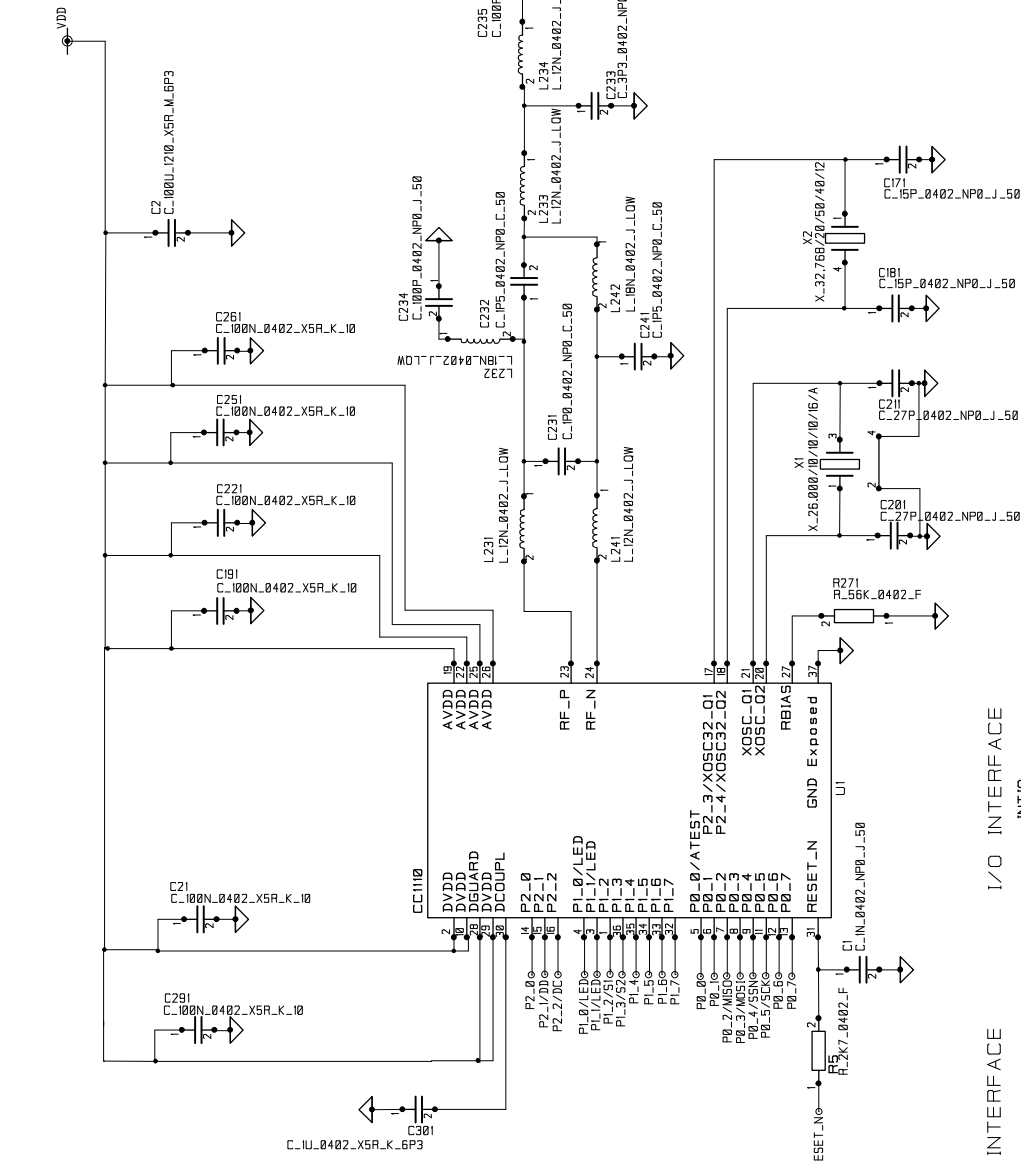
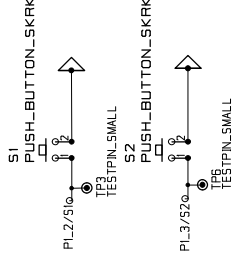

I/O INTERFACE

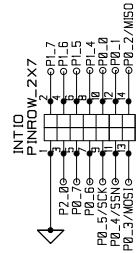

DEBUG INTERFACE

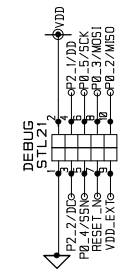

CONTRACT NO. 025114		COMPANY NAME Texas Instruments Norway	
APPROVALS	DATE	DWG	SmartRFCC1110-868
DRAWN	CHS	SIZE	A3
CHECKED		FSEM NO.	1,3
ISSUED		SCALE	SHEET 1 (1)

Not mount: INT10, R2