

OnBoard 2.4 GHz SMD - Antenna

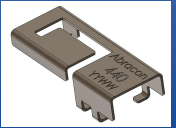

PRO-OB-440

Request Samples



Check Inventory



13.75 x 5.23 x 3.53 mm
RoHS/RoHS II Compliant
MSL Level = 1

Features

- Compact
- Low Cost
- Mixed Linear Polarization
- Peak Gain of 5.2 dBi
- Efficiency > 65%
- Surface Mount
- Durable-Shelf life of up to 10 years

Applications

- 2.4 GHz - Wi-Fi/BT/BLE/ZigBee/ISM
- IoT, M2M
 - Industrial IoT
 - Consumer IoT
 - Medical IoT
- Telemetry
- Wireless Remote Control
- Personal Area Networks (PAN)
- Industrial/Commercial Equipments

Product Image

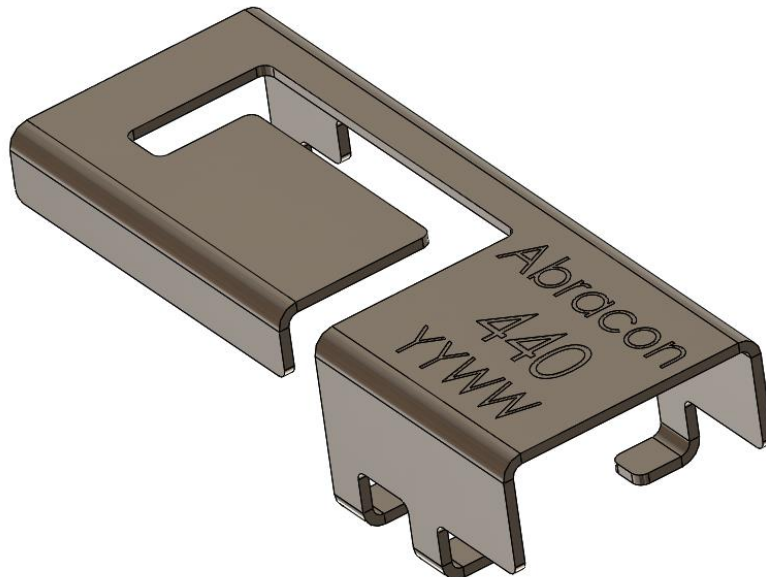

5101 Hidden Creek Ln Spicewood TX 78669
Phone: 512-371-6159 | Fax: 512-351-8858
For terms and conditions of sales, please visit:
www.abracon.com

REVISED:

ABRACON IS
ISO9001-2015
CERTIFIED

OnBoard 2.4 GHz SMD - Antenna

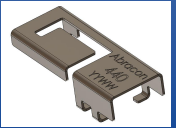

PRO-OB-440

Request Samples



Check Inventory



13.75 x 5.23 x 3.53 mm
RoHS/RoHS II Compliant
MSL Level = 1

Electrical Specification

Parameter	Specification	Unit
Operating Frequency	2400 - 2500	MHz
Center Frequency	2450	
Return Loss	< -6.9	dB
Polarization	Mixed Linear	-
Peak Gain	5.2	dBi
Efficiency	> 65	%
Impedance	50	Ω

Note: All measurements were conducted on the evaluation board in free space. Performance will vary depending on the ground plane, application, and environment.

Mechanical Specification

Parameter	Specification
Antenna Dimension	13.75 x 5.23 x 3.53 mm
Evaluation board Dimension	100 x 50 mm
Mounting Type	Surface Mount

Environmental Specification

Parameter	Specification
Operating Temperature	-40°C to +125°C
Storage Temperature	
Maximum Temperature	
RoHS Compliance	Yes Compliant with EU directive 2011/65/EU and 2015/863
Shelf life	10 years
MSL	Level 1, unlimited
Mechanical resistance	Immunity to vibrations IEC/EN 60068-2-6, Fc test Immunity to shock IEC/EN 60068-2-27, Ea test



5101 Hidden Creek Ln Spicewood TX 78669
Phone: 512-371-6159 | Fax: 512-351-8858
For terms and conditions of sales, please visit:
www.abracon.com

REVISED:

ABRACON IS
ISO9001-2015
CERTIFIED

OnBoard 2.4 GHz SMD - Antenna

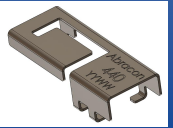

PRO-OB-440

Request Samples



Check Inventory



13.75 x 5.23 x 3.53 mm
RoHS/RoHS II Compliant
MSL Level = 1

Product Dimension

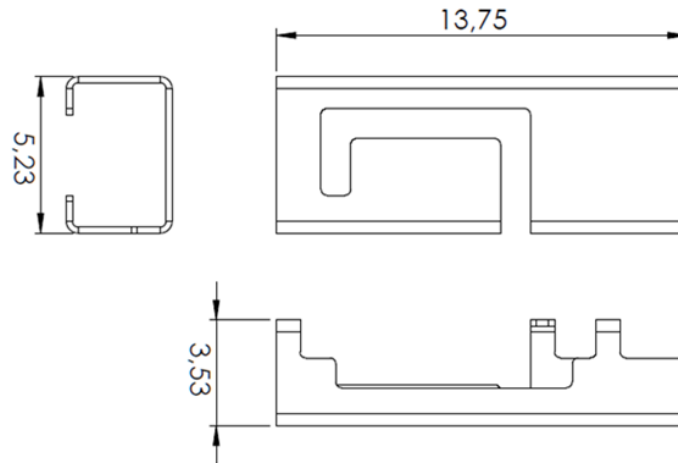

Unit : mm

Antenna pins and keep-out block

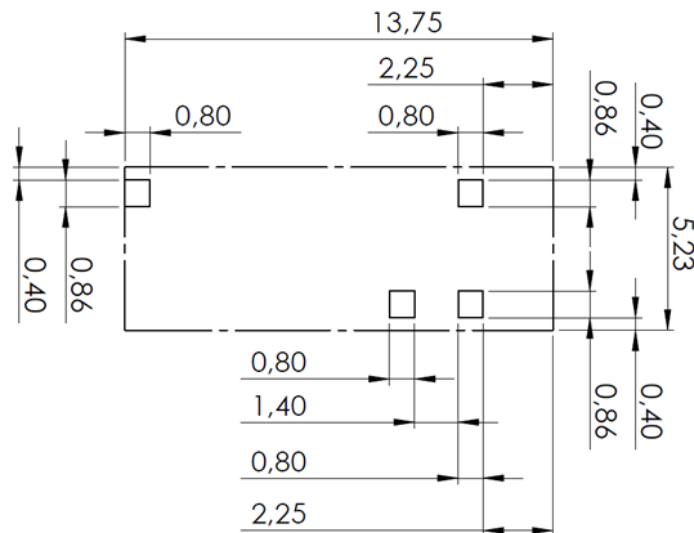

Unit : mm



5101 Hidden Creek Ln Spicewood TX 78669
Phone: 512-371-6159 | Fax: 512-351-8858
For terms and conditions of sales, please visit:
www.abracon.com

REVISED:

ABRACON IS
ISO9001-2015
CERTIFIED

OnBoard 2.4 GHz SMD - Antenna

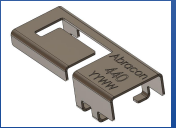

PRO-OB-440

Request Samples



Check Inventory



13.75 x 5.23 x 3.53 mm
RoHS/RoHS II Compliant
MSL Level = 1

PCB layout and antenna pin numbering

The antenna uses PIFA technology and should thus be mounted on a ground plane. If there are several layers in the PCB, there is an advantage to add vias for smooth interconnection of the ground areas to avoid splits in the ground plane. It is also important that there is a ground clearance around the NC pads and the RF feed pad, through all layers of the PCB. It is recommended to implement a matching network to optimize the antenna impedance in your application. The components can be positioned under the antenna. See recommendations in the figures below.

3 ■ ■ 1
 ■ 2

4 ■

1 = GND
2 = RF FEED
3 = NC
4 = NC

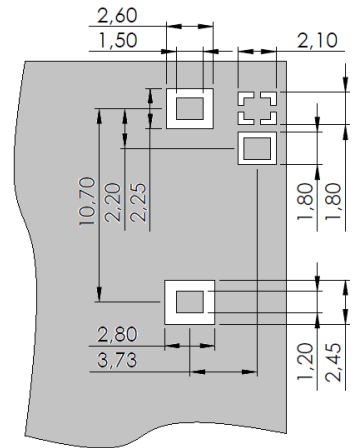
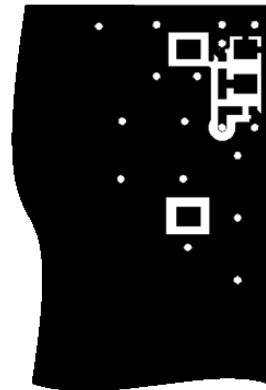

Pin configuration

PCB Layout (from evaluation board)

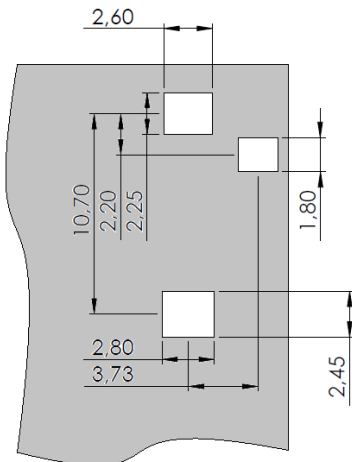

Clearance through all layers

Unit : mm



5101 Hidden Creek Ln Spicewood TX 78669
Phone: 512-371-6159 | Fax: 512-351-8858
For terms and conditions of sales, please visit:
www.abracon.com

REVISED:

ABRACON IS
ISO9001-2015
CERTIFIED

OnBoard 2.4 GHz SMD - Antenna

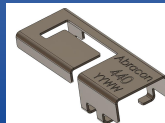

PRO-OB-440

Request Samples



Check Inventory



13.75 x 5.23 x 3.53 mm
RoHS/RoHS II Compliant
MSL Level = 1

Measurement Setup

The antenna measurements were all done in free space with the OnBoard SMD 2400 evaluation board (PRO-EB-450) that has a PCB size of 100 x 50 mm.

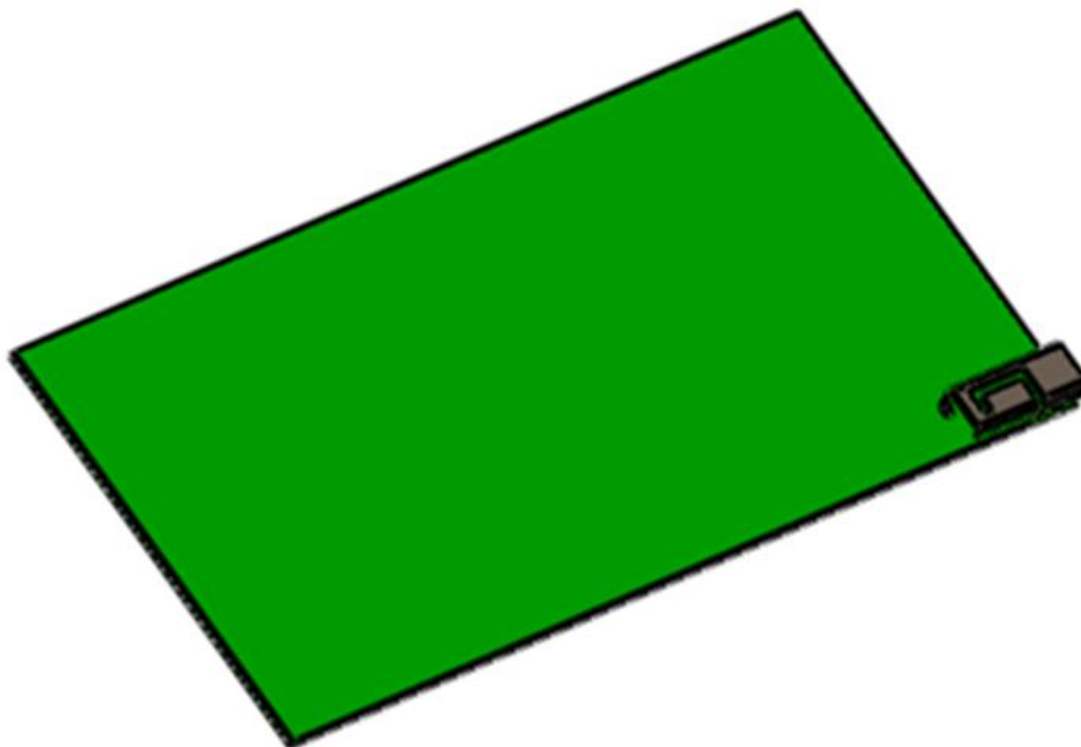

OnBoard 2.4 GHz SMD - Antenna

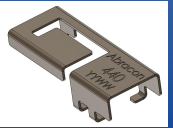

PRO-OB-440

Request Samples



Check Inventory



13.75 x 5.23 x 3.53 mm
RoHS/RoHS II Compliant
MSL Level = 1

Reflection Characteristics – Return Loss

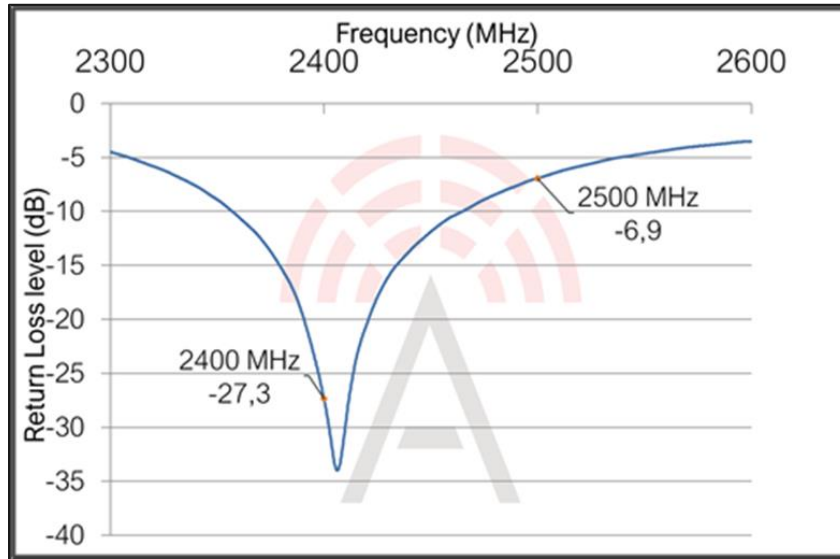

Total Radiation Efficiency

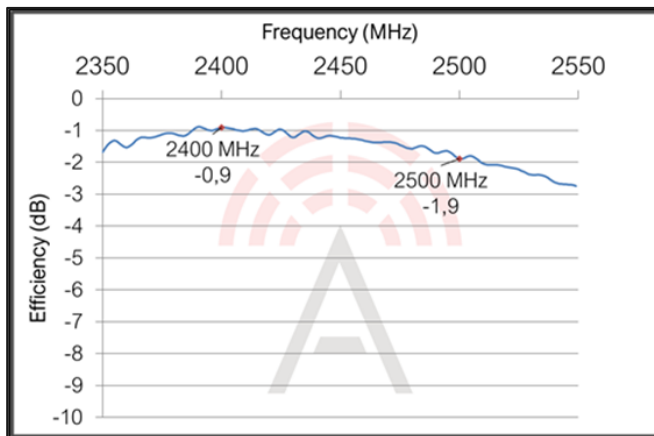

Maximum Radiation Gain

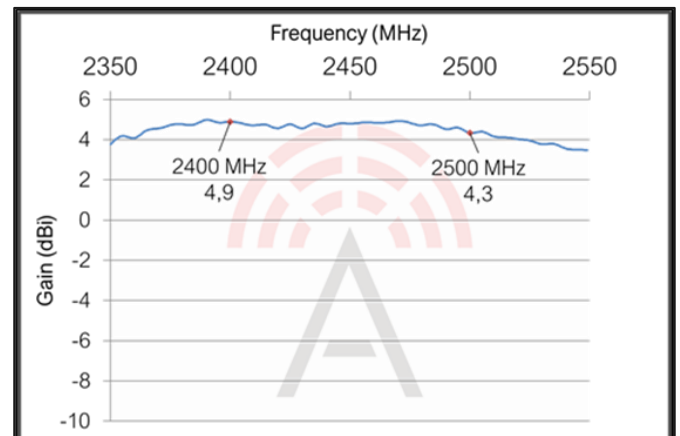

5101 Hidden Creek Ln Spicewood TX 78669
Phone: 512-371-6159 | Fax: 512-351-8858
For terms and conditions of sales, please visit:
www.abracon.com

REVISED:

ABRACON IS
ISO9001-2015
CERTIFIED

OnBoard 2.4 GHz SMD - Antenna

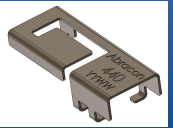

PRO-OB-440

Request Samples



Check Inventory



13.75 x 5.23 x 3.53 mm
RoHS/RoHS II Compliant
MSL Level = 1

Radiation Characteristics – 2D Pattern (2400 MHz)

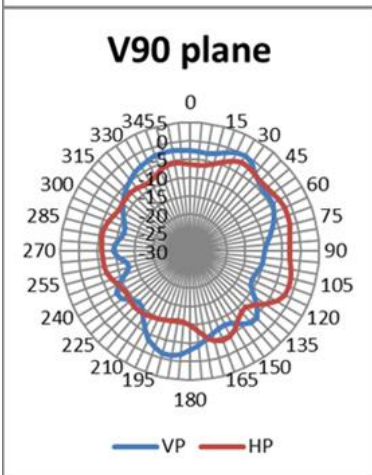
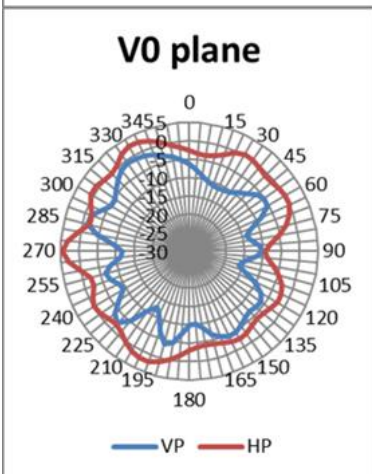
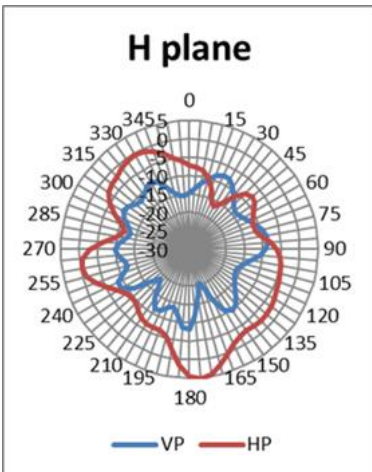

VP: Vertical Polarization
HP: Horizontal Polarization



Unit: dBi



5101 Hidden Creek Ln Spicewood TX 78669
Phone: 512-371-6159 | Fax: 512-351-8858
For terms and conditions of sales, please visit:
www.abracon.com

REVISED:

ABRACON IS
ISO9001-2015
CERTIFIED

OnBoard 2.4 GHz SMD - Antenna

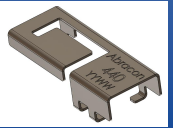

PRO-OB-440

Request Samples



Check Inventory



13.75 x 5.23 x 3.53 mm
RoHS/RoHS II Compliant
MSL Level = 1

Radiation Characteristics – 2D Pattern (2500 MHz)

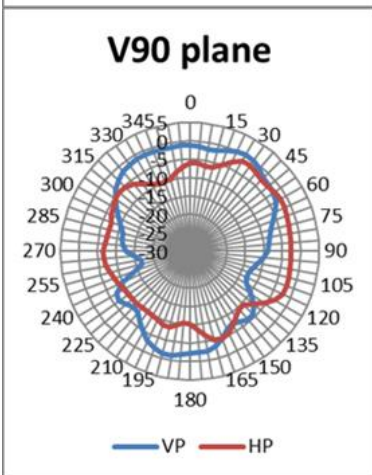
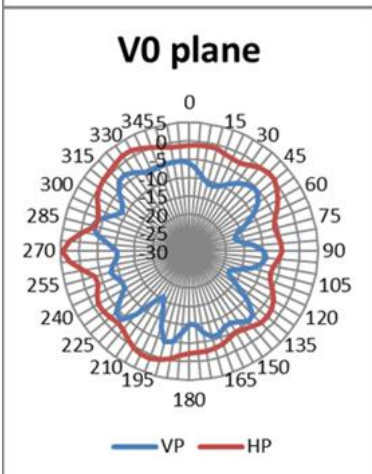
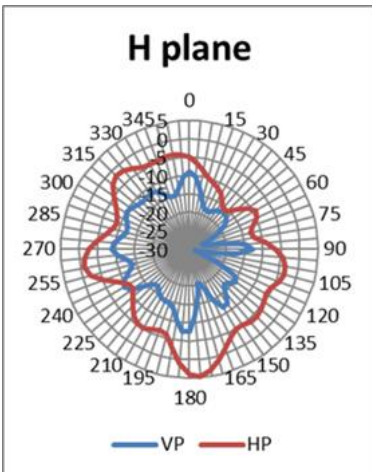

VP: Vertical Polarization
HP: Horizontal Polarization



Unit: dBi



5101 Hidden Creek Ln Spicewood TX 78669
Phone: 512-371-6159 | Fax: 512-351-8858
For terms and conditions of sales, please visit:
www.abracon.com

REVISED:

ABRACON IS
ISO9001-2015
CERTIFIED

OnBoard 2.4 GHz SMD - Antenna



PRO-OB-440

Request Samples



Check Inventory



13.75 x 5.23 x 3.53 mm
RoHS/RoHS II Compliant
MSL Level = 1

Evaluation Board Outline & Matching Circuit

The evaluation board (PRO-EB-450) is developed to simplify antenna testing and evaluation. It has an arbitrary size of 100 x 50 mm and includes an SMA connector. The purpose is to give a reference design for an optimal antenna implementation. The evaluation board can also be used to test other implementations by cutting and soldering the PCB into any device.

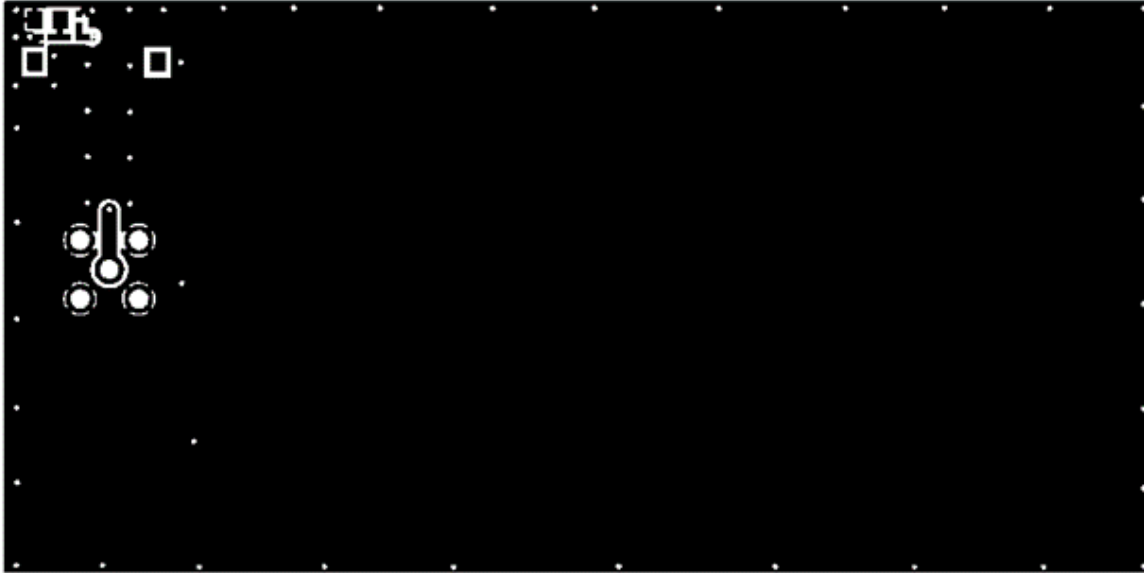

Evaluation board outline

The evaluation board has a matching circuit implemented next to the antenna. This is aimed to enable optimization possibilities for the user. The component positions are sized for 0402 (1005 metric) SMD components.

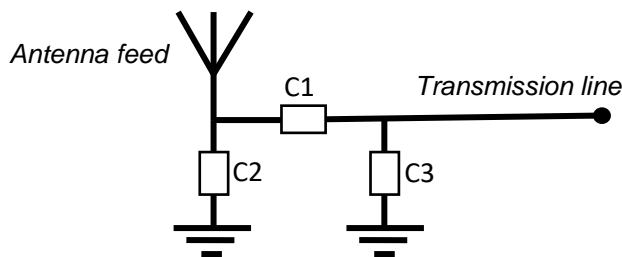

Matching circuit

The antenna needs a matching circuit to adjust the resonant frequency balance. When delivered, the evaluation board is tuned for optimum balance at the 2.4 GHz frequency band using the following component values:

$$C1 = 1.5 \text{ nH}$$

$$C2 = 0.5 \text{ pF}$$

$$C3 = \text{N/A.}$$

However, it is common that the resonant frequency will shift during implementation in an arbitrary device. Therefore, this matching may be changed for compensation of such effects. This is further described in General Implementation Guidelines section below.



5101 Hidden Creek Ln Spicewood TX 78669
Phone: 512-371-6159 | Fax: 512-351-8858
For terms and conditions of sales, please visit:
www.abracon.com

REVISED:

ABRACON IS
ISO9001-2015
CERTIFIED

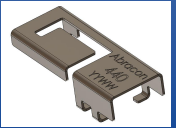

PRO-OB-440

Request Samples



Check Inventory



13.75 x 5.23 x 3.53 mm
RoHS/RoHS II Compliant
MSL Level = 1

General Implementation Guidelines

The antenna can be positioned in different ways, although there are some positions which are more beneficial. Below picture shows a typical PCB with examples on different antenna positions. The optimal position is option 1 or 4.

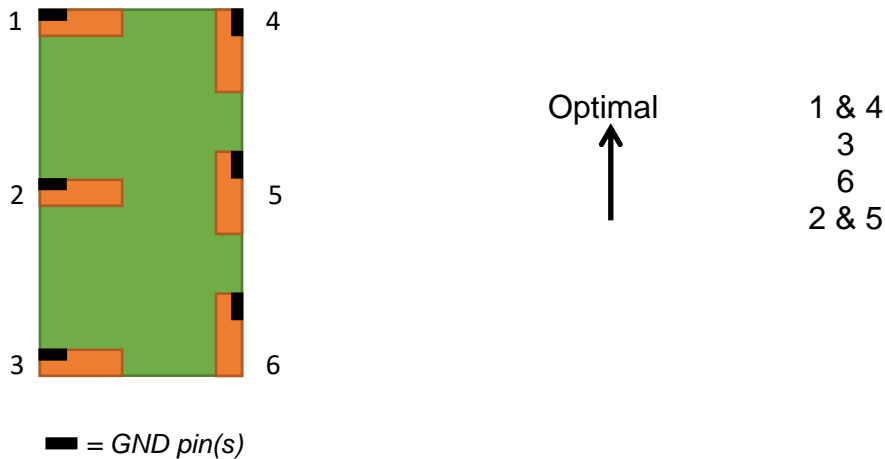

The antenna should be aligned with the PCB edge if possible, preferably with the GND pin(s) close to a corner.

The antenna enables that small electrical components are mounted inside the antenna keep-out block. This is a space-efficient solution which has very little influence on the performance. It may have an impact on the antenna tuning, but is fully possible if there is limited space on the PCB.

Another general aspect on surface mounted antennas is regarding the PCB population. If other electrical components are positioned in the surrounding area of the antenna, some impact on the antenna tuning and radiated performance may be expected. It is recommended that such components are distributed below a topographical slope that starts on PCB level at the antenna keep-out block, and slowly increases the height.

It shall also be highlighted that plastic and metal parts in the near proximity of antennas may influence the antenna tuning and/or performance. This aspect should be noted as a general guideline for all antennas. The effects are difficult to estimate without detailed information, but it is common that a plastic housing above the antenna shifts the resonant frequency down. It is recommended to measure the antenna in the actual device after implementation.

OnBoard 2.4 GHz SMD - Antenna

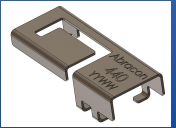

PRO-OB-440

Request Samples



Check Inventory



13.75 x 5.23 x 3.53 mm
RoHS/RoHS II Compliant
 MSL Level = 1

Packaging

The antenna is delivered on tape and reel according to following specifications. The quantity per 13" reel is 1000 pcs.

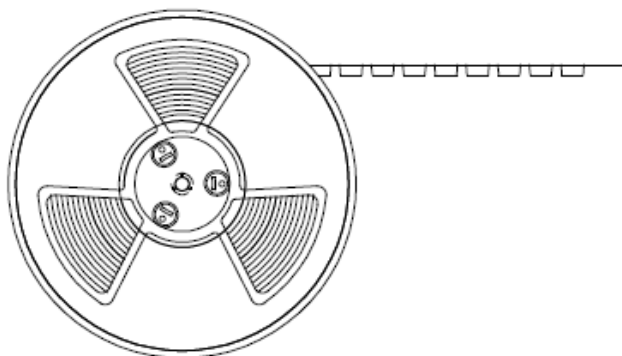
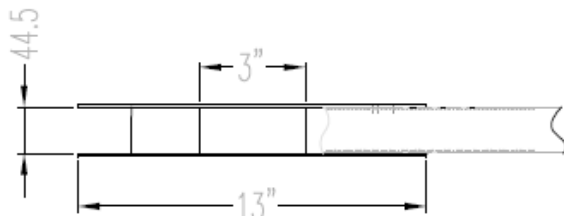
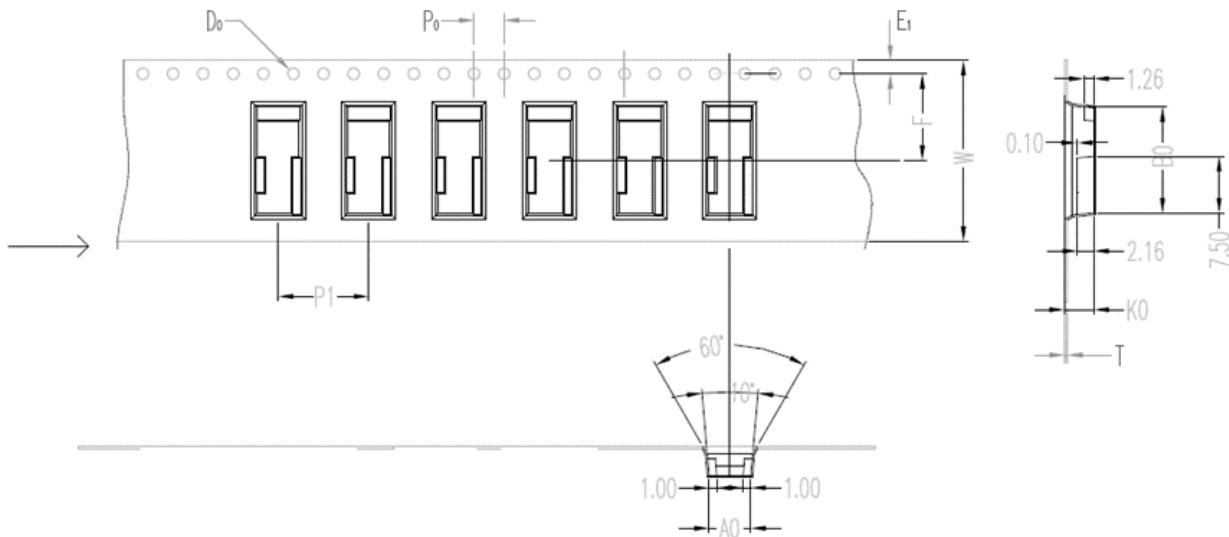

A_0	5.53 ±0.1
B_0	14.05 ±0.1
D_0	∅1.5 $\begin{smallmatrix} +0.10 \\ -0.00 \end{smallmatrix}$
E_1	1.75 ±0.1
F	11.5 ±0.15
K_0	3.83±0.1
P_0	4.0 ±0.1
P_1	12. ±0.1
P_2	2.0 ±0.15
S_0	
T	0.35 ±0.05
W	24.0 ±0.3

Unit: mm (unless otherwise noted)



5101 Hidden Creek Ln Spicewood TX 78669
 Phone: 512-371-6159 | Fax: 512-351-8858
 For terms and conditions of sales, please visit:
www.abracon.com

REVISED:

ABRACON IS
 ISO9001-2015
 CERTIFIED

OnBoard 2.4 GHz SMD - Antenna

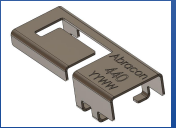

PRO-OB-440

Request Samples



Check Inventory



13.75 x 5.23 x 3.53 mm
RoHS/RoHS II Compliant
 MSL Level = 1

Part Marking

The top marking of the antenna is arranged according to the following illustration.

Abracon

440

Product part number

YYWW

Date code

YY=Year

WW=Week

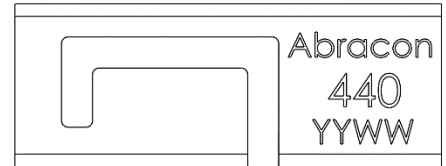

Example top marking

There will be a transition period for the part marking until production batches after 2222 (YYWW). Produced batches before 2222 are marked according to the below illustration.

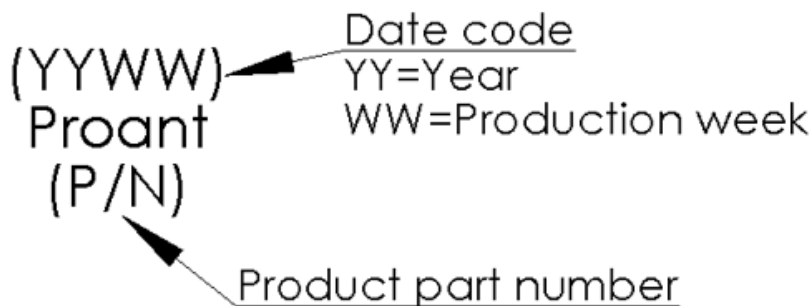

Example top marking

Ordering Information

Part number	Part name	Details
PRO-OB-440	OnBoard SMD 2400	Antenna for 2.4-2.5 GHz.
PRO-EB-450	Evaluation board, Onboard SMD 2400	Evaluation board with PRO-OB-440 for 2.4 - 2.5 GHz (Wi-Fi/BT/BLE/Zigbee) applications.

ATTENTION: Abracon LLC's products are COTS – Commercial-Off-The-Shelf products; suitable for Commercial, Industrial and, where designated, Automotive Applications. Abracon's products are not specifically designed for Military, Aviation, Aerospace, Life-dependent Medical applications or any application requiring high reliability where component failure could result in loss of life and/or property. For applications requiring high reliability and/or presenting an extreme operating environment, written consent and authorization from Abracon LLC is required. Please contact Abracon LLC for more information.



5101 Hidden Creek Ln Spicewood TX 78669
 Phone: 512-371-6159 | Fax: 512-351-8858
 For terms and conditions of sales, please visit:
www.abracon.com

REVISED:

ABRACON IS
 ISO9001-2015
 CERTIFIED