

2.4GHz 3216 Chip Antenna: ANT3216R24003KLA

Application:

WLAN, 802.11b/g, Bluetooth, etc...

Features

SMD, high reliability, ultra compact, Omni-directional...

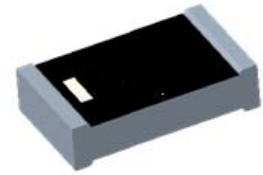

Part number

ANT 3216 R 2400 3K LA
 (1) (2) (3) (4) (5)

(1)Size Code	3.2x1.6mm
(2) Packing	Tape and reel
(3) Frequency	2.4GHz
(4) Packing Number	3K
(5)Code	LA

Electrical Specification

Working Frequency Range	2402 ~2480 MHz
Peak Gain	0.95dBi (Typ.)
Impedance	50 Ohm
VSWR	2.5(Max)
Polarization	Linear
Azimuth Beamwidth	Omni-directional
Operation Temperature(°C)	-40~85°C

The specification is defined on HEK EVB.

Dimension and Terminal Configuration

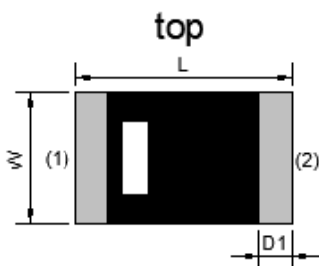

Dimension (mm)	
L	3.20±0.15
W	1.60±0.15
T	0.60±0.10
D1	0.50±0.15
D2	1.30±0.15

No.	Terminal Name
1	Feeding
2	Ground

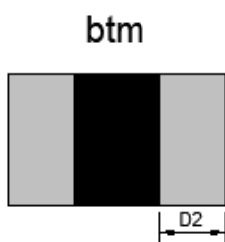

Evaluation Board Reference

PCB Dimension

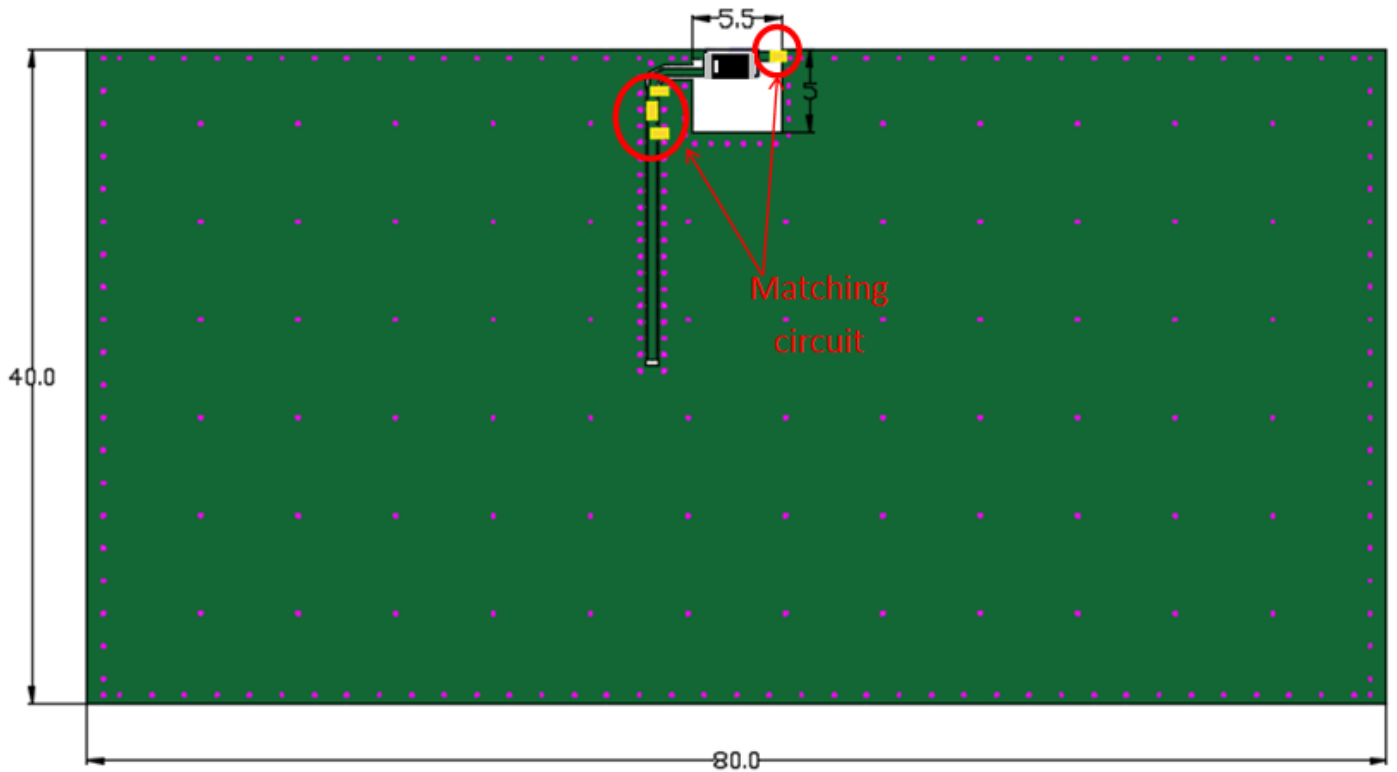

Antenna Layout Reference

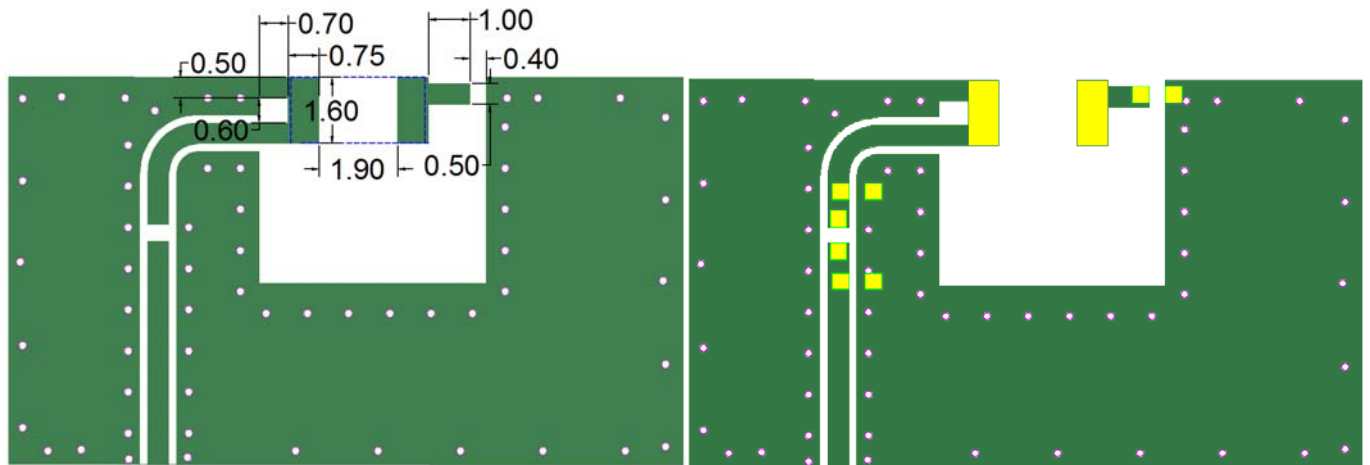

Unit : mm

2.4GHz 3216 Chip Antenna: ANT3216R24003KLA

Electrical Characteristics



VSWR

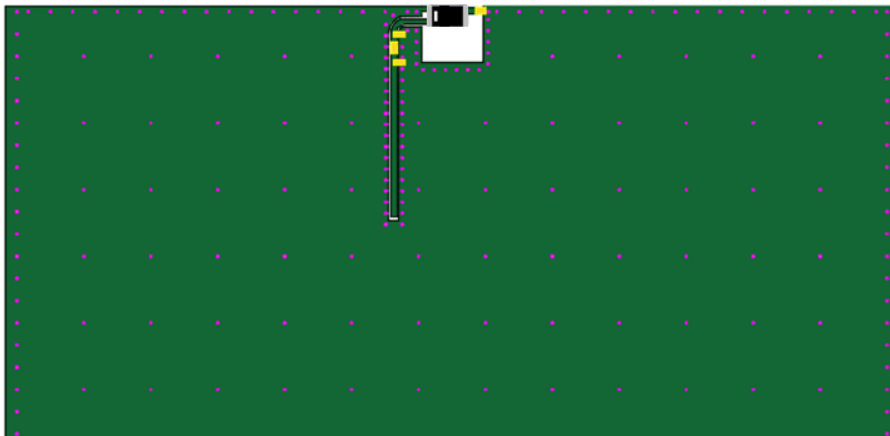
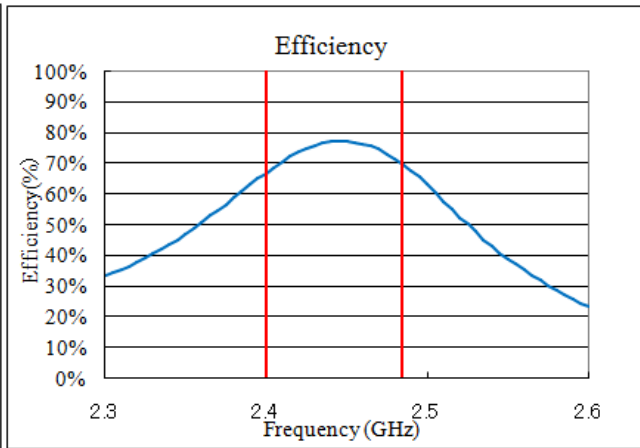
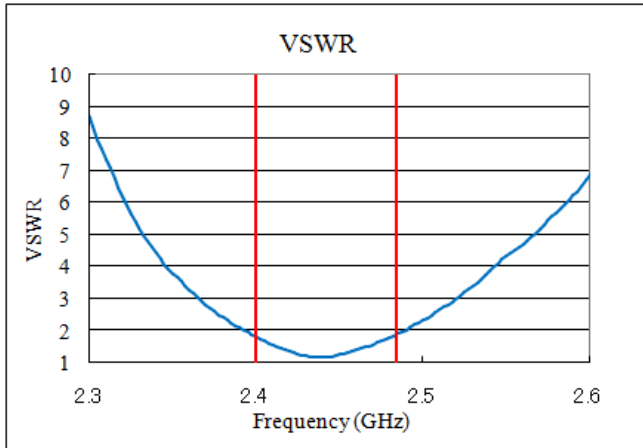

2441.000MHz H

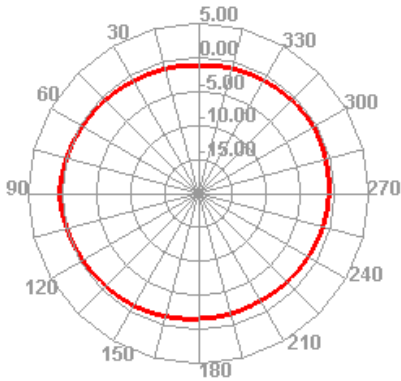

2441.000MHz E1

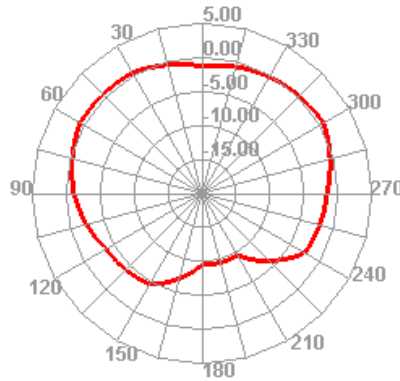

2441.000MHz E2

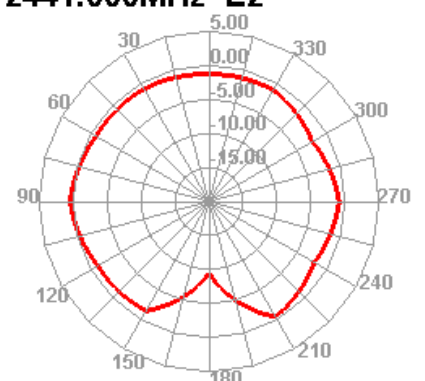

Taping Specifications

Reel and Taping Specification

Reel Specification

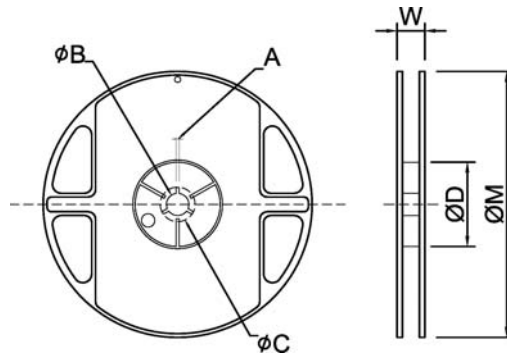

TYPE	SIZE		A	ψB	ψC	ψD	W	ψM
3216	7"	3K/Reel	2.0±0.5	13.5±1.0	21±1.0	60±1.0	11.5±2.0	178±2.0

Taping Specification

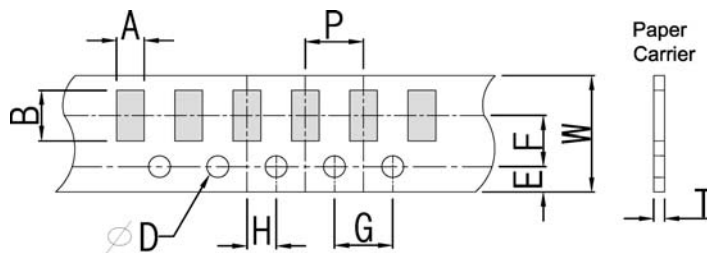

Packaging	Type	A	B	W	E	F	G	H	T	ψD	P
Paper Type	3216	1.90±0.20	3.50±0.20	8.0±0.20	1.75±0.10	3.5±0.05	4.0±0.10	2.0±0.05	0.75±0.10	1.50 +0.10 -0	4.0±0.1

2.4GHz 3216 Chip Antenna: ANT3216R24003KLA

Recommended Reflow Profile

Pb free solder

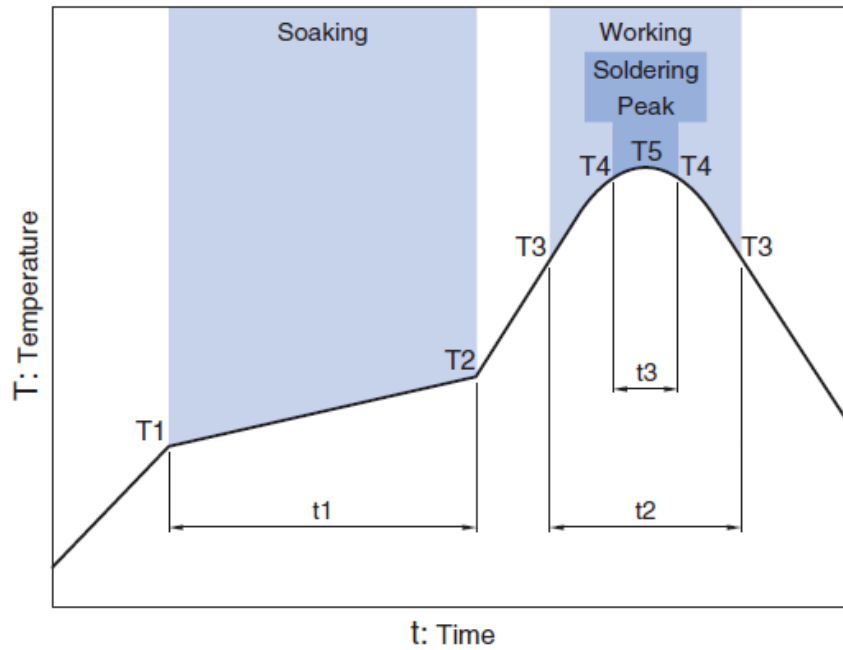

Soaking		Working		Soldering		Peak	
Temp.	Time	Temp.	Time	Temp.	Time	Temp.	
T1	T2	t1	T3	t2	T4	t3	T5
150°C	180°C	60 to 120sec	230°C	more than 30sec	247 to 253°C	within 10sec	260°C Max.

Sept. 2022 Ver.H01