



FCC AND ISED CERTIFICATION TEST REPORT

Applicant	:	Edifier International Limited
Address of Applicant	:	P.O. Box 6264 General Post Office, Hong Kong
Manufacturer	:	Beijing Edifier Technology Co., Ltd.
Address of Manufacturer	:	815, Floor 8, Shuangqiao Building, No.68, North Fourth Ring West Road, Haidian District, 100080 Beijing, P.R. China
Equipment under Test	:	Multimedia Speaker
Model No.	:	EDF100074
FCC ID	:	Z9G-EDF252
IC	:	10004A-EDF252
Test Standard(s)	:	FCC Rules and Regulations Part 15 Subpart C, RSS-247 Issue 3 August 2023, ANSI C63.10:2020, RSS-Gen Issue 5, Apr. 2018, Amendment 2 (February 2021)
Report No.	:	DDT-RE24052807-1E01
Issue Date	:	2024/07/31
Issue By	:	Guangdong Dongdian Testing Service Co., Ltd. Unit 2, Building 1, No. 17, Zongbu 2nd Road, Songshan Lake Park, Dongguan, Guangdong, China, 523808

Table of Contents

1.	Summary of Test Results	7
2.	General Test Information	8
2.1.	Description of EUT	8
2.2.	Accessories of EUT	9
2.3.	Block diagram of EUT configuration for test	9
2.4.	Decision of final test mode	9
2.5.	Deviations of test standard	10
2.6.	Test environment conditions	10
2.7.	Test laboratory	10
2.8.	Measurement uncertainty	11
3.	Equipment Used During Conductive Test	12
4.	20 dB Bandwidth	13
4.1.	Block diagram of test setup	13
4.2.	Limits	13
4.3.	Test procedure	13
4.4.	Test result	14
4.5.	Test graphs	15
5.	99% Bandwidth	18
5.1.	Block diagram of test setup	18
5.2.	Limits	18
5.3.	Test procedure	18
5.4.	Test result	19
5.5.	Test graphs	20
6.	Maximum Peak Output Power	23
6.1.	Block diagram of test setup	23
6.2.	Limits	23
6.3.	Test procedure	23
6.4.	Test result	24
6.5.	Test graphs	25
7.	Carrier Frequency Separation	28
7.1.	Block diagram of test setup	28
7.2.	Limits	28
7.3.	Test procedure	28
7.4.	Test result	29
7.5.	Test graphs	30
8.	Dwell Time	31

8.1.	Block diagram of test setup	31
8.2.	Limits.....	31
8.3.	Test procedure.....	31
8.4.	Test result	32
8.5.	Test graphs.....	33
9.	Number of Hopping Channel.....	39
9.1.	Block diagram of test setup	39
9.2.	Limits.....	39
9.3.	Test procedure.....	39
9.4.	Test result	40
9.5.	Test graphs.....	41
10.	Band Edge Compliance (Conducted Method).....	42
10.1.	Block diagram of test setup	42
10.2.	Limit.....	42
10.3.	Test procedure.....	42
10.4.	Test result	43
10.5.	Test graphs.....	44
11.	RF Conducted Spurious Emissions.....	48
11.1.	Block diagram of test setup	48
11.2.	Limits.....	48
11.3.	Test procedure.....	48
11.4.	Test result	49
11.5.	Test graphs.....	50
12.	Duty cycle	59
12.1.	Block diagram of test setup	59
12.2.	Limit.....	59
12.3.	Test procedure.....	59
12.4.	Test result	60
12.5.	Test graphs.....	61
13.	Antenna Requirements.....	64
13.1.	Limit.....	64
13.2.	Result.....	64
14.	Radiated Emission.....	65
14.1.	Test equipment.....	65
14.2.	Block diagram of test setup	66
14.3.	Limits.....	67
14.4.	Assistant equipment used for test	69
14.5.	Test procedure.....	69

14.6.	Test result	71
14.7.	Test data	72
15.	Band Edge Compliance	80
15.1.	Test equipment	80
15.2.	Block diagram of test setup	81
15.3.	Limits.....	81
15.4.	Assistant equipment used for test	81
15.5.	Test procedure.....	81
15.6.	Test result	81
15.7.	Test data	82
16.	Power Line Conducted Emissions.....	94
16.1.	Test equipment	94
16.2.	Block diagram of test setup	94
16.3.	Limits.....	94
16.4.	Assistant equipment used for test	94
16.5.	Test procedure.....	95
16.6.	Test result	95
16.7.	Test data	96
17.	Test Setup Photograph.....	98
18.	Photos of the EUT	100

Test Report Declare

Applicant	:	Edifier International Limited
Address of Applicant	:	P.O. Box 6264 General Post Office, Hong Kong
Equipment under Test	:	Multimedia Speaker
Model No.	:	EDF100074
Manufacturer	:	Beijing Edifier Technology Co., Ltd.
Address of Manufacturer	:	815, Floor 8, Shuangqiao Building, No.68, North Fourth Ring West Road, Haidian District, 100080 Beijing, P.R. China

Test Standard Used:

FCC Rules and Regulations Part 15 Subpart C,
RSS-247 Issue 3 August 2023,
ANSI C63.10:2020,
RSS-Gen Issue 5, Apr. 2018, Amendment 2 (February 2021)

We Declare:

The equipment described above is tested by Guangdong Dongdian Testing Service Co., Ltd. and in the configuration tested the equipment complied with the standards specified above. The test results are contained in this test report and Guangdong Dongdian Testing Service Co., Ltd. is assumed of full responsibility for the accuracy and completeness of these tests.

Report No.:	DDT-RE24052807-1E01		
Date of Receipt:	2024/06/04	Date of Test:	2024/06/04~2024/07/26

Prepared By:**Jacky Huang/Engineer****Approved By:****Damon Hu/EMC Manager**

Note: This report applies to above tested sample only. This report shall not be reproduced in parts without written approval of Guangdong Dongdian Testing Service Co., Ltd.

Revision History

Rev.	Revisions	Issue Date	Revised By
---	Initial issue	2024/07/31	

1. Summary of Test Results

No.	Test Parameter	Clause No.	Condition	Result
1	Maximum Peak Output Power	FCC Part 15: 15.247(b)(1), RSS-247 Issue 3 clause 5.4(b)	/	Pass
2	20 dB Bandwidth	FCC Part 15: 15.247(a)(1), RSS-247 Issue 3 clause 5.1(a)	/	Pass
3	99% Bandwidth	RSS-Gen Issue 5 clause 6.7	/	Pass
4	Carrier Frequency Separation	FCC Part 15: 15.247(a)(1), RSS-247 Issue 3 clause 5.1(b)	/	Pass
5	Number of Hopping Channel	FCC Part 15: 15.247(a)(1)(iii), RSS-247 Issue 3 clause 5.1(d)	/	Pass
6	Dwell Time	FCC Part 15: 15.247(a)(1)(iii), RSS-247 Issue 3 clause 5.1(d)	/	Pass
7	RF Conducted Spurious Emissions	FCC Part 15: 15.247(d), RSS-247 Issue 3 clause 5.5	/	Pass
8	Radiated Emission	FCC Part 15: 15.205, FCC Part 15: 15.209, FCC Part 15: 15.247(d), RSS-247 Issue 3 clause 5.5, RSS-Gen Issue 5 clause 8.9, RSS-Gen Issue 5 clause 8.10	/	Pass
9	Band Edge Compliance	FCC Part 15: 15.205, FCC Part 15: 15.209, FCC Part 15: 15.247(d), RSS-247 Issue 3 clause 5.5, RSS-Gen Issue 5 clause 8.9, RSS-Gen Issue 5 clause 8.10	/	Pass
10	Antenna Requirement	FCC Part 15: 15.203, RSS-Gen Issue 5 clause 6.8	/	Pass
11	Power Line Conducted Emissions	FCC Part 15: 15.207(a), RSS-Gen Issue 5 clause 8.8	/	Pass

Note: N/A is an abbreviation for Not Applicable, and means this item is not applicable for this device or no need to test according to standard.

2. General Test Information

2.1. Description of EUT

EUT Name	: Multimedia Speaker
Model Number	: EDF100074
EUT Function Description	: Please reference user manual of this device
Power Supply	: 100-240V~, 50/60Hz, 400mA
Hardware Version	: /
Software Version	: /

Note: This EUT support Bluetooth BR/EDR/LE, this report only for Bluetooth BR/EDR.

Radio Specification	: Bluetooth BR/EDR
Operation Frequency	: 2402 MHz-2480 MHz
Modulation	: GFSK, $\pi/4$ -DQPSK, 8DPSK

Antenna information	
Antenna Type	: PIFA antenna
Max Antenna Gain (dBi)	: -0.29

Channel information					
Channel	Frequency (MHz)	Channel	Frequency (MHz)	Channel	Frequency (MHz)
0	2402	27	2429	54	2456
1	2403	28	2430	55	2457
2	2404	29	2431	56	2458
3	2405	30	2432	57	2459
4	2406	31	2433	58	2460
5	2407	32	2434	59	2461
6	2408	33	2435	60	2462
7	2409	34	2436	61	2463
8	2410	35	2437	62	2464
9	2411	36	2438	63	2465
10	2412	37	2439	64	2466
11	2413	38	2440	65	2467
12	2414	39	2441	66	2468
13	2415	40	2442	67	2469
14	2416	41	2443	68	2470
15	2417	42	2444	69	2471
16	2418	43	2445	70	2472
17	2419	44	2446	71	2473
18	2420	45	2447	72	2474
19	2421	46	2448	73	2475

20	2422	47	2449	74	2476
21	2423	48	2450	75	2477
22	2424	49	2451	76	2478
23	2425	50	2452	77	2479
24	2426	51	2453	78	2480
25	2427	52	2454		
26	2428	53	2455		

Note: The above EUT information is declared by manufacturer and for more detailed features description please refer to the manufacturer's specifications or User's Manual. The above Antenna information is declared by manufacturer and for more detailed features description please refer to the manufacturer's specifications, the laboratory shall not be held responsible.

2.2. Accessories of EUT

Accessories	Manufacturer	Model number	Description
AC line	/	/	Length: 2.50m, Unshielded
3.5mm AUX in cable	/	/	Length: 1.80m, Unshielded
Type-C cable	/	/	Length: 1.20m, shielded
Connecting line	/	/	Length: 1.80m, shielded

2.3. Block diagram of EUT configuration for test

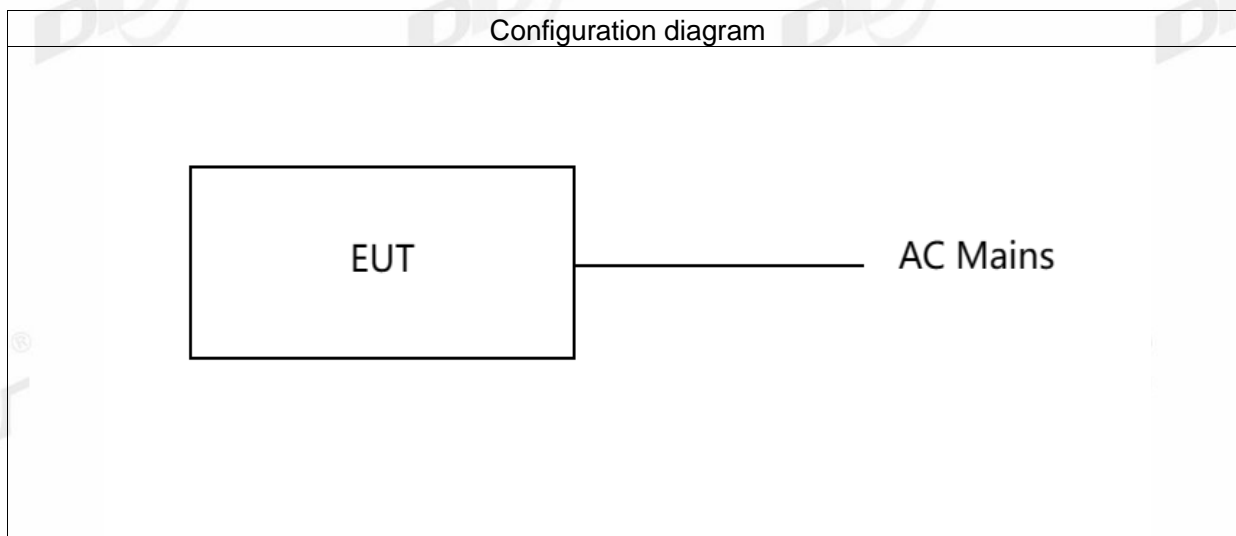

2.4. Decision of final test mode

According pre-test, the worst test modes were reported as below:

Test software: BQB.exe, Version: 20220506

The test software was used to control EUT work in Continuous Tx mode, and select test channel, wireless mode as below table.

The pathloss of external cable: 0.5 dB (According to the manufacturer's claims)

Tested mode, channel, information			
Mode	Setting Tx Power	Channel	Frequency (MHz)
GFSK hopping on Tx mode	2	CH0 to CH78	2402 to 2480
p/4-DQPSK hopping on Tx mode	2	CH0 to CH78	2402 to 2480
8DPSK hopping on Tx mode	2	CH0 to CH78	2402 to 2480
GFSK hopping off Tx mode	2	CH0	2402
	2	CH39	2441
	2	CH78	2480
p/4-DQPSK hopping off Tx mode	2	CH0	2402
	2	CH39	2441
	2	CH78	2480
8DPSK hopping off Tx mode	2	CH0	2402
	2	CH39	2441
	2	CH78	2480
Worst-case data rates were: GFSK mode: DH5, p/4-DQPSK mode: 2DH5, 8DPSK mode: 3DH5			

2.5. Deviations of test standard

No deviation.

2.6. Test environment conditions

During the measurement the environmental conditions were within the listed ranges:

Temperature range:	+15°C to +35 °C
Humidity range:	20% to 75%
Pressure range:	86 kPa to 106 kPa

Note: The specific temperature and humidity information of each test item refers to the temperature and humidity record in the corresponding test data.

2.7. Test laboratory

Guangdong Dongdian Testing Service Co., Ltd.

Add.: Unit 2, Building 1, No. 17, Zongbu 2nd Road, Songshan Lake Park, Dongguan, Guangdong, China, 523808.

Tel.: +86-0769-38826678, <http://www.dgddt.com>, Email: ddt@dgddt.com.

CNAS Accreditation No. L6451; A2LA Accreditation Number: 3870.01

FCC Designation Number: CN1182, Test Firm Registration Number: 540522

Innovation, Science and Economic Development Canada Site Registration Number: 10288A

Conformity Assessment Body identifier: CN0048

VCCI facility registration number: C-20087, T-20088, R-20123, R-20155, G-20118

2.8. Measurement uncertainty

Test Item	Uncertainty
Bandwidth	1.1%
Peak Output Power (Conducted) (Spectrum analyzer)	0.86 dB (10 MHz ≤ f < 3.6 GHz);
	1.38 dB (3.6 GHz ≤ f < 8 GHz)
Peak Output Power (Conducted) (Power Sensor)	0.74 dB
Power Spectral Density	0.74 dB (10 MHz ≤ f < 3.6 GHz);
	1.38 dB (3.6 GHz ≤ f < 8 GHz)
Frequencies Stability	6.7 × 10 ⁻⁸ (Antenna couple method)
	5.5 × 10 ⁻⁸ (Conducted method)
Conducted spurious emissions	0.86 dB (10 MHz ≤ f < 3.6 GHz);
	1.40 dB (3.6 GHz ≤ f < 8 GHz)
	1.66 dB (8 GHz ≤ f < 26.5 GHz)
Uncertainty for radio frequency (RBW < 20 kHz)	3×10 ⁻⁸
Temperature	0.4 °C
Humidity	2 %
Uncertainty for Radiation Emission test (9 kHz – 30 MHz)	3.44 dB
Uncertainty for Radiation Emission test (30 MHz - 1 GHz)	4.70 dB (Antenna Polarize: V)
	4.84 dB (Antenna Polarize: H)
Uncertainty for Radiation Emission test (1 GHz - 40 GHz)	4.10 dB (1 - 6 GHz)
	4.40 dB (6 GHz - 18 GHz)
	3.54 dB (18 GHz - 26 GHz)
	4.30 dB (26 GHz - 40 GHz)
Uncertainty for Power line conduction emission test	3.34dB (150KHz-30MHz)
	3.72dB (9KHz-150KHz)

Note: This uncertainty represents an expanded uncertainty expressed at approximately the 95% confidence level using a coverage factor of k=2.

3. Equipment Used During Conductive Test

Equipment	Manufacturer	Model No.	Serial Number	Due Date	Cal. Interval
☑RF Connected Test (RF Measurement System 4#)					
Signal & Spectrum Analyzer	R&S	FSV3044	101173	2025/03/31	1 Year
Wideband Radio Communication Tester	R&S	CMW500	168801	2025/03/31	1 Year
MXG Vector Signal Generator	Agilent	N5182A	MY48180737	2025/03/31	1 Year
PSG Vector Signal Generator	Agilent	E8267D	US49060192	2024/09/05	1 Year
RF Control Unit	Tonsend	JS0806-2	2118060485	2025/03/31	1 Year
TEMP&HUMI Programmable Chamber	ZHIXIANG	ZXGDJS-150L	ZX170110-A	2024/05/14	1 Year
Test Software	Tonscend	JS1120-3	Ver.3.2.22	N/A	N/A

4. 20 dB Bandwidth

4.1. Block diagram of test setup

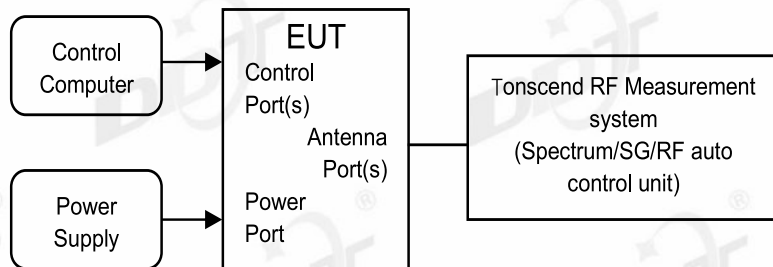

4.2. Limits

Intentional radiators operating under the alternative provisions to the general emission limits, as contained in § 15.217 through 15.257 and in Subpart E of this part, must be designed to ensure that the 20 dB bandwidth of the emission, or whatever bandwidth may otherwise be specified in the specific rule section under which the equipment operates, is contained within the frequency band designated in the rule section under which the equipment is operated.

4.3. Test procedure

- (1) The test according to ANSI C63.10-2020 clause 6.9.2.
- (2) Connect EUT's antenna output to spectrum analyzer by RF cable, the path loss was compensated to the results
- (3) Set the EUT as maximum power setting and enable the EUT transmit continuously
- (4) Use the following spectrum analyzer settings for the 20 dB bandwidth measurement:

RBW:	1% to 5% of the OBW
VBW:	approximately three times RBW
Span:	between 2 times and 5 times the OBW
Detector Mode:	Peak
Sweep time:	Auto
Trace mode:	Max hold

- (5) Measure and record the results in the report.

4.4. Test result

Test Engineer:	Zora Zhang	Test Site:	RF Measurement System 4#
Ambient Condition:	25.3°C, 55.6%RH	Test Date:	2024.06.07-2024.06.18
Test Power Supply:	AC 230V/50HZ	Sample Number:	S24052807-001

Test Mode	Antenna	Frequency [MHz]	20dB EBW [MHz]
DH5	Ant1	2402	0.96
		2441	0.96
		2480	0.96
2DH5	Ant1	2402	1.32
		2441	1.29
		2480	1.24
3DH5	Ant1	2402	1.26
		2441	1.31
		2480	1.26

4.5. Test graphs

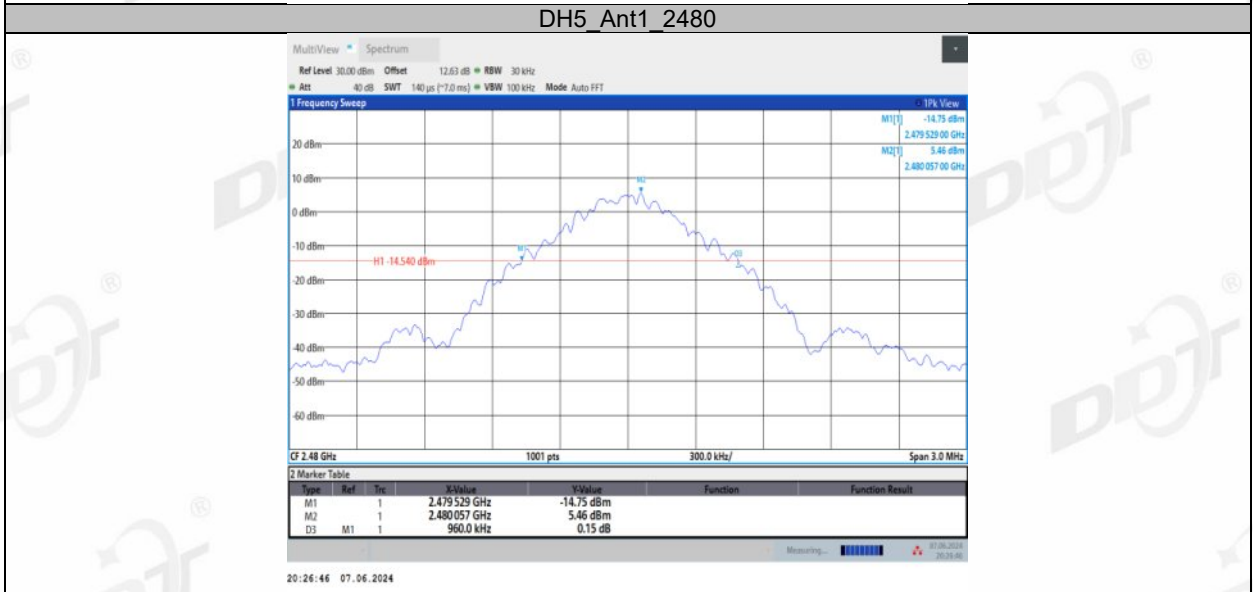
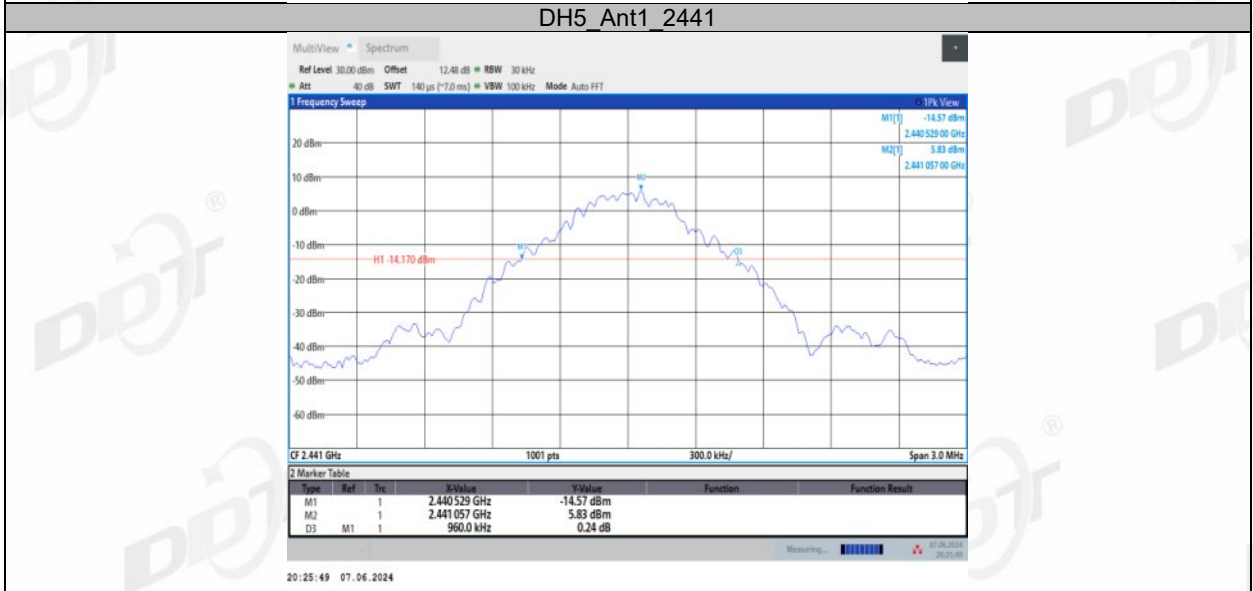
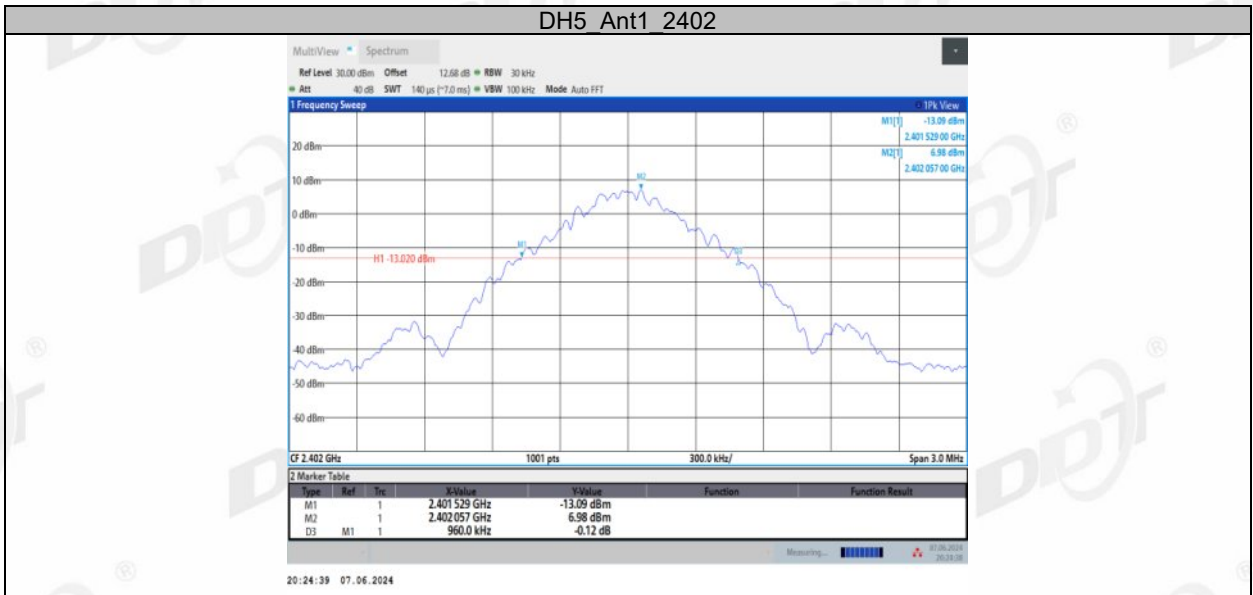

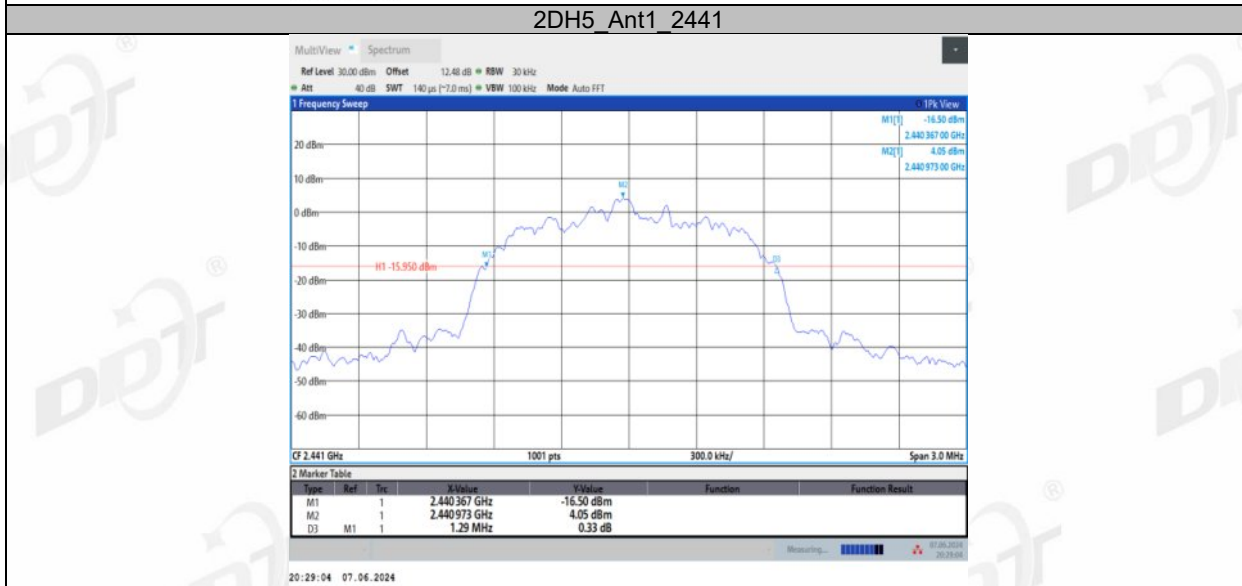
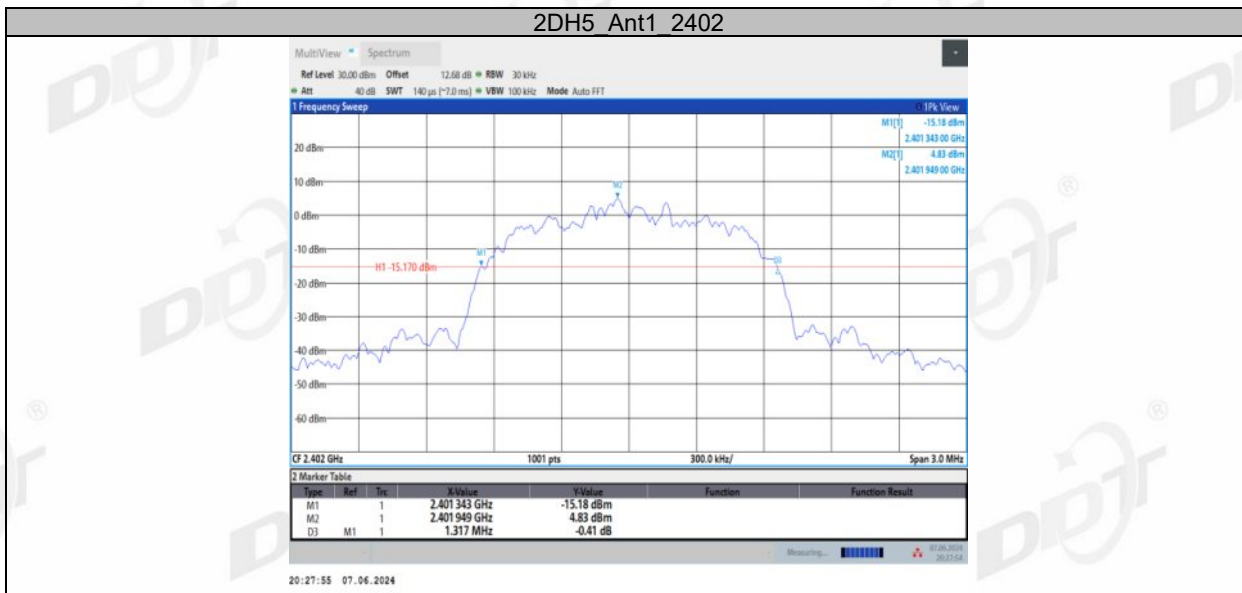



5. 99% Bandwidth

5.1. Block diagram of test setup

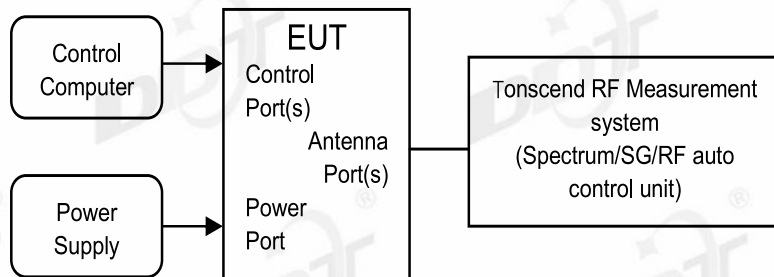

5.2. Limits

Just for Report.

5.3. Test procedure

- (1) The test according to ANSI C63.10-2020 clause 6.9.3.
- (2) Connect EUT's antenna output to spectrum analyzer by RF cable, the path loss was compensated to the results
- (3) Set the EUT as maximum power setting and enable the EUT transmit continuously
- (4) Use the following spectrum analyzer settings for the 99% bandwidth measurement:

RBW:	1% to 5% of the OBW
VBW:	approximately three times RBW
Span:	between 1.5 times and 5.0 times the OBW
Detector Mode:	Peak
Sweep time:	Auto
Trace mode:	Max hold
- (5) Measure and record the results in the report.

5.4. Test result

Test Engineer:	Zora Zhang	Test Site:	RF Measurement System 4#
Ambient Condition:	25.3°C, 55.6%RH	Test Date:	2024.06.07-2024.06.18
Test Power Supply:	AC 230V/50HZ	Sample Number:	S24052807-001

Test Mode	Antenna	Frequency [MHz]	OCB [MHz]	FL [MHz]	FH [MHz]
DH5	Ant1	2402	0.881	2401.5612	2402.4418
		2441	0.878	2440.5596	2441.4378
		2480	0.881	2479.5588	2480.4396
2DH5	Ant1	2402	1.170	2401.4157	2402.5852
		2441	1.160	2440.4176	2441.5780
		2480	1.154	2479.4203	2480.5743
3DH5	Ant1	2402	1.155	2401.4241	2402.5791
		2441	1.159	2440.4205	2441.5791
		2480	1.150	2479.4296	2480.5793

5.5. Test graphs

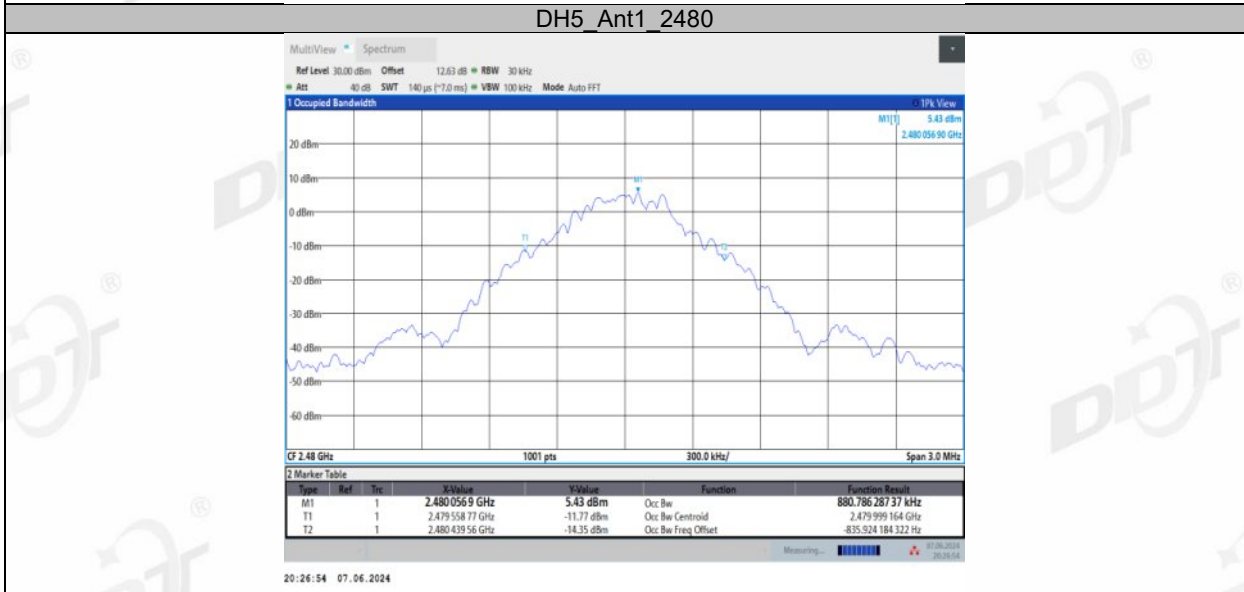
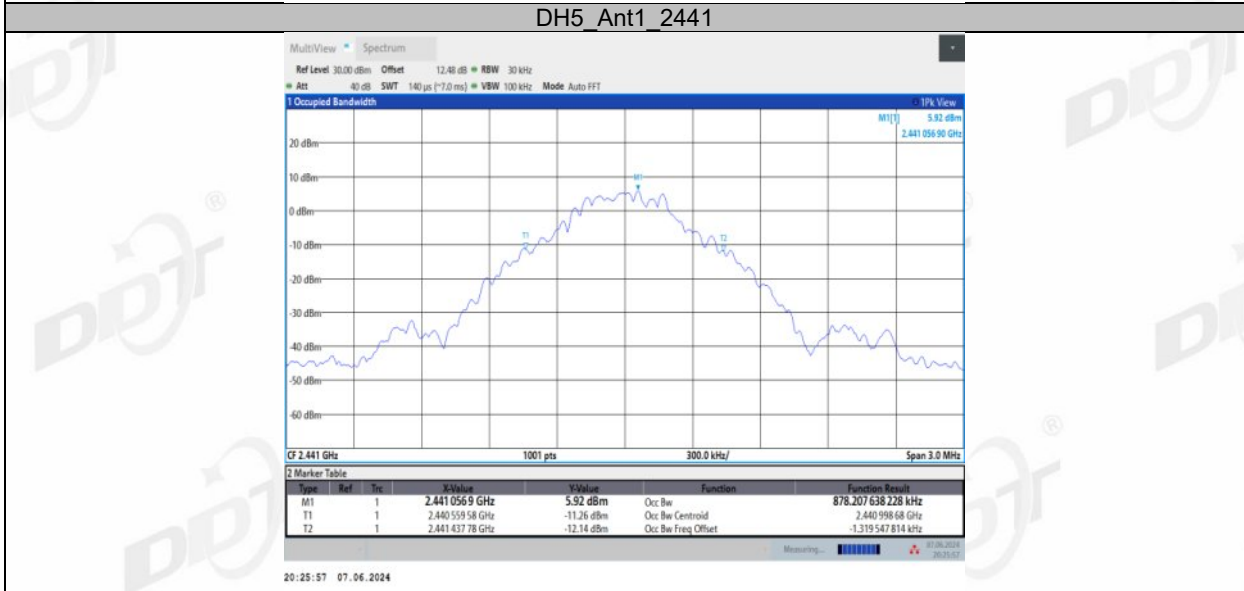
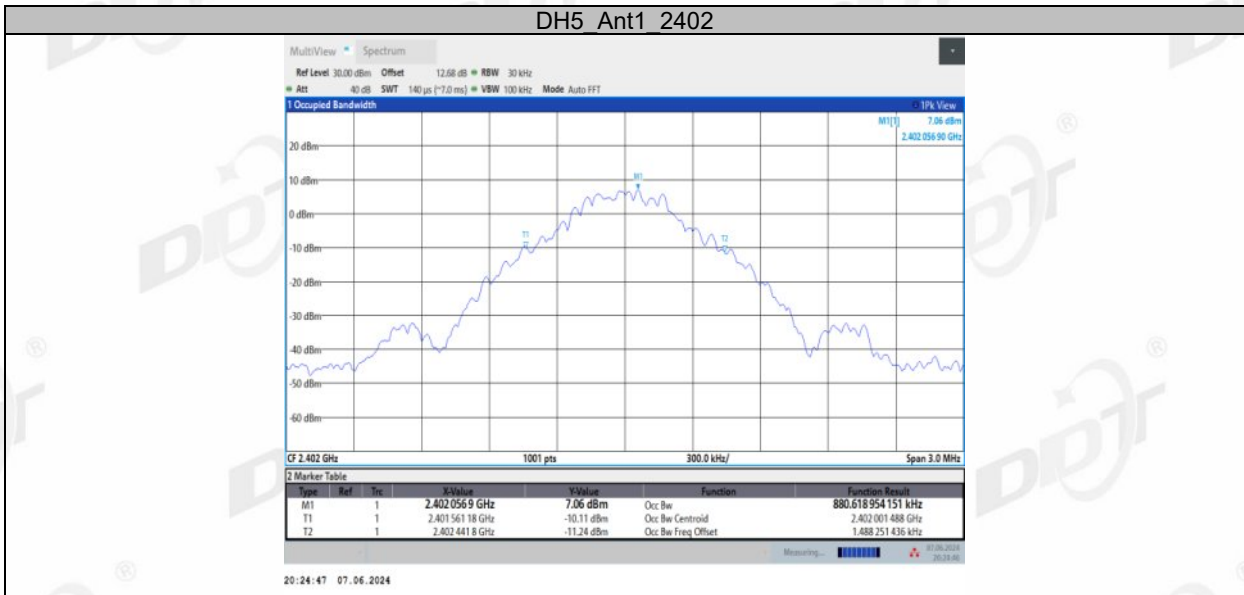

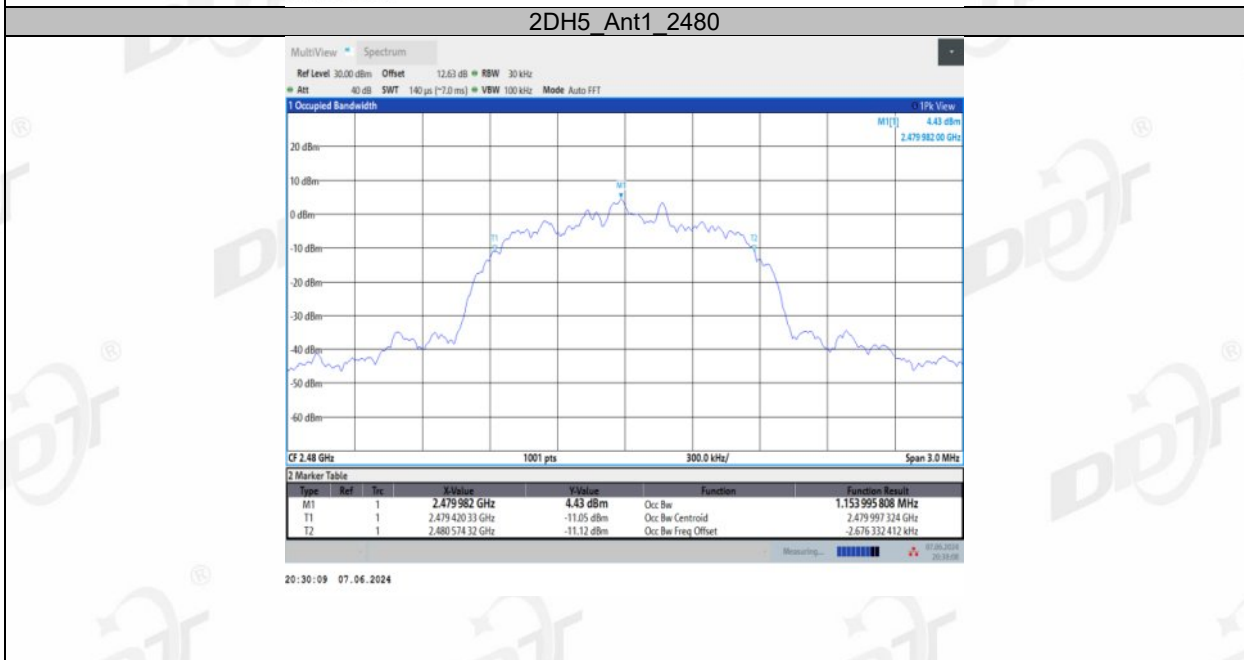
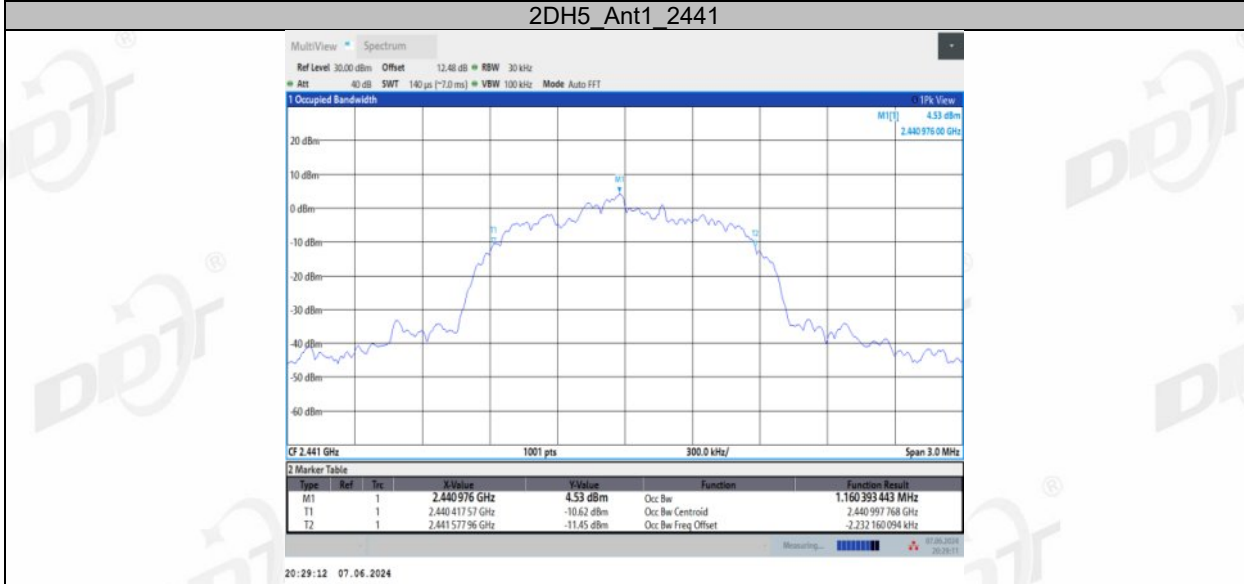



6. Maximum Peak Output Power

6.1. Block diagram of test setup

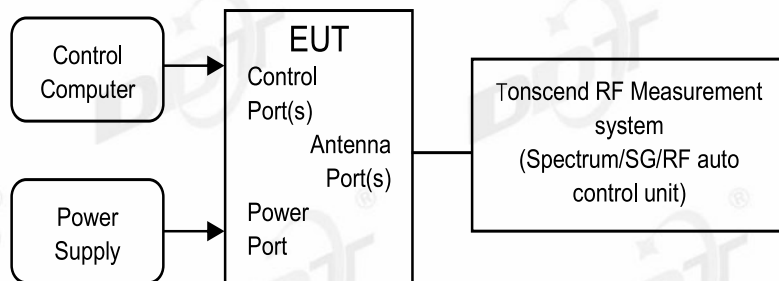

6.2. Limits

For frequency hopping systems operating in the 2400-2483.5 MHz band employing at least 75 non-overlapping hopping channels, and all frequency hopping systems in the 5725-5850 MHz band: 1 watt.

For all other frequency hopping systems in the 2400-2483.5 MHz band: 0.125 watts, the e.i.r.p shall not exceed 4W.

6.3. Test procedure

- (1) The test according to ANSI C63.10-2020 clause 7.8.5.
- (2) Connect EUT's antenna output to spectrum analyzer by RF cable, the path loss was compensated to the results.
- (3) Set the EUT as maximum power setting and enable the EUT transmit continuously.
- (4) Use the following spectrum analyzer settings for the maximum peak output power measurement:

RBW:	> 20 dB bandwidth of the emission being measured.
VBW:	VBW ≥ RBW.
Span:	Approximately five times the 20 dB bandwidth, centered on a hopping channel.
Detector Mode:	Peak
Sweep time:	Auto
Trace mode:	Max hold
- (5) Use the marker-to-peak function to set the marker to the peak of the emission and record the results in the report.

6.4. Test result

Test Engineer:	Zora Zhang	Test Site:	RF Measurement System 4#
Ambient Condition:	25.3°C, 55.6%RH	Test Date:	2024.06.07-2024.06.18
Test Power Supply:	AC 230V/50HZ	Sample Number:	S24052807-001

Test Mode	Antenna	Frequency [MHz]	Conducted Peak Power [dBm]	Conducted Limit [dBm]	EIRP [dBm]	EIRP Limit [dBm]	Verdict
DH5	Ant1	2402	10.65	≤20.97	10.36	≤30	PASS
		2441	9.02	≤20.97	8.73	≤30	PASS
		2480	8.27	≤20.97	7.98	≤30	PASS
2DH5	Ant1	2402	10.64	≤20.97	10.35	≤30	PASS
		2441	9.03	≤20.97	8.74	≤30	PASS
		2480	8.20	≤20.97	7.91	≤30	PASS
3DH5	Ant1	2402	10.65	≤20.97	10.36	≤30	PASS
		2441	9.02	≤20.97	8.73	≤30	PASS
		2480	8.22	≤20.97	7.93	≤30	PASS

6.5. Test graphs

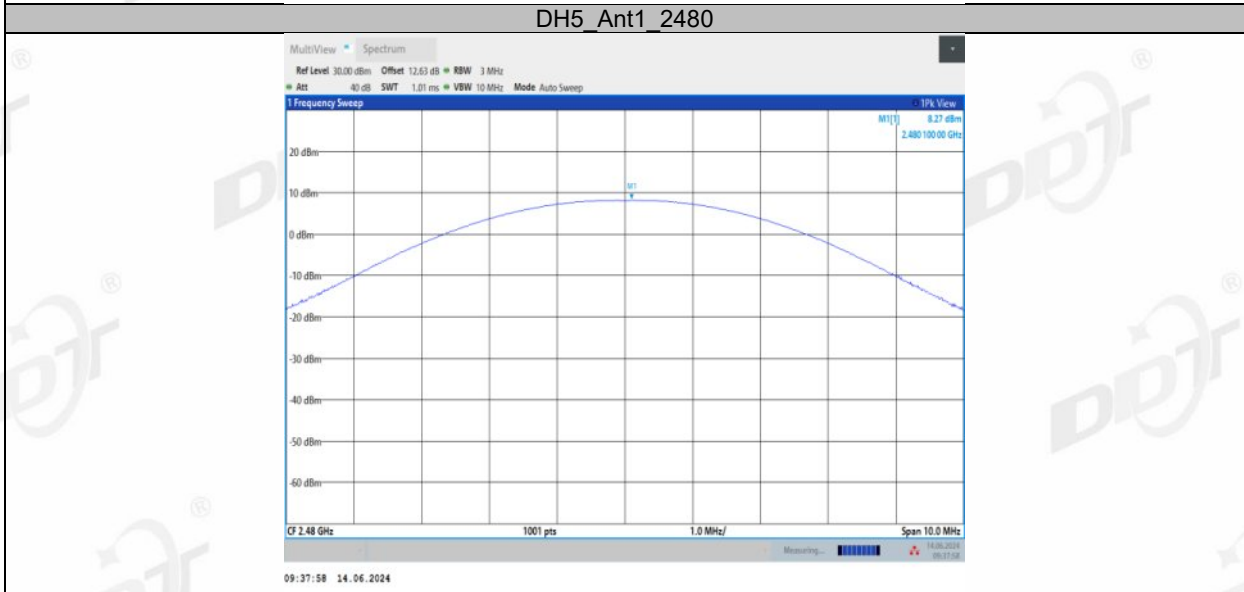
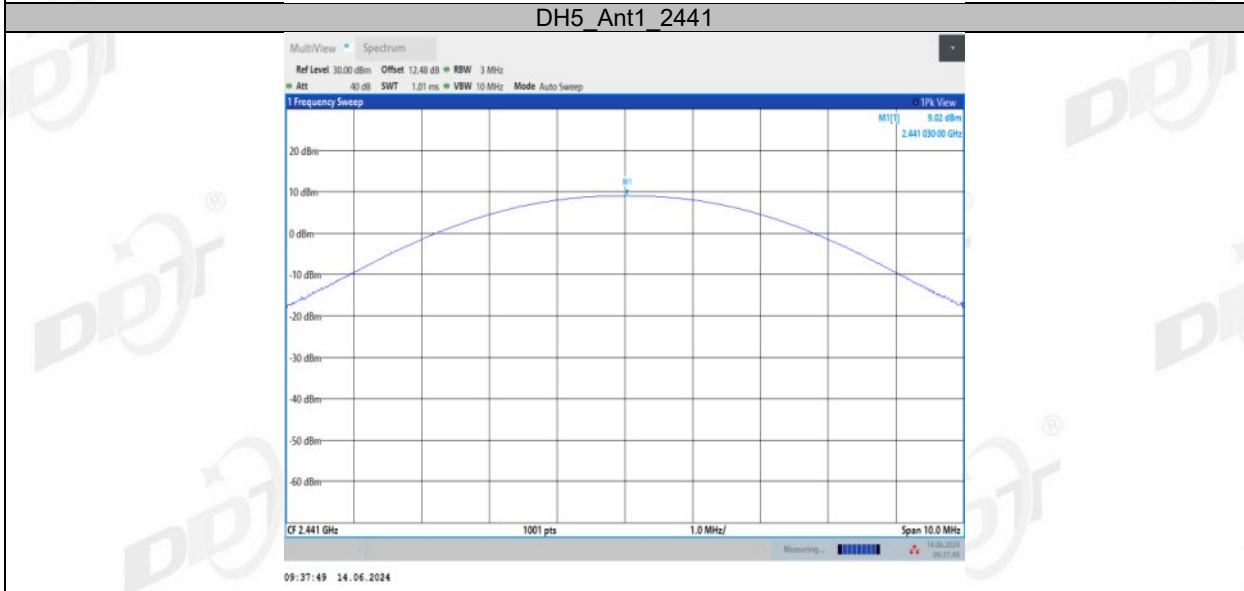
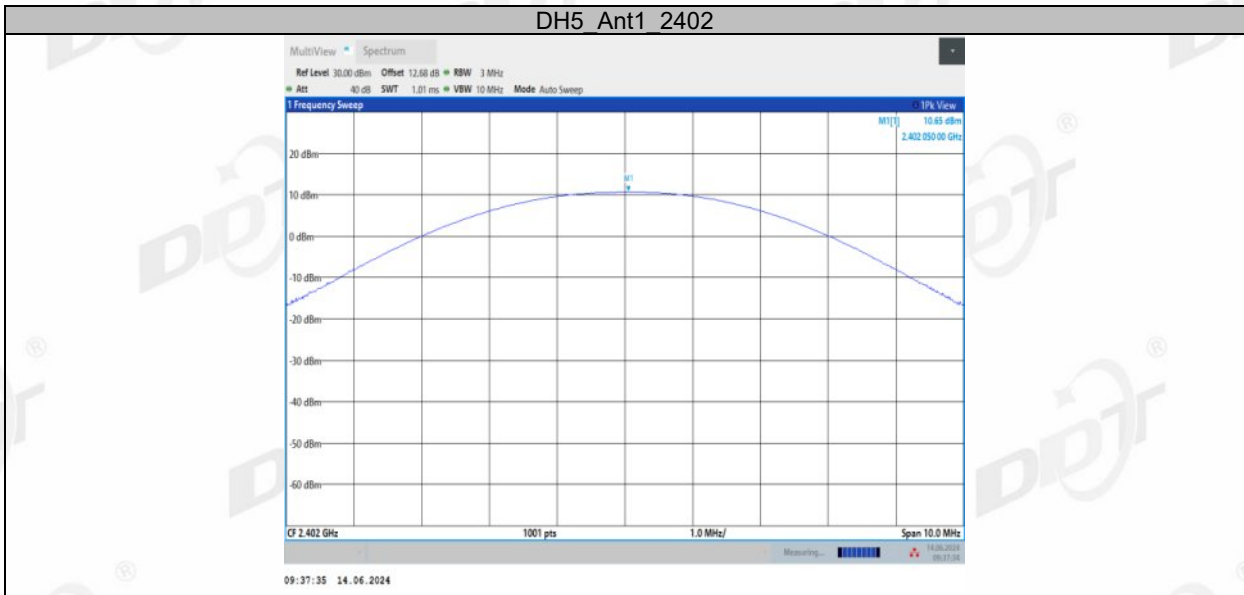

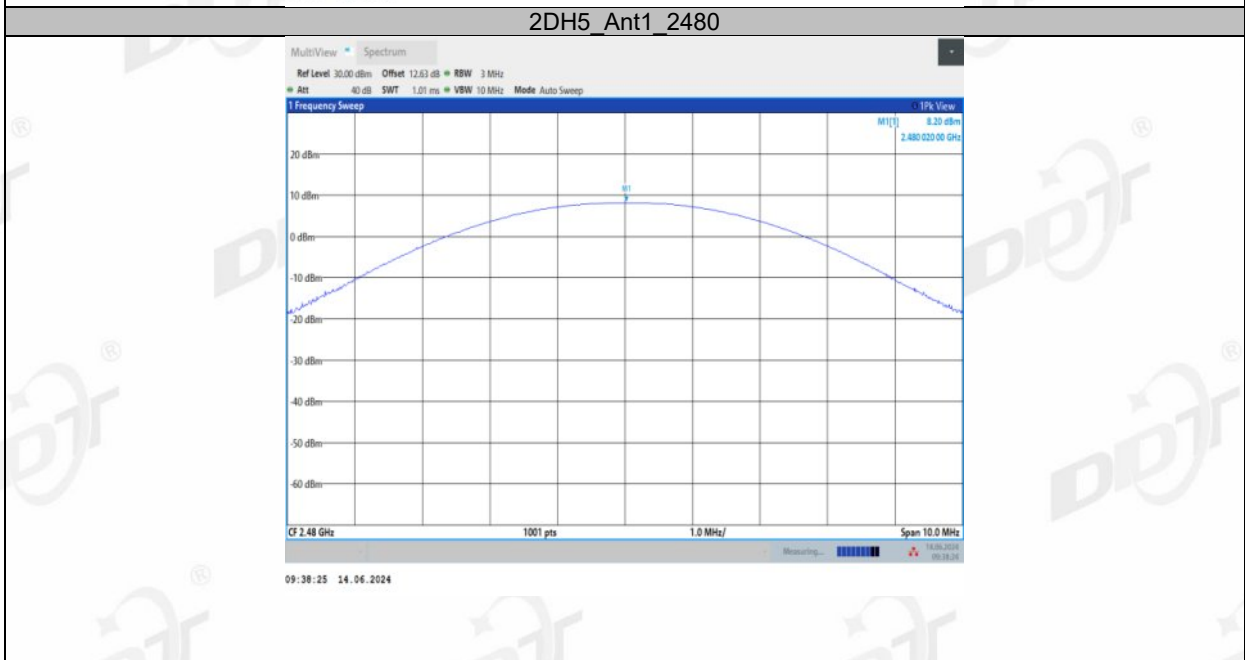
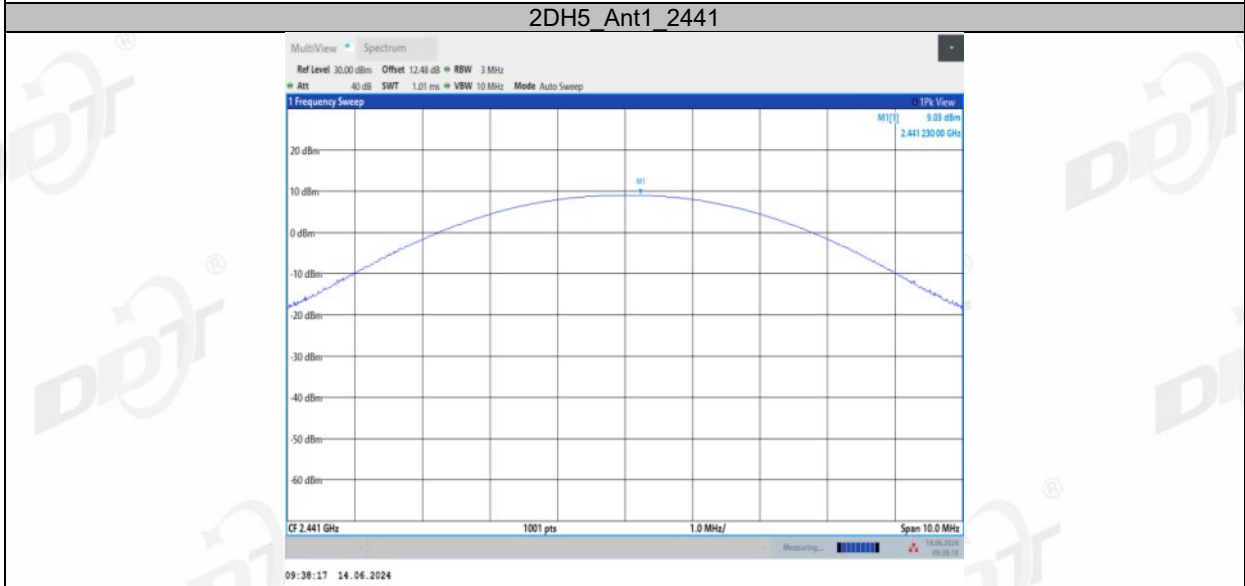
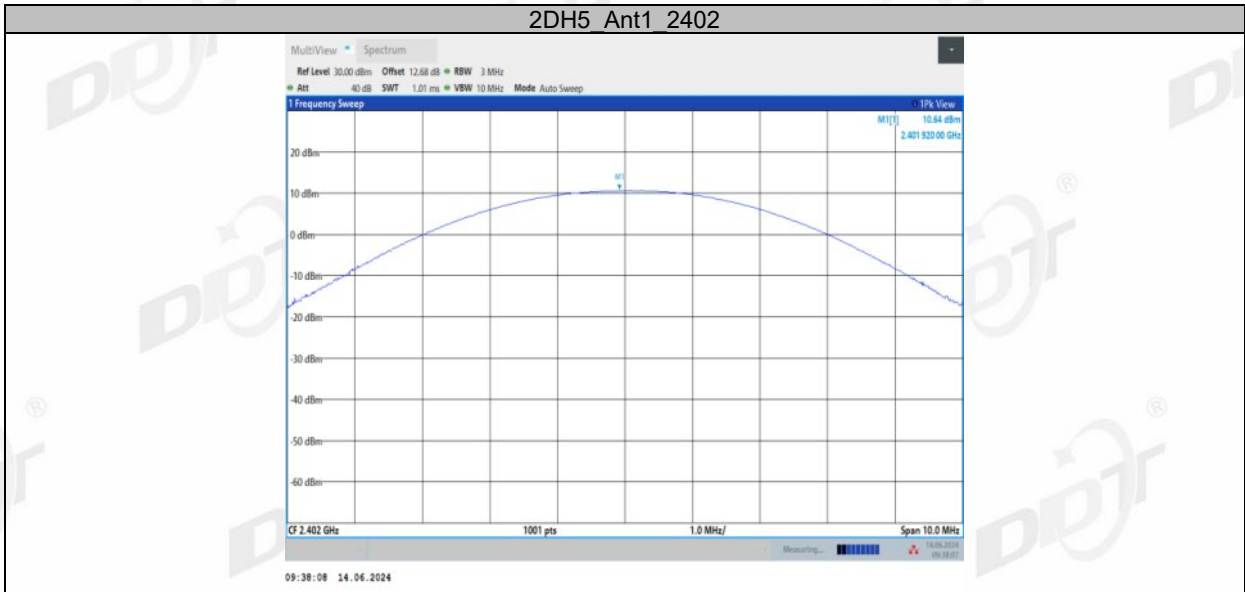

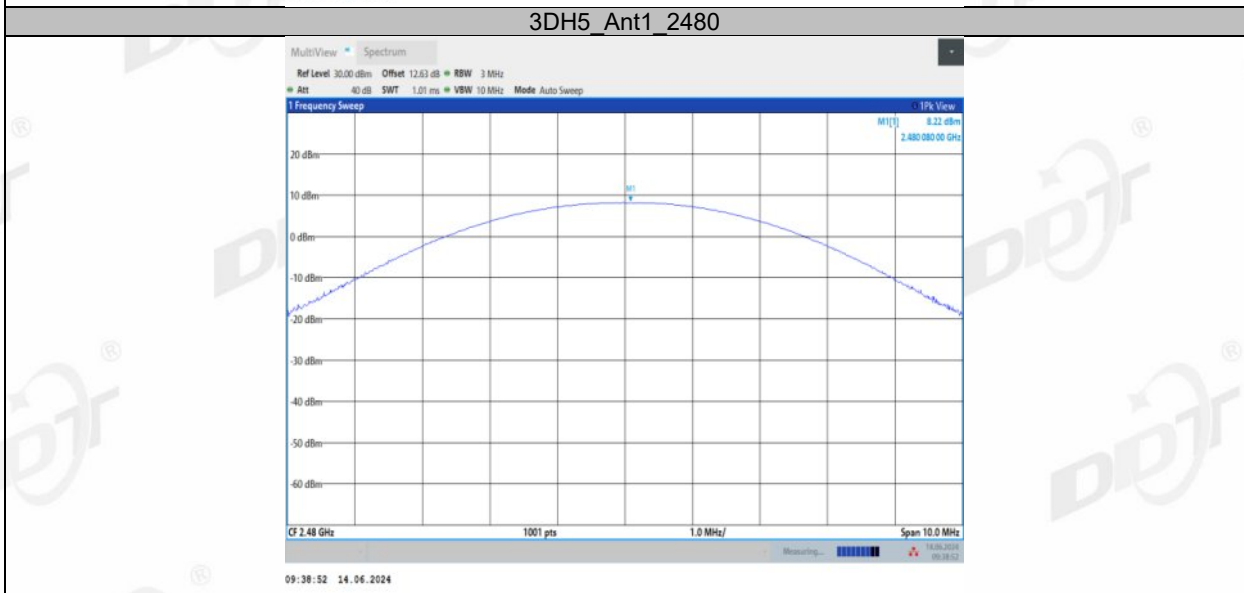
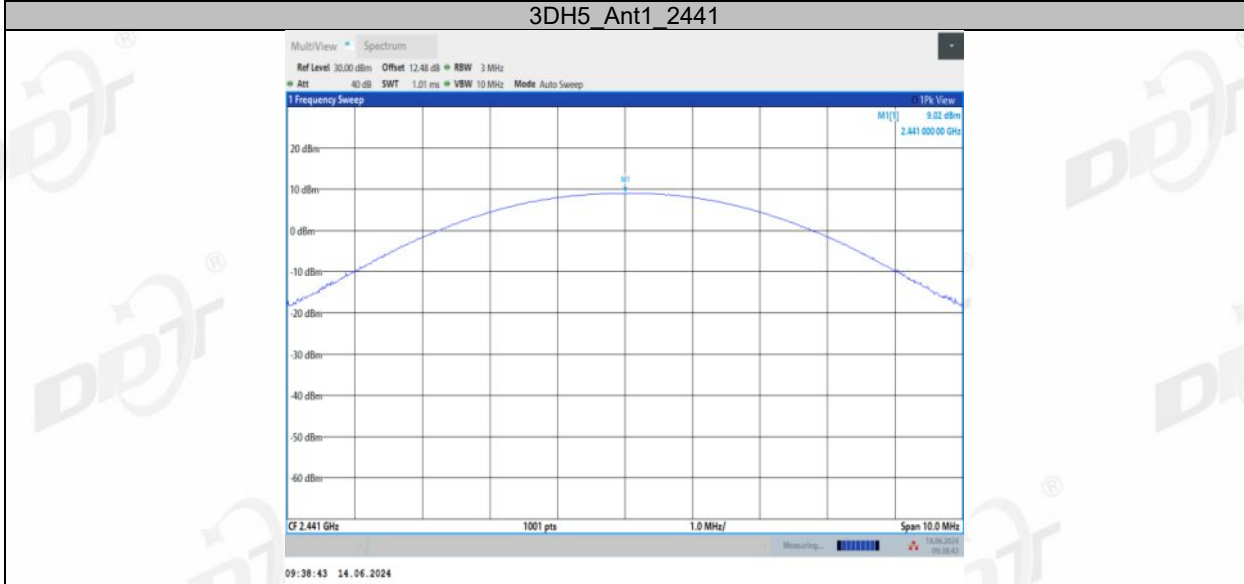
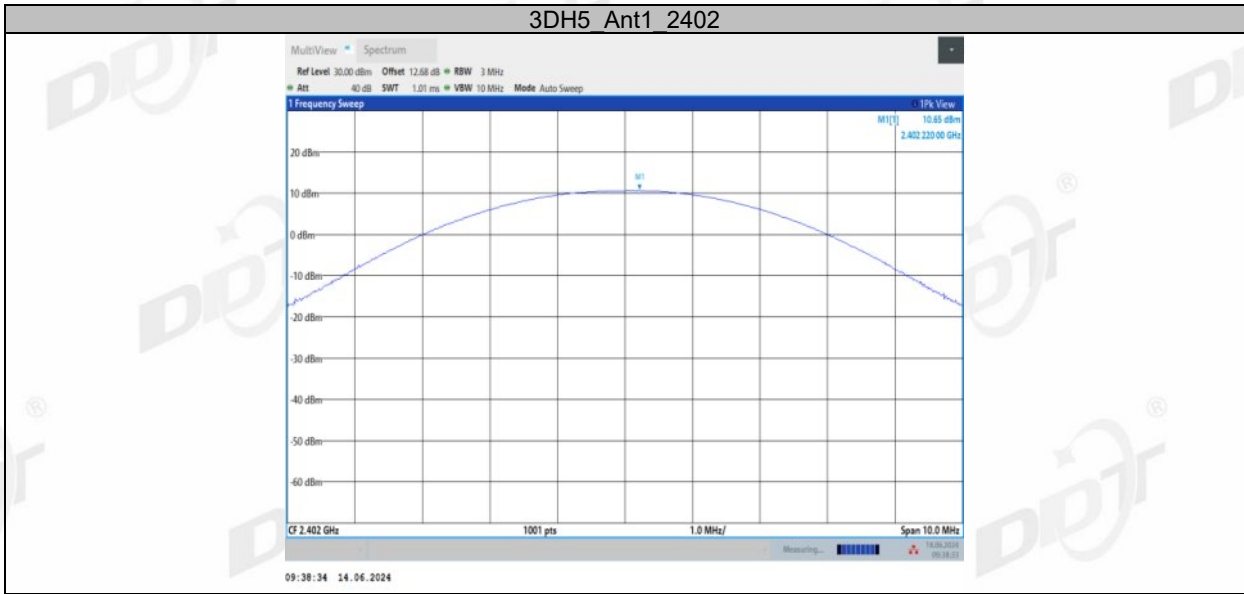

7. Carrier Frequency Separation

7.1. Block diagram of test setup

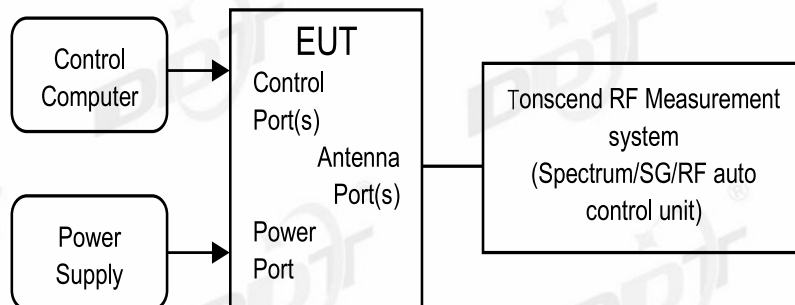

7.2. Limits

Frequency hopping systems shall have hopping channel carrier frequencies separated by a minimum of 25 kHz or the 20 dB bandwidth of the hopping channel, whichever is greater. Alternatively, frequency hopping systems operating in the 2400-2483.5 MHz band may have hopping channel carrier frequencies that are separated by 25 kHz or two-thirds of the 20 dB bandwidth of the hopping channel, whichever is greater, provided the systems operate with an output power no greater than 125 mW.

7.3. Test procedure

- (1) The test according to ANSI C63.10-2020 clause 7.8.2.
- (2) Connect EUT's antenna output to spectrum analyzer by RF cable, the path loss was compensated to the results.
- (3) Set the EUT as maximum power setting and enable the EUT transmit continuously.
- (4) Use the following spectrum analyzer settings for the maximum peak output power measurement:

RBW:	approximately 30% of the channel spacing
VBW:	VBW \geq RBW.
Span:	Wide enough to capture the peaks of two adjacent channels.
Detector Mode:	Peak
Sweep time:	Auto
Trace mode:	Max hold
- (5) Use the marker-delta function to determine the separation between the peaks of the adjacent channels and record the results in the report.

7.4. Test result

Test Engineer:	Zora Zhang	Test Site:	RF Measurement System 4#
Ambient Condition:	25.3°C, 55.6%RH	Test Date:	2024.06.07-2024.06.18
Test Power Supply:	AC 230V/50HZ	Sample Number:	S24052807-001

Test Mode	Antenna	Frequency [MHz]	Result [MHz]	Limit [MHz]	Verdict
DH5	Ant1	Hop	1.008	≥0.640	PASS
2DH5	Ant1	Hop	1.010	≥0.880	PASS
3DH5	Ant1	Hop	1.332	≥0.873	PASS

7.5. Test graphs

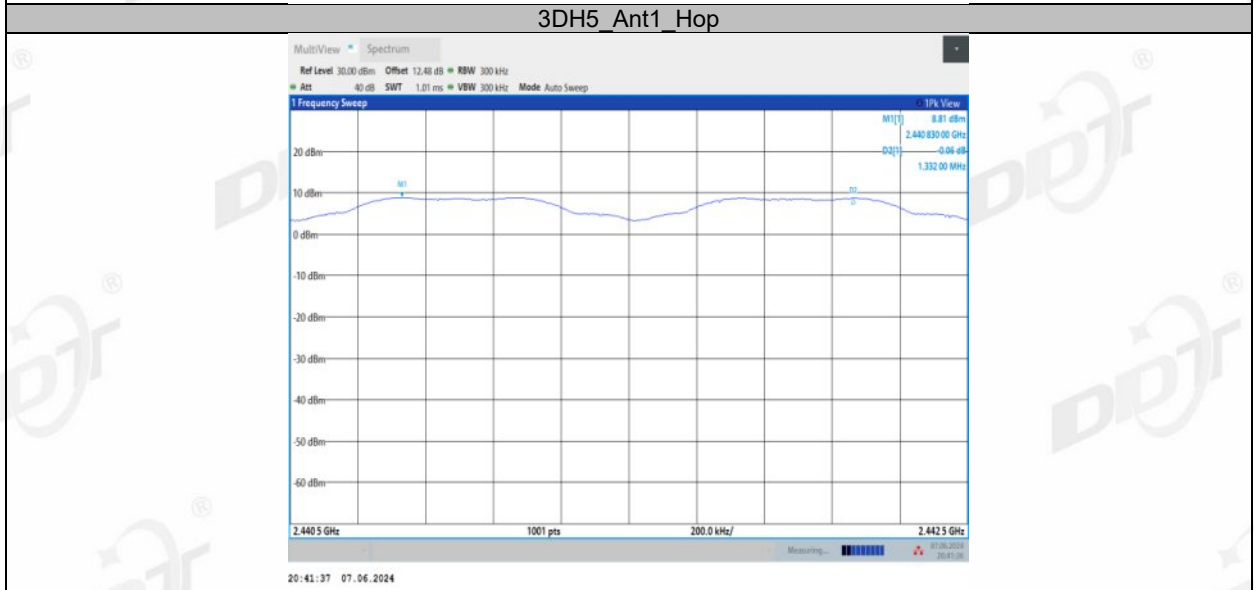
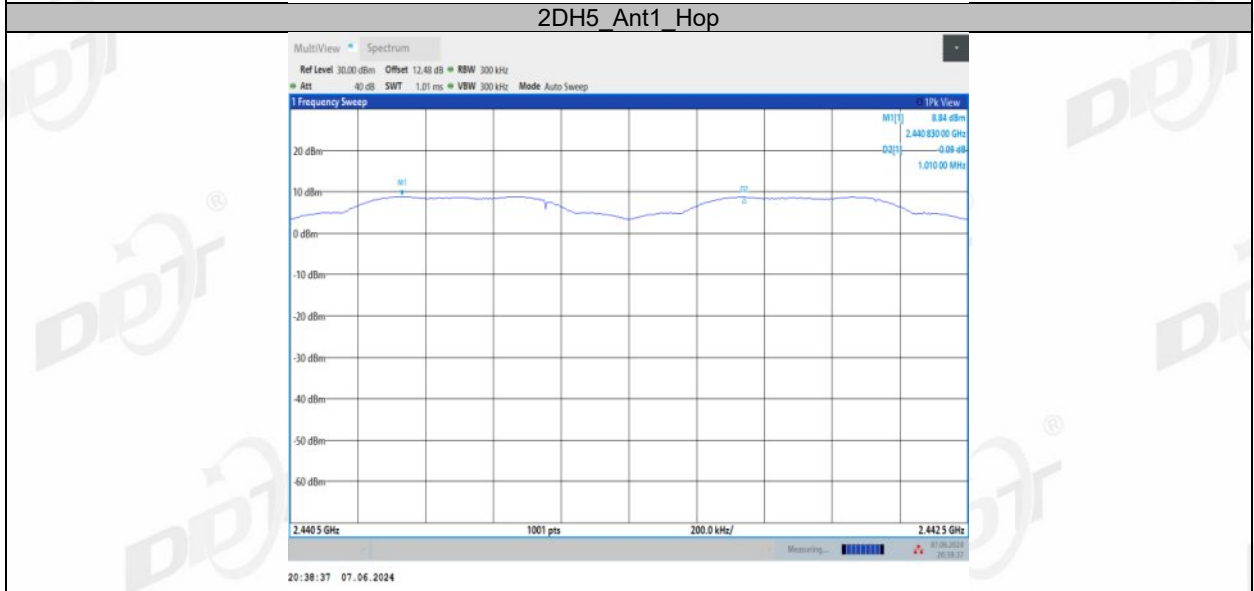
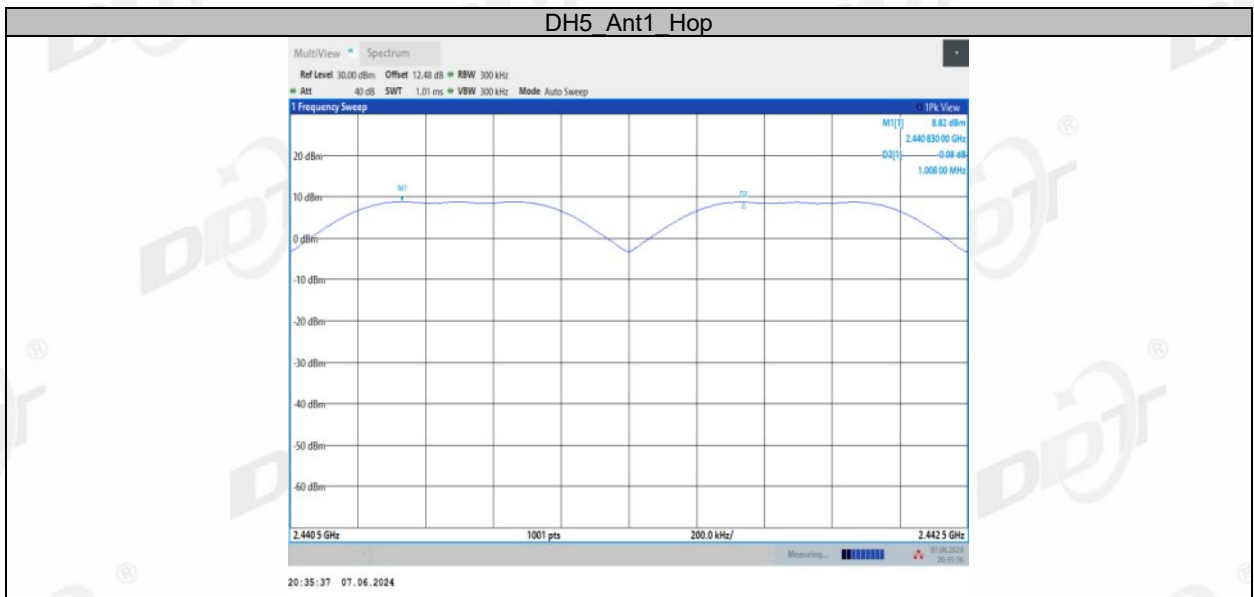

8. Dwell Time

8.1. Block diagram of test setup

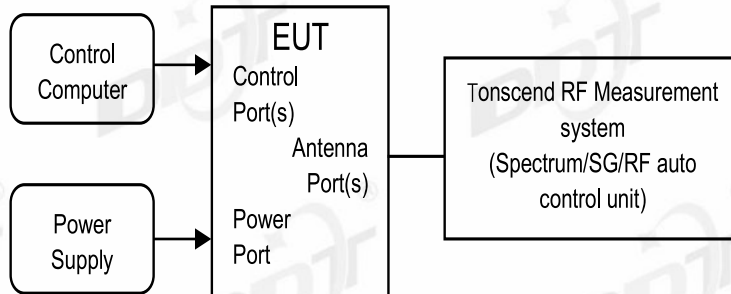

8.2. Limits

The average time of occupancy on any channel shall not be greater than 0.4 seconds within a period of 0.4 seconds multiplied by the number of hopping channels employed.

8.3. Test procedure

- (1) The test according to ANSI C63.10-2020 clause 7.8.4.
- (2) Connect EUT's antenna output to spectrum analyzer by RF cable, the path loss was compensated to the results.
- (3) Set the EUT as maximum power setting and enable the EUT transmit continuously.
- (4) Use the following spectrum analyzer settings for the maximum peak output power measurement:

RBW:	≤ channel spacing and where possible RBW should be set $\gg 1 / T$
VBW:	$VBW \geq RBW$.
Span:	Zero span, centered on a hopping channel.
Detector Mode:	Peak
Sweep time:	Auto
Trace mode:	Clear Write.
- (5) The test period: $T = 0.4 \text{ Second/Channel} \times 79 \text{ Channel} = 31.6 \text{ s}$
- (6) Measure the hopping number and on time of each pulse with spectrum analyzer in zero span set, and calculate dwell time with formula Dwell time = total hops * pulse's on time.
- (7) Measure and record the results in the report.

8.4. Test result

Test Engineer:	Zora Zhang	Test Site:	RF Measurement System 4#
Ambient Condition:	25.3°C, 55.6%RH	Test Date:	2024.06.07-2024.06.18
Test Power Supply:	AC 230V/50HZ	Sample Number:	S24052807-001

Test Mode	Antenna	Frequency [MHz]	Burst Width [ms]	Total Hops [Num]	Result [s]	Limit [s]	Verdict
DH1	Ant1	Hop	0.370	316	0.117	≤0.4	PASS
DH3	Ant1	Hop	1.630	164	0.267	≤0.4	PASS
DH5	Ant1	Hop	2.880	94	0.271	≤0.4	PASS
2DH1	Ant1	Hop	0.390	316	0.123	≤0.4	PASS
2DH3	Ant1	Hop	1.630	169	0.275	≤0.4	PASS
2DH5	Ant1	Hop	2.890	115	0.332	≤0.4	PASS
3DH1	Ant1	Hop	0.390	319	0.124	≤0.4	PASS
3DH3	Ant1	Hop	1.640	164	0.269	≤0.4	PASS
3DH5	Ant1	Hop	2.890	109	0.315	≤0.4	PASS

8.5. Test graphs

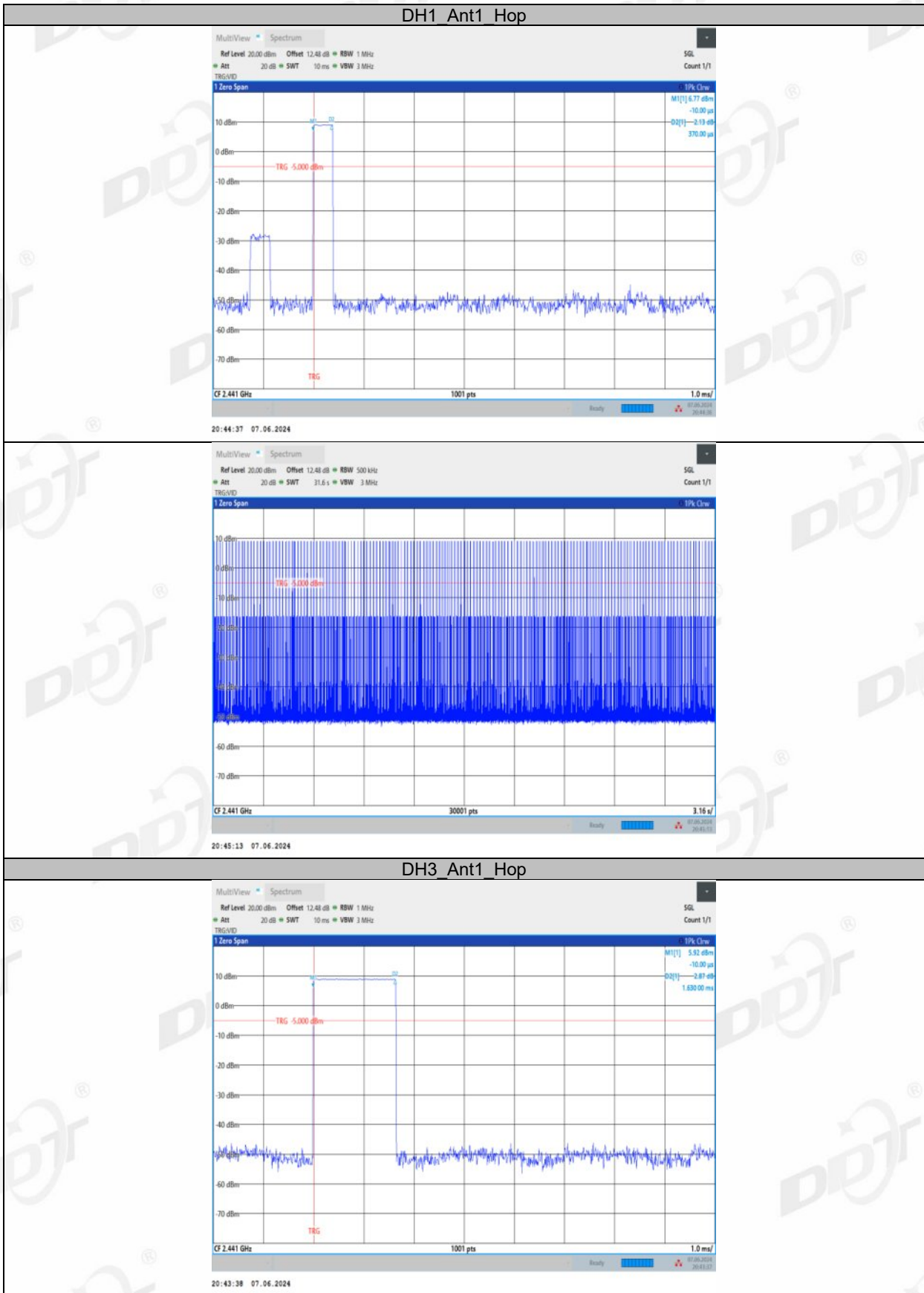

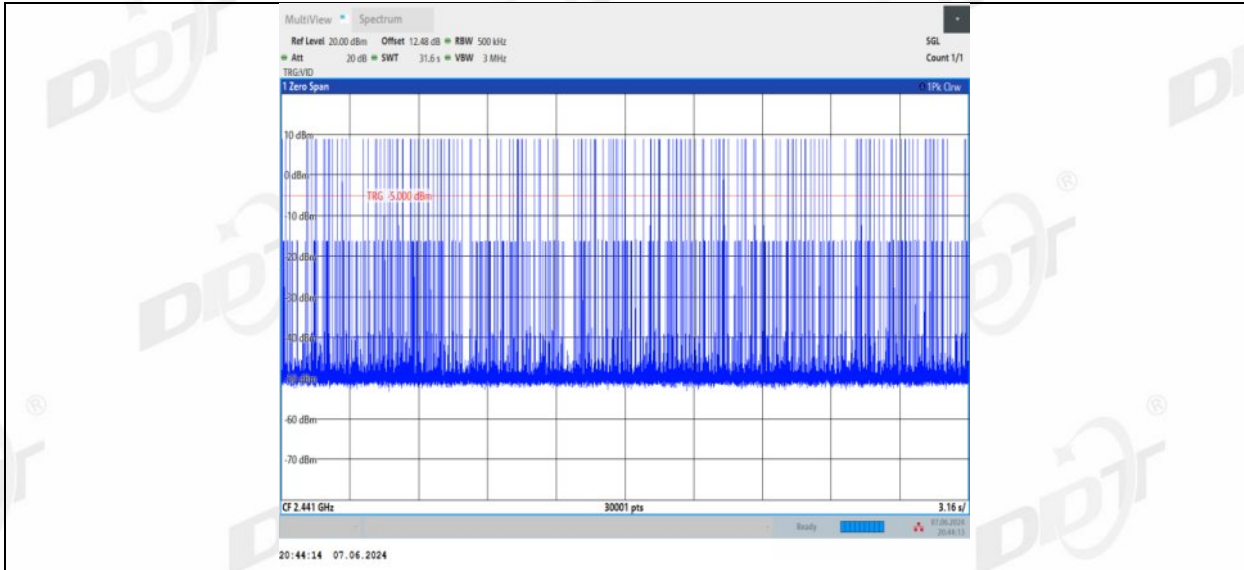

DH5_Ant1_Hop

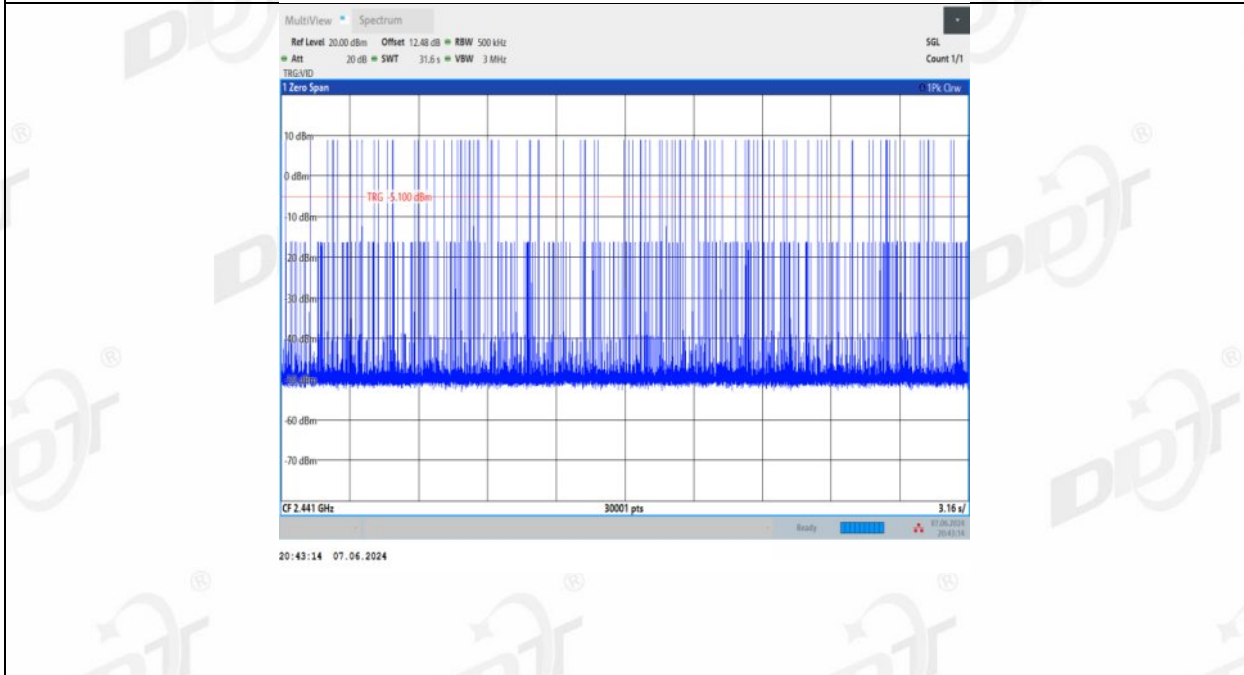
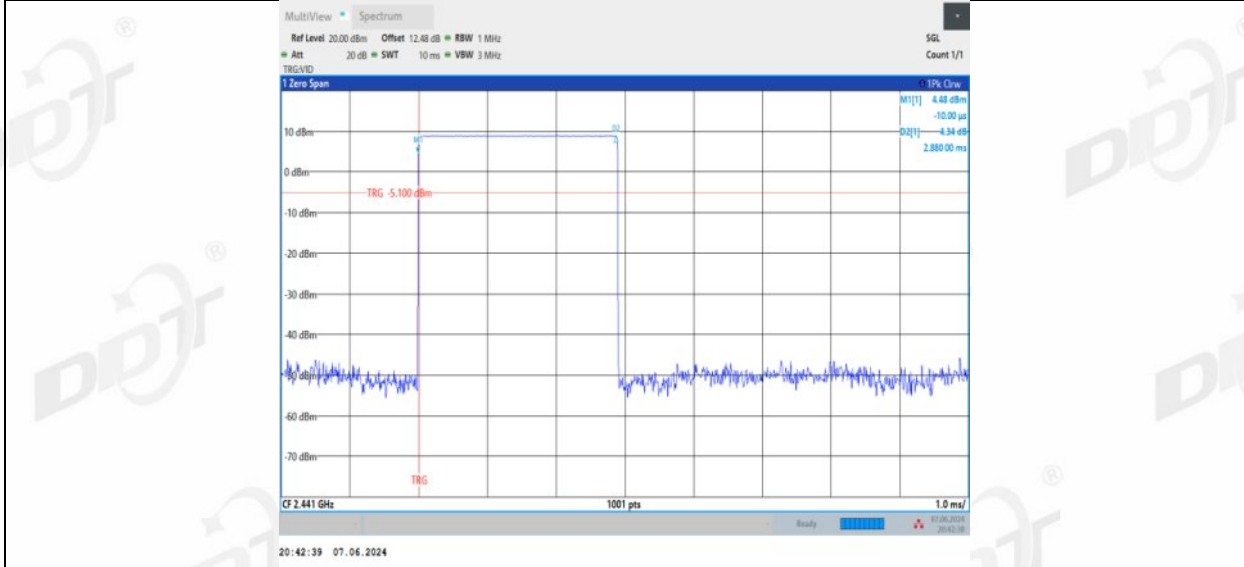

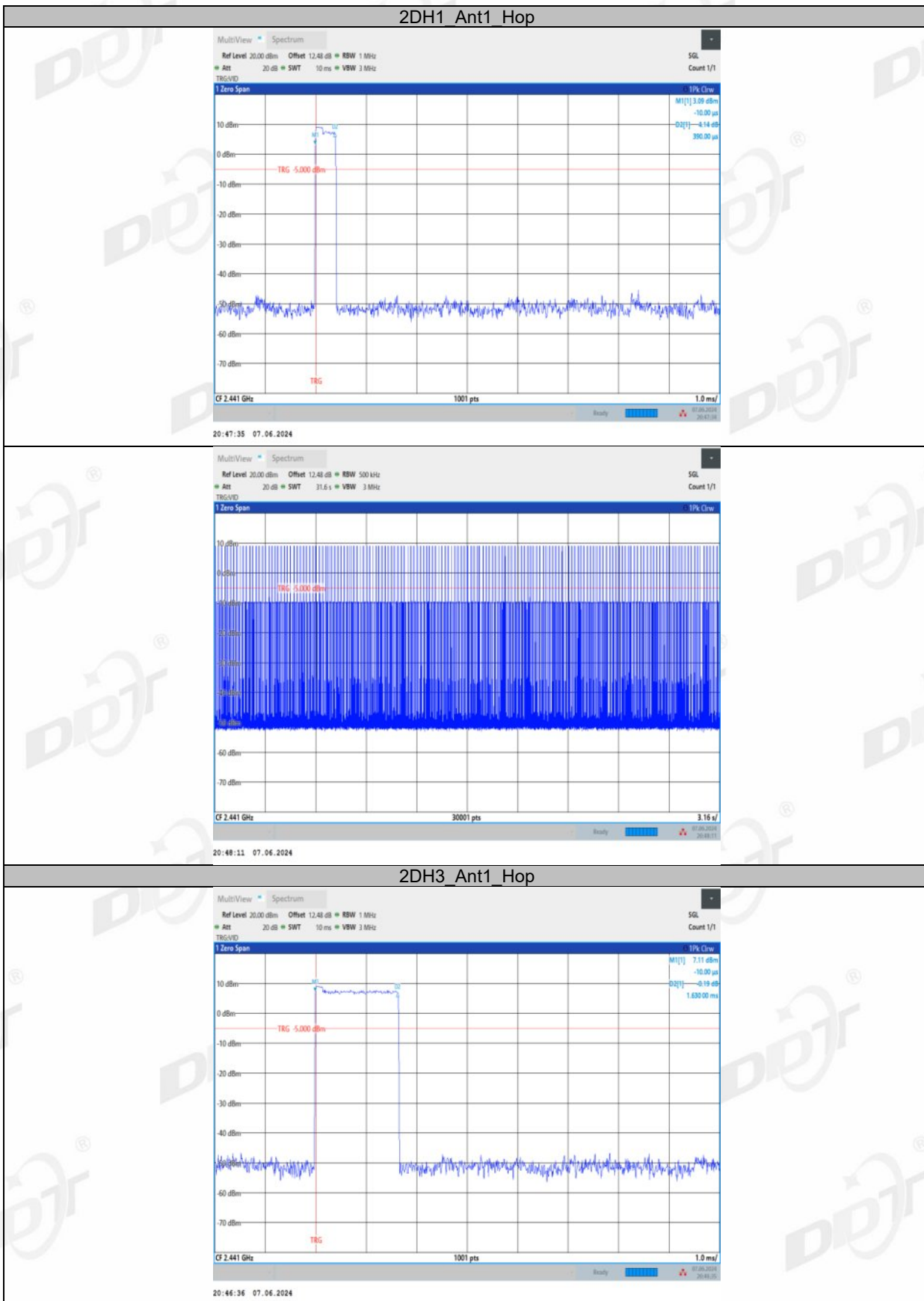

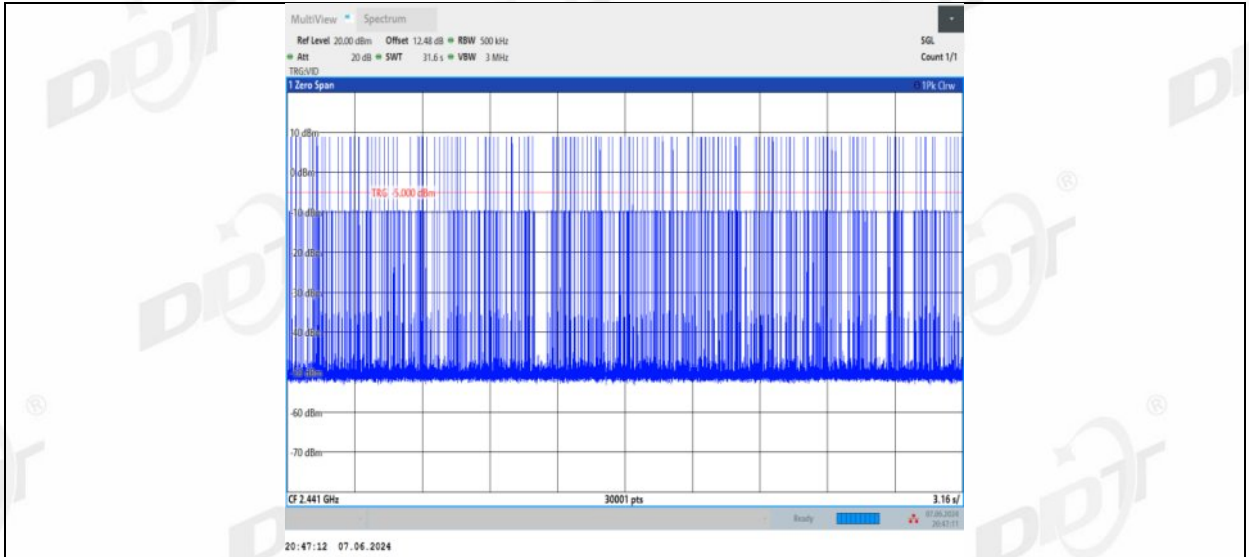

2DH5_Ant1_Hop

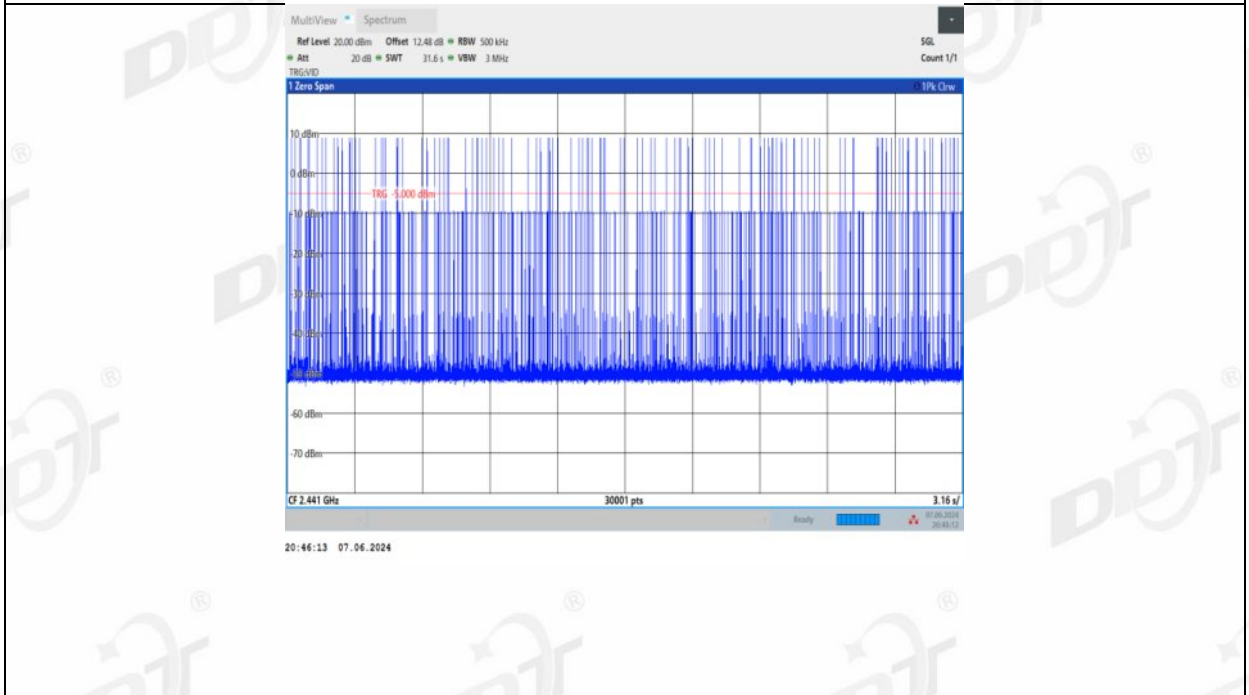
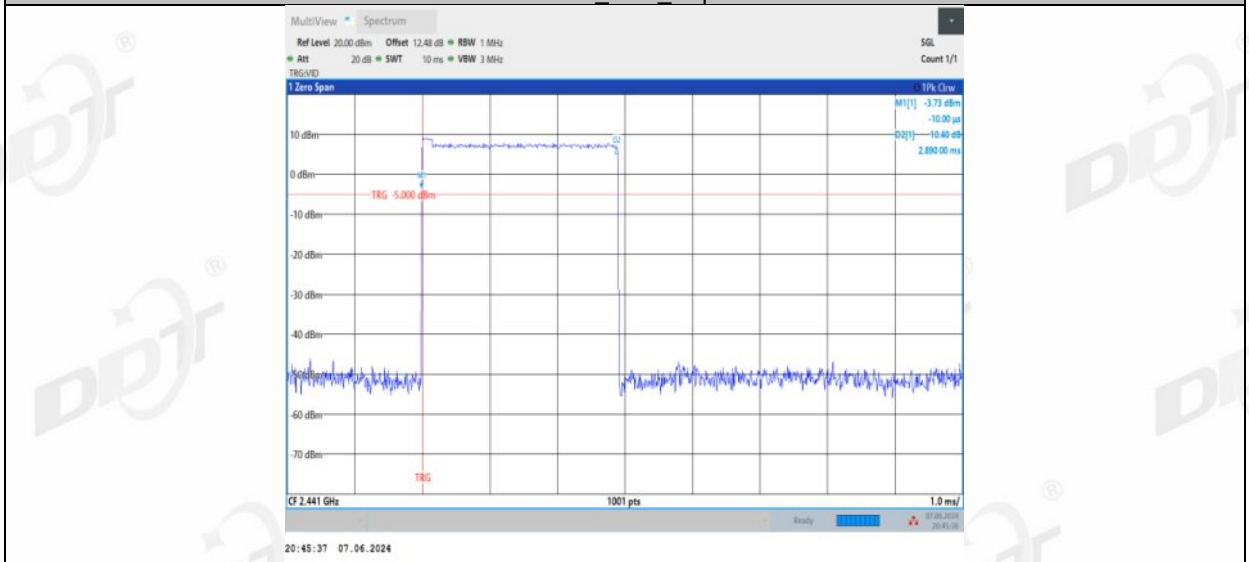

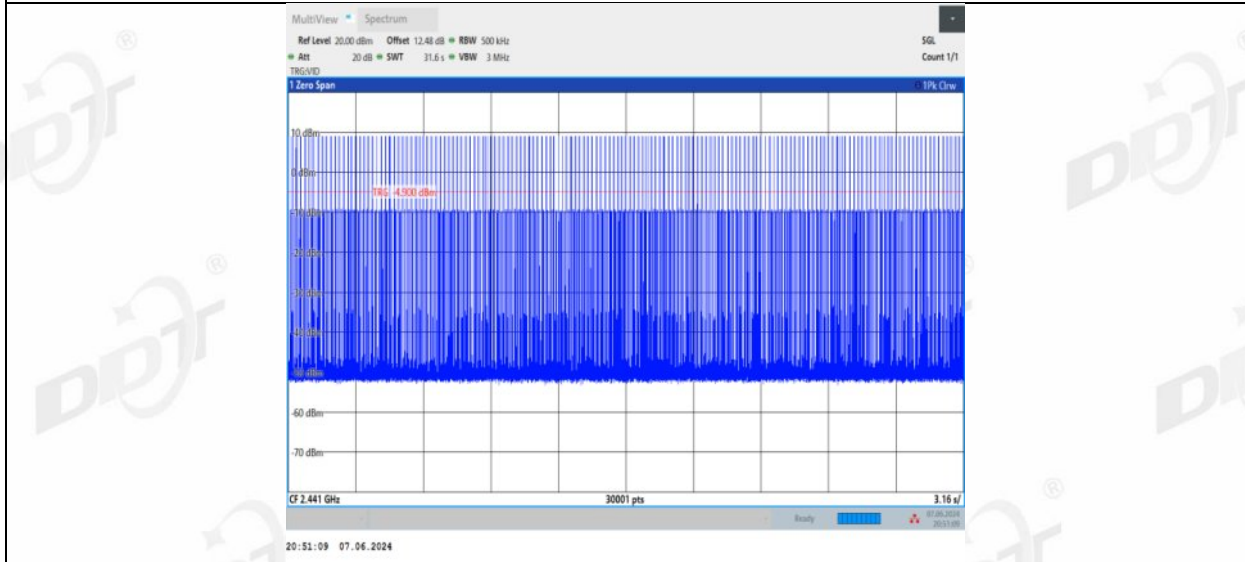
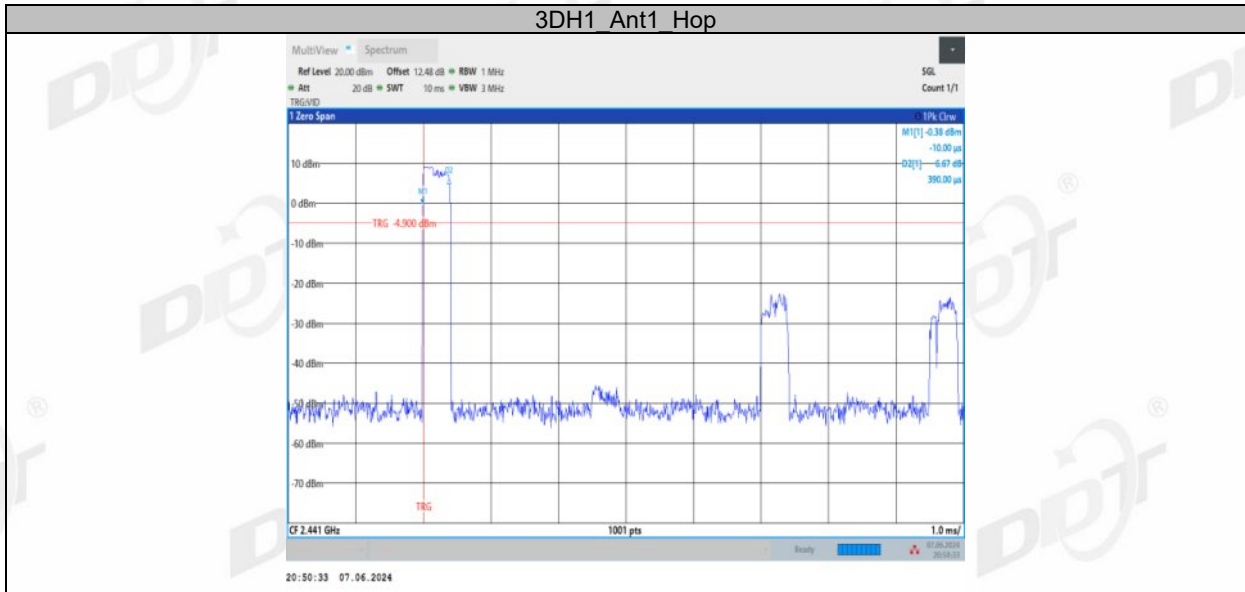

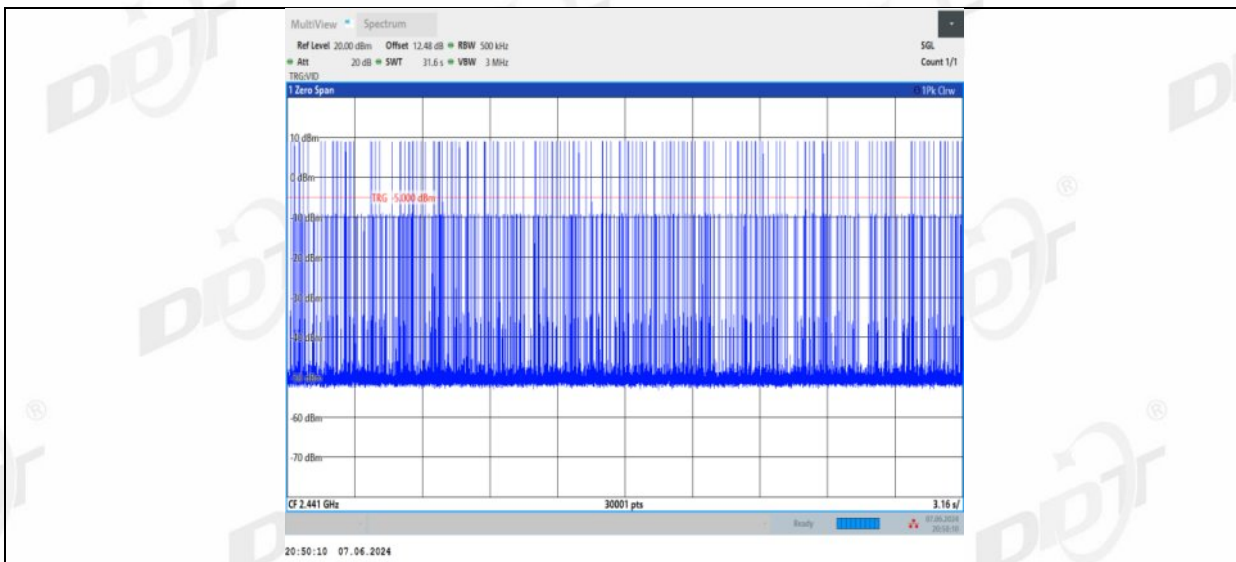

3DH5_Ant1_Hop

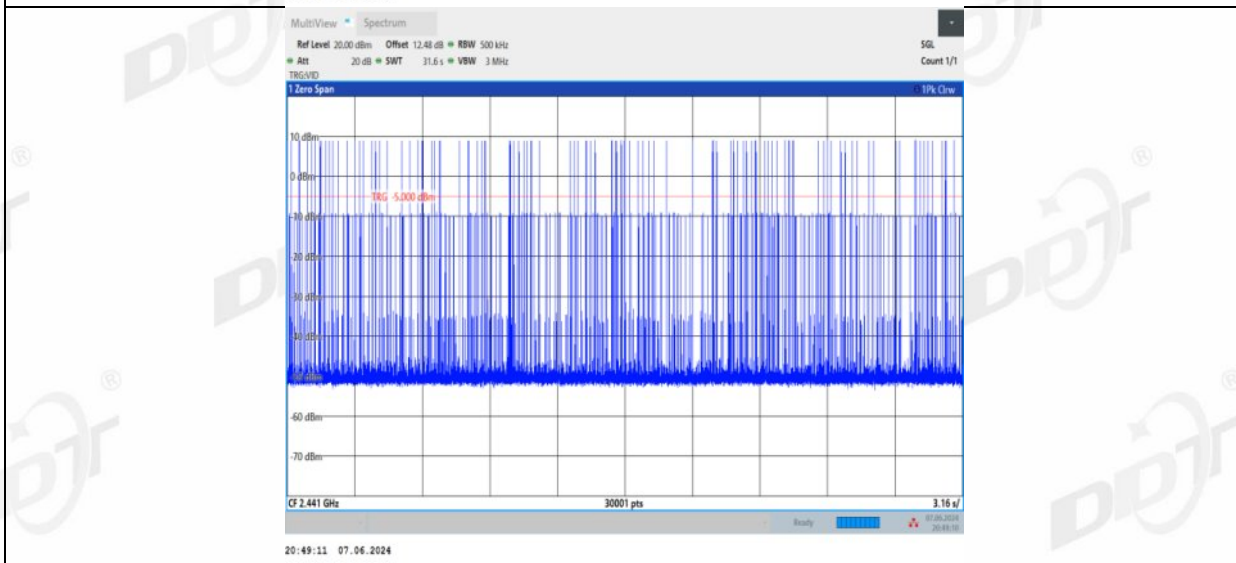
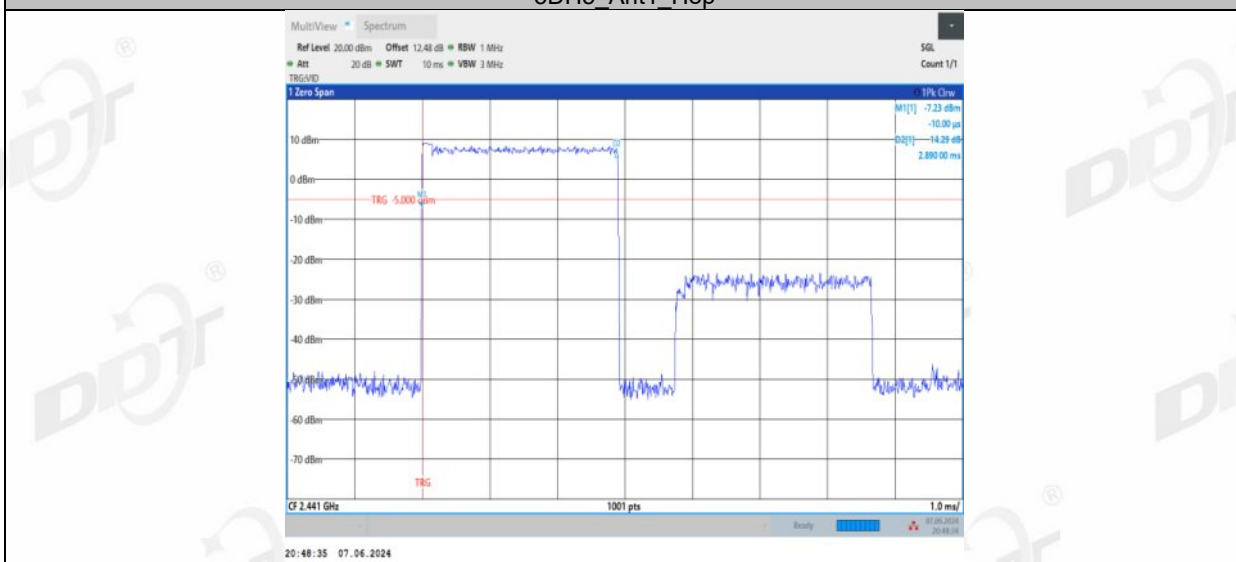

9. Number of Hopping Channel

9.1. Block diagram of test setup

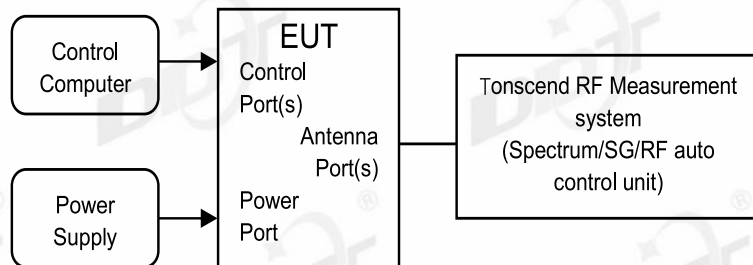

9.2. Limits

Frequency hopping systems in the 2400-2483.5 MHz band shall use at least 15 channels.

9.3. Test procedure

- (1) The test according to ANSI C63.10-2020 clause 7.8.3.
- (2) Connect EUT's antenna output to spectrum analyzer by RF cable, the path loss was compensated to the results.
- (3) Set the EUT as maximum power setting and enable the EUT transmit continuously.
- (4) Use the following spectrum analyzer settings for the maximum peak output power measurement:

RBW:	RBW to less than 30% of the channel spacing or the 20 dB bandwidth, whichever is smaller.
VBW:	VBW \geq RBW.
Span:	The frequency band of operation
Detector Mode:	Peak
Sweep time:	Auto
Trace mode:	Max hold
- (5) Measure the hopping number and record the results in the report.
- (6) Measure and record the results in the report.

9.4. Test result

Test Engineer:	Zora Zhang	Test Site:	RF Measurement System 4#
Ambient Condition:	25.3°C, 55.6%RH	Test Date:	2024.06.07-2024.06.18
Test Power Supply:	AC 230V/50HZ	Sample Number:	S24052807-001

Test Mode	Antenna	Frequency [MHz]	Result [Num]	Limit [Num]	Verdict
DH5	Ant1	Hop	79	≥15	PASS
2DH5	Ant1	Hop	79	≥15	PASS
3DH5	Ant1	Hop	79	≥15	PASS

9.5. Test graphs

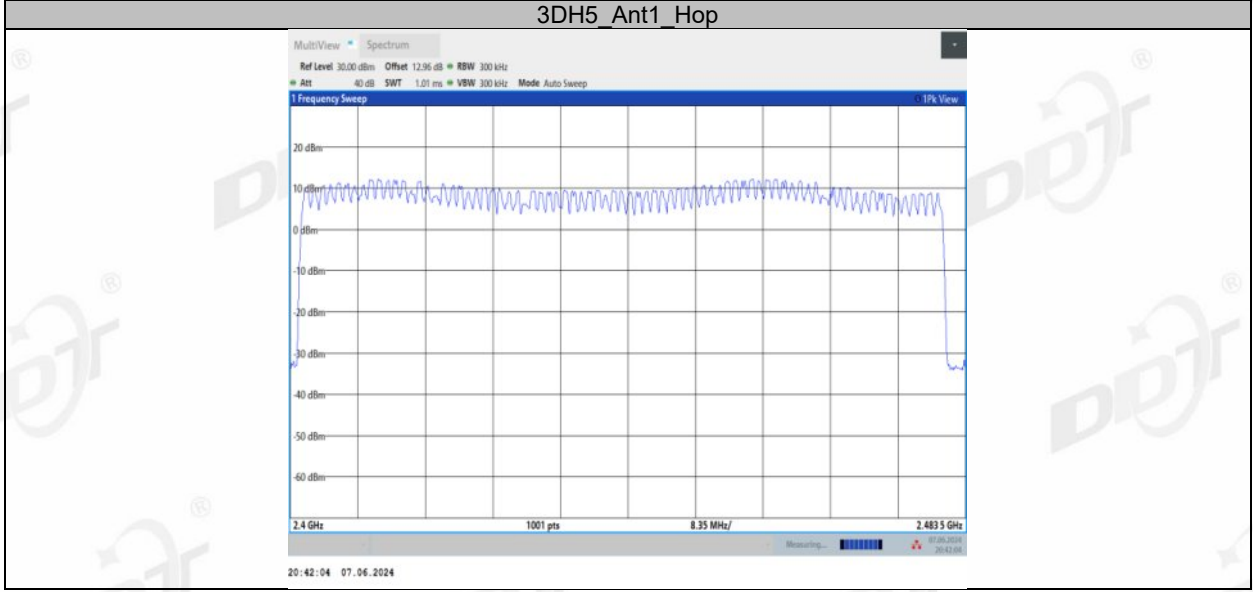
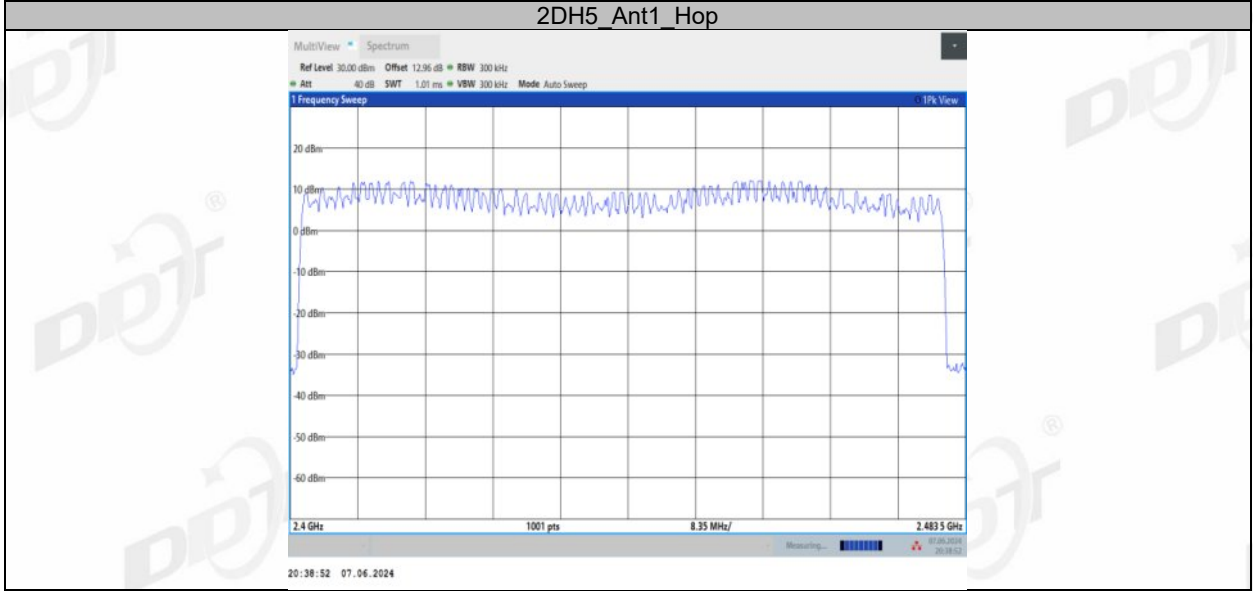
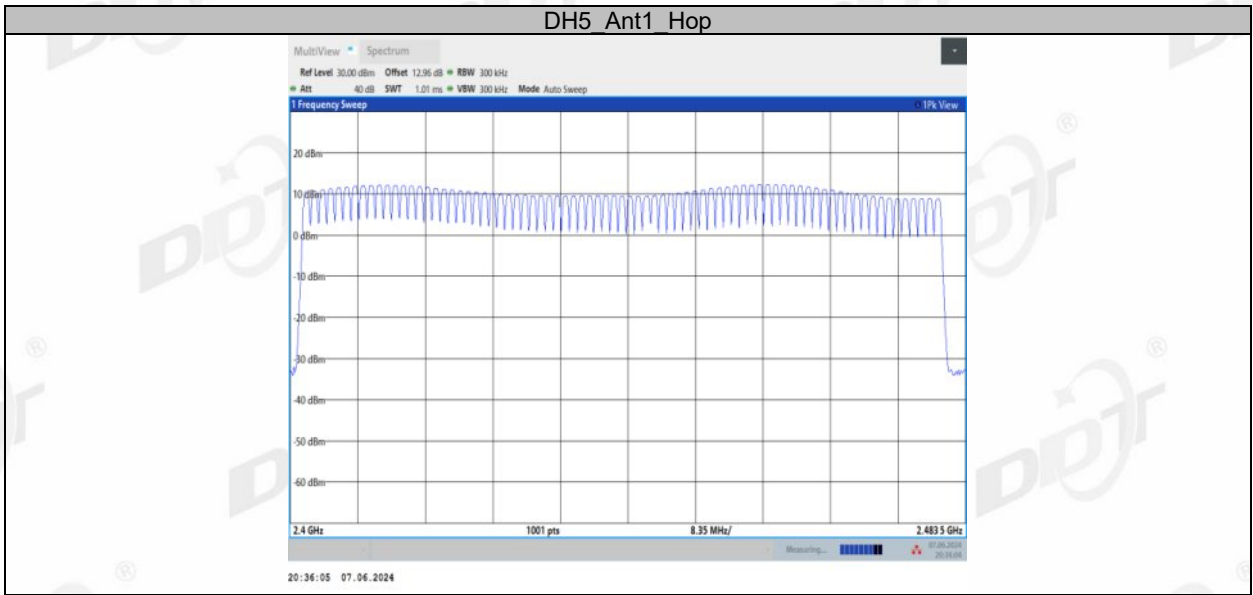

10. Band Edge Compliance (Conducted Method)

10.1. Block diagram of test setup

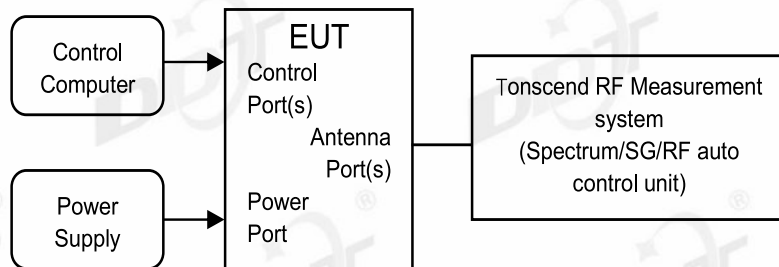

10.2. Limit

All restriction band should comply with 15.209, other emission should be at least 20dB below the fundamental.

10.3. Test procedure

- (1) Connect EUT's antenna output to spectrum analyzer by RF cable.
- (2) Establish a reference level by using the following procedure:

RBW:	100 kHz
VBW:	300 kHz
Span	Encompass frequency range to be measured
Detector Mode:	Peak
Sweep time:	Auto
Trace mode	Max hold
- (3) Allow the trace to stabilize, use the peak marker function to determine the maximum peak power level to establish the reference level.
- (4) Then mark the maximum amplitude of all unwanted emissions outside of the authorized frequency band.

10.4. Test result

Test Engineer:	Zora Zhang	Test Site:	RF Measurement System 4#
Ambient Condition:	25.3°C, 55.6%RH	Test Date:	2024.06.07-2024.06.18
Test Power Supply:	AC 230V/50HZ	Sample Number:	S24052807-001

Mode	Frequency (MHz)	Verdict
DH5	Hopping off 2402	Pass
	Hopping off 2480	Pass
	Hopping on	Pass
2DH5	Hopping off 2402	Pass
	Hopping off 2480	Pass
	Hopping on	Pass
3DH5	Hopping off 2402	Pass
	Hopping off 2480	Pass
	Hopping on	Pass

10.5. Test graphs

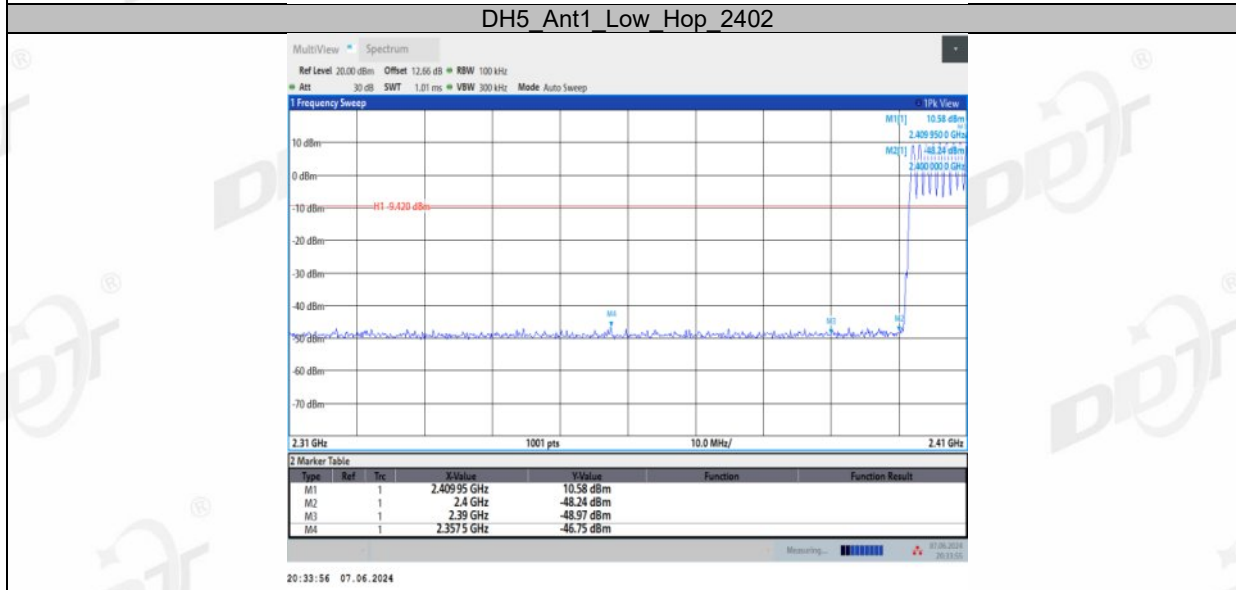
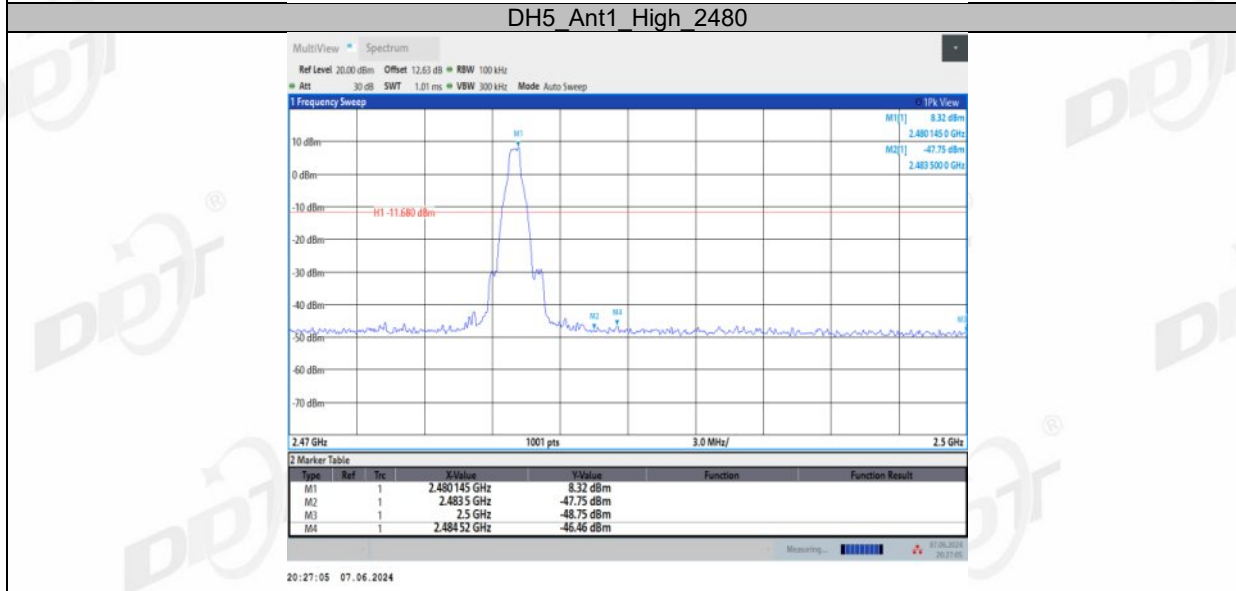
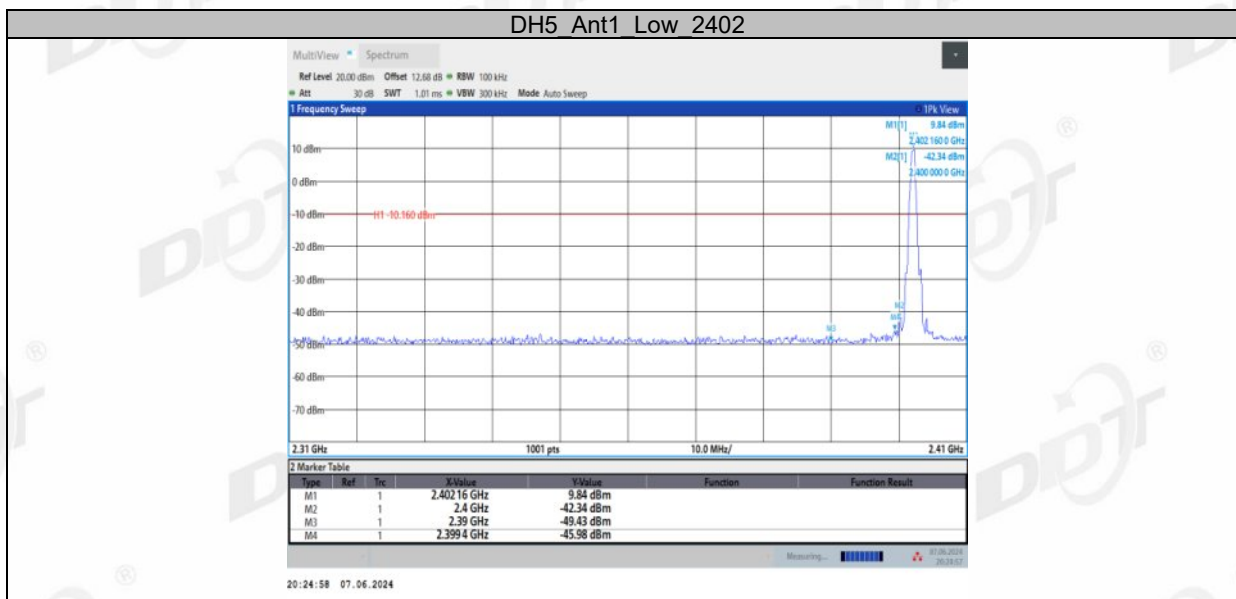

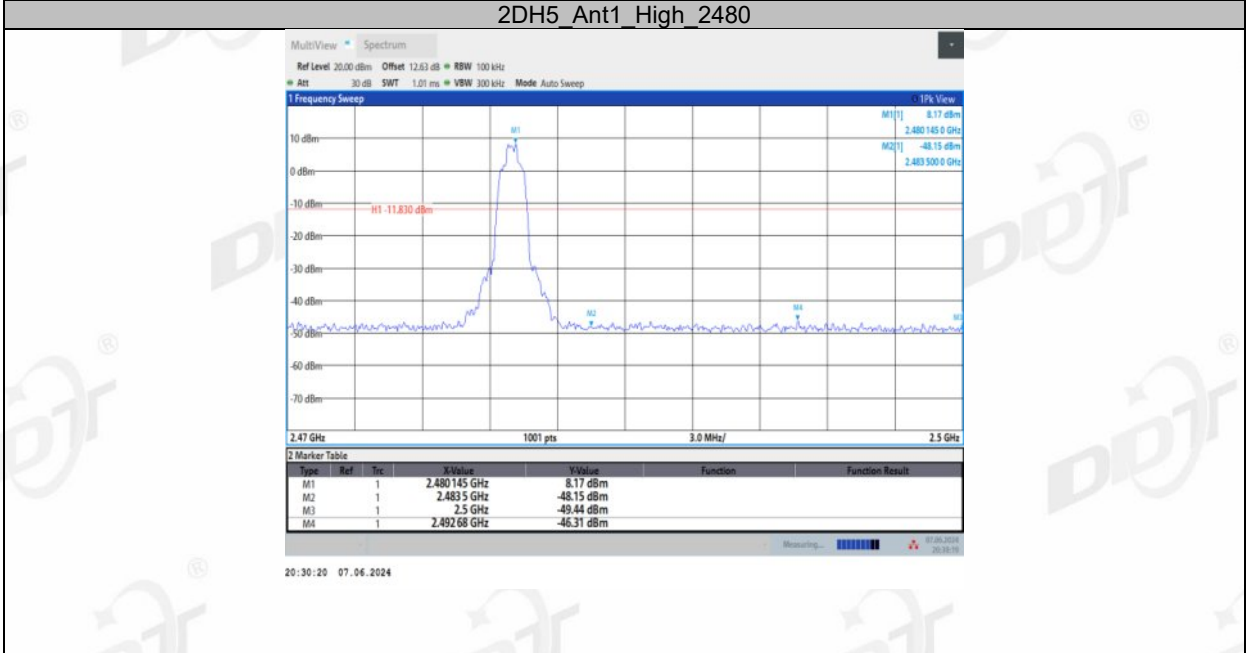
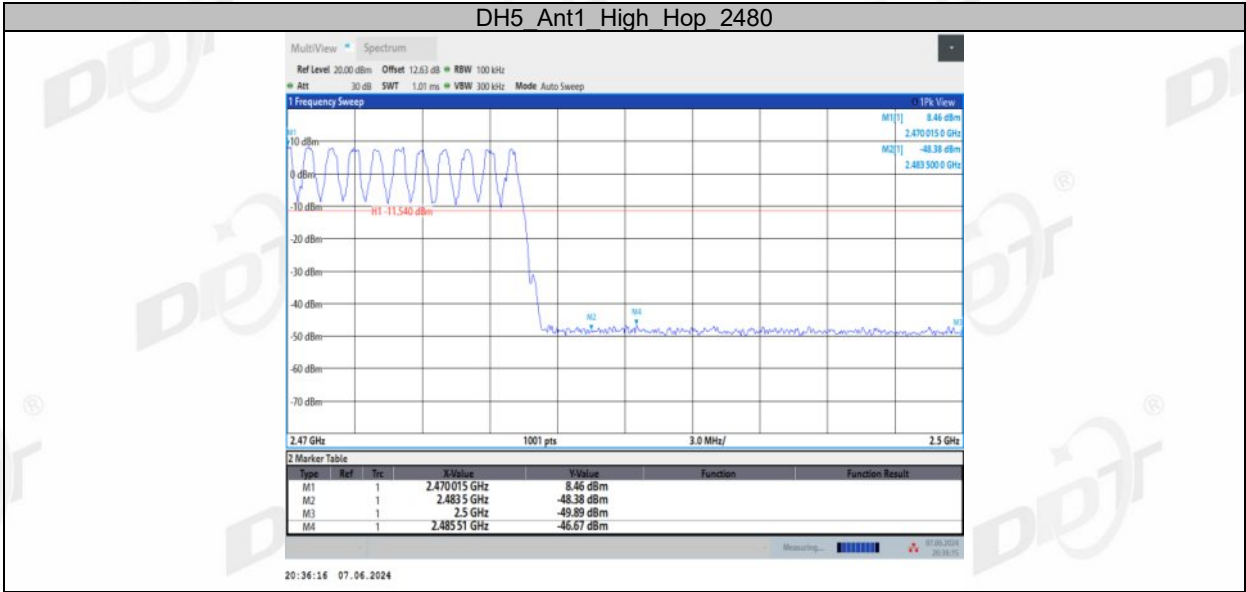

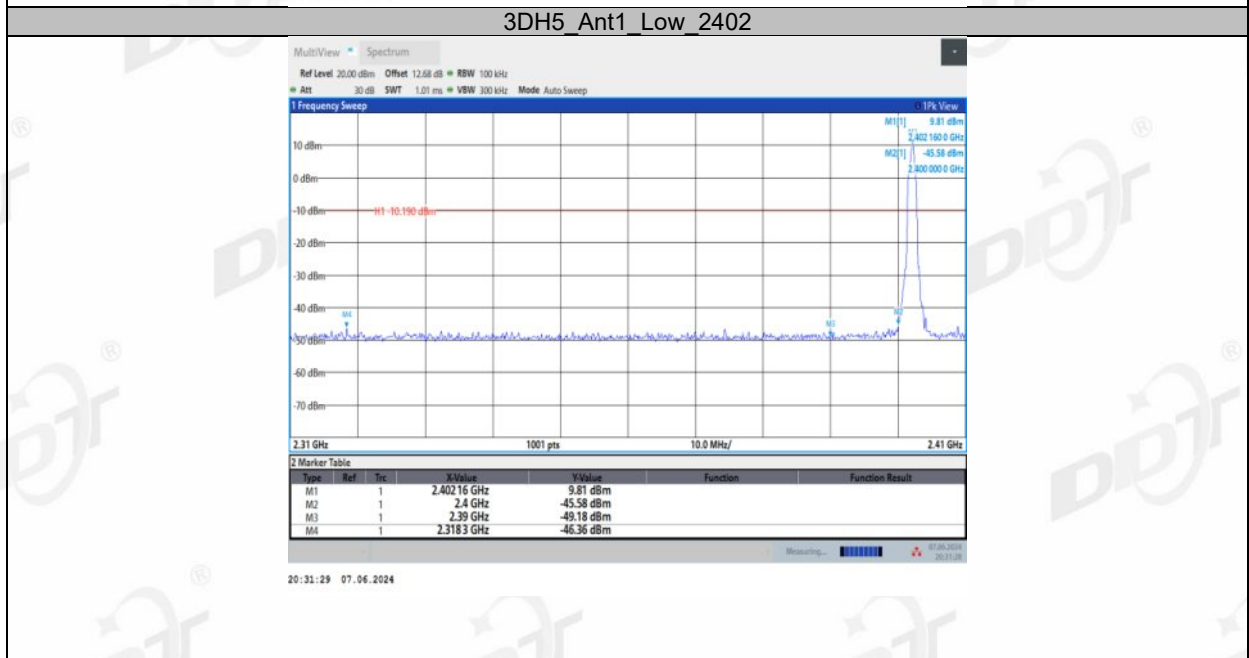
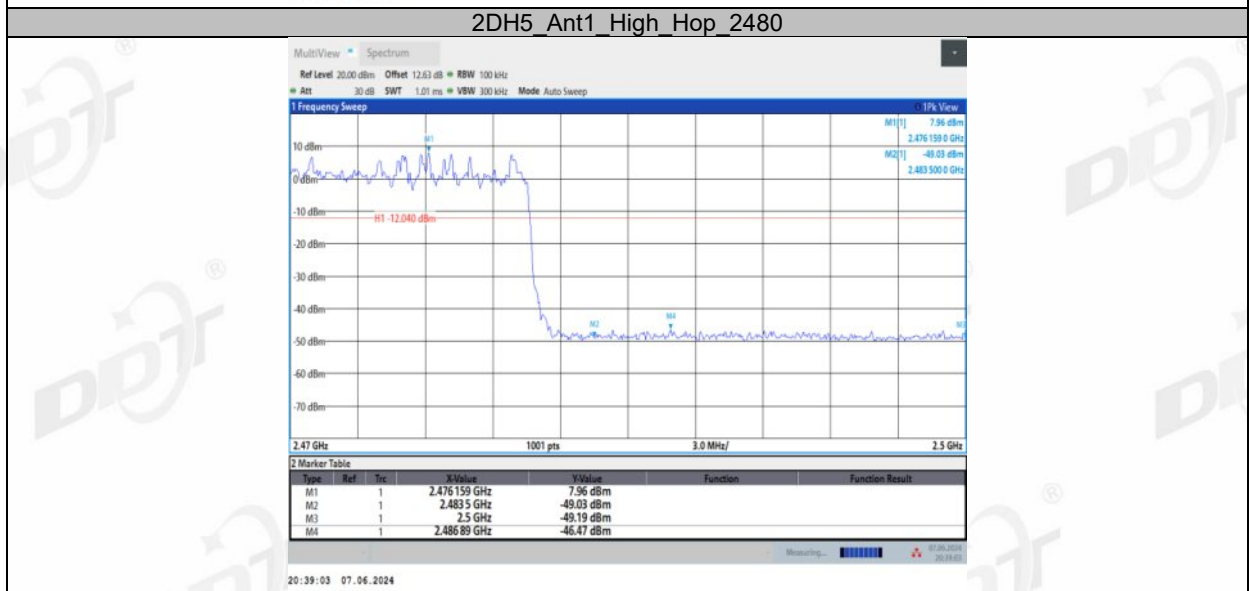
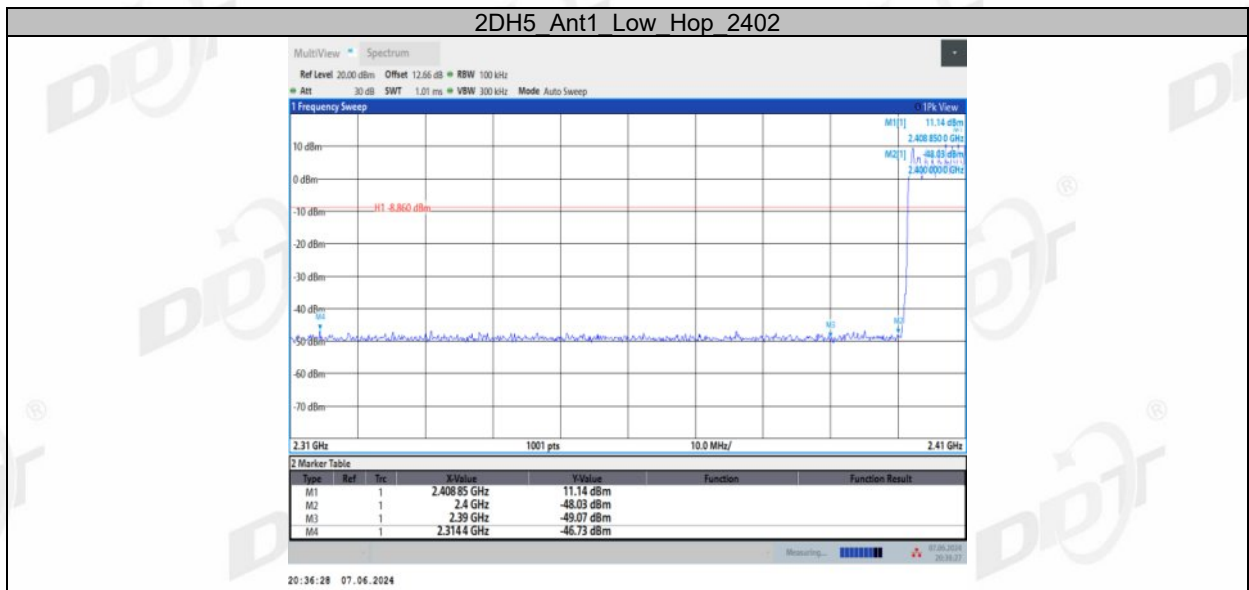

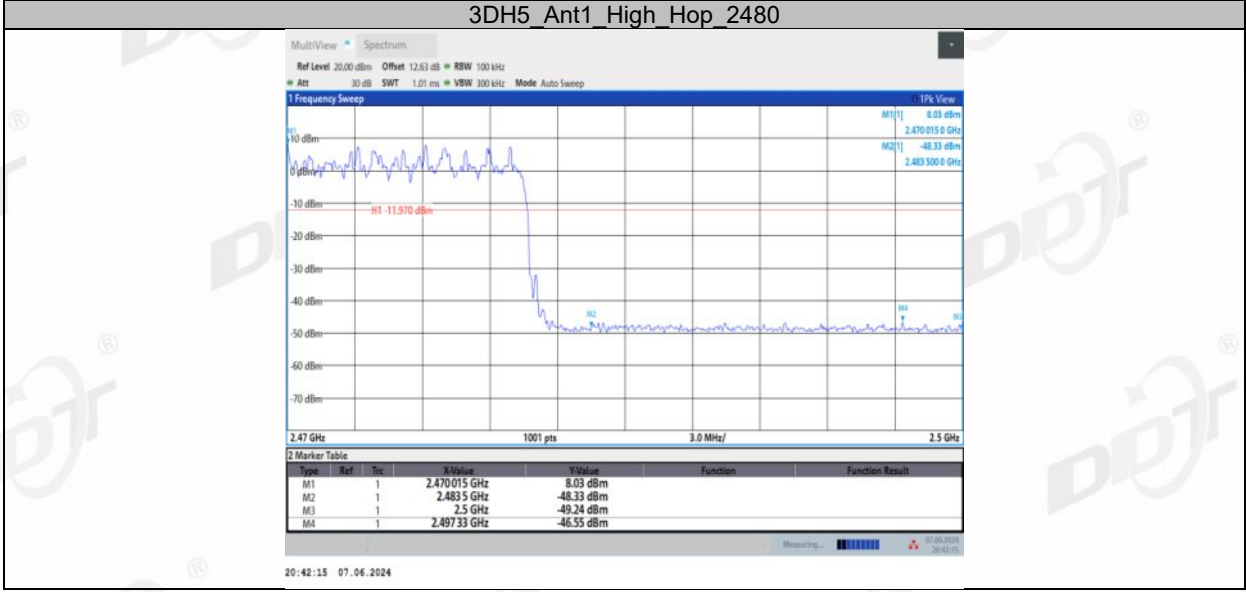
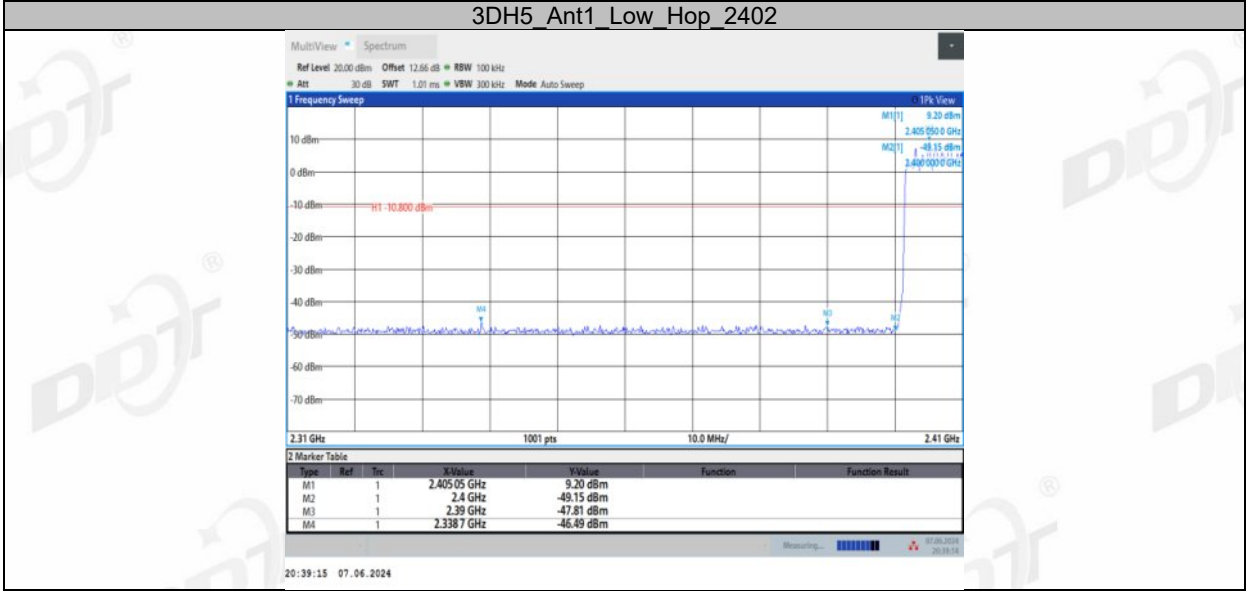
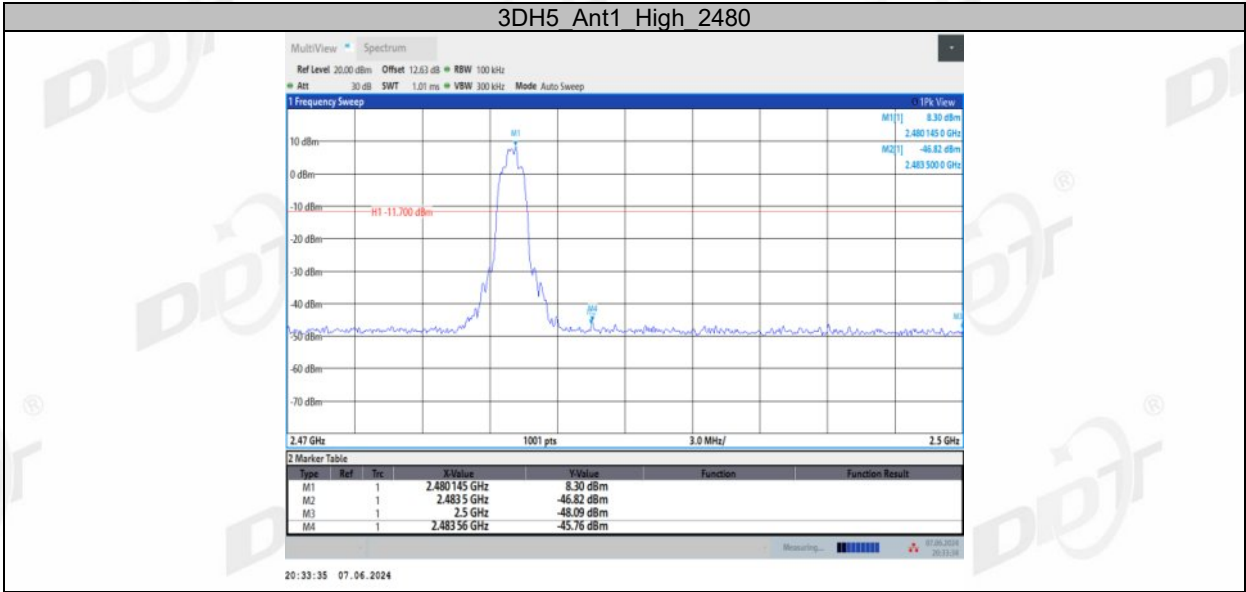

11. RF Conducted Spurious Emissions

11.1. Block diagram of test setup

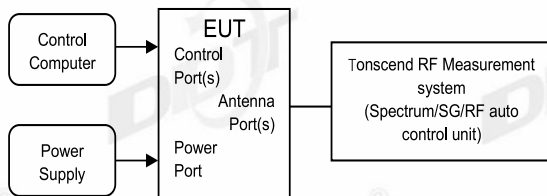

11.2. Limits

In any 100 kHz bandwidth outside the frequency bands in which the spread spectrum intentional radiator is operating, the radio frequency power that is produced by the intentional radiator shall be at least 20 dB below that in the 100 kHz bandwidth within the band that contains the highest level of the desired power.

11.3. Test procedure

- (1) Connect EUT's antenna output to spectrum analyzer by RF cable.
- (2) Establish a reference level by using the following procedure:

Center frequency	Test frequency
RBW:	100 kHz
VBW:	300 kHz
Span	Wide enough to capture the peak level of the in-band emission
Detector Mode:	Peak
Sweep time:	Auto
Trace mode	Max hold
- (3) Allow the trace to stabilize, use the peak marker function to determine the maximum peak power level to establish the reference level.
- (4) Set the spectrum analyzer as follows:

RBW:	100 kHz
VBW:	300 kHz
Span	Encompass frequency range to be measured
Number of measurement points	$\geq \text{Span}/\text{RBW}$
Detector Mode:	Peak
Sweep time:	Auto
Trace mode	Max hold
- (5) Allow the trace to stabilize, use the peak marker function to determine the maximum amplitude of all unwanted emissions outside of the authorized frequency band

11.4. Test result

Test Engineer:	Zora Zhang	Test Site:	RF Measurement System 4#
Ambient Condition:	25.3°C, 55.6%RH	Test Date:	2024.06.07-2024.06.18
Test Power Supply:	AC 230V/50HZ	Sample Number:	S24052807-001

Mode	Frequency (MHz)	Verdict
DH5	Hopping off 2402	Pass
	Hopping off 2441	Pass
	Hopping off 2480	Pass
2DH5	Hopping off 2402	Pass
	Hopping off 2441	Pass
	Hopping off 2480	Pass
3DH5	Hopping off 2402	Pass
	Hopping off 2441	Pass
	Hopping off 2480	Pass

11.5. Test graphs

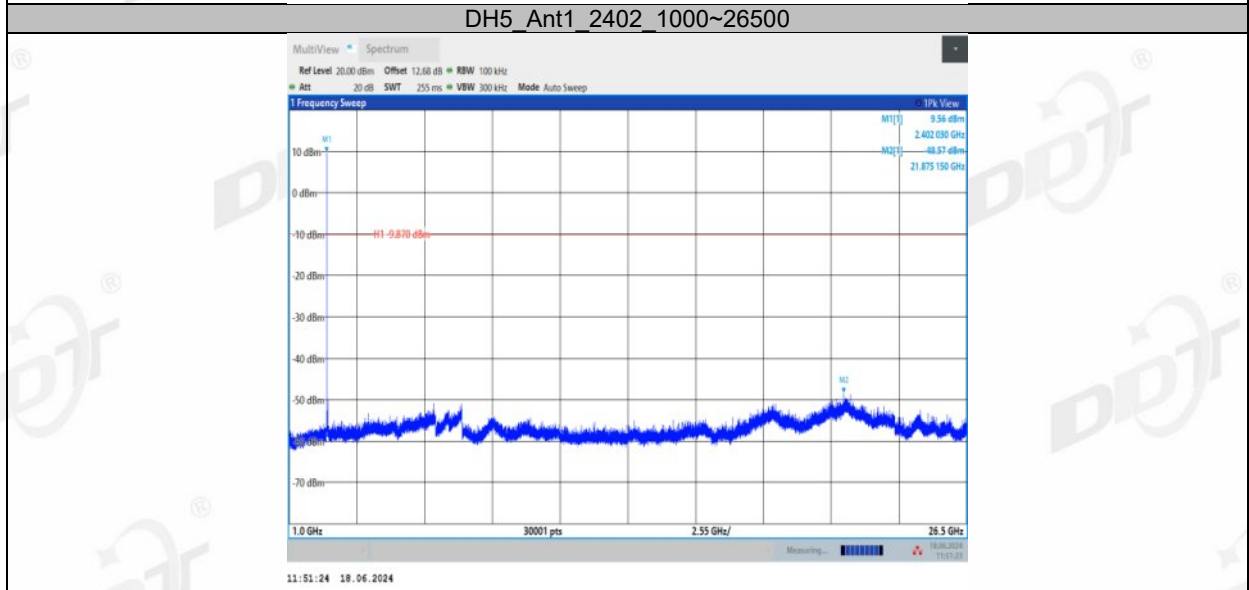
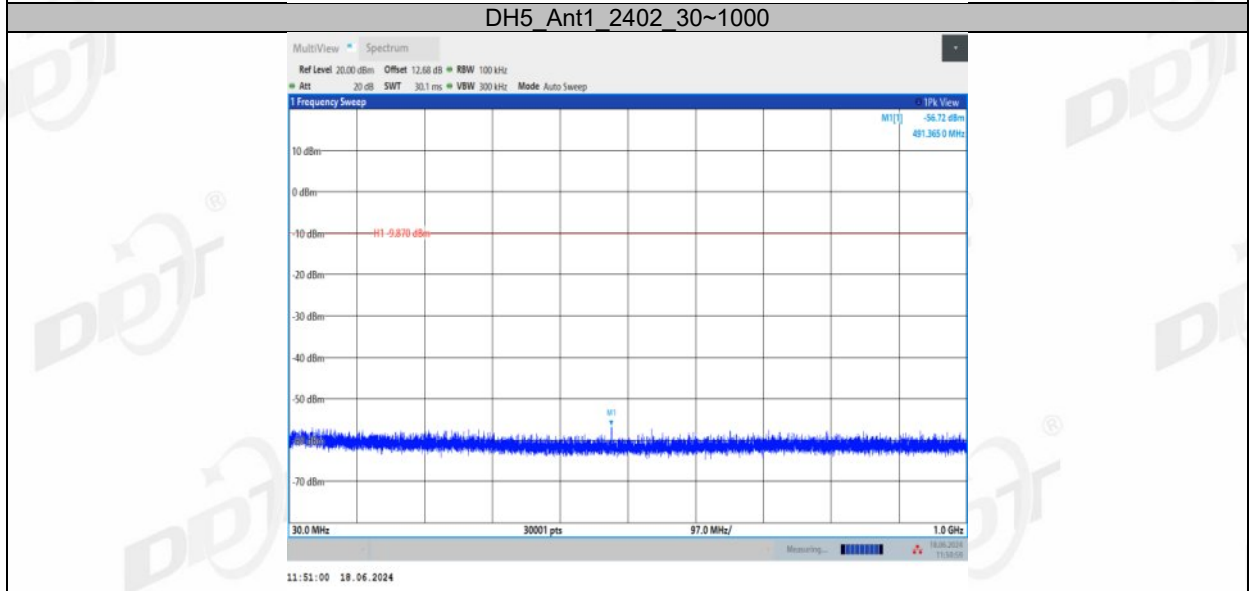
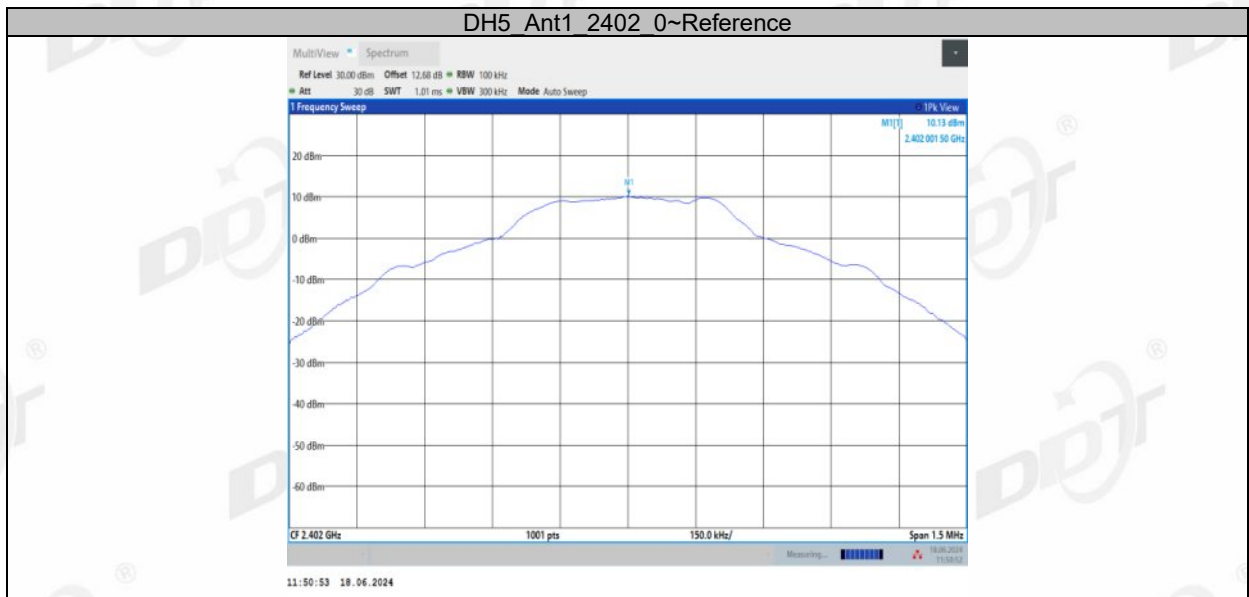

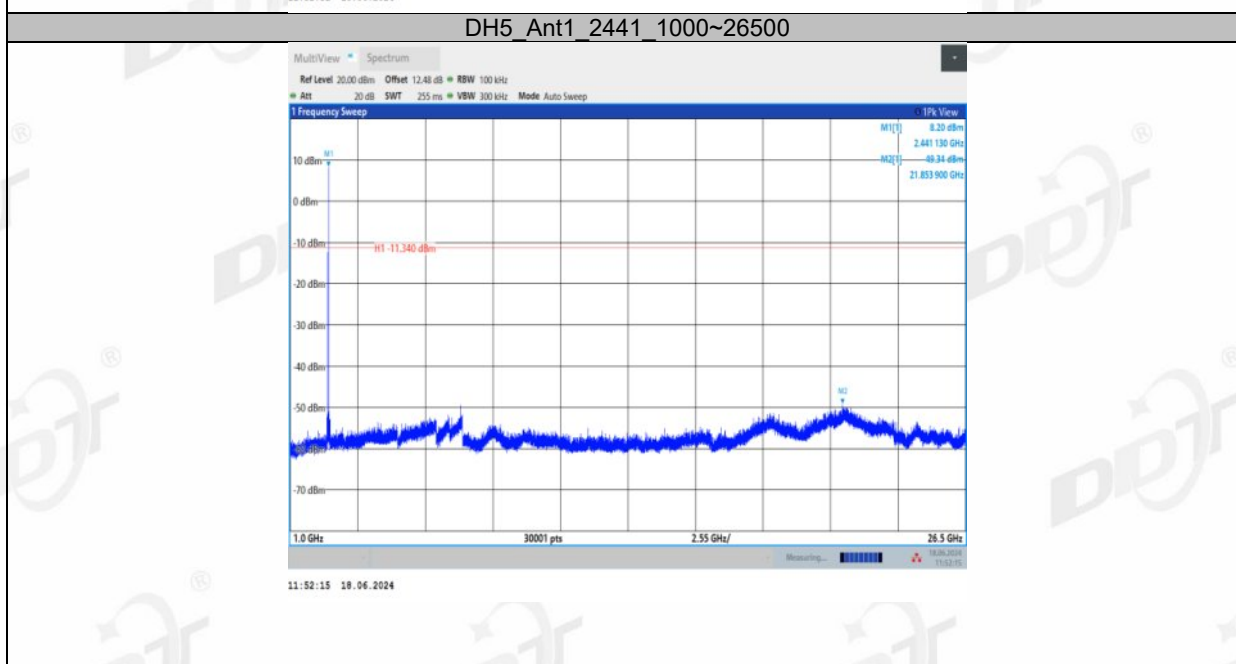
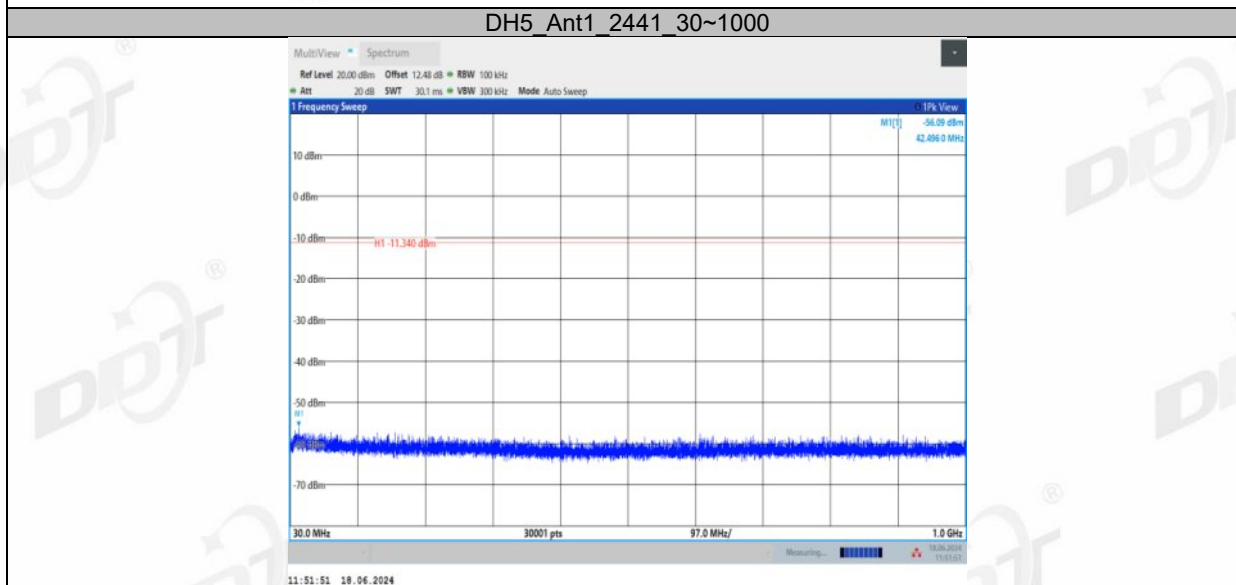
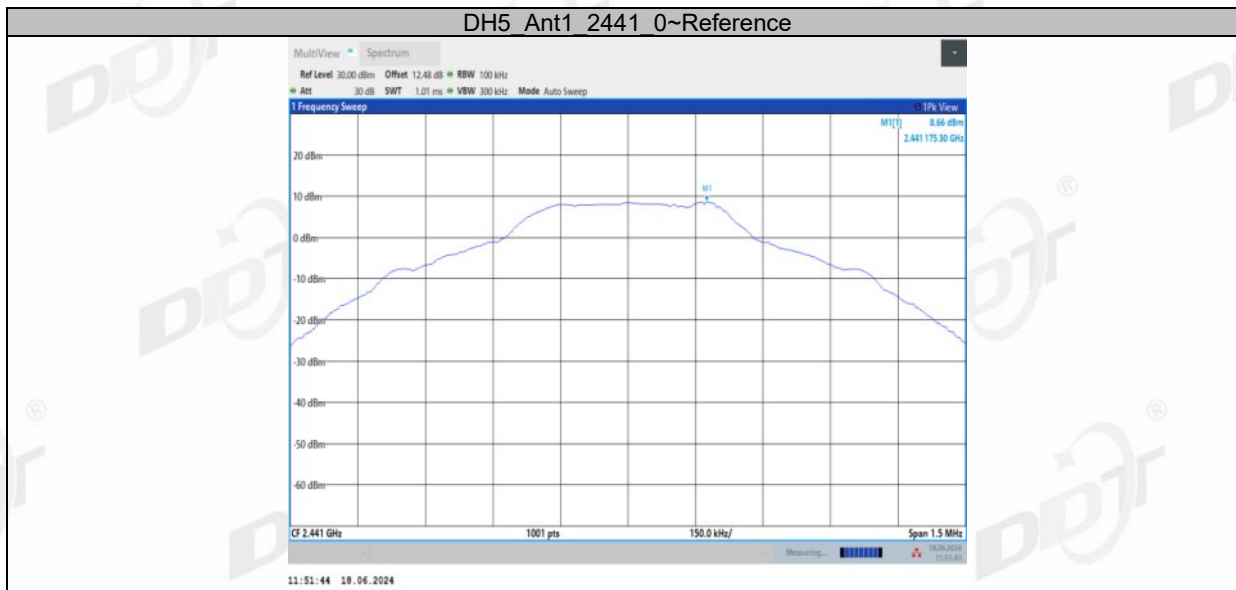

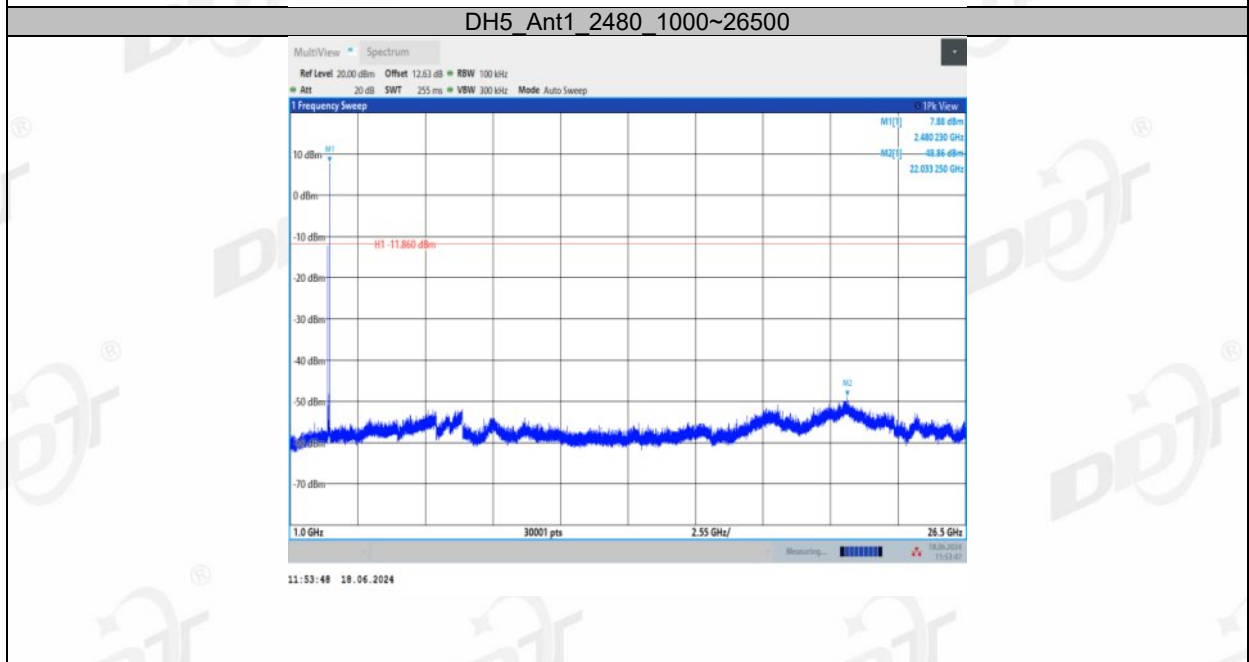
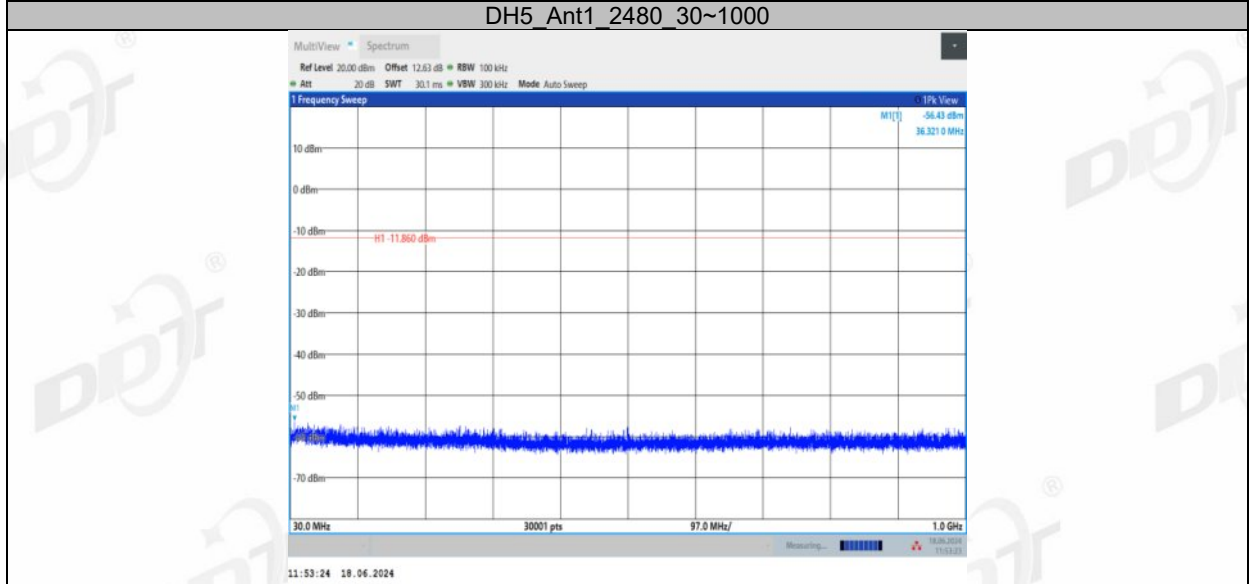
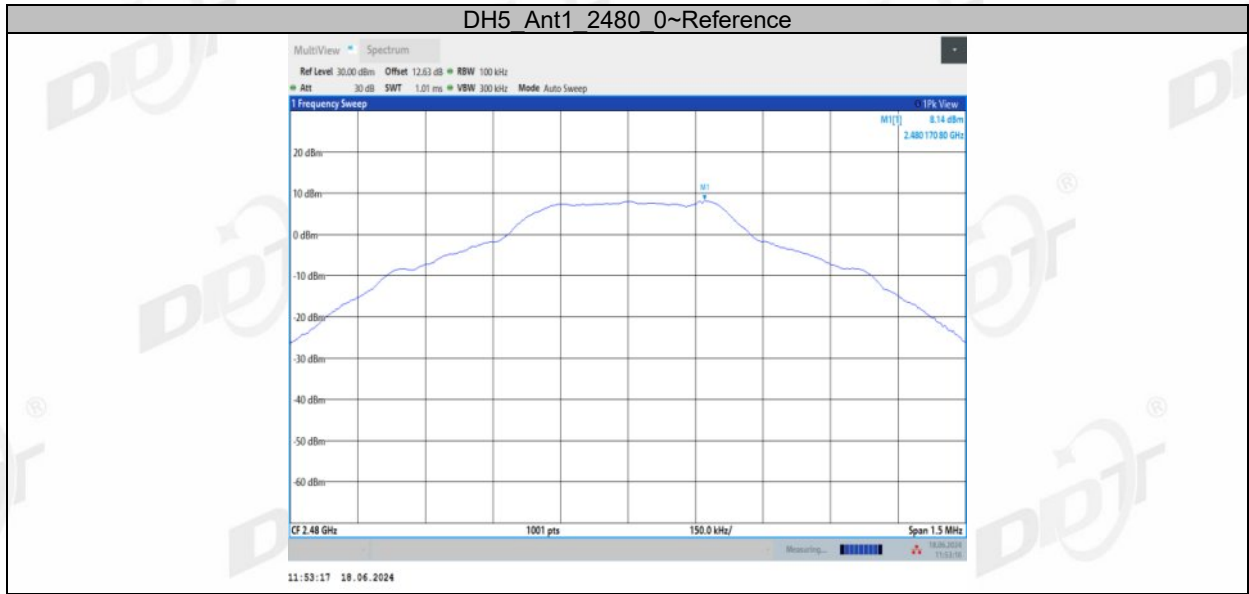

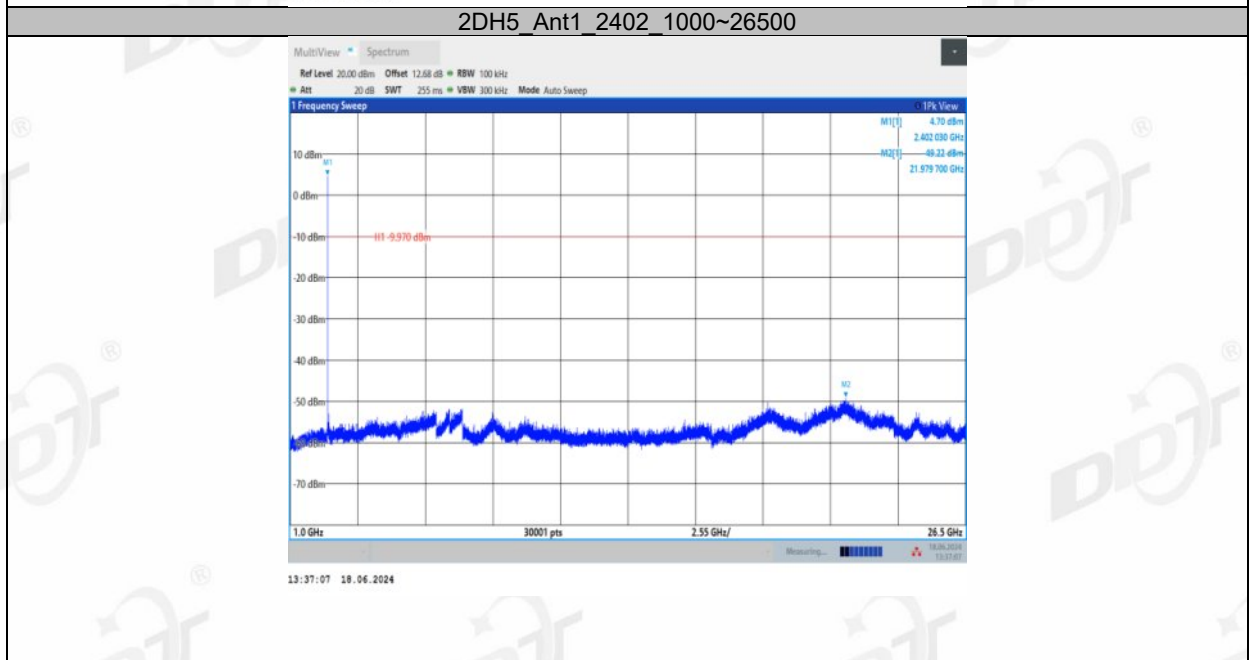
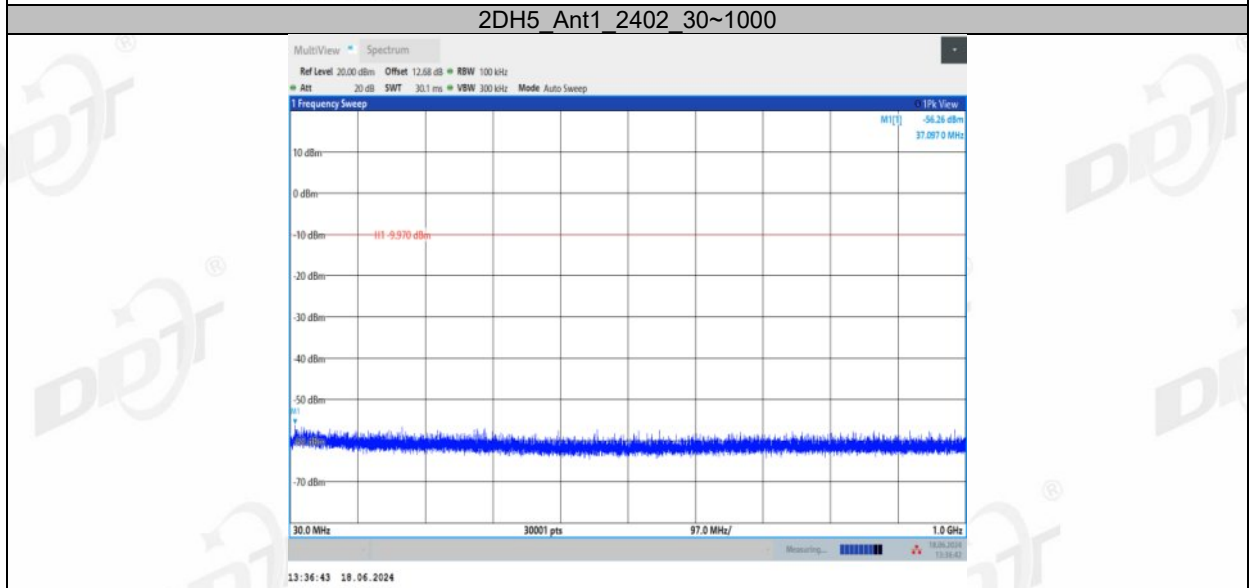
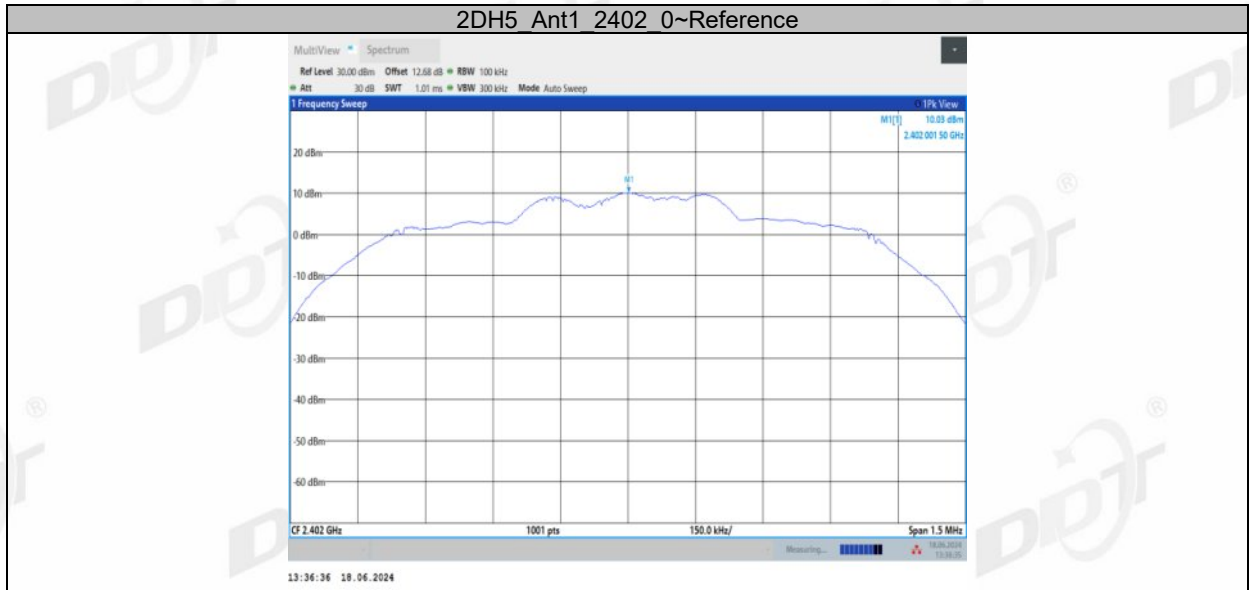

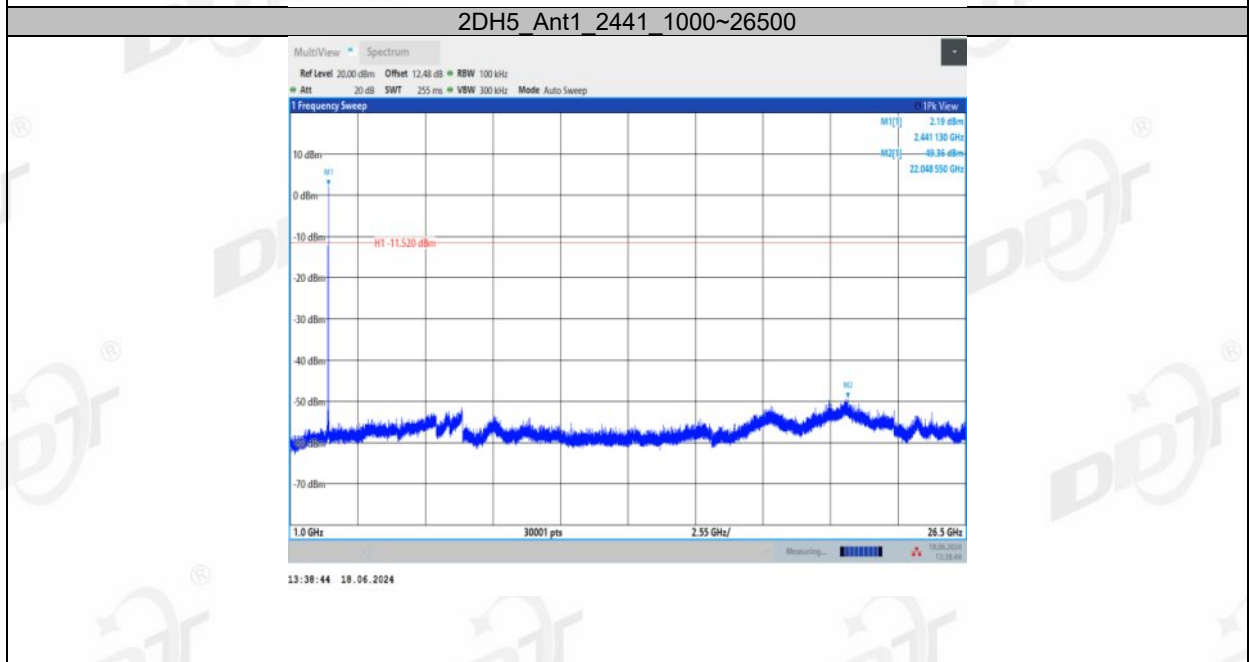
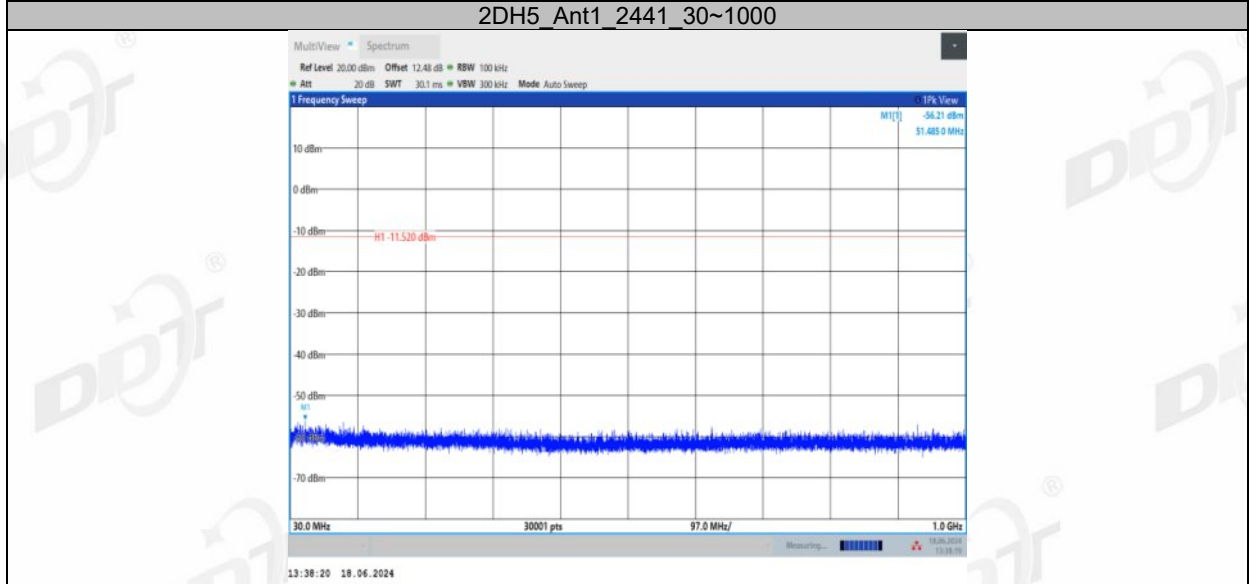
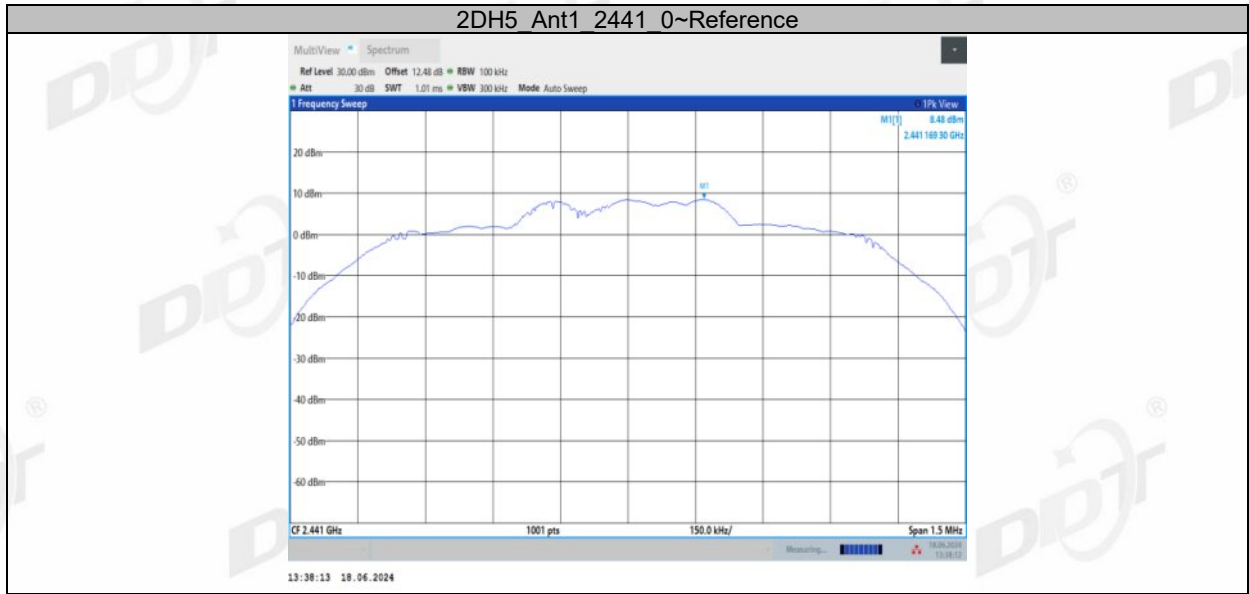

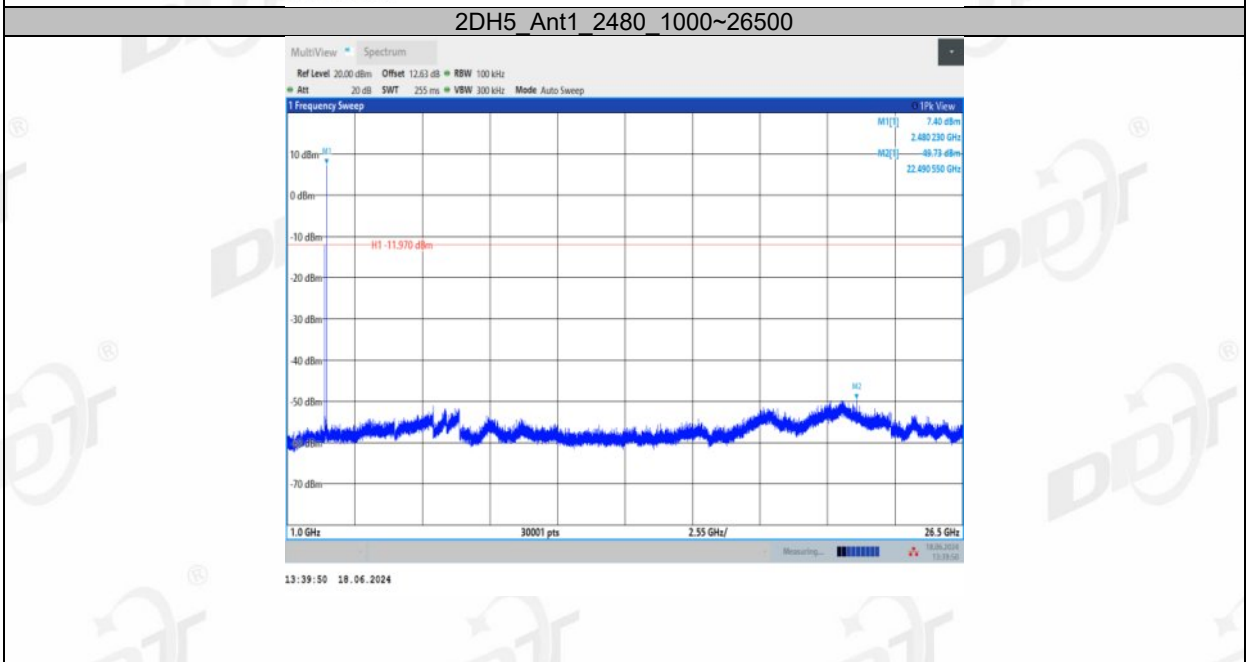
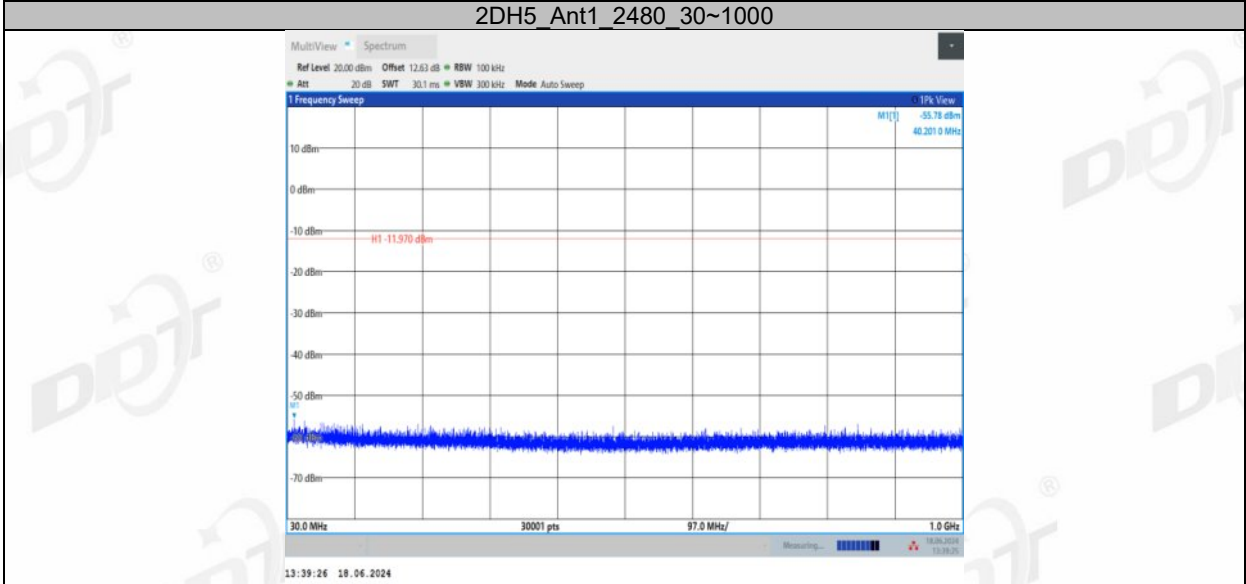
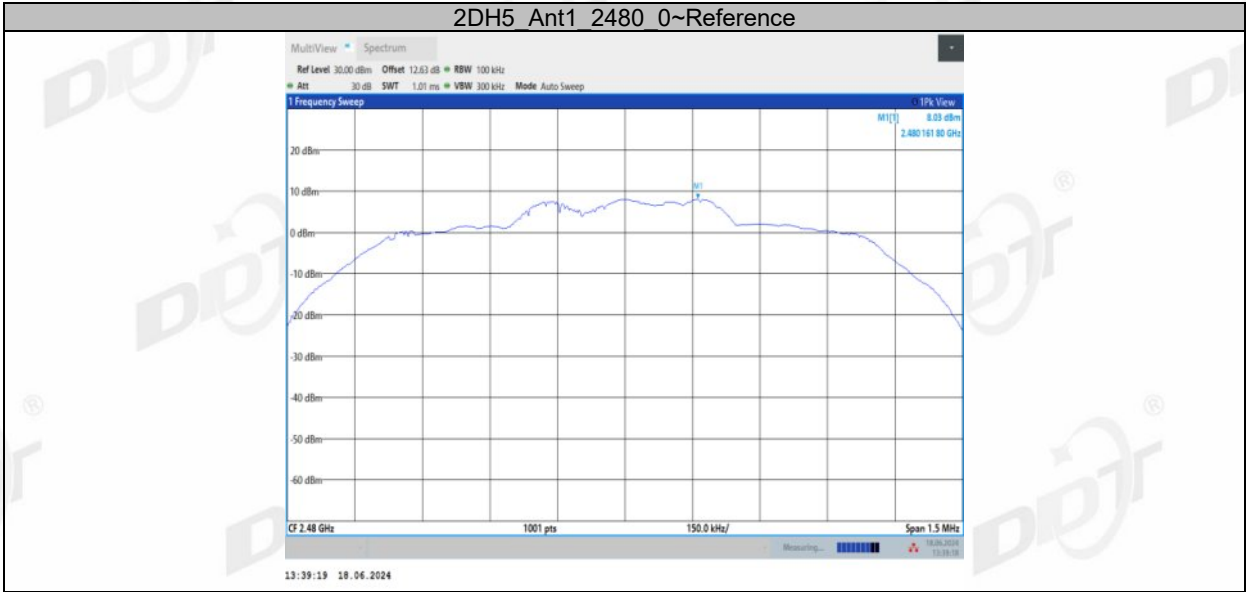

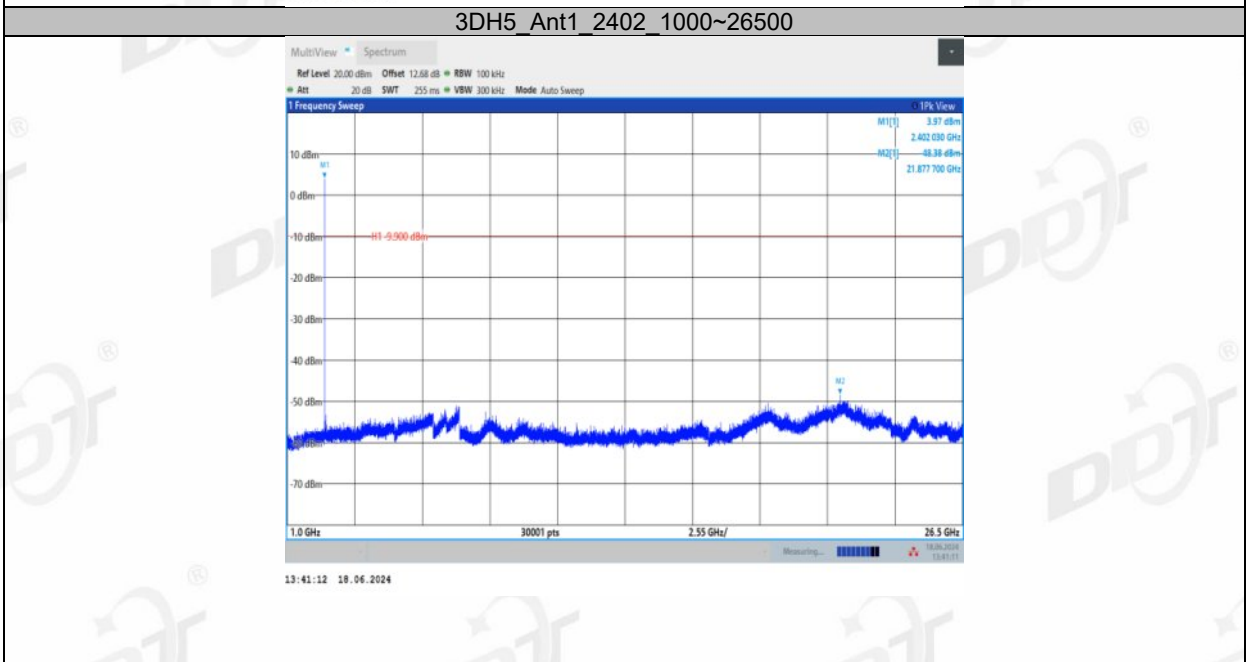
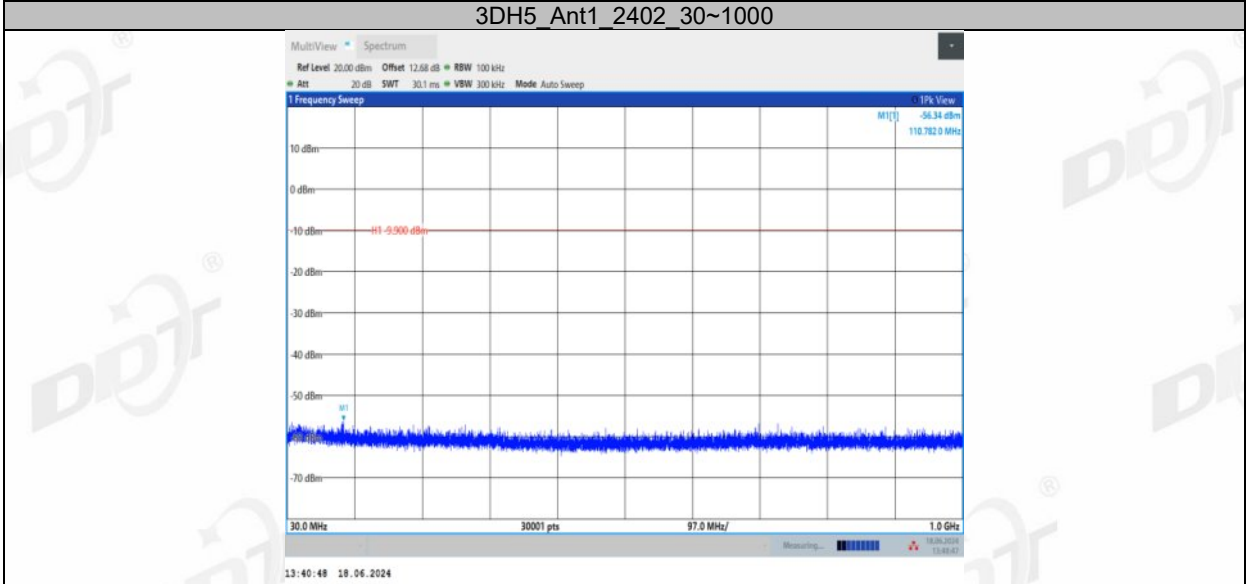
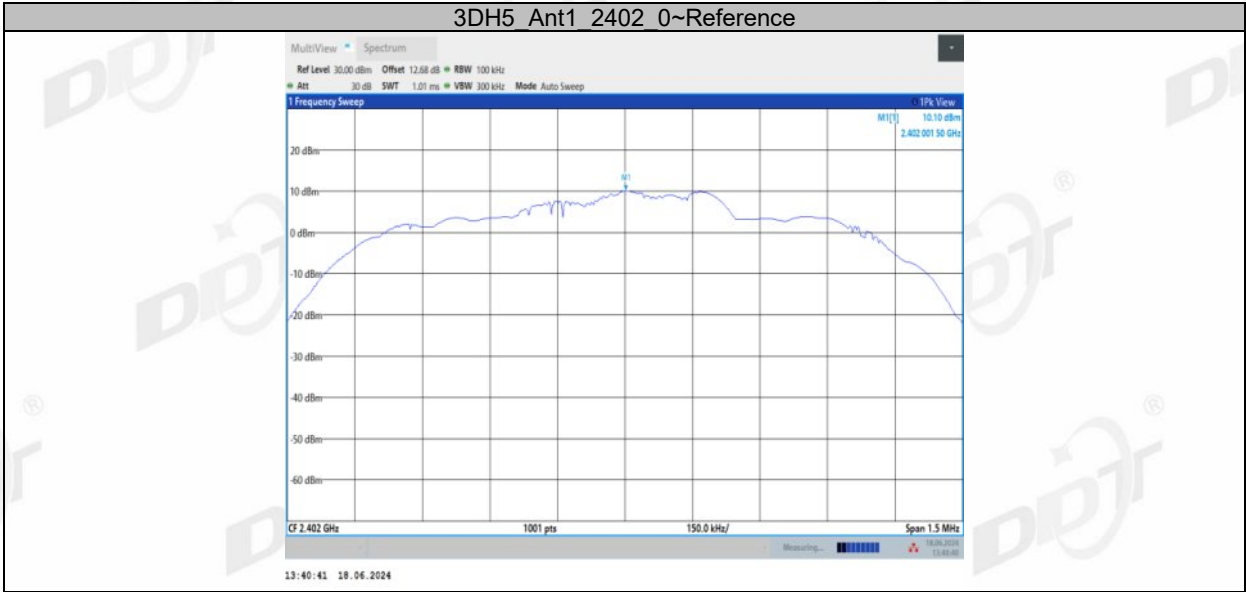

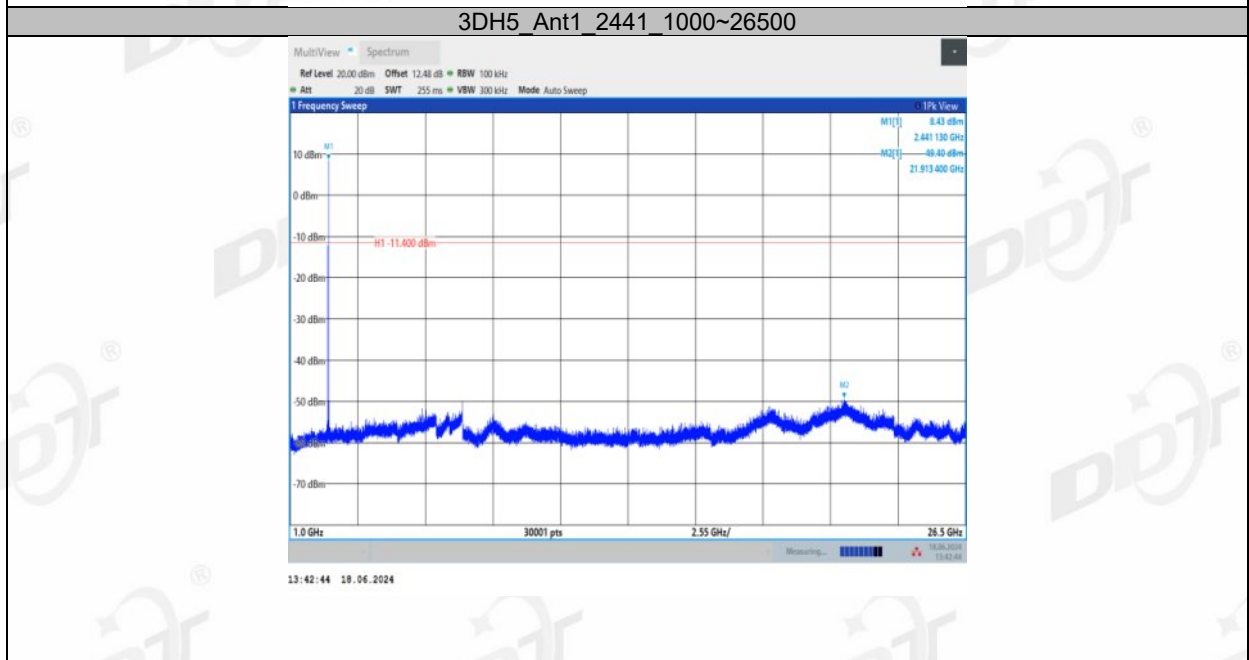
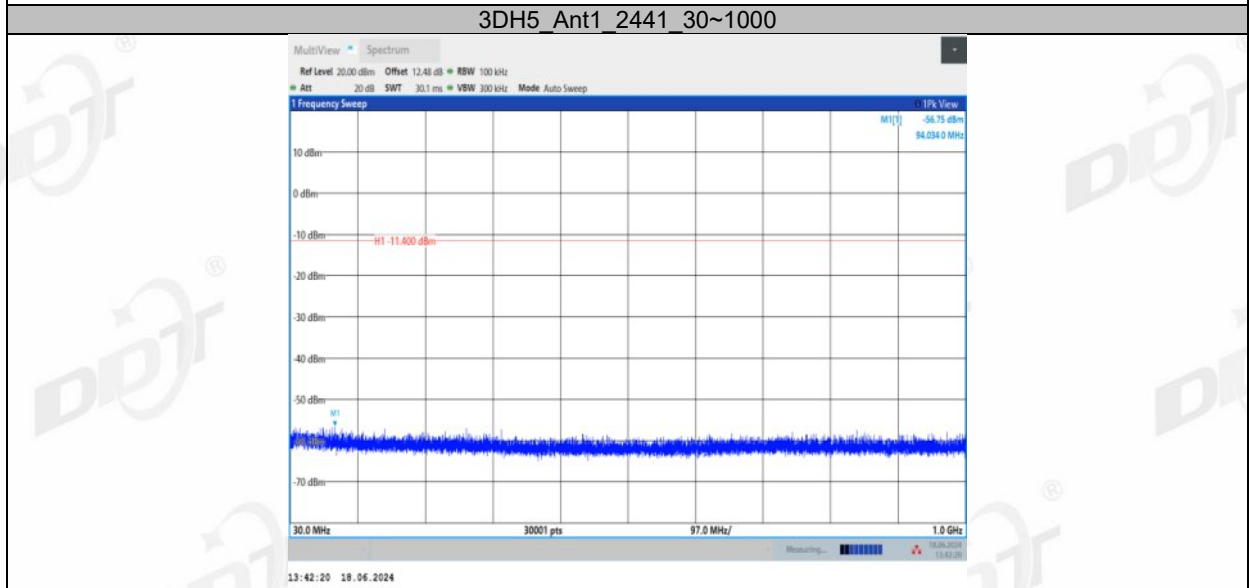
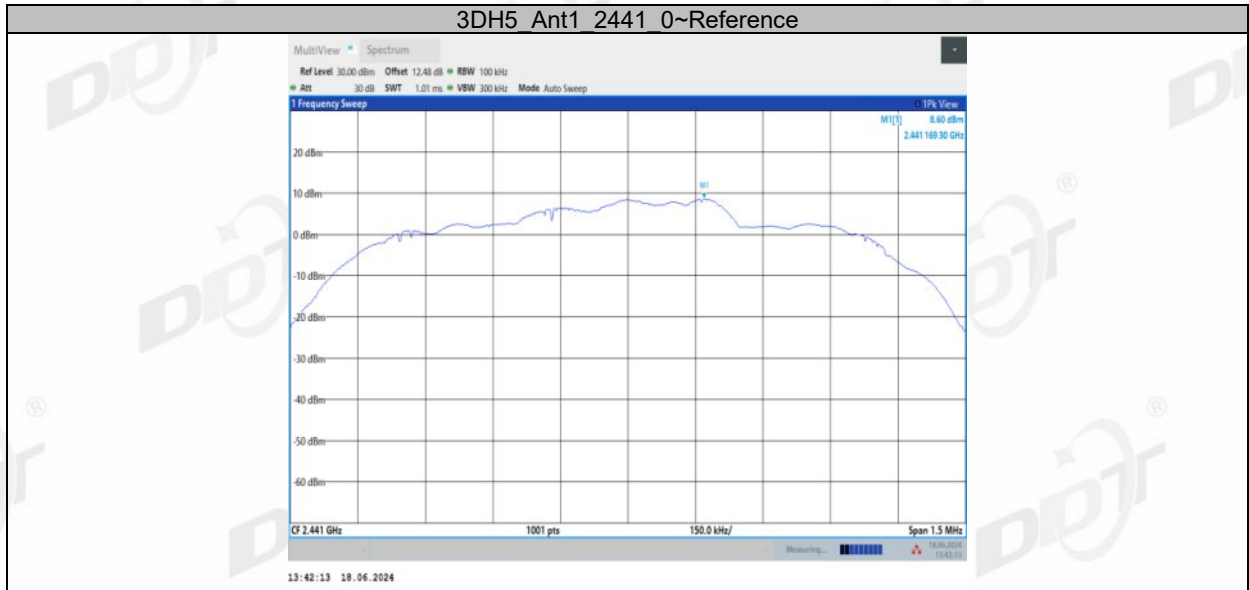

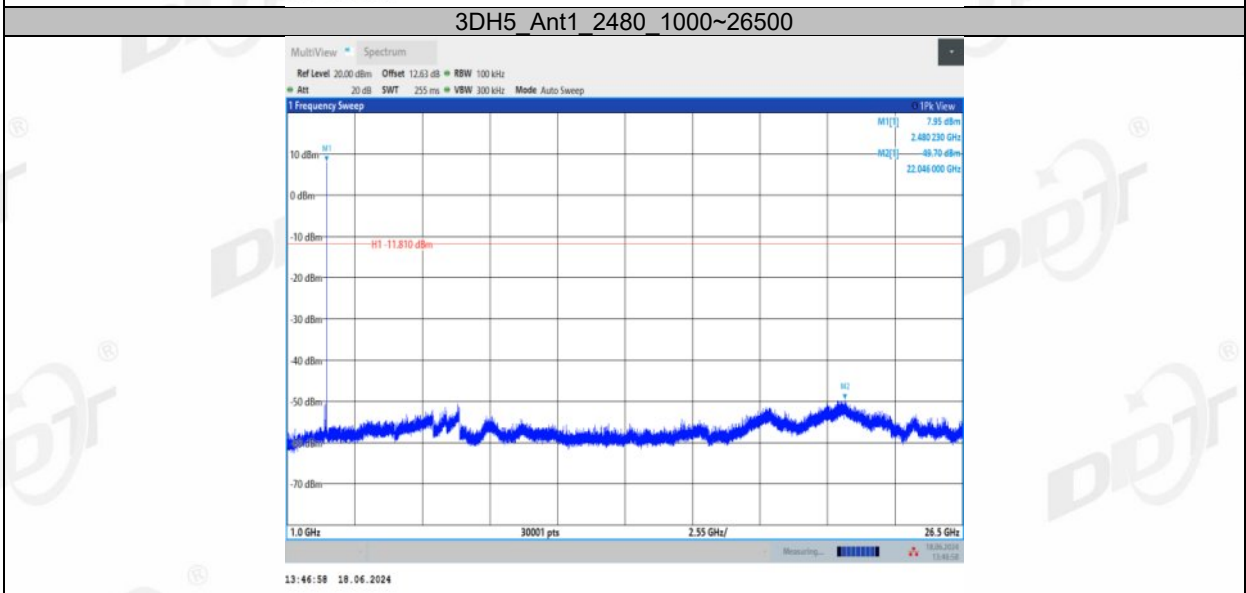
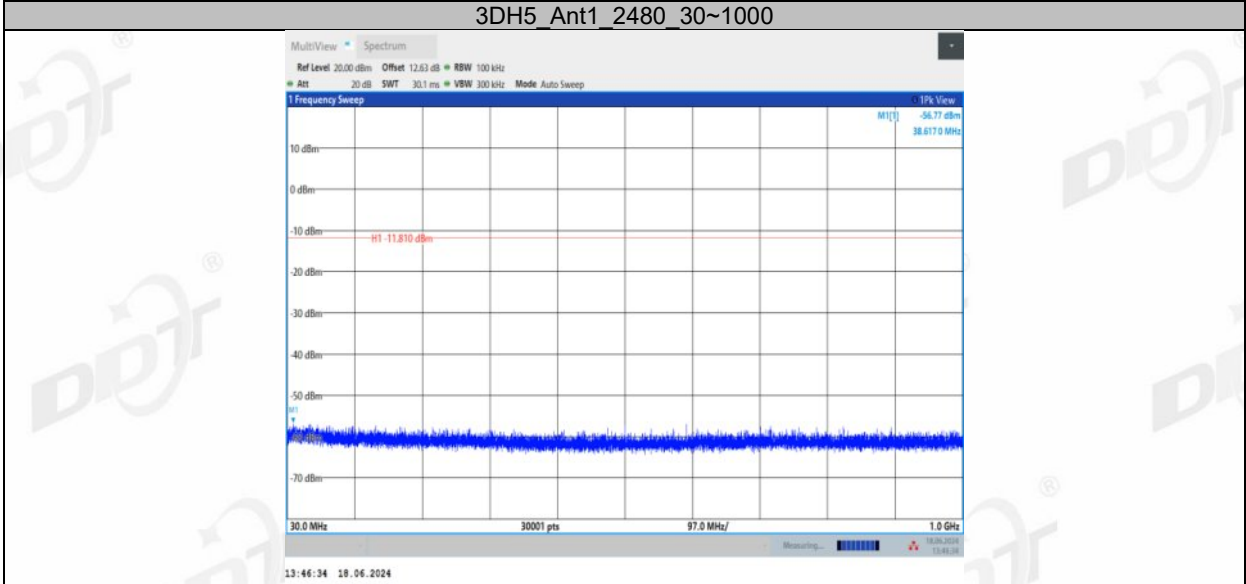
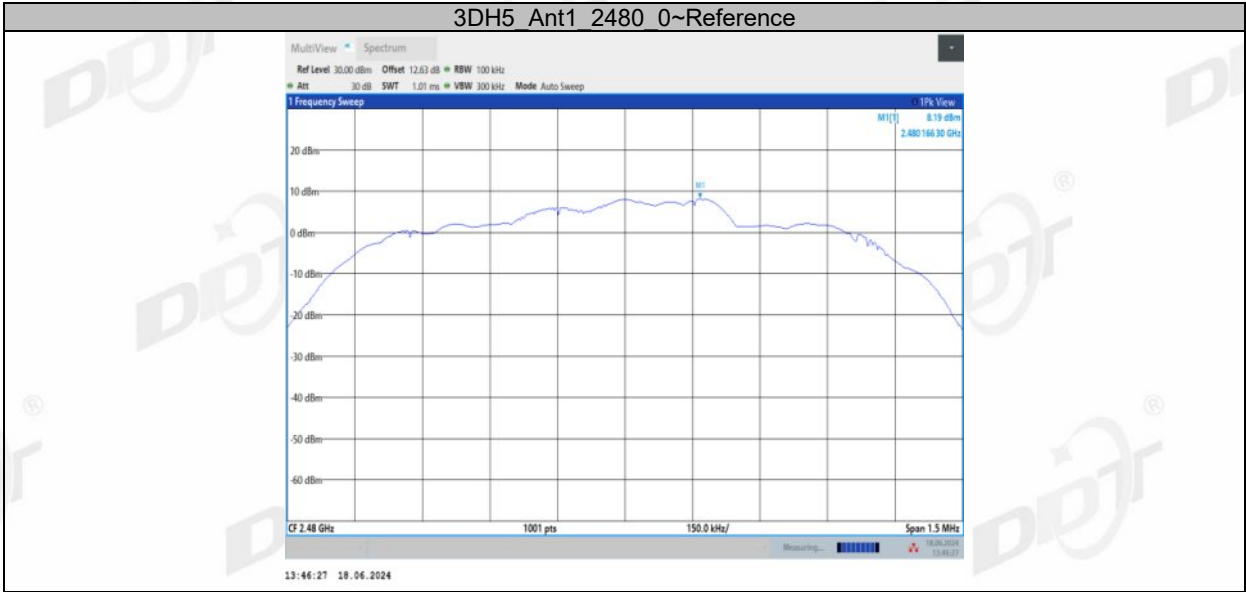

12. Duty cycle

12.1. Block diagram of test setup

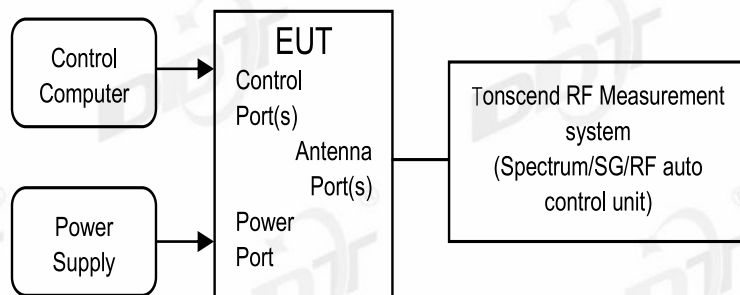

12.2. Limit

Just for Report.

12.3. Test procedure

- (1) Connected the EUT's antenna port to the Spectrum Analyzer by suitable attenuator, The cable loss and attenuator loss have been put into spectrum analyzer as amplitude offset. set the Spectrum Analyzer as below:

Centre Frequency: The centre frequency of the middle hopping channel.

Resolution BW: 10 MHz.

Video BW: 10 MHz.

Span: Zero span.

Detector: Peak.

Trace Mode: Clear Write.

Sweep: Video Trigger

- (2) When the trace is complete, measure the sending time of 1 burst and the duty cycle of 1 burst cycle.
- (3) Calculate dwell time follow below formula:
Duty cycle= Pulse's on time / Burst cycle

12.4. Test result

Test Engineer:	Zora Zhang	Test Site:	RF Measurement System 4#
Ambient Condition:	25.3℃, 55.6%RH	Test Date:	2024.06.07-2024.06.18
Test Power Supply:	AC 230V/50HZ	Sample Number:	S24052807-001

Test Mode	Antenna	Frequency [MHz]	ON Time [ms]	Period [ms]	Duty Cycle [%]	Duty Cycle Factor [dB]
DH5	Ant1	2402	2.90	3.75	77.33	1.12
		2441	2.90	3.75	77.33	1.12
		2480	2.90	3.75	77.33	1.12
2DH5	Ant1	2402	2.91	3.75	77.60	1.10
		2441	2.91	3.76	77.39	1.11
		2480	2.91	3.76	77.39	1.11
3DH5	Ant1	2402	2.91	3.75	77.60	1.10
		2441	2.91	3.75	77.60	1.10
		2480	2.92	3.76	77.66	1.10

12.5. Test graphs

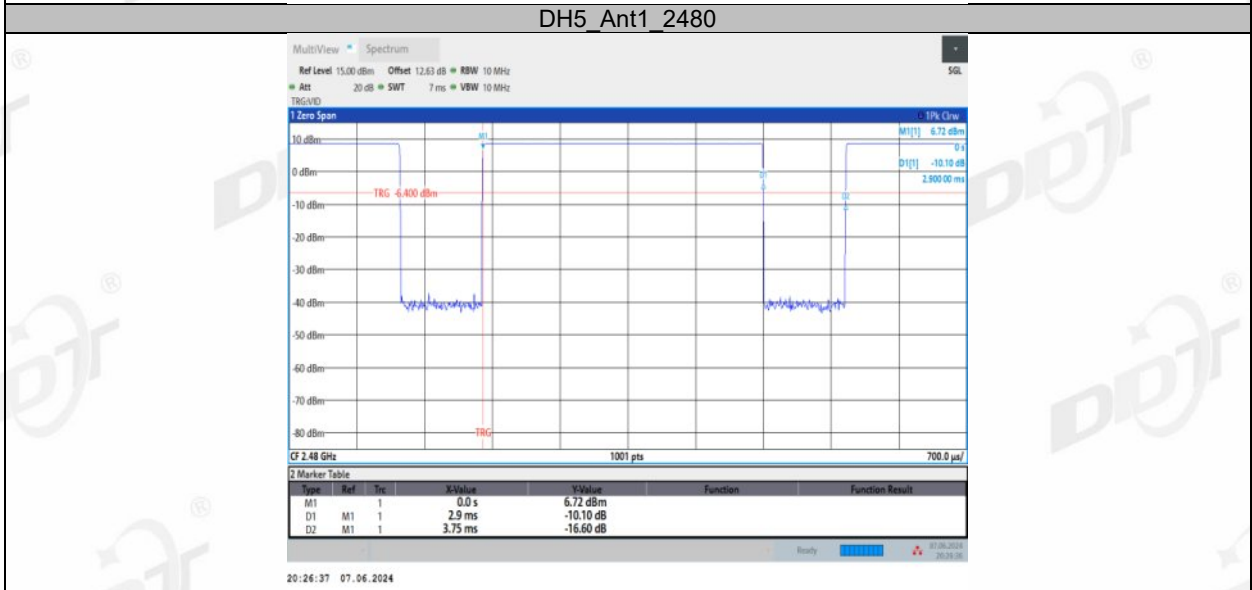
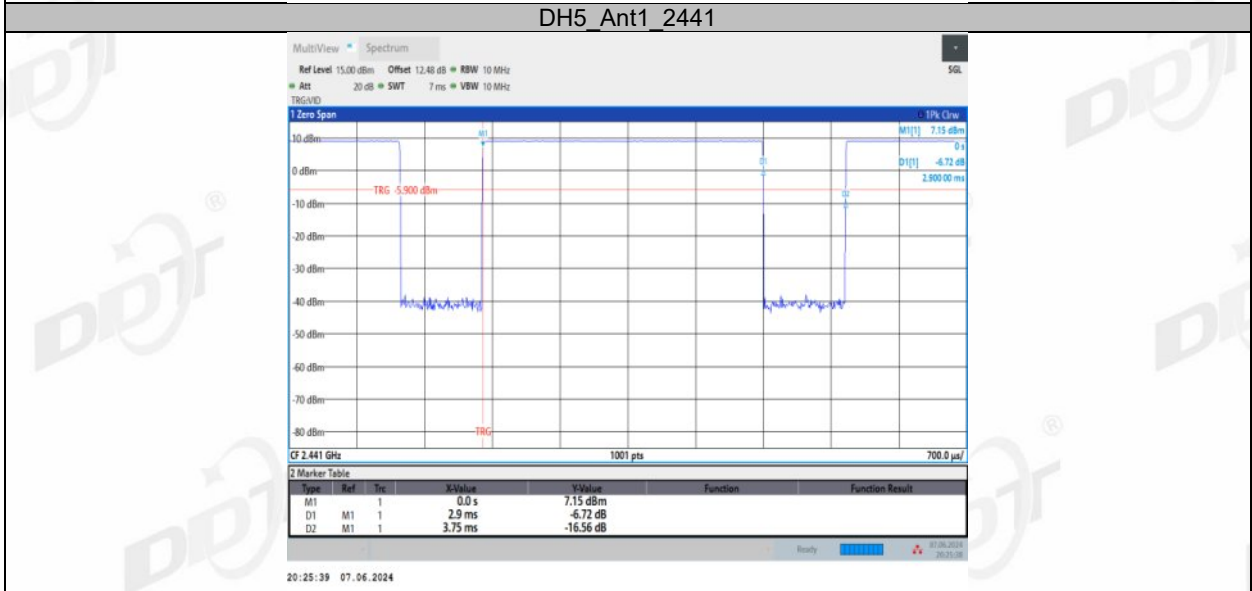
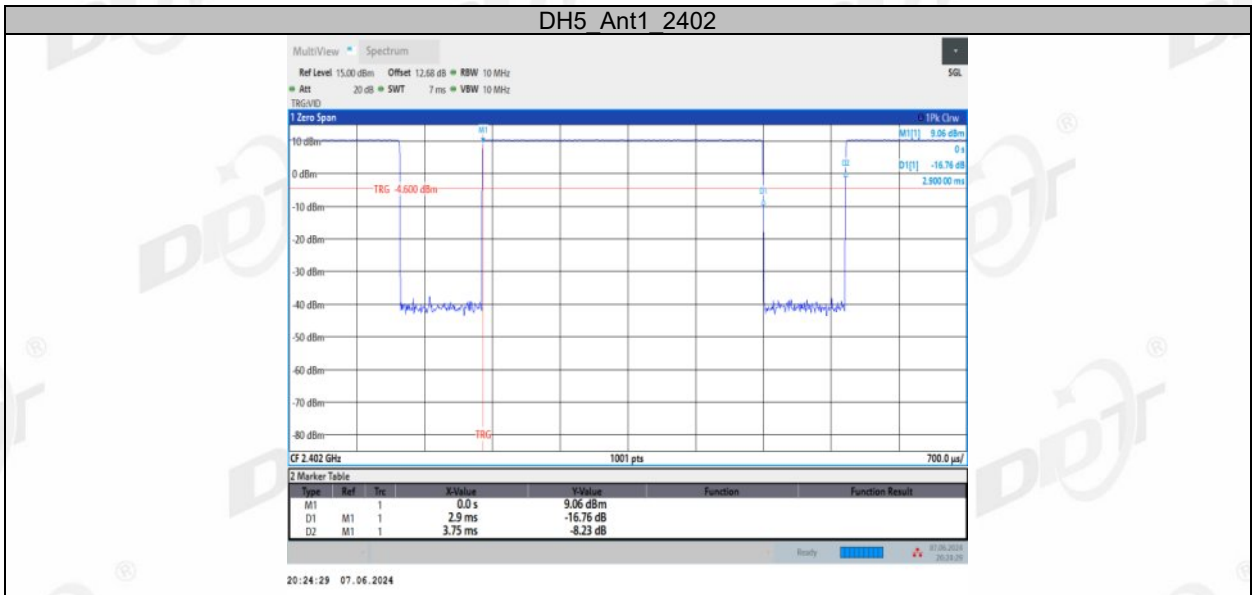

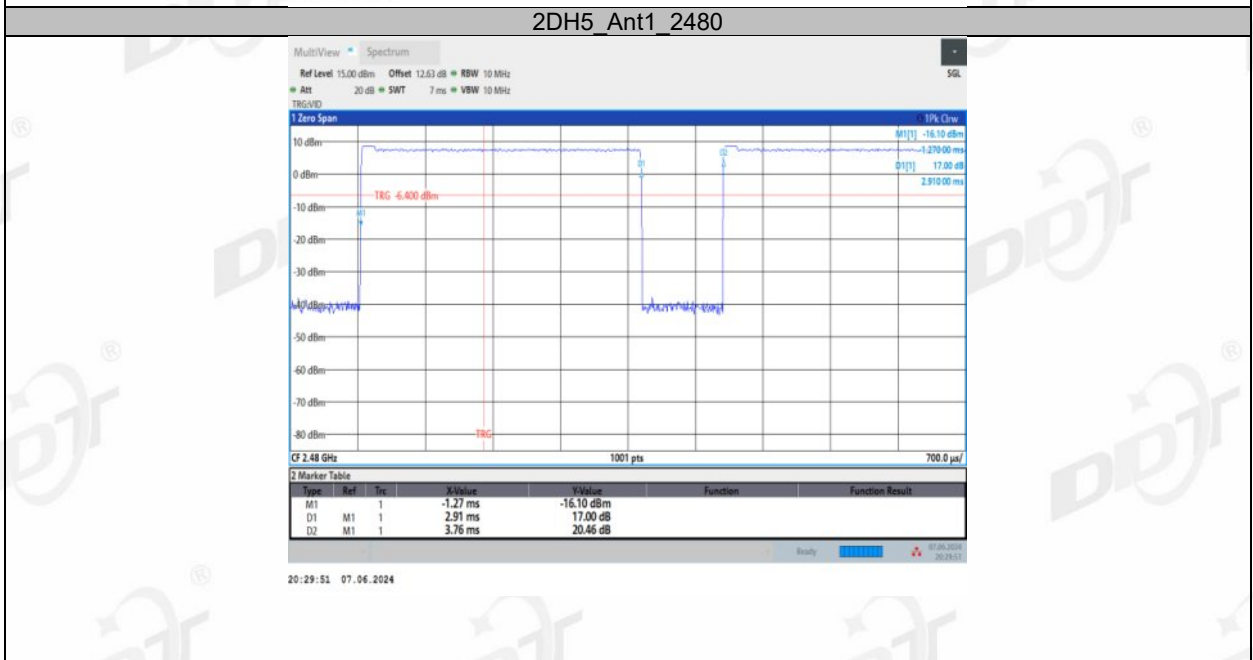
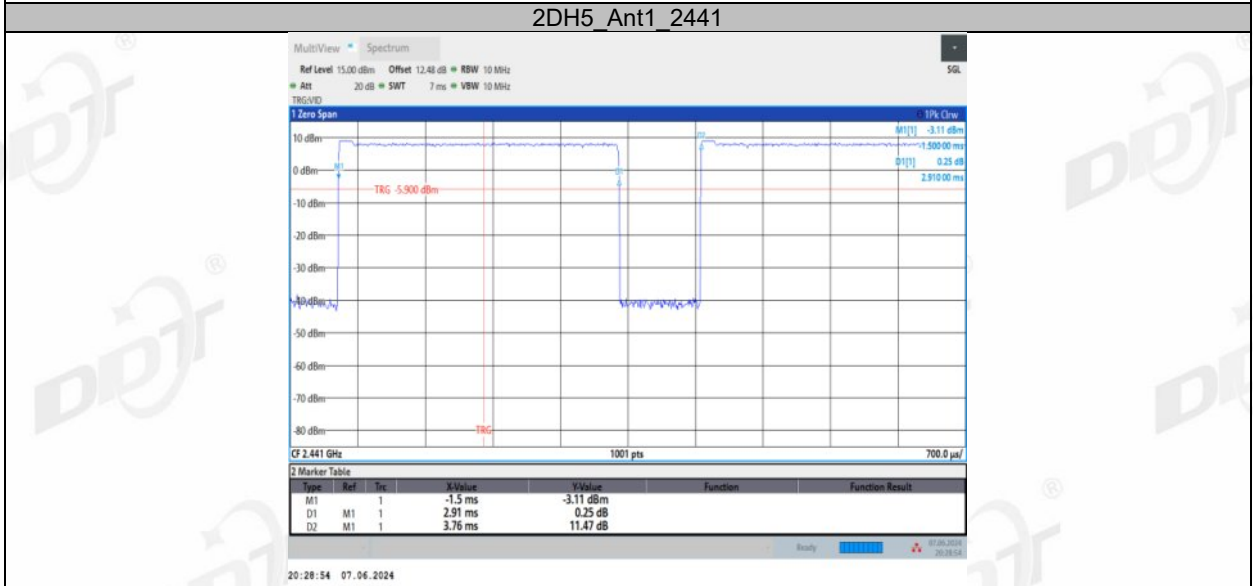
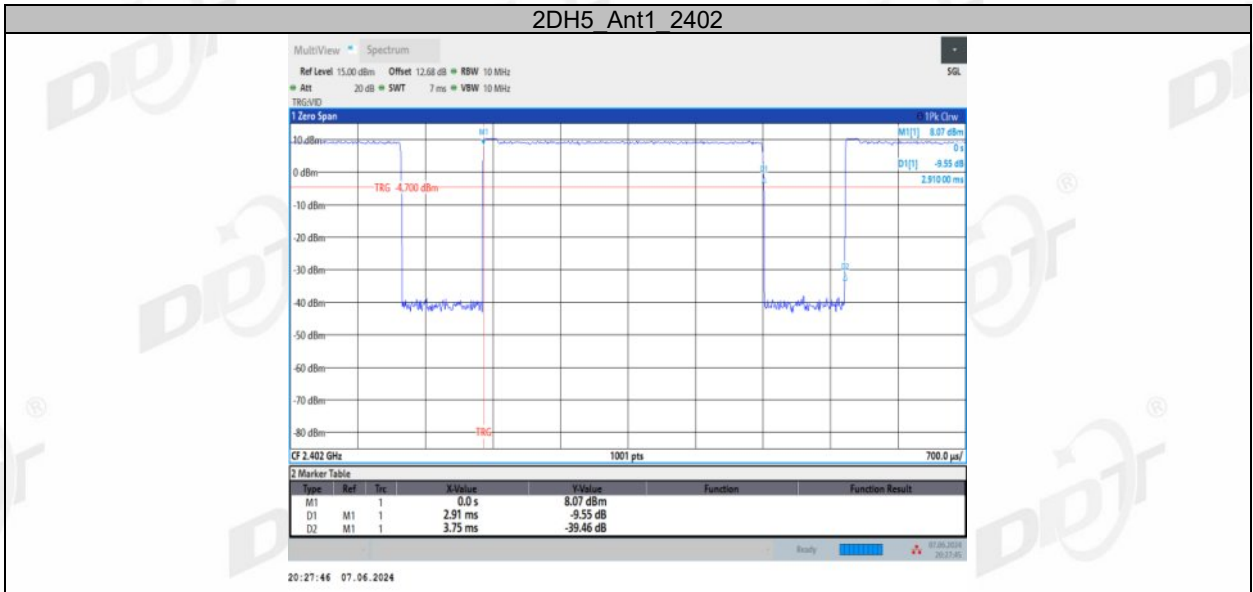

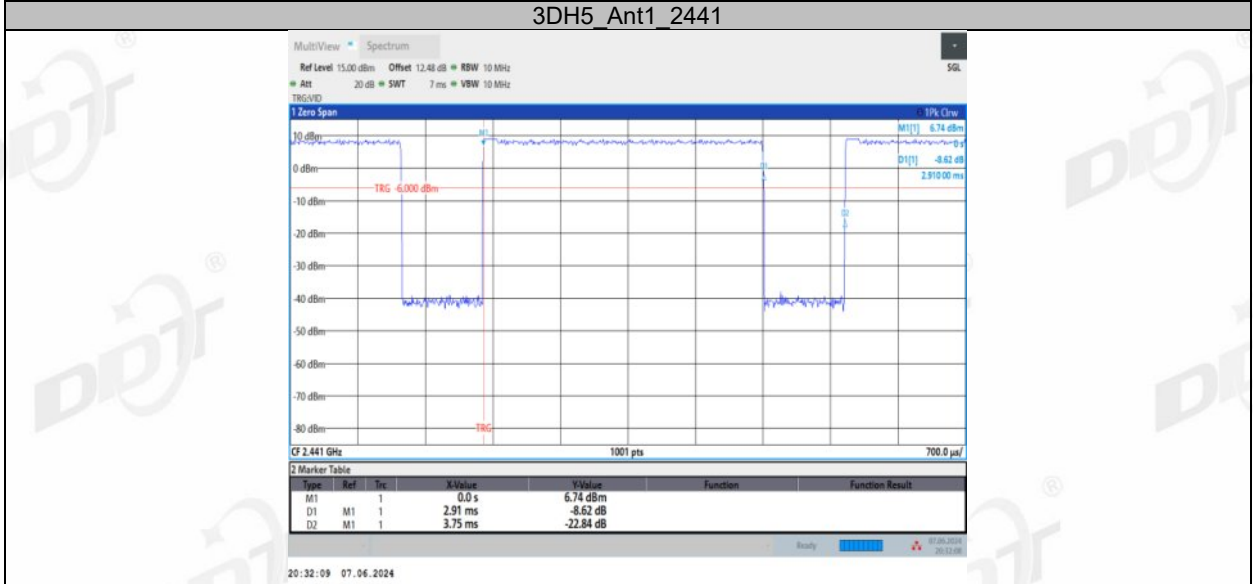
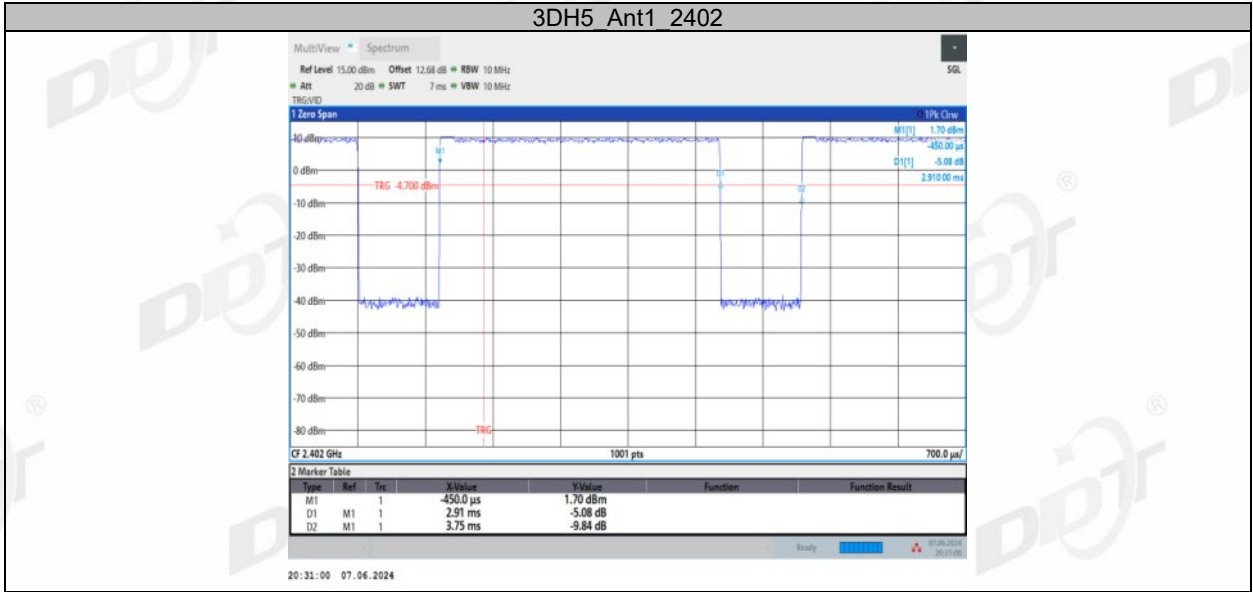

13. Antenna Requirements

13.1. Limit

For intentional device, according to FCC 47 CFR Section 15.203, an intentional radiator shall be designed to ensure that no antenna other than that furnished by the responsible party shall be used with the device. And according to FCC 47 CFR Section 15.247 (b), if transmitting antennas of directional gain greater than 6 dBi are used, the power shall be reduced by the amount in dB that the directional gain of the antenna exceeds 6 dBi.

For intentional device, according to RSS-Gen issue 5 section 6.8.

The applicant for equipment certification shall provide a list of all antenna types that may be used with the transmitter, where applicable (i.e. for transmitters with detachable antenna), indicating the maximum permissible antenna gain (in dBi) and the required impedance for each antenna. The test report shall demonstrate the compliance of the transmitter with the limit for maximum equivalent isotropically radiated power (e.i.r.p.) specified in the applicable RSS, when the transmitter is equipped with any antenna type, selected from this list.

13.2. Result

The antenna used for this product as Antenna information described in section 2.1 of the report, and there is no other antenna than that furnished by the responsible party shall be used with the device.

14. Radiated Emission

14.1. Test equipment

Equipment	Manufacturer	Model No.	Serial No.	Cal Due To	Cal. Interval
ELECTRIC AND MAGNETIC FIELD ANALYZER	Narda	EHP-200A	DDT-ZC01401	2024/09/20	1 Year
RF Cable	N/A	W24.02 HL-562	DDT-ZC04022	2025/03/31	1 Year
Trilog Broadband Antenna	Schwarzbeck	VULB 9163	DDT-ZC02050	2025/07/11	1 Year
EMI TEST RECEIVER	R&S	ESU26	DDT-ZC01909	2025/03/31	1 Year
Active Loop Antenna	Schwarzbeck	FMZB1519	DDT-ZC00524	2025/09/11	2 Year
Micro-Tronics filters	REBES	BRM50716	DDT-ZC03240	/	/
High pass filter	Micro-Tronics	HPM50102	DDT-ZC00561	2025/04/22	1 Year
Micro-Tronics filters	REBES	BRM50702	DDT-ZC03242	/	/
RF Cable	N/A	W13.02 AP1-X2	DDT-ZC04023	2025/03/31	1 Year
High pass filter	Micro-Tronics	HPM50108	DDT-ZC00560	2025/04/22	1 Year
RF cable	Yuhu Technology	JCTB810-NJ-NJ-9M	DDT-ZC02538	2025/03/31	1 Year
High Pass filter	Xi'an Xingbo	XBLBQ-GTA67	DDT-ZC02179	2025/04/22	1 Year
RF cable	Zhongke Junchuang	JCT26S-NJ-NJ-1.5M	DDT-ZC02762	2025/03/31	1 Year
Broad-Band Horn Antenna	Schwarzbeck	BBHA 9170	DDT-ZC00506	2025/04/26	1 Year
PSA Series Spectrum Analyzer	Agilent	E4447A	DDT-ZC00517	2025/03/31	1 Year
Hochgewinn-Hornantenne	SCHWARZBECK	BBHA 9120 D	DDT-ZC02129	2025/09/18	2 Year
Pre-amplifier	COM-POWER	PAM-118A	DDT-ZC01293	2025/07/08	1 Year
Pre-amplifier	COM-POWER	PAM-840A	DDT-ZC01693	2025/03/31	1 Year
RF cable	Yuhu Technology	ZT26S-SMAJ-SMAJ-1M	DDT-ZC02037	2025/03/31	1 Year

14.2. Block diagram of test setup

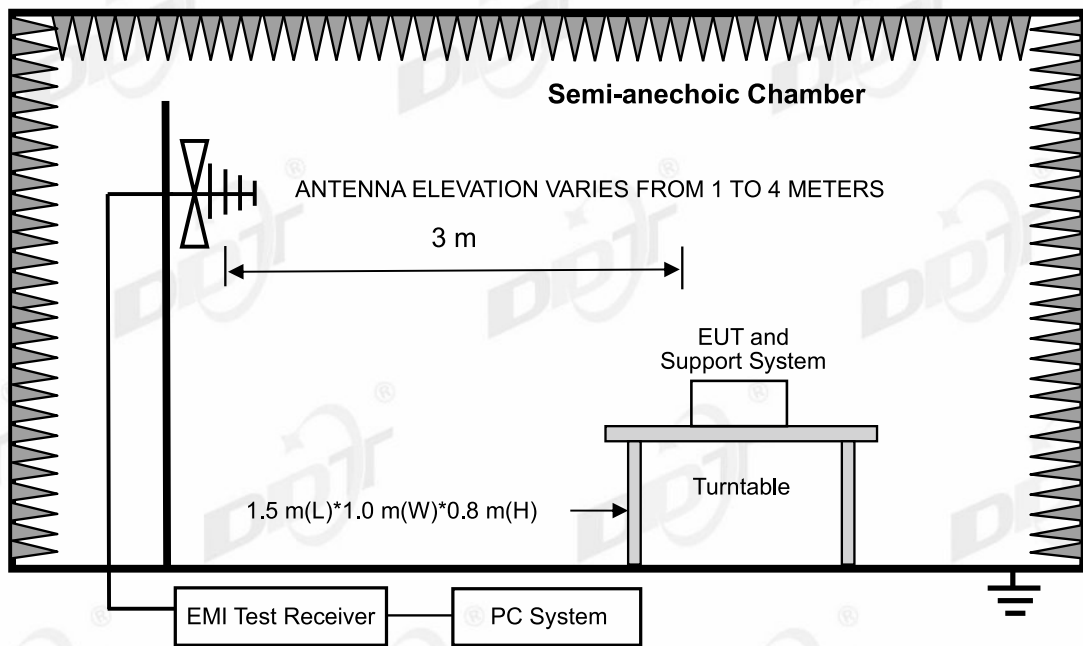
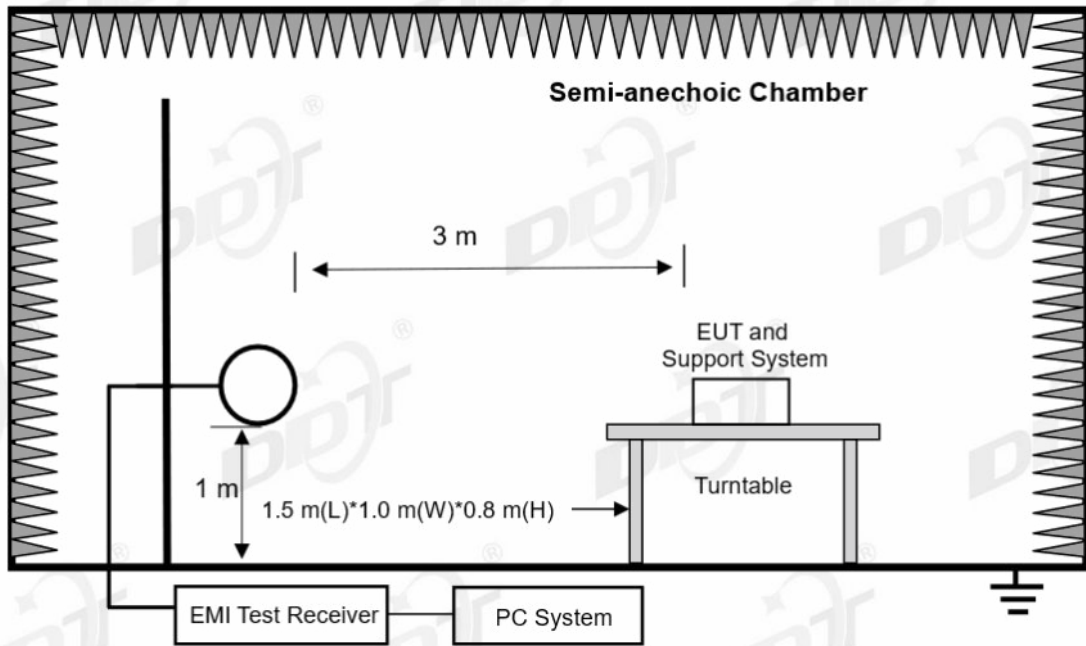

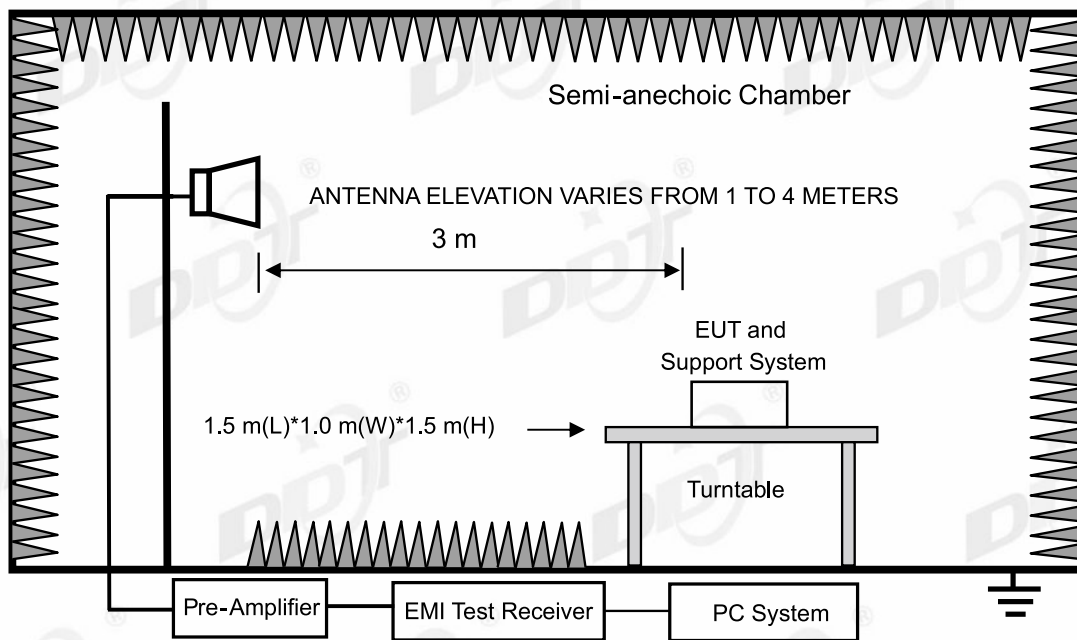

14.3. Limits

(1) FCC 15.205 Restricted frequency band

MHz	MHz	MHz	GHz
0.090-0.110	16.42-16.423	399.9-410	4.5-5.15
¹ 0.495-0.505	16.69475-16.69525	608-614	5.35-5.46
2.1735-2.1905	16.80425-16.80475	960-1240	7.25-7.75
4.125-4.128	25.5-25.67	1300-1427	8.025-8.5
4.1772&4.17775	37.5-38.25	1435-1626.5	9.0-9.2
4.2072&4.20775	73-74.6	1645.5-1646.5	9.3-9.5
6.215-6.218	74.8-75.2	1660-1710	10.6-12.7
6.26775-6.26825	108-121.94	1718.8-1722.2	13.25-13.4
6.31175-6.31225	123-138	2200-2300	14.47-14.5
8.291-8.294	149.9-150.05	2310-2390	15.35-16.2
8.362-8.366	156.52475-156.52525	2483.5-2500	17.7-21.4
8.37625-8.38675	156.7-156.9	2690-2900	22.01-23.12
8.41425-8.41475	162.0125-167.17	3260-3267	23.6-24.0
12.29-12.293	167.72-173.2	3332-3339	31.2-31.8
12.51975-12.52025	240-285	3345.8-3358	36.43-36.5
12.57675-12.57725	322-335.4	3600-4400	(²)
13.36-13.41			

¹Until February 1, 1999, this restricted band shall be 0.490-0.510 MHz

²Above 38.6

RSS-Gen section 8.10 Restricted frequency bands*

MHz	MHz	MHz	GHz
0.090-0.110	12.51975-12.52025	240-285	3.5-4.4
0.495-0.505	12.57675-12.57725	322-335.4	4.5-5.15
2.1735-2.1905	13.36-13.41	399.9-410	5.35-5.46
3.020-3.026	16.42-16.423	608-614	7.25-7.75
4.125-4.128	16.69475-16.69525	960-1427	8.025-8.5
4.1772&4.17775	16.80425-16.80475	1435-1626.5	9.0-9.2
4.2072&4.20775	25.5-25.67	1645.5-1646.5	9.3-9.5
5.677-5.683	37.5-38.25	1660-1710	10.6-12.7
6.215-6.218	73-74.6	1718.8-1722.2	13.25-13.4
6.26775-6.26825	74.8-75.2	2200-2300	14.47-14.5
6.31175-6.31225	108-138	2310-2390	15.35-16.2
8.291-8.294	149.9-150.05	2483.5-2500	17.7-21.4
8.362-8.366	156.52475-156.52525	2655-2900	22.01-23.12
8.37625-8.38675	156.7-156.9	3260-3267	23.6-24.0
8.41425-8.41475	162.0125-167.17	3332-3339	31.2-31.8
12.29-12.293	167.72-173.2	3345.8-3358	36.43-36.5
			Above 38.6

* Certain frequency bands listed in table and in bands above 38.6 GHz are designated for licence-exempt applications. These frequency bands and the requirements that apply to related devices are set out in the 200 and 300 series of RSSs.

(2) FCC 15.209 Limit & RSS-Gen section 8.9 Limit

FREQUENCY MHz	DISTANCE Meters	FIELD STRENGTHS LIMIT	
		mV/m	dB(mV)/m
0.009 ~ 0.490	300	2400/F(kHz)	67.6-20log(F)
0.490 ~ 1.705	30	24000/F(kHz)	87.6-20log(F)
1.705 ~ 30.0	30	30	29.54
30 ~ 88	3	100	40.0
88 ~ 216	3	150	43.5
216 ~ 960	3	200	46.0
960 ~ 1000	3	500	54.0
Above 1000	3	74.0 dB(mV)/m (Peak) 54.0 dB(mV)/m (Average)	

Note:

(1) The emission limits shown in the above table are based on measurements employing a CISPR QP detector except for the frequency bands 9 - 90 kHz, 110 - 490 kHz and above 1000 MHz, radiated emissions limits in these three bands are based on measurements employing an average detector.

(2) At frequencies below 30 MHz, measurement may be performed at a distance closer than that specified, and the limit at closer measurement distance can be extrapolated by below formula:

$$\text{Limit}_{3\text{m}}(\text{dBuV/m}) = \text{Limit}_{30\text{m}}(\text{dBuV/m}) + 40\text{Log}(30\text{m}/3\text{m})$$

(3) Limit for this EUT

The emissions appearing within 15.205 restricted frequency bands shall not exceed the limits shown in 15.209, and the emissions appearing within RSS-Gen section 8.10 Restricted frequency bands shall not exceed the limits shown in RSS-Gen section 8.9, all the other emissions shall be at least 20 dB below the fundamental emissions or comply with 15.209 limits and RSS-Gen section 8.9 limits.

14.4. Assistant equipment used for test

Assistant equipment	Manufacturer	Model number	Description	other
/	/	/	/	/

14.5. Test procedure

(1) EUT was placed on a non-metallic table, 80 cm above the ground plane inside a semi-anechoic chamber for below 1G and 150 cm above the ground plane inside a fully-anechoic chamber for above 1G.

(2) Test antenna was located 3 m from the EUT on an adjustable mast, and the antenna used as below table.

Test frequency range	Test antenna used	Test antenna distance
9 kHz - 30 MHz	Active Loop antenna	3 m
30 MHz - 1 GHz	Trilog Broadband Antenna	3 m
1 GHz - 18 GHz	Double Ridged Horn Antenna(1 GHz-18 GHz)	3 m
18 GHz - 40 GHz	Horn Antenna(18 GHz-40 GHz)	1 m

According ANSI C63.10:2020 clause 6.4.6 and 6.5.3, for measurements below 30 MHz, Antenna was located 3 m from EUT, the loop antenna was positioned in three antenna orientations (parallel, perpendicular, and round-parallel), for each measurement antenna alignment, the EUT shall be rotated through 0° to 360° on a turntable, and the lowest height of the magnetic antenna shall be 1 m above the ground. For measurement above 30MHz, the trilog Broadband Antenna or Horn Antenna was located 3m from EUT, Measurements were made with the antenna positioned in both the horizontal and vertical planes of Polarization, and the measurement antenna was varied from 1 m to 4 m. in height above the reference ground plane to obtain the maximum signal strength.

(3) Below pre-scan procedure was first performed in order to find prominent frequency spectrum radiated emissions from 9 kHz to 25 GHz:

(a) Scanning the peak frequency spectrum with the antenna specified in step (3), and the EUT was rotated 360 degree, the antenna height was varied from 1 m to 4 m (Except loop antenna, it's fixed 1 m above ground.)

- (b) Change work frequency or channel of device if practicable.
- (c) Change modulation type of device if practicable.
- (d) Change power supply range from 85% to 115% of the rated supply voltage
- (e) Rotated EUT though three orthogonal axes to determine the attitude of EUT arrangement produces highest emissions.

Spectrum frequency from 9 kHz to 25 GHz (tenth harmonic of fundamental frequency) was investigated, and no any obvious emission were detected from 18 GHz to 25 GHz, so below final test was performed with frequency range from 9 kHz to 18 GHz.

(4) For final emissions measurements at each frequency of interest, the EUT was rotated and the antenna height was varied between 1 m and 4 m in order to maximize the emission. Measurements in both horizontal and vertical polarities were made and the data was recorded. In order to find the maximum emission, the relative positions of equipment and all of the interface cables were changed according to ANSI C63.10:2020 on Radiated Emission test.

(5) The emissions from 9 kHz to 1 GHz were measured based on CISPR QP detector except for the frequency bands 9 - 90 kHz, 110 - 490 kHz, for emissions from 9 kHz - 90 kHz, 110 kHz - 490 kHz and above 1 GHz were measured based on average detector, for emissions above 1 GHz, peak emissions also be measured and need comply with Peak limit.

(6) The emissions from 9 kHz to 1 GHz, QP or average values were measured with EMI receiver with below RBW.

Frequency band	RBW
9 kHz - 150 kHz	200 Hz
150 kHz - 30 MHz	9 kHz
30 MHz - 1 GHz	120 kHz

(7) For emissions above 1GHz, both Peak and Average level were measured with Spectrum Analyzer, and the RBW is set at 1 MHz, VBW is set at 3 MHz for Peak measure; According ANSI C63.10:2020 clause 4.1.4.2.2 procedure for average measure.

(8) For portable device, X axis, Y axis, Z axis are tested, and worse setup is reported.

14.6. Test result

PASS. (See below detailed test result)

Note1: According exploratory test, the emission levels are 20 dB below the limit detected from 9 kHz to 30 MHz and 18 GHz to 25 GHz, so the final test was performed with frequency range from 30 MHz to 18 GHz and recorded in below.

Note2: 30 MHz ~ 25 GHz: (Scan with GFSK, $\pi/4$ -DQPSK and 8DPSK, the worst case is GFSK Mode)

Note3: For emissions below 1 GHz, according exploratory explorer test, when change Tx mode and channel, have no distinct influence on emissions level, so for emissions below 1 GHz, the final test was only performed with EUT working in GFSK, Tx 2402 MHz mode.

Note4: For emissions above 1 GHz. If peak results comply with AV limit, AV Result is deemed to comply with AV limit.

14.7. Test data

TR-4-E-009 Radiated Emission Test Result

Test Date: 2024-06-17 **Tested By:** Junchang Du
EUT: Multimedia Speaker **Model Number:** EDF100074
Test Mode: BT TX **Power Supply:** AC 120V/60Hz
Condition: Temp:21.9°C;Humi:51.0% **Test Site:** DDT 3# Chamber
File Path: d:\ts\2024 report data\Q24052413-1E EDF100074\FCC BELOW 1G\20240617-133410_H
Memo: Sample Number:S24052413-003 Power Setting:2

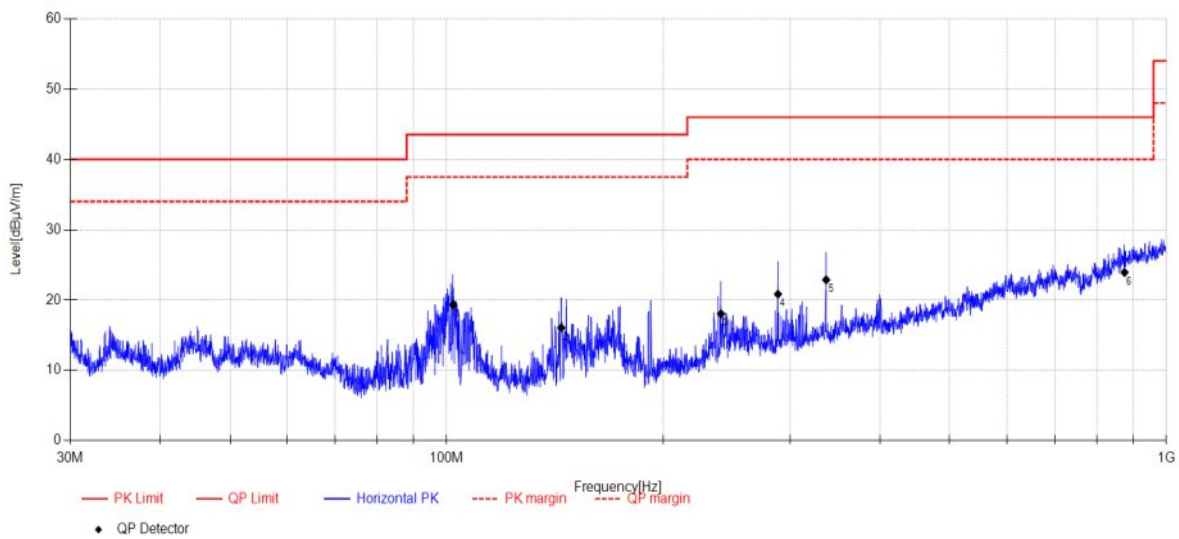

Data List										
NO.	Freq. [MHz]	Reading [dBμV/m]	Antenna Factor [dB]	Cable Loss [dB]	AMP [dB]	Result [dBμV/m]	Limit [dBμV/m]	Margin [dB]	Detector	Polarity
1	102.048	35.19	10.81	4.23	-30.89	19.34	43.50	24.16	QP	Horizontal
2	144.289	33.29	9.07	4.46	-30.77	16.05	43.50	27.45	QP	Horizontal
3	240.561	31.8	11.77	4.95	-30.48	18.04	46.00	27.96	QP	Horizontal
4	288.669	33.07	12.93	5.17	-30.33	20.84	46.00	25.16	QP	Horizontal
5	336.816	33.35	14.38	5.37	-30.23	22.87	46.00	23.13	QP	Horizontal
6	874.657	24.53	21.49	7.14	-29.23	23.93	46.00	22.07	QP	Horizontal

Note:

1. Result Level = Reading + Cable loss + Antenna Factor + AMP
2. If Peak Result complies with QP limit, QP Result is deemed to comply with QP limit.
3. Test setup: RBW: 120 kHz, VBW: 300 kHz, Sweep time: auto.

TR-4-E-009 Radiated Emission Test Result

Test Date: 2024-06-17 **Tested By:** Junchang Du
EUT: Multimedia Speaker **Model Number:** EDF100074
Test Mode: BT TX **Power Supply:** AC 120V/60Hz
Condition: Temp:21.9°C;Humi:51.0% **Test Site:** DDT 3# Chamber
File Path: d:\ts\2024 report data\Q24052413-1E EDF100074\FCC BELOW 1G\20240617-133455_V
Memo: Sample Number:S24052413-003 Power Setting:2

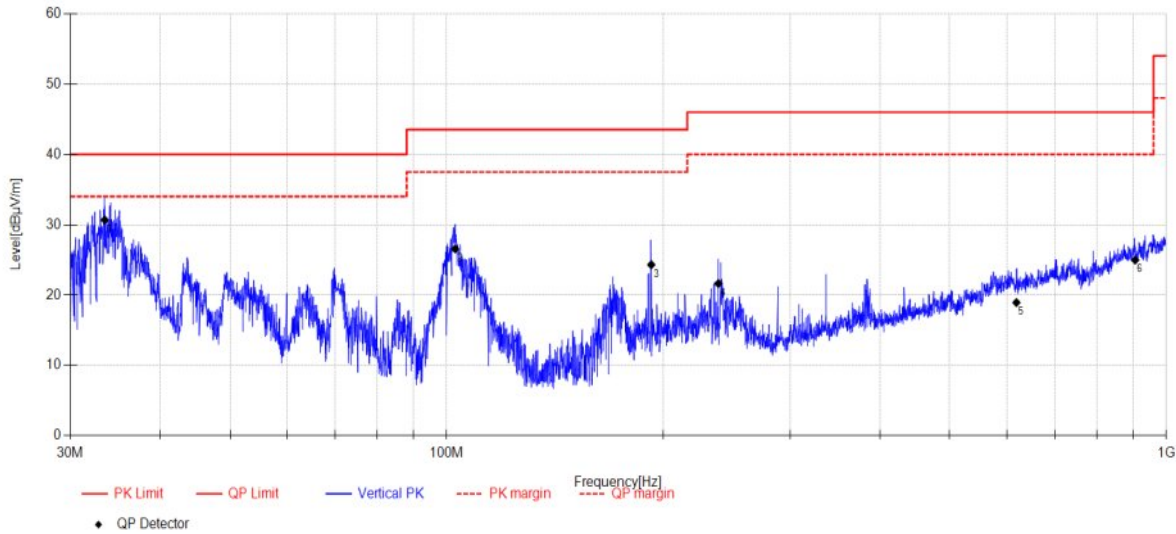

Data List										
NO.	Freq. [MHz]	Reading [dBμV/m]	Antenna Factor [dB]	Cable Loss [dB]	AMP [dB]	Result [dBμV/m]	Limit [dBμV/m]	Margin [dB]	Detector	Polarity
1	33.491	46.63	11.22	3.78	-30.95	30.68	40.00	9.32	QP	Vertical
2	102.766	42.19	11.03	4.23	-30.89	26.56	43.50	16.94	QP	Vertical
3	192.482	40.41	9.80	4.72	-30.62	24.31	43.50	19.19	QP	Vertical
4	238.546	35.5	11.68	4.94	-30.48	21.64	46.00	24.36	QP	Vertical
5	619.030	24.13	18.28	6.43	-29.90	18.94	46.00	27.06	QP	Vertical
6	905.230	24.84	21.88	7.21	-28.95	24.98	46.00	21.02	QP	Vertical

Note:

1. Result Level = Reading + Cable loss + Antenna Factor + AMP
2. If Peak Result complies with QP limit, QP Result is deemed to comply with QP limit.
3. Test setup: RBW: 120 kHz, VBW: 300 kHz, Sweep time: auto.

TR-4-E-009 Radiated Emission Test Result

Test Date: 2024-06-17 **Tested By:** Junchang Du
EUT: Multimedia Speaker **Model Number:** EDF100074
Test Mode: DH5 TX 2402MHz **Power Supply:** AC 120V/60Hz
Condition: Temp:21.9°C;Humi:51.0% **Test Site:** DDT 3# Chamber
File Path: d:\ts\2024 report data\Q24052413-1E EDF100074\FCC ABOVE 1G\1
Memo: Sample Number:S24052413-003 Power Setting:2

Test Graph

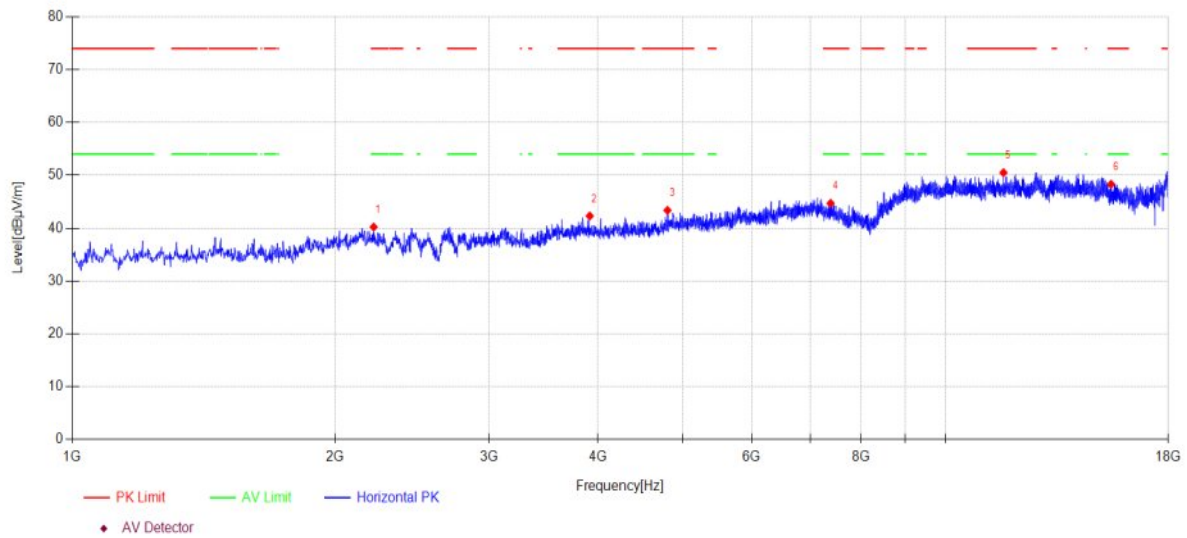

Data List										
NO.	Freq. [MHz]	Reading [dBμV/m]	Antenna Factor [dB]	Cable loss [dB]	AMP [dB]	Level [dBμV/m]	Limit [dBμV/m]	Margin [dB]	Detector	Polarity
1	2213.800	45.46	27.66	4.72	-37.62	40.22	74.00	33.78	PK	Horizontal
2	3913.800	46.48	31.17	5.06	-40.40	42.31	74.00	31.69	PK	Horizontal
3	4804.600	45.37	32.62	5.53	-40.15	43.37	74.00	30.63	PK	Horizontal
4	7386.900	43.00	36.73	6.65	-41.67	44.71	74.00	29.29	PK	Horizontal
5	11653.900	42.36	39.00	8.54	-39.40	50.50	74.00	23.50	PK	Horizontal
6	15477.200	38.71	38.85	9.80	-39.05	48.31	74.00	25.69	PK	Horizontal

Note:

- Level = Reading + Cable loss + Antenna Factor + AMP
- If Peak Result complies with AV limit, AV Result is deemed to comply with AV limit.
- Test setup: RBW: 1 MHz, VBW: 3 MHz, Sweep time: auto.

TR-4-E-009 Radiated Emission Test Result

Test Date: 2024-06-17 **Tested By:** Junchang Du
EUT: Multimedia Speaker **Model Number:** EDF100074
Test Mode: DH5 TX 2402MHz **Power Supply:** AC 120V/60Hz
Condition: Temp:21.9°C;Humi:51.0% **Test Site:** DDT 3# Chamber
File Path: d:\ts\2024 report data\Q24052413-1E EDF100074\FCC ABOVE 1G2
Memo: Sample Number:S24052413-003 Power Setting:2

Test Graph

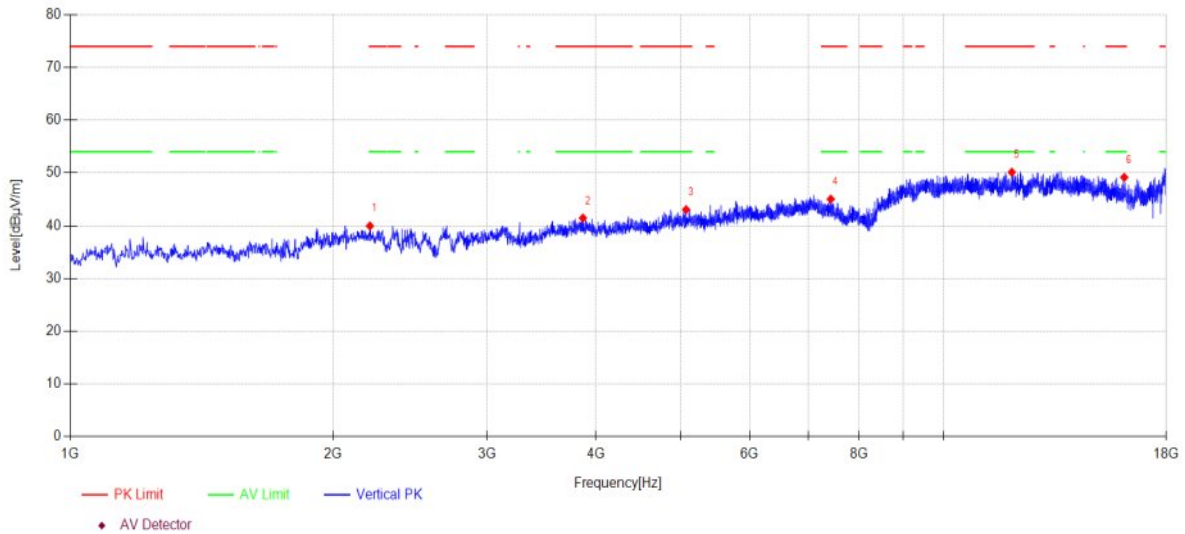

Data List										
NO.	Freq. [MHz]	Reading [dBµV/m]	Antenna Factor [dB]	Cable loss [dB]	AMP [dB]	Level [dBµV/m]	Limit [dBµV/m]	Margin [dB]	Detector	Polarity
1	2203.600	45.06	27.76	4.72	-37.59	39.95	74.00	34.05	PK	Vertical
2	3864.500	45.76	30.99	5.07	-40.37	41.45	74.00	32.55	PK	Vertical
3	5073.200	44.09	33.35	5.69	-40.07	43.06	74.00	30.94	PK	Vertical
4	7429.400	43.50	36.64	6.67	-41.77	45.04	74.00	28.96	PK	Vertical
5	11976.900	41.81	39.13	8.75	-39.55	50.14	74.00	23.86	PK	Vertical
6	16109.600	40.56	37.89	10.17	-39.45	49.17	74.00	24.83	PK	Vertical

Note:

- Level = Reading + Cable loss + Antenna Factor + AMP
- If Peak Result complies with AV limit, AV Result is deemed to comply with AV limit.
- Test setup: RBW: 1 MHz, VBW: 3 MHz, Sweep time: auto.

TR-4-E-009 Radiated Emission Test Result

Test Date: 2024-06-17 **Tested By:** Junchang Du
EUT: Multimedia Speaker **Model Number:** EDF100074
Test Mode: DH5 TX 2441MHz **Power Supply:** AC 120V/60Hz
Condition: Temp:21.9°C;Humi:51.0% **Test Site:** DDT 3# Chamber
File Path: d:\ts\2024 report data\Q24052413-1E EDF100074\FCC ABOVE 1G3
Memo: Sample Number:S24052413-003 Power Setting:2

Test Graph

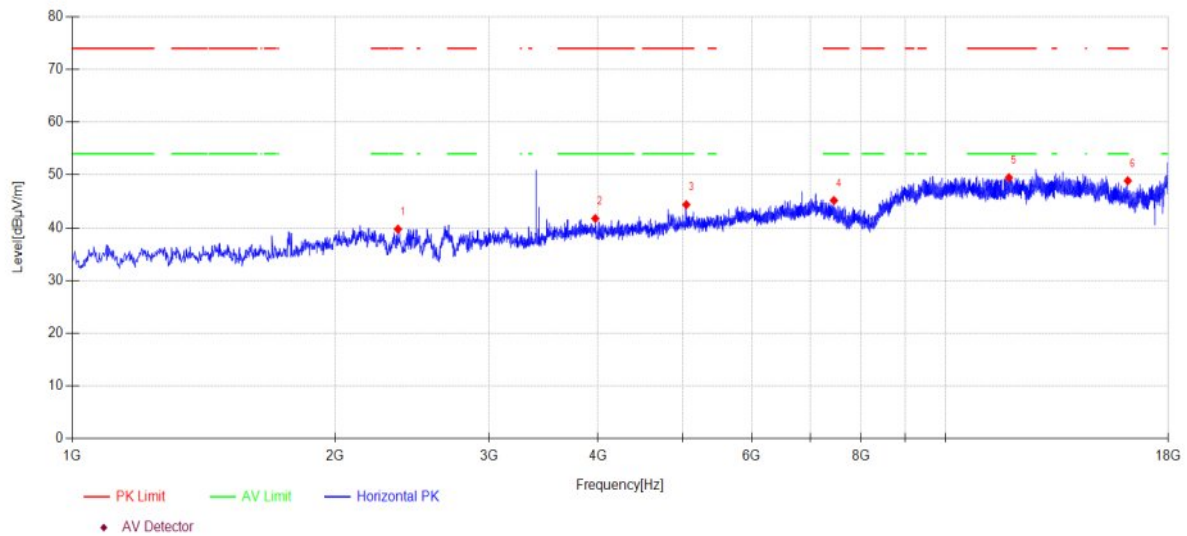

Data List										
NO.	Freq. [MHz]	Reading [dBµV/m]	Antenna Factor [dB]	Cable loss [dB]	AMP [dB]	Level [dBµV/m]	Limit [dBµV/m]	Margin [dB]	Detector	Polarity
1	2360.000	45.80	27.14	4.82	-38.03	39.73	74.00	34.27	PK	Horizontal
2	3971.600	46.12	31.01	5.05	-40.43	41.75	74.00	32.25	PK	Horizontal
3	5049.400	45.46	33.30	5.68	-40.07	44.37	74.00	29.63	PK	Horizontal
4	7451.500	43.71	36.60	6.68	-41.83	45.16	74.00	28.84	PK	Horizontal
5	11823.900	41.43	38.90	8.65	-39.48	49.50	74.00	24.50	PK	Horizontal
6	16175.900	40.39	37.82	10.19	-39.50	48.90	74.00	25.10	PK	Horizontal

Note:

- Level = Reading + Cable loss + Antenna Factor + AMP
- If Peak Result complies with AV limit, AV Result is deemed to comply with AV limit.
- Test setup: RBW: 1 MHz, VBW: 3 MHz, Sweep time: auto.

TR-4-E-009 Radiated Emission Test Result

Test Date: 2024-06-17 **Tested By:** Junchang Du
EUT: Multimedia Speaker **Model Number:** EDF100074
Test Mode: DH5 TX 2441MHz **Power Supply:** AC 120V/60Hz
Condition: Temp:21.9°C;Humi:51.0% **Test Site:** DDT 3# Chamber
File Path: d:\ts\2024 report data\Q24052413-1E EDF100074\FCC ABOVE 1G4
Memo: Sample Number:S24052413-003 Power Setting:2

Test Graph

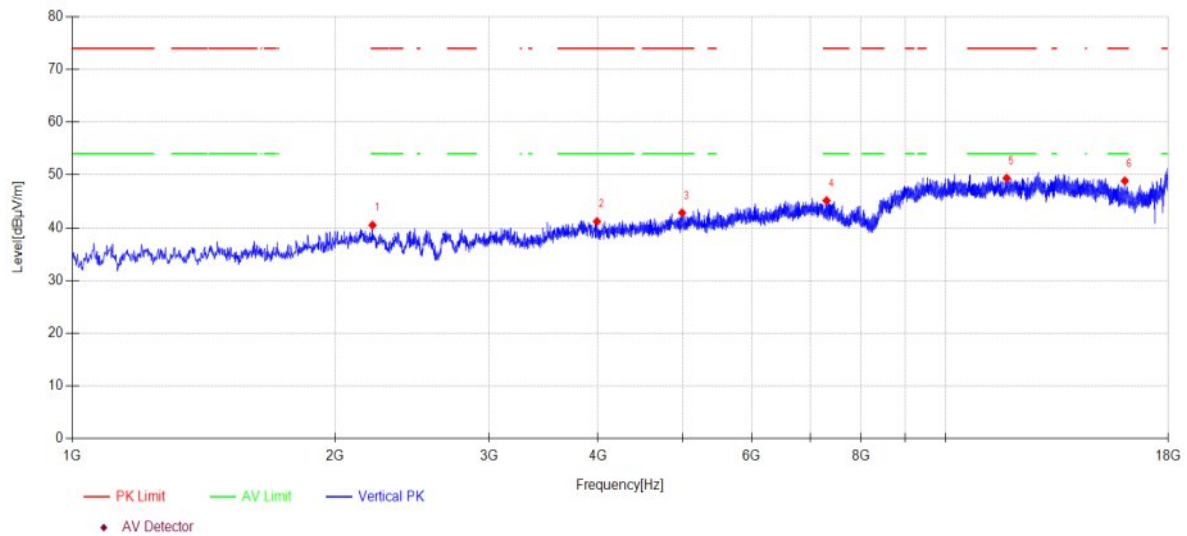

Data List										
NO.	Freq. [MHz]	Reading [dBµV/m]	Antenna Factor [dB]	Cable loss [dB]	AMP [dB]	Level [dBµV/m]	Limit [dBµV/m]	Margin [dB]	Detector	Polarity
1	2207.000	45.63	27.73	4.72	-37.60	40.48	74.00	33.52	PK	Vertical
2	3988.600	45.61	30.95	5.05	-40.44	41.17	74.00	32.83	PK	Vertical
3	4993.300	44.06	33.19	5.65	-40.08	42.82	74.00	31.18	PK	Vertical
4	7308.700	43.12	36.88	6.60	-41.47	45.13	74.00	28.87	PK	Vertical
5	11752.500	41.28	38.95	8.60	-39.44	49.39	74.00	24.61	PK	Vertical
6	16048.400	40.17	37.95	10.16	-39.40	48.88	74.00	25.12	PK	Vertical

Note:

- Level = Reading + Cable loss + Antenna Factor + AMP
- If Peak Result complies with AV limit, AV Result is deemed to comply with AV limit.
- Test setup: RBW: 1 MHz, VBW: 3 MHz, Sweep time: auto.

TR-4-E-009 Radiated Emission Test Result

Test Date: 2024-06-17 **Tested By:** Junchang Du
EUT: Multimedia Speaker **Model Number:** EDF100074
Test Mode: DH5 TX 2480MHz **Power Supply:** AC 120V/60Hz
Condition: Temp:21.9°C;Humi:51.0% **Test Site:** DDT 3# Chamber
File Path: d:\ts\2024 report data\Q24052413-1E EDF100074\FCC ABOVE 1G5
Memo: Sample Number:S24052413-003 Power Setting:2

Test Graph

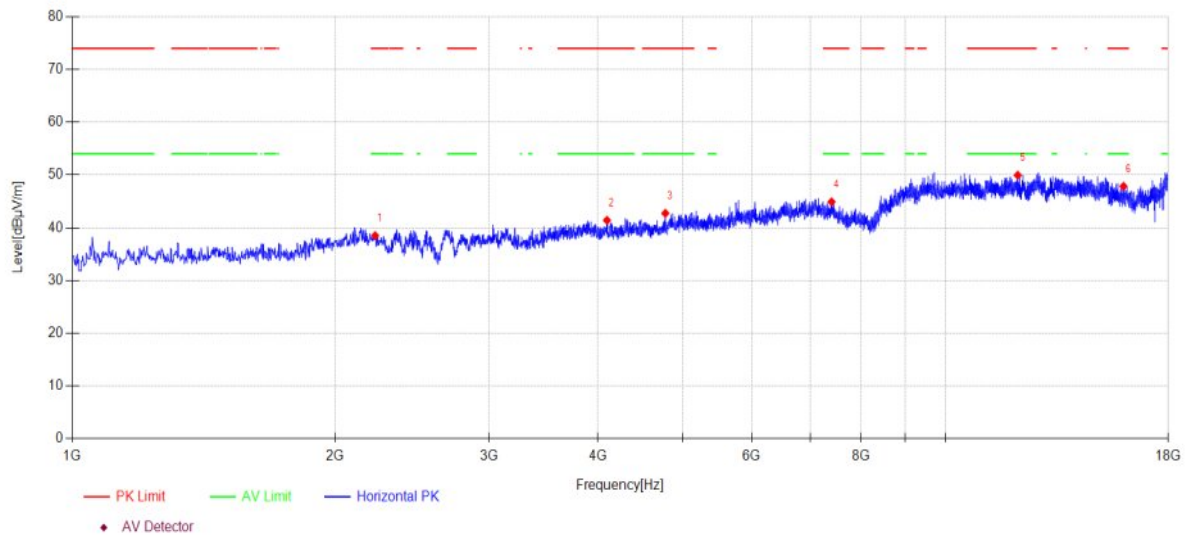

Data List										
NO.	Freq. [MHz]	Reading [dBμV/m]	Antenna Factor [dB]	Cable loss [dB]	AMP [dB]	Level [dBμV/m]	Limit [dBμV/m]	Margin [dB]	Detector	Polarity
1	2222.300	43.84	27.58	4.73	-37.64	38.51	74.00	35.49	PK	Horizontal
2	4095.700	45.61	31.09	5.11	-40.41	41.40	74.00	32.60	PK	Horizontal
3	4777.400	44.96	32.41	5.52	-40.16	42.73	74.00	31.27	PK	Horizontal
4	7405.600	43.27	36.69	6.65	-41.71	44.90	74.00	29.10	PK	Horizontal
5	12101.000	41.44	39.30	8.81	-39.60	49.95	74.00	24.05	PK	Horizontal
6	15992.300	39.06	38.01	10.14	-39.36	47.85	74.00	26.15	PK	Horizontal

Note:

- Level = Reading + Cable loss + Antenna Factor + AMP
- If Peak Result complies with AV limit, AV Result is deemed to comply with AV limit.
- Test setup: RBW: 1 MHz, VBW: 3 MHz, Sweep time: auto.

TR-4-E-009 Radiated Emission Test Result

Test Date: 2024-06-17 **Tested By:** Junchang Du
EUT: Multimedia Speaker **Model Number:** EDF100074
Test Mode: DH5 TX 2480MHz **Power Supply:** AC 120V/60Hz
Condition: Temp:21.9°C;Humi:51.0% **Test Site:** DDT 3# Chamber
File Path: d:\ts\2024 report data\Q24052413-1E EDF100074\FCC ABOVE 1G6
Memo: Sample Number:S24052413-003 Power Setting:2

Test Graph

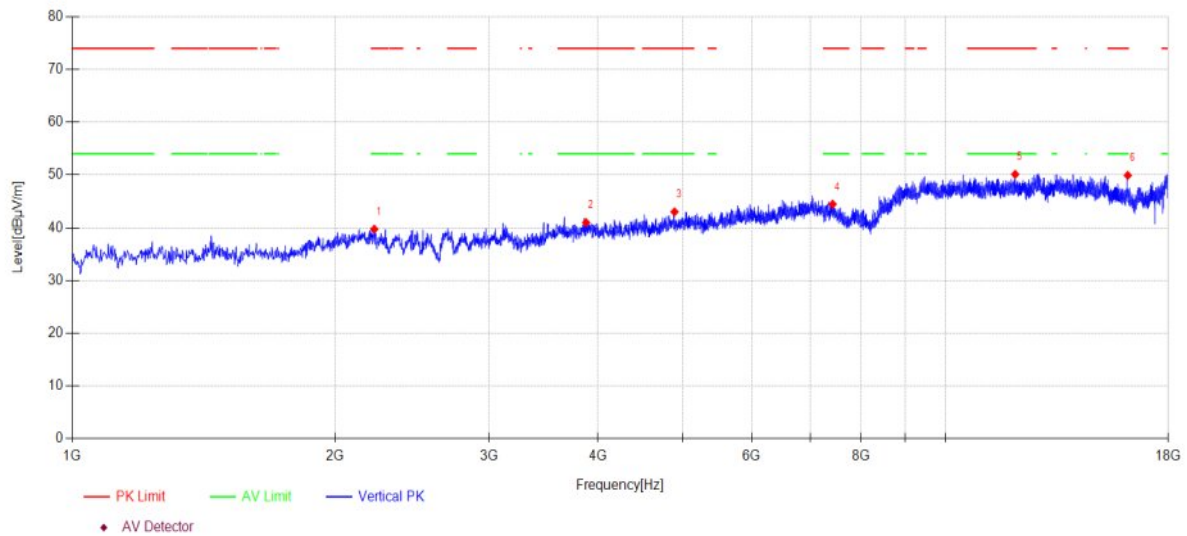

Data List										
NO.	Freq. [MHz]	Reading [dBµV/m]	Antenna Factor [dB]	Cable loss [dB]	AMP [dB]	Level [dBµV/m]	Limit [dBµV/m]	Margin [dB]	Detector	Polarity
1	2217.200	44.98	27.63	4.73	-37.62	39.72	74.00	34.28	PK	Vertical
2	3876.400	45.21	31.06	5.07	-40.37	40.97	74.00	33.03	PK	Vertical
3	4894.700	44.46	33.08	5.59	-40.12	43.01	74.00	30.99	PK	Vertical
4	7426.000	42.91	36.65	6.67	-41.77	44.46	74.00	29.54	PK	Vertical
5	12017.700	41.70	39.22	8.77	-39.57	50.12	74.00	23.88	PK	Vertical
6	16174.200	41.40	37.83	10.19	-39.50	49.92	74.00	24.08	PK	Vertical

Note:

- Level = Reading + Cable loss + Antenna Factor + AMP
- If Peak Result complies with AV limit, AV Result is deemed to comply with AV limit.
- Test setup: RBW: 1 MHz, VBW: 3 MHz, Sweep time: auto.

15. Band Edge Compliance

15.1. Test equipment

Equipment	Manufacturer	Model No.	Serial No.	Cal Due To	Cal. Interval
RF cable	Yuhu Technology	JCTB810-NJ-NJ-9M	DDT-ZC02538	2025/03/31	1 Year
RF cable	Yuhu Technology	ZT26S-SMAJ-SMAJ-1M	DDT-ZC02037	2025/03/31	1 Year
Pre-amplifier	COM-POWER	PAM-118A	DDT-ZC01293	2025/07/08	1 Year
High pass filter	Micro-Tronics	HPM50108	DDT-ZC00560	2025/04/22	1 Year
PSA Series Spectrum Analyzer	Agilent	E4447A	DDT-ZC00517	2025/03/31	1 Year
Pre-amplifier	COM-POWER	PAM-840A	DDT-ZC01693	2025/03/31	1 Year
Micro-Tronics filters	REBES	BRM50716	DDT-ZC03240	/	/
EMI TEST RECEIVER	R&S	ESU26	DDT-ZC01909	2025/03/31	1 Year
RF Cable	N/A	W24.02 HL-562	DDT-ZC04022	2025/03/31	1 Year
RF Cable	N/A	W13.02 AP1-X2	DDT-ZC04023	2025/03/31	1 Year
Hochgewinn-Hornantenne	SCHWARZBECK	BBHA 9120 D	DDT-ZC02129	2025/09/18	2 Year
RF cable	Zhongke Junchuang	JCT26S-NJ-NJ-1.5M	DDT-ZC02762	2025/03/31	1 Year
High pass filter	Micro-Tronics	HPM50102	DDT-ZC00561	2025/04/22	1 Year
Micro-Tronics filters	REBES	BRM50702	DDT-ZC03242	/	/
ELECTRIC AND MAGNETIC FIELD ANALYZER	Narda	EHP-200A	DDT-ZC01401	2024/09/20	1 Year
Broad-Band Horn Antenna	Schwarzbeck	BBHA 9170	DDT-ZC00506	2025/04/26	1 Year
Active Loop Antenna	Schwarzbeck	FMZB1519	DDT-ZC00524	2025/09/11	2 Year
High Pass filter	Xi'an Xingbo	XBLBQ-GTA67	DDT-ZC02179	2025/04/22	1 Year
Trilog Broadband Antenna	Schwarzbeck	VULB 9163	DDT-ZC02050	2025/07/11	1 Year

15.2. Block diagram of test setup

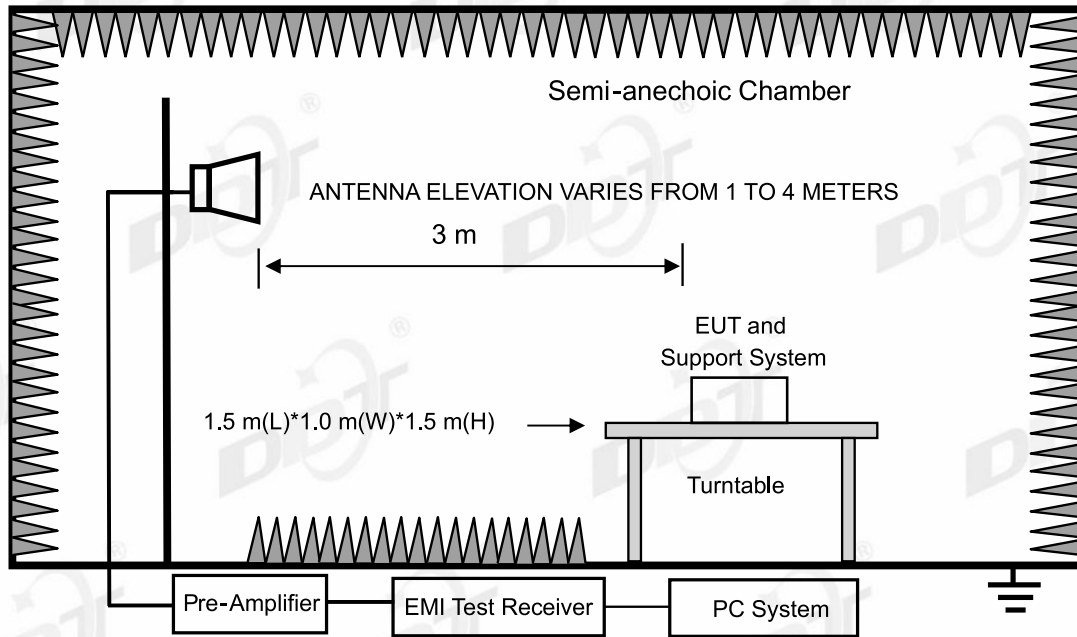

15.3. Limits

All restriction band should comply with 15.209 and RSS-Gen section 8.9 limits, other emission should be at least 20 dB below the fundamental.

15.4. Assistant equipment used for test

Assistant equipment	Manufacturer	Model number	Description	other
/	/	/	/	/

15.5. Test procedure

Same with Radiated Emission except change investigated frequency range.

Remark: All restriction band have been tested, and only the worst case is shown in report.

15.6. Test result

PASS. (See below detailed test result)

15.7. Test data

TR-4-E-009 Radiated Emission Test Result

Test Date: 2024-06-17 **Tested By:** Junchang Du
EUT: Multimedia Speaker **Model Number:** EDF100074
Test Mode: DH5 TX 2402MHz **Power Supply:** AC 120V/60Hz
Condition: Temp:21.9°C;Humi:51.0% **Test Site:** DDT 3# Chamber
File Path: d:\ts\2024 report data\Q24052413-1E EDF100074\FCC ABOVE 1G\13
Memo: Sample Number:S24052413-003 Power Setting:2

Test Graph

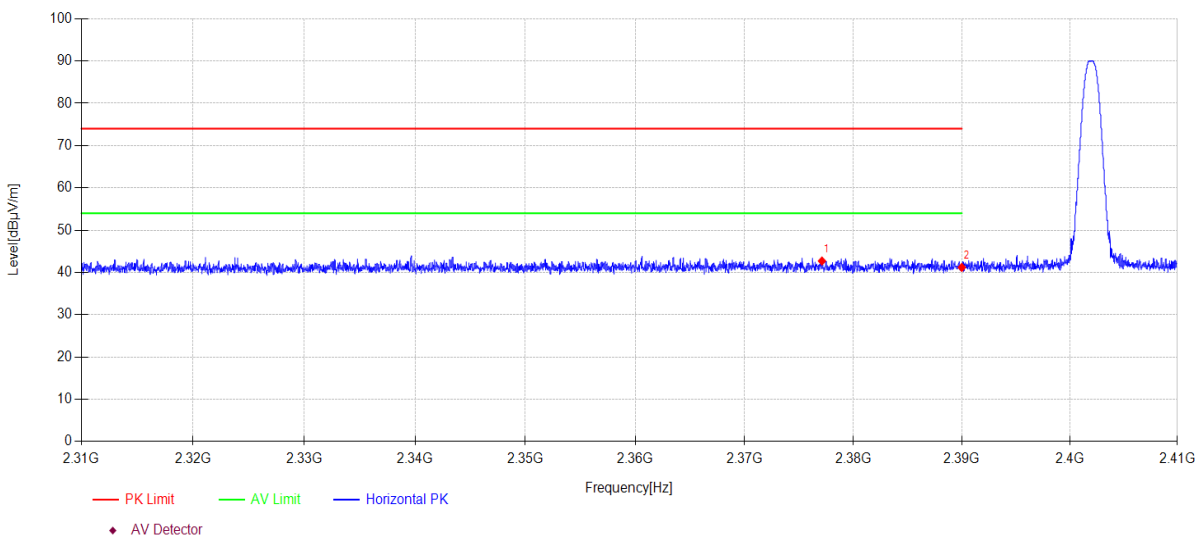

Data List										
NO.	Freq. [MHz]	Reading [dBµV/m]	Antenna Factor [dB]	Cable loss [dB]	AMP [dB]	Level [dBµV/m]	Limit [dBµV/m]	Margin [dB]	Detector	Polarity
1	2377.110	11.94	27.21	3.56	0.00	42.71	74.00	31.29	PK	Horizontal
2	2390.000	10.36	27.26	3.57	0.00	41.19	74.00	32.81	PK	Horizontal

Note:

1. Level = Reading + Cable loss + Antenna Factor + AMP
2. If Peak Result complies with AV limit, AV Result is deemed to comply with AV limit.
3. Test setup: RBW: 1 MHz, VBW: 3 MHz, Sweep time: auto.

TR-4-E-009 Radiated Emission Test Result

Test Date: 2024-06-17 **Tested By:** Junchang Du
EUT: Multimedia Speaker **Model Number:** EDF100074
Test Mode: DH5 TX 2402MHz **Power Supply:** AC 120V/60Hz
Condition: Temp:21.9°C;Humi:51.0% **Test Site:** DDT 3# Chamber
File Path: d:\ts\2024 report data\Q24052413-1E EDF100074\FCC ABOVE 1G\14
Memo: Sample Number:S24052413-003 Power Setting:2

Test Graph

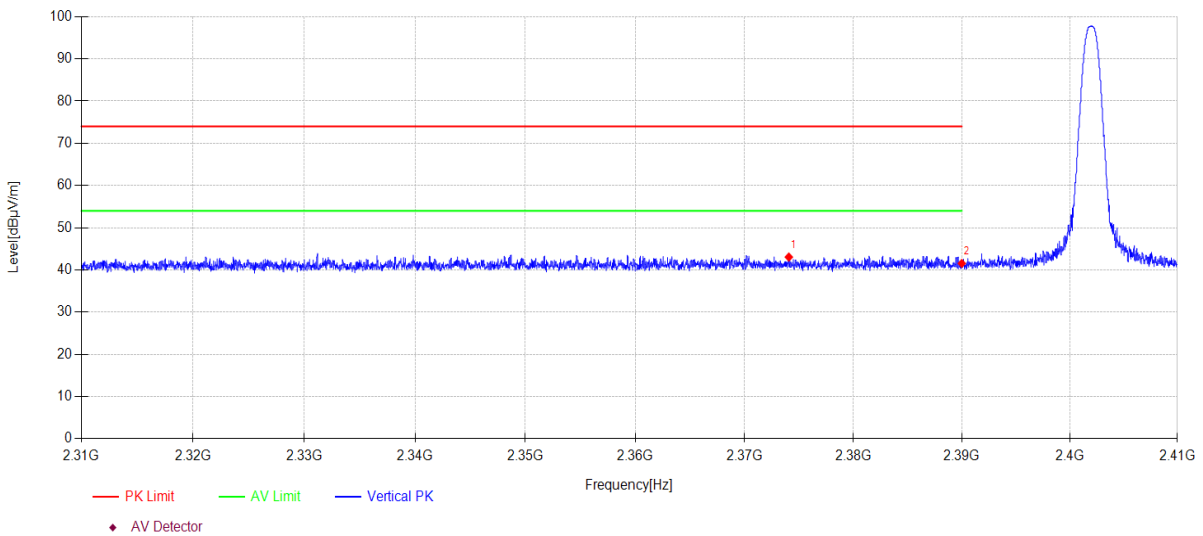

Data List										
NO.	Freq. [MHz]	Reading [dBµV/m]	Antenna Factor [dB]	Cable loss [dB]	AMP [dB]	Level [dBµV/m]	Limit [dBµV/m]	Margin [dB]	Detector	Polarity
1	2374.070	12.29	27.20	3.56	0.00	43.05	74.00	30.95	PK	Vertical
2	2390.000	10.72	27.26	3.57	0.00	41.55	74.00	32.45	PK	Vertical

Note:

- Level = Reading + Cable loss + Antenna Factor + AMP
- If Peak Result complies with AV limit, AV Result is deemed to comply with AV limit.
- Test setup: RBW: 1 MHz, VBW: 3 MHz, Sweep time: auto.

TR-4-E-009 Radiated Emission Test Result

Test Date: 2024-06-17 **Tested By:** Junchang Du
EUT: Multimedia Speaker **Model Number:** EDF100074
Test Mode: 2DH5 TX 2402MHz **Power Supply:** AC 120V/60Hz
Condition: Temp:21.9°C;Humi:51.0% **Test Site:** DDT 3# Chamber
File Path: d:\ts\2024 report data\Q24052413-1E EDF100074\FCC ABOVE 1G\15
Memo: Sample Number:S24052413-003 Power Setting:2

Test Graph

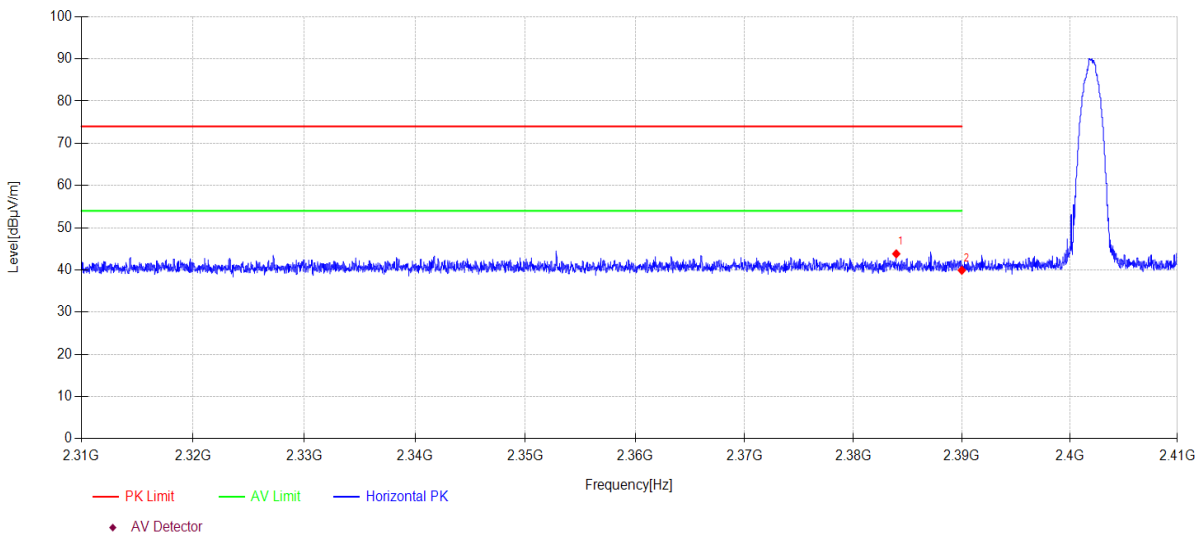

Data List										
NO.	Freq. [MHz]	Reading [dBµV/m]	Antenna Factor [dB]	Cable loss [dB]	AMP [dB]	Level [dBµV/m]	Limit [dBµV/m]	Margin [dB]	Detector	Polarity
1	2383.950	13.00	27.24	3.57	0.00	43.81	74.00	30.19	PK	Horizontal
2	2390.000	9.09	27.26	3.57	0.00	39.92	74.00	34.08	PK	Horizontal

Note:

- Level = Reading + Cable loss + Antenna Factor + AMP
- If Peak Result complies with AV limit, AV Result is deemed to comply with AV limit.
- Test setup: RBW: 1 MHz, VBW: 3 MHz, Sweep time: auto.

TR-4-E-009 Radiated Emission Test Result

Test Date: 2024-06-17 **Tested By:** Junchang Du
EUT: Multimedia Speaker **Model Number:** EDF100074
Test Mode: 2DH5 TX 2402MHz **Power Supply:** AC 120V/60Hz
Condition: Temp:21.9°C;Humi:51.0% **Test Site:** DDT 3# Chamber
File Path: d:\ts\2024 report data\Q24052413-1E EDF100074\FCC ABOVE 1G\16
Memo: Sample Number:S24052413-003 Power Setting:2

Test Graph

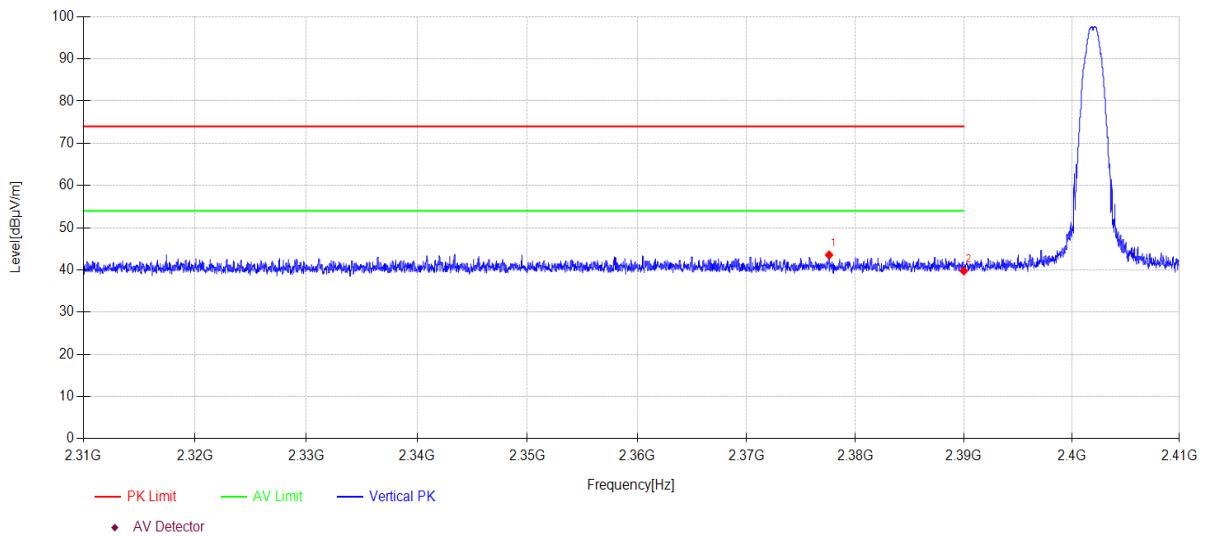

Data List										
NO.	Freq. [MHz]	Reading [dBµV/m]	Antenna Factor [dB]	Cable loss [dB]	AMP [dB]	Level [dBµV/m]	Limit [dBµV/m]	Margin [dB]	Detector	Polarity
1	2377.580	12.78	27.21	3.56	0.00	43.55	74.00	30.45	PK	Vertical
2	2390.000	8.93	27.26	3.57	0.00	39.76	74.00	34.24	PK	Vertical

Note:

- Level = Reading + Cable loss + Antenna Factor + AMP
- If Peak Result complies with AV limit, AV Result is deemed to comply with AV limit.
- Test setup: RBW: 1 MHz, VBW: 3 MHz, Sweep time: auto.

TR-4-E-009 Radiated Emission Test Result

Test Date: 2024-06-17 **Tested By:** Junchang Du
EUT: Multimedia Speaker **Model Number:** EDF100074
Test Mode: 3DH5 TX 2402MHz **Power Supply:** AC 120V/60Hz
Condition: Temp:21.9°C;Humi:51.0% **Test Site:** DDT 3# Chamber
File Path: d:\ts\2024 report data\Q24052413-1E EDF100074\FCC ABOVE 1G\17
Memo: Sample Number:S24052413-003 Power Setting:2

Test Graph

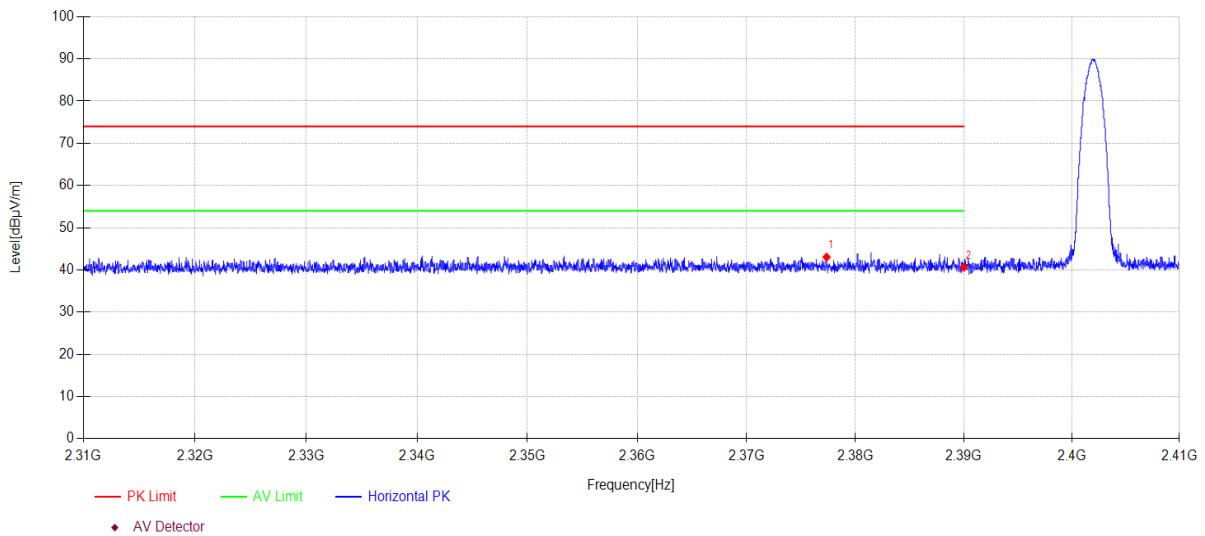

Data List										
NO.	Freq. [MHz]	Reading [dBµV/m]	Antenna Factor [dB]	Cable loss [dB]	AMP [dB]	Level [dBµV/m]	Limit [dBµV/m]	Margin [dB]	Detector	Polarity
1	2377.350	12.27	27.21	3.56	0.00	43.04	74.00	30.96	PK	Horizontal
2	2390.000	9.79	27.26	3.57	0.00	40.62	74.00	33.38	PK	Horizontal

Note:

1. Level = Reading + Cable loss + Antenna Factor + AMP
2. If Peak Result complies with AV limit, AV Result is deemed to comply with AV limit.
3. Test setup: RBW: 1 MHz, VBW: 3 MHz, Sweep time: auto.

TR-4-E-009 Radiated Emission Test Result

Test Date: 2024-06-17 **Tested By:** Junchang Du
EUT: Multimedia Speaker **Model Number:** EDF100074
Test Mode: 3DH5 TX 2402MHz **Power Supply:** AC 120V/60Hz
Condition: Temp:21.9°C;Humi:51.0% **Test Site:** DDT 3# Chamber
File Path: d:\ts\2024 report data\Q24052413-1E EDF100074\FCC ABOVE 1G\18
Memo: Sample Number:S24052413-003 Power Setting:2

Test Graph

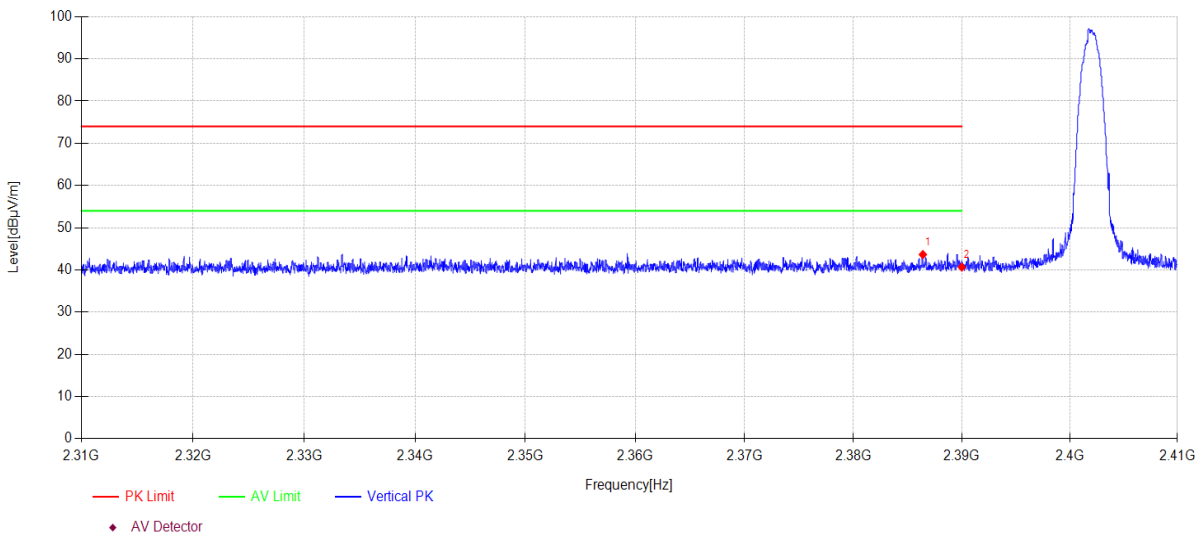

Data List										
NO.	Freq. [MHz]	Reading [dBµV/m]	Antenna Factor [dB]	Cable loss [dB]	AMP [dB]	Level [dBµV/m]	Limit [dBµV/m]	Margin [dB]	Detector	Polarity
1	2386.400	12.82	27.25	3.57	0.00	43.64	74.00	30.36	PK	Vertical
2	2390.000	9.85	27.26	3.57	0.00	40.68	74.00	33.32	PK	Vertical

Note:

- Level = Reading + Cable loss + Antenna Factor + AMP
- If Peak Result complies with AV limit, AV Result is deemed to comply with AV limit.
- Test setup: RBW: 1 MHz, VBW: 3 MHz, Sweep time: auto.

TR-4-E-009 Radiated Emission Test Result

Test Date: 2024-06-17 **Tested By:** Junchang Du
EUT: Multimedia Speaker **Model Number:** EDF100074
Test Mode: DH5 TX 2480MHz **Power Supply:** AC 120V/60Hz
Condition: Temp:21.9°C;Humi:51.0% **Test Site:** DDT 3# Chamber
File Path: d:\ts\2024 report data\Q24052413-1E EDF100074\FCC ABOVE 1G\19
Memo: Sample Number:S24052413-003 Power Setting:2

Test Graph

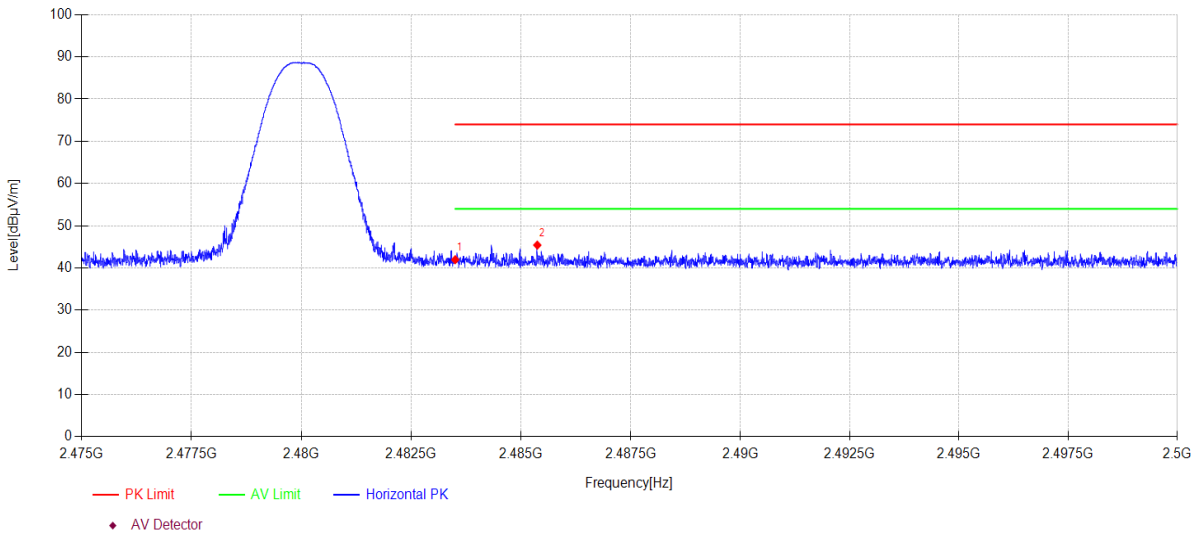

Data List										
NO.	Freq. [MHz]	Reading [dBµV/m]	Antenna Factor [dB]	Cable loss [dB]	AMP [dB]	Level [dBµV/m]	Limit [dBµV/m]	Margin [dB]	Detector	Polarity
1	2483.500	10.80	27.53	3.62	0.00	41.95	74.00	32.05	PK	Horizontal
2	2485.370	14.25	27.54	3.62	0.00	45.41	74.00	28.59	PK	Horizontal

Note:

1. Level = Reading + Cable loss + Antenna Factor + AMP
2. If Peak Result complies with AV limit, AV Result is deemed to comply with AV limit.
3. Test setup: RBW: 1 MHz, VBW: 3 MHz, Sweep time: auto.

TR-4-E-009 Radiated Emission Test Result

Test Date: 2024-06-17 **Tested By:** Junchang Du
EUT: Multimedia Speaker **Model Number:** EDF100074
Test Mode: DH5 TX 2480MHz **Power Supply:** AC 120V/60Hz
Condition: Temp:21.9°C;Humi:51.0% **Test Site:** DDT 3# Chamber
File Path: d:\ts\2024 report data\Q24052413-1E EDF100074\FCC ABOVE 1G\20
Memo: Sample Number:S24052413-003 Power Setting:2

Test Graph

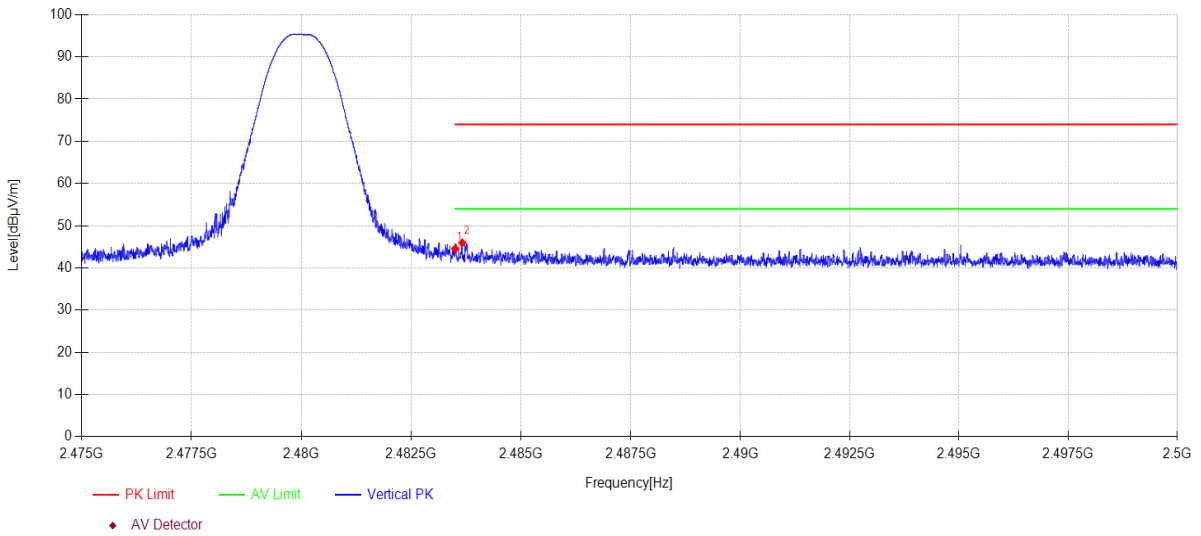

Data List										
NO.	Freq. [MHz]	Reading [dBµV/m]	Antenna Factor [dB]	Cable loss [dB]	AMP [dB]	Level [dBµV/m]	Limit [dBµV/m]	Margin [dB]	Detector	Polarity
1	2483.500	13.40	27.53	3.62	0.00	44.55	74.00	29.45	PK	Vertical
2	2483.660	14.79	27.53	3.62	0.00	45.94	74.00	28.06	PK	Vertical

Note:

1. Level = Reading + Cable loss + Antenna Factor + AMP
2. If Peak Result complies with AV limit, AV Result is deemed to comply with AV limit.
3. Test setup: RBW: 1 MHz, VBW: 3 MHz, Sweep time: auto.

TR-4-E-009 Radiated Emission Test Result

Test Date: 2024-06-17 **Tested By:** Junchang Du
EUT: Multimedia Speaker **Model Number:** EDF100074
Test Mode: 2DH5 TX 2480MHz **Power Supply:** AC 120V/60Hz
Condition: Temp:21.9°C;Humi:51.0% **Test Site:** DDT 3# Chamber
File Path: d:\ts\2024 report data\Q24052413-1E EDF100074\FCC ABOVE 1G\21
Memo: Sample Number:S24052413-003 Power Setting:2

Test Graph

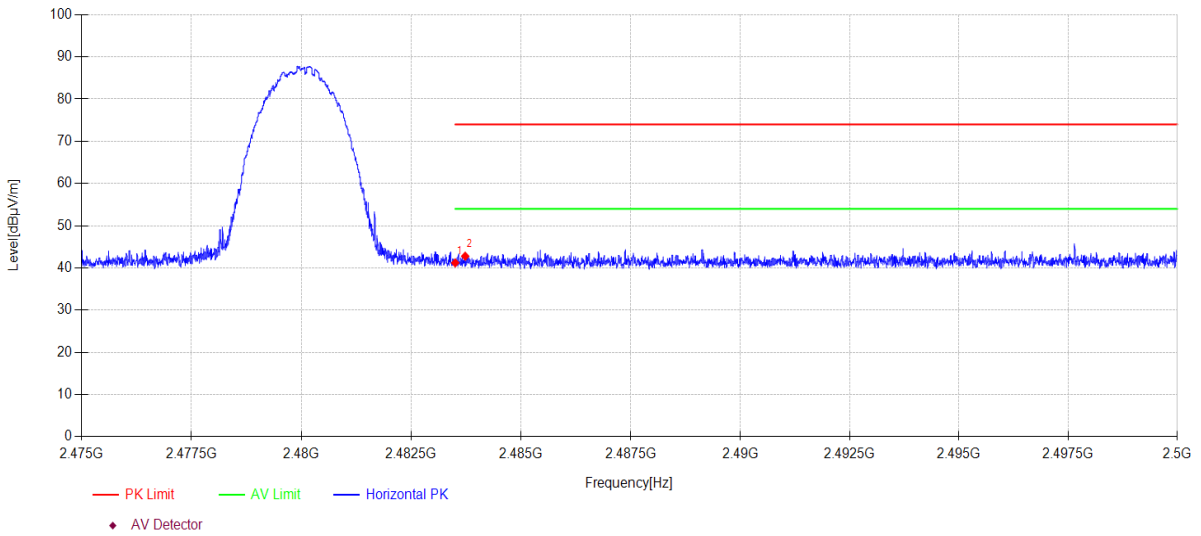

Data List										
NO.	Freq. [MHz]	Reading [dBµV/m]	Antenna Factor [dB]	Cable loss [dB]	AMP [dB]	Level [dBµV/m]	Limit [dBµV/m]	Margin [dB]	Detector	Polarity
1	2483.500	10.06	27.53	3.62	0.00	41.21	74.00	32.79	PK	Horizontal
2	2483.728	11.63	27.53	3.62	0.00	42.78	74.00	31.22	PK	Horizontal

Note:

1. Level = Reading + Cable loss + Antenna Factor + AMP
2. If Peak Result complies with AV limit, AV Result is deemed to comply with AV limit.
3. Test setup: RBW: 1 MHz, VBW: 3 MHz, Sweep time: auto.

TR-4-E-009 Radiated Emission Test Result

Test Date: 2024-06-17 **Tested By:** Junchang Du
EUT: Multimedia Speaker **Model Number:** EDF100074
Test Mode: 2DH5 TX 2480MHz **Power Supply:** AC 120V/60Hz
Condition: Temp:21.9°C;Humi:51.0% **Test Site:** DDT 3# Chamber
File Path: d:\ts\2024 report data\Q24052413-1E EDF100074\FCC ABOVE 1G\22
Memo: Sample Number:S24052413-003 Power Setting:2

Test Graph

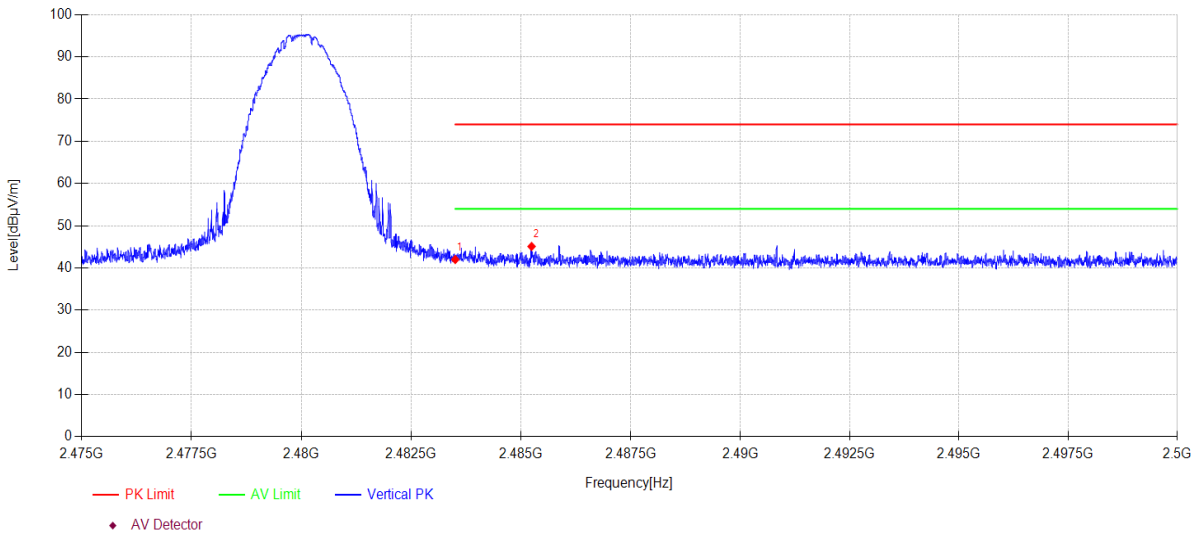

Data List										
NO.	Freq. [MHz]	Reading [dBµV/m]	Antenna Factor [dB]	Cable loss [dB]	AMP [dB]	Level [dBµV/m]	Limit [dBµV/m]	Margin [dB]	Detector	Polarity
1	2483.500	10.85	27.53	3.62	0.00	42.00	74.00	32.00	PK	Vertical
2	2485.240	13.93	27.54	3.62	0.00	45.09	74.00	28.91	PK	Vertical

Note:

1. Level = Reading + Cable loss + Antenna Factor + AMP
2. If Peak Result complies with AV limit, AV Result is deemed to comply with AV limit.
3. Test setup: RBW: 1 MHz, VBW: 3 MHz, Sweep time: auto.

TR-4-E-009 Radiated Emission Test Result

Test Date: 2024-06-17 **Tested By:** Junchang Du
EUT: Multimedia Speaker **Model Number:** EDF100074
Test Mode: 3DH5 TX 2480MHz **Power Supply:** AC 120V/60Hz
Condition: Temp:21.9°C;Humi:51.0% **Test Site:** DDT 3# Chamber
File Path: d:\ts\2024 report data\Q24052413-1E EDF100074\FCC ABOVE 1G\23
Memo: Sample Number:S24052413-003 Power Setting:2

Test Graph

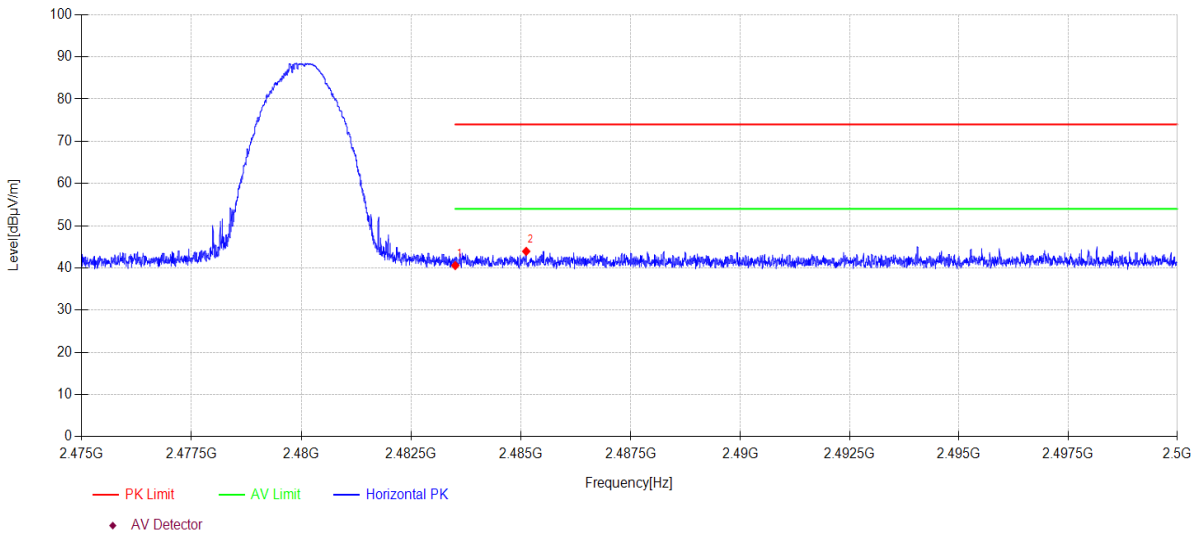

Data List										
NO.	Freq. [MHz]	Reading [dBµV/m]	Antenna Factor [dB]	Cable loss [dB]	AMP [dB]	Level [dBµV/m]	Limit [dBµV/m]	Margin [dB]	Detector	Polarity
1	2483.500	9.42	27.53	3.62	0.00	40.57	74.00	33.43	PK	Horizontal
2	2485.118	12.77	27.54	3.62	0.00	43.93	74.00	30.07	PK	Horizontal

Note:

1. Level = Reading + Cable loss + Antenna Factor + AMP
2. If Peak Result complies with AV limit, AV Result is deemed to comply with AV limit.
3. Test setup: RBW: 1 MHz, VBW: 3 MHz, Sweep time: auto.

TR-4-E-009 Radiated Emission Test Result

Test Date: 2024-06-17 **Tested By:** Junchang Du
EUT: Multimedia Speaker **Model Number:** EDF100074
Test Mode: 3DH5 TX 2480MHz **Power Supply:** AC 120V/60Hz
Condition: Temp:21.9°C;Humi:51.0% **Test Site:** DDT 3# Chamber
File Path: d:\ts\2024 report data\Q24052413-1E EDF100074\FCC ABOVE 1G\24
Memo: Sample Number:S24052413-003 Power Setting:2

Test Graph

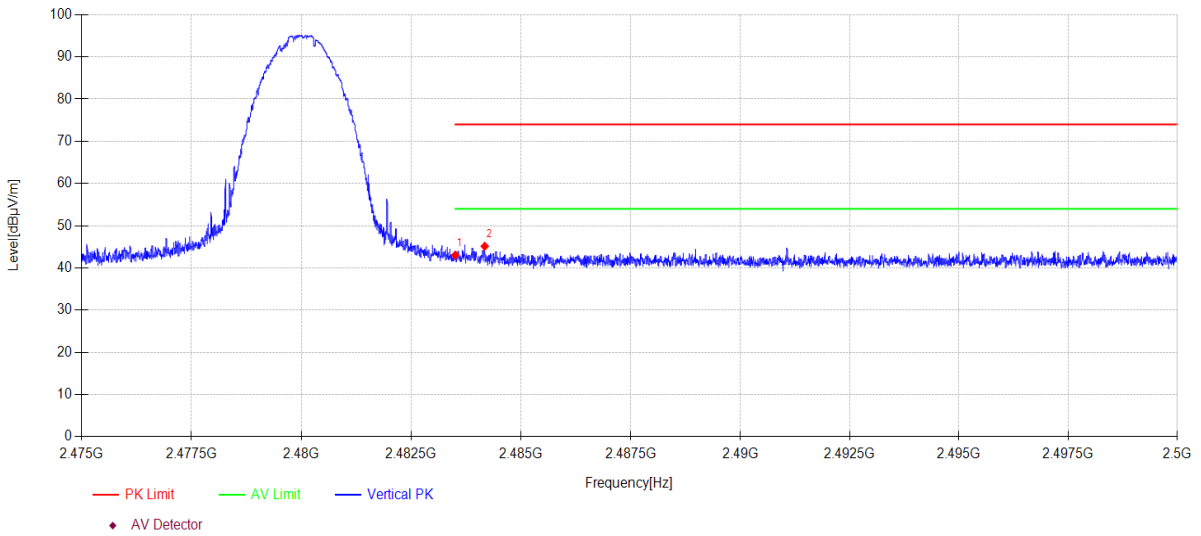

Data List										
NO.	Freq. [MHz]	Reading [dBµV/m]	Antenna Factor [dB]	Cable loss [dB]	AMP [dB]	Level [dBµV/m]	Limit [dBµV/m]	Margin [dB]	Detector	Polarity
1	2483.500	11.88	27.53	3.62	0.00	43.03	74.00	30.97	PK	Vertical
2	2484.173	13.97	27.54	3.62	0.00	45.13	74.00	28.87	PK	Vertical

Note:

1. Level = Reading + Cable loss + Antenna Factor + AMP
2. If Peak Result complies with AV limit, AV Result is deemed to comply with AV limit.
3. Test setup: RBW: 1 MHz, VBW: 3 MHz, Sweep time: auto.

16. Power Line Conducted Emissions

16.1. Test equipment

Equipment	Manufacturer	Model No.	Serial No.	Cal Due To	Cal. Interval
Conducted Radiated Software	Audix	E3	DDT-ZC00562	/	/
Three-phase artificial power network	SCHWARZBECK	NSLK 8163	DDT-ZC01572	2025/07/08	1 Year
RF Cable	Yuhu Technology	Z806-NJ-NJ-6M	DDT-ZC02004	2025/07/08	1 Year
Two Line V-Network	R&S	ENV216	DDT-ZC02056	2025/07/08	1 Year
Two Line V-Network	R&S	ENV216	DDT-ZC02059	2025/07/08	1 Year
Δ -shaped artificial power network	SCHWARZBECK	PVDC 8301	DDT-ZC03939	2025/03/31	1 Year
Pulse Limiter	SCHWARZBECK	VTSD 9561	DDT-ZC02128	2025/07/08	1 Year
EMI Test Receiver	R&S	ESCI/E3	DDT-ZC01297	2025/07/08	1 Year

16.2. Block diagram of test setup

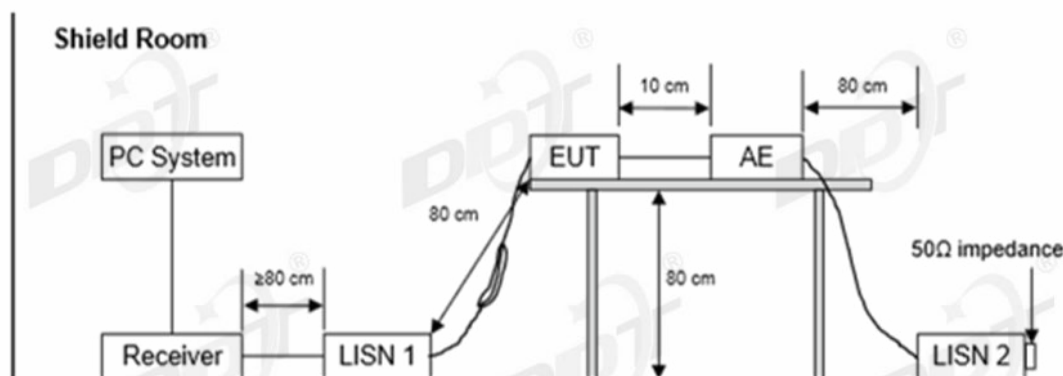

16.3. Limits

Frequency	Quasi-Peak Level dB(mV)	Average Level dB(mV)
150 kHz~500 kHz	66 ~ 56*	56 ~ 46*
500 kHz~5 MHz	56	46
5 MHz~30 MHz	60	50

Note 1: * Decreasing linearly with logarithm of frequency.

Note 2: The lower limit shall apply at the transition frequencies.

16.4. Assistant equipment used for test

Assistant equipment	Manufacturer	Model number	Description	other
/	/	/	/	/

16.5. Test procedure

The EUT and Support equipment, if needed, were put placed on a non-metallic table, 80cm above the ground plane.

All support equipment power received from a second LISN.

Emissions were measured on each current carrying line of the EUT using an EMI Test Receiver connected to the LISN powering the EUT.

The Receiver scanned from 150 kHz to 30 MHz for emissions in each of the test modes.

During the above scans, the emissions were maximized by cable manipulation.

The test mode(s) described in clause 2.4 were scanned during the preliminary test.

After the preliminary scan, we found the test mode producing the highest emission level.

The EUT configuration and worse cable configuration of the above highest emission levels were recorded for reference of the final test.

EUT and support equipment were set up on the test bench as per the configuration with highest emission level in the preliminary test.

A scan was taken on both power lines, Neutral and Line, recording at least the six highest emissions.

Emission frequency and amplitude were recorded into a computer in which correction factors were used to calculate the emission level and compare reading to the applicable limit.

The test data of the worst-case condition(s) was recorded.

The bandwidth of test receiver is set at 9 kHz.

16.6. Test result

PASS. (See below detailed test result)

Note1: All emissions not reported below are too low against the prescribed limits.

Note2: “----” means Peak detection; “-----” means Average detection.

Note3: Pre-test AC conducted emission at both voltage AC 120V/60Hz and AC 240V/50Hz, recorded the worst case.

16.7. Test data

TR-4-E-010 Conducted Emission Test Result

Test Site	: DDT 6# Shield Room	D:\2024 Report Date\Q24052413-1E\0629 CE.EM6	
Test Date	: 2024-06-29	Tested By	: Antony Zeng
EUT	: Multimedia Speaker	Model Number	: EDF100074
Power Supply	: AC 120V/60Hz	Test Mode	: BT mode
Condition	: Temp:21.9°C,Humi:56.2%	LISN	: 2023 ENV 216 3#/LINE
Memo	:		

Data: 10

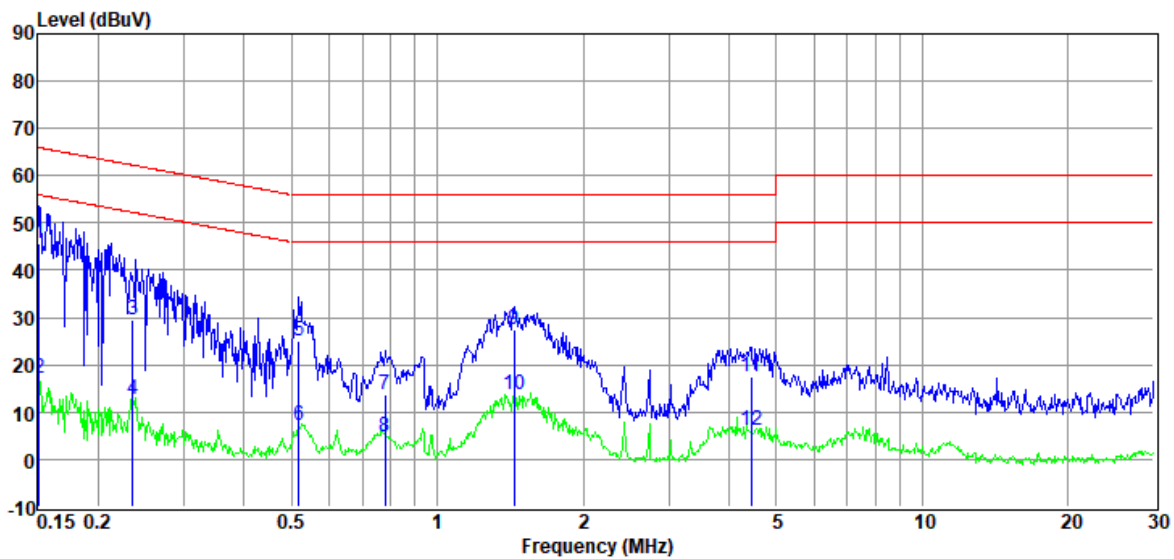

Item (Mark)	Freq. (MHz)	Read Level (dBμV)	LISN Factor (dB)	Cable Loss (dB)	Pulse Limiter Factor (dB)	Result Level (dBμV)	Limit Line (dBμV)	Over Limit (dB)	Detector	Phase
1	0.15	25.90	9.88	0.10	9.94	45.82	65.96	-20.14	QP	LINE
2	0.15	-2.80	9.88	0.10	9.94	17.12	55.96	-38.84	Average	LINE
3	0.24	9.77	9.75	0.11	9.94	29.57	62.26	-32.69	QP	LINE
4	0.24	-7.26	9.75	0.11	9.94	12.54	52.26	-39.72	Average	LINE
5	0.52	5.48	9.63	0.13	9.96	25.20	56.00	-30.80	QP	LINE
6	0.52	-12.41	9.63	0.13	9.96	7.31	46.00	-38.69	Average	LINE
7	0.78	-6.43	9.94	0.17	9.97	13.65	56.00	-42.35	QP	LINE
8	0.78	-15.22	9.94	0.17	9.97	4.86	46.00	-41.14	Average	LINE
9	1.44	7.79	9.46	0.25	9.98	27.48	56.00	-28.52	QP	LINE
10	1.44	-5.83	9.46	0.25	9.98	13.86	46.00	-32.14	Average	LINE
11	4.43	-2.47	9.81	0.27	10.02	17.63	56.00	-38.37	QP	LINE
12	4.43	-13.93	9.81	0.27	10.02	6.17	46.00	-39.83	Average	LINE

Note: 1. Result Level = Read Level + LISN Factor + Pulse Limiter Factor + Cable loss.
 2. If QP Result complies with AV limit, AV Result is deemed to comply with AV limit.
 3. Test setup: RBW: 200 Hz (9 kHz—150 kHz), 9 kHz (150 kHz—30 MHz).
 4. Step size: 80Hz (0.009MHz-0.15MHz), 4 kHz (0.15MHz-30MHz), Scan time: auto.

TR-4-E-010 Conducted Emission Test Result

Test Site	: DDT 6# Shield Room	D:\2024 Report Date\Q24052413-1E\0629 CE.EM6	
Test Date	: 2024-06-29	Tested By	: Antony Zeng
EUT	: Multimedia Speaker	Model Number	: EDF100074
Power Supply	: AC 120V/60Hz	Test Mode	: BT mode
Condition	: Temp:21.9°C,Humi:56.2%	LISN	: 2023 ENV 216 3#/NEUTRAL
Memo	:		

Data: 12

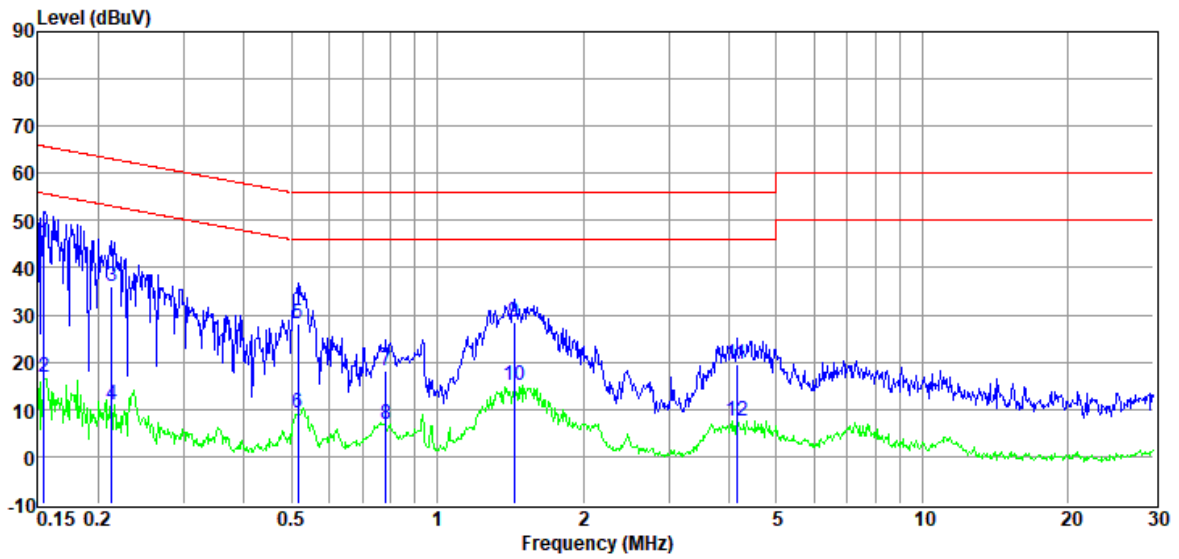

Item (Mark)	Freq. (MHz)	Read Level (dBμV)	LISN Factor (dB)	Cable Loss (dB)	Pulse Limiter Factor (dB)	Result Level (dBμV)	Limit Line (dBμV)	Over Limit (dB)	Detector	Phase
1	0.15	25.61	9.80	0.10	9.94	45.45	65.74	-20.29	QP	NEUTRAL
2	0.15	-3.07	9.80	0.10	9.94	16.77	55.74	-38.97	Average	NEUTRAL
3	0.21	15.99	9.92	0.11	9.94	35.96	63.10	-27.14	QP	NEUTRAL
4	0.21	-9.02	9.92	0.11	9.94	10.95	53.10	-42.15	Average	NEUTRAL
5	0.52	8.38	9.80	0.13	9.96	28.27	56.00	-27.73	QP	NEUTRAL
6	0.52	-10.77	9.80	0.13	9.96	9.12	46.00	-36.88	Average	NEUTRAL
7	0.78	-2.02	9.91	0.17	9.97	18.03	56.00	-37.97	QP	NEUTRAL
8	0.78	-13.29	9.91	0.17	9.97	6.76	46.00	-39.24	Average	NEUTRAL
9	1.44	8.43	9.93	0.25	9.98	28.59	56.00	-27.41	QP	NEUTRAL
10	1.44	-5.23	9.93	0.25	9.98	14.93	46.00	-31.07	Average	NEUTRAL
11	4.14	-0.43	9.56	0.27	10.01	19.41	56.00	-36.59	QP	NEUTRAL
12	4.14	-12.42	9.56	0.27	10.01	7.42	46.00	-38.58	Average	NEUTRAL

- Note: 1. Result Level = Read Level + LISN Factor + Pulse Limiter Factor + Cable loss.
 2. If QP Result complies with AV limit, AV Result is deemed to comply with AV limit.
 3. Test setup: RBW: 200 Hz (9 kHz—150 kHz), 9 kHz (150 kHz—30 MHz).
 4. Step size: 80Hz (0.009MHz-0.15MHz), 4 kHz (0.15MHz-30MHz), Scan time: auto.

17. Test Setup Photograph



18. Photos of the EUT

Please refer to appendix I

-----End Report-----