



FCC AND ISED CERTIFICATION TEST REPORT

Applicant	:	Edifier International Limited
Address of Applicant	:	P. O. Box 6264 General Post Office Hong Kong
Manufacturer	:	Beijing Edifier Technology Co., Ltd.
Address of Manufacturer	:	815, Floor 8, Shuangqiao Building, No.68, North Fourth Ring West Road, Haidian District, Beijing 100080, P.R.China
Equipment under Test	:	Active Speaker
Model No.	:	EDF100078
FCC ID	:	Z9G-EDF219
IC	:	10004A-EDF219
Test Standard(s)	:	FCC Rules and Regulations Part 15 Subpart E, RSS-247 Issue 3 August 2023, ANSI C63.10:2013, 789033 D02 General U-NII Test Procedures New Rules v02r01, RSS-Gen Issue 5 April 2018
Report No.	:	DDT-RE23103011-2E03
Issue Date	:	2023/12/04
Issue By	:	Guangdong Dongdian Testing Service Co., Ltd.
Address of Laboratory	:	Unit 2, Building 1, No. 17, Zongbu 2nd Road, Songshan Lake Park, Dongguan, Guangdong, China, 523808

REPORT

Table of Contents

	Test report declares.....	4
1.	Summary of Test Results.....	6
2.	General Test Information	7
2.1.	Description of EUT	7
2.2.	Accessories of EUT.....	9
2.3.	Assistant equipment used for test.....	9
2.4.	Block diagram of EUT configuration for test	10
2.5.	Deviations of test standard.....	10
2.6.	Test environment conditions	10
2.7.	Test laboratory	10
2.8.	Measurement uncertainty.....	11
3.	Equipment Used During Conductive Test.....	12
4.	Occupied Channel Bandwidth.....	13
4.1.	Block diagram of test setup.....	13
4.2.	Limits	13
4.3.	Test procedure	13
4.4.	Test result.....	13
4.5.	Test Graphs.....	14
5.	6dB Bandwidth	16
5.1.	Block diagram of test setup.....	16
5.2.	Limits	16
5.3.	Test procedure	16
5.4.	Test Result B4.....	16
5.5.	Test Graphs B4	17
6.	Duty Cycle	19
6.1.	Block diagram of test setup.....	19
6.2.	Limit	19
6.3.	Test procedure	19
6.4.	Test Result	19
6.5.	Test Graphs.....	20
7.	Maximum Output Power.....	22
7.1.	Block diagram of test setup.....	22
7.2.	Limits	22
7.3.	Test procedure	22
7.4.	Test result channel power	22
8.	Power Spectral Density.....	23
8.1.	Block diagram of test setup.....	23

8.2.	Limits	23
8.3.	Test procedure	23
8.4.	Test Result	24
8.5.	Test Graphs.....	25
9.	Frequency Stability Measurement	27
9.1.	Limit of Frequency Stability	27
9.2.	Measuring Instruments.....	27
9.3.	Test procedures	27
9.4.	Test setup.....	27
9.5.	Test Result	28
10.	Emissions in Restricted Frequency Bands	29
10.1.	Test equipment.....	29
10.2.	Block diagram of test setup.....	29
10.3.	Limit	31
10.4.	Test Procedure.....	33
10.5.	Test result.....	34
11.	Band Edge Compliance	53
11.1.	Test equipment.....	53
11.2.	Block diagram of test setup.....	53
11.3.	Limit	53
11.4.	Test Procedure.....	54
11.5.	Test result.....	54
12.	Power Line Conducted Emission	67
12.1.	Test equipment.....	67
12.2.	Block diagram of test setup.....	67
12.3.	Power Line Conducted Emission Limits	67
12.4.	Test Procedure.....	67
12.5.	Test Result	68
13.	Antenna Requirements	71
13.1.	Limit	71
13.2.	Result	71
14.	Test Setup Photograph	72
15.	Photos of the EUT	76

Test Report Declare

Applicant	:	Edifier International Limited
Address of Applicant	:	P. O. Box 6264 General Post Office Hong Kong
Equipment under Test	:	Active Speaker
Model No.	:	EDF100078
Manufacturer	:	Beijing Edifier Technology Co., Ltd.
Address of Manufacturer	:	815, Floor 8, Shuangqiao Building, No.68, North Fourth Ring West Road, Haidian District, Beijing 100080, P.R.China

Test Standard Used:

FCC Rules and Regulations Part 15 Subpart E, RSS-247 Issue 3 August 2023.

Test procedure used:

ANSI C63.10:2013, 789033 D02 General U-NII Test Procedures New Rules v02r01, RSS-Gen Issue 5 April 2018

We Declare:

The equipment described above is tested by Guangdong Dongdian Testing Service Co., Ltd. and in the configuration tested the equipment complied with the standards specified above. The test results are contained in this test report and Guangdong Dongdian Testing Service Co., Ltd. is assumed of full responsibility for the accuracy and completeness of these tests.

After test and evaluation, our opinion is that the equipment provided for test compliance with the requirement of the above standards.

Report No.:	DDT-RE23103011-2E03		
Date of Receipt:	2023/11/04	Date of Test:	2023/11/04-2023/12/04

Prepared By:

Approved By:

Johnson Huang

Johnson Huang /Engineer

Damon Hu

Damon Hu/EMC Manager

Note: This report applies to above tested sample only. This report shall not be reproduced in parts without written approval of Guangdong Dongdian Testing Service Co., Ltd.

Revision History

Rev.	Revisions	Issue Date	Revised By
---	Initial issue	2023/12/04	

1. Summary of Test Results

The EUT have been tested according to the applicable standards as referenced below.

Description of Test Item	Standard	Results
6 Bandwidth and 99% Bandwidth	FCC 15.407 (e) RSS-247 Clause 6.2	PASS
Maximum Conducted Output Power	FCC 15.407 (a) RSS-247 Clause 6.2	PASS
Power Spectral Density	FCC 15.407 (a) RSS-247 Clause 6.2	PASS
Frequency Stability Measurement	FCC 15.407 (g) RSS-247 Clause 6.2 RSS-GEN Clause 8.9	PASS
Emissions in restricted frequency bands	FCC 15.407 (b) FCC 15.209 FCC 15.205 RSS-247 Clause 6.2 RSS-GEN Clause 8.9	PASS
Band Edge Compliance	FCC 15.407 (b) FCC 15.209 FCC 15.205 RSS-247 Clause 6.2 RSS-GEN Clause 8.9	PASS
Power Line Conducted Emission	FCC 15.207 RSS-GEN Clause 8.8	PASS
Antenna requirement	FCC 15.203 RSS-GEN Clause 8.3	PASS

2. General Test Information

2.1. Description of EUT

EUT Name	: Active Speaker
Model Number	: EDF100078
EUT function description	: Please reference user manual of this device
Power Supply	: 100-240V~ 50/60Hz
Radio Technology	: Bluetooth (BR/EDR/LE),5.8GHz Wireless
Operation frequency	: Bluetooth (BR/EDR/LE):2402 MHz-2480 MHz 5.8GHz Wireless :5729MHz-5845MHz
Modulation	: Bluetooth BR/EDR: GFSK, $\pi/4$ -DQPSK, 8DPSK Bluetooth LE: GFSK 5.8GHz Wireless: FSK
Antenna Type	: Antenna 1: Integral antenna, Maximum PK gain: 3.49 dBi Antenna 2: Integral antenna, Maximum PK gain: 3.49 dBi

Note 1: EUT is the abbreviation of equipment under test.

Note 2: “☑” means to be chosen or applicable; “☐” means don't to be chosen or not applicable; This note applies to entire report.

Note 3: This report only for 5.8GHz Wireless

Channel information					
Channel	Frequency (MHz)	Channel	Frequency (MHz)	Channel	Frequency (MHz)
0	5729	20	5769	40	5809
1	5731	21	5771	41	5811
2	5733	22	5773	42	5813
3	5735	23	5775	43	5815
4	5737	24	5777	44	5817
5	5739	25	5779	45	5819
6	5741	26	5781	46	5821
7	5743	27	5783	47	5823
8	5745	28	5785	48	5825
9	5747	29	5787	49	5827
10	5749	30	5789	50	5829
11	5751	31	5791	51	5831
12	5753	32	5793	52	5833
13	5755	33	5795	53	5835
14	5757	34	5797	54	5837
15	5759	35	5799	55	5839
16	5761	36	5801	56	5841
17	5763	37	5803	57	5843
18	5765	38	5805	58	5845
19	5767	39	5807		

2.2. Accessories of EUT

Description of Accessories	Manufacturer	Model number	Description	Remark
N/A	N/A	N/A	N/A	N/A

2.3. Assistant equipment used for test

Assistant equipment	Manufacturer	Model number	EMC Compliance	SN
N/A	N/A	N/A	N/A	N/A

2.4. Block diagram of EUT configuration for test



Test software: EMI_Tool_V27_EverestekInc

The test software was used to control EUT work in Continuous Tx mode, and select test channel, wireless mode as below table.

The pathloss of external cable: 2 dB (According to the manufacturer's claims)

Tested mode, channel, information			
Mode	Setting Tx Power	Channel	Frequency (MHz)
Tx mode	5	CH0 to CH58	5729 to 5845

2.5. Deviations of test standard

No Deviation.

2.6. Test environment conditions

Temperature range:	+15°C to +35 °C
Humidity range:	20% to 75%
Pressure range:	86 kPa to 106 kPa

2.7. Test laboratory

Guangdong Dongdian Testing Service Co., Ltd.

Add.: Unit 2, Building 1, No. 17, Zongbu 2nd Road, Songshan Lake Park, Dongguan, Guangdong, China, 523808

Tel.: +86-0769-38826678, <http://www.dgddt.com>, Email: ddt@dgddt.com

CNAS Accreditation No. L6451; A2LA Accreditation Number: 3870.01

FCC Designation Number: CN1182, Test Firm Registration Number: 540522

Innovation, Science and Economic Development Canada Site Registration Number: 10288A

Conformity Assessment Body identifier: CN0048

VCCI facility registration number: C-20087, T-20088, R-20123, R-20155, G-20118

2.8. Measurement uncertainty

Test Item	Uncertainty
Bandwidth	1.1%
Peak Output Power (Conducted) (Spectrum analyzer)	0.86 dB (10 MHz ≤ f < 3.6 GHz);
	1.38 dB (3.6 GHz ≤ f < 8 GHz)
Peak Output Power (Conducted) (Power Sensor)	0.74 dB
Power Spectral Density	0.74 dB (10 MHz ≤ f < 3.6 GHz);
	1.38 dB (3.6 GHz ≤ f < 8 GHz)
Frequencies Stability	6.7 x 10 ⁻⁸ (Antenna couple method)
	5.5 x 10 ⁻⁸ (Conducted method)
Conducted spurious emissions	0.86 dB (10 MHz ≤ f < 3.6 GHz);
	1.40 dB (3.6 GHz ≤ f < 8 GHz)
	1.66 dB (8 GHz ≤ f < 26.5 GHz)
Uncertainty for radio frequency (RBW < 20 kHz)	3x10 ⁻⁸
Temperature	0.4 °C
Humidity	2 %
Uncertainty for Radiation Emission test (9 kHz – 30 MHz)	3.44 dB
Uncertainty for Radiation Emission test (30 MHz - 1 GHz)	4.70 dB (Antenna Polarize: V)
	4.84 dB (Antenna Polarize: H)
Uncertainty for Radiation Emission test (1 GHz - 40 GHz)	4.10 dB (1 - 6 GHz)
	4.40 dB (6 GHz - 18 GHz)
	3.54 dB (18 GHz - 26 GHz)
	4.30 dB (26 GHz - 40 GHz)
Uncertainty for Power line conduction emission test	3.34dB (150KHz-30MHz)
	3.72dB (9KHz-150KHz)
Note: This uncertainty represents an expanded uncertainty expressed at approximately the 95% confidence level using a coverage factor of k=2.	

3. Equipment Used During Conductive Test

Equipment	Manufacturer	Model No.	Serial Number	Due Date
☑RF Connected Test (RF Measurement System 3#)				
SIGNAL ANALYZER	R&S	FSV40	101407	2024/07/11
Wideband Radio Communication Tester	R&S	CMW500	117491	2024/04/26
EXG Analog Signal Generator	KEYSIGHT	N5173B	MY62153058	2024/07/11
MXG Vector Signal Generator	Agilent	N5182A	MY48180912	2024/04/22
RF Control Unit	Tonscend	JS0806-2	20C8060230	2024/04/26
TEMP&HUMI Programmable Chamber	ZHIXIANG	ZXGDJS-150L	ZX170110-A	2024/05/14
Test Software	Tonscend	JS1120-3	Ver.3.2.22	N/A

4. Occupied Channel Bandwidth

4.1. Block diagram of test setup

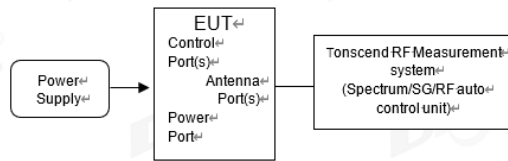

4.2. Limits

No limit requirement.

4.3. Test procedure

- (1) The test according to ANSI C63.10-2013 clause 6.9.3.
- (2) Connect EUT's antenna output to spectrum analyzer by RF cable, the path loss was compensated to the results
- (3) Set the EUT as maximum power setting and enable the EUT transmit continuously
- (4) Set the spectrum analyzer as follows:

RBW:	1% to 5% of the OBW
VBW:	approximately three times RBW
Span:	between 1.5 times and 5.0 times the OBW
Detector Mode:	Peak
Sweep time:	Auto
Trace mode:	Max hold

- (5) Measure and record the results in the report.

4.4. Test result

TestMode	Antenna	Frequency[MHz]	OCB [MHz]	FL[MHz]	FH[MHz]	Limit[MHz]	Verdict
SRD	Ant1	5729	2.368	5727.8511	5730.2188	---	---
	Ant2	5729	2.418	5727.7812	5730.1988	---	---
	Ant1	5787	2.408	5785.8112	5788.2188	---	---
	Ant2	5787	2.438	5785.7712	5788.2088	---	---
	Ant1	5845	2.448	5843.7313	5846.1788	---	---
	Ant2	5845	2.398	5843.7313	5846.1289	---	---

4.5. Test Graphs

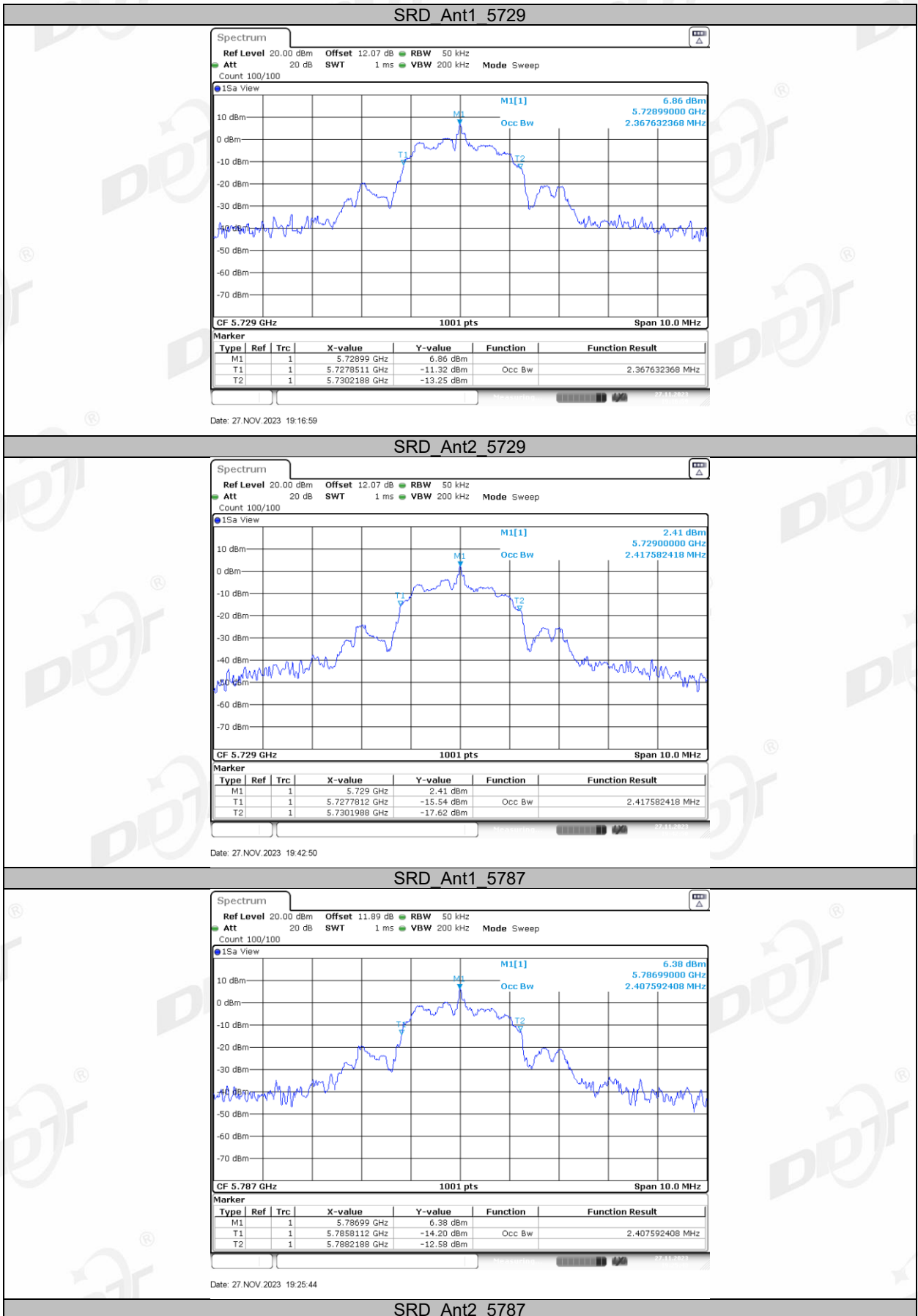

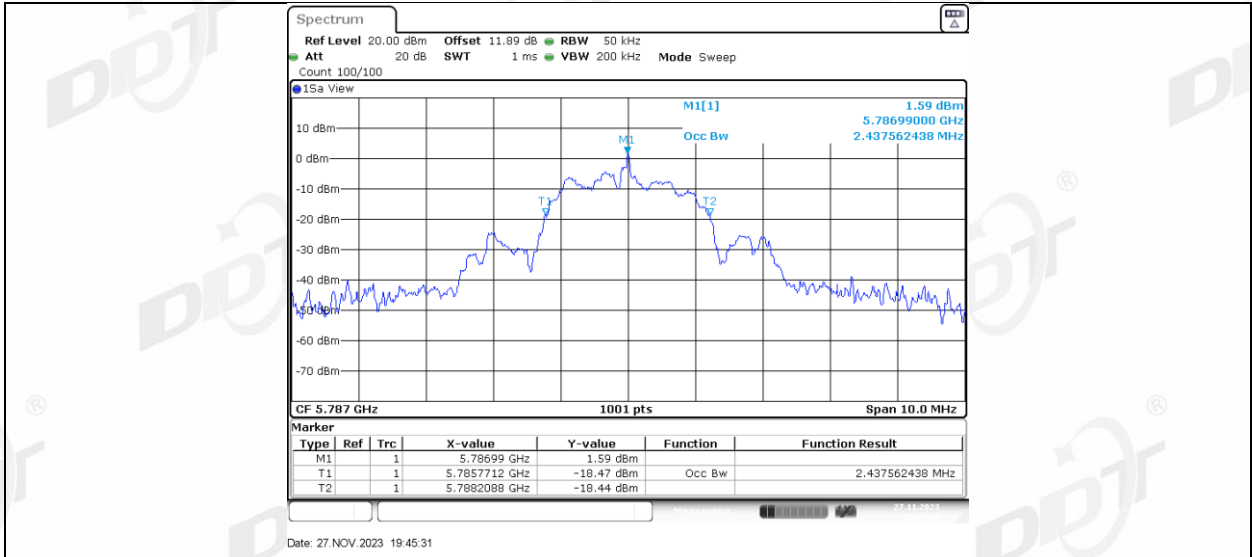

SRD Ant1 5845

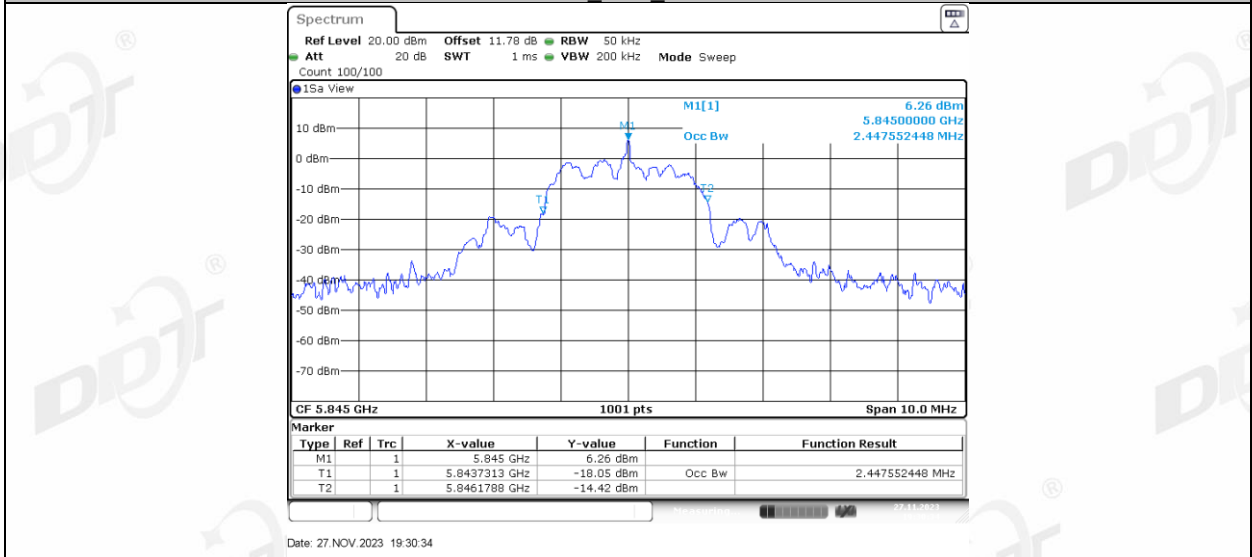

SRD Ant2 5845

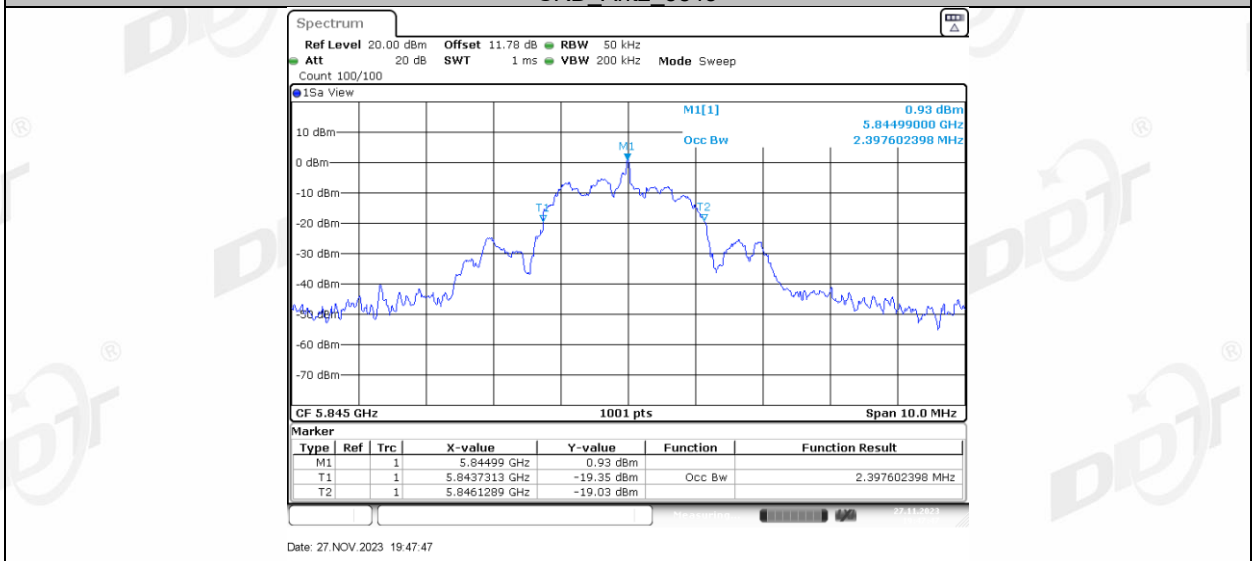

5. 6dB Bandwidth

5.1. Block diagram of test setup

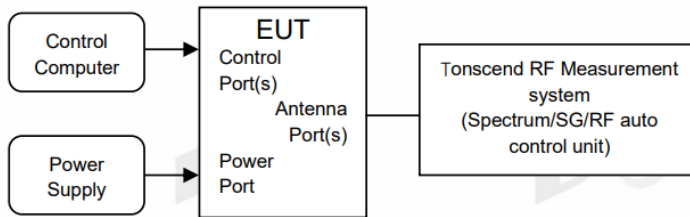

5.2. Limits

FCC Part15, Subpart E, RSS-247		
Test Item	Limit	Frequency Range (MHz)
6 dB Bandwidth	Minimum 500 kHz	5725 - 5850

5.3. Test procedure

Connect EUT's antenna output to spectrum analyzer by RF cable.

Center Frequency	The center frequency of the channel under test
Detector	Peak
RBW	100 kHz
VBW	300 kHz
Trace	Max hold
Sweep	Auto couple

Allow the trace to stabilize, measure the maximum width of the emission that is constrained by the frequencies associated with the two outermost amplitude points (upper and lower frequencies) that are attenuated by 6 dB relative to the maximum level measured in the fundamental emission.

5.4. Test Result B4

TestMode	Antenna	Frequency[MHz]	6db EBW [MHz]	FL[MHz]	FH[MHz]	Limit[MHz]	Verdict
SRD	Ant1	5729	1.63	5728.11	5729.74	0.5	PASS
	Ant2	5729	1.11	5728.56	5729.67	0.5	PASS
	Ant1	5787	1.59	5786.11	5787.70	0.5	PASS
	Ant2	5787	1.55	5786.10	5787.65	0.5	PASS
	Ant1	5845	1.67	5844.02	5845.69	0.5	PASS
	Ant2	5845	1.60	5844.04	5845.64	0.5	PASS

5.5. Test Graphs B4

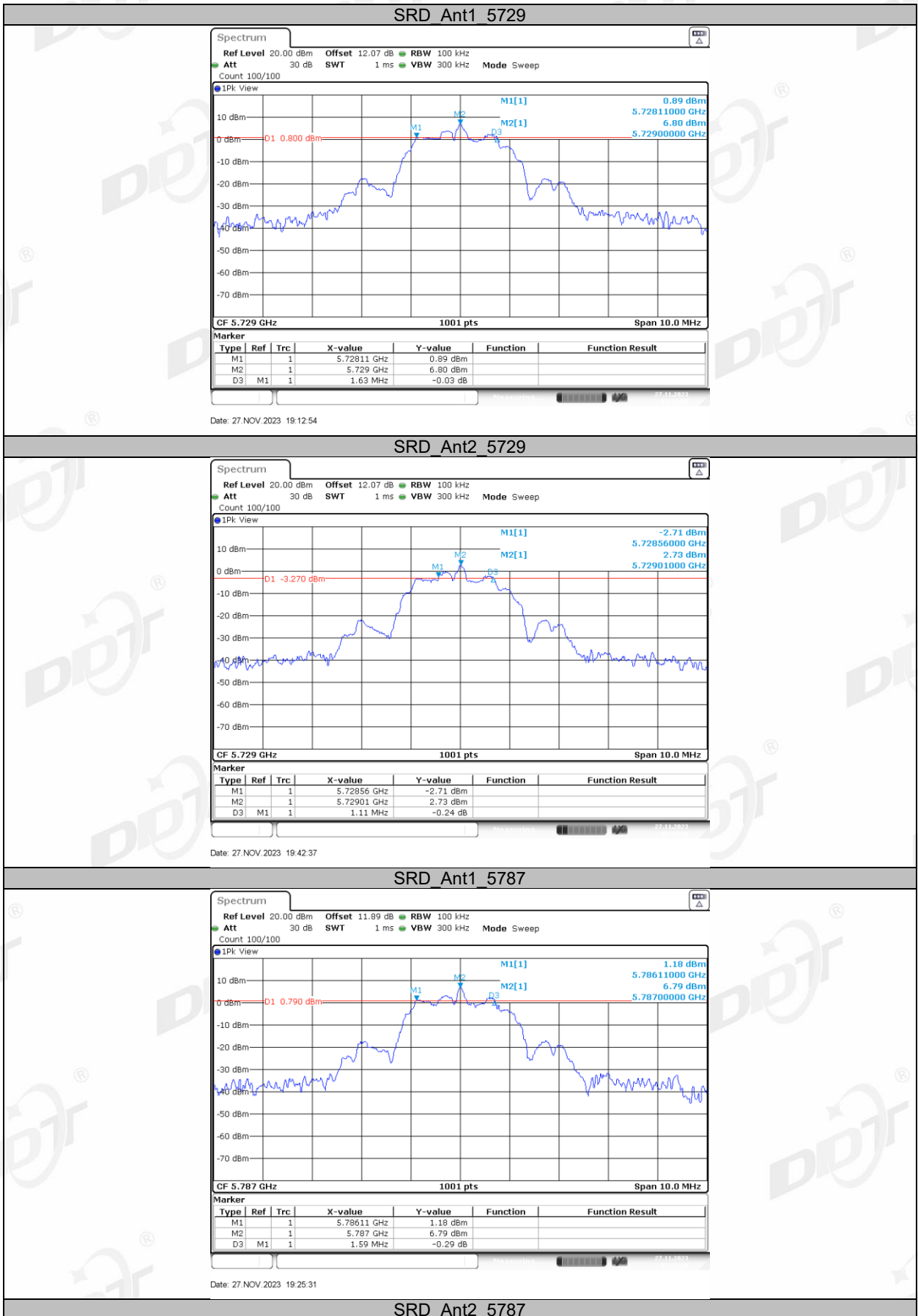

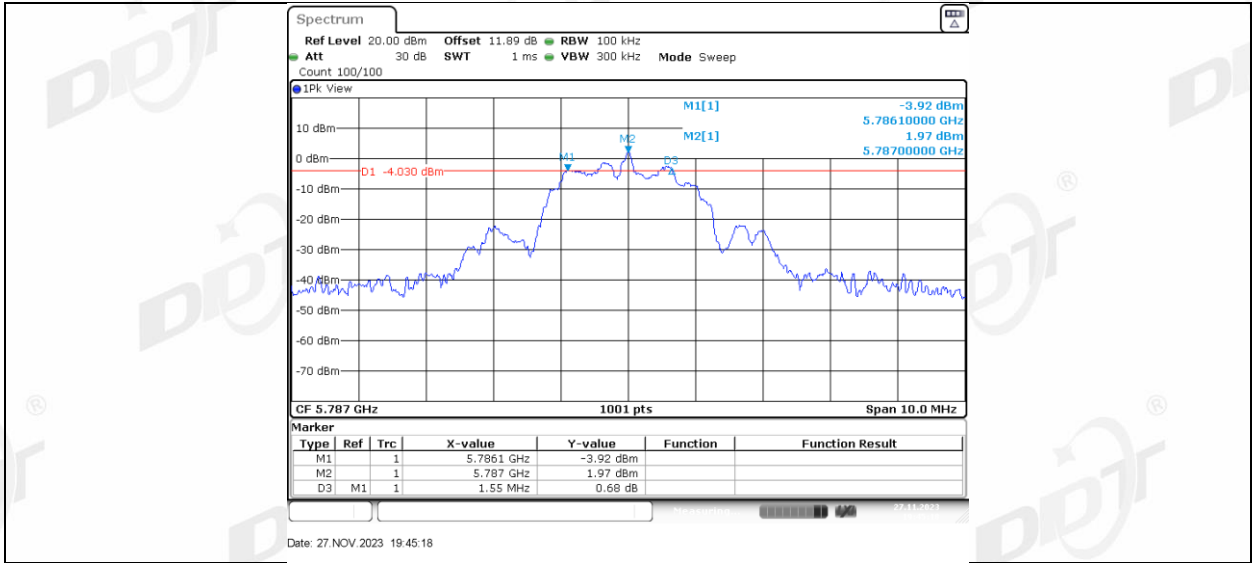

SRD Ant1 5845

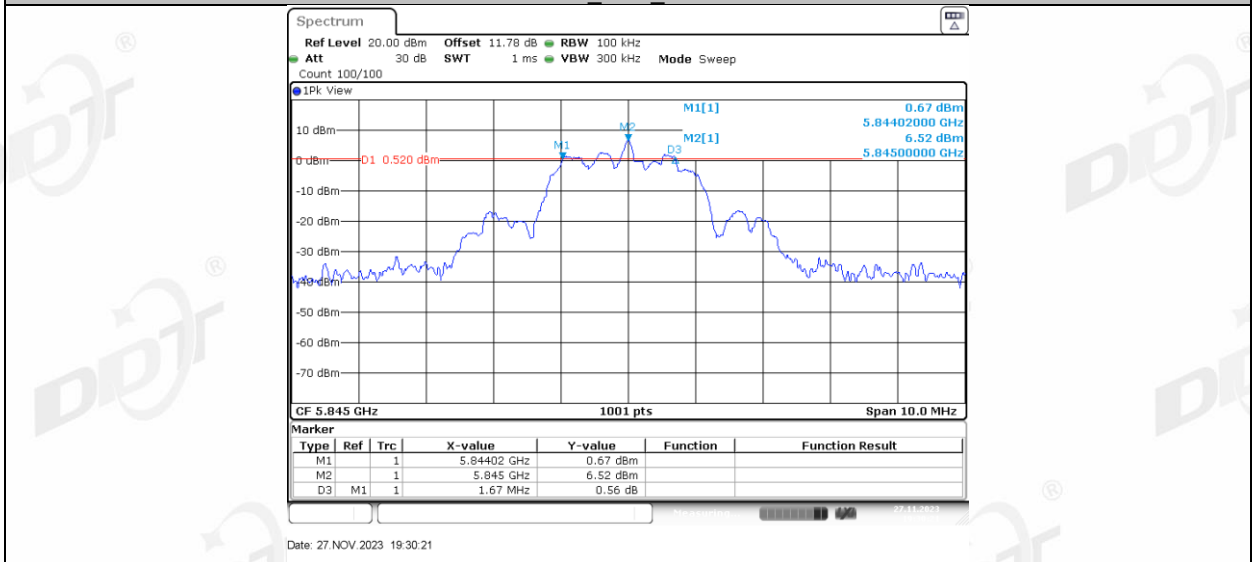

SRD Ant2 5845

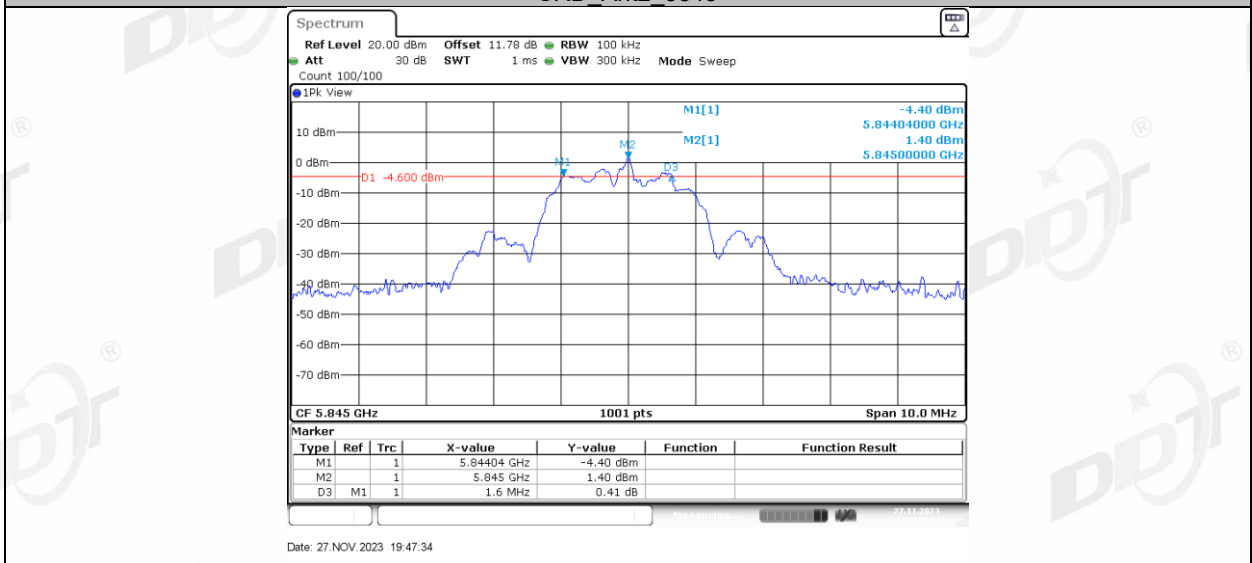

6. Duty Cycle

6.1. Block diagram of test setup

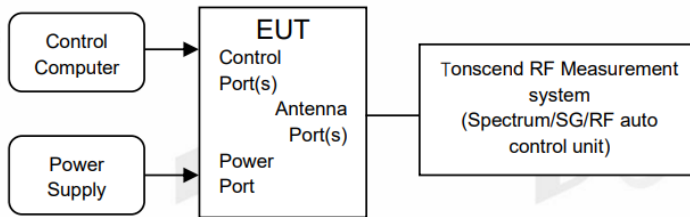

6.2. Limit

Just for Report.

6.3. Test procedure

(1) Connected the EUT's antenna port to the Spectrum Analyzer by suitable attenuator, The cable loss and attenuator loss have been put into spectrum analyzer as amplitude offset.

set the Spectrum Analyzer as below:

Centre Frequency: The centre frequency of the middle hopping channel.

Resolution BW: 10 MHz.

Video BW: 10 MHz.

Span: Zero span.

Detector: Peak.

Trace Mode: Clear Write.

Sweep: Video Trigger

(2) When the trace is complete, measure the sending time of 1 burst and the duty cycle of 1 burst cycle.

(3) Calculate dwell time follow below formula:

Duty cycle= Pulse's on time / Burst cycle

6.4. Test Result

TestMode	Antenna	Frequency[MHz]	Transmission Duration [ms]	Transmission Period [ms]	Duty Cycle [%]
SRD	Ant1	5729	2.80	18.02	15.54
	Ant2	5729	2.80	18.02	15.54
	Ant1	5787	2.82	18.02	15.65
	Ant2	5787	2.82	18.02	15.65
	Ant1	5845	2.82	18.02	15.65
	Ant2	5845	2.82	18.02	15.65

6.5. Test Graphs



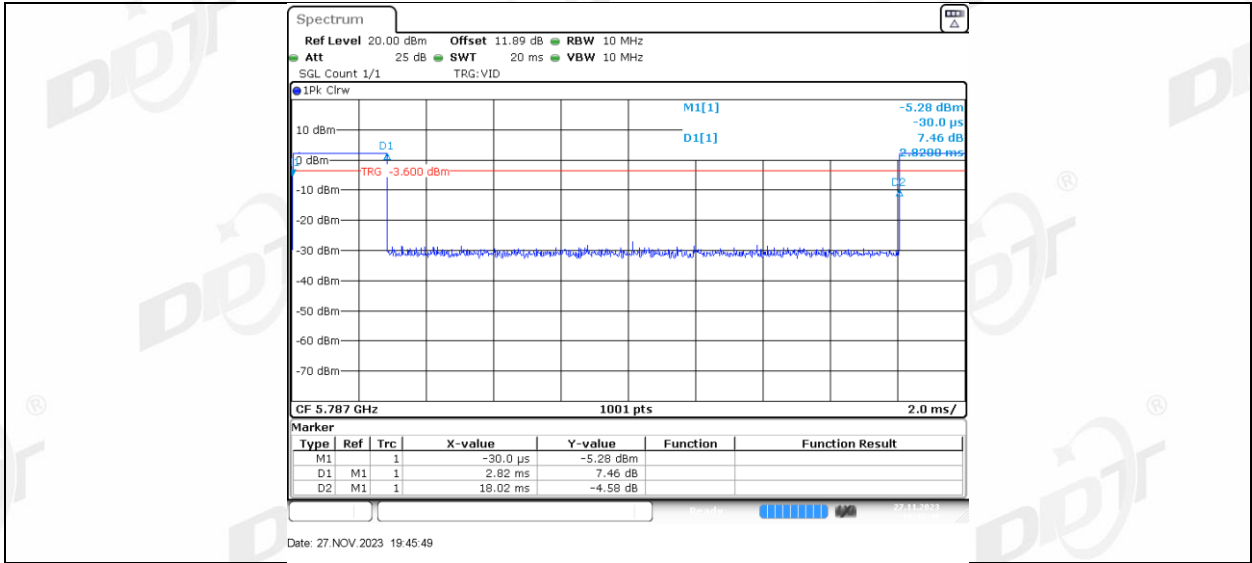

SRD Ant1 5845

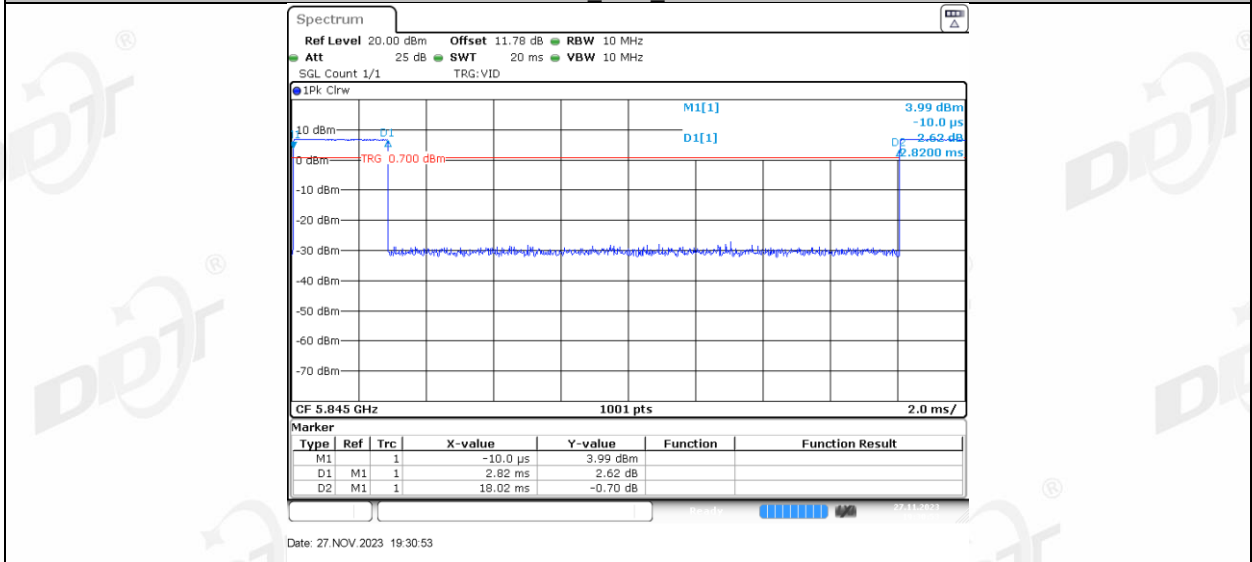

SRD Ant2 5845

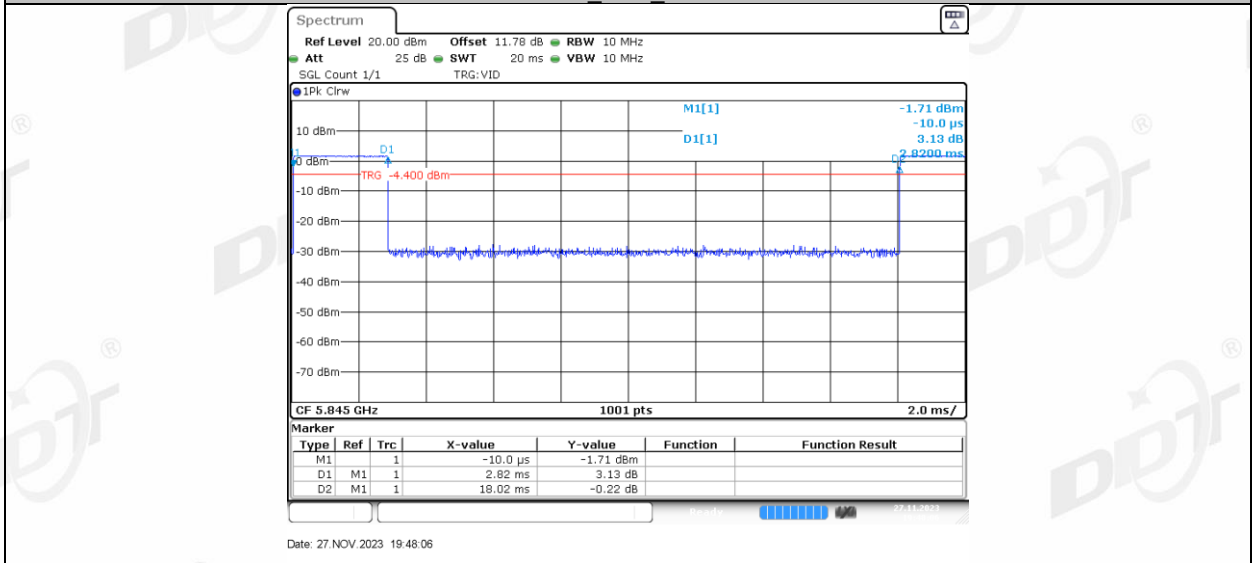

7. Maximum Output Power

7.1. Block diagram of test setup

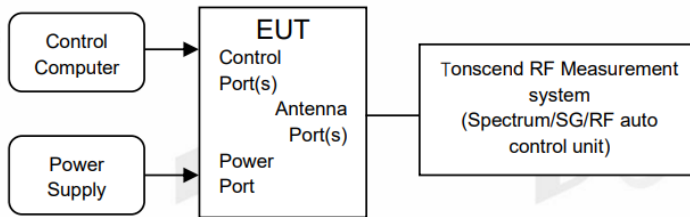

7.2. Limits

FCC Part15, Subpart E, RSS-247		
Test Item	Limit	Frequency Range (MHz)
Maximum Output Power	client devices: 250 mW (24 dBm)	5150-5250
	250 mW (24 dBm) or $11 + 10 \log_{10} B$	5250-5350
	250 mW (24 dBm) or $11 + 10 \log_{10} B$	5470-5725
	1 Watt (30 dBm)	5725-5850
Note 1: B=26 bandwidth		

7.3. Test procedure

Connect each EUT's antenna output to power sensor by RF cable and attenuator

Measure the output power of each antenna port by power sensor.

7.4. Test result channel power

Test Mode	Antenna	Frequency [MHz]	Duty Cycle [%]	DC Factor [dBm]	Result [dBm]	Limit [dBm]	EIRP [dBm]	EIRP Limit [dBm]	Verdict
SRD	Ant1	5729	15.54	8.09	6.93	≤30.00	10.42	---	PASS
	Ant2	5729	15.54	8.09	2.40	≤30.00	5.89	---	PASS
	Ant1	5787	15.65	8.05	6.87	≤30.00	10.36	---	PASS
	Ant2	5787	15.65	8.05	1.52	≤30.00	5.01	---	PASS
	Ant1	5845	15.65	8.05	7.09	≤30.00	10.58	---	PASS
	Ant2	5845	15.65	8.05	2.05	≤30.00	5.54	---	PASS

8. Power Spectral Density

8.1. Block diagram of test setup

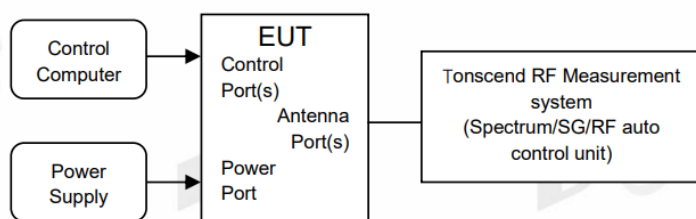

8.2. Limits

FCC Part15, Subpart E, RSS-247		
Test Item	Limit	Frequency Range (MHz)
Power Spectral Density	Other than Mobile and portable:17 dBm/MHz Mobile and portable client devices:11 dBm/MHz	5150-5250
	11 dBm/MHz	5250-5350
	11 dBm/MHz	5470-5725
	30 dBm/500 kHz	5725-5850

8.3. Test procedure

The transmitter output was connected to a spectrum analyzer. Power density was measured by spectrum analyzer with 1MHz RBW and 3MHz VBW.

Connect the UUT to the spectrum analyser and use the following settings:

5150 MHz~5250 MHz, 5250 MHz~5350 MHz, 5470 MHz~5725 MHz

Center Frequency	The centre frequency of the channel under test
Detector	RMS
RBW	1MHz
VBW	$\geq 3 \times \text{RBW}$
Span	Encompass the entire emissions bandwidth (EBW) of the signal
Trace	Max hold
Sweep time	Auto

5725 MHz-5850 MHz

Center Frequency	The centre frequency of the channel under test
Detector	RMS
RBW	500 kHz
VBW	$\geq 3 \times \text{RBW}$
Span	Encompass the entire emissions bandwidth (EBW) of the signal
Trace	Max hold
Sweep time	Auto

8.4. Test Result

TestMode	Antenna	Frequency[MHz]	Result [dBm/500kHz]	Limit[dBm/500kHz]	Verdict
SRD	Ant1	5729	3.83	≤ 30.00	PASS
	Ant2	5729	-0.77	≤ 30.00	PASS
	Ant1	5787	2.87	≤ 30.00	PASS
	Ant2	5787	-1.93	≤ 30.00	PASS
	Ant1	5845	2.20	≤ 30.00	PASS
	Ant2	5845	-2.13	≤ 30.00	PASS

Note: 1.The Result and Limit Unit is dBm/500 kHz in the band 5.725–5.85 GHz.

2.The Duty Cycle Factor and RBW Factor is compensated in the graph.

8.5. Test Graphs

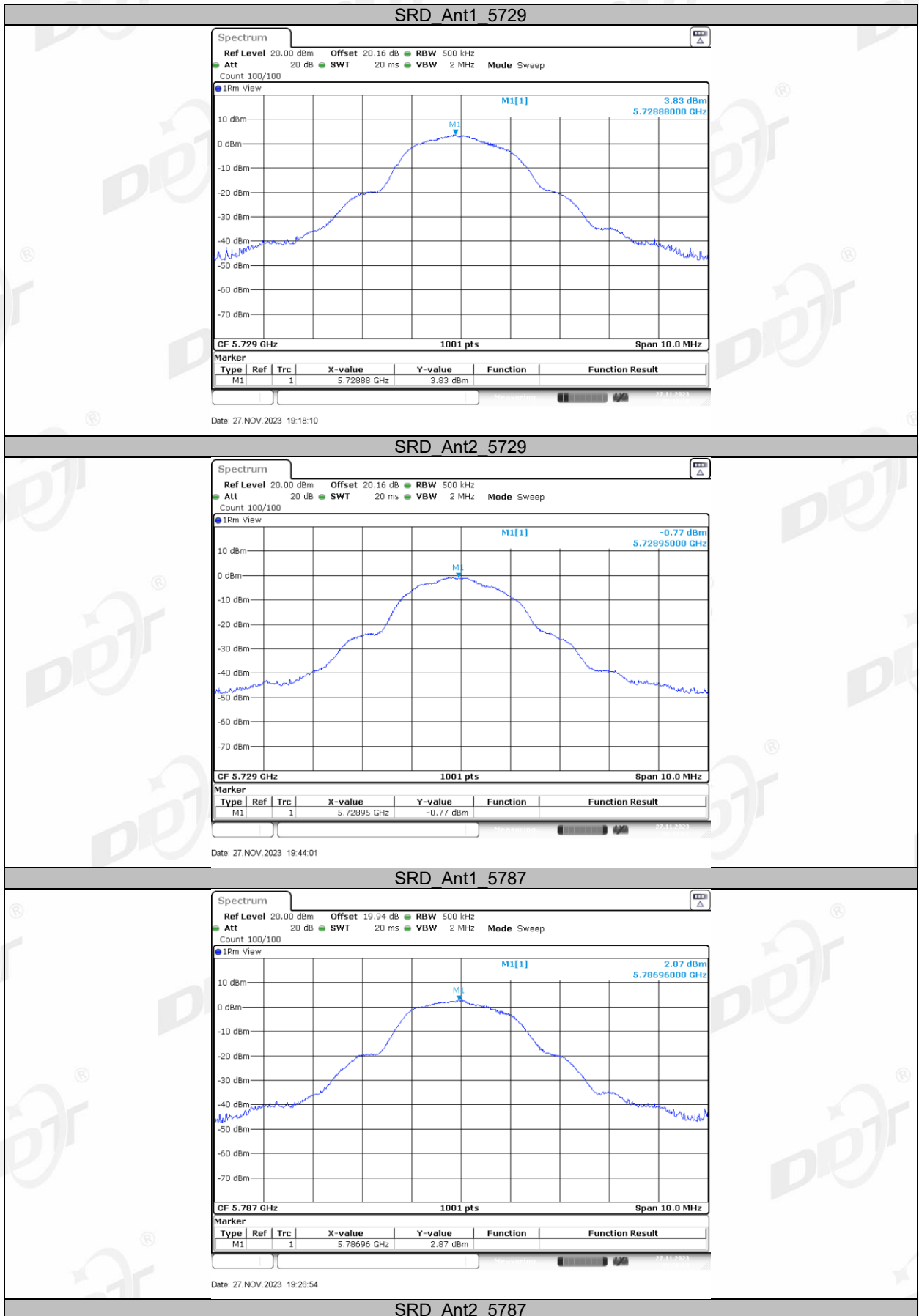

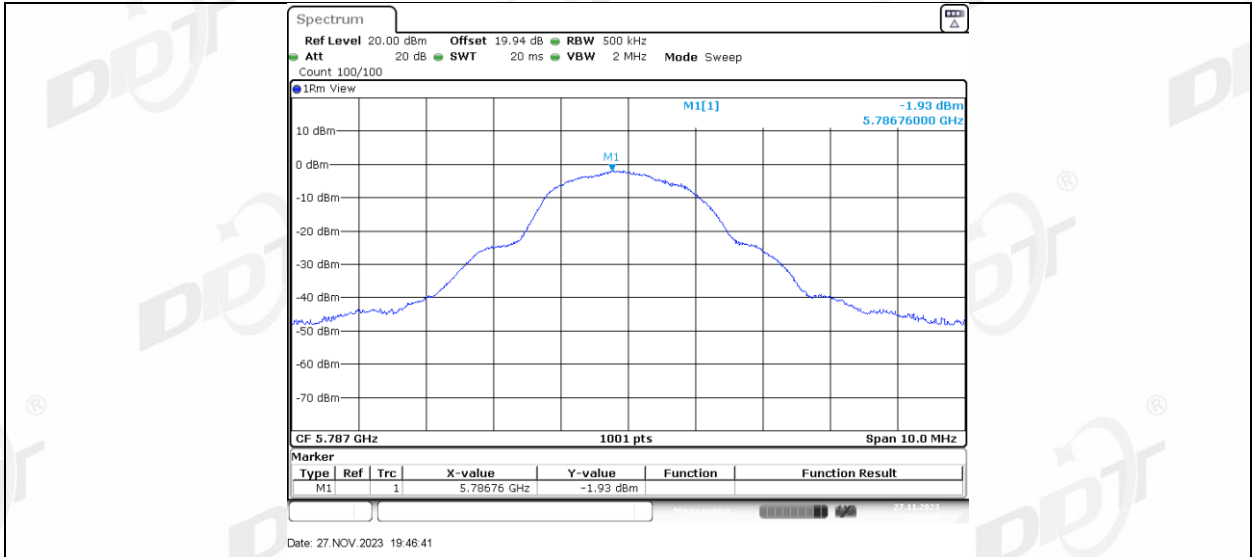

SRD Ant1 5845

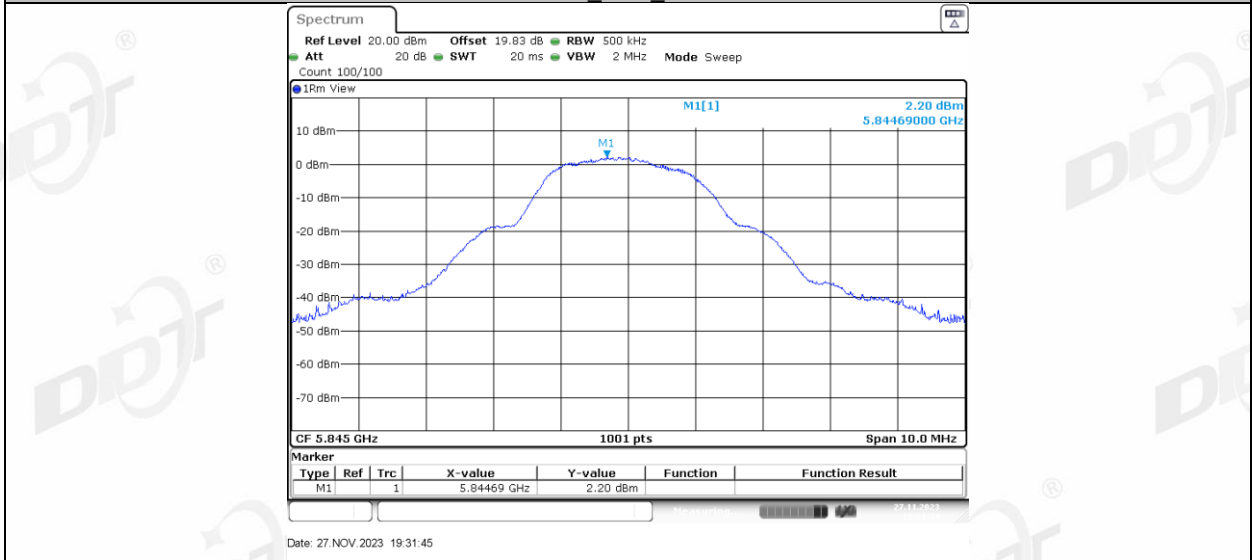

SRD Ant2 5845

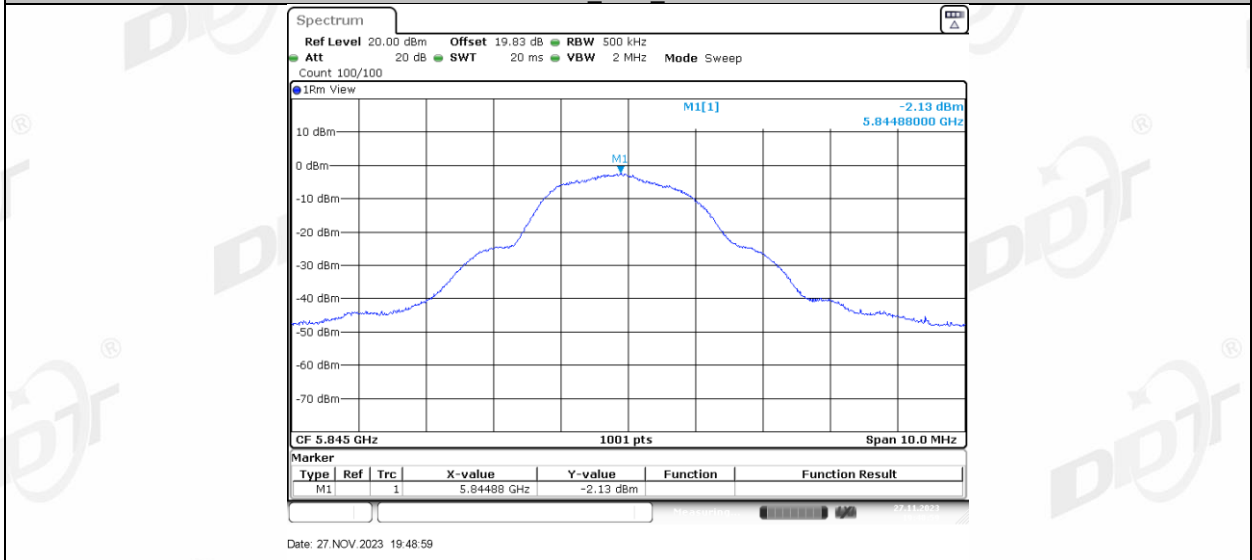

9. Frequency Stability Measurement

9.1. Limit of Frequency Stability

Manufacturers of U-NII devices are responsible for ensuring frequency stability such that an emission is maintained within the band of operation under all conditions of normal operation as specified in the user's manual.

9.2. Measuring Instruments

The measuring equipment is listed in the section 4 of this test report.

9.3. Test procedures

(1) To ensure emission at the band edge is maintained within the authorized band, those values shall be measured by radiation emissions at upper and lower frequency points, and finally compensated by frequency deviation as procedures below.

(2) The EUT was operated at the maximum output power, and connected to the spectrum analyzer, which is set to maximum hold function and peak detector. The peak value of the power envelope was measured and noted. The upper and lower frequency points were respectively measured relatively 10 dB lower than the measured peak value.

(3) The frequency deviation was calculated by adding the upper frequency point and the lower frequency point divided by two. Those detailed values of frequency deviation are provided in table below.

9.4. Test setup

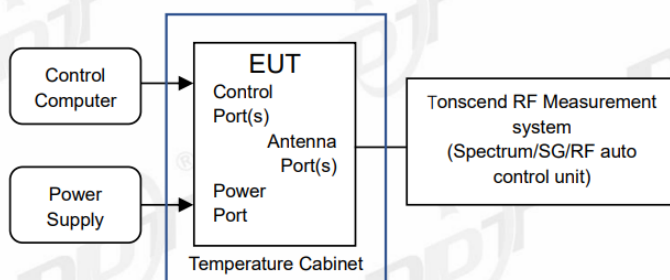

9.5. Test Result

Voltage								
TestMode	Antenna	Frequenc y[MHz]	Voltage [Vdc]	Tempera ture (°C)	Deviation (Hz)	Deviation (ppm)	Limit (ppm)	Verdict
SRD	Ant1	5729	NV	NT	-6000.00	-1.047303	20	PASS
			LV	NT	-6000.00	-1.047303	20	PASS
			HV	NT	-6000.00	-1.047303	20	PASS
	Ant2	5729	NV	NT	-5000.00	-0.872753	20	PASS
			LV	NT	-5000.00	-0.872753	20	PASS
			HV	NT	-5000.00	-0.872753	20	PASS
	Ant1	5787	NV	NT	-6000.00	-1.036807	20	PASS
			LV	NT	-7000.00	-1.209608	20	PASS
			HV	NT	-6000.00	-1.036807	20	PASS
	Ant2	5787	NV	NT	-6000.00	-1.036807	20	PASS
			LV	NT	-6000.00	-1.036807	20	PASS
			HV	NT	-7000.00	-1.209608	20	PASS
	Ant1	5845	NV	NT	-7000.00	-1.197605	20	PASS
			LV	NT	-6000.00	-1.026518	20	PASS
			HV	NT	-6000.00	-1.026518	20	PASS
	Ant2	5845	NV	NT	-5000.00	-0.855432	20	PASS
LV			NT	-7000.00	-1.197605	20	PASS	
HV			NT	-6000.00	-1.026518	20	PASS	

Temperature								
TestMode	Antenna	Frequenc y[MHz]	Voltage [Vdc]	Tempera ture (°C)	Deviation (Hz)	Deviation (ppm)	Limit (ppm)	Verdict
SRD	Ant1	5729	NV	0	-6000.00	-1.047303	20	PASS
			NV	10	-7000.00	-1.221854	20	PASS
			NV	20	-7000.00	-1.221854	20	PASS
			NV	30	-7000.00	-1.221854	20	PASS
			NV	35	-7000.00	-1.221854	20	PASS
	Ant2	5729	NV	0	-6000.00	-1.047303	20	PASS
			NV	10	-6000.00	-1.047303	20	PASS
			NV	20	-6000.00	-1.047303	20	PASS
			NV	35	-6000.00	-1.047303	20	PASS
	Ant1	5787	NV	0	-6000.00	-1.036807	20	PASS
			NV	10	-6000.00	-1.036807	20	PASS
			NV	20	-6000.00	-1.036807	20	PASS
			NV	30	-6000.00	-1.036807	20	PASS
			NV	35	-6000.00	-1.036807	20	PASS
	Ant2	5787	NV	0	-6000.00	-1.036807	20	PASS
			NV	10	-6000.00	-1.036807	20	PASS
			NV	20	-6000.00	-1.036807	20	PASS
			NV	35	-6000.00	-1.036807	20	PASS
	Ant1	5845	NV	0	-6000.00	-1.026518	20	PASS
			NV	10	-7000.00	-1.197605	20	PASS
			NV	20	-7000.00	-1.197605	20	PASS
			NV	30	-6000.00	-1.026518	20	PASS
			NV	35	-6000.00	-1.026518	20	PASS
	Ant2	5845	NV	0	-7000.00	-1.197605	20	PASS
			NV	10	-6000.00	-1.026518	20	PASS
			NV	20	-6000.00	-1.026518	20	PASS
			NV	30	-6000.00	-1.026518	20	PASS
				NV	35	-6000.00	-1.026518	20

10. Emissions in Restricted Frequency Bands

10.1. Test equipment

Equipment	Manufacturer	Model No.	Serial Number	Due Date
☑Radiation 3#Chamber				
EMI TEST RECEIVER	R&S	ESU26	100472	2024/04/22
PSA Series Spectrum Analyzer	Agilent	E4447A	MY50180031	2024/04/22
Active Loop Antenna	Schwarzbeck	FMZB-1519	1519-038	2024/09/10
Trilog Broadband Antenna	Schwarzbeck	VULB 9163	01429	2024/07/11
Double Ridged Horn Antenna	Schwarzbeck	BBHA 9120 D	02468	2024/09/17
Broad Band Horn Antenna	Schwarzbeck	BBHA 9170	790	2024/04/25
Pre-amplifier	COM-POWER	PAM-118A	18040084	2024/07/14
Pre-amplifier	COM-POWER	PAM-840A	461369	2024/04/26
RE Cable	N/A	W23.02 CP1-X2 + W23.09 AP1-X8+ JCT26S-NJ-NJ- 1.5M	4.5M+8M+1.5 M	2024/04/20
RF Cable	Yuhu	JCTB810-NJ-NJ- 9M+ ZT26S- SMAJ-SMAJ-1M	21123964	2024/04/22
Band Reject Filter(5150-5880 MHz)	REBES	BRM50716	G392	N/A
Test Software	Tonscend	JS32-RE	V 5.0.0.1	N/A

10.2. Block diagram of test setup

In 3 m Anechoic Chamber, test setup diagram for 9 kHz - 30 MHz:

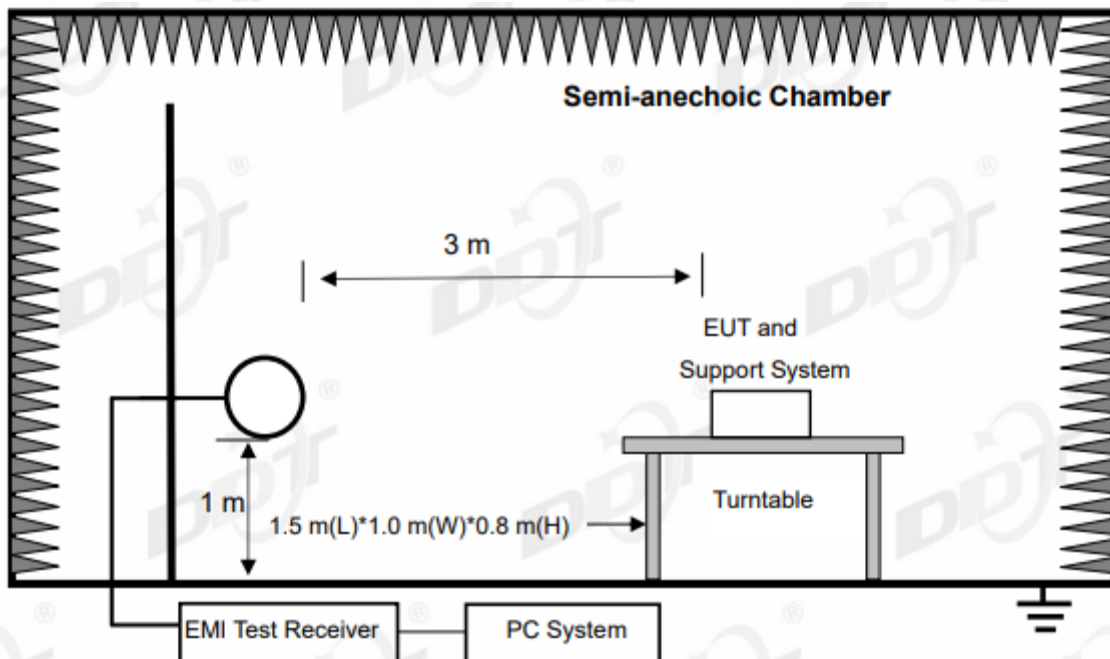

In 3 m Anechoic Chamber, test setup diagram for 30 MHz - 1 GHz:

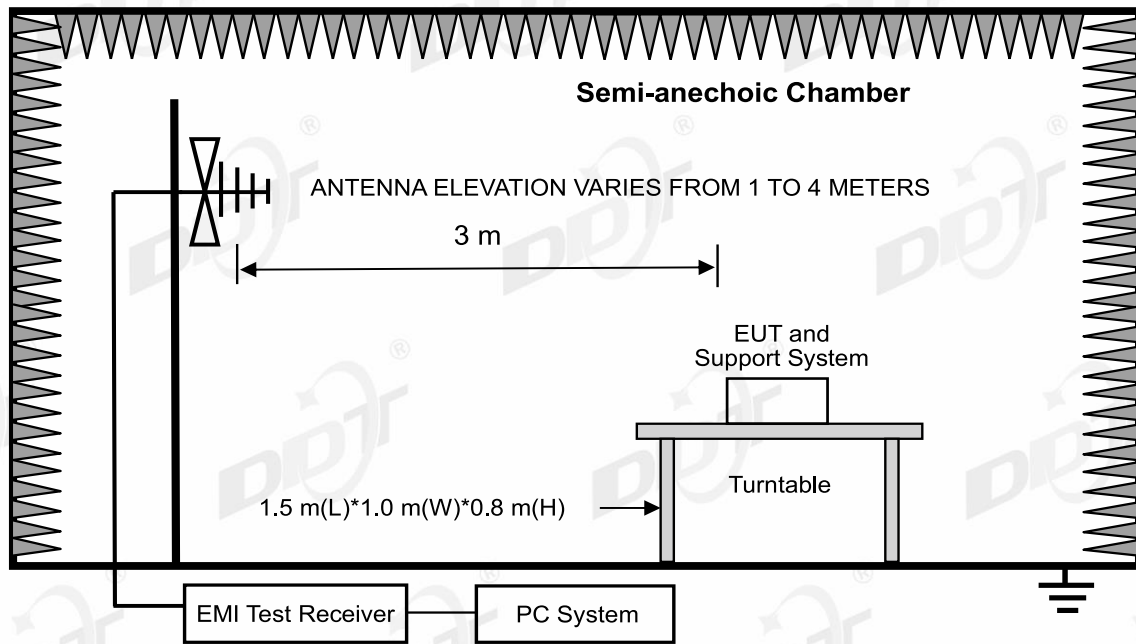

In 3 m Anechoic Chamber, test setup diagram for frequency above 1 GHz:

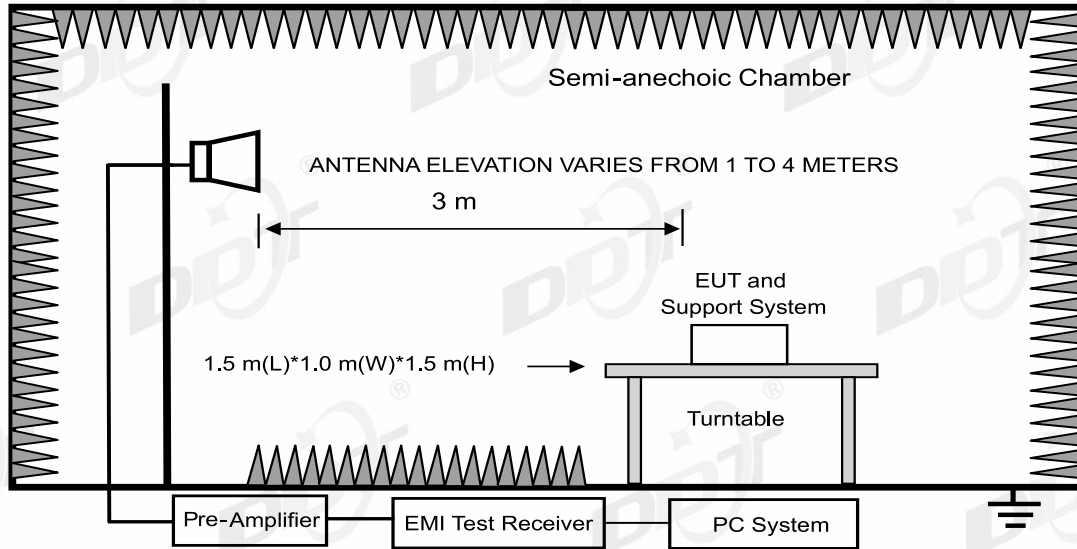

Note: For harmonic emissions test an appropriate high pass filter was inserted in the input port of AMP.

10.3. Limit

(1) FCC 15.205 Restricted frequency band

MHz	MHz	MHz	GHz
0.090-0.110	16.42-16.423	399.9-410	4.5-5.15
10.495-0.505	16.69475-16.69525	608-614	5.35-5.46
2.1735-2.1905	16.80425-16.80475	960-1240	7.25-7.75
4.125-4.128	25.5-25.67	1300-1427	8.025-8.5
4.1772&4.17775	37.5-38.25	1435-1626.5	9.0-9.2
4.2072&4.20775	73-74.6	1645.5-1646.5	9.3-9.5
6.215-6.218	74.8-75.2	1660-1710	10.6-12.7
6.26775-6.26825	108-121.94	1718.8-1722.2	13.25-13.4
6.31175-6.31225	123-138	2200-2300	14.47-14.5
8.291-8.294	149.9-150.05	2310-2390	15.35-16.2
8.362-8.366	156.52475-156.52525	2483.5-2500	17.7-21.4
8.37625-8.38675	156.7-156.9	2690-2900	22.01-23.12
8.41425-8.41475	162.0125-167.17	3260-3267	23.6-24.0
12.29-12.293	167.72-173.2	3332-3339	31.2-31.8
12.51975-12.52025	240-285	3345.8-3358	36.43-36.5
12.57675-12.57725	322-335.4	3600-4400	(²)
13.36-13.41			

¹Until February 1, 1999, this restricted band shall be 0.490-0.510 MHz.

²Above 38.6

RSS-Gen section 8.10 Restricted frequency bands*

MHz	MHz	MHz	GHz
0.090-0.110	12.51975-12.52025	240-285	3.5-4.4
0.495-0.505	12.57675-12.57725	322-335.4	4.5-5.15
2.1735-2.1905	13.36-13.41	399.9-410	5.35-5.46
3.020-3.026	16.42-16.423	608-614	7.25-7.75
4.125-4.128	16.69475-16.69525	960-1427	8.025-8.5
4.1772&4.17775	16.80425-16.80475	1435-1626.5	9.0-9.2
4.2072&4.20775	25.5-25.67	1645.5-1646.5	9.3-9.5
5.677-5.683	37.5-38.25	1660-1710	10.6-12.7
6.215-6.218	73-74.6	1718.8-1722.2	13.25-13.4
6.26775-6.26825	74.8-75.2	2200-2300	14.47-14.5
6.31175-6.31225	108-138	2310-2390	15.35-16.2
8.291-8.294	149.9-150.05	2483.5-2500	17.7-21.4
8.362-8.366	156.52475-156.52525	2655-2900	22.01-23.12
8.37625-8.38675	156.7-156.9	3260-3267	23.6-24.0
8.41425-8.41475	162.0125-167.17	3332-3339	31.2-31.8
12.29-12.293	167.72-173.2	3345.8-3358	36.43-36.5
			Above 38.6

* Certain frequency bands listed in table and in bands above 38.6 GHz are designated for licence-exempt applications. These frequency bands and the requirements that apply to related devices are set out in the 200 and 300 series of RSSs.

(2) FCC 15.209 Limit & RSS-Gen section 8.9 Limit

FREQUENCY MHz	DISTANCE Meters	FIELD STRENGTHS LIMIT	
		$\mu\text{V}/\text{m}$	$\text{dB}(\mu\text{V})/\text{m}$
0.009 ~ 0.490	300	2400/F(kHz)	67.6-20log(F)
0.490 ~ 1.705	30	24000/F(kHz)	87.6-20log(F)
1.705 ~ 30.0	30	30	29.54
30 ~ 88	3	100	40.0
88 ~ 216	3	150	43.5
216 ~ 960	3	200	46.0
960 ~ 1000	3	500	54.0
Above 1000	3	74.0 dB(μV)/m (Peak) 54.0 dB(μV)/m (Average)	

Note:

(1) The emission limits shown in the above table are based on measurements employing a CISPR QP detector except for the frequency bands 9 - 90 kHz, 110 - 490 kHz and above 1000 MHz. Radiated emissions limits in these three bands are based on measurements employing an average

detector.

(2) At frequencies below 30 MHz, measurement may be performed at a distance closer than that specified, and the limit at closer measurement distance can be extrapolated by below formula:

$$\text{Limit}_{3m}(\text{dBuV/m}) = \text{Limit}_{30m}(\text{dBuV/m}) + 40\text{Log}(30m/3m)$$

(3) Limit for this EUT

The emissions appearing within 15.205 restricted frequency bands shall not exceed the limits shown in 15.209, and the emissions appearing within RSS-Gen section 8.10 Restricted frequency bands shall not exceed the limits shown in RSS-Gen section 8.9, all the other emissions shall be at least 20 dB below the fundamental emissions or comply with 15.209 limits and RSS-Gen section 8.9 limits..

10.4. Test Procedure

- (1) EUT height should be 0 m for below 1 GHz at a semi - anechoic chamber while EUT height should be 0 m for above 1GHz at full chamber or semi - anechoic chamber ground with absorbers
- (2) Setup EUT and assistant system according clause 2.3 and 8.2
- (3) Test antenna was located 3m from the EUT on an adjustable mast, and the antenna used as below table.

Test frequency range	Test antenna used	Test distance
9 kHz-30 MHz	Active Loop antenna	3 m
30 MHz-1 GHz	Trilog Broadband Antenna	3 m
1 GHz-18 GHz	Double Ridged Horn Antenna(1GHz-18GHz)	3 m
18 GHz-40 GHz	Horn Antenna(18GHz-40GHz)	1 m

According ANSI C63.10:2013 clause 6.4.4.2 and 6.5.3, for measurements below 30 MHz, the loop antenna was positioned with its plane vertical from the EUT and rotated about its vertical axis for maximum response at each azimuth position around the EUT. And the loop antenna also be positioned with its plane horizontal at the specified distance from the EUT. The center of the loop is 1 m above the ground. for measurement above 30 MHz, the Trilog Broadband Antenna or Horn Antenna was located 3m from EUT, Measurements were made with the antenna positioned in both the horizontal and vertical planes of Polarization, and the measurement antenna was varied from 1 m to 4 m. in height above the reference ground plane to obtain the maximum signal strength.

(4) Below pre-scan procedure was first performed in order to find prominent frequency spectrum radiated emissions from 9 kHz to 40 GHz:

(a) Scanning the peak frequency spectrum with the antenna specified in step (3), and the EUT was rotated 360 degree, the antenna height was varied from 1 m to 4 m (Except loop antenna, it's fixed 1m above ground.)

(b) Change work frequency or channel of device if practicable.

(c) Change modulation type of device if practicable.

(d) Change power supply range from 85% to 115% of the rated supply voltage

(e) Rotated EUT through three orthogonal axes to determine the attitude of EUT arrangement produces highest emissions.

Spectrum frequency from 9 kHz to 40 GHz (tenth harmonic of fundamental frequency) was investigated, and no any obvious emission were detected from 9 kHz to 30 MHz and 18 GHz to 40 GHz, so below final test was performed with frequency range from 30 MHz to 18 GHz.

(5) For final emissions measurements at each frequency of interest, the EUT was rotated and the antenna height was varied between 1m and 4m in order to maximize the emission. Measurements in both horizontal and vertical polarities were made and the data was recorded. In order to find the maximum emission, the relative positions of equipments and all of the interface cables were changed according to ANSI C63.10:2013 on Radiated Emission test.

(6) The emissions from 9 kHz to 1 GHz were measured based on CISPR QP detector except for the frequency bands 9-90 kHz, 110-490 kHz, for emissions from 9 kHz-90kHz, 110kHz-490kHz and above 1GHz were measured based on average detector, for emissions above 1 GHz, peak emissions also be measured and need comply with Peak limit.

(7) The emissions from 9 kHz to 1 GHz, QP or average values were measured with EMI receiver with below RBW

Frequency band	RBW
9 kHz-150 kHz	200 Hz
150 kHz-30 MHz	9 kHz
30 MHz-1 GHz	120 kHz

(8) For emissions above 1 GHz, both Peak and Average level were measured with Spectrum Analyzer, and the RBW is set at 1 MHz, VBW is set at 3MHz for Peak measure, the RBW is set at 1 MHz, VBW is set at 10 Hz for AV value.

10.5. Test result

Pass. (See below detailed test result)

All the emissions except fundamental emission from 9 kHz to 25 GHz were comply with 15.209 limits and RSS-Gen section 8.9 limits.

Note1: According exploratory test no any obvious emission was detected from 9 kHz to 30 MHz and 18 GHz to 40 GHz, so the final test was performed with frequency range from 30 MHz to 18 GHz and recorded in below.

Note2: For emissions below 1 GHz, according exploratory explorer test, when change Tx mode and channel, have no distinct influence on emissions level, so for emissions below 1 GHz, the final test was only performed with EUT working in 5.8GHz Wireless mode.

Note3: For emissions above 1 GHz. If peak results comply with AV limit, AV Result is deemed to comply with AV limit. And the BT+ 5.8GHz Wireless is the worst simultaneous case and reported.

Radiated Emission test (below 1GHz)

TR-4-E-009 Radiated Emission Test Result

Test Date: 2023-11-25 **Tested By:** Junchang Du
EUT: Active Speaker **Model Number:** EDF100078
Test Mode: 5.8G SRD **Power Supply:** AC 120V/60Hz
Condition: Temp:22.6°C;Humi:57.0% **Test Site:** DDT 3# Chamber
File Path: d:\ts\2023 report data\Q23103011-2E EDF100078\FCC BELOW 1G\20231125-012233_H
Memo: Sample Number:S23103011-03 Power Setting:NA

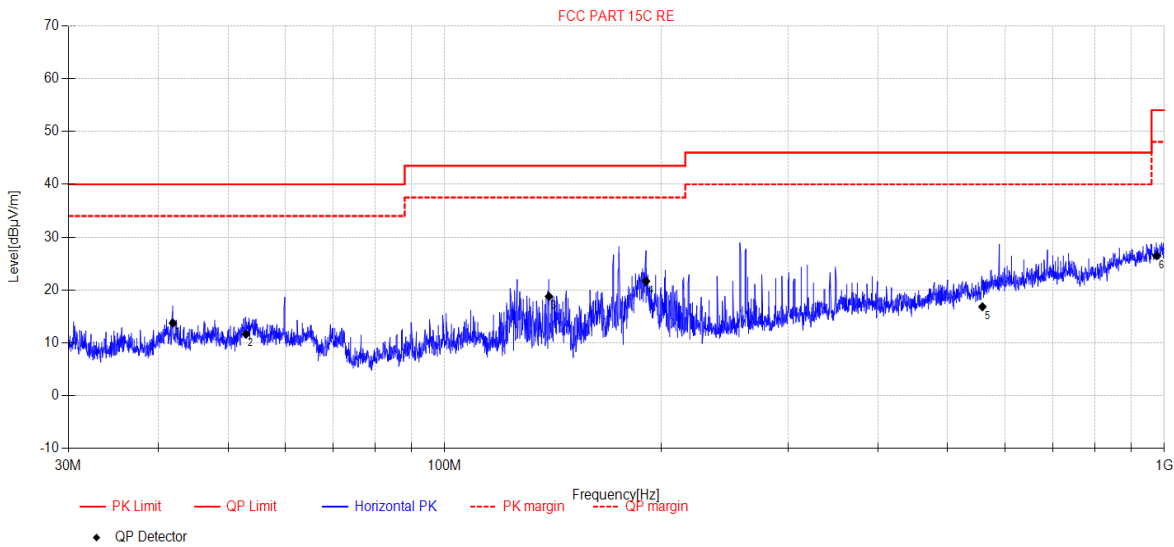

Data List										
NO.	Freq. [MHz]	Reading [dBµV/m]	Antenna Factor [dB]	Cable Loss [dB]	AMP [dB]	Result [dBµV/m]	Limit [dBµV/m]	Margin [dB]	Detector	Polarity
1	41.92	26.91	13.04	4.62	-30.82	13.75	40.00	26.25	QP	Horizontal
2	52.98	24	13.58	4.74	-30.68	11.64	40.00	28.36	QP	Horizontal
3	139.61	36.13	8.16	5.27	-30.78	18.78	43.50	24.72	QP	Horizontal
4	190.47	36.85	9.79	5.65	-30.63	21.66	43.50	21.84	QP	Horizontal
5	558.80	21.8	17.76	7.17	-29.90	16.83	46.00	29.17	QP	Horizontal
6	975.76	24.1	22.10	8.61	-28.32	26.49	54.00	27.51	QP	Horizontal

Note:

1. Result Level = Reading + Cable loss + Antenna Factor + AMP
2. If Peak Result complies with QP limit, QP Result is deemed to comply with QP limit.
3. Test setup: RBW: 120 kHz, VBW: 300 kHz, Sweep time: auto.

TR-4-E-009 Radiated Emission Test Result

Test Date: 2023-11-25 **Tested By:** Junchang Du
EUT: Active Speaker **Model Number:** EDF100078
Test Mode: 5.8G SRD **Power Supply:** AC 120V/60Hz
Condition: Temp:22.6°C;Humi:57.0% **Test Site:** DDT 3# Chamber
File Path: d:\ts\2023 report data\Q23103011-2E EDF100078\FCC BELOW 1G\20231125-012251_V
Memo: Sample Number:S23103011-03 Power Setting:NA

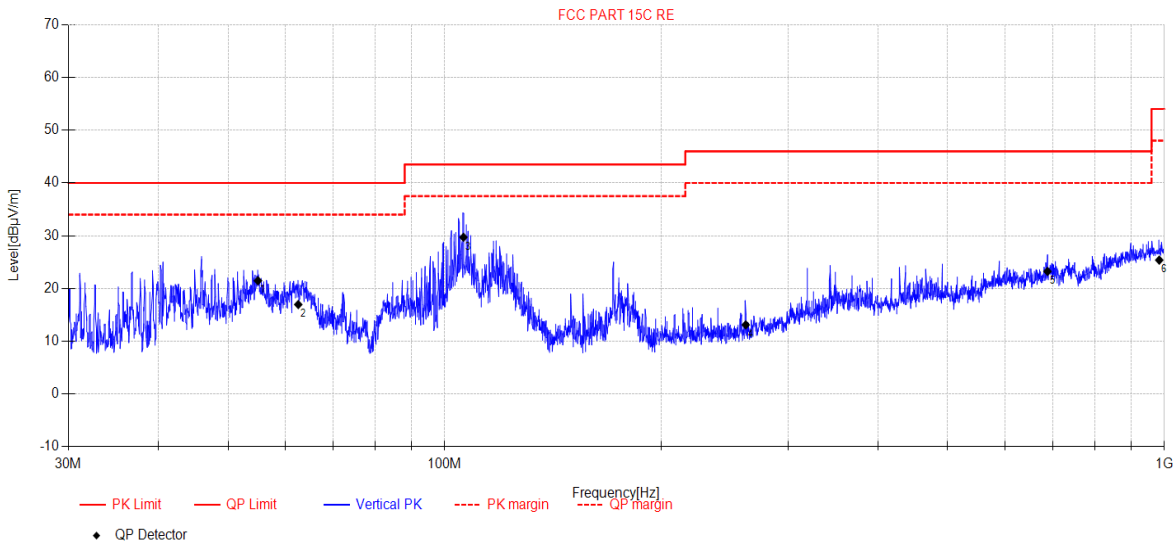

Data List										
NO.	Freq. [MHz]	Reading [dBµV/m]	Antenna Factor [dB]	Cable Loss [dB]	AMP [dB]	Result [dBµV/m]	Limit [dBµV/m]	Margin [dB]	Detector	Polarity
1	55.02	34.7	12.69	4.75	-30.67	21.47	40.00	18.53	QP	Vertical
2	62.60	30.25	12.56	4.77	-30.62	16.96	40.00	23.04	QP	Vertical
3	106.21	44.19	11.30	5.10	-30.88	29.71	43.50	13.79	QP	Vertical
4	262.05	25.95	11.58	5.99	-30.41	13.11	46.00	32.89	QP	Vertical
5	688.17	26.04	19.39	7.71	-29.90	23.24	46.00	22.76	QP	Vertical
6	984.00	23.05	21.94	8.63	-28.24	25.38	54.00	28.62	QP	Vertical

Note:

1. Result Level = Reading + Cable loss + Antenna Factor + AMP
2. If Peak Result complies with QP limit, QP Result is deemed to comply with QP limit.
3. Test setup: RBW: 120 kHz, VBW: 300 kHz, Sweep time: auto.

TR-4-E-009 Radiated Emission Test Result

Test Date: 2023-11-25 **Tested By:** Junchang Du
EUT: Active Speaker **Model Number:** EDF100078
Test Mode: BT TX +5.8G SRD TX **Power Supply:** AC 120V/60Hz
Condition: Temp:22.6°C;Humi:57.0% **Test Site:** DDT 3# Chamber
File Path: d:\ts\2023 report data\Q23103011-2E EDF100078\FCC BELOW 1G\20231204-095843_H
Memo: Sample Number:S23103011-03 Power Setting:NA

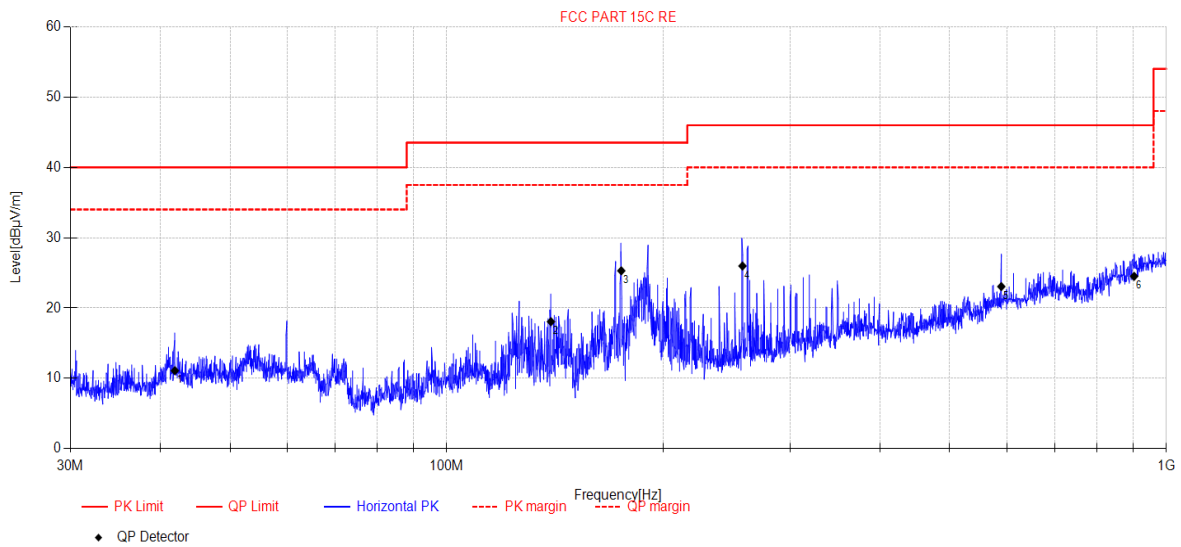

Data List										
NO.	Freq. [MHz]	Reading [dBµV/m]	Antenna Factor [dB]	Cable Loss [dB]	AMP [dB]	Result [dBµV/m]	Limit [dBµV/m]	Margin [dB]	Detector	Polarity
1	41.92	24.26	13.04	4.62	-30.82	11.10	40.00	28.90	QP	Horizontal
2	139.61	35.42	8.16	5.27	-30.78	18.07	43.50	25.43	QP	Horizontal
3	174.85	41.26	9.20	5.52	-30.68	25.30	43.50	18.20	QP	Horizontal
4	257.67	38.8	11.64	5.97	-30.43	25.98	46.00	20.02	QP	Horizontal
5	589.79	27.18	18.49	7.29	-29.90	23.06	46.00	22.94	QP	Horizontal
6	902.06	23.24	21.90	8.35	-28.98	24.51	46.00	21.49	QP	Horizontal

Note:

1. Result Level = Reading + Cable loss + Antenna Factor + AMP
2. If Peak Result complies with QP limit, QP Result is deemed to comply with QP limit.
3. Test setup: RBW: 120 kHz, VBW: 300 kHz, Sweep time: auto.

TR-4-E-009 Radiated Emission Test Result

Test Date: 2023-11-25 **Tested By:** Junchang Du
EUT: Active Speaker **Model Number:** EDF100078
Test Mode: BT TX +5.8G SRD TX **Power Supply:** AC 120V/60Hz
Condition: Temp:22.6°C;Humi:57.0% **Test Site:** DDT 3# Chamber
File Path: d:\ts\2023 report data\Q23103011-2E EDF100078\FCC BELOW 1G\20231204-095936_V
Memo: Sample Number:S23103011-03 Power Setting:NA

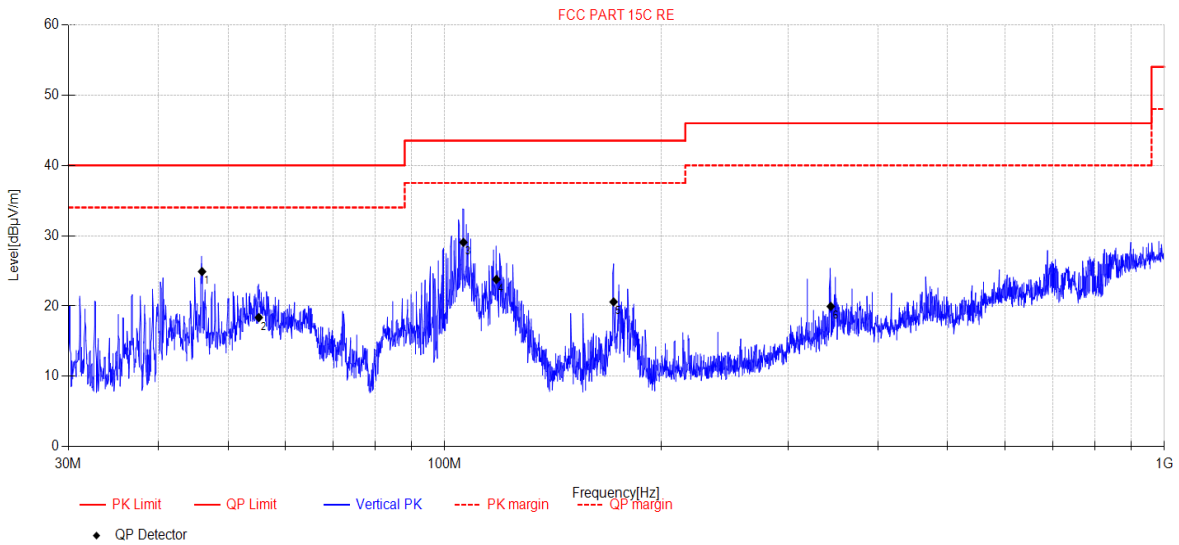

Data List										
NO.	Freq. [MHz]	Reading [dBµV/m]	Antenna Factor [dB]	Cable Loss [dB]	AMP [dB]	Result [dBµV/m]	Limit [dBµV/m]	Margin [dB]	Detector	Polarity
1	46.01	38.67	12.31	4.68	-30.76	24.90	40.00	15.10	QP	Vertical
2	55.18	31.66	12.63	4.75	-30.67	18.37	40.00	21.63	QP	Vertical
3	106.21	43.53	11.30	5.10	-30.88	29.05	43.50	14.45	QP	Vertical
4	117.99	40.17	9.31	5.16	-30.85	23.79	43.50	19.71	QP	Vertical
5	171.69	36.45	9.32	5.50	-30.68	20.59	43.50	22.91	QP	Vertical
6	343.98	29.53	14.24	6.39	-30.21	19.95	46.00	26.05	QP	Vertical

Note:

1. Result Level = Reading + Cable loss + Antenna Factor + AMP
2. If Peak Result complies with QP limit, QP Result is deemed to comply with QP limit.
3. Test setup: RBW: 120 kHz, VBW: 300 kHz, Sweep time: auto.

Radiated Emission test (above 1GHz)

TR-4-E-009 Radiated Emission Test Result

Test Date: 2023-11-28 **Tested By:** Junchang Du
EUT: Active Speaker **Model Number:** EDF100078
Test Mode: SRD TX 5729MHz **Power Supply:** AC 120V/60Hz
Condition: Temp:22.6°C;Humi:57.0% **Test Site:** DDT 3# Chamber
File Path: d:\ts\2023 report data\Q23103011-2E EDF100078\FCC ABOVE 1G 5G SRD\39
Memo: Sample Number:S23103011-03 Power Setting:5 ANT1

Test Graph

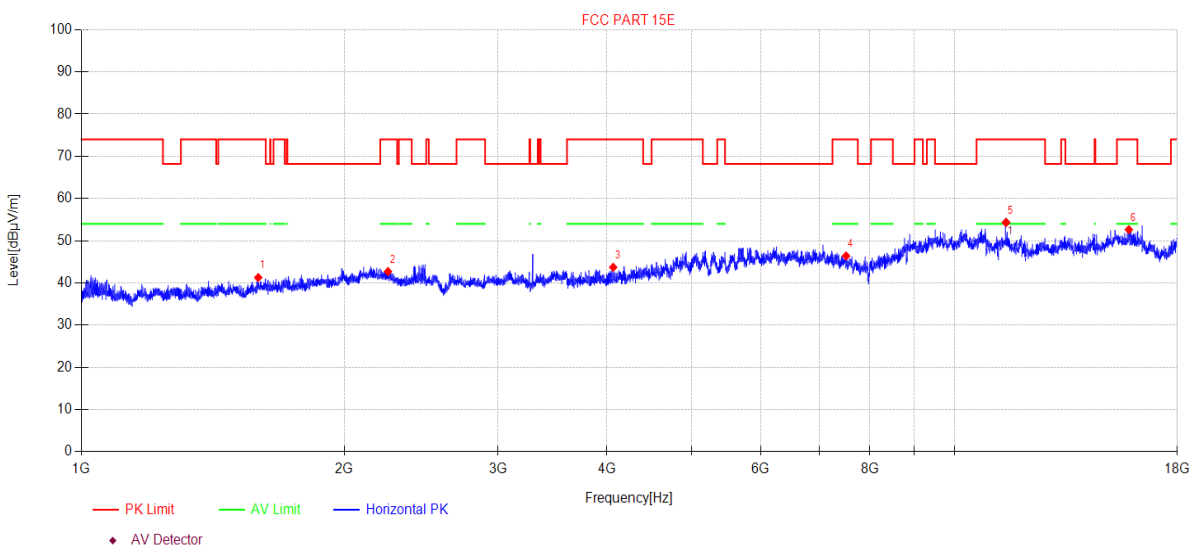

Data List										
N O.	Freq. [MHz]	Reading [dBμV/m]	Antenna Factor [dB]	Cable loss [dB]	AMP [dB]	Level [dBμV/m]	Limit [dBμV/m]	Margin [dB]	Detector	Polarity
1	1594.34	47.94	25.51	4.79	-36.96	41.28	74.00	32.72	PK	Horizontal
2	2244.86	47.09	27.35	5.96	-37.70	42.70	74.00	31.30	PK	Horizontal
3	4065.58	47.13	31.03	5.98	-40.43	43.71	74.00	30.29	PK	Horizontal
4	7513.49	44.25	36.47	7.65	-41.98	46.39	74.00	27.61	PK	Horizontal
5	11458.00	44.33	39.24	10.06	-39.31	54.32	74.00	19.68	PK	Horizontal
6	15836.88	38.52	38.23	15.14	-39.26	52.63	74.00	21.37	PK	Horizontal

AVG Result										
N O.	Freq. [MHz]	Reading [dBμV/m]	Antenna Factor [dB]	Cable loss [dB]	AMP [dB]	AVG Level [dBμV/m]	Limit [dBμV/m]	Margin [dB]	Detector	Polarity
1	11458.00	/	/	/	/	38.15	54.00	15.85	/	Horizontal

Note:

1. Level = Reading + Cable loss + Antenna Factor + AMP
2. If Peak Result complies with AV limit, AV Result is deemed to comply with AV limit.
3. Test setup: RBW: 1 MHz, VBW: 3 MHz, Sweep time: auto.
4. AVG Level=Peak level+20log (D) , D= Duty Cycle =15.54%, Peak level =54.32 dBμV/m

TR-4-E-009 Radiated Emission Test Result

Test Date: 2023-11-28 **Tested By:** Junchang Du
EUT: Active Speaker **Model Number:** EDF100078
Test Mode: SRD TX 5729MHz **Power Supply:** AC 120V/60Hz
Condition: Temp:22.6°C;Humi:57.0% **Test Site:** DDT 3# Chamber
File Path: d:\ts\2023 report data\Q23103011-2E EDF100078\FCC ABOVE 1G 5G SRD\40
Memo: Sample Number:S23103011-03 Power Setting:5 ANT1

Test Graph

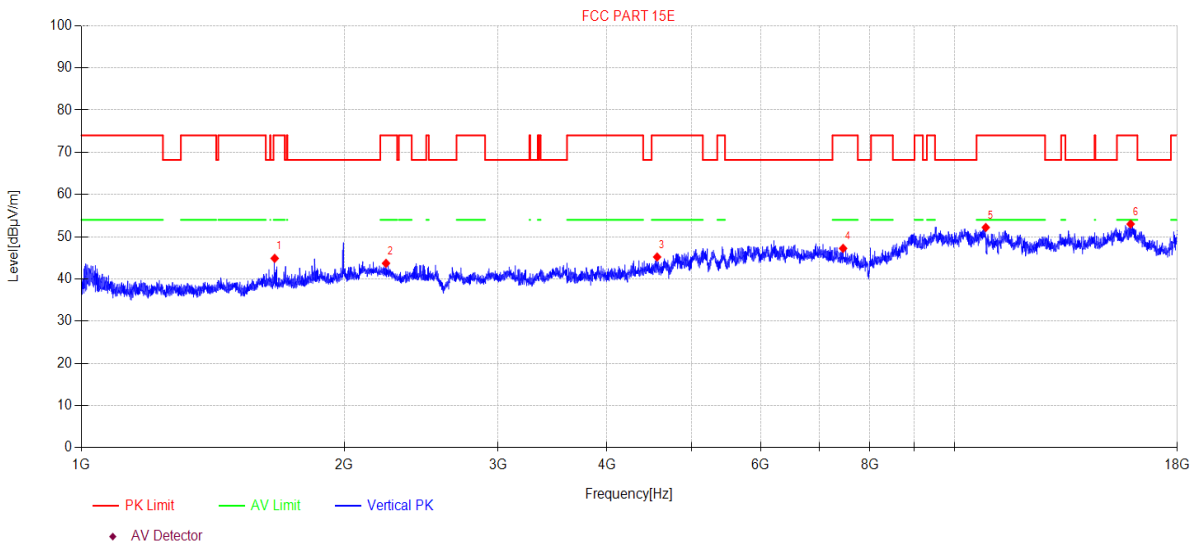

Data List

N O.	Freq. [MHz]	Reading [dBµV/m]	Antenna Factor [dB]	Cable loss [dB]	AMP [dB]	Level [dBµV/m]	Limit [dBµV/m]	Margin [dB]	Detector	Polarity
1	1664.98	51.25	25.58	5.01	-36.97	44.87	74.00	29.13	PK	Vertical
2	2233.22	47.93	27.47	5.97	-37.67	43.70	74.00	30.30	PK	Vertical
3	4565.14	46.55	31.90	6.99	-40.24	45.20	74.00	28.80	PK	Vertical
4	7455.09	44.85	36.59	7.64	-41.84	47.24	74.00	26.76	PK	Vertical
5	10861.07	42.35	39.34	9.55	-39.04	52.20	74.00	21.80	PK	Vertical
6	15914.88	38.74	38.09	15.49	-39.31	53.01	74.00	20.99	PK	Vertical

Note:

- Level = Reading + Cable loss + Antenna Factor + AMP
- If Peak Result complies with AV limit, AV Result is deemed to comply with AV limit.
- Test setup: RBW: 1 MHz, VBW: 3 MHz, Sweep time: auto.

TR-4-E-009 Radiated Emission Test Result

Test Date: 2023-11-15 **Tested By:** Junchang Du
EUT: Active Speaker **Model Number:** EDF100078
Test Mode: SRD TX 5787MHz **Power Supply:** AC 120V/60Hz
Condition: Temp:22.6°C;Humi:57.0% **Test Site:** DDT 3# Chamber
File Path: d:\ts\2023 report data\Q23103011-2E EDF100078\FCC ABOVE 1G 5G SRD\15
Memo: Sample Number:S23103011-03 Power Setting:5 ANT1

Test Graph

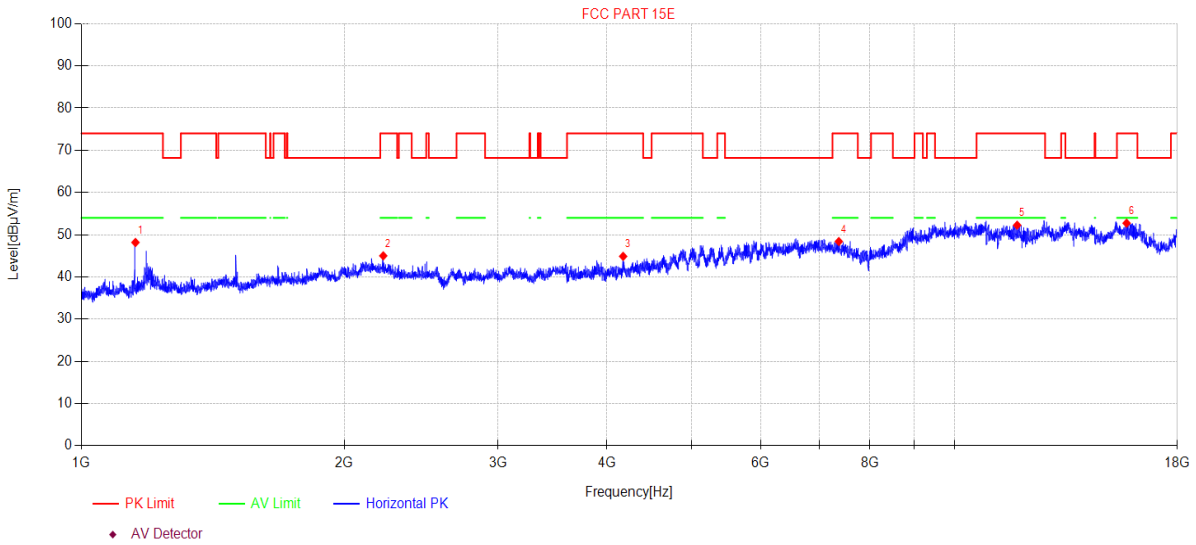

Data List										
N O.	Freq. [MHz]	Reading [dBµV/m]	Antenna Factor [dB]	Cable loss [dB]	AMP [dB]	Level [dBµV/m]	Limit [dBµV/m]	Margin [dB]	Detector	Polarity
1	1153.46	56.82	24.81	3.44	-36.90	48.17	74.00	25.83	PK	Horizontal
2	2217.14	48.96	27.63	6.04	-37.62	45.01	74.00	28.99	PK	Horizontal
3	4173.93	47.65	31.20	6.42	-40.39	44.88	74.00	29.12	PK	Horizontal
4	7371.53	44.37	36.76	8.90	-41.63	48.40	74.00	25.60	PK	Horizontal
5	11796.96	42.66	38.90	10.16	-39.46	52.26	74.00	21.74	PK	Horizontal
6	15745.60	38.75	38.41	14.79	-39.21	52.74	74.00	21.26	PK	Horizontal

Note:

1. Level = Reading + Cable loss + Antenna Factor + AMP
2. If Peak Result complies with AV limit, AV Result is deemed to comply with AV limit.
3. Test setup: RBW: 1 MHz, VBW: 3 MHz, Sweep time: auto.

TR-4-E-009 Radiated Emission Test Result

Test Date: 2023-11-15 **Tested By:** Junchang Du
EUT: Active Speaker **Model Number:** EDF100078
Test Mode: SRD TX 5787MHz **Power Supply:** AC 120V/60Hz
Condition: Temp:22.6°C;Humi:57.0% **Test Site:** DDT 3# Chamber
File Path: d:\ts\2023 report data\Q23103011-2E EDF100078\FCC ABOVE 1G 5G SRD\16
Memo: Sample Number:S23103011-03 Power Setting:5 ANT1

Test Graph

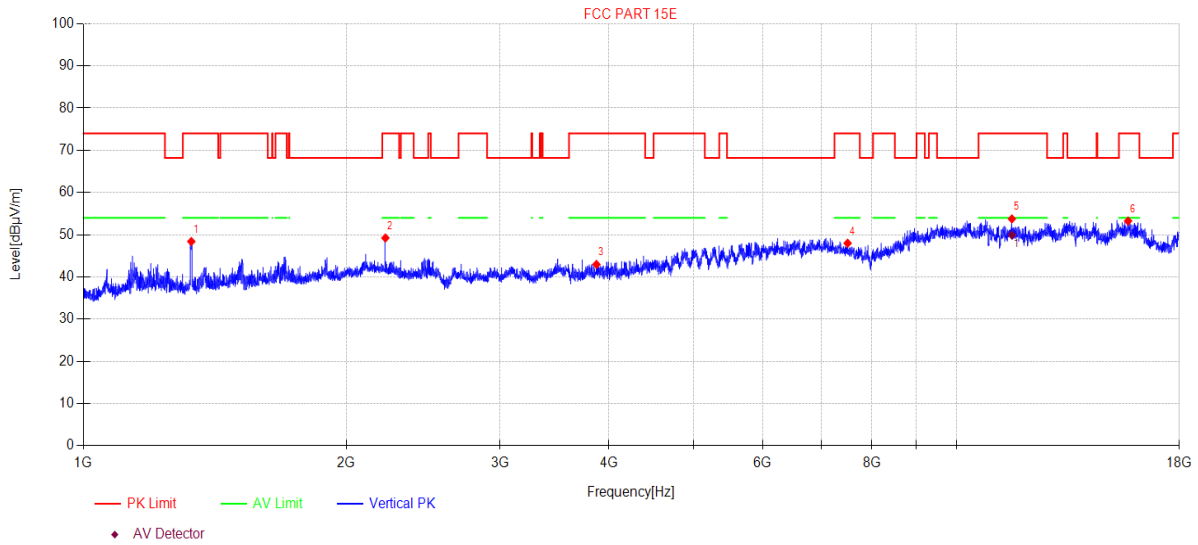

Data List										
N O.	Freq. [MHz]	Reading [dBµV/m]	Antenna Factor [dB]	Cable loss [dB]	AMP [dB]	Level [dBµV/m]	Limit [dBµV/m]	Margin [dB]	Detector	Polarity
1	1329.33	56.57	24.72	4.02	-36.92	48.39	74.00	25.61	PK	Vertical
2	2217.78	53.20	27.62	6.04	-37.63	49.23	74.00	24.77	PK	Vertical
3	3869.54	46.33	31.02	5.98	-40.37	42.96	74.00	31.04	PK	Vertical
4	7504.81	44.58	36.49	8.88	-41.96	47.99	74.00	26.01	PK	Vertical
5	11574.07	44.08	39.05	9.98	-39.36	53.75	74.00	20.25	PK	Vertical
6	15722.86	39.33	38.45	14.67	-39.19	53.26	74.00	20.74	PK	Vertical

Data List										
N O.	Freq. [MHz]	Reading [dBµV/m]	Antenna Factor [dB]	Cable loss [dB]	AMP [dB]	Level [dBµV/m]	Limit [dBµV/m]	Margin [dB]	Detector	Polarity
1	11574.07	40.25	39.05	9.98	-39.36	49.92	54.00	4.08	AV	Vertical

Note:

1. Level = Reading + Cable loss + Antenna Factor + AMP
2. If Peak Result complies with AV limit, AV Result is deemed to comply with AV limit.
3. Test setup: RBW: 1 MHz, VBW: 3 MHz, Sweep time: auto.

TR-4-E-009 Radiated Emission Test Result

Test Date: 2023-11-28 **Tested By:** Junchang Du
EUT: Active Speaker **Model Number:** EDF100078
Test Mode: SRD TX 5845MHz **Power Supply:** AC 120V/60Hz
Condition: Temp:22.6°C;Humi:57.0% **Test Site:** DDT 3# Chamber
File Path: d:\ts\2023 report data\Q23103011-2E EDF100078\FCC ABOVE 1G 5G SRD\41
Memo: Sample Number:S23103011-03 Power Setting:5 ANT1

Test Graph

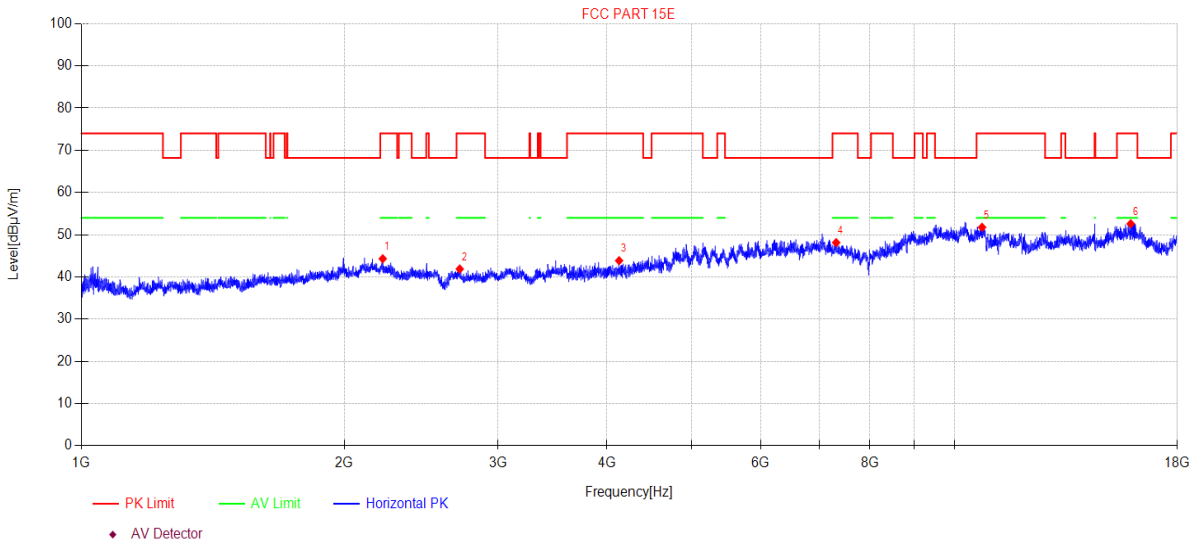

Data List										
N O.	Freq. [MHz]	Reading [dBµV/m]	Antenna Factor [dB]	Cable loss [dB]	AMP [dB]	Level [dBµV/m]	Limit [dBµV/m]	Margin [dB]	Detector	Polarity
1	2213.94	48.23	27.66	6.04	-37.62	44.31	74.00	29.69	PK	Horizontal
2	2712.70	47.78	27.53	5.60	-39.03	41.88	74.00	32.12	PK	Horizontal
3	4129.53	46.77	31.16	6.33	-40.40	43.86	74.00	30.14	PK	Horizontal
4	7320.58	43.86	36.86	8.91	-41.50	48.13	74.00	25.87	PK	Horizontal
5	10754.87	41.86	39.40	9.50	-39.00	51.76	74.00	22.24	PK	Horizontal
6	15919.48	38.16	38.08	15.66	-39.31	52.59	74.00	21.41	PK	Horizontal

Note:

1. Level = Reading + Cable loss + Antenna Factor + AMP
2. If Peak Result complies with AV limit, AV Result is deemed to comply with AV limit.
3. Test setup: RBW: 1 MHz, VBW: 3 MHz, Sweep time: auto.

TR-4-E-009 Radiated Emission Test Result

Test Date: 2023-11-28 **Tested By:** Junchang Du
EUT: Active Speaker **Model Number:** EDF100078
Test Mode: SRD TX 5845MHz **Power Supply:** AC 120V/60Hz
Condition: Temp:22.6°C;Humi:57.0% **Test Site:** DDT 3# Chamber
File Path: d:\ts\2023 report data\Q23103011-2E EDF100078\FCC ABOVE 1G 5G SRD\42
Memo: Sample Number:S23103011-03 Power Setting:5 ANT1

Test Graph

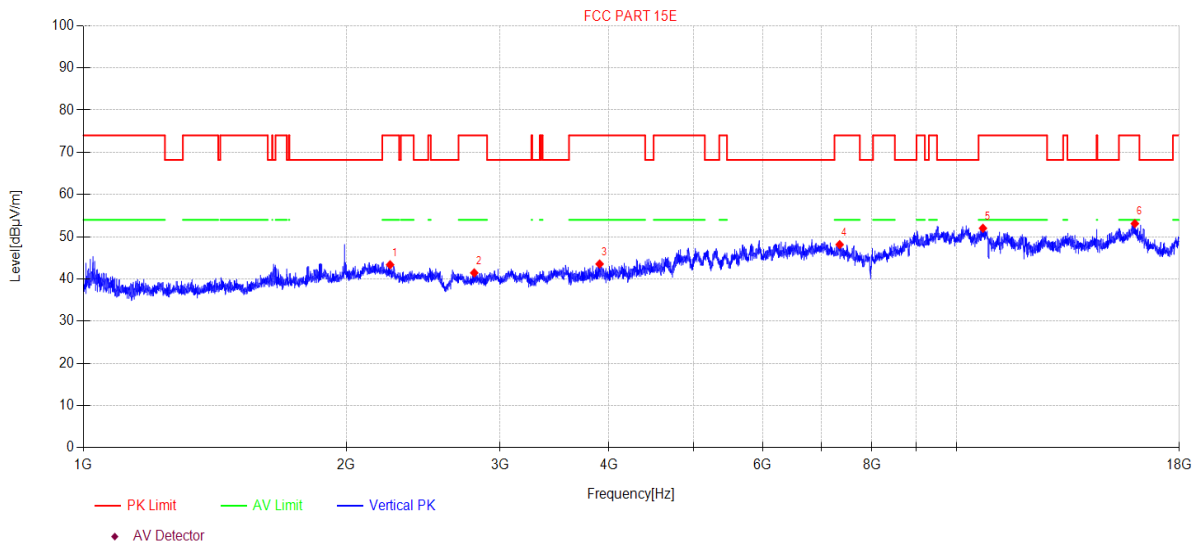

Data List										
N O.	Freq. [MHz]	Reading [dBµV/m]	Antenna Factor [dB]	Cable loss [dB]	AMP [dB]	Level [dBµV/m]	Limit [dBµV/m]	Margin [dB]	Detector	Polarity
1	2245.51	47.70	27.34	6.01	-37.70	43.35	74.00	30.65	PK	Vertical
2	2803.57	47.77	27.43	5.52	-39.28	41.44	74.00	32.56	PK	Vertical
3	3902.11	46.72	31.20	6.01	-40.39	43.54	74.00	30.46	PK	Vertical
4	7348.13	44.00	36.80	8.90	-41.57	48.13	74.00	25.87	PK	Vertical
5	10723.84	42.10	39.40	9.49	-38.99	52.00	74.00	22.00	PK	Vertical
6	16007.13	38.45	37.99	16.04	-39.37	53.11	74.00	20.89	PK	Vertical

Note:

- Level = Reading + Cable loss + Antenna Factor + AMP
- If Peak Result complies with AV limit, AV Result is deemed to comply with AV limit.
- Test setup: RBW: 1 MHz, VBW: 3 MHz, Sweep time: auto.

TR-4-E-009 Radiated Emission Test Result

Test Date: 2023-11-28 **Tested By:** Junchang Du
EUT: Active Speaker **Model Number:** EDF100078
Test Mode: SRD TX 5729MHz **Power Supply:** AC 120V/60Hz
Condition: Temp:22.6°C;Humi:57.0% **Test Site:** DDT 3# Chamber
File Path: d:\ts\2023 report data\Q23103011-2E EDF100078\FCC ABOVE 1G 5G SRD\43
Memo: Sample Number:S23103011-03 Power Setting:5 ANT2

Test Graph

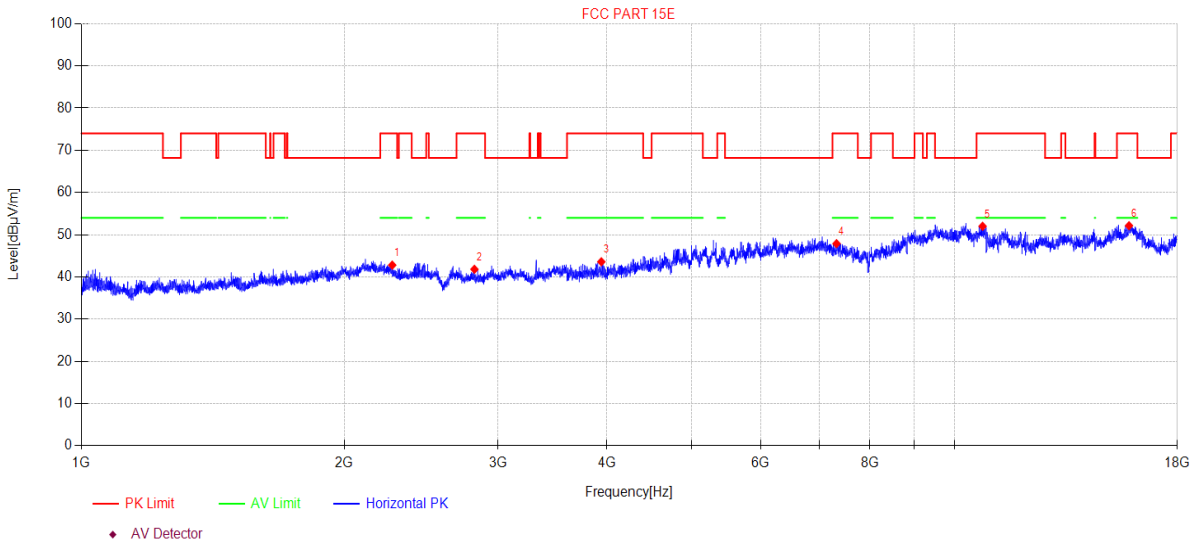

Data List										
N O.	Freq. [MHz]	Reading [dBµV/m]	Antenna Factor [dB]	Cable loss [dB]	AMP [dB]	Level [dBµV/m]	Limit [dBµV/m]	Margin [dB]	Detector	Polarity
1	2270.31	47.48	27.10	5.99	-37.77	42.80	74.00	31.20	PK	Horizontal
2	2819.82	48.08	27.56	5.51	-39.33	41.82	74.00	32.18	PK	Horizontal
3	3940.64	46.84	31.12	6.04	-40.41	43.59	74.00	30.41	PK	Horizontal
4	7326.93	43.65	36.85	8.91	-41.52	47.89	74.00	26.11	PK	Horizontal
5	10770.43	42.11	39.40	9.50	-39.01	52.00	74.00	22.00	PK	Horizontal
6	15846.03	37.91	38.21	15.29	-39.27	52.14	74.00	21.86	PK	Horizontal

Note:

1. Level = Reading + Cable loss + Antenna Factor + AMP
2. If Peak Result complies with AV limit, AV Result is deemed to comply with AV limit.
3. Test setup: RBW: 1 MHz, VBW: 3 MHz, Sweep time: auto.

TR-4-E-009 Radiated Emission Test Result

Test Date: 2023-11-28 **Tested By:** Junchang Du
EUT: Active Speaker **Model Number:** EDF100078
Test Mode: SRD TX 5729MHz **Power Supply:** AC 120V/60Hz
Condition: Temp:22.6°C;Humi:57.0% **Test Site:** DDT 3# Chamber
File Path: d:\ts\2023 report data\Q23103011-2E EDF100078\FCC ABOVE 1G 5G SRD\44
Memo: Sample Number:S23103011-03 Power Setting:5 ANT2

Test Graph

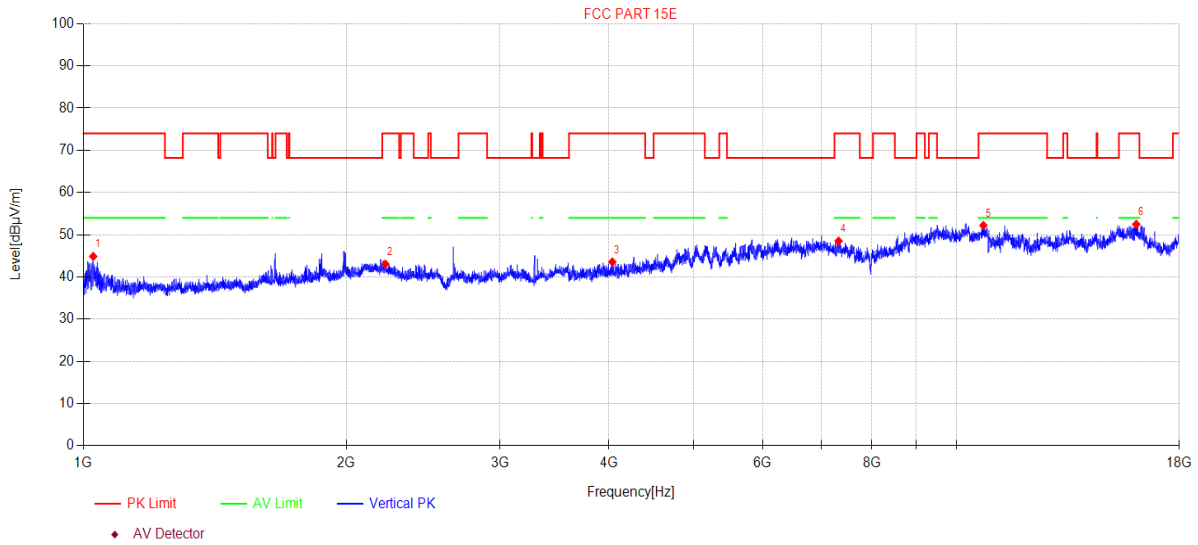

Data List										
N O.	Freq. [MHz]	Reading [dBµV/m]	Antenna Factor [dB]	Cable loss [dB]	AMP [dB]	Level [dBµV/m]	Limit [dBµV/m]	Margin [dB]	Detector	Polarity
1	1026.35	54.32	24.40	3.02	-36.88	44.86	74.00	29.14	PK	Vertical
2	2217.78	47.01	27.62	6.04	-37.63	43.04	74.00	30.96	PK	Vertical
3	4035.15	46.88	30.97	6.15	-40.44	43.56	74.00	30.44	PK	Vertical
4	7329.04	44.27	36.84	8.91	-41.52	48.50	74.00	25.50	PK	Vertical
5	10736.24	42.29	39.40	9.49	-38.99	52.19	74.00	21.81	PK	Vertical
6	16067.39	38.16	37.93	15.79	-39.41	52.47	74.00	21.53	PK	Vertical

Note:

- Level = Reading + Cable loss + Antenna Factor + AMP
- If Peak Result complies with AV limit, AV Result is deemed to comply with AV limit.
- Test setup: RBW: 1 MHz, VBW: 3 MHz, Sweep time: auto.

TR-4-E-009 Radiated Emission Test Result

Test Date: 2023-11-25 **Tested By:** Junchang Du
EUT: Active Speaker **Model Number:** EDF100078
Test Mode: SRD TX 5787MHz **Power Supply:** AC 120V/60Hz
Condition: Temp:22.6°C;Humi:57.0% **Test Site:** DDT 3# Chamber
File Path: d:\ts\2023 report data\Q23103011-2E EDF100078\FCC ABOVE 1G 5G SRD\31
Memo: Sample Number:S23103011-03 Power Setting:5 ANT2

Test Graph

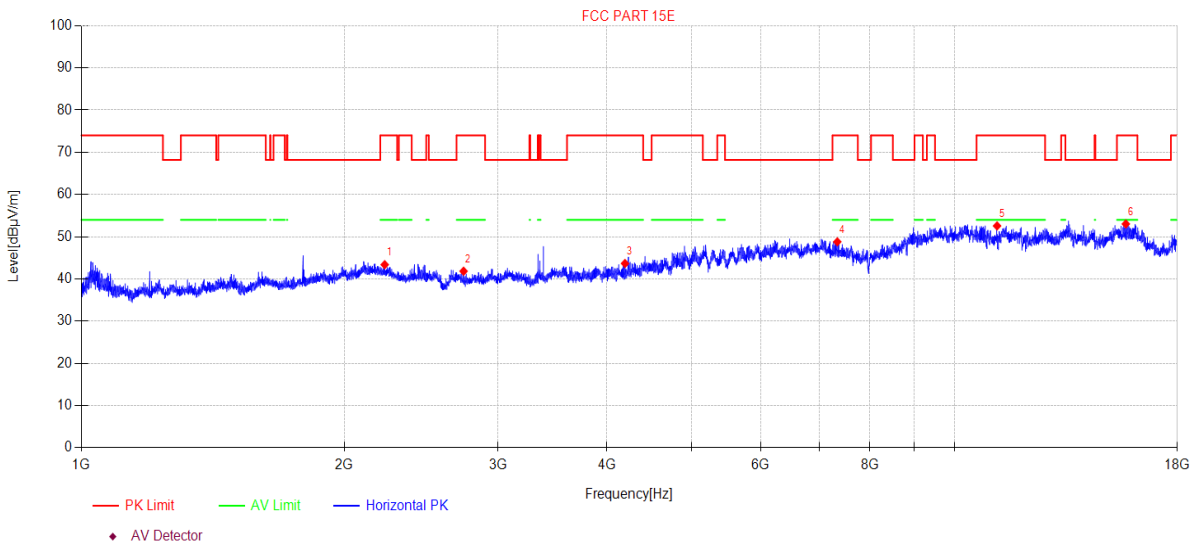

Data List										
N O.	Freq. [MHz]	Reading [dBµV/m]	Antenna Factor [dB]	Cable loss [dB]	AMP [dB]	Level [dBµV/m]	Limit [dBµV/m]	Margin [dB]	Detector	Polarity
1	2225.49	47.45	27.55	6.03	-37.65	43.38	74.00	30.62	PK	Horizontal
2	2740.28	47.78	27.58	5.58	-39.10	41.84	74.00	32.16	PK	Horizontal
3	4194.48	46.38	31.20	6.46	-40.38	43.66	74.00	30.34	PK	Horizontal
4	7341.76	44.62	36.82	8.91	-41.55	48.80	74.00	25.20	PK	Horizontal
5	11189.25	42.87	39.21	9.67	-39.18	52.57	74.00	21.43	PK	Horizontal
6	15713.78	39.12	38.47	14.63	-39.19	53.03	74.00	20.97	PK	Horizontal

Note:

- Level = Reading + Cable loss + Antenna Factor + AMP
- If Peak Result complies with AV limit, AV Result is deemed to comply with AV limit.
- Test setup: RBW: 1 MHz, VBW: 3 MHz, Sweep time: auto.

TR-4-E-009 Radiated Emission Test Result

Test Date: 2023-11-25 **Tested By:** Junchang Du
EUT: Active Speaker **Model Number:** EDF100078
Test Mode: SRD TX 5787MHz **Power Supply:** AC 120V/60Hz
Condition: Temp:22.6°C;Humi:57.0% **Test Site:** DDT 3# Chamber
File Path: d:\ts\2023 report data\Q23103011-2E EDF100078\FCC ABOVE 1G 5G SRD\32
Memo: Sample Number:S23103011-03 Power Setting:5 ANT2

Test Graph

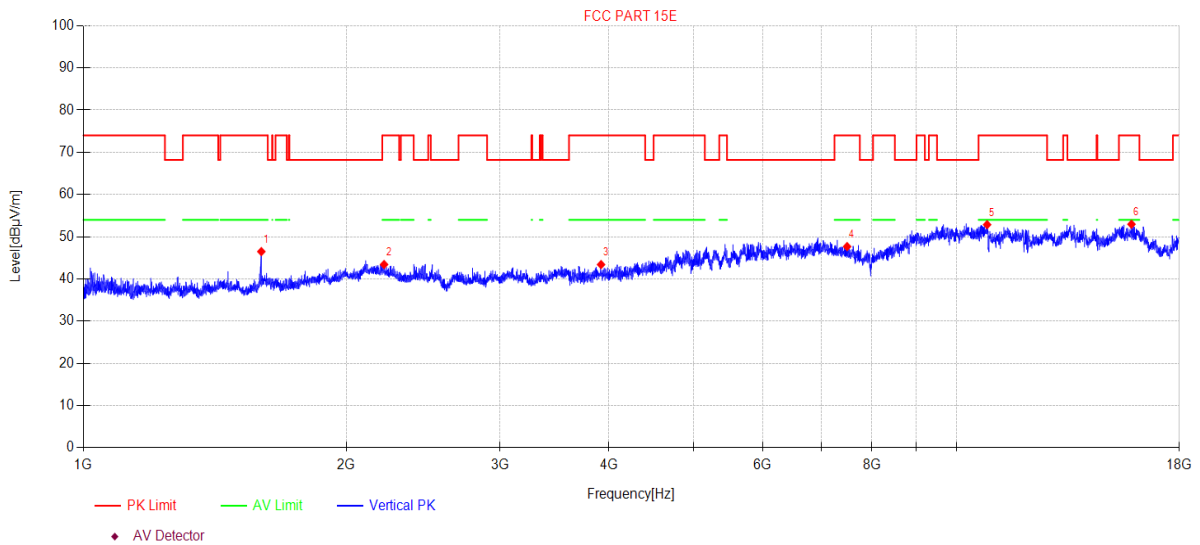

Data List										
N O.	Freq. [MHz]	Reading [dBμV/m]	Antenna Factor [dB]	Cable loss [dB]	AMP [dB]	Level [dBμV/m]	Limit [dBμV/m]	Margin [dB]	Detector	Polarity
1	1598.95	52.95	25.58	4.91	-36.96	46.48	74.00	27.52	PK	Vertical
2	2210.10	47.27	27.70	6.05	-37.60	43.42	74.00	30.58	PK	Vertical
3	3916.80	46.61	31.17	6.02	-40.40	43.40	74.00	30.60	PK	Vertical
4	7493.97	44.21	36.51	8.88	-41.93	47.67	74.00	26.33	PK	Vertical
5	10842.26	43.03	39.36	9.50	-39.03	52.86	74.00	21.14	PK	Vertical
6	15864.36	38.68	38.17	15.39	-39.28	52.96	74.00	21.04	PK	Vertical

Note:

- Level = Reading + Cable loss + Antenna Factor + AMP
- If Peak Result complies with AV limit, AV Result is deemed to comply with AV limit.
- Test setup: RBW: 1 MHz, VBW: 3 MHz, Sweep time: auto.

TR-4-E-009 Radiated Emission Test Result

Test Date: 2023-11-28 **Tested By:** Junchang Du
EUT: Active Speaker **Model Number:** EDF100078
Test Mode: SRD TX 5845MHz **Power Supply:** AC 120V/60Hz
Condition: Temp:22.6°C;Humi:57.0% **Test Site:** DDT 3# Chamber
File Path: d:\ts\2023 report data\Q23103011-2E EDF100078\FCC ABOVE 1G 5G SRD\45
Memo: Sample Number:S23103011-03 Power Setting:5 ANT2

Test Graph

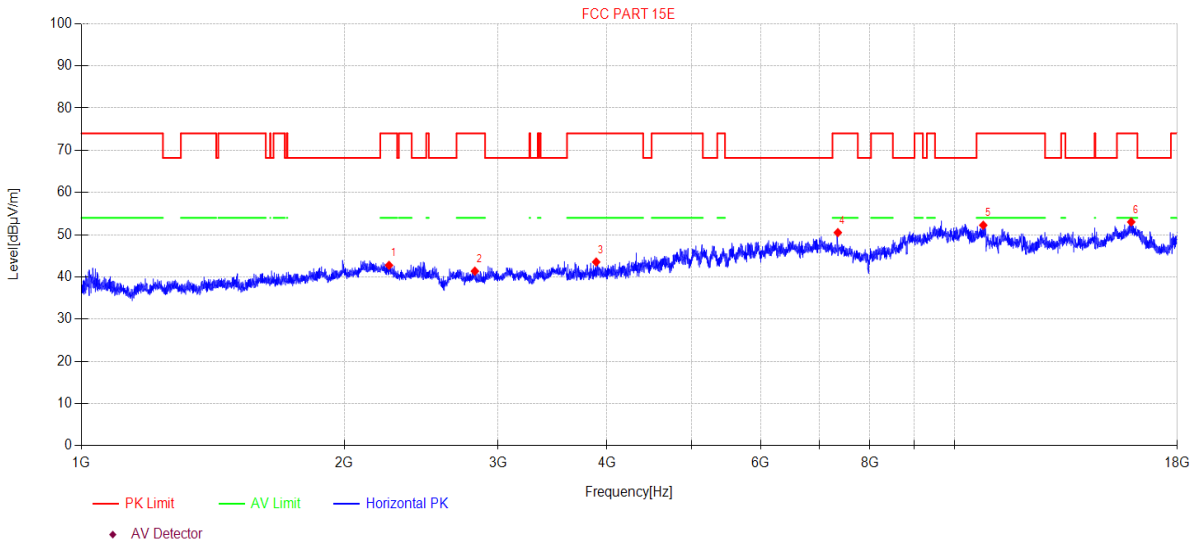

Data List										
N O.	Freq. [MHz]	Reading [dBµV/m]	Antenna Factor [dB]	Cable loss [dB]	AMP [dB]	Level [dBµV/m]	Limit [dBµV/m]	Margin [dB]	Detector	Polarity
1	2251.36	47.17	27.29	6.01	-37.72	42.75	74.00	31.25	PK	Horizontal
2	2823.08	47.63	27.58	5.51	-39.34	41.38	74.00	32.62	PK	Horizontal
3	3887.48	46.80	31.12	6.00	-40.38	43.54	74.00	30.46	PK	Horizontal
4	7352.38	46.38	36.80	8.90	-41.58	50.50	74.00	23.50	PK	Horizontal
5	10789.12	42.36	39.40	9.50	-39.01	52.25	74.00	21.75	PK	Horizontal
6	15937.89	38.52	38.06	15.76	-39.32	53.02	74.00	20.98	PK	Horizontal

Note:

1. Level = Reading + Cable loss + Antenna Factor + AMP
2. If Peak Result complies with AV limit, AV Result is deemed to comply with AV limit.
3. Test setup: RBW: 1 MHz, VBW: 3 MHz, Sweep time: auto.

TR-4-E-009 Radiated Emission Test Result

Test Date: 2023-11-28 **Tested By:** Junchang Du
EUT: Active Speaker **Model Number:** EDF100078
Test Mode: SRD TX 5845MHz **Power Supply:** AC 120V/60Hz
Condition: Temp:22.6°C;Humi:57.0% **Test Site:** DDT 3# Chamber
File Path: d:\ts\2023 report data\Q23103011-2E EDF100078\FCC ABOVE 1G 5G SRD\46
Memo: Sample Number:S23103011-03 Power Setting:5 ANT2

Test Graph

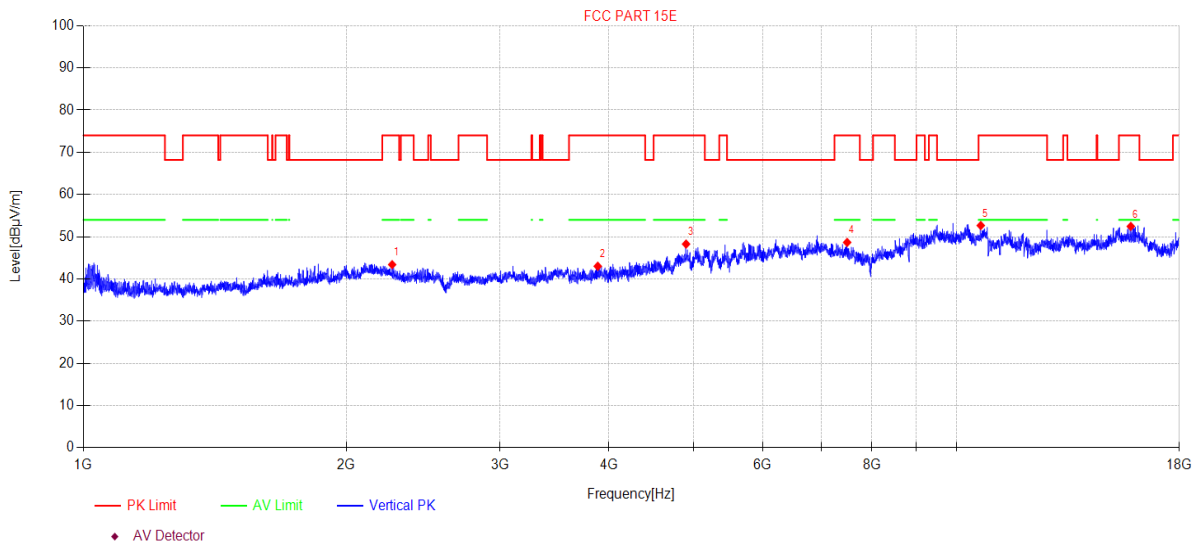

Data List										
N O.	Freq. [MHz]	Reading [dBµV/m]	Antenna Factor [dB]	Cable loss [dB]	AMP [dB]	Level [dBµV/m]	Limit [dBµV/m]	Margin [dB]	Detector	Polarity
1	2257.88	47.91	27.22	6.00	-37.74	43.39	74.00	30.61	PK	Vertical
2	3882.99	46.30	31.10	5.99	-40.38	43.01	74.00	30.99	PK	Vertical
3	4901.52	47.56	33.00	7.82	-40.12	48.26	74.00	25.74	PK	Vertical
4	7496.14	45.21	36.51	8.88	-41.94	48.66	74.00	25.34	PK	Vertical
5	10662.03	42.81	39.32	9.49	-38.96	52.66	74.00	21.34	PK	Vertical
6	15836.88	38.23	38.23	15.25	-39.26	52.45	74.00	21.55	PK	Vertical

Note:

- Level = Reading + Cable loss + Antenna Factor + AMP
- If Peak Result complies with AV limit, AV Result is deemed to comply with AV limit.
- Test setup: RBW: 1 MHz, VBW: 3 MHz, Sweep time: auto.

TR-4-E-009 Radiated Emission Test Result

Test Date: 2023-11-30 **Tested By:** Junchang Du
EUT: Active Speaker **Model Number:** EDF100078
Test Mode: SRD TX 5729MHz DH5 TX 2402MHz **Power Supply:** AC 120V/60Hz
Condition: Temp:22.6°C;Humi:57.0% **Test Site:** DDT 3# Chamber
File Path: d:\ts\2023 report data\Q23103011-2E EDF100078\FCC ABOVE 1G 5G SRD\3
Memo: Sample Number:S23103011-03 Power Setting:5/NA

Test Graph

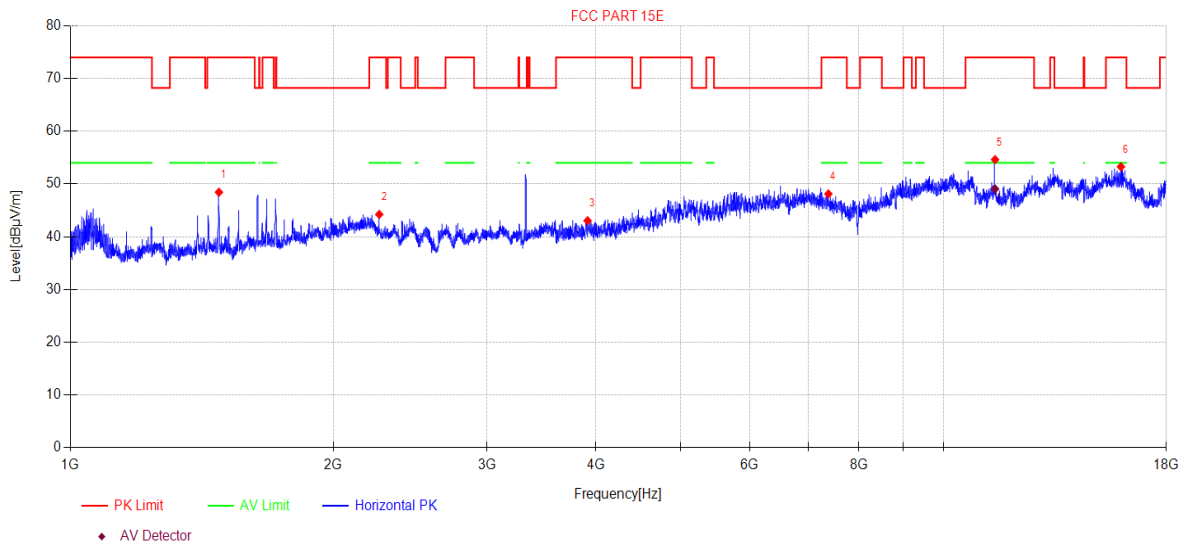

Data List										
NO	Freq. [MHz]	Reading [dBµV/m]	Antenna Factor [dB]	Cable loss [dB]	AMP [dB]	Level [dBµV/m]	Limit [dBµV/m]	Margin [dB]	Detector	Polarity
1	1479.78	55.45	25.42	4.51	-36.94	48.44	74.00	25.56	PK	Horizontal
2	2258.53	48.76	27.21	6.00	-37.74	44.23	74.00	29.77	PK	Horizontal
3	3912.28	46.23	31.18	6.02	-40.40	43.03	74.00	30.97	PK	Horizontal
4	7382.19	44.13	36.74	8.90	-41.66	48.11	74.00	25.89	PK	Horizontal
5	11457.58	44.80	39.24	9.89	-39.31	54.62	74.00	19.38	PK	Horizontal
6	15970.17	38.65	38.03	15.92	-39.34	53.26	74.00	20.74	PK	Horizontal

Data List										
NO	Freq. [MHz]	Reading [dBµV/m]	Antenna Factor [dB]	Cable loss [dB]	AMP [dB]	Level [dBµV/m]	Limit [dBµV/m]	Margin [dB]	Detector	Polarity
1	11457.92	39.24	39.24	9.89	-39.31	49.06	54.00	4.94	AV	Horizontal

Note:

1. Level = Reading + Cable loss + Antenna Factor + AMP
2. If Peak Result complies with AV limit, AV Result is deemed to comply with AV limit.
3. Test setup: RBW: 1 MHz, VBW: 3 MHz, Sweep time: auto.

TR-4-E-009 Radiated Emission Test Result

Test Date: 2023-11-30 **Tested By:** Junchang Du
EUT: Active Speaker **Model Number:** EDF100078
Test Mode: SRD TX 5729MHz DH5 TX 2402MHz **Power Supply:** AC 120V/60Hz
Condition: Temp:22.6°C;Humi:57.0% **Test Site:** DDT 3# Chamber
File Path: d:\ts\2023 report data\Q23103011-2E EDF100078\FCC ABOVE 1G 5G SRD\4
Memo: Sample Number:S23103011-03 Power Setting:5/NA

Test Graph

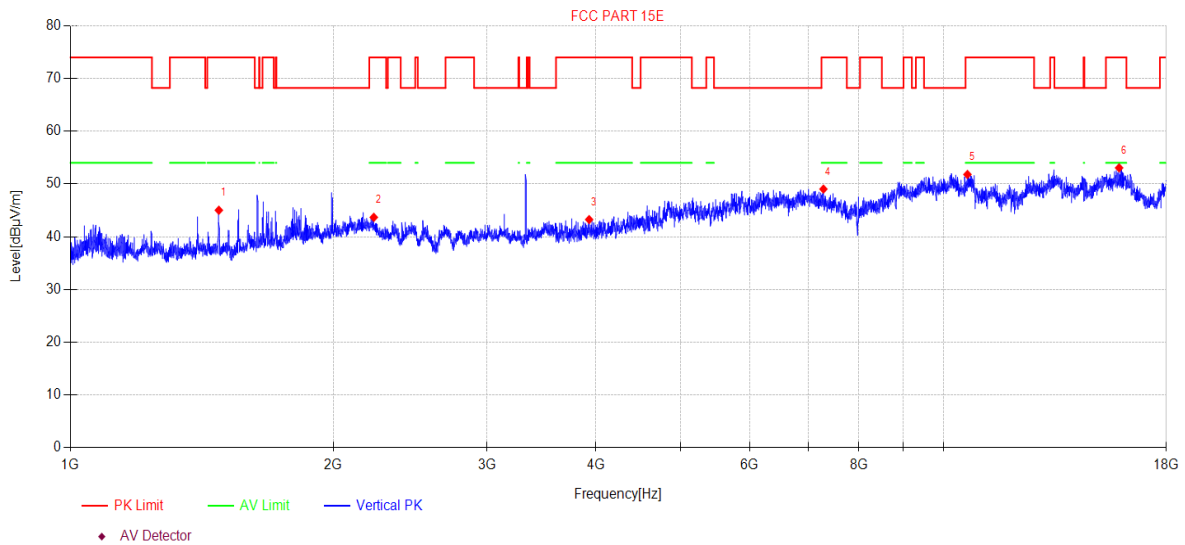

Data List										
NO	Freq. [MHz]	Reading [dBµV/m]	Antenna Factor [dB]	Cable loss [dB]	AMP [dB]	Level [dBµV/m]	Limit [dBµV/m]	Margin [dB]	Detector	Polarity
1	1479.36	52.03	25.42	4.51	-36.94	45.02	74.00	28.98	PK	Vertical
2	2226.13	47.76	27.54	6.03	-37.65	43.68	74.00	30.32	PK	Vertical
3	3928.14	46.50	31.14	6.03	-40.41	43.26	74.00	30.74	PK	Vertical
4	7286.80	44.67	36.87	8.91	-41.42	49.03	74.00	24.97	PK	Vertical
5	10652.79	41.96	39.31	9.49	-38.96	51.80	74.00	22.20	PK	Vertical
6	15891.89	38.70	38.12	15.53	-39.30	53.05	74.00	20.95	PK	Vertical

Note:

1. Level = Reading + Cable loss + Antenna Factor + AMP
2. If Peak Result complies with AV limit, AV Result is deemed to comply with AV limit.
3. Test setup: RBW: 1 MHz, VBW: 3 MHz, Sweep time: auto.

11. Band Edge Compliance

11.1. Test equipment

Equipment	Manufacturer	Model No.	Serial Number	Due Date
☑Radiation 3#Chamber				
EMI TEST RECEIVER	R&S	ESU26	100472	2024/04/22
Double Ridged Horn Antenna	Schwarzbeck	BBHA 9120 D	02468	2024/09/17
Pre-amplifier	COM-POWER	PAM-118A	18040084	2024/07/14
RF Cable	Yuhu	JCTB810-NJ-NJ-9M+ ZT26S-SMAJ-SMAJ-1M	21123964	2024/04/22
Test Software	Tonscend	JS32-RE	V 5.0.0.1	N/A

11.2. Block diagram of test setup

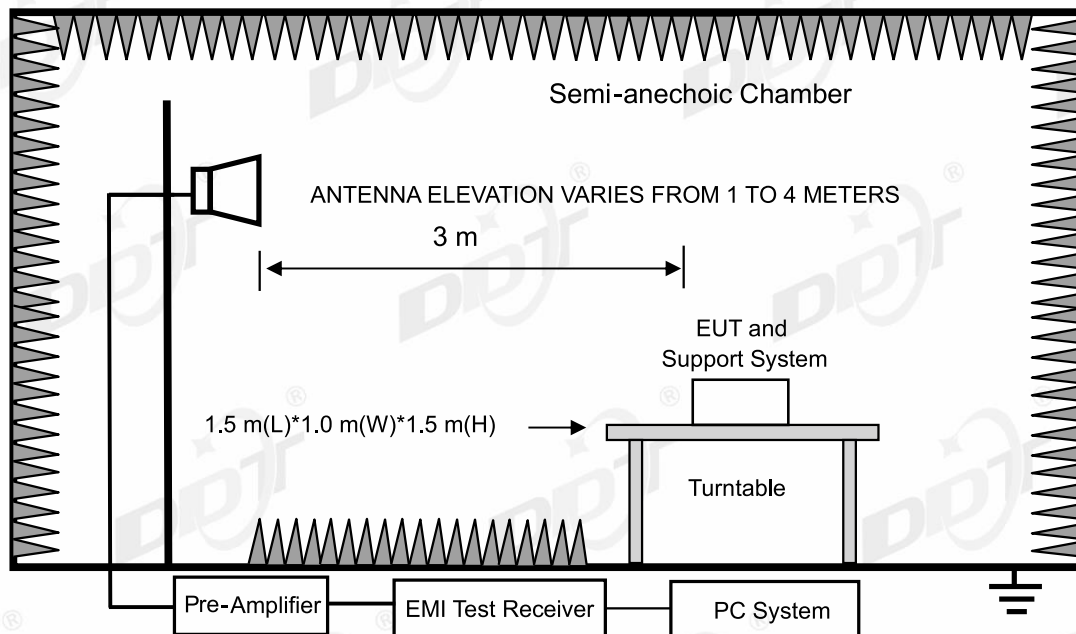

11.3. Limit

- (1) For transmitters operating in the 5.15-5.25 GHz band: All emissions outside of the 5.15-5.35 GHz band shall not exceed an e.i.r.p. of -27 dBm/MHz.
- (2) For transmitters operating in the 5.25-5.35 GHz band: All emissions outside of the 5.15-5.35 GHz band shall not exceed an e.i.r.p. of -27 dBm/MHz.
- (3) For transmitters operating in the 5.47-5.725 GHz band: All emissions outside of the 5.47-5.725 GHz band shall not exceed an e.i.r.p. of -27 dBm/MHz.
- (4) For transmitters operating solely in the 5.725-5.850 GHz band:

All emissions shall be limited to a level of -27 dBm/MHz at 75 MHz or more above or below the band edge increasing linearly to 10 dBm/MHz at 25 MHz above or below the band edge, and from

25 MHz above or below the band edge increasing linearly to a level of 15.6 dBm/MHz at 5 MHz above or below the band edge, and from 5 MHz above or below the band edge increasing linearly to a level of 27 dBm/MHz at the band edge.

11.4. Test Procedure

Same with Emissions in Restricted Frequency Bands except change investigated frequency range from 5.15-5.25 GHz, 5250-5350 GHz, 5470-5725 GHz, 5.725-5.85 GHz.

Remark: All restriction band have been tested, and only the worst case is shown in report.

11.5. Test result

Pass. (See below detailed test result)

Note: As specified in 15.407(b), emissions above 1000 MHz that are outside of the restricted bands are subject to a peak emission limit of -27 dBm/MHz. However, out-of-band emission that complies with both the average and peak limits of 15.209 is not required to satisfy the -27 dBm/MHz peak emission limit

TR-4-E-009 Radiated Emission Test Result

Test Date: 2023-11-28 **Tested By:** Junchang Du
EUT: Active Speaker **Model Number:** EDF100078
Test Mode: SRD TX 5729MHz **Power Supply:** AC 120V/60Hz
Condition: Temp:22.6°C;Humi:57.0% **Test Site:** DDT 3# Chamber
File Path: d:\ts\2023 report data\Q23103011-2E EDF100078\FCC ABOVE 1G 5G SRD MASK\45
Memo: Sample Number:S23103011-03 Power Setting:5 ANT1

Test Graph

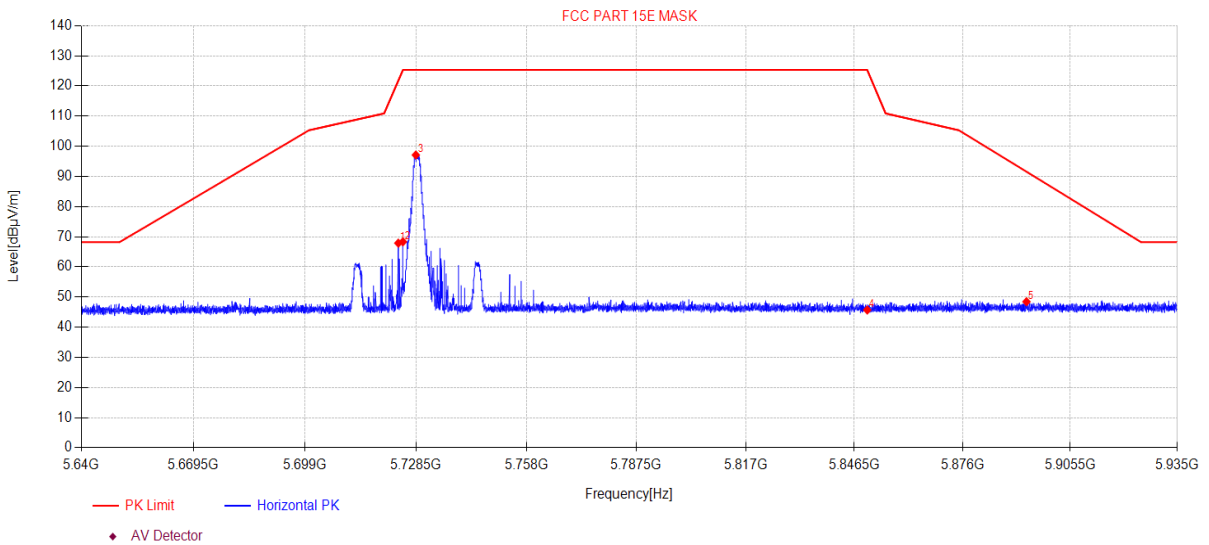

Data List										
N O.	Freq. [MHz]	Reading [dBμV/m]	Antenna Factor [dB]	Cable loss [dB]	AMP [dB]	Level [dBμV/m]	Limit [dBμV/m]	Margin [dB]	Detector	Polarity
1	5723.78	68.25	33.74	5.87	-39.99	67.87	121.79	53.92	PK	Horizontal
2	5725.00	68.69	33.75	5.87	-39.99	68.32	125.30	56.98	PK	Horizontal
3	5728.44	97.47	33.77	5.87	-39.99	97.12	125.30	28.18	PK	Horizontal
4	5850.00	45.73	34.00	5.94	-39.97	45.70	125.27	79.57	PK	Horizontal
5	5893.49	48.36	34.09	5.96	-39.96	48.45	91.58	43.13	PK	Horizontal

Note:

1. Level = Reading + Cable loss + Antenna Factor + AMP
2. If Peak Result complies with AV limit, AV Result is deemed to comply with AV limit.
3. Test setup: RBW: 1 MHz, VBW: 3 MHz, Sweep time: auto.

TR-4-E-009 Radiated Emission Test Result

Test Date: 2023-11-28 **Tested By:** Junchang Du
EUT: Active Speaker **Model Number:** EDF100078
Test Mode: SRD TX 5729MHz **Power Supply:** AC 120V/60Hz
Condition: Temp:22.6°C;Humi:57.0% **Test Site:** DDT 3# Chamber
File Path: d:\ts\2023 report data\Q23103011-2E EDF100078\FCC ABOVE 1G 5G SRD MASK\46
Memo: Sample Number:S23103011-03 Power Setting:5 ANT1

Test Graph

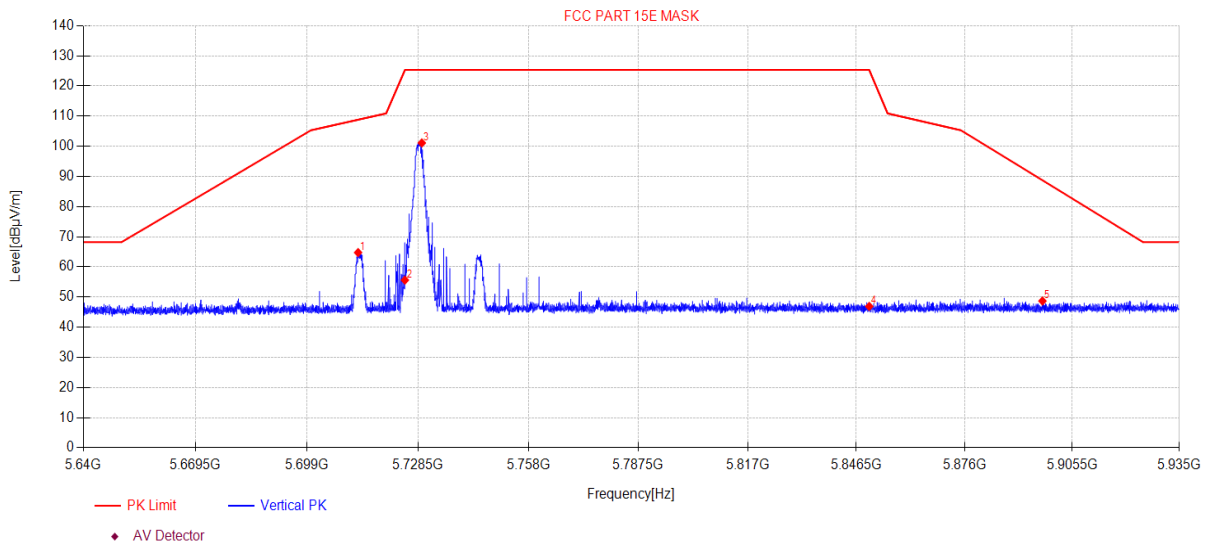

Data List										
N O.	Freq. [MHz]	Reading [dBμV/m]	Antenna Factor [dB]	Cable loss [dB]	AMP [dB]	Level [dBμV/m]	Limit [dBμV/m]	Margin [dB]	Detector	Polarity
1	5712.54	65.19	33.68	5.87	-39.99	64.75	108.81	44.06	PK	Vertical
2	5725.00	55.97	33.75	5.87	-39.99	55.60	125.30	69.70	PK	Vertical
3	5729.50	101.45	33.78	5.87	-39.99	101.11	125.30	24.19	PK	Vertical
4	5850.00	46.94	34.00	5.94	-39.97	46.91	125.27	78.36	PK	Vertical
5	5897.33	48.60	34.09	5.96	-39.96	48.69	88.73	40.04	PK	Vertical

Note:

1. Level = Reading + Cable loss + Antenna Factor + AMP
2. If Peak Result complies with AV limit, AV Result is deemed to comply with AV limit.
3. Test setup: RBW: 1 MHz, VBW: 3 MHz, Sweep time: auto.

TR-4-E-009 Radiated Emission Test Result

Test Date: 2023-11-25 **Tested By:** Junchang Du
EUT: Active Speaker **Model Number:** EDF100078
Test Mode: SRD TX 5787MHz **Power Supply:** AC 120V/60Hz
Condition: Temp:22.6°C;Humi:57.0% **Test Site:** DDT 3# Chamber
File Path: d:\ts\2023 report data\Q23103011-2E EDF100078\FCC ABOVE 1G 5G SRD MASK\35
Memo: Sample Number:S23103011-03 Power Setting:5 ANT1

Test Graph

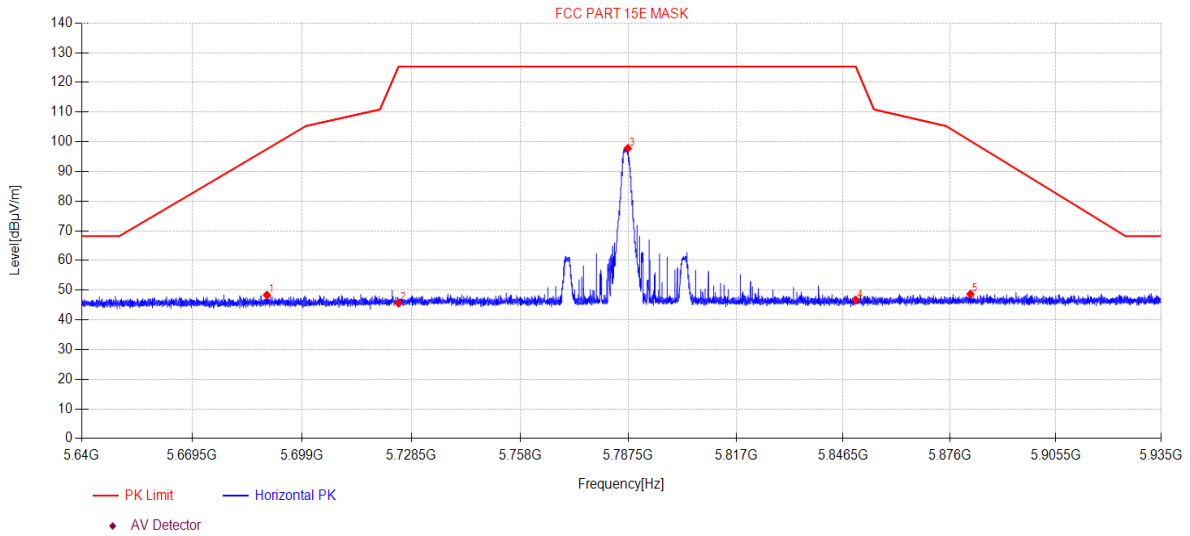

Data List										
N O.	Freq. [MHz]	Reading [dBµV/m]	Antenna Factor [dB]	Cable loss [dB]	AMP [dB]	Level [dBµV/m]	Limit [dBµV/m]	Margin [dB]	Detector	Polarity
1	5689.53	48.91	33.56	5.85	-39.99	48.33	97.53	49.20	PK	Horizontal
2	5725.00	46.01	33.75	5.87	-39.99	45.64	125.30	79.66	PK	Horizontal
3	5787.35	97.76	34.12	5.90	-39.98	97.80	125.30	27.50	PK	Horizontal
4	5850.00	46.71	34.00	5.94	-39.97	46.68	125.27	78.59	PK	Horizontal
5	5881.75	48.63	34.06	5.95	-39.97	48.67	100.29	51.62	PK	Horizontal

Note:

1. Level = Reading + Cable loss + Antenna Factor + AMP
2. If Peak Result complies with AV limit, AV Result is deemed to comply with AV limit.
3. Test setup: RBW: 1 MHz, VBW: 3 MHz, Sweep time: auto.

TR-4-E-009 Radiated Emission Test Result

Test Date: 2023-11-25 **Tested By:** Junchang Du
EUT: Active Speaker **Model Number:** EDF100078
Test Mode: SRD TX 5787MHz **Power Supply:** AC 120V/60Hz
Condition: Temp:22.6°C;Humi:57.0% **Test Site:** DDT 3# Chamber
File Path: d:\ts\2023 report data\Q23103011-2E EDF100078\FCC ABOVE 1G 5G SRD MASK\36
Memo: Sample Number:S23103011-03 Power Setting:5 ANT1

Test Graph

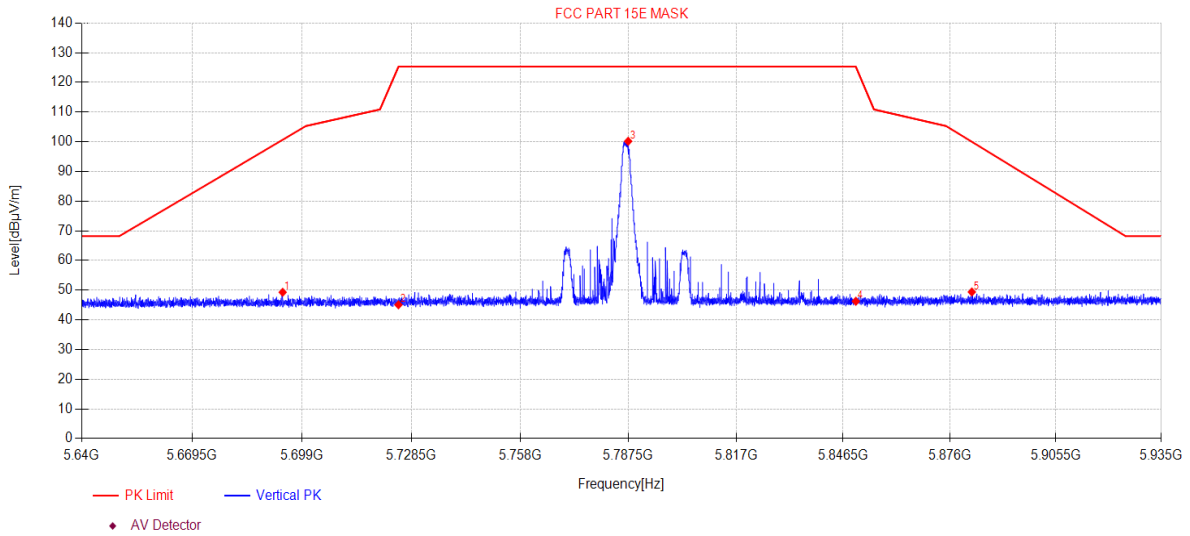

Data List										
N O.	Freq. [MHz]	Reading [dBµV/m]	Antenna Factor [dB]	Cable loss [dB]	AMP [dB]	Level [dBµV/m]	Limit [dBµV/m]	Margin [dB]	Detector	Polarity
1	5693.78	49.85	33.58	5.86	-39.99	49.30	100.68	51.38	PK	Vertical
2	5725.00	45.44	33.75	5.87	-39.99	45.07	125.30	80.23	PK	Vertical
3	5787.44	100.14	34.12	5.90	-39.98	100.18	125.30	25.12	PK	Vertical
4	5850.00	46.28	34.00	5.94	-39.97	46.25	125.27	79.02	PK	Vertical
5	5882.14	49.35	34.06	5.95	-39.97	49.39	100.01	50.62	PK	Vertical

Note:

1. Level = Reading + Cable loss + Antenna Factor + AMP
2. If Peak Result complies with AV limit, AV Result is deemed to comply with AV limit.
3. Test setup: RBW: 1 MHz, VBW: 3 MHz, Sweep time: auto.

TR-4-E-009 Radiated Emission Test Result

Test Date: 2023-11-28 **Tested By:** Junchang Du
EUT: Active Speaker **Model Number:** EDF100078
Test Mode: SRD TX 5845MHz **Power Supply:** AC 120V/60Hz
Condition: Temp:22.6°C;Humi:57.0% **Test Site:** DDT 3# Chamber
File Path: d:\ts\2023 report data\Q23103011-2E EDF100078\FCC ABOVE 1G 5G SRD MASK\47
Memo: Sample Number:S23103011-03 Power Setting:5 ANT1

Test Graph

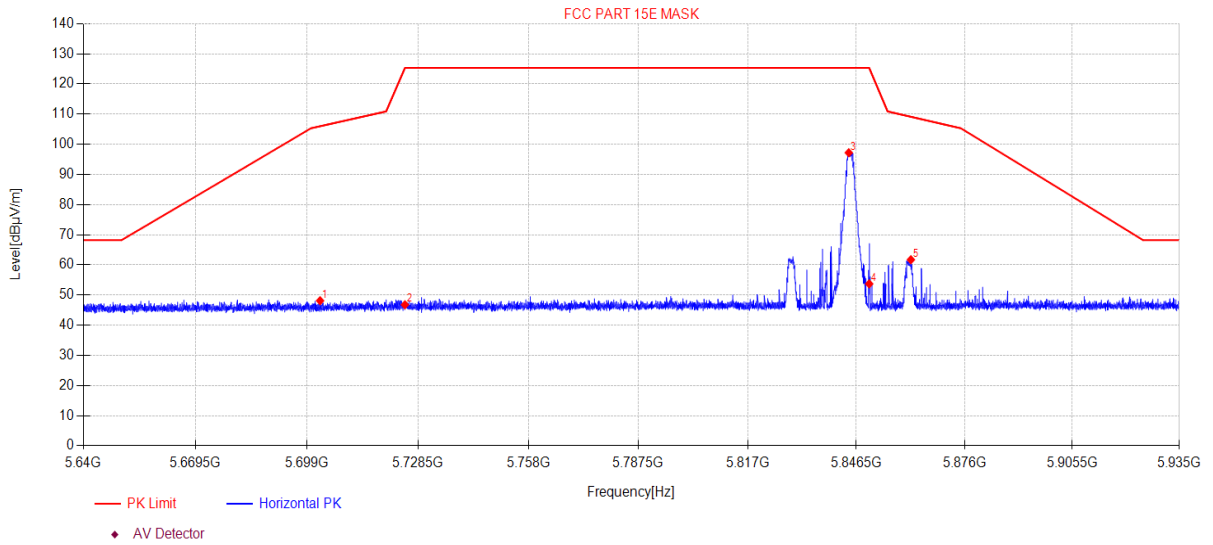

Data List										
N O.	Freq. [MHz]	Reading [dBµV/m]	Antenna Factor [dB]	Cable loss [dB]	AMP [dB]	Level [dBµV/m]	Limit [dBµV/m]	Margin [dB]	Detector	Polarity
1	5702.45	48.64	33.61	5.86	-39.99	48.12	105.99	57.87	PK	Horizontal
2	5725.00	47.15	33.75	5.87	-39.99	46.78	125.30	78.52	PK	Horizontal
3	5844.44	97.21	34.02	5.93	-39.97	97.19	125.30	28.11	PK	Horizontal
4	5850.00	53.74	34.00	5.94	-39.97	53.71	125.27	71.56	PK	Horizontal
5	5861.34	61.72	34.02	5.94	-39.97	61.71	109.13	47.42	PK	Horizontal

Note:

1. Level = Reading + Cable loss + Antenna Factor + AMP
2. If Peak Result complies with AV limit, AV Result is deemed to comply with AV limit.
3. Test setup: RBW: 1 MHz, VBW: 3 MHz, Sweep time: auto.

TR-4-E-009 Radiated Emission Test Result

Test Date: 2023-11-28 **Tested By:** Junchang Du
EUT: Active Speaker **Model Number:** EDF100078
Test Mode: SRD TX 5845MHz **Power Supply:** AC 120V/60Hz
Condition: Temp:22.6°C;Humi:57.0% **Test Site:** DDT 3# Chamber
File Path: d:\ts\2023 report data\Q23103011-2E EDF100078\FCC ABOVE 1G 5G SRD MASK\48
Memo: Sample Number:S23103011-03 Power Setting:5 ANT1

Test Graph

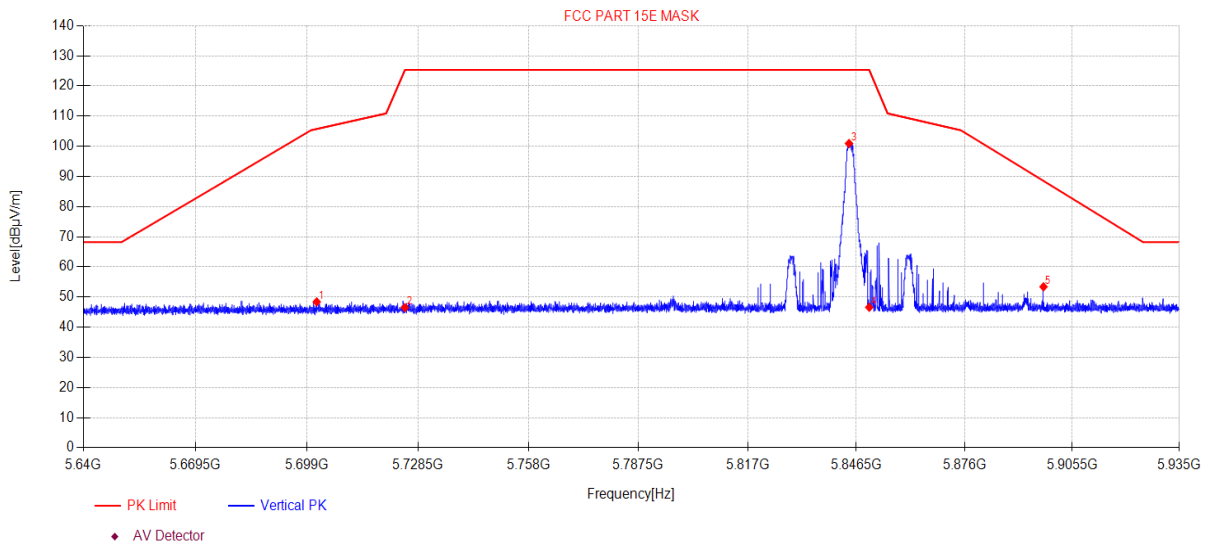

Data List										
N O.	Freq. [MHz]	Reading [dBμV/m]	Antenna Factor [dB]	Cable loss [dB]	AMP [dB]	Level [dBμV/m]	Limit [dBμV/m]	Margin [dB]	Detector	Polarity
1	5701.57	48.91	33.61	5.86	-39.99	48.39	105.74	57.35	PK	Vertical
2	5725.00	46.86	33.75	5.87	-39.99	46.49	125.30	78.81	PK	Vertical
3	5844.49	100.95	34.02	5.93	-39.97	100.93	125.30	24.37	PK	Vertical
4	5850.00	46.62	34.00	5.94	-39.97	46.59	125.27	78.68	PK	Vertical
5	5897.62	53.29	34.10	5.96	-39.96	53.39	88.51	35.12	PK	Vertical

Note:

- Level = Reading + Cable loss + Antenna Factor + AMP
- If Peak Result complies with AV limit, AV Result is deemed to comply with AV limit.
- Test setup: RBW: 1 MHz, VBW: 3 MHz, Sweep time: auto.

TR-4-E-009 Radiated Emission Test Result

Test Date: 2023-11-28 **Tested By:** Junchang Du
EUT: Active Speaker **Model Number:** EDF100078
Test Mode: SRD TX 5729MHz **Power Supply:** AC 120V/60Hz
Condition: Temp:22.6°C;Humi:57.0% **Test Site:** DDT 3# Chamber
File Path: d:\ts\2023 report data\Q23103011-2E EDF100078\FCC ABOVE 1G 5G SRD MASK\49
Memo: Sample Number:S23103011-03 Power Setting:5 ANT2

Test Graph

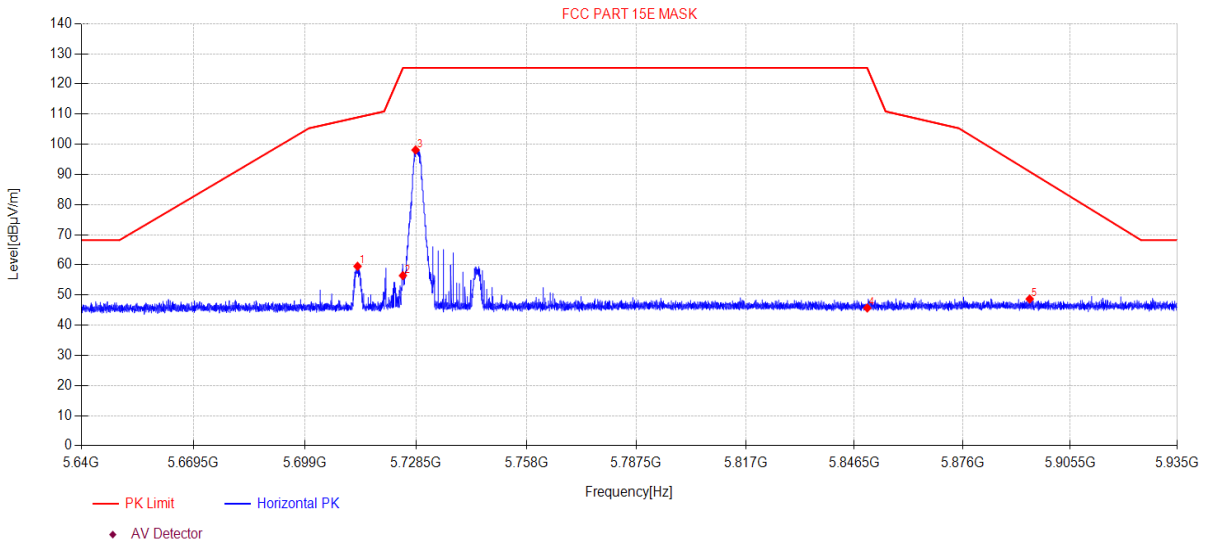

Data List										
N O.	Freq. [MHz]	Reading [dBµV/m]	Antenna Factor [dB]	Cable loss [dB]	AMP [dB]	Level [dBµV/m]	Limit [dBµV/m]	Margin [dB]	Detector	Polarity
1	5712.92	59.97	33.68	5.87	-39.99	59.53	108.92	49.39	PK	Horizontal
2	5725.00	56.83	33.75	5.87	-39.99	56.46	125.30	68.84	PK	Horizontal
3	5728.38	98.46	33.77	5.87	-39.99	98.11	125.30	27.19	PK	Horizontal
4	5850.00	45.73	34.00	5.94	-39.97	45.70	125.27	79.57	PK	Horizontal
5	5894.38	48.60	34.09	5.96	-39.96	48.69	90.92	42.23	PK	Horizontal

Note:

1. Level = Reading + Cable loss + Antenna Factor + AMP
2. If Peak Result complies with AV limit, AV Result is deemed to comply with AV limit.
3. Test setup: RBW: 1 MHz, VBW: 3 MHz, Sweep time: auto.

TR-4-E-009 Radiated Emission Test Result

Test Date: 2023-11-28 **Tested By:** Junchang Du
EUT: Active Speaker **Model Number:** EDF100078
Test Mode: SRD TX 5729MHz **Power Supply:** AC 120V/60Hz
Condition: Temp:22.6°C;Humi:57.0% **Test Site:** DDT 3# Chamber
File Path: d:\ts\2023 report data\Q23103011-2E EDF100078\FCC ABOVE 1G 5G SRD MASK\50
Memo: Sample Number:S23103011-03 Power Setting:5 ANT2

Test Graph

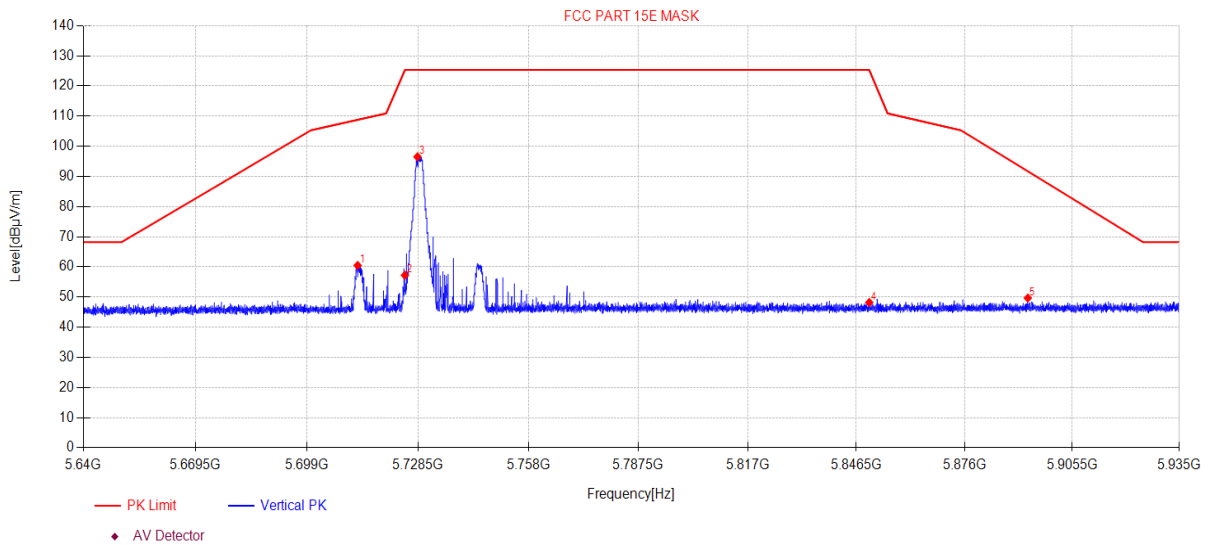

Data List										
N O.	Freq. [MHz]	Reading [dBμV/m]	Antenna Factor [dB]	Cable loss [dB]	AMP [dB]	Level [dBμV/m]	Limit [dBμV/m]	Margin [dB]	Detector	Polarity
1	5712.42	60.93	33.67	5.87	-39.99	60.48	108.78	48.30	PK	Vertical
2	5725.00	57.60	33.75	5.87	-39.99	57.23	125.30	68.07	PK	Vertical
3	5728.35	96.85	33.77	5.87	-39.99	96.50	125.30	28.80	PK	Vertical
4	5850.00	48.23	34.00	5.94	-39.97	48.20	125.27	77.07	PK	Vertical
5	5893.32	49.58	34.09	5.96	-39.96	49.67	91.71	42.04	PK	Vertical

Note:

1. Level = Reading + Cable loss + Antenna Factor + AMP
2. If Peak Result complies with AV limit, AV Result is deemed to comply with AV limit.
3. Test setup: RBW: 1 MHz, VBW: 3 MHz, Sweep time: auto.

TR-4-E-009 Radiated Emission Test Result

Test Date: 2023-11-25 **Tested By:** Junchang Du
EUT: Active Speaker **Model Number:** EDF100078
Test Mode: SRD TX 5787MHz **Power Supply:** AC 120V/60Hz
Condition: Temp:22.6°C;Humi:57.0% **Test Site:** DDT 3# Chamber
File Path: d:\ts\2023 report data\Q23103011-2E EDF100078\FCC ABOVE 1G 5G SRD MASK\31
Memo: Sample Number:S23103011-03 Power Setting:5 ANT2

Test Graph

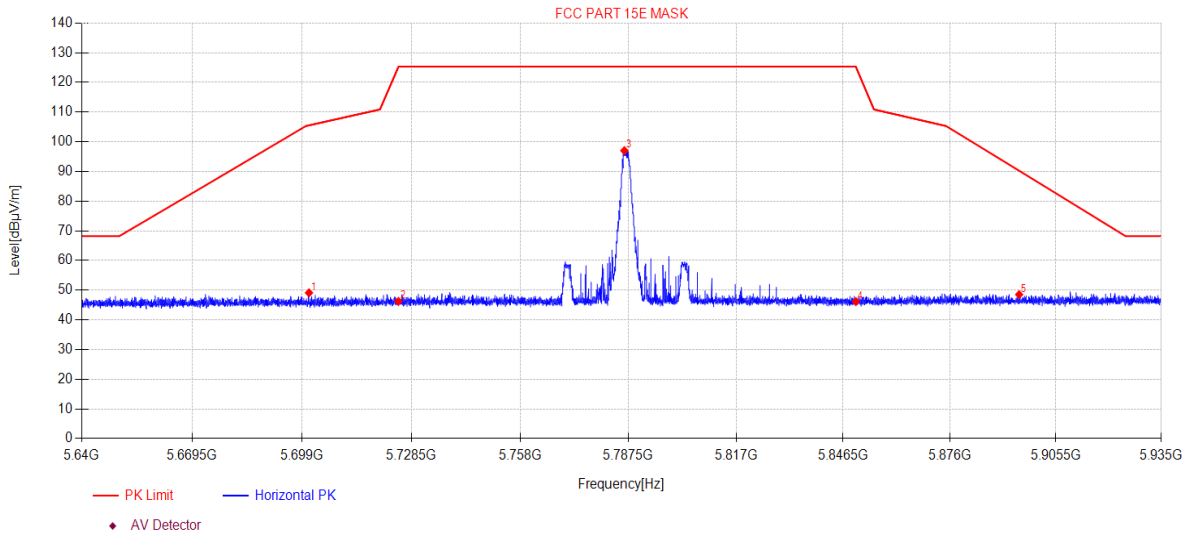

Data List										
N O.	Freq. [MHz]	Reading [dBµV/m]	Antenna Factor [dB]	Cable loss [dB]	AMP [dB]	Level [dBµV/m]	Limit [dBµV/m]	Margin [dB]	Detector	Polarity
1	5700.86	49.63	33.61	5.86	-39.99	49.11	105.54	56.43	PK	Horizontal
2	5725.00	46.60	33.75	5.87	-39.99	46.23	125.30	79.07	PK	Horizontal
3	5786.41	96.98	34.12	5.90	-39.98	97.02	125.30	28.28	PK	Horizontal
4	5850.00	46.19	34.00	5.94	-39.97	46.16	125.27	79.11	PK	Horizontal
5	5895.29	48.43	34.09	5.96	-39.96	48.52	90.24	41.72	PK	Horizontal

Note:

1. Level = Reading + Cable loss + Antenna Factor + AMP
2. If Peak Result complies with AV limit, AV Result is deemed to comply with AV limit.
3. Test setup: RBW: 1 MHz, VBW: 3 MHz, Sweep time: auto.

TR-4-E-009 Radiated Emission Test Result

Test Date: 2023-11-25 **Tested By:** Junchang Du
EUT: Active Speaker **Model Number:** EDF100078
Test Mode: SRD TX 5787MHz **Power Supply:** AC 120V/60Hz
Condition: Temp:22.6°C;Humi:57.0% **Test Site:** DDT 3# Chamber
File Path: d:\ts\2023 report data\Q23103011-2E EDF100078\FCC ABOVE 1G 5G SRD MASK\32
Memo: Sample Number:S23103011-03 Power Setting:5 ANT2

Test Graph

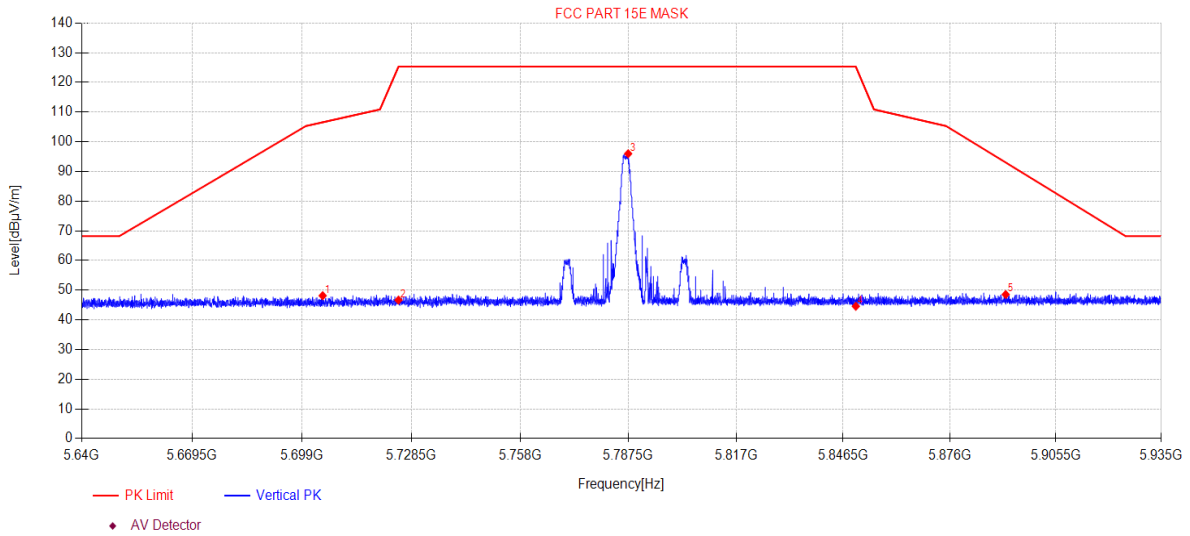

Data List										
N O.	Freq. [MHz]	Reading [dBµV/m]	Antenna Factor [dB]	Cable loss [dB]	AMP [dB]	Level [dBµV/m]	Limit [dBµV/m]	Margin [dB]	Detector	Polarity
1	5704.55	48.63	33.63	5.86	-39.99	48.13	106.57	58.44	PK	Vertical
2	5725.00	47.03	33.75	5.87	-39.99	46.66	125.30	78.64	PK	Vertical
3	5787.44	95.95	34.12	5.90	-39.98	95.99	125.30	29.31	PK	Vertical
4	5850.00	44.60	34.00	5.94	-39.97	44.57	125.27	80.70	PK	Vertical
5	5891.55	48.46	34.08	5.96	-39.96	48.54	93.02	44.48	PK	Vertical

Note:

1. Level = Reading + Cable loss + Antenna Factor + AMP
2. If Peak Result complies with AV limit, AV Result is deemed to comply with AV limit.
3. Test setup: RBW: 1 MHz, VBW: 3 MHz, Sweep time: auto.

TR-4-E-009 Radiated Emission Test Result

Test Date: 2023-11-28 **Tested By:** Junchang Du
EUT: Active Speaker **Model Number:** EDF100078
Test Mode: SRD TX 5845MHz **Power Supply:** AC 120V/60Hz
Condition: Temp:22.6°C;Humi:57.0% **Test Site:** DDT 3# Chamber
File Path: d:\ts\2023 report data\Q23103011-2E EDF100078\FCC ABOVE 1G 5G SRD MASK\51
Memo: Sample Number:S23103011-03 Power Setting:5 ANT2

Test Graph

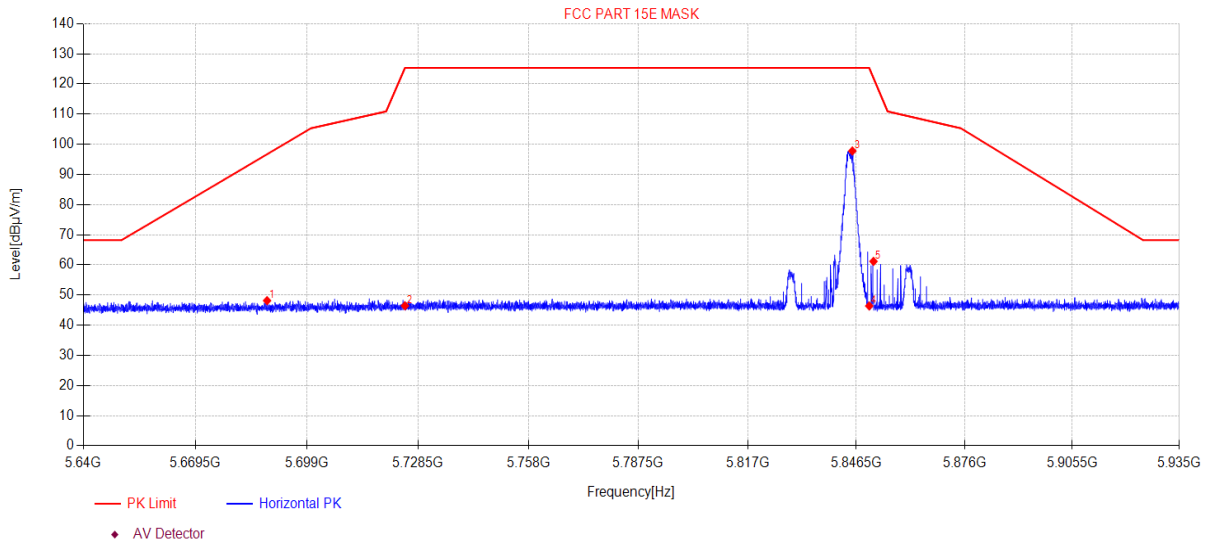

Data List										
N O.	Freq. [MHz]	Reading [dBµV/m]	Antenna Factor [dB]	Cable loss [dB]	AMP [dB]	Level [dBµV/m]	Limit [dBµV/m]	Margin [dB]	Detector	Polarity
1	5688.41	48.73	33.55	5.85	-39.99	48.14	96.70	48.56	PK	Horizontal
2	5725.00	46.80	33.75	5.87	-39.99	46.43	125.30	78.87	PK	Horizontal
3	5845.41	97.80	34.02	5.93	-39.97	97.78	125.30	27.52	PK	Horizontal
4	5850.00	46.41	34.00	5.94	-39.97	46.38	125.27	78.89	PK	Horizontal
5	5851.16	61.19	34.00	5.94	-39.97	61.16	121.96	60.80	PK	Horizontal

Note:

1. Level = Reading + Cable loss + Antenna Factor + AMP
2. If Peak Result complies with AV limit, AV Result is deemed to comply with AV limit.
3. Test setup: RBW: 1 MHz, VBW: 3 MHz, Sweep time: auto.

TR-4-E-009 Radiated Emission Test Result

Test Date: 2023-11-28 **Tested By:** Junchang Du
EUT: Active Speaker **Model Number:** EDF100078
Test Mode: SRD TX 5845MHz **Power Supply:** AC 120V/60Hz
Condition: Temp:22.6°C;Humi:57.0% **Test Site:** DDT 3# Chamber
File Path: d:\ts\2023 report data\Q23103011-2E EDF100078\FCC ABOVE 1G 5G SRD MASK\52
Memo: Sample Number:S23103011-03 Power Setting:5 ANT2

Test Graph

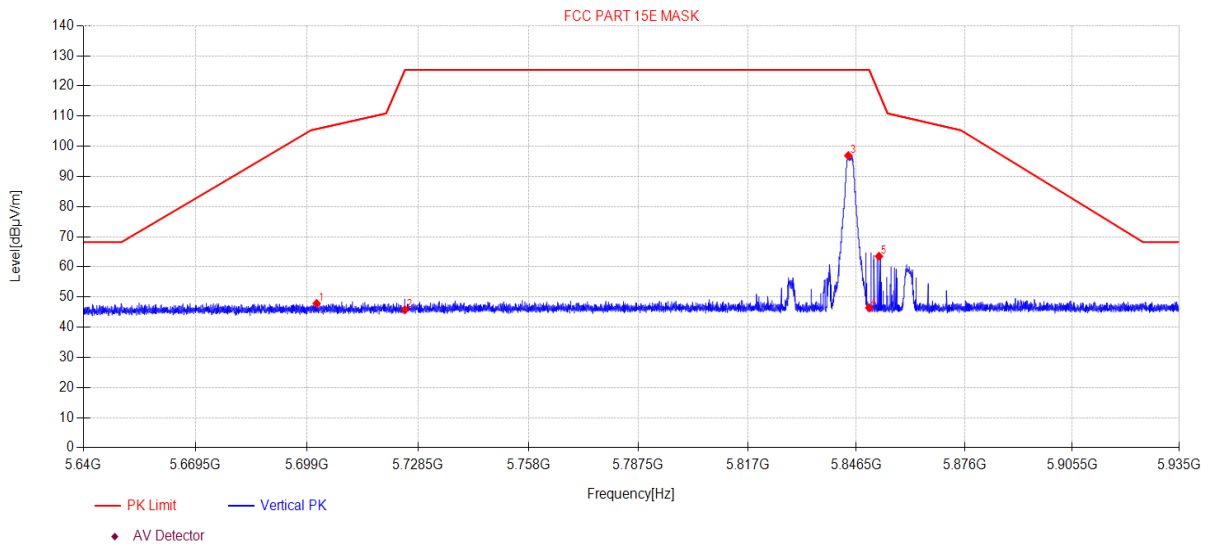

Data List										
N O.	Freq. [MHz]	Reading [dBµV/m]	Antenna Factor [dB]	Cable loss [dB]	AMP [dB]	Level [dBµV/m]	Limit [dBµV/m]	Margin [dB]	Detector	Polarity
1	5701.54	48.38	33.61	5.86	-39.99	47.86	105.73	57.87	PK	Vertical
2	5725.00	46.17	33.75	5.87	-39.99	45.80	125.30	79.50	PK	Vertical
3	5844.32	96.91	34.02	5.93	-39.97	96.89	125.30	28.41	PK	Vertical
4	5850.00	46.43	34.00	5.94	-39.97	46.40	125.27	78.87	PK	Vertical
5	5852.67	63.53	34.01	5.94	-39.97	63.51	117.62	54.11	PK	Vertical

Note:

1. Level = Reading + Cable loss + Antenna Factor + AMP
2. If Peak Result complies with AV limit, AV Result is deemed to comply with AV limit.
3. Test setup: RBW: 1 MHz, VBW: 3 MHz, Sweep time: auto.

12. Power Line Conducted Emission

12.1. Test equipment

Equipment	Manufacturer	Model No.	Serial Number	Due Date
☑Power Line Conducted Emissions Test 1#				
Test Receiver	R&S	ESCI	100551	2024/07/10
LISN 1	R&S	ENV216	101109	2024/07/10
LISN 2	R&S	ESH2-Z5	100309	2024/07/11
Pulse Limiter	R&S	ESH3-Z2	101242	2024/07/14
CE Cable 1	HUBSER	N/A	W10.01	2024/07/14
Test software	Audix	E3	V 6.11111b	N/A

12.2. Block diagram of test setup

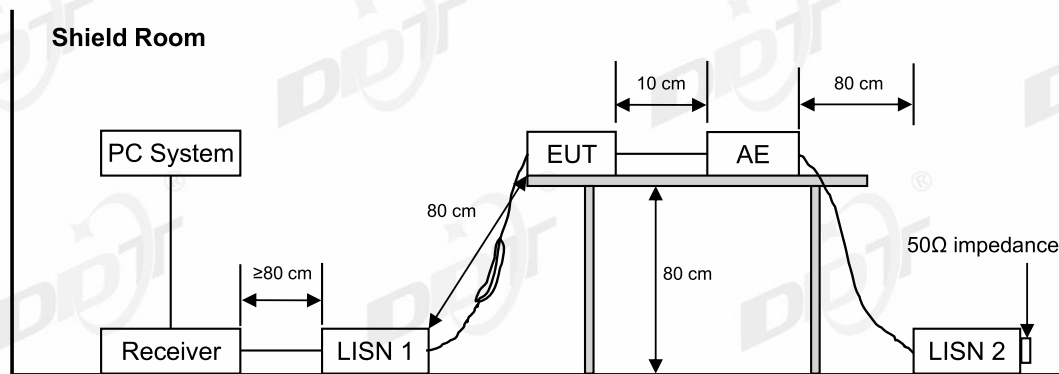

12.3. Power Line Conducted Emission Limits

Frequency	Quasi-Peak Level dB(μ V)	Average Level dB(μ V)
150 kHz ~ 500 kHz	66 ~ 56*	56 ~ 46*
500 kHz ~ 5 MHz	56	46
5 MHz ~ 30 MHz	60	50

Note 1: * Decreasing linearly with logarithm of frequency.

Note 2: The lower limit shall apply at the transition frequencies.

12.4. Test Procedure

The EUT and Support equipment, if needed, were put placed on a non-metallic table, 80cm above the ground plane.

All support equipment power received from a second LISN.

Emissions were measured on each current carrying line of the EUT using an EMI Test Receiver connected to the LISN powering the EUT.

The Receiver scanned from 150 kHz to 30 MHz for emissions in each of the test modes.

During the above scans, the emissions were maximized by cable manipulation.

The test mode(s) described in clause 2.4 were scanned during the preliminary test.

After the preliminary scan, we found the test mode producing the highest emission level.

The EUT configuration and worse cable configuration of the above highest emission levels were recorded for reference of the final test.

EUT and support equipment were set up on the test bench as per the configuration with highest emission level in the preliminary test.

A scan was taken on both power lines, Neutral and Line, recording at least the six highest emissions.

Emission frequency and amplitude were recorded into a computer in which correction factors were used to calculate the emission level and compare reading to the applicable limit.

The test data of the worst-case condition(s) was recorded.

The bandwidth of test receiver is set at 9 kHz.

12.5. Test Result

Pass. (See below detailed test result)

Note1: All emissions not reported below are too low against the prescribed limits.

Note2: "----" means peak detection; "----" means average detection

Note3: Pre-test AC conducted emission at both voltage AC 120V/60Hz and AC 240V/50Hz, recorded worse case.

TR-4-E-010 Conducted Emission Test Result

Test Site : DDT 1# Shield Room
Test Date : 2023-11-15
EUT : Active Speaker
Power Supply : AC 120V/60Hz
Condition : TEMP:26.2°C, RH:58.9%
Memo : Sample Number:S23103011-2E03

D:\2023 CE report data\Q23103011-2E EDF100078\FCC CE.EM6
Tested By : Junchang Du
Model Number : EDF100078
Test Mode : 5GSRD TX
LISN : 2023 1# ENV216/NEUTRAL

Data: 14

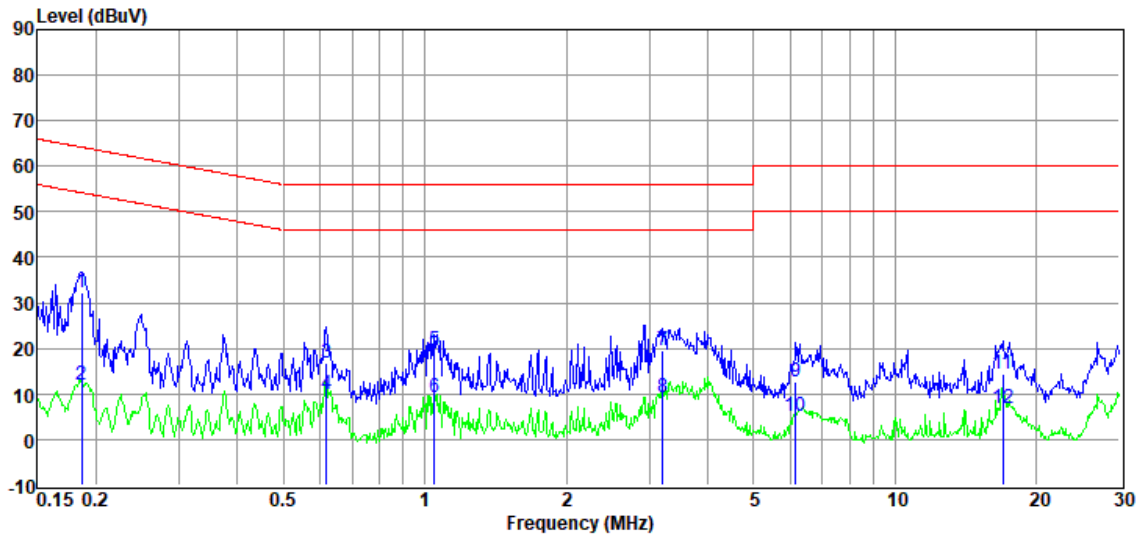

Item (Mark)	Freq. (MHz)	Read Level (dBμV)	LISN Factor (dB)	Cable Loss (dB)	Pulse Limiter Factor (dB)	Result Level (dBμV)	Limit Line (dBμV)	Over Limit (dB)	Detector	Phase
1	0.19	11.86	9.79	0.91	9.69	32.25	64.20	-31.95	QP	NEUTRAL
2	0.19	-8.53	9.79	0.91	9.69	11.86	54.20	-42.34	Average	NEUTRAL
3	0.62	-3.50	9.83	0.81	9.72	16.86	56.00	-39.14	QP	NEUTRAL
4	0.62	-10.30	9.83	0.81	9.72	10.06	46.00	-35.94	Average	NEUTRAL
5	1.05	-0.56	9.75	0.67	9.73	19.59	56.00	-36.41	QP	NEUTRAL
6	1.05	-10.83	9.75	0.67	9.73	9.32	46.00	-36.68	Average	NEUTRAL
7	3.21	-0.64	9.72	0.58	9.78	19.44	56.00	-36.56	QP	NEUTRAL
8	3.21	-10.90	9.72	0.58	9.78	9.18	46.00	-36.82	Average	NEUTRAL
9	6.15	-7.29	9.79	0.48	9.80	12.78	60.00	-47.22	QP	NEUTRAL
10	6.15	-14.93	9.79	0.48	9.80	5.14	50.00	-44.86	Average	NEUTRAL
11	16.93	-5.76	9.82	0.34	9.90	14.30	60.00	-45.70	QP	NEUTRAL
12	16.93	-13.22	9.82	0.34	9.90	6.84	50.00	-43.16	Average	NEUTRAL

Note:

1. Result Level = Read Level + LISN Factor + Pulse Limiter Factor + Cable loss.
2. If QP Result complies with AV limit, AV Result is deemed to comply with AV limit.
3. Test setup: RBW: 200 Hz (9 kHz—150 kHz), 9 kHz (150 kHz—30 MHz).
4. Step size: 80Hz (0.009MHz-0.15MHz), 4 kHz (0.15MHz-30MHz), Scan time: auto.

TR-4-E-010 Conducted Emission Test Result

Test Site : DDT 1# Shield Room
Test Date : 2023-11-15
EUT : Active Speaker
Power Supply : AC 120V/60Hz
Condition : TEMP:26.2°C, RH:58.9%
Memo : Sample Number:S23103011-2E03

D:\2023 CE report data\Q23103011-2E EDF100078\FCC CE.EM6
Tested By : Junchang Du
Model Number : EDF100078
Test Mode : 5GSRD TX
LISN : 2023 1# ENV216/LINE

Data: 16

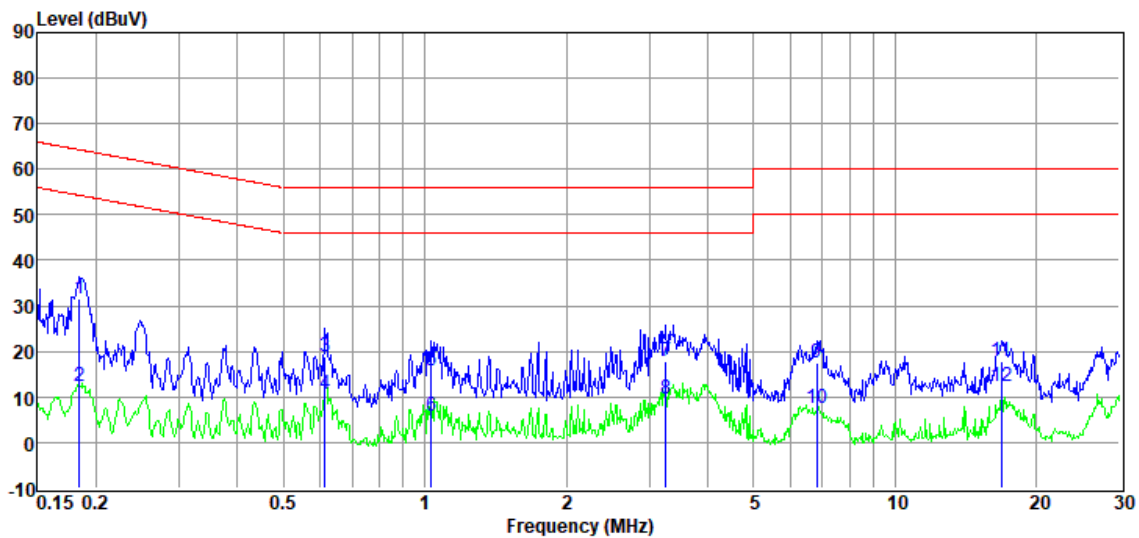

Item (Mark)	Freq. (MHz)	Read Level (dBμV)	LISN Factor (dB)	Cable Loss (dB)	Pulse Limiter Factor (dB)	Result Level (dBμV)	Limit Line (dBμV)	Over Limit (dB)	Detector	Phase
1	0.18	11.35	9.75	0.91	9.69	31.70	64.28	-32.58	QP	LINE
2	0.18	-8.10	9.75	0.91	9.69	12.25	54.28	-42.03	Average	LINE
3	0.61	-1.58	9.78	0.81	9.72	18.73	56.00	-37.27	QP	LINE
4	0.61	-9.57	9.78	0.81	9.72	10.74	46.00	-35.26	Average	LINE
5	1.03	-4.37	9.64	0.67	9.73	15.67	56.00	-40.33	QP	LINE
6	1.03	-14.27	9.64	0.67	9.73	5.77	46.00	-40.23	Average	LINE
7	3.26	-2.02	9.64	0.58	9.78	17.98	56.00	-38.02	QP	LINE
8	3.26	-10.32	9.64	0.58	9.78	9.68	46.00	-36.32	Average	LINE
9	6.81	-2.30	9.68	0.46	9.80	17.64	60.00	-42.36	QP	LINE
10	6.81	-12.47	9.68	0.46	9.80	7.47	50.00	-42.53	Average	LINE
11	16.84	-2.27	9.83	0.34	9.90	17.80	60.00	-42.20	QP	LINE
12	16.84	-7.79	9.83	0.34	9.90	12.28	50.00	-37.72	Average	LINE

Note:

1. Result Level = Read Level + LISN Factor + Pulse Limiter Factor + Cable loss.
2. If QP Result complies with AV limit, AV Result is deemed to comply with AV limit.
3. Test setup: RBW: 200 Hz (9 kHz—150 kHz), 9 kHz (150 kHz—30 MHz).
4. Step size: 80Hz (0.009MHz-0.15MHz), 4 kHz (0.15MHz-30MHz), Scan time: auto.

13. Antenna Requirements

13.1. Limit

For intentional device, according to FCC 47 CFR Section 15.203, an intentional radiator shall be designed to ensure that no antenna other than that furnished by the responsible party shall be used with the device. And according to FCC 47 CFR Section 15.247 (b), if transmitting antennas of directional gain greater than 6 dBi are used, the power shall be reduced by the amount in dB that the directional gain of the antenna exceeds 6 dBi.

For intentional device, according to RSS-Gen issue 5 section 6.8.

The applicant for equipment certification shall provide a list of all antenna types that may be used with the transmitter, where applicable (i.e. for transmitters with detachable antenna), indicating the maximum permissible antenna gain (in dBi) and the required impedance for each antenna. The test report shall demonstrate the compliance of the transmitter with the limit for maximum equivalent isotropically radiated power (e.i.r.p.) specified in the applicable RSS, when the transmitter is equipped with any antenna type, selected from this list.

13.2. Result

The antenna used for this product and no antenna other than that furnished by the responsible party shall be used with the device, maximum antenna ANT1 gain is 3.49 dBi and maximum antenna ANT2 gain is 3.49 dBi.

15. Photos of the EUT

Please refer to appendix I.

END OF REPORT