

FCC REPORT

Applicant: SHANGHAI BAOLONG AUTOMOTIVE CORPORATION

Address of Applicant: 5500, Shenzhuan Rd., Songjiang District, Shanghai 201619, China

Manufacturer/Factory: SHANGHAI BAOLONG AUTOMOTIVE CORPORATION

Address of Manufacturer/Factory: 5500, Shenzhuan Rd., Songjiang District, Shanghai 201619, China

Equipment Under Test (EUT)

Product Name: TPMS-sensor

Model No.: TPM-C pro-M

FCC ID: Z9F-TPMCPROM

Applicable standards: FCC CFR Title 47 Part 15 Subpart C Section 15.231

Date of sample receipt: September 27, 2018

Date of Test: September 28-October 20, 2018

Date of report issued: October 20, 2018

Test Result : PASS *

* In the configuration tested, the EUT complied with the standards specified above.

Authorized Signature:



Robinson Lo

Laboratory Manager

This results shown in this test report refer only to the sample(s) tested, this test report cannot be reproduced, except in full, without prior written permission of the company. The report would be invalid without specific stamp of test institute and the signatures of compiler and approver.

2 Version

Version No.	Date	Description
01	October 20, 2018	Original

Prepared By:

Bill. Yuan

Date:

October 20, 2018

Project Engineer

Check By:

Robinson

Date:

October 20, 2018

Reviewer

3 Contents

	Page
1 COVER PAGE	1
2 VERSION	2
3 CONTENTS	3
4 TEST SUMMARY	4
4.1 MEASUREMENT UNCERTAINTY	4
5 GENERAL INFORMATION	5
5.1 GENERAL DESCRIPTION OF EUT	5
5.2 TEST MODE	6
5.3 DESCRIPTION OF SUPPORT UNITS	6
5.4 TEST FACILITY.....	6
5.5 TEST LOCATION	6
5.6 OTHER INFORMATION REQUESTED BY THE CUSTOMER	6
6 TEST INSTRUMENTS LIST	7
7 TEST RESULTS AND MEASUREMENT DATA.....	8
7.1 ANTENNA REQUIREMENT	8
7.2 RADIATED EMISSION METHOD.....	9
7.2.1 <i>Field Strength of The Fundamental Signal</i>	11
7.2.2 <i>Spurious Emissions</i>	12
7.3 20dB OCCUPY BANDWIDTH	15
7.4 DWELL TIME.....	17
7.5 DUTY CYCLE	19
8 TEST SETUP PHOTO	21
9 EUT CONSTRUCTIONAL DETAILS	22

4 Test Summary

Test Item	Section in CFR 47	Result
Antenna Requirement	15.203	Pass
Conduction Emission	15.207	N/A
Field strength of the Fundamental Signal	15.231 (e)	Pass
Spurious Emissions	15.231 (e)/15.209	Pass
20dB Bandwidth	15.231 (c)	Pass
Dwell Time	15.231 (e)	Pass

Pass: The EUT complies with the essential requirements in the standard.

4.1 Measurement Uncertainty

Test Item	Frequency Range	Measurement Uncertainty	Notes
Radiated Emission	9kHz ~ 30MHz	± 4.34dB	(1)
Radiated Emission	30MHz ~ 1000MHz	± 4.24dB	(1)
Radiated Emission	1GHz ~ 26.5GHz	± 4.68dB	(1)
AC Power Line Conducted Emission	0.15MHz ~ 30MHz	± 3.45dB	(1)

Note (1): The measurement uncertainty is for coverage factor of k=2 and a level of confidence of 95%.

5 General Information

5.1 General Description of EUT

Product Name:	TPMS-sensor
Model No.:	TPM-C pro-M
Serial No.:	5F01023C
Test sample(s) ID:	GTS201809000176-1
Sample(s) Status:	Engineer sample
Hardware Version:	QY1269-01-001PB-V04
Software Version:	QY1269-A14B13-000
Operation Frequency:	433.92MHz
Modulation technology:	FSK
Antenna Type:	PCB Antenna
Antenna gain:	-5.0dBi(declared by manufacture)
Power supply:	Battery: DC 3.0V

5.2 Test mode

Transmitting mode	Keep the EUT in transmitting mode.
-------------------	------------------------------------

Per-test mode.

We have verified the construction and function in typical operation, The EUT was placed on three different polar directions; i.e. X axis, Y axis, Z axis. which only the worst case was shown in this test report and defined as follows:

433.92MHz	Axis	X	Y	Z
	Field Strength(dBuV/m)	80.36	81.24	79.51

5.3 Description of Support Units

Manufacturer	Description	Model	Serial Number
SHANGHAI BAOLONG AUTOMOTIVE CORPORATION	Tire pressure monitoring sensor activation tool	SGMW	1012-1809010009

5.4 Test Facility

The test facility is recognized, certified, or accredited by the following organizations:

- **FCC —Registration No.: 381383**

Global United Technology Services Co., Ltd., Shenzhen EMC Laboratory has been registered and fully described in a report filed with the (FCC) Federal Communications Commission. The acceptance letter from the FCC is maintained in files. Registration 381383, January 08, 2018.

- **Industry Canada (IC) —Registration No.: 9079A-2**

The 3m Semi-anechoic chamber of Global United Technology Services Co., Ltd. has been registered by Certification and Engineering Bureau of Industry Canada for radio equipment testing with Registration No.: 9079A-2, August 15, 2016

5.5 Test Location

All tests were performed at:

Global United Technology Services Co., Ltd.
 No. 301-309, 3/F., Jinyuan Business Building, No.2, Laodong Industrial Zone,
 Xixiang Road, Baoan District, Shenzhen, Guangdong, China
 Tel: 0755-27798480
 Fax: 0755-27798960

5.6 Other Information Requested by the Customer

None.

6 Test Instruments list

Radiated Emission:						
Item	Test Equipment	Manufacturer	Model No.	Inventory No.	Cal.Date (mm-dd-yy)	Cal.Due date (mm-dd-yy)
1	3m Semi- Anechoic Chamber	ZhongYu Electron	9.2(L)*6.2(W)* 6.4(H)	GTS250	July. 03 2015	July. 02 2020
2	Control Room	ZhongYu Electron	6.2(L)*2.5(W)* 2.4(H)	GTS251	N/A	N/A
3	EMI Test Receiver	Rohde & Schwarz	ESU26	GTS203	June. 27 2018	June. 26 2019
4	BiConiLog Antenna	SCHWARZBECK MESS-ELEKTRONIK	VULB9163	GTS214	June. 27 2018	June. 26 2019
5	Double -ridged waveguide horn	SCHWARZBECK MESS-ELEKTRONIK	9120D-829	GTS208	June. 27 2018	June. 26 2019
6	Horn Antenna	ETS-LINDGREN	3160	GTS217	June. 27 2018	June. 26 2019
7	EMI Test Software	AUDIX	E3	N/A	N/A	N/A
8	Coaxial Cable	GTS	N/A	GTS213	June. 27 2018	June. 26 2019
9	Coaxial Cable	GTS	N/A	GTS211	June. 27 2018	June. 26 2019
10	Coaxial cable	GTS	N/A	GTS210	June. 27 2018	June. 26 2019
11	Coaxial Cable	GTS	N/A	GTS212	June. 27 2018	June. 26 2019
12	Amplifier(100kHz-3GHz)	HP	8347A	GTS204	June. 27 2018	June. 26 2019
13	Amplifier(2GHz-20GHz)	HP	8349B	GTS206	June. 27 2018	June. 26 2019
14	Amplifier (18-26GHz)	Rohde & Schwarz	AFS33-18002 650-30-8P-44	GTS218	June. 27 2018	June. 26 2019
15	Band filter	Amindeon	82346	GTS219	June. 27 2018	June. 26 2019
16	Power Meter	Anritsu	ML2495A	GTS540	June. 27 2018	June. 26 2019
17	Power Sensor	Anritsu	MA2411B	GTS541	June. 27 2018	June. 26 2019
18	Wideband Radio Communication Tester	Rohde & Schwarz	CMW500	GTS588	June. 27 2018	June. 26 2019
19	Splitter	Agilent	11636B	GTS237	June. 27 2018	June. 26 2019
20	Loop Antenna	ZHINAN	ZN30900A	GTS534	June. 27 2018	June. 26 2019
21	Spectrum Analyzer	Agilent	E4440A	GTS533	June. 27 2018	June. 26 2019

General used equipment:						
Item	Test Equipment	Manufacturer	Model No.	Inventory No.	Cal.Date (mm-dd-yy)	Cal.Due date (mm-dd-yy)
1	Barometer	ChangChun	DYM3	GTS257	June 27 2018	June 26 2019

7 Test results and Measurement Data

7.1 Antenna Requirement

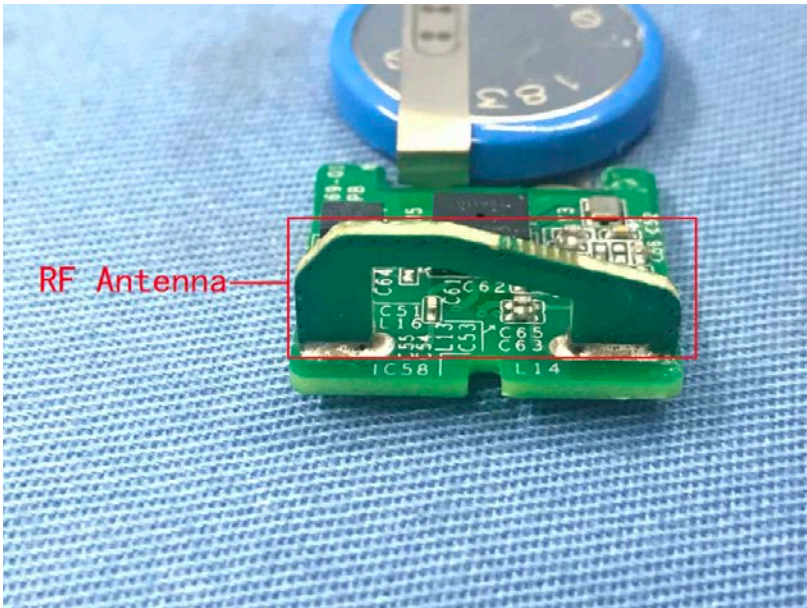
Standard requirement:	FCC Part15 C Section 15.203
<p>15.203 requirement:</p> <p>An intentional radiator shall be designed to ensure that no antenna other than that furnished by the responsible party shall be used with the device. The use of a permanently attached antenna or of an antenna that uses a unique coupling to the intentional radiator, the manufacturer may design the unit so that a broken antenna can be replaced by the user, but the use of a standard antenna jack or electrical connector is prohibited.</p>	
EUT Antenna:	
<p><i>The antenna is PCB antenna, the best case gain of the antenna is -5.0dBi</i></p> 	

7.2 Radiated Emission Method

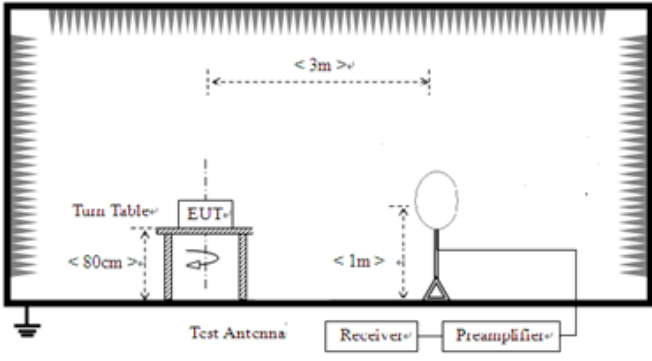
Test Requirement:	FCC Part15 C Section 15.231 (e)& Section 15.209					
Test Method:	ANSI C63.10:2013					
Test Frequency Range:	9kHz to 5000MHz					
Test site:	Measurement Distance: 3m					
Receiver setup:	Frequency	Detector	RBW	VBW	Value	
	9KHz-150KHz	Quasi-peak	200Hz	600Hz	Quasi-peak	
	150KHz-30MHz	Quasi-peak	9KHz	30KHz	Quasi-peak	
	30MHz-1GHz	Quasi-peak	100KHz	300KHz	Quasi-peak	
	Above 1GHz	Peak	1MHz	3MHz	Peak	
Peak		1MHz	10Hz	Average		
Limit: (Field strength of the fundamental signal)	Frequency	Limit (dBuV/m @3m)		Remark		
	433.92MHz	72.87		Average Value		
		92.87		Peak Value		
Limit: (Spurious Emissions)	Fundamental Frequency (MHz)	Field Strength of fundamental (microvolts/meter)	Field Strength of Unwanted Emissions (microvolts/meter)			
	40.66 - 40.70	1,000	100			
	70 - 130	500	50			
	130 - 174	500 to 1,500 **	50 to 1,50 **			
	174 - 260	1,500	1,50			
	260 - 470	1,500 to 5,000 **	1,50 to 5,00 **			
	Above 470	5,000	5,00			
	FREQUENCY (MHz)	Class B (dBuV/m) (at 3M)				
		PEAK		AVERAGE		
	Above 1000	74		54		
Or The maximum permitted unwanted emission level is 20 dB below the maximum permitted fundamental level whichever limit permits a higher field strength.						
Test setup:	<p>Below 30MHz</p>  <p>Below 1GHz</p>					

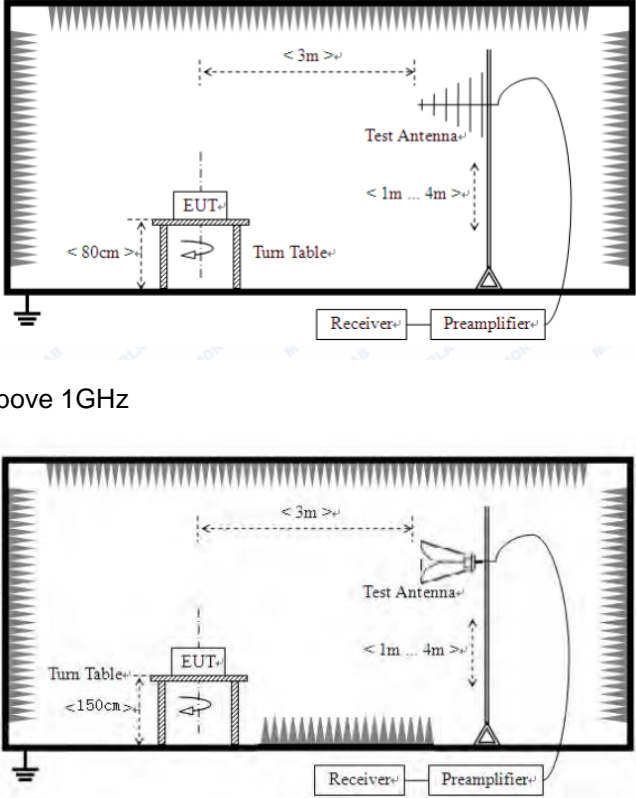
	 <p>Above 1GHz</p>
<p>Test Procedure:</p>	<ol style="list-style-type: none"> 1. The EUT was placed on the top of a rotating table (0.8 meters for below 1GHz and 1.5 meters for above 1GHz) above the ground at a 3 meter camber. The table was rotated 360 degrees to determine the position of the highest radiation. 2. The EUT was set 3 meters away from the interference-receiving antenna, which was mounted on the top of a variable-height antenna tower. 3. The antenna height is varied from one meter to four meters above the ground to determine the maximum value of the field strength. Both horizontal and vertical polarizations of the antenna are set to make the measurement. 4. For each suspected emission, the EUT was arranged to its worst case and then the antenna was tuned to heights from 1 meter to 4 meters and the rota table was turned from 0 degrees to 360 degrees to find the maximum reading. 5. The test-receiver system was set to Peak Detect Function and Specified Bandwidth with Maximum Hold Mode. 6. If the emission level of the EUT in peak mode was 10dB lower than the limit specified, then testing could be stopped and the peak values of the EUT would be reported. Otherwise the emissions that did not have 10dB margin would be re-tested one by one using peak, quasi-peak or average method as specified and then reported in a data sheet.
<p>Test Instruments:</p>	<p>Refer to section 6.0 for details</p>
<p>Test mode:</p>	<p>Refer to section 5.2 for details</p>
<p>Test results:</p>	<p>Pass</p>

Measurement data:**7.2.1 Field Strength of The Fundamental Signal****Peak value:**

Frequency (MHz)	Read Level (dBuV)	Antenna Factor (dB/m)	Cable Loss (dB)	Preamp Factor (dB)	Level (dBuV/m)	Limit Line (dBuV/m)	Over Limit (dB)	polarization
433.92	87.21	17.53	3.02	29.43	78.33	92.87	-14.54	Horizontal
433.92	90.12	17.53	3.02	29.43	81.24	92.87	-11.63	Vertical

Average value:

Frequency (MHz)	Peak Value (dBuV/m)	Duty cycle factor	Average value (dBuV/m)	Limit Line (dBuV/m)	Over Limit (dB)	Polarization
433.92	78.33	-14.61	63.72	72.87	-9.15	Horizontal
433.92	81.24	-14.61	66.63	72.87	-6.24	Vertical

Remark:

1. *Final Level = Receiver Read level + Antenna Factor + Cable Loss – Preamplifier Factor*
2. *Average value = Peak value + Duty cycle factor*

7.2.2 Spurious Emissions

Measurement data:

9 kHz ~ 30 MHz

The low frequency, which started from 9 kHz to 30 MHz, was pre-scanned and the result which was 20 dB lower than the limit line per 15.31(o) was not reported.

Below 1GHz:

Mode:	Transmitting mode	Test by:	Bill
Temp./Hum.(%RH):	26°C/56%RH	Polarization:	Horizontal

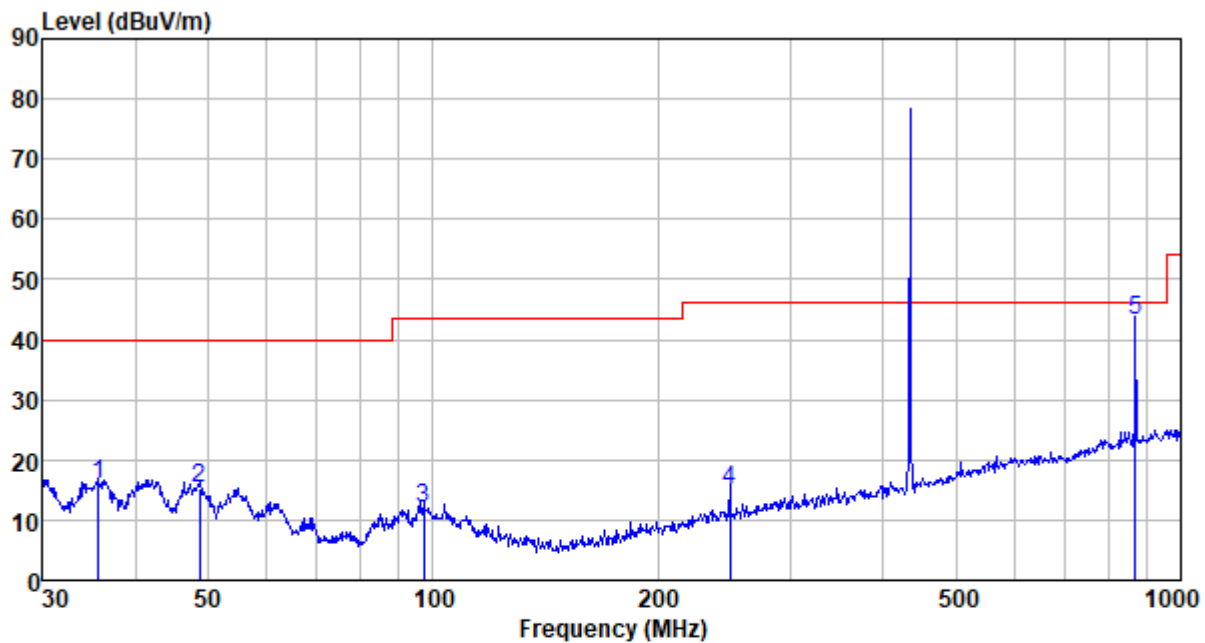

Freq MHz	Reading level dBuV	Antenna factor dB/m	Cable loss dB	Preamp factor dB	level dBuV	Limit level dBuV/m	Over limit dB	Remark
35.749	39.26	11.46	0.62	35.41	15.93	40.00	-24.07	QP
48.672	38.40	12.29	0.76	36.12	15.33	40.00	-24.67	QP
97.115	35.67	11.79	1.17	36.70	11.93	43.50	-31.57	QP
249.425	38.00	12.15	2.12	37.38	14.89	46.00	-31.11	QP
869.130	54.11	22.02	4.74	37.61	43.26	46.00	-2.74	QP

Mode:	Transmitting mode	Test by:	Bill
Temp./Hum.(%RH):	26°C/56%RH	Polarization:	Vertical

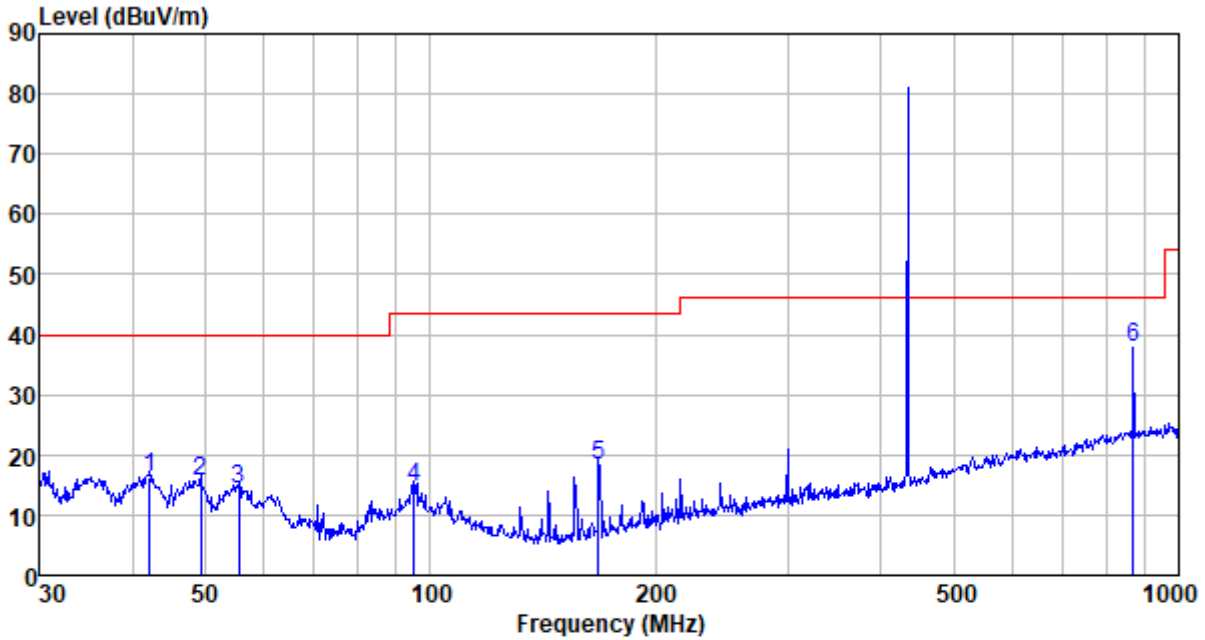

Freq MHz	Reading level dBuV	Antenna factor dB/m	Cable loss dB	Preamp factor dB	level dBuV	Limit level dBuV/m	Over limit dB	Remark
42.154	39.00	12.22	0.69	35.79	16.12	40.00	-23.88	QP
49.359	38.57	12.29	0.77	36.15	15.48	40.00	-24.52	QP
55.415	38.11	11.75	0.82	36.26	14.42	40.00	-25.58	QP
95.093	38.62	11.52	1.15	36.68	14.61	43.50	-28.89	QP
167.824	45.28	8.46	1.67	37.18	18.23	43.50	-25.27	QP
869.130	48.73	22.02	4.74	37.61	37.88	46.00	-8.12	QP

Above 1G:

Peak value:

Frequency (MHz)	Read Level (dBuV)	Antenna Factor (dB/m)	Cable Loss (dB)	Preamplifier Factor (dB)	Level (dBuV/m)	Limit Line (dBuV/m)	Over Limit (dB)	Polarization
1735.68	53.62	25.05	4.82	34.00	49.49	72.87	-23.38	Vertical
2169.60	40.11	27.74	5.15	34.27	38.73	72.87	-34.14	Vertical
2603.52	40.86	27.82	5.58	33.78	40.48	72.87	-32.39	Vertical
1735.68	50.33	25.05	4.82	34.00	46.20	72.87	-26.67	Horizontal
2169.60	41.55	27.74	5.15	34.27	40.17	72.87	-32.70	Horizontal
2603.52	41.71	27.82	5.58	33.78	41.33	72.87	-31.54	Horizontal

Average value:

Frequency (MHz)	Level (dBuV/m)	Duty cycle factor	Average value (dBuV/m)	Limit Line (dBuV/m)	Over Limit (dB)	Polarization
1735.68	49.49	-14.61	34.88	52.87	-17.99	Vertical
2169.60	38.73	-14.61	24.12	52.87	-28.75	Vertical
2603.52	40.48	-14.61	25.87	52.87	-27.00	Vertical
1735.68	46.20	-14.61	31.59	52.87	-21.28	Horizontal
2169.60	40.17	-14.61	25.56	52.87	-27.31	Horizontal
2603.52	41.33	-14.61	26.72	52.87	-26.15	Horizontal

Remarks:

1. *Final Level = Receiver Read level + Antenna Factor + Cable Loss – Preamplifier Factor*
2. *Average value = Peak value + Duty cycle factor*

7.3 20dB Occupy Bandwidth

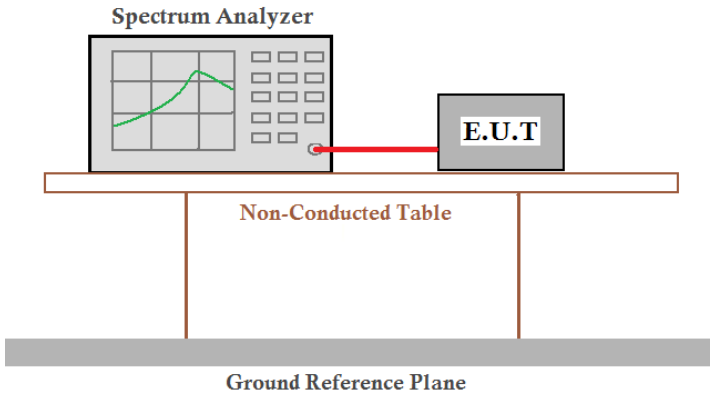
Test Requirement:	FCC Part15 C Section 15.231 (c)
Test Method:	ANSI C63.10:2013
Limit:	The bandwidth of the emission shall be no wider than 0.25% of the center frequency for devices operating above 70 MHz and below 900MHz. For devices operating above 900 MHz, the emission shall be no wider than 0.5% of the center frequency. Bandwidth is determined at the points 20 dB down from the modulated carrier.
Test setup:	 <p>The diagram illustrates the test setup. A Spectrum Analyzer is connected to an E.U.T. (Equipment Under Test) via a red cable. Both are placed on a Non-Conducted Table, which is supported by two vertical legs. Below the table is a Ground Reference Plane.</p>
Test Instruments:	Refer to section 6.0 for details
Test mode:	Refer to section 5.2 for details
Test results:	Pass

Measurement Data

Test Frequency (MHz)	20dB bandwidth (MHz)	Limit (MHz)	Result
433.92	0.166	1.085	Pass

Note: Limit= Fundamental frequency×0.25%

433.92×0.25%=1.085MHz

Test plot as follows:

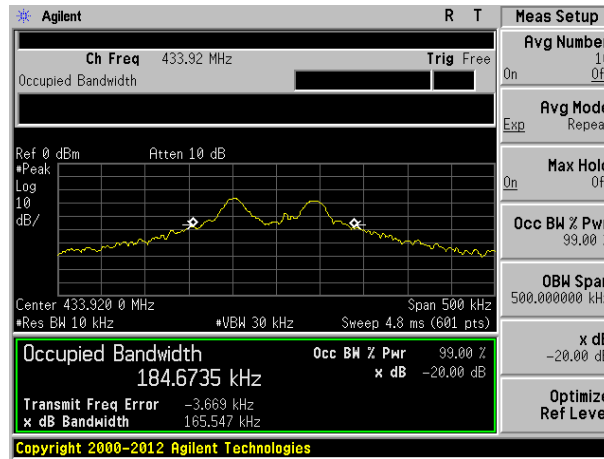

7.4 Dwell Time

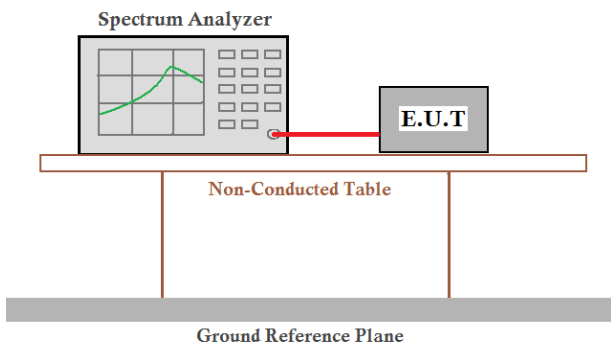
Test Requirement:	FCC Part15 C Section 15.231 (e)
Test Method:	ANSI C63.10:2013
Receiver setup:	RBW=100KHz, VBW=100KHz, span=0Hz, detector: Peak
Limit:	Not more than 1 seconds Silent period: at least 30 times the duration of the transmission or more than 10 seconds
Test setup:	 <p>The diagram shows a Spectrum Analyzer and an E.U.T. (Equipment Under Test) connected by a red cable. They are positioned on a table labeled 'Non-Conducted Table'. Below the table is a 'Ground Reference Plane'.</p>
Test Instruments:	Refer to section 6.0 for details
Test mode:	Refer to section 5.2 for details
Test results:	Pass

Measurement data:

Frequency (MHz)	Duration of each TX (second)	Limit (second)	Result
433.92	0.0125	<1.0	Pass

Silent period

Frequency (MHz)	Duration of each TX (seconds):	Limit (seconds)	Result
433.92	11.80	At least 30 times the duration of the transmission or more than 10 seconds	Pass

Test plot as follows:

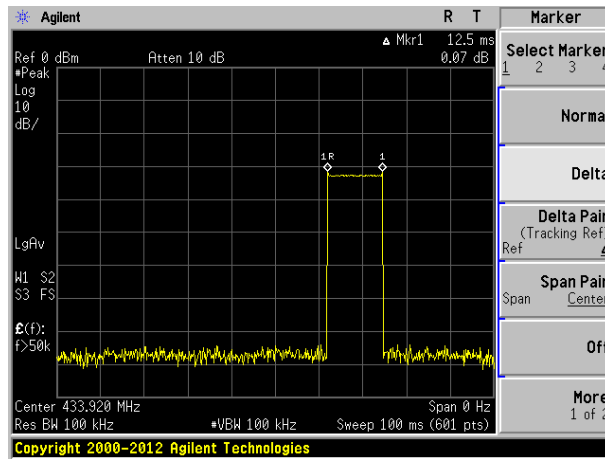

Silent period

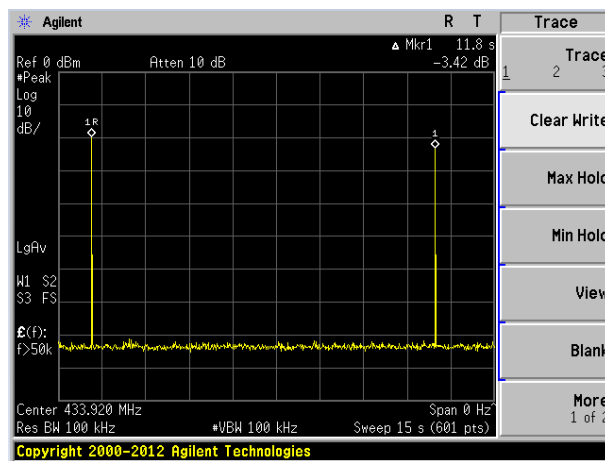

7.5 Duty Cycle

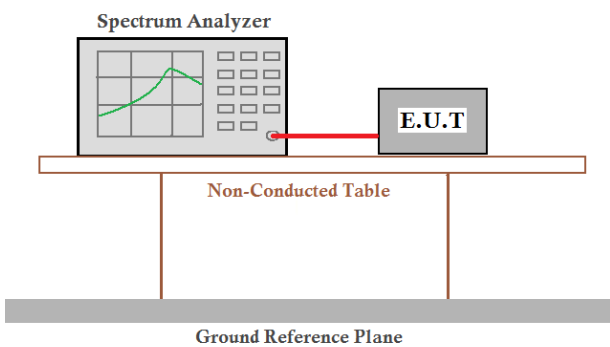
Test Requirement:	FCC Part15 C Section 15.231
Test Method:	ANSI C63.10:2013
Receiver setup:	RBW=100KHz, VBW=100KHz, span=0Hz, detector: Peak
Limit:	No dedicated limit specified in the Rules.
Test Procedure:	<ol style="list-style-type: none"> 1. Place the EUT on the table and set it in transmitting mode. 2. Remove the antenna from the EUT and then connect a low loss RF cable from the antenna port to the spectrum analyzer. 3. Set centre frequency of spectrum analyzer=operating frequency. 4. Set the spectrum analyzer as RBW=100kHz, VBW=100KHz, Span=0Hz, Adjust Sweep=100ms to obtain the "worst-case" pulse on time 5. Repeat above procedures until all frequency measured was complete.
Test setup:	 <p>The diagram illustrates the test setup. A Spectrum Analyzer is connected via a red cable to an E.U.T. (Equipment Under Test). Both are placed on a Non-Conducted Table. Below the table is a Ground Reference Plane.</p>
Test Instruments:	Refer to section 6.0 for details
Test mode:	Refer to section 5.2 for details
Test results:	Pass

Measurement data:

Calculate Formula: $\text{Duty cycle factor} = 20 \log(\text{Duty cycle})$
 Duty cycle = on time / 0.1 seconds or period, whichever is less

Test data:

T on time = 12.50 (ms)
 T period = 67.25 (ms)
 Duty cycle = $12.50 / 67.25 = 18.59\%$
 Duty cycle factor = $20 \log(0.1859) = -14.61$

Test plot as follows:

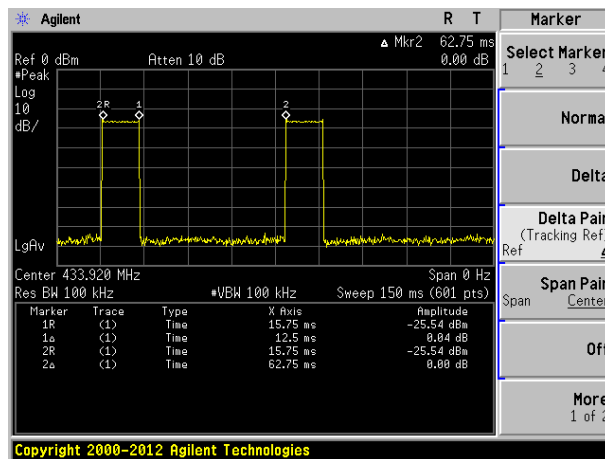

8 Test Setup Photo

Radiated Emission

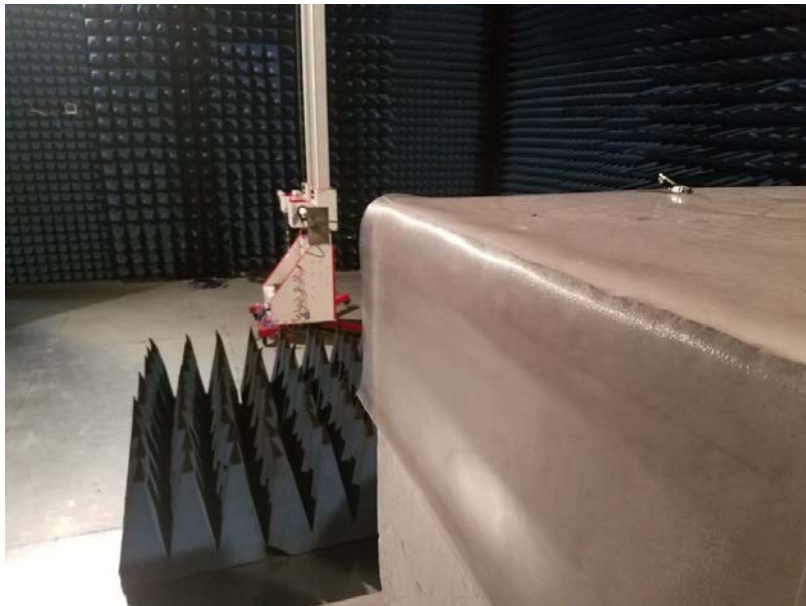

9 EUT Constructional Details





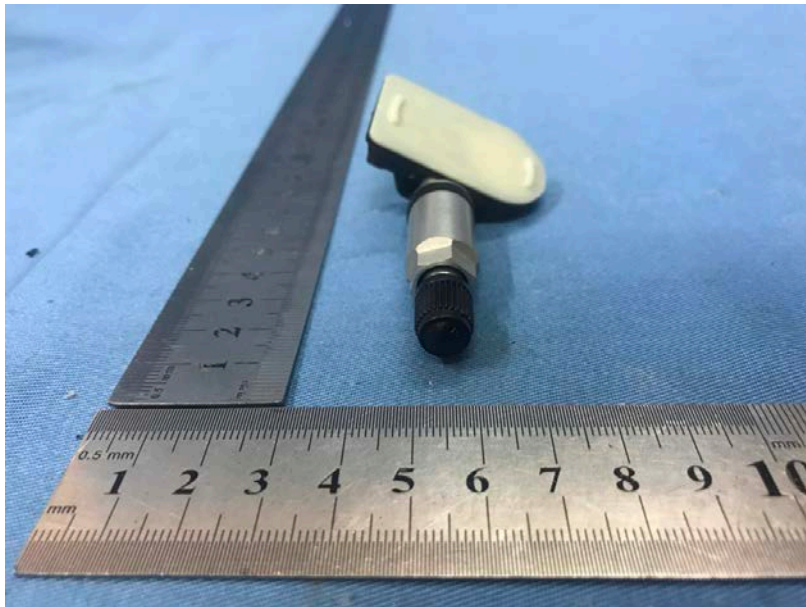
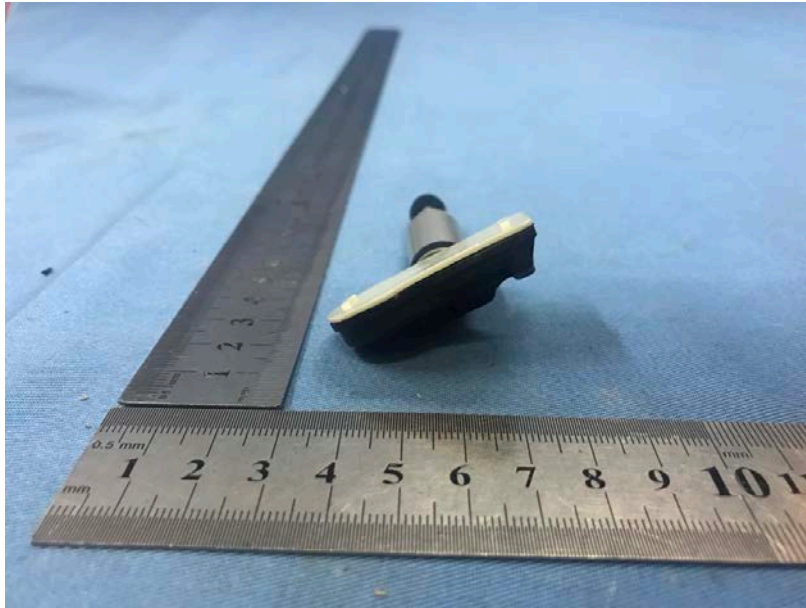



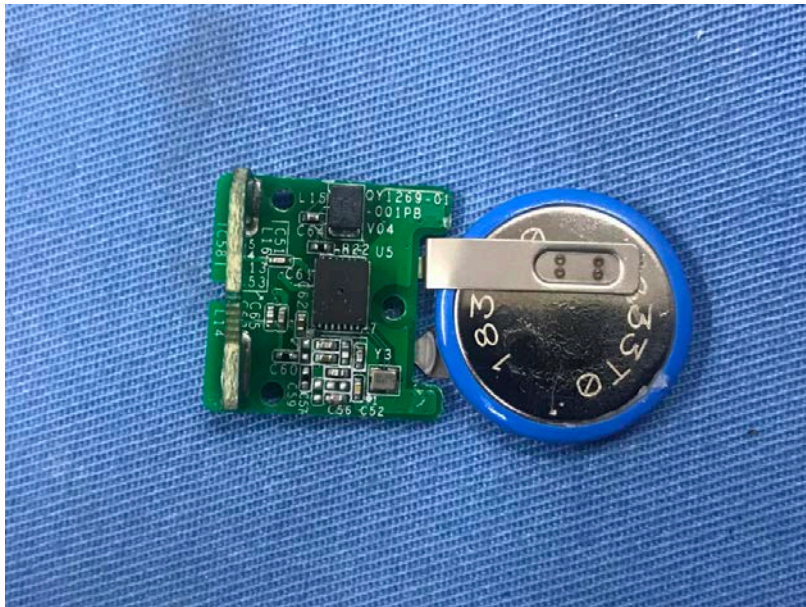
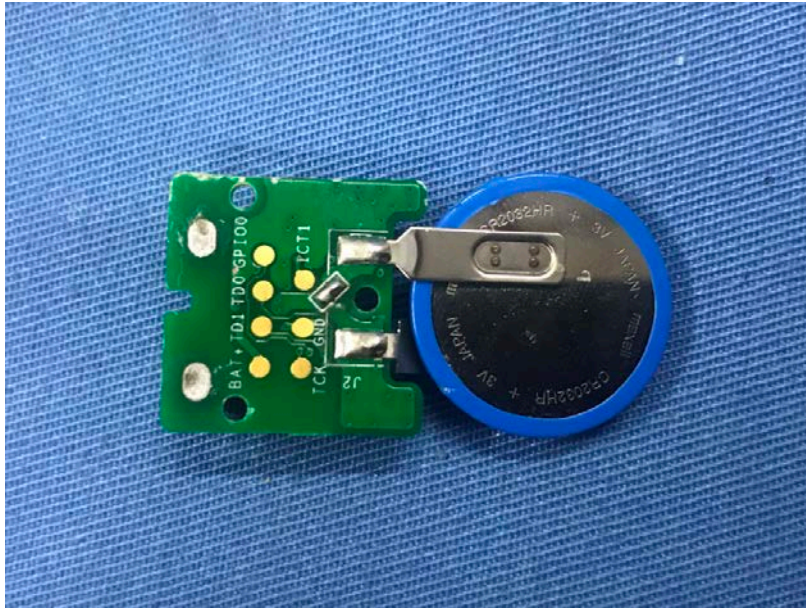

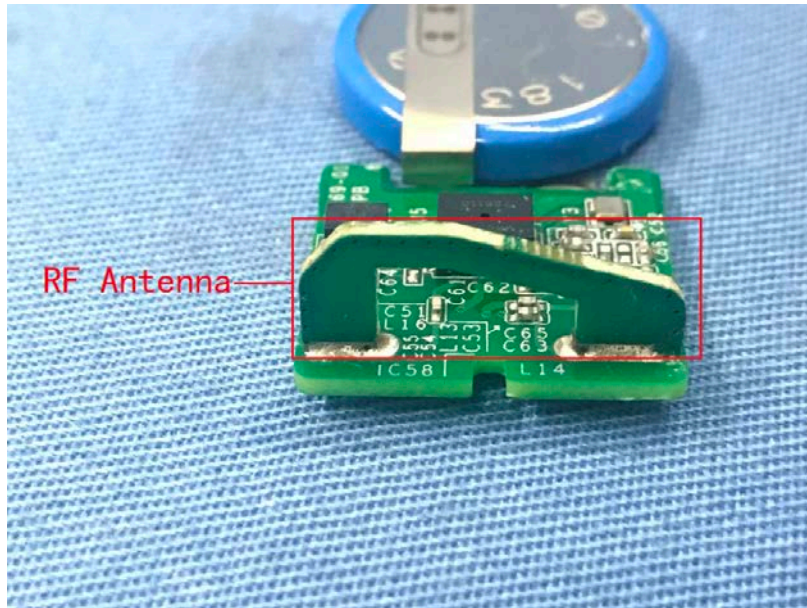

----- End -----