

Contents

Important Safety Instructions	2
Safety.....	2
Warning.....	2
Identifying the Parts	5
Main Unit	5
Remote Control	6
Install Remote Control Batteries	7
Prepare the Remote Control	7
Replace the Remote Control Battery	7
Connections	7
Using the AUX Connection.....	7
Connect to FM Antenna	8
Connecting Power	8
General Operation.....	8
Power ON/OFF	8
Select Modes.....	8
Turn the Bass ON/OFF	8
Adjust the Volume	8
Select the Equaliser.....	9
Adjust the Brightness.....	9
Set the Clock.....	9
Set the alarm Timer	9
Set the Sleep Timer	10
PLAY	10
CD/MP3/WMA Operation	10
USB Operation	10
Play Control.....	11
Program.....	11
Play iPod/iPhone	12
Bluetooth Operation	12
Pair Bluetooth-enabled Devices.....	12
NFC (Near Field Communication) Operation.....	13
Listen to Music from Bluetooth Device.....	13
AUX Operation	13
FM Operation	14
Auto Scan and Save Preset Station.....	14
Tuning in a Station	14
Presetting Stations Manually.....	14
Troubleshooting	14
Specifications.....	16
Standard Accessories	16

Important Safety Instructions

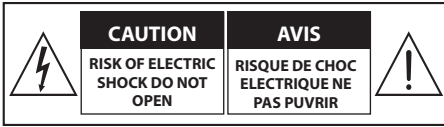

The lightning flash with arrowhead symbol, within an equilateral triangle, is intended to alert the user to the presence of uninsulated "dangerous voltage" within the product's enclosure that may be of sufficient magnitude as to constitute a risk of electric shock to persons.



The exclamation point within an equilateral triangle is intended to alert the user to the presence of important operating and maintenance (servicing) instructions in the literature accompanying the appliance.

Safety

- 1 **Read these instructions** – All the safety and operating instructions should be read before this product is operated.
- 2 **Keep these instructions** – The safety and operating instructions should be retained for future reference.
- 3 **Heed all warnings** – All warnings on the appliance and in the operating instructions should be adhered to.
- 4 **Follow all instructions** – All operating and usage instructions should be followed.
- 5 **Do not use this apparatus near water** – The appliance should not be used near water or moisture – for example, in a wet basement or near a swimming pool and the like.
- 6 Clean only with a dry cloth.
- 7 Do not block any ventilation openings. Install in accordance with the manufacturer's instructions.
- 8 Do not install near any heat sources such as radiators, heaters, stoves, or other apparatus (including amplifiers) that produce heat.
9. Do not defeat the safety purpose of the polarized or grounding plug. A polarized plug has two blades with one wider than the other. A grounding plug has two blades and a third grounding prong. The wide blade or the third prong is provided for your safety. If the provided plug does not fit into your outlet, consult an electrician for replacement of the obsolete outlet.
- 10 Protect the power cord from being walked on

or pinched, particularly at plugs, convenience receptacles and at the point where they exit from the apparatus.

- 11 Only use attachments/accessories specified by the manufacturer.
- 12 Use only with the cart, stand, tripod, bracket or table specified by the manufacturer, or sold with the apparatus. When a cart or rack is used, use caution when moving the cart/apparatus combination to avoid injury from tip-over.
- 13 Unplug the apparatus during lightning storms or when unused for long periods of time.
- 14 Refer all servicing to qualified personnel. Servicing is required when the apparatus has been damaged in any way, such as power supply cord or plug is damaged, liquid has been spilled or objects have fallen into the apparatus, the unit has been exposed to rain or moisture, does not operate normally, or has been dropped.
- 15  This equipment is a Class II or double insulated electrical appliance. It has been designed in such a way that it does not require a safety connection to electrical earth.

Caution:

- Use of controls or adjustments or performance of procedures other than those described herein, may result in hazardous radiation exposure or other unsafe operation.
- To reduce the risk of fire or electric shock, do not expose this apparatus to rain or moisture. The apparatus must not be exposed to dripping or splashing and objects filled with liquids, such as vases, must not be placed on apparatus.
- The mains plug/appliance coupler is used as the disconnect device, the disconnect device must remain readily operable.
- Danger of explosion if battery is incorrectly replaced.
- Replace only with the same or equivalent type.
- This Transmitter must be installed to provide a separation distance of at least 20 cm from all persons.

Warning

- The battery (battery or batteries or battery pack) must not be exposed to excessive heat such as sunshine, fire or the like.

- Before operating this system, check the voltage of this system to see if it is identical to the voltage of your local power supply.
- Do not cover the ventilation openings with items such as newspaper, table-cloths, curtains etc. Ensure that there is at least 20 cm of space above and at least 5cm of space on each side of the unit.
- Do not place this unit close to strong magnetic fields.
- Do not place this unit on the amplifier or receiver.
- Do not place this unit close to damp areas as the moisture will affect the life of the laser head.
- If any solid object or liquid falls into the system, unplug the system and have it checked by qualified personnel before operating it any further.
- Do not attempt to clean the unit with chemical solvents as this may damage the finish. Use a clean, dry or slightly damp cloth.
- When removing the power plug from the wall outlet, always pull directly on the plug, never yank on the cord.
- No naked flame sources, such as lighted candles, should be placed on the apparatus.
- Changes or modifications to this unit not expressly approved by the party responsible for compliance will void the user's authority to operate the equipment.
- The rating label is pasted on the bottom or back of the equipment.

⚠ DO NOT INGEST BATTERY, CHEMICAL BURN HAZARD

The remote control supplied with this product contains a coin/button cell battery. If the coin/button cell battery is swallowed, it can cause severe internal burns in just 2 hours and lead to death. Keep new and used batteries away from children. If the battery compartment does not close securely, stop using the product and keep it away from children. If you think batteries might have been swallowed or placed inside any part of the body, seek immediate medical attention.

Do not move the unit during playback

- During playback, the disc rotates at high speed.
- Do not lift or move the unit during playback, as doing so may damage the disc or the unit.

When moving this unit

- When changing places of installation or packing the unit for moving, be sure to remove the disc and return the disc tray to its closed position in the player. Then, press the power switch to turn the power off before disconnecting the power cord. Moving this unit with the disc loaded may result in damage to this unit.

This apparatus includes this label:



About the discs Handling

Do not touch the playback side of discs. Hold discs by the edges to avoid leaving fingerprints on the surface.



Any dust, fingerprints or scratches may cause a malfunction.



Never attach a label or sticky tape to the disc.

Storage

Put disc back in their case after playing them. Never expose disc to direct sunlight or heat sources. Never leave discs inside a car parked in full sunlight.

Cleaning

Use a clean soft lint-free cloth to clean the discs, working from the centre outwards in a straight line. Do not use solvents such as petrol, thinners, commercially available cleaners or antistatic sprays for vinyl records.



“Made for iPod,” “Made for iPhone,” mean that an electronic accessory

has been designed to connect specifically to iPod, iPhone, respectively, and has been certified by the developer to meet Apple performance standards. Apple is not responsible for the operation of this device or its compliance with safety and regulatory standards. Please note that the use of this accessory with iPod, iPhone may affect wireless performance. iPhone, iPod, iPod classic, iPod nano, iPod shuffle, and iPod touch are trademarks of Apple Inc., registered in the U.S. and other countries.

FCC INFORMATION(for US customers)

Warning:

Changes or modifications to this unit not expressly approved by the party responsible for compliance could void the user's authority to operate the equipment.

NOTE:

This equipment has been tested and found to comply with the limits for a Class B digital device, pursuant to Part 15 of the FCC Rules. These limits are designed to provide reasonable protection against harmful interference in a residential installation. This equipment generates, uses and can radiate radio frequency energy and, if not installed and used in accordance with the instructions, may cause harmful interference to radio communications.

However, there is no guarantee that interference will not occur in a particular installation. If this equipment does cause harmful interference to radio or television reception, which can be determined by turning the equipment off and on, the user is encouraged to try to correct the interference by one or more of the following measures:

- Reorient or relocate the receiving antenna.
- Increase the separation between the equipment and receiver.
- Connect the equipment into an outlet on a circuit different from that to which the receiver is connected.
- Consult the dealer or an experienced radio/TV technician for help.

This device complies with Part 15 of the FCC Rules. Operation is subject to the following two conditions:

- (1) this device may not cause harmful interference, and
- (2) this device must accept any interference received, including interference that may cause undesired operation.

FCC ID:Z8M-VCM632

Identifying the Parts

Main Unit

Top View

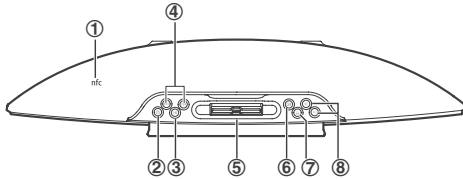

Front View

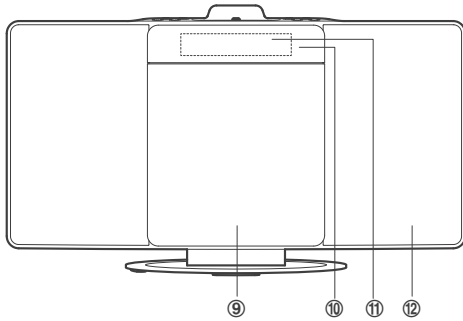

Rear View

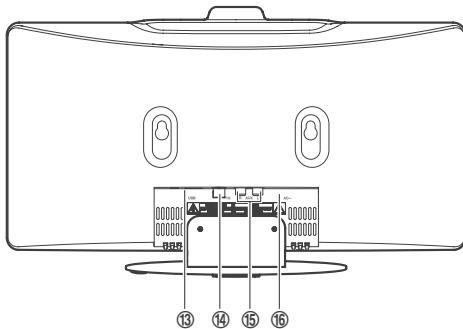

1 NFC Sensing Area

2

Switch the unit between ON and Standby mode.

3

Play/pause/resume playback in Bluetooth/CD/DOCK mode.

Activate the pairing function in BLUETOOTH mode and disconnect the existing paired Bluetooth device. Confirm a selection.

4

In CD/DOCK/BT mode: Skip to previous track/skip to next track.

In CD/DOCK mode: Press and hold search backward/forward within a track/disc.

In FM mode:

Search radio stations manually, press and hold the button to search automatically.

5 DOCK for iPod/iPhone

Load an iPod/iPhone (Lightning® connector models only)

6

Select the play function.

7

Open and close the disc compartment.

8 VOL+/VOL-

Increase/decrease the volume level.

9 Display

Show current status.

10 Disc Compartment

11 IR (Remote Control Sensor)

Receive the signal from the remote control.

12 Speakers

13 Wall hanging points

14 FM wire antenna

15 AUX (R L) Socket

Connect to an external audio device.

16 AC~ Connect to power cord.

Remote Control

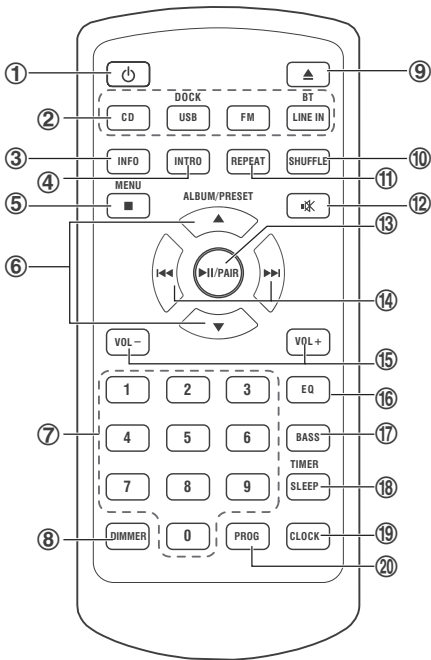

- 1 **⏻**
Switch the unit between ON and Standby mode.
- 2 **SOURCE**
Select the play function.
- 3 **INFO**
Displays playback information.
- 4 **INTRO**
Every soundtrack will be played for 10 Sec.
- 5 **■/MENU**
Stop play.
- 6 **▲, ▼**
Navigate up/down through.
Select a previous/next preset station.
Adjust time.
- 7 **Numeric keypad (0~9)**
In CD mode:
Select a track number for playback.
In FM mode:
Choose the preset radio station.
- 8 **DIMMER**
Adjust display brightness.
- 9 **▲**
Open or close disc compartment.
- 10 **SHUFFLE**
Select shuffle play mode.
- 11 **REPEAT**
Select repeat play modes.
- 12 **🔇**
Mute or resume the sound.
- 13 **▶ ||/PAIR**
Play/pause/resume playback.
Activate the pairing function in BLUETOOTH mode and disconnect the existing paired Bluetooth device.
- 14 **⏮/⏭**
In USB/CD/DOCK/BT mode: Skip to previous track/skip to next track.
In USB/CD/DOCK mode: Press and hold search backward/forward within a track/disc.
In FM mode:
Search radio stations manually, press and hold the button to search automatically.
- 15 **VOL+/VOL-**
Increase/decrease the volume level.
- 16 **EQ**
Select the preset equaliser.
- 17 **BASS**
Turn the bass ON/OFF.
- 18 **SLEEP/TIMER**
Set the sleep timer.
Set the alarm timer.
- 19 **CLOCK**
In standby mode, press and hold to activate clock setup .
Display current clock .
- 20 **PROG**
Programme soundtracks.
Presets radio stations.
Press and hold to scan for radio stations in FM modes.

Install Remote Control Batteries

Prepare the Remote Control

The provided Remote Control allows the unit to be operated from a distance.

- Even if the Remote Control is operated within the effective range (6m), remote control operation may be impossible if there are any obstacles between the unit and the remote control.
- If the Remote Control is operated near other products which generate infrared rays, or if other remote control devices using infra-red rays are used near the unit, it may operate incorrectly. Conversely, the other products may operate incorrectly.

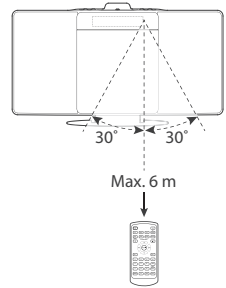

First-time use:

The unit has a pre-installed lithium CR2025 battery. Remove the protective tab to activate the remote control battery.

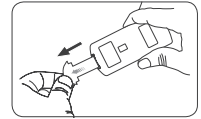

Replace the Remote Control Battery

- 1 Pull out the battery tray and remove the old battery.
- 2 Place a new CR2025 battery into the battery tray with correct polarity (+/-) as indicated.
- 3 Insert the battery tray back into the slot.

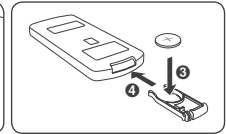
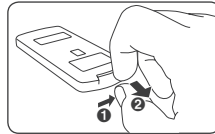

Precautions Concerning Batteries

- When the Remote Control is not going to be used for a long time (more than a month), remove the battery from the Remote Control to prevent it from leaking.
- If the batteries leak, wipe away the leakage inside the battery compartment and replace the batteries with new ones.
- Do not use any batteries other than those specified.
- Do not heat or disassemble batteries. Never throw them in fire or water.
- Do not carry or store batteries with other metallic objects as this may cause the batteries to short-circuit, leak or explode.
- Never recharge a battery unless it is confirmed to be a rechargeable type.

Connections

Using the AUX Connection

- Use a RCA to RCA stereo audio cable (included) to connect the TV's audio output sockets to the **AUX(R L)** socket on the unit.

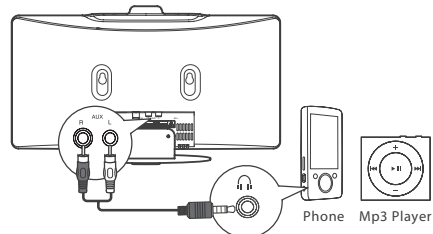
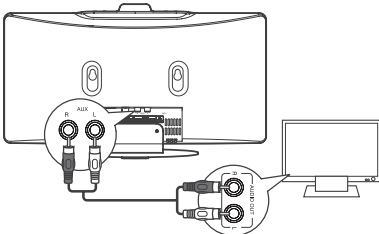

- Use a RCA to 3.5mm audio cable (not included) to connect the audio player's headphone socket to the **AUX(R L)** socket on the unit.

Connect to FM Antenna

- Connect the supplied FM wire antenna to the FM antenna socket on the unit.
- To avoid noise, keep antennas away from the unit's, the connecting cord and the AC power cord.

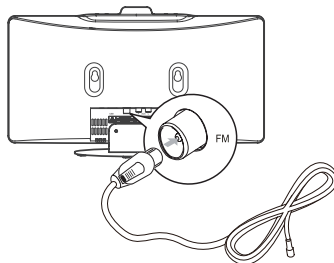

Connecting Power

Caution:

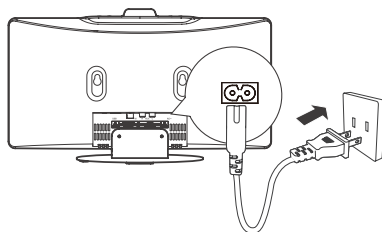

- Risk of product damage! Ensure that the power supply voltage corresponds to the voltage printed on the rating label on the back or the underside of the unit.
- Before connecting the AC power cord, ensure you have completed all other connections.
- Connect the power to the **AC** socket on the unit and a wall outlet.
- Please turn the unit off completely to save energy when not in use.



General Operation

Power ON/OFF

When you first connect the unit to the mains socket, the unit will be in STANDBY mode.

- Press the  button on the main unit or on the remote control to switch the main unit ON.
- Press the  button on the main unit or on the remote control to switch the main unit back to Standby mode.
- Disconnect the mains plug from the mains socket if you want to switch the unit off completely.

Note: When there is no input signal (or weak input signal) in AUX/docking/Bluetooth and when CD is not playing (No disc, Stop or Pause) for over 15 minutes, the unit will automatically switch to Standby mode.

Select Modes

To get to the desired function mode, press the  button repeatedly on the unit or press the **CD, DOCK, FM, AUX/BT**(Bluetooth) buttons on the remote control to select the desired mode.

Turn the Bass ON/OFF

Press the **BASS** button on the remote control repeatedly to turn the bass on or off.

Adjust the Volume

Press the **VOL +/-** buttons on the main unit or on the remote control to adjust the volume.

If you wish to turn the sound off, press the **MUTE** button on the remote control. Press the **MUTE** button again or press **VOL +/-** button to resume normal volume.

Select the Equaliser

Press the **EQ** button on the remote control repeatedly to select: **[POP] - [CLASSIC] - [JAZZ] - [ROCK]** .

The default EQ setting is **POP**.

Adjust the Brightness

Press the **DIMMER** button on the remote control to select brightness level.

Set the Clock

- Manual Setting the clock can only be done in **STANDBY** mode.
- 1 In **STANDBY** mode, press and hold the **CLOCK** button on the remote control until the hour digits are flashing.
- 2 Press the **▲, ▼** buttons on the remote control to adjust the hour digits while flashing, then press **CLOCK** button on the remote control to confirm, then the minute digits will flash.
- 3 Press the **▲, ▼** buttons on the remote control to adjust the minute digits while flashing, then press the **CLOCK** button on the remote control to confirm.
- Each activated state will be cleared if any buttons are not pressed within 15 seconds.
- During Time Setup press the **▶ ||** button to select 12/24 hour format.
- **Time Display**
- Press the **CLOCK** button to show the current time on the display for a few seconds.

Set the alarm Timer

- The clock must be correctly set for the timer to operate correctly.
- 1 In **STANDBY** mode, press and hold the **TIMER/SLEEP** button on the remote control until the hour digits flash on the display.
- 2 Press the **▲, ▼** buttons on the remote control to adjust the hour digits, and then press the **TIMER/SLEEP** button on the remote control to confirm, the minute digits will flash on the display.
- 3 Press the **▲, ▼** buttons on the remote control to adjust the minute digits, and then press the **TIMER/SLEEP** button on the remote control to confirm, the tuner timer will flash on the display
- 4 Press the **▲, ▼** buttons on the remote control to select BUZZER, FM, IPOD, DISC mode, and then press the **TIMER/SLEEP** button on the remote control to confirm, the display will show the volume level.
- 5 Press the **▲, ▼** buttons on the remote control to adjust the volume, and then press the **TIMER/SLEEP** button on the remote control to confirm, the display will show the selected timer and “

Activate and Deactivate the Alarm Timer

- Press the **TIMER/SLEEP** button on the remote control to view the alarm settings or activate the alarm.
- The alarms are active when “

9

Stop Alarm Ring

When the alarm rings, press the  button on the remote control. The alarm stops but the alarm settings remain.

Set the Sleep Timer

This unit can switch to standby automatically after a set period of time.

- 1 Press the **TIMER/SLEEP** button on the remote control repeatedly to select your desired number of minutes. The number of minutes shown will display in this sequence:





- 2 Stop pressing the **TIMER/SLEEP** button when your desired number of minutes is displayed. The sleep timer is now set.
 - Press the **TIMER/SLEEP** button to view the remaining time before switch off.
 - To cancel the sleep timer, press the **TIMER/SLEEP** button repeatedly until "SLEEP 00" shows on the display.

PLAY

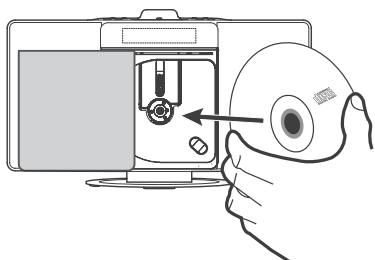
CD/MP3/WMA Operation



- 1 Press the  button on the main unit or press the **CD** button on the remote control to select the DISC source.
- 2 The unit will read the disc and play it automatically after you place a disc onto the disc tray and press the  button to close the tray.

USB Operation

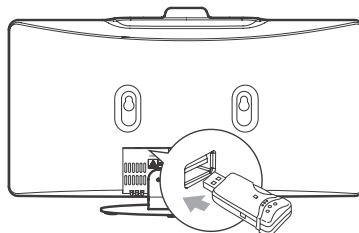

- 1 Press the  button on the main unit or press the **DOCK/USB** button on the remote control to select **USB** mode.
- 2 Insert the USB device.

Play Control

- To stop play, press the **■** button on the remote control. The total tracks of the CD will show on the display.
- To pause or resume play, press the **▶ ||** button on the unit or the **▶ ||/PAIR** button on the remote control.
- To skip to the previous/next track, press the **◀▶** buttons on the unit or on the remote control.
- Press and hold the **◀▶** buttons on the unit or on the remote control to perform fast forward/reverse playback. Release the button to resume normal playback.

Show maturity (Music CD)

Press the **INFO** button on the remote control while playing a music CD to:

- The remaining term of the title,
- The current time on the CD,
- The remaining term of the CD.

Random Playback

During play, press the **SHUFFLE** button repeatedly to select a repeat option play mode.

Intro Playback

Press the **INTRO** button on the remote control. The unit will play the first 10 seconds of each track.

Press the **INTRO** button on the remote control again to resume normal playback.

Repeat Playback

Press the **REPEAT** button on the remote control repeatedly to select repeat play modes. The selected mode will show on the display.

: Play the current track repeatedly.

: Play all tracks repeatedly.

Program

The user can programme up to 20 tracks in CD/USB mode in any desired order. If more than 20 tracks are stored, **FULL** appears in the display..

1. Press the **■ /MENU** button on the remote control.
2. Press the **PROG** button on the remote control to enter MEMORY mode.
3. Press the numbe (0~9) buttons on the remote control or the **◀▶** buttons to select the track number you wish to play then press the **PROG** button to confirm.
4. Repeat step 2-3 to store the rest of the tracks.
5. Press the **▶ ||** on the unit or the **▶ ||/PAIR** button on the remote control on the remote control to begin playback.

Note: If you want to change the programmed files, double press the **■ /MENU** button to clear the current program files, then repeat the program steps as above to re-enter the new program files.

Play iPod/iPhone

You can enjoy audio from an iPod/iPhone through this unit.

- 1 Place the iPod/iPhone into the dock.
 - This apparatus does not support Apple 30 pin models.
- 2 Press the  button on the main unit or press the **DOCK/USB** button on the remote control to select the **IPOD** mode.

- 3 Start to play the connected iPod/iPhone.

- To pause/resume play, press the **▶ ||** button.
- To skip to a track, press the **◀▶** buttons on the unit or on the remote control.
- Press and hold the **◀▶** buttons on the unit or on the remote control to perform fast forward/reverse playback. Release the button to resume normal playback.
- To select repeat play options: press the **REPEAT** button repeatedly to select a repeat option play mode.
- To select shuffle play options: press the **SHUFFLE** button repeatedly to select a shuffle option play mode.

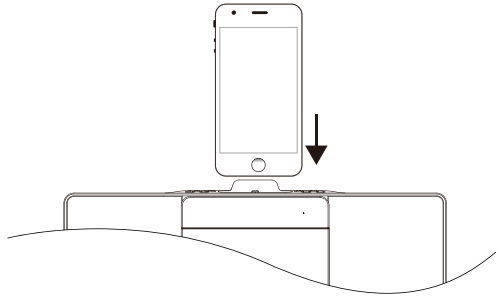

Charge the iPod/iPhone

- The docked iPod/iPhone begins to charge as soon as the unit is connected to AC power.

Bluetooth Operation

The unit has a Bluetooth function that can receive a signal within 8 metres.

Pair Bluetooth-enabled Devices

- The operational range between this player and a Bluetooth device is approximately 8 meters (without any object between the Bluetooth device and the unit).
 - Before you connect a Bluetooth device to this unit, ensure you know the device's capabilities.
 - Compatibility with all Bluetooth devices is not guaranteed.
 - Any obstacle between this unit and a Bluetooth device can reduce the operational range.
 - If the signal strength is weak, your Bluetooth receiver may disconnect, but it will re-enter pairing mode automatically.
- 1 Press the  button on the main unit or press the **BT/AUX** button on the remote control to select **BT**(Bluetooth) mode. "**NO BT**" will show on the display if the unit is not paired to any Bluetooth device.
 - 2 The system has entered pairing mode.
 - Or press and hold the "**▶ ||/PAIR**" button on the remote control or the "**▶ ||**" button on the unit to be searchable. The Bluetooth indicator will flash rapidly. The display will show "**PAIR**".
 - 3 Activate your Bluetooth device and select the search mode. "**inStudio 8021091**" will appear on your Bluetooth device.
 - 4 Select "**inStudio 8021091**" in the pairing list. Display panel shows "**BT**" while the pairing succeeds.
 - 5 To disconnect the Bluetooth function, switch to another function on the unit or disable the function from your Bluetooth device.

Tips:

- Enter "0000" for the password if necessary.
- If a connection exist, press and hold "▶ ||/PAIR" button on the unit or "▶ ||" button on remote control to re-activate the pairing mode, the connection will be interrupted.The display will show "PAIR".
- If no other bluetooth device pairs with this player within two minutes, the player will recover its previous connection.
- The player will also be disconnected when your device is moved beyond the operational range.
- If you want to reconnect your device to this player, place it within the operational range.
- If the device is moved beyond the operational range, when it is brought back, please check if the device is still connected to the player.
- If they are connected, display panel shows "BT".
- If the connection is lost, display panel shows "NO BT". Follow the instruction above to pair your device to the player again.

NFC (Near Field Communication) Operation

Pair your NFC-enabled mobile device directly with this unit by just a single tap.

1. Activate NFC on your mobile device.
 2. Tap the mobile device on the "nfc" icon of the unit.
 3. Operate your mobile device directly for playback features.
 4. Tap again on the "nfc" icon of the unit to disconnect.
 5. Disable NFC from your mobile device if needed.
- This function only works with mobile devices that support NFC technology.

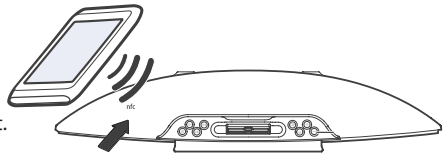

Listen to Music from Bluetooth Device

- If the connected Bluetooth device supports Advanced Audio Distribution Profile (A2DP), you can listen to the music stored on the device through the player.
 - If the device also supports Audio Video Remote Control Profile (AVRCP), you can use the player's remote control to play music stored on the device.
- 1 Pair your device with the player.
 - 2 Play music via your device (if it supports A2DP).
 - 3 Use supplied remote control to control play (if it supports AVRCP).
- To pause/resume play, press the ▶ || button.
 - To skip to a track, press the ◀◀, ▶▶ buttons.

AUX Operation

- 1 Press the  button on the main unit or press the **BT/AUX** button on the remote control to select **AUX** mode.
- 2 Operate your audio device directly for playback features.
- 3 Press the **VOL +/-** button to adjust the volume to your desired level.
- 4 In AUX mode, operate your audio device directly for playback features.

FM Operation

Auto Scan and Save Preset Station

- 1 Press the  button on the main unit or press the **DAB/FM** button on the remote control to select **FM** mode.
 - 2 Press the **INTRO** button on the to activate automatic programming. All available stations are programmed in the order of waveband reception strength.
 - The first programmed radio station is played automatically.
- **Tune to a Preset Radio Station**
 - Press the **▲** or **▼** buttons to select a preset number that you want.

Tuning in a Station

Tune in radio stations automatically

- Press and hold the **◀◀/▶▶** buttons, the frequency changes down or up automatically until a station is found.
 - The search may not stop at a station with a very weak signal.

Tune in radio stations manually

- Press the **◀◀/▶▶** buttons repeatedly until you find the station you want.
 - If reception is still poor, try to adjust the position of the aerial or try to move the radio to another location.

Presetting Stations Manually

You can preset up to 20 FM stations.

- 1 Tune in the desired station, then press the **PROG** button.
- 2 Press the **▲/▼** buttons to select the preset number.
- 3 Press the **PROG** button to store the station.
- 4 Repeat above steps 1 to 3 for each station you want to store in memory with a preset number.

Troubleshooting

To keep the warranty valid, never try to repair the system yourself. If you encounter problems when using this unit, check the following points before requesting service.

No power

- Ensure that the AC cord of the apparatus is properly connected .
- Ensure that there is power at the AC outlet.
- Press standby button to turn the unit on.

Remote control does not work

- Before you press any **SOURCE** button, first select the correct source.
- Reduce the distance between the remote control and the unit.
- Insert the battery with its polarities (+/-) aligned as indicated.
- Replace the battery.
- Aim the remote control directly at the sensor on the front of the unit.

No response from the unit

- Disconnect and reconnect the AC power plug, then turn the unit on again.

Poor radio reception

- Increase the distance between the unit and your NFC compatible bluetooth device or the TV and VCR.

Clock setting erased

- Power has been interrupted or the power cord has been disconnected.
- Reset the clock.

No Response From the Unit

- Disconnect and reconnect the AC power plug, then turn on the unit again.

I can not find the Bluetooth name of this unit on my Bluetooth device

- Ensure the Bluetooth function is activated on your Bluetooth device.
- Re-pair the unit with your Bluetooth device.

Some NFC-enabled mobile devices cannot pair directly with the unit via NFC Please try either one of the solutions below:

- Download and install NFC reader apps into your NFC-enabled mobile device. Please refer to your mobile device's guidebook for more details.
- Pair with the unit via Bluetooth first, then tap again on the icon.
- Simply pair with the unit via Bluetooth.

The disc does not play

- There is no disc inside the unit ("NO DISC" appears on the display).
- Insert the disc correctly with the label side facing up.
- Clean the disc.
- PAUSE mode may be activated, deactivate it.
- A non-valid disc has been inserted.
- Condensation may have formed inside the unit due to a sudden change in temperature. Wait about an hour for it to clear and try again.

Using iPhone to play music

- While the iPhone is playing the music through the docking, there may be a chance that the iPhone may not be under a good reception mode to get the incoming call signal.

Specifications

General

Power requirements.....	AC110-120V~ 60 Hz
Power consumption.....	25W
Output power (max).....	5W x2
Total harmonic distortion.....	1%(1kHz, 1W)
Audio input sensitivity	500mV
Frequency response.....	45Hz - 20KHz
Tuning range.....	87.5 - 108.0MHz
Main unit(W x H x D)	375 x 200 x 79 mm

Speakers

Total impedance.....	2 Ω
----------------------	-----

Remote Control

Distance.....	6m
Angle.....	30°

Standard Accessories

AC Power Cord.....	x 1
RCA audio Cable	x 1
Remote Control	x 1
Owner's Manual	x 1
Wall Mounting Guideline.....	x 1
Wall screws.....	x 2

- Design and specifications are subject to change without notice.