

onn.TM

USER GUIDE

2.1CH Soundbar with Subwoofer

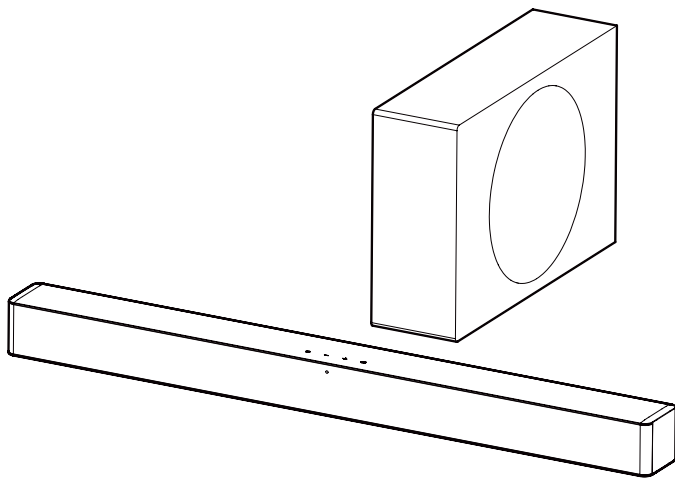

100130683

Contents & Information

Contents & Information	2	First Time Setup	13
Overview	3	Operation	18
Safety Precautions	6	Cleaning & Care	24
Unpacking	11	Specifications	25
Wall Mounting Setup (Optional)	12	Troubleshooting	26

Features

- 2.1 Channels
- Roku TV Ready™
- Bluetooth®
- DTS:X® and DTS® Virtual:X™
- 2 Internal speakers + 1 wireless subwoofer
- 120 W RMS output / 480 W peak output (4 x RMS)
- Dolby Atmos

Connections

- 1 x HDMI® (TV eARC/ARC)
- 1 x Optical
- 1 x AUX
- 1 x USB

Overview

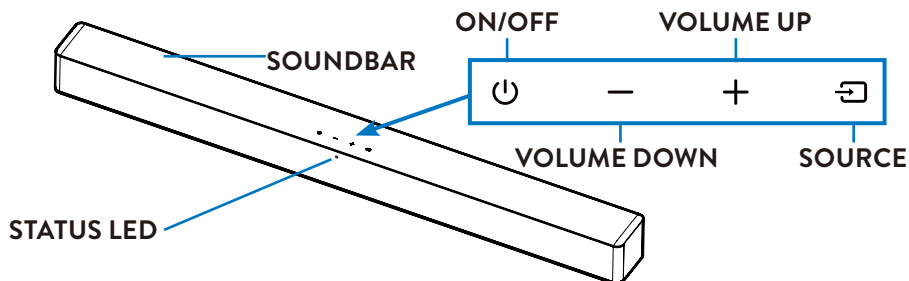

Standby	Solid Red
HDMI (TV eARC/ARC)	Solid Yellow
Optical	Solid Purple
Aux in	Solid White
USB	Solid Green
Bluetooth pairing mode	Flashing Blue
Bluetooth device connected	Solid Blue
Volume up/down	Corresponding source color flash 1 time
Maximum/minimum volume	Corresponding source color flash 3 times
Mute	Flashing Red
Talk	Corresponding source color flash 1 time
Music	Corresponding source color flash 3 times
Movie	Corresponding source color flash 5 times
Bass +/-	White Status LED flash 2 times
Treble +/-	White Status LED flash 2 times
VRT:X	Yellow Status LED flash 3 times

WIRELESS SUBWOOFER BACK

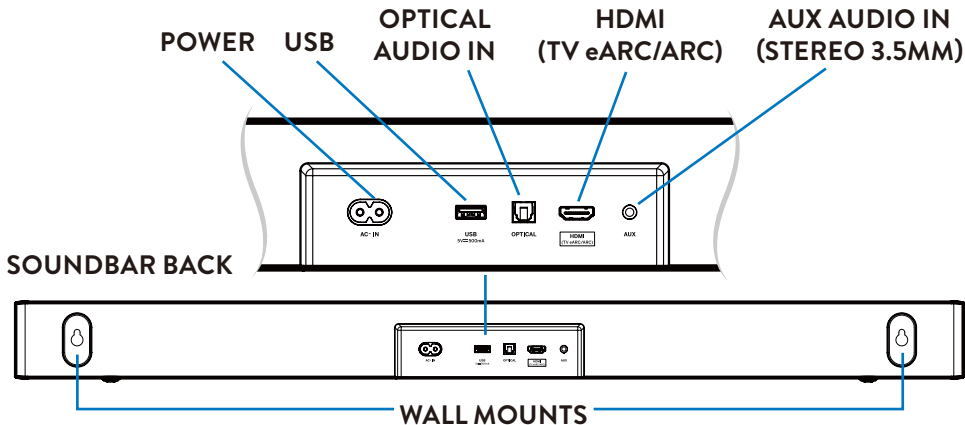
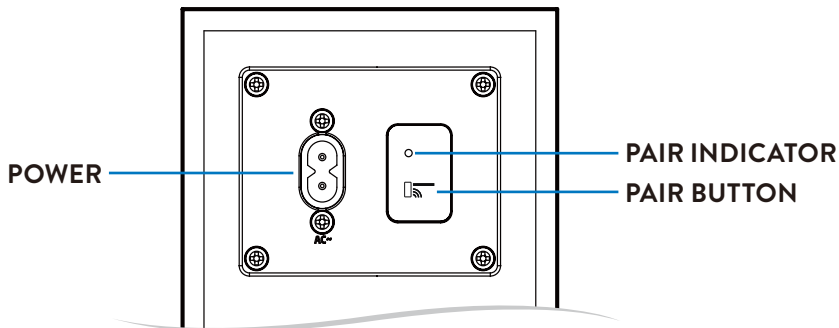

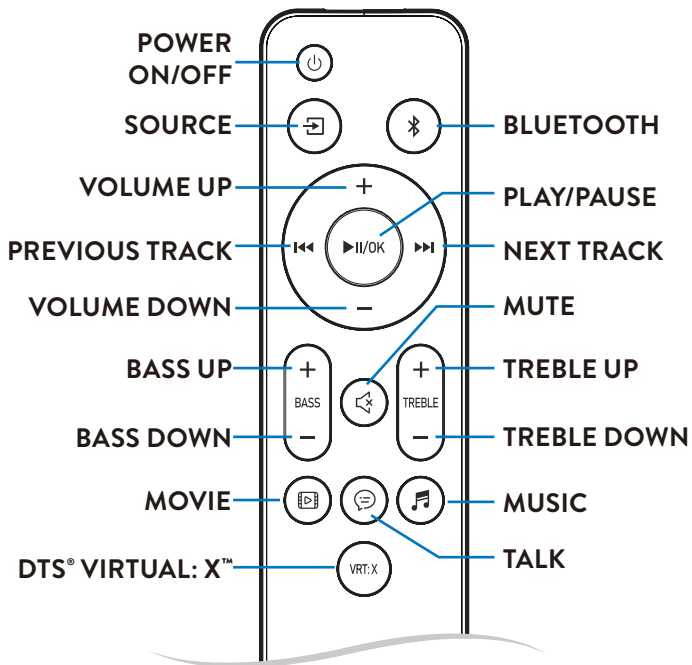

REMOTE CONTROL



Safety Precautions

WARNING

	CAUTION RISK OF ELECTRIC SHOCK DO NOT OPEN	
CAUTION: TO REDUCE THE RISK OF ELECTRIC SHOCK, DO NOT REMOVE COVER (OR BACK). NO USER-SERVICEABLE PARTS INSIDE. REFER SERVICING TO QUALIFIED SERVICE PERSONNEL.		



The lightning flash with arrowhead symbol, within an equilateral triangle, is intended to alert the user to the presence of uninsulated “dangerous voltage” within the product’s enclosure that may be of sufficient magnitude as to constitute a risk of electric shock to persons.



The exclamation point within an equilateral triangle is intended to alert the user to the presence of important operating and maintenance (servicing) instructions in the literature accompanying the appliance.

- Read these instructions – All safety and operating instructions should be read before product is operated.
- Keep these instructions – The safety and operating instructions should be retained for future reference.

- Heed all warnings – All warnings on appliance and in operating instructions should be adhered to.
- All operating and use instructions should be followed.
- Do not use this apparatus near water – Appliance should not be used near water or moisture – for example, in a wet basement or near a swimming pool, etc.
- Do not block any ventilation openings. Install in accordance with manufacturer’s instructions.
- Do not install near any heat sources such as radiators, heat registers, stoves, or other apparatus (including amplifiers) that produce heat.
- Do not defeat the safety purpose of the polarized or grounding plug. A polarized plug has two blades with one wider than the other. A grounding plug has two blades and a third grounding prong. The wide blade or the third prong is provided for your safety. If the provided plug does not fit into your outlet, consult an electrician for replacement of the obsolete outlet.
- Protect power cord from being walked on or pinched particularly at the plugs, convenience receptacles, and at the point where they exit from the apparatus.

- Only use attachments/accessories specified by the manufacturer.
- Use only with the cart, stand, tripod, bracket, or table specified by the manufacturer, or sold with the apparatus. When a cart or rack is used, use caution when moving the cart/apparatus combination to avoid injury from tip-over.
- Unplug apparatus during lightning storms or when unused for long periods of time.
- Refer all servicing to qualified personnel. Servicing is required when apparatus has been damaged in any way, such as power supply cord or plug is damaged, liquid has been spilled or objects have fallen into apparatus. Apparatus has been exposed to rain or moisture, does not operate normally, or has been dropped.
- Maintain ventilation around equipment. Do not install in a confined space such as a book case or similar unit. Do not cover the ventilation openings with items such as newspaper, table-cloths, curtains etc.
- This equipment is a Class II or double insulated electrical appliance. It has been designed in such a way that it does not require a safety connection to electrical earth.
- The equipment shall be used at maximum 35 degree C ambient temperature.
- Do not replace a battery with an incorrect type that can defeat a safeguard (for example, in the case of some lithium battery types).
- Do not dispose of a battery in a fire or a hot oven. Do not mechanically crush or cut a battery. These conditions can result in an explosion.
- Leaving a battery in an extremely high temperature environment can result in an explosion or the leakage of flammable liquid or gas.
- A battery subjected to extremely low air pressure may result in an explosion or the leakage of flammable liquid or gas. To reduce the risk of fire or electric shock, do not expose this apparatus to rain or moisture. The apparatus shall not be exposed to dripping, splashing or objects filled with liquids, such as vases, etc.
- The mains plug is used as disconnect device, the disconnect device shall remain readily operable.
- To reduce the risk of electric shock, do not remove cover (or back) as there are no user-serviceable parts inside. Refer servicing to qualified personnel.
- To prevent injury, this apparatus must be securely attached to the floor/wall in accordance with the installation instructions.
- Danger of explosion if the remote control batteries are incorrectly replaced. Replace only with the same or equivalent type.

FCC Statement :

This device complies with Part 15 of the FCC Rules. Operation is subject to the following two conditions: 1) This device may not cause harmful interference, and 2) This device must accept any interference received, including interference that may cause undesired operation.

Note: This equipment has been tested and found to comply with the limits for a Class B digital device, pursuant to part 15 of the FCC Rules. These limits are designed to provide reasonable protection against harmful interference in a residential installation. This equipment generates, uses and can radiate radio frequency energy and, if not installed and used in accordance with the instructions, may cause harmful interference to radio communications. However, there is no guarantee that interference will not occur in a particular installation. If this equipment does cause harmful interference to radio or television reception, which can be determined by turning the equipment off and on, the user is encouraged to try to correct the interference by one or more of the following measures:

- Reorient or relocate the receiving antenna.
- Increase the separation between the equipment and receiver.
- Connect the equipment into an outlet on a circuit different from that to which the receiver is connected.
- Consult the dealer or an experienced radio/TV technician for help.

FCC Caution:

- Changes or modifications not expressly approved by the party responsible for compliance could void the user's authority to operate the equipment.
- This equipment complies with FCC and IC radiation exposure limits set forth for an uncontrolled environment. This equipment should be installed and operated with minimum distance 20cm between the radiator & your body.
- Shielded cables must be used with this unit to ensure compliance with the Class B FCC limits.

This device contains licence-exempt transmitter(s)/receiver(s) that comply with Innovation, Science and Economic Development Canada's licence-exempt RSS(s). Operation is subject to the following two conditions:

- This device may not cause interference.
- This device must accept any interference, including interference that may cause undesired operation of the device.

L'émetteur/récepteur exempt de licence contenu dans le présent appareil est conforme aux CNR d'Innovation, Sciences et Développement économique Canada applicables aux appareils radio exempts de licence. L'exploitation est autorisée aux deux conditions suivantes:

- L'appareil ne doit pas produire de brouillage;
- L'appareil doit accepter tout brouillage radioélectrique subi, même si le brouillage est susceptible d'en compromettre le fonctionnement.

CAUTION

- Batteries should not be exposed to excessive heat such as sunshine, fire, etc.
- Keep new and used batteries away from children.
- If the battery compartment does not close securely, stop using the product and keep it away from children.
- If you think batteries might have been swallowed or placed inside any part of the body, seek immediate medical attention.

Dolby Atmos

Dolby, Dolby Atmos, and the double-D symbol are registered trademarks of Dolby Laboratories Licensing Corporation. Manufactured under license from Dolby Laboratories. Confidential unpublished works. Copyright © 2012-2021 Dolby Laboratories. All rights reserved.



The Adopted Trademarks HDMI, HDMI High-Definition Multimedia Interface, HDMI trade dress and the HDMI Logos are trademarks or registered trademarks of HDMI Licensing Administrator, Inc. in the United States and other countries.



The Bluetooth® word mark and logos are registered trademarks owned by the Bluetooth SIG, Inc. and any use of such marks by Walmart Inc. is under license. Other trademarks and trade names are those of their respective owners.



For DTS patents, see <http://patents.dts.com>. Manufactured under license from DTS, Inc. or DTS Licensing Limited. DTS, DTS:X, Virtual:X, and the DTS:X logo are registered trademarks or trademarks of DTS, Inc. in the United States and other countries. © 2021 DTS, Inc. ALL RIGHTS RESERVED.



Roku, the Roku logo, Roku TV, Roku TV Ready, and the Roku TV Ready logo are trademarks and/or registered trademarks of Roku, Inc.

This product is Roku TV Ready-supported in the United State. Countries are subject to change. For the most current list of countries in which this product is Roku TV Ready-supported, please email rokutvready@roku.com.

Unpacking

PARTS

Part	Description	Qty
1	Soundbar	1
2	Wireless Subwoofer	1
3	HDMI cable	1
4	Power cable	2

Part	Description	Qty
5	Wall mounting template	1
6	Wall mounting kit	1
7	Remote control (AAA batteries x2)	1

PARTS DIAGRAM

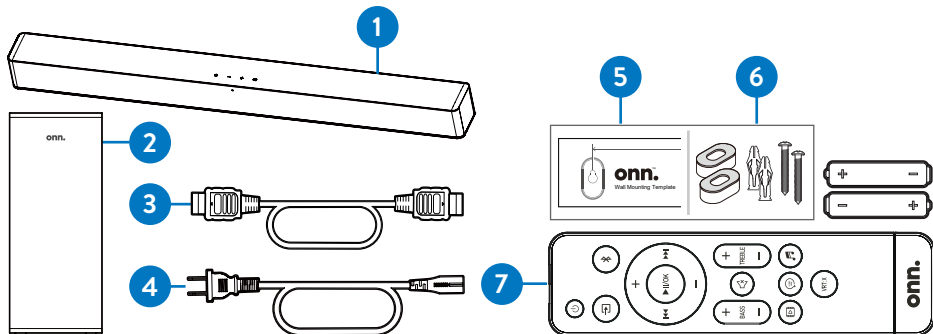

Wall Mounting Setup (Optional)

SETUP

TOOLS NEEDED (NOT SUPPLIED)



Drill bit



Drill



Cross Head Screwdriver



Ruler



Level



Hammer

HARDWARE

Part	Description	Picture	Qty
A	Rubber pads		2
B	Screws		2
C	Anchor		2

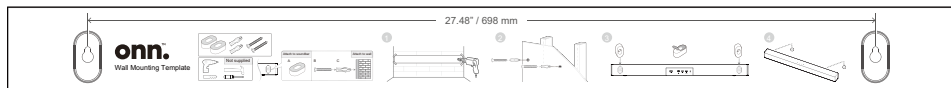

(Wall mounting, optional)

Wall mounting template

First Time Setup

ON A SURFACE



1A. CENTER

1. Below TV, close to ear level
2. Go to step 4

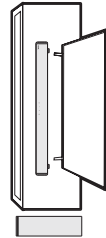
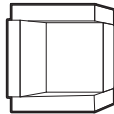

ON A WALL



1B. PLACE

1. Place wall mount template on wall under TV.
2. Mark Bracket holes (Ensure enough space between Soundbar and TV) See 3B. HANG.

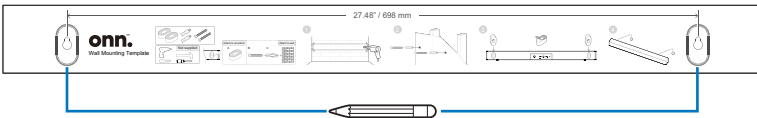
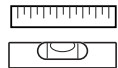

- Be sure screws will be attached to wood studs or use anchors for drywall, or anchors for concrete or brick walls.

ON A WALL



2B. INSTALL

Wall mounts Screws and Anchors (if required)



1. Drill holes



2. Hammer
in anchors(C)



3. Screw
in screws(B)
into anchors

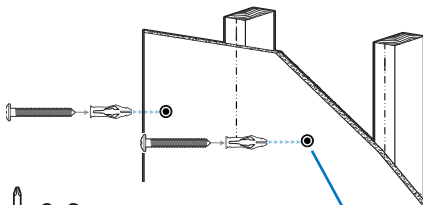

Anchors not
needed if screwed
into Studs

REQUIRED

(A) Rubber pads x2



(B) Screws x2



(C) Anchors x2

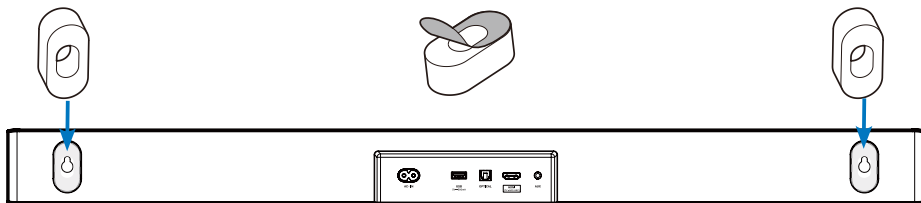

Remove the backing paper from the backs of the rubber pads and stick them to the back of the soundbar in the position shown in the diagram.

CAUTION

If you are unfamiliar with power tools or layout of electrical wiring in the walls of your home, consult a professional installer.

3B. HANG

Mounting hooks on screws then slide down to lock in place.

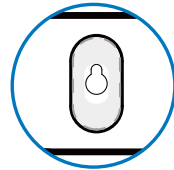
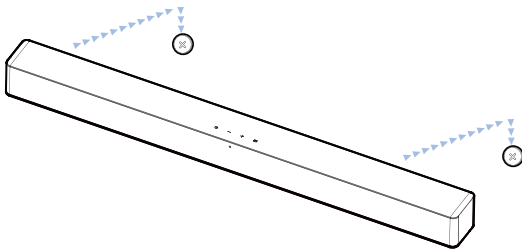

Note: Make sure wall mount orientation matches example

4. CHOOSE CABLE

Connect one cable to Soundbar and TV

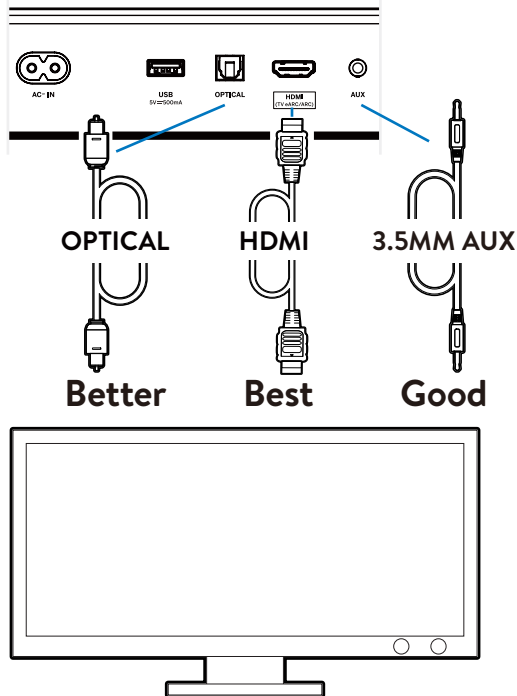

Tip: If you have a Roku TV™, setup will be easy. Just use the included cable to connect your soundbar to the HDMI (TV eARC/ARC) port on your TV and follow the on-screen instructions.

- To use **Dolby Atmos** and **dts x** in HDMI (TV eARC/ARC) mode, your TV has to support Dolby Atmos®
- Enable CEC and ARC on TV
- Settings for CEC and ARC may differ by TV manufacturer. See TV's user guide for more.
- To control soundbar volume on TV remote, enable System Audio Control in CEC menu.
- CEC Function naming may differ by TV Manufacturer. See TV's user guide for more.
- The full Dolby Atmos and DTS:X experience is only available when the soundbar is connected to the source via a HDMI 2.0 cable.
- * If no Audio using Digital Inputs See troubleshooting.

5. CONNECT POWER

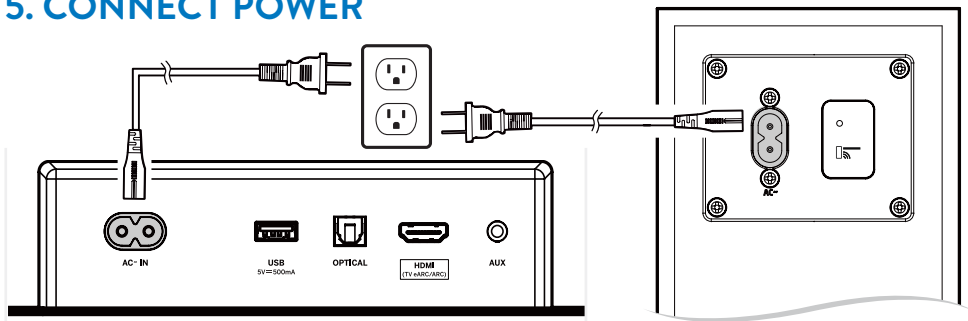

6. INSTALL BATTERIES

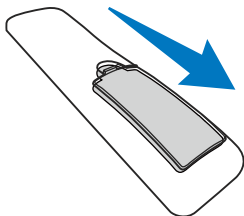

Remove battery door

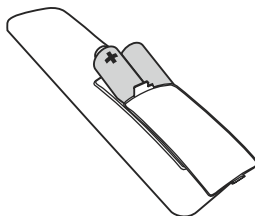

Insert batteries

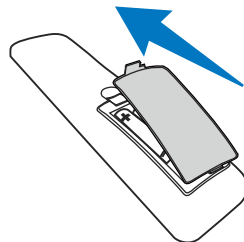

Close battery door



WARNING

Do not mix old and new batteries.



WARNING

Do not mix alkaline, standard (carbon-zinc) or rechargeable (ni-cad, ni-mh, etc.) batteries.

Operation

Connect Wireless Subwoofer



1A. AUTOMATIC PAIRING

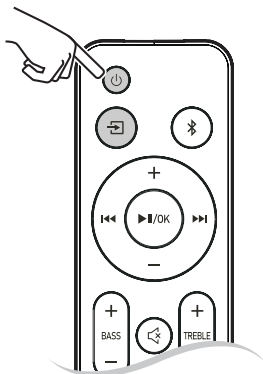

-OR-

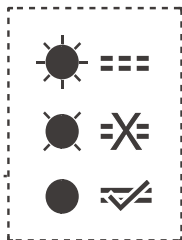
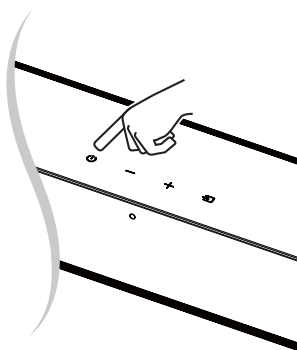

LED State

Status

Quick flash

Subwoofer in pairing mode

Slow flash

Connection/Pairing Failed



Solid

Connected/Pairing successful

Connect Wireless Subwoofer



1B. MANUAL PAIRING (IF AUTOMATIC PAIRING FAILED)

- A: Press and hold the PAIR button () of the wireless subwoofer.
- B: Press the Power button () on the soundbar or on the remote control.
- C: When wireless connection is successful, the indicator will be solid orange.

The indicator will flash rapidly.

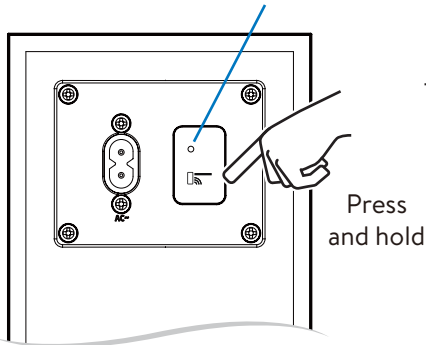

WARNING

The subwoofer is within 5m of the soundbar.

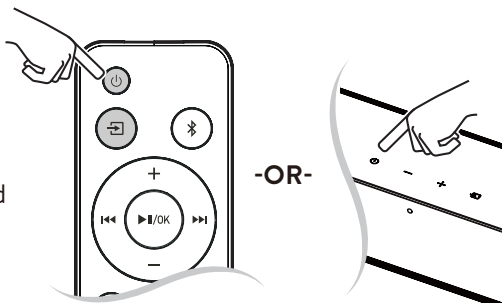

Bluetooth® Operation

1C. POWER ON/OFF

Soundbar
(Remote control or Bar)

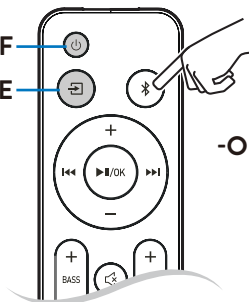

ON/OFF
SOURCE

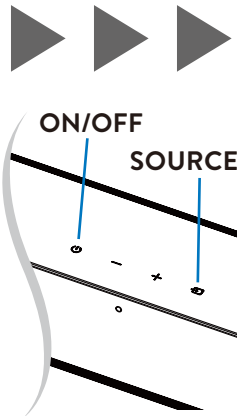

-OR-



2C. SELECT SOURCE

To switch between audio sources
(Remote control or Bar  button or  button on remote control)

3C. PAIR DEVICE

Press and hold the  button on remote control.

Press and hold

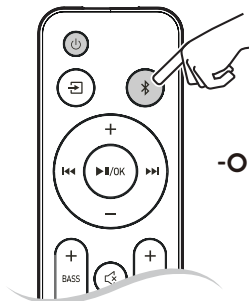

-OR-

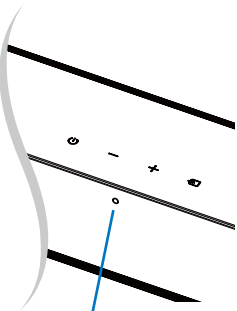

4C. SEARCH ON DEVICE

Select “onn. 2.1 Soundbar” on device

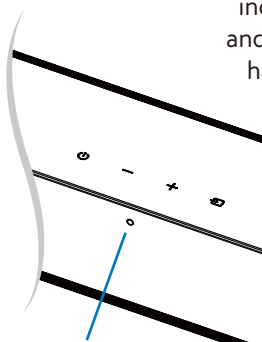
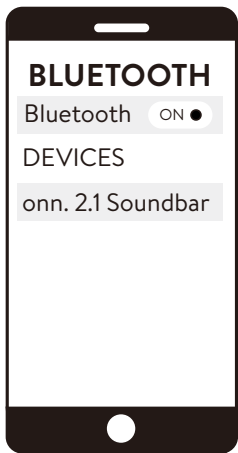

Device is connected when
Blue LED stops flashing
and becomes solid.



IMPORTANT

Soundbar does not include microphone and cannot operate as hands-free device.



WARNING

High volume levels can damage your hearing. Reduce the volume levels before pressing Play.

5C. PLAY AUDIO

From device

6C. VOLUME

Controlled by Device, Remote control or Soundbar

Bluetooth use

Your Soundbar supports music streaming from smartphones, tablets, and computers with Bluetooth capability.

Device compatibility will vary, see your device's documentation for more information. Once you have paired your source device to the Soundbar, as long as you stay within range of the Soundbar, your device should remain paired.

If the input is changed, the Bluetooth device will disconnect. If the source is changed back to Bluetooth, any paired Bluetooth device will reconnect automatically.

A Bluetooth signal has a range of up to 27 feet. Keep in mind that Bluetooth is a compressed audio format, so streamed music may lose some integrity when compared to a wired connection.

USB Operation



1D. INSERT THE USB DEVICE

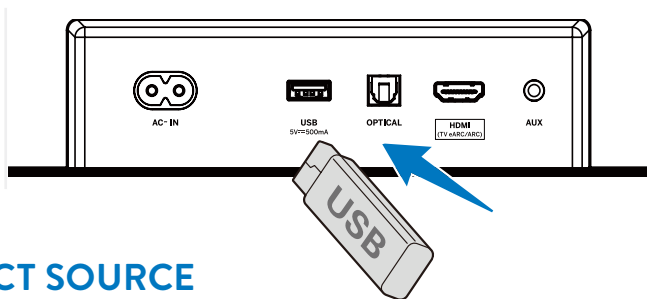



2D. SELECT SOURCE

Select USB Mode

(Remote or Soundbar  button)

3D. PLAY AUDIO

Tip: Support the USB music file format of MP3.

Button	Action
	Play, pause or resume play.
	Skip to the previous or next track.
	Increase/decrease the volume.

Cleaning & Care

CLEANING

- Wipe down surfaces with a light cloth.
- Never use abrasive pads to clean device.
- Avoid using liquids to clean device.



CAUTION

Ensure the unit is fully unplugged from the power supply before cleaning.

Specifications

Soundbar	
Power	100-240V~ 50/60Hz 30 W / < 0.5 W (StandBy)
USB	5V --- 500mA Full Speed USB / FAT32 / FAT16, MP3
Dimension (WxHxD)	31.57" x 2.62" x 3.09" (802 x 66.5 x 78.5 mm)
Net weight	2.64 lbs (1.2 kg)
Audio input sensitivity	500mV
Frequency Response	120Hz - 20KHz
Wireless Specification	
Bluetooth version/profiles Bluetooth frequency range	V 5.3 (A2DP, AVRCP) 2402 MHz ~ 2480 MHz
Modulation Type	GFSK, $\pi/4$ DQPSK, 8DPSK
Wireless Subwoofer	
Power	100-240V~ 50/60Hz 30 W / < 0.5 W (StandBy)
Dimension (WxHxD)	4.13" x 14.56" x 10.16" (105 x 370 x 258 mm)
Net weight	7.7 lbs (3.5 kg)
Frequency Response	40Hz - 120Hz
Remote Control	
Distance/Angle	19.7 feet (6m) / 30°
Battery type	AAA (1.5V x 2)

Troubleshooting

Problem	Cause	Solution
No power	Power off	Press “⏻” button on remote control or on Soundbar.
	Loose power cord	Ensure the power cord is securely connected.
	Faulty outlet	Plug a different device into the electrical outlet to verify that the outlet is working correctly
No audio	Low Volume / Mute	Press “🔊”
		Increase volume
	Some TVs do not Pass through Digital Audio	Change TV output to AUTO
	Input source	Select different Input source
	Not All TVs have Audio outputs listed.	Connect directly to another device (Blu-Ray, Game System, etc.)
	TV set to variable audio output	Set audio output to fixed or standard, NOT variable.

- Input LEDs will flash rapidly if an unsupported format is present.
- Consult your TV’s user manual for more detailed information.

Problem	Cause	Solution
No audio	Bluetooth source device	Increase volume / unmute source device
	Wireless subwoofer and soundbar too far	The wireless subwoofer is out of range, please move the wireless subwoofer closer to the soundbar. Make sure the wireless subwoofer is within 5m of the soundbar.
Bluetooth break-up or disconnect	Source too far	Move the source device closer to soundbar
	Solid obstruction	Move source device into line-of-site of soundbar
	Other wireless devices	Turn off / move devices away (wireless security cameras, wireless video baby monitors, cordless phones, and microwave ovens)

Remark: In standby mode, press the **VOL+** , **VOL-** , **⏮**, **⏭**, **⏸/OK** in sequence to enter Flat mode, it's only for debug use and the sound setting is Flat without DRC.

onn.TM

For product assistance:

WE CAN HELP

1-888-516-2630

7 DAYS/WEEK 7:00am- 9:00pm CST

**THIS GUIDE CONTAINS
IMPORTANT SAFETY
INFORMATION.**

PLEASE READ AND KEEP
FOR FUTURE REFERENCE.

Find more at **Walmart.com**

Manufactured in China for Walmart Inc.