

Hisense

2.1ch Theater Sound System SOUNDiVA Pro

Model: HS216F



 **Dolby** Atmos

HDMITM
HIGH-DEFINITION MULTIMEDIA INTERFACE

 **Bluetooth**[®]

USER MANUAL



Before using the sound bar, please read this manual thoroughly and retain it for future reference.

Contents

Important Safety Instructions	3	Basic Operation	13
Safety	3	Standby/ON	13
Warning	4	Auto-Standby / Auto-Wake Feature	13
What's in the Box	6	Select Modes	13
Identifying the Parts	7	Adjust the Bass/Treble Level	13
Main Unit	7	Turn the Surround Sound ON/OFF	13
Remote Control	8	Adjust the Volume	13
Preparations	8	Adjust the Brightness	13
Prepare the Remote Control	8	Select a Preset Sound Effect	13
Replace the Remote Control Battery	8	Set the Audio Delay	13
Placement and Mounting	9	OPTICAL / COAXIAL / HDMI eARC	14
Wall Mounting (if using option-B)	9	Operation	14
Connections	10	Bluetooth Operation	14
Dolby Atmos®	10	Pair Bluetooth-enabled Devices	14
Use the HDMI Socket	10	Listen to Music from Bluetooth Device	15
Use the OPTICAL Socket	11	USB Operation	15
Use the COAXIAL Socket	11	Troubleshooting	15
Use the IR Socket	11	Specifications	17
Connect Power	11		
Use the Hisense EzPlay Function	12		

Important Safety Instructions





The lightning flash with arrowhead symbol, within an equilateral triangle, is intended to alert the user to the presence of uninsulated “dangerous voltage” within the product’s enclosure that may be of sufficient magnitude as to constitute a risk of electric shock to persons.



The exclamation point within an equilateral triangle is intended to alert the user to the presence of important operating and maintenance (servicing) instructions in the literature accompanying the appliance.

Safety

- 1 **Read these instructions** – All the safety and operating instructions should be read before this product is operated.
- 2 **Keep these instructions** – The safety and operating instructions should be retained for future reference.
- 3 **Heed all warnings** – All warnings on the appliance and in the operating instructions should be adhered to.
- 4 **Follow all instructions** – All operating and usage instructions should be followed.
- 5 **Do not use this apparatus near water** – The appliance should not be used near water or moisture – for example, in a wet basement or near a swimming pool and the like.
- 6 **Clean only with a dry cloth.**
- 7 **Do not block any ventilation openings.** Install in accordance with the manufacturer’s instructions.
- 8 Do not install near any heat sources such as radiators, heaters, stoves, or other apparatus (including amplifiers) that produce heat.
- 9 Do not defeat the safety purpose of the polarized or grounding plug. A polarized plug has two blades with one wider than the other. A grounding plug has two blades and a third grounding prong. The wide blade or the third prong is provided for your safety. If the provided plug does not fit into your outlet, consult an electrician for replacement of the obsolete outlet.
- 10 Protect the power cord from being walked on or pinched particularly at plugs, convenience receptacles, and the point where they exit from the apparatus.
- 11 Only use attachments/accessories specified by the manufacturer.
- 12  Use only with the cart, stand, tripod, bracket or table specified by the manufacturer, or sold with the apparatus. When a cart or rack is used, use caution when moving the cart/apparatus combination to avoid injury from tip-over.
- 13 Unplug the apparatus during lightning storms or when unused for long periods of time.
- 14 Refer all servicing to qualified personnel. Servicing is required when the apparatus has been damaged in any way, such as power supply cord or plug is damaged, liquid has been spilled or objects have fallen into the apparatus, the unit has been exposed to rain or moisture, does not operate normally, or has been dropped.
- 15  This equipment is a Class II or double insulated electrical appliance. It has been designed in such a way that it does not require a safety connection to electrical earth.
- 16 The apparatus shall not be exposed to dripping or splashing. No objects filled with liquids, such as vases, shall be placed on the apparatus.
- 17 Minimum distance around the apparatus for sufficient ventilation is 5cm.
- 18 The ventilation should not be impeded by covering the ventilation openings with items, such as newspapers, table-cloths, curtains, etc...
- 19 No naked flame sources, such as lighted candles, should be placed on the apparatus.
- 20 Batteries should be recycled or disposed of as per state and local guidelines.
- 21 The use of apparatus in moderate or tropical climates.

Caution:

- Use of controls or adjustments or performance of procedures other than those described herein, may result in hazardous radiation exposure or other unsafe operation.
- To reduce the risk of fire or electric shock, do not expose this apparatus to rain or moisture. The apparatus must not be exposed to dripping or splashing and objects filled with liquids, such as vases, must not be placed on apparatus.
- The mains plug/appliance coupler is used as the disconnect device, the disconnect device must remain readily operable.
- Danger of explosion if battery is incorrectly replaced. Replace only with the same or equivalent type.

Warning

- The battery (batteries or battery pack) shall not be exposed to excessive heat such as sunshine, fire or the like.
- Before operating this system, check the voltage of this system to see if it is identical to the voltage of your local power supply.
- Do not place this unit close to strong magnetic fields.
- Do not place this unit on the amplifier or receiver.
- If any solid object or liquid falls into the system, unplug the system and have it checked by qualified personnel before operating it any further.
- Do not attempt to clean the unit with chemical solvents as this may damage the finish. Use a clean, dry or slightly damp cloth.
- When removing the power plug from the wall outlet, always pull directly on the plug, never yank on the cord.
- Changes or modifications to this unit not expressly approved by the party responsible for compliance will void the user's authority to operate the equipment.
- The rating label is pasted on the bottom or back of the equipment.

Battery usage CAUTION

To prevent battery leakage which may result in bodily injury, property damage, or damage to the apparatus:

- Install all batteries correctly, + and - as marked on the apparatus.
- Do not mix old and new batteries.
- Do not mix alkaline, standard (Carbon-Zinc) or rechargeable (Ni-Cd, Ni-MH, etc.) batteries.
- Remove batteries when the unit is not used for a long time.



Correct Disposal of this product. This marking indicates that this product should not be disposed with other household wastes throughout the EU.

To prevent possible harm to the environment or human health from uncontrolled waste disposal, recycle it responsibly to promote the sustainable reuse of material resources. To return your used device, please use the return and collection systems or contact the retailer where the product was purchased. They can take this product for environmental safe recycling.



We hereby declares that this product is in compliance with the essential requirements and other relevant provisions of Directive 2014/53/EU.



The Bluetooth® word mark and logos are registered trademarks owned by Bluetooth SIG, Inc. and any use of such marks by Hisense is under license. Other trademarks and trade names are those of their respective owners.



The terms HDMI and HDMI High-Definition Multimedia Interface, and the HDMI Logo are trademarks or registered trademarks of HDMI Licensing Administrator, Inc.



Dolby, Dolby Atmos, and the double-D symbol are registered trademarks of Dolby Laboratories Licensing Corporation. Manufactured under license from Dolby Laboratories. Confidential unpublished works. Copyright © 2012-2020 Dolby Laboratories. All rights reserved.

Supported input audio formats

The audio formats supported by this system are as follows.

Format	Function			
	HDMI IN	TV ARC	TV OPT	TV COA
LPCM 2ch	✓	✓	✓	✓
LPCM 5.1ch	✓	X	X	X
LPCM 7.1ch	✓	X	X	X
Dolby Digital	✓	✓	✓	✓
Dolby TrueHD	✓	✓	X	X
Dolby Digital Plus	✓	✓	X	X
Dolby Atmos - Dolby TrueHD	✓	✓	X	X
Dolby Atmos - Dolby Digital Plus	✓	✓	X	X

✓: Supported formats.

X: Unsupported format.

Note: The HDMI IN jack does not support copy-protected audio formats such as Super Audio CD or DVD-Audio.

Supported HDMI video formats

The video formats supported by this system are as follows.

Resolution	Frame rate	3D	Color space	Color depth	[HDMI Signal Format] setting
4K 4096 x 2160p ³⁾ 3840 x 2160p	50/59.94/60 Hz	-	RGB 4:4:4 YCbCr 4:4:4	8 bits	[enhanced format] ¹⁾
		-	YCbCr 4:2:2	8/10/12 bits	
		-	YCbCr 4:2:0	10/12 bits	
	23.98/24/25/ 29.97/30 Hz	-	RGB 4:4:4 YCbCr 4:4:4	10/12 bits	
4K 4096 x 2106p ³⁾ 3840 x 2106p	50/59.94/60 Hz	-	YCbCr 4:2:0	8 bits	[standard format] ²⁾
	23.98/24/25/ 29.97/30 Hz	-	RGB 4:4:4 YCbCr 4:4:4	8 bits	
		-	YCbCr 4:2:2	8/10/12 bits	
1920 x 1080p	25/29.97/30/50/ 59.94/60 Hz	-	RGB 4:4:4 YCbCr 4:4:4 YCbCr 4:2:2	8/10/12 bits	
	23.98/24 Hz	⊙			
1920 x 1080i	50/59.94/60 Hz	○			
1280 x 720p	50/59.94/60 Hz	⊙			
	23.98/24/29.97/30 Hz	-			
720 x 480p	59.94/60 Hz	-			
720 x 576p	50 Hz	-			
640 x 480p	59.94/60 Hz	-	RGB 4:4:4		

○: Compatible with side-by-side (half width)³⁾ format 3D signals

⊙: Compatible with frame packing and 3D signals in³⁾ format

1) Please use a high-quality high-speed HDMI Ethernet cable that supports 18Gbps.

2) Please use a high quality high speed HDMI Ethernet cable.

What's in the Box



Main Unit

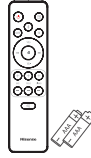

Remote Control /
AAA Batteries x 2

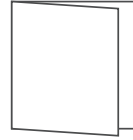

User Manual

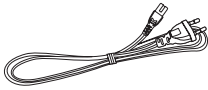

AC power Cord



HDMI Cable

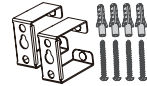

Wall Bracket



IR pass-through Cable

- Power cord quantity and plug type vary by regions.
- Images, illustrations and drawings shown on this User Manual are for reference only, actual product may vary in appearance.
- Design and specifications are subject to change without notice.

Identifying the Parts



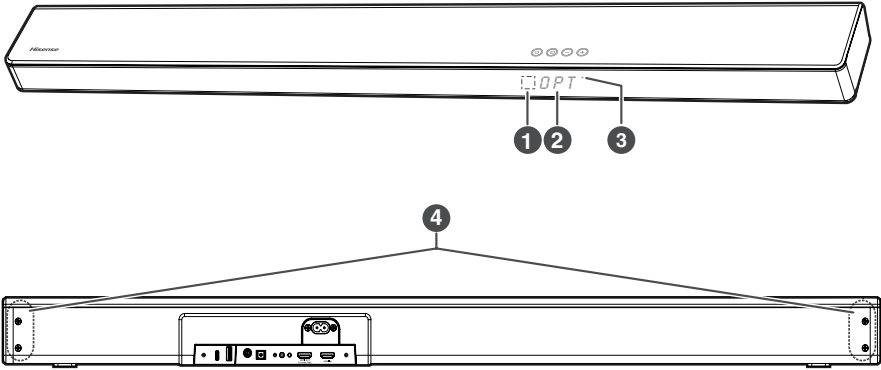



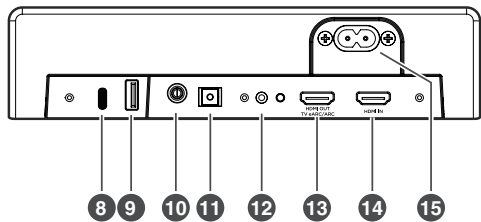
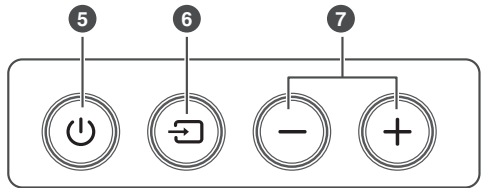

Main Unit



- 1 Remote Control Sensor**
Receive signal from the remote control.
- 2 Display Window**
Show the current status.
- 3 Standby Indicator**
- 4 Screws**
Remove the screws then install the wall mounting screws into the back of the unit.
- 5 (ON/OFF) button**
Switch the unit between ON and Standby mode.
- 6 (SOURCE) button**
Select the play function.
- 7 VOL+/VOL- buttons**
Increase/decrease the volume level.
- 8 DONGLE Socket**
- 9 USB Socket**
Insert the USB device to play music.
- 10 COAXIAL Socket**
- 11 OPTICAL Socket**
- 12 IR Socket**
IR pass-through Cable connector.
- 13 HDMI OUT (TV eARC/ARC) Socket**
Connect to a TV via HDMI cable.
- 14 HDMI IN Socket**
- 15 AC~ Socket**



Remote Control

- 1  Switch the unit between ON and STANDBY mode.
- 2  (SOURCE) Select the play function.
- 3 **SURR** Adjust the surround ON/OFF.
- 4  (BT) Select the Bluetooth mode.
Press the  (BT) button to disconnect the current Bluetooth connection or re-enter the pairing state.
- 5 **EQ** Select a preset sound effect.
- 6  Skip to previous/next track in BT/USB mode.
- 7 **VOL+ / VOL-** Increase/decrease the volume level.
- 8  Press and hold the  button of the remote control for 3s to enter the MENU, the Main Unit displays "MENU".
- 9 **BASS+/-** Adjust bass level.
- 10 **TREBLE+/-** Adjust treble level.
- 11 **DIMMER+/-** Adjust display brightness.
- 12  (MUTE) Mute or resume the sound.

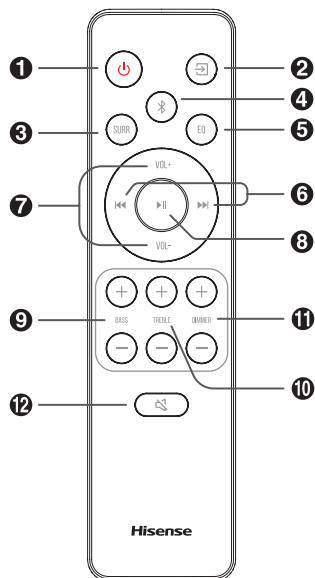

Preparations

Prepare the Remote Control

The provided Remote Control allows the unit to be operated from a distance.

- Even if the Remote Control is operated within the effective range 19.7 feet (6m), remote control operation may be impossible if there are any obstacles between the unit and the remote control.
- If the Remote Control is operated near other products which generate infrared rays, or if other remote control devices using infra-red rays are used near the unit, it may operate incorrectly. Conversely, the other products may operate incorrectly.

Replace the Remote Control Battery

- 1 Press and slide the back cover to open the battery compartment of the remote control.
- 2 Insert two **AAA** size batteries (included). Make sure the (+) and (-) ends of the batteries match the (+) and (-) ends indicated in the battery compartment.
- 3 Close the battery compartment cover.

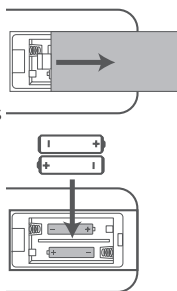

Precautions Concerning Batteries

- Be sure to insert the batteries with correct positive "+" and negative "-" polarities.
- Use batteries of the same type. Never use different types of batteries together.
- Either rechargeable or non-rechargeable batteries can be used. Refer to the precautions on their labels.
- Be aware of your fingernails when removing the battery cover and the battery.
- Do not drop the remote control.
- Do not allow anything to impact the remote control.
- Do not spill water or any liquid on the remote control.
- Do not place the remote control on a wet object.
- Do not place the remote control under direct sunlight or near sources of excessive heat.
- Remove the battery from the remote control when not in use for a long period of time, as corrosion or battery leakage may occur and result in physical injury, and/or property damage, and/or fire.
- Do not use any batteries other than those specified.
- Do not mix new batteries with old ones.
- Never recharge a battery unless it is confirmed to be a rechargeable type.

Placement and Mounting

Placement

- A If your TV is placed on a table, you can place the unit on the table directly in front of the TV stand, centered with the TV screen.
- B If your TV is attached to a wall, you can mount the unit on the wall directly below the TV screen.

Wall Mounting (if using option-B)

Note:

- Installation must be carried out by qualified personnel only. Incorrect assembly can result in severe personal injury and property damage (if you intend to install this product yourself, you must check for installations such as electrical wiring and plumbing that may be buried inside the wall). It is the installer's responsibility to verify that the wall will safely support the total load of the unit and wall brackets.
 - Additional tools (not included) are required for the installation.
 - Do not overtighten screws.
 - Keep this instruction manual for future reference.
 - Use an electronic stud finder to check the wall type before drilling and mounting.
1. Drill 2 parallel holes (\varnothing 5.5-6 mm each according to wall type) in the wall. The distance between the holes should be 927 mm.
 2. Firmly fix 1 dowel into each hole in the wall if necessary. Tighten the wall mount brackets on the wall with screws and screwdriver. Make sure that they are securely installed.
 3. Remove the screws at the back of the unit. Install the wall mounting screws into the back of the unit.
 4. Lift the unit onto the wall mount brackets and slot into place.

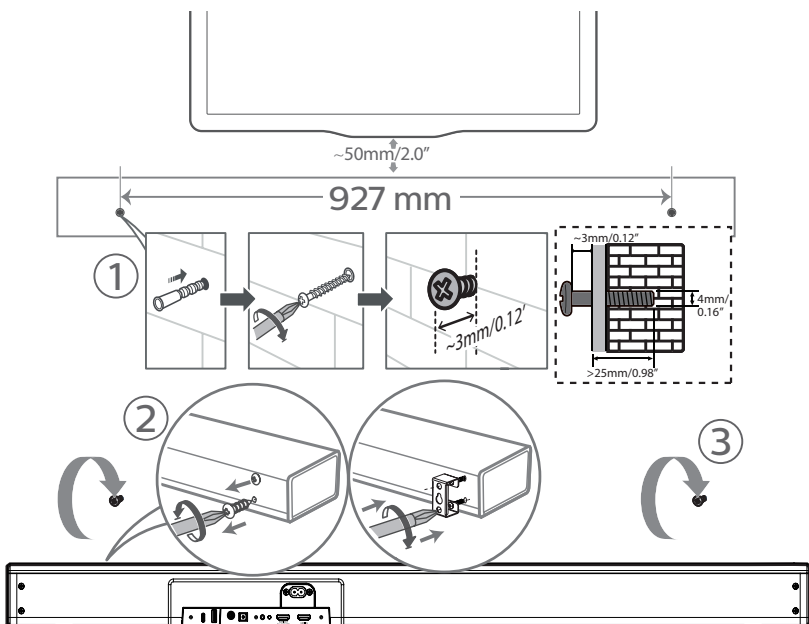
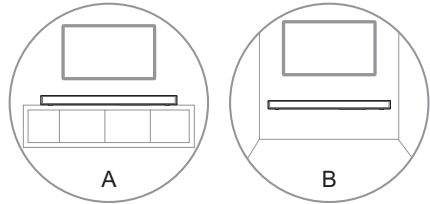

Connections

Dolby Atmos®

Dolby Atmos gives you amazing experience you have never before by overhead sound, and all the richness, clarity, and power of Dolby sound.

For using Dolby Atmos®

Dolby Atmos® is available only in HDMI mode. For the details of the connection, please refer to “**HDMI Connection**”.

1. To use Dolby Atmos® in HDMI IN mode, Your TV had to support Dolby Atmos® or HDMI audio passthrough.
2. Make sure that “No Encoding” is selected for bitstream in the audio output of the connected external device (e.g. Blu-ray DVD player, TV etc.).
3. While entering Dolby Atmos / Dolby Digital / PCM format, the soundbar will show DOLBY ATMOS / DOLBY AUDIO / PCM AUDIO.
4. While the soundbar is using Dolby Atmos audio, you can only adjust the bass level of the subwoofer. All other EQ effects will not be available.

Use the HDMI Socket

Some 4K HDR TVs require the HDMI input or picture settings to be set for HDR content reception. For further setup details on HDR display, please refer to the instruction manual of your TV.

Using HDMI to connect the soundbar, AV equipment and TV:

Method 1: eARC (Audio Return Channel)

The ARC (Audio Return Channel) function allows you to send audio from your ARC-compliant TV to your soundbar through a single HDMI connection. To enjoy the ARC function, please ensure your TV is both HDMI-CEC and ARC compliant and set up accordingly. When correctly set up, you can use your TV remote control to adjust the volume output (VOL +/- and MUTE) of the soundbar.

- Connect the HDMI cable from unit's **HDMI OUT (TV eARC/ARC)** socket to the HDMI (ARC) socket on your ARC compliant TV. Then press the remote control to select **HDMI eARC**.

Tips:

- Your TV must support the HDMI-CEC and ARC function. HDMI-CEC and ARC must be set to On.
- The setting method of HDMI-CEC and ARC may differ depending on the TV. For details about ARC function, please refer to the owner's manual.

Method 2: Standard HDMI

- If your TV is not HDMI ARC-compliant, connect your soundbar to the TV through a standard HDMI connection.
1. Use an HDMI cable to connect the soundbar's **HDMI OUT (TV eARC/ARC)** socket to the TV's HDMI IN socket.
 2. Use an HDMI cable to connect the soundbar's **HDMI IN** socket to your external devices (e.g. games consoles, DVD players and blu ray).

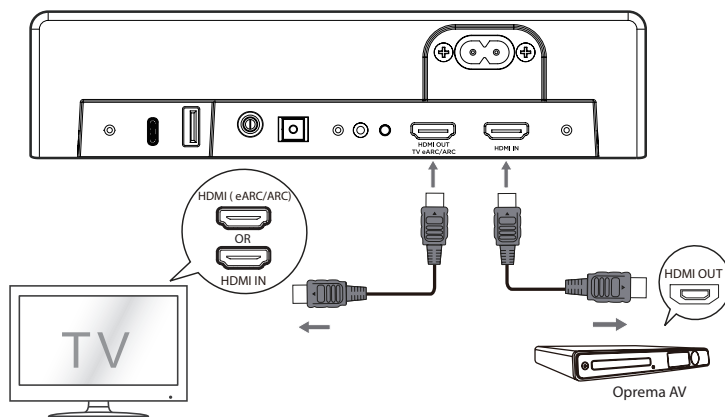

Use the OPTICAL Socket

- Remove the protective cap of the **OPTICAL** socket, then connect an OPTICAL cable to the TV's OPTICAL OUT socket and the **OPTICAL** socket on the unit.

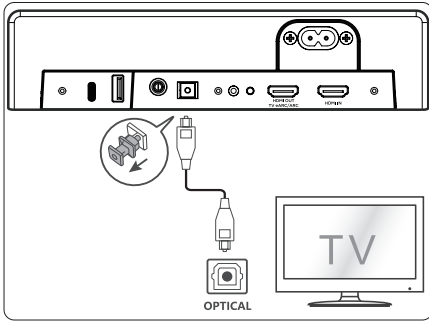

Use the COAXIAL Socket

- You also can use the COAXIAL cable to connect the TV's COAXIAL OUT socket and COAXIAL socket on the unit.

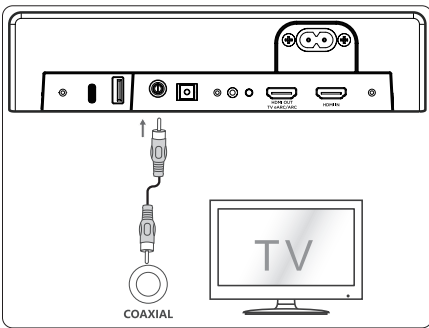

Tip: The unit may not be able to decode all digital audio formats from the input source. In this case, the unit will mute. This is NOT a defect. Ensure that the audio setting of the input source (e.g. TV, game console, DVD player, etc.) is set to **PCM** or **Dolby Digital** (Refer to the user manual of the input source device for its audio setting details) with HDMI / OPTICAL / COAXIAL input.

Use the IR Socket

If the Soundbar blocks the IR receiver of the TV when placing directly in front of it, you can connect the Soundbar and TV with the supplied IR pass-through cable so that it can receive signal from the remote control of your TV.

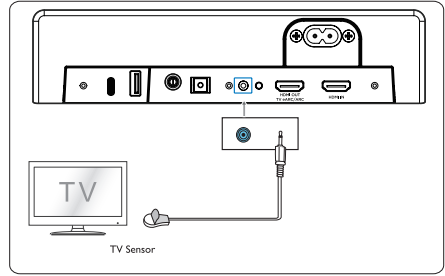

- Connect the 2.5mm end of the IR pass-through cable to the IR OUT connector on your Soundbar.
- Then, place the other end with the IR blaster close to the TV sensor. For information, check the user manual of your TV.

Connect Power

Risk of product damage!

- Ensure that the power supply voltage corresponds to the voltage printed on the back or the underside of the unit.
- Before connecting the AC power cord, ensure you have completed all other connections.

Soundbar

- Connect the mains cable to the **AC~** Socket of main unit and then into a mains socket.

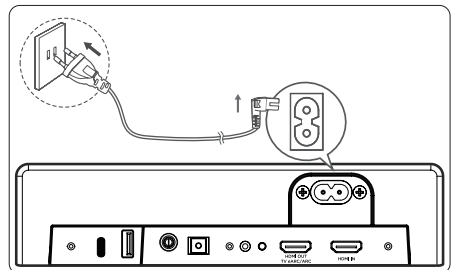

Use the Hisense EzPlay Function

For Hisense EzPlay, when the Soundbar connects with a Hisense TV via HDMI ARC, there will be a Soundbar Setting menu on the TV, and you can control this menu via your TV remote to control most of the Soundbar features.

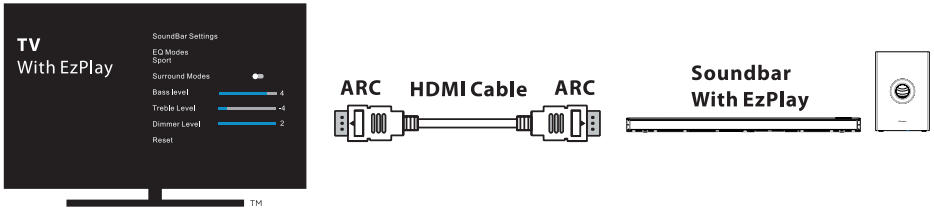

TV menu example(different models may have different menus): Setting--sound--Soundbar Setting.

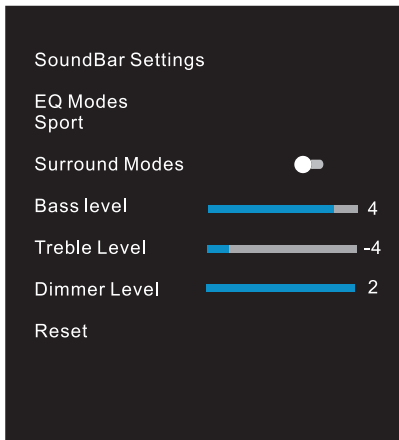

Note:

- This function is available only when both Soundbar and TV support Hisense EzPlay.
- This function requires Soundbar and TV connected via HDMI ARC, and the CEC of the TV must be turned ON.
- If everting setting right, for the first time connect, there would be a tip on the TV screen to guide you find the Soundbar setting menu.

Basic Operation

Standby/ON

When you first connect the main unit to the mains socket, the main unit will be in Standby mode.

- Press the **⏻** button on the unit or on the remote control to switch the unit ON.
- Press the **⏻** button again to switch the unit back to STANDBY mode.
- Disconnect the mains plug from the mains socket if you want to switch the unit OFF completely.

Auto-Standby / Auto-Wake Feature

- **[Auto-Standby]** Your sound bar has been programmed to enter Standby mode automatically when no audio is detected for 15 minutes. For example, this would happen when pausing playback, or should the sound bar be left on accidentally.
- **[Auto-Wake]** If a TV or an external device is connected (COAXIAL/OPTICAL socket), the unit will switch on automatically when the TV or the external device is switched on. To disable this feature, please follow the steps below:
 1. Ensure the sound bar is in Power-ON state.
 2. Pointing the remote at the soundbar, press and hold the **▶▶** button to open the menu. Press the **▶▶** button 6 times in succession, the display shows: **[AutoWake ON] / [AutoWake OFF] / [AutoStandby ON] / [AutoStandby OFF]**.
 3. Select the content with **VOL +/-** button on the remote controller, and then press **▶▶** to confirm your selection and the exit the settings.
- Repeating these steps will toggle the feature ON and OFF.

Select Modes

Press the **☐** (SOURCE) button repeatedly on the unit or on the remote control to select the **OPTICAL, COAXIAL, HDMI eARC, HDMI IN, Bluetooth** and **USB** mode. The selected mode will show on the display.

Adjust the Bass/Treble Level

- Press the **TREBLE +/-** buttons to increase or decrease the treble.
(treble+5 / treble-5)
- Press the **BASS +/-** buttons to increase or decrease the bass.
(bass+5 / bass-5)

Turn the Surround Sound ON/OFF

- Press the **SURR** button on the remote control to turn on the surround sound. Press this button again to turn off the surround sound.

Adjust the Volume

- Press the **VOL+ / VOL-** buttons on the unit or on the remote control to adjust the volume.
- If you wish to turn the sound off, press the **🔇** (MUTE) button on the remote control. Press the **🔇** (MUTE) button again or press the **VOL+ / VOL-** buttons to resume normal listening.

Adjust the Brightness

- Press the **DIMMER +/-** button on the remote control to select brightness level.

Select a Preset Sound Effect

- While playing, press the **EQ** button on the remote control to select desired preset equalizers:
MUSIC, MOVIE, NEWS, SPORT, NIGHT, GAME, HI-RES, AI EQ

Set the Audio Delay

Video image processing, sometimes longer than the time required to process the audio signal. This is called "delayed." Audio Delay feature is designed to remedy this delay. By default, the audio delay is set to 0.

- Set the audio delay, provided only for the current playback mode. (As provided in the HDMI ARC audio delay mode, the delay mode is valid only for the HDMI ARC).
 1. Ensure the sound bar is in Power-ON state.
 2. Pointing the remote at the soundbar, press and hold the **▶▶** button to open the menu. Press the button 9 times in succession, the display shows: **[LATENCY 00]**

- Press the VOL+/- buttons will be hopping to adjust the delay time. Set 60 ms maximum delay.

Tip:

- Adjustment range: **[00~60ms]**
- The audio delay setting is only valid for digital audio (eg HDMI IN, HDMI eARC, COAXIAL, OPTICAL).

OPTICAL / COAXIAL /HDMI eARC Operation

- Ensure that the unit is connected to the TV or audio device.
- Press the  button repeatedly on the unit or on the remote control to select the **OPTICAL, COAXIAL, HDMI eARC** mode.
- Operate your audio device directly for playback features.
- Press the **VOL +/-** button to adjust the volume to your desired level.

Tip:

- The unit may not be able to decode all digital audio formats from the input source. In this case, the unit will mute. This is NOT a defect. Ensure that the audio setting of the input source (e.g. TV, game console, DVD player, etc.) is set to **PCM** or **Dolby Digital** (Refer to the user manual of the input source device for its audio setting details) with HDMI IN / HDMI eARC / OPTICAL / COAXIAL input.
- When selecting a different audio format, the unit will display the following as follows:

Audio (abbreviation)	Display
LPCM 2ch	PCM
LPCM 5.1ch	PCM
LPCM 7.1ch	PCM
Dolby Digital	DOLBY AUDIO
Dolby TrueHD	DOLBY AUDIO
Dolby Digital Plus	DOLBY AUDIO
Dolby Atmos - Dolby TrueHD	DOLBY ATMOS
Dolby Atmos - Dolby Digital Plus	DOLBY ATMOS

Bluetooth Operation

Pair Bluetooth-enabled Devices

The first time you connect your bluetooth device to this player, you need to pair your device to this player.

Note:

- The operational range between this player and a Bluetooth device is approximately 26 feet (8m) (without any object between the Bluetooth device and the unit).
- Before you connect a Bluetooth device to this unit, ensure you know the device's capabilities.
- Compatibility with all Bluetooth devices is not guaranteed.
- Any obstacle between this unit and a Bluetooth device can reduce the operational range.
- If the signal strength is weak, your Bluetooth receiver may disconnect, but it will re-enter pairing mode automatically.

- During ON mode, press the  button repeatedly on the unit or the  (BT) button on the remote control to select Bluetooth mode. "NO_BT" will show on the display if the unit is not paired to any Bluetooth device.
- Activate your Bluetooth device and select the search mode. "Hisense SOUNDIVA Pro" will appear on your Bluetooth device list.
 - If you cannot find the unit, press and hold the  (BT) button on the remote control to be searchable. The display will show "BT PAIRING" and you will hear "Pairing" from the unit.
- Select "Hisense SOUNDIVA Pro" in the pairing list. After successful pairing, you will hear "Paired" from the unit, and the display panel shows "BT_IN".
- Play music from the connected Bluetooth device.

To disconnect the Bluetooth function, you can :

- Switch to another function on the unit.
- Disable the function from your Bluetooth device. The Bluetooth device will be disconnected from the unit after the "Disconnected" voice prompt.
- Press and hold the  (BT) button on the remote control.

Tips:

- Enter "0000" for the password if necessary.
- If no other Bluetooth device pairs with this player within two minutes, the player will recover its previous connection.
- The player will also be disconnected when your device is moved beyond the operational range.
- If you want to reconnect your device to this player, place it within the operational range.
- If the device is moved beyond the operational range, when it is brought back, please check if the device is still connected to the player.
- If the connection is lost, follow the instructions above to pair your device to the player again.

Listen to Music from Bluetooth Device

- If the connected Bluetooth device supports Advanced Audio Distribution Profile (A2DP), you can listen to the music stored on the device through the player.
1. Pair your device with the player.
 2. Play music via your device (if it supports A2DP).
 3. Use supplied remote control to control play (if it supports AVRCP).
- To pause/resume play, press the **▶||** button on the remote control.
 - To skip to a track, press the **◀◀/▶▶** buttons on the remote control.

USB Operation

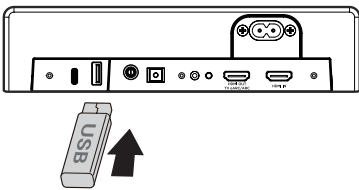

- 1 Insert the USB device.
- 2 Press the **USB** button repeatedly on the unit or on the remote control to select **USB** mode.
- 3 During playback:
 - To pause or resume play, press the **▶||** button on the remote control.

- To skip to the previous/next file, press the **◀◀/▶▶** buttons on the remote control.

Tips:

- The unit can support USB devices with up to 32 GB of memory.
- This unit can play WAV/WMA/MP3/FLAC/DSD/ALAC.
- Support a USB port: exFAT/FAT16/FAT32.

Troubleshooting

To keep the warranty valid, never try to repair the system yourself. If you encounter problems when using this unit, check the following points before requesting service.

No power

- Ensure that the AC cord of the apparatus is properly connected.
- Ensure that there is power at the AC outlet.
- Press standby button to turn the unit on.

Remote control does not work

- Before you press any playback control button, first select the correct source.
- Reduce the distance between the remote control and the unit.
- Insert the battery with its polarities (+/-) aligned as indicated.
- Replace the battery.
- Aim the remote control directly at the sensor on the front of the unit.

No sound

- Make sure that the unit is not muted. Press **MUTE** or **VOL+/VOL-** button to resume normal listening.
- Press **⏻** button on the unit or on the remote control to switch the soundbar to standby mode. Then press the **⏻** button again to switch the soundbar on.
- Ensure the audio setting of the input source (e.g. TV, game console, DVD player, etc.) is set to PCM or Dolby Digital mode while using digital (e.g. HDMI, OPTICAL, COAXIAL) connection.
- The unit may not be able to decode all digital audio formats from the input source. In this case, the unit will mute. This is NOT a defect. device is not muted.

I can't find the Bluetooth name of this unit on my Bluetooth device for Bluetooth pairing

- Ensure the Bluetooth function is activated on your Bluetooth device.
- Ensure you have paired the unit with your Bluetooth device.

This is a 15 mins power off function, one of the ERPII standard requirement for saving power

- When the unit's external input signal level is too low, the unit will be turned off automatically in 15 minutes. Please increase the volume level of your external device.

Specifications

Model Name	HS216F
-------------------	--------

Soundbar	
Power Supply	AC100-240V~ 50/60Hz
Power Consumption	30 W
Standby Power	< 0.5 W
USB port for playback	5V = 500mA
USB Compatibility	Hi-Speed USB (2.0) / FAT32
USB Playback support / file formats	32G (max) , WAV/WMA/MP3/FLAC/DSD/ALAC
Dimension (WxHxD)	960 x 68 x 105.3 mm
Net weight	3.6 kg
Audio input sensitivity	500mV
Frequency Response	120Hz - 20KHz
Wireless Specification	
Bluetooth Version	V 4.2
Bluetooth Maximum power transmitted	<5 dbm
Frequency bands	2402 MHz ~ 2480 MHz
Amplifier (Output power)	
Soundbar	60W, 30W x 2 (@10%THD)
Remote Control	
Distance/Angle	19.7 feet (6m) / 30°
Battery type	AAA (1.5V X 2)



WARNING: This product can expose you to chemicals including Lead, which is known to the State of California to cause cancer. For more information go to: www.P65Warnings.ca.gov.

EN

FCC INFORMATION (for US customers)

NOTE:

- This equipment has been tested and found to comply with the limits for a Class B digital device, pursuant to Part 15 of the FCC Rules. These limits are designed to provide reasonable protection against harmful interference in a residential installation. This equipment generates, uses and can radiate radio frequency energy and, if not installed and used in accordance with the instructions, may cause harmful interference to radio communications.
- However, there is no guarantee that interference will not occur in a particular installation. If this equipment does cause harmful interference to radio or television reception, which can be determined by turning the equipment off and on, the user is encouraged to try to correct the interference by one or more of the following measures:
 - Reorient or relocate the receiving antenna.
 - Increase the separation between the equipment and receiver.
 - Connect the equipment into an outlet on a circuit different from that to which the receiver is connected.
 - Consult the dealer or an experienced radio / TV technician for help.

This device complies with Part 15 of the FCC Rules. Operation is subject to the following two conditions:

- (1) this device may not cause harmful interference, and
 - (2) this device must accept any interference received, including interference that may cause undesired operation.
- Shielded cables must be used with this unit to ensure compliance with the Class B FCC limits.

IC Notice:

This device contains licence-exempt transmitter(s)/receiver(s) that comply with Innovation, Science and Economic Development Canada's licence-exempt RSS(s). Operation is subject to the following two conditions:

1. This device may not cause interference.
2. This device must accept any interference, including interference that may cause undesired operation of the device.

Warning:

- This equipment should be installed and operated with minimum distance 20cm between the radiator & your body.
- Changes or modifications to this unit not expressly approved by the party responsible for compliance could void the user's authority to operate the equipment."



FR

Réglement de la FCC (pour les clients américains)

REMARQUE :

- Ce dispositif a été testé et déclaré conforme aux limites d'un dispositif numérique de classe B, conformément à la partie 15 des règles de la FCC.
Ces limites ont pour but d'assurer une protection raisonnable contre le brouillage nuisible dans une installation résidentielle. Cet équipement produit, utilise et peut émettre de l'énergie en radio fréquence et, s'il n'est pas installé et utilisé conformément aux directives, il peut causer un brouillage nuisible dans les communications radio.
- Cependant, il n'est pas garanti que des interférences ne se produiront pas dans une installation particulière. Si cet appareil provoque des interférences nuisibles à la réception radio ou de télévision, ce qui peut être déterminé en mettant l'appareil hors tension, l'utilisateur est encouragé à essayer de corriger l'interférence par une ou plusieurs des mesures suivantes :
 - Réorienter ou déplacer l'antenne de réception.
 - Augmenter la distance entre l'appareil et le récepteur.
 - Brancher l'appareil à une prise sur un circuit différent de celui sur lequel le récepteur est branché.
 - Consulter le revendeur ou un technicien radio/TV expérimenté.

Cet appareil est conforme à la partie 15 des règles de la FCC. Son fonctionnement est soumis aux deux conditions suivantes :

- (1) ce dispositif ne peut pas causer d'interférences nuisibles et
 - (2) cet appareil doit accepter toute interférence reçue, y compris les interférences qui peuvent causer un mauvais fonctionnement.
- Des câbles blindés doivent être utilisés avec cet appareil pour assurer la conformité avec les limites de la classe B de la FCC. fonctionnement de l'appareil.

Avis d'Industrie Canada

L'émetteur/récepteur exempt de licence contenu dans le présent appareil est conforme aux CNR d'Innovation, Sciences et Développement économique Canada applicables aux appareils radio exempts de licence. L'exploitation est autorisée aux deux conditions suivantes :

1. L'appareil ne doit pas produire de brouillage;
2. L'appareil doit accepter tout brouillage radioélectrique subi, même si le brouillage est susceptible d'en compromettre le fonctionnement.

Avvertissement :

- Pour rester en conformité avec les consignes d'exposition aux RF, placez le produit à au moins 20 cm des personnes proches.
- Les changements ou modifications de cet appareil non expressément approuvées par la partie responsable de la conformité pourraient annuler l'autorisation de l'utilisateur à utiliser l'équipement.

Hisense

HS216F