

# Hisense

2.1 Soundbar with built-in Subwoofer

Model: HS2000



 **Dolby** Audio

 **Bluetooth**®

 **HDMI**™  
HIGH-DEFINITION MULTIMEDIA INTERFACE

 **dts**®

**Complete UM on web**



Before using the soundbar, please read this manual thoroughly and retain it for future reference.

# Contents

<b>1. What's in the Box .....</b>	<b>3</b>
<b>2. Product Diagram .....</b>	<b>4</b>
2.1 Main Unit .....	4
2.2 Remote Control .....	5
<b>3. Preparations .....</b>	<b>5</b>
3.1 Prepare the Remote Control .....	5
3.2 Replace the Remote Control Battery .....	5
3.3 Placement and Mounting .....	6
3.4 Wall Mounting (if using option-B).....	6
<b>4. Connections .....</b>	<b>7</b>
4.1 Use the HDMI ARC Socket.....	7
4.2 Use the OPTICAL Socket.....	8
4.3 Use the COAXIAL Socket .....	8
4.4 Use the AUX Socket.....	8
4.5 Connect Power .....	8
<b>5. Basic Operation .....</b>	<b>8</b>
5.1 Standby/ON .....	8
5.2 Auto-Standby / Auto-Wake .....	9
5.3 Select Modes .....	9
5.4 Adjust the Volume .....	9
5.5 Turn the Surround Sound ON/OFF .....	9
5.6 Select Equalizer (EQ) Effect.....	9
5.7 Adjust the Bass/Treble .....	9
5.8 Adjust the Brightness.....	9
5.9 Voice prompts ON/OFF.....	9
5.10 Factory reset.....	9
<b>6. AUX/ OPTICAL/COAXIAL/HDMI ARC Operation .....</b>	<b>10</b>
<b>7. USB Operation .....</b>	<b>10</b>
<b>8. Bluetooth Operation .....</b>	<b>10</b>
<b>9. Troubleshooting.....</b>	<b>11</b>
<b>10. Specifications.....</b>	<b>12</b>

# 1. What's in the Box

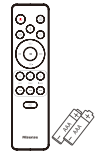
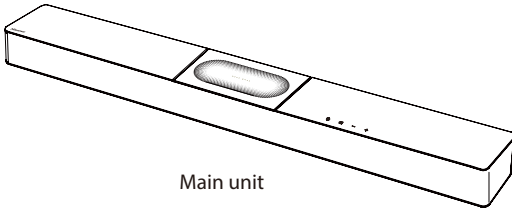

Remote control  
AAA batteries x 2 \*\*

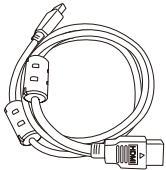

HDMI cable



AC Power cord \*

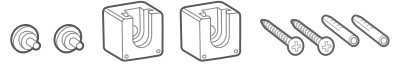

Wall mount kit  
Bracket(x2) / Wall Plug(x2) /  
screw(x2) / bracket screw(x2)

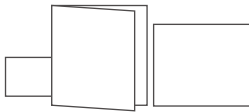

Warranty card/Quick start manual /  
Wall mount guide

- \* Power cord quantity and plug type vary by regions. \*\* The accessories may be different from the list above due to different models, countries/ regions, please refer to the actual accessory bag.
- Images, illustrations and drawings shown on this User Manual are for reference only, actual product may vary in appearance.





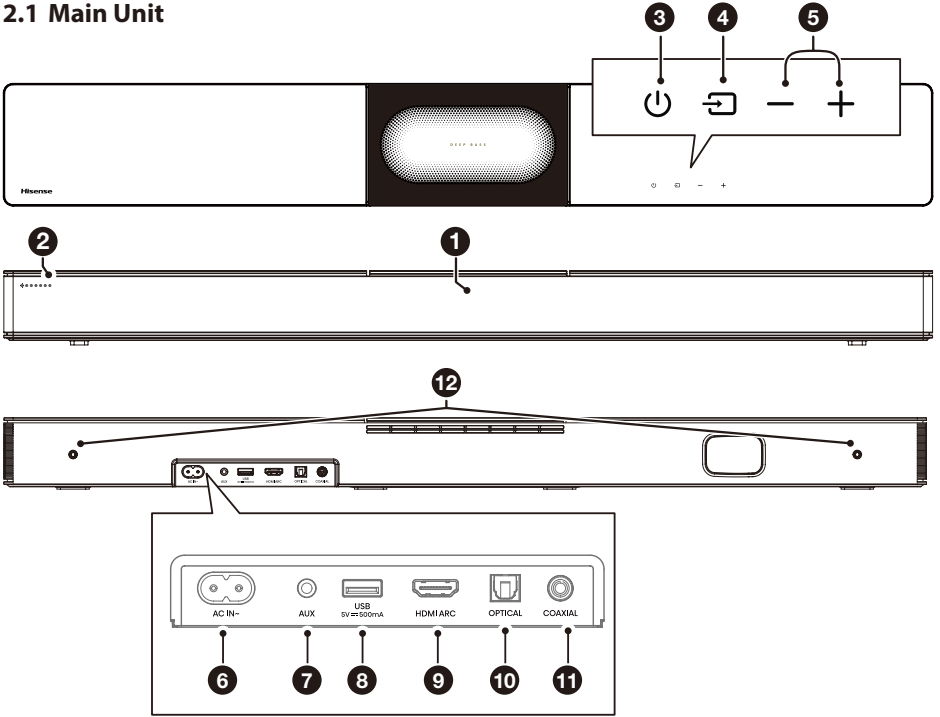

## 2. Product Diagram

### 2.1 Main Unit



- | <p>① <b>Remote Control Sensor</b><br/>Receive signal from the remote control.</p> <p>② <b>LED Indicators</b></p> <table border="1" style="width: 100%; border-collapse: collapse;"> <thead> <tr> <th style="text-align: left;">Lamp</th> <th style="text-align: left;">Mode</th> </tr> </thead> <tbody> <tr> <td>● Red</td> <td>Standby</td> </tr> <tr> <td>● Green</td> <td>AUX</td> </tr> <tr> <td>● Blue</td> <td>BT (Bluetooth)</td> </tr> <tr> <td>● Orange</td> <td>OPTICAL</td> </tr> <tr> <td>● Light blue</td> <td>COAXIAL</td> </tr> <tr> <td>● White</td> <td>HDMI ARC</td> </tr> <tr> <td>● Yellow</td> <td>USB</td> </tr> </tbody> </table> <p>③ <b>(ON/OFF) Button</b><br/>Switch the soundbar between ON and Standby mode.</p> <p>④ <b>(SOURCE) Button</b><br/>Select the play function.</p> | Lamp           | Mode | ● Red | Standby | ● Green | AUX | ● Blue | BT (Bluetooth) | ● Orange | OPTICAL | ● Light blue | COAXIAL | ● White | HDMI ARC | ● Yellow | USB | <p>⑤ <b>+/- (Volume) Buttons</b><br/>Increase/decrease the volume level.</p> <p>⑥ <b>AC IN ~ Socket</b><br/>Connect to the power supply.</p> <p>⑦ <b>AUX Socket</b><br/>Connect to an external audio device.</p> <p>⑧ <b>USB Socket</b><br/>Insert the USB device to play music.</p> <p>⑨ <b>HDMI ARC Socket</b><br/>Connect to a TV via HDMI cable.</p> <p>⑩ <b>OPTICAL Socket</b><br/>Connect to an optical audio output on the TV.</p> <p>⑪ <b>COAXIAL Socket</b><br/>Connect to the <b>COAXIA</b> audio output on the TV.</p> <p>⑫ <b>Wall hanging points</b></p> |
|---|----------------|------|-------|---------|---------|-----|--------|----------------|----------|---------|--------------|---------|---------|----------|----------|-----|---|
| Lamp  | Mode           |      |       |         |         |     |        |                |          |         |              |         |         |          |          |     |   |
| ● Red   | Standby        |      |       |         |         |     |        |                |          |         |              |         |         |          |          |     |   |
| ● Green   | AUX            |      |       |         |         |     |        |                |          |         |              |         |         |          |          |     |   |
| ● Blue  | BT (Bluetooth) |      |       |         |         |     |        |                |          |         |              |         |         |          |          |     |   |
| ● Orange  | OPTICAL        |      |       |         |         |     |        |                |          |         |              |         |         |          |          |     |   |
| ● Light blue  | COAXIAL        |      |       |         |         |     |        |                |          |         |              |         |         |          |          |     |   |
| ● White   | HDMI ARC       |      |       |         |         |     |        |                |          |         |              |         |         |          |          |     |   |
| ● Yellow  | USB            |      |       |         |         |     |        |                |          |         |              |         |         |          |          |     |   |

## 2.2 Remote Control

- ①  Switch the unit between ON and STANDBY mode.
- ②  (SOURCE) Select the play function.
- ③ **SURR** Adjust the surround ON/OFF.
- ④  (BT) Select the Bluetooth mode. Press and hold the  (BT) button to activate the pairing function in Bluetooth mode or disconnect the existing paired Bluetooth device.
- ⑤ **EQ** Select a preset sound effect.
- ⑥  Skip to previous/next track in BT / USB mode.
- ⑦ **VOL+ / VOL-** Increase/decrease the volume level.
- ⑧  Play/pause/resume playback in BT / USB mode.
- ⑨ **BASS + / -** Adjust bass level.
- ⑩ **TREBLE + / -** Adjust treble level.
- ⑪ **DIMMER + / -** Adjust LED brightness.
- ⑫  (MUTE) Mute or resume the sound.

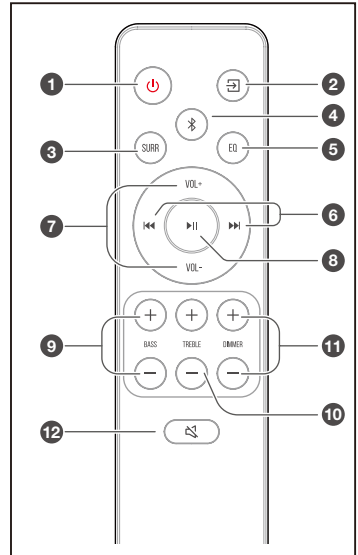

## 3. Preparations

### 3.1 Prepare the Remote Control

The provided Remote Control allows the unit to be operated from a distance.

- Even if the Remote Control is operated within the effective range 19.7 feet (6m), remote control operation may be impossible if there are any obstacles between the unit and the remote control.
- If the Remote Control is operated near other products which generate infrared rays, or if other remote control devices using infra-red rays are used near the unit, it may operate incorrectly. Conversely, the other products may operate incorrectly.

### 3.2 Replace the Remote Control Battery

- 1 Press and slide the back cover to open the battery compartment of the remote control.
- 2 Insert two AAA size batteries. Make sure the (+) and (-) ends of the batteries match the (+) and (-) ends indicated in the battery compartment.
- 3 Close the battery compartment cover.

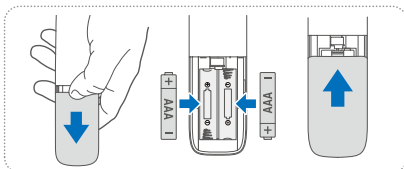

### Precautions Concerning Batteries

- Be sure to insert the batteries with correct positive “+” and negative “-” polarities.
- Use batteries of the same type. Never use different types of batteries together.
- Either rechargeable or non-rechargeable batteries can be used. Refer to the precautions on their labels.
- Be aware of your fingernails when removing the battery cover and the battery.
- Do not drop the remote control.
- Do not allow anything to impact the remote control.
- Do not spill water or any liquid on the remote control.
- Do not place the remote control on a wet object.
- Do not place the remote control under direct sunlight or near sources of excessive heat.
- Remove the battery from the remote control when not in use for a long period of time, as corrosion or battery leakage may occur and result in physical injury, and/or property damage, and/or fire.
- Do not use any batteries other than those specified.
- Do not mix new batteries with old ones.
- Never recharge a battery unless it is confirmed to be a rechargeable type.

### 3.3 Placement and Mounting

#### Placement

- A If your TV is placed on a table, you can place the unit on the table directly in front of the TV stand, centered with the TV screen.
- B If your TV is attached to a wall, you can mount the unit on the wall directly below the TV screen.

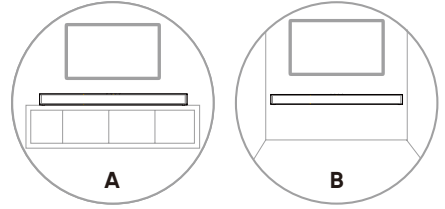

#### 3.4 Wall Mounting (if using option-B)

##### Note:

- Installation must be carried out by qualified personnel only. Incorrect assembly can result in severe personal injury and property damage (if you intend to install this product yourself, you must check for installations such as electrical wiring and plumbing that may be buried inside the wall). It is the installer's responsibility to verify that the wall will safely support the total load of the unit and wall brackets.
- Additional tools (not included) are required for the installation.
- Do not overtighten screws.
- Keep this instruction manual for future reference.
- Use an electronic stud finder to check the wall type before drilling and mounting.

##### WARNING

- To prevent injury, this apparatus must be securely attached to the floor/wall in accordance with the installation instructions.
- Suggested wall mounting height:  $\leq 1.5$  meters.

1. Drill 2 parallel holes ( $\varnothing 5.5$ -6 mm each according to wall type) in the wall. The distance between the holes should be **680mm/26.8"**.
2. Firmly fix 1 dowel into each hole in the wall if necessary. Tighten the wall mount brackets on the wall with screws and screwdriver (included). Make sure that they are securely installed.
3. Remove the screws at the back of the unit. Install the wall mounting screws into the back of the unit.
4. Lift the unit onto the wall mount brackets and slot into place.

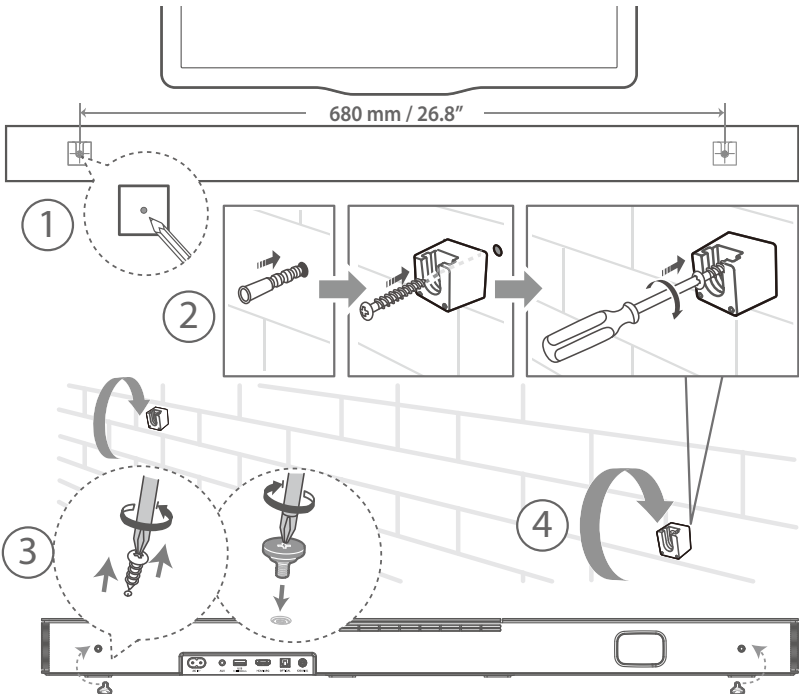

## 4. Connections

### 4.1 Use the HDMI ARC Socket

The ARC (Audio Return Channel) function allows you to send audio from your ARC-compliant TV to your soundbar through a single HDMI connection. To enjoy the ARC function, please ensure your TV is both HDMI-CEC and ARC compliant and set up accordingly. When correctly set up, you can use your TV remote control to adjust the volume output (VOL +/- and Mute) of the soundbar.

- Connect the HDMI cable from unit's **HDMI ARC** socket to the HDMI (ARC) socket on your ARC compliant TV. Then press the remote control to select **HDMI ARC**.

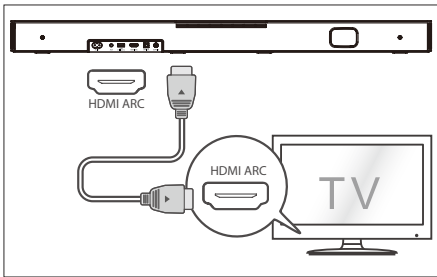

#### Tips:

- Your TV must support the HDMI-CEC and ARC function. HDMI-CEC and ARC must be set to On.
- The setting method of HDMI-CEC and ARC may differ depending on the TV. For details about ARC function, please refer to the owner's manual.
- Only HDMI 1.4 or higher version cable can support the ARC function.

### Use the Roku TV

- If you have a Roku TV™, simply plug in the HDMI cable to the ARC ports and follow the Roku TV Ready™ on-screen instructions.



- ✓ Simple setup
- ✓ One remote
- ✓ Quick settings

### Use the Hisense EzPlay Function

For Hisense EzPlay, when the Soundbar connects with a Hisense TV via HDMI ARC, it will be a Soundbar Setting menu on the TV, and you can control this menu via your TV remote to control most of the Soundbar features.

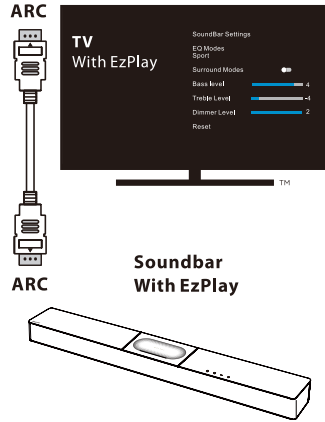

TV menu example (different models may have different menus):

#### Setting--sound--Soundbar Setting.

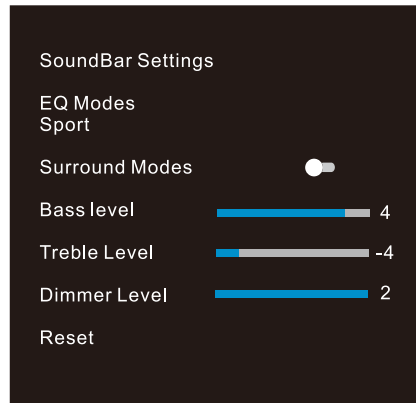

#### Note:

- This function is available only when both Soundbar and TV support Hisense Ezplay.
- This function requires Soundbar and TV connected via HDMI ARC, and the CEC of the TV must be turned ON.
- If everytime setting right, for the first time connect, there would be a tip on the TV screen to guide you find the Soundbar setting menu.

## 4.2 Use the OPTICAL Socket

- Connect an OPTICAL cable to the TV's OPTICAL OUT socket and the **OPTICAL** socket on the unit.

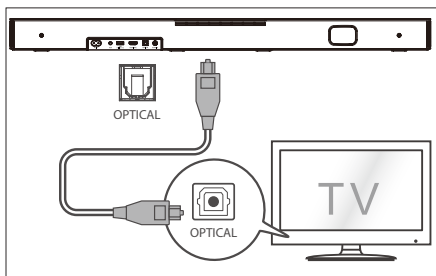

## 4.3 Use the COAXIAL Socket

- You also can use the COAXIAL cable to connect the TV's COAXIAL OUT socket and COAXIAL socket on the unit.

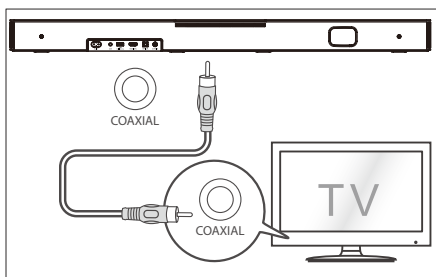

**Tip:** The Soundbar may not be able to decode all digital audio formats from the input source. In this case, the Soundbar will mute. This is NOT a defect. Ensure that the audio setting of the input source (e.g. TV, game console, DVD player, etc.) is set to **PCM** or **Dolby Digital** (Refer to the user manual of the input source device for its audio setting details) with HDMI ARC / OPTICAL / COAXIAL input.

## 4.4 Use the AUX Socket

- A. Use a 3.5mm to 3.5mm audio cable to connect the TV's or external audio device headphone socket to the **AUX** socket on the unit.
- B. Use a RCA to 3.5mm audio cable to connect the TV's audio output sockets to the **AUX** socket on the unit.

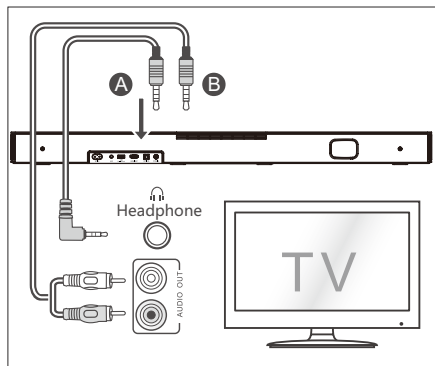

## 4.5 Connect Power

### Risk of product damage!

- Ensure that the power supply voltage corresponds to the voltage printed on the back or the underside of the unit.
- Before connecting the AC power cord, ensure you have completed all other connections.
- Connect the mains cable to the **AC~** socket of the Sound Bar and then into a mains socket.

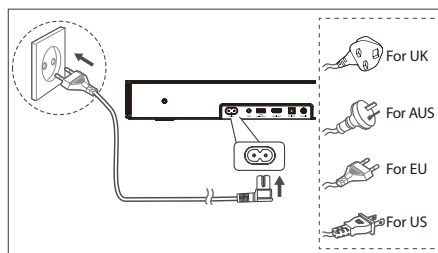

\* Power cord quantity and plug vary by regions.

## 5. Basic Operation

### 5.1 Standby/ON

When you first connect the main unit to the mains socket, the main unit will be in Standby mode.

- Press the **⏻** button on the unit or on the remote control to switch the unit ON.
- Press the **⏻** button again to switch the unit back to STANDBY mode.
- Disconnect the mains plug from the mains socket if you want to switch the unit OFF completely.



## 5.2 Auto-Standby / Auto-Wake

**[Auto-Standby]** The soundbar automatically turns to Standby mode after about 15 minutes if the TV or the external soundbar is disconnected (or USB, BT function bit playback pause), or switched off.

**[Auto-Wake]** If a TV or an external device is connected (AUX / OPTICAL / HDMI ARC socket), the unit will switch on automatically when the TV or the external device is switched on.

### Auto-standby ON/OFF

Switch the soundbar on the optical mode, double click the **I◀◀** (x2) and **▶▶** (x2) buttons on the remote control to activate and deactivate the auto-standby:

Auto Standby	
<b>On</b>	Your Soundbar has been programmed to enter Standby mode automatically when no audio is detected for <b>15</b> minutes. LED State: ●   Yellow blink quick for 3 times
<b>Off</b>	You can turn off the Auto Standby to keep your Soundbar always working. LED State: ●   Yellow blink slowly for 3 times

### Activate and Deactivate the Auto-Wake:

Turn on the soundbar, press the **[⏻] [+]** button at the same time on the soundbar to activate and deactivate the auto-wake:

Auto-Wake	
<b>On</b>	The Soundbar will wake up automatically when audio input is detected. LED State: ● ● ● ●   White   White   Green   Green
<b>Off</b>	The Soundbar does not wake up automatically. LED State: ● ● ● ●   White   White   Red   Red

## 5.3 Select Modes

- Press the **[S]** (SOURCE) button repeatedly on the unit or on the remote control to select the desired mode.
- The indicator light on the front of the main unit will show which mode is currently in use.

Lamp	Mode
● Red	Standby
● Green	AUX
● Blue	BT (Bluetooth)
● Orange	OPTICAL
● Light blue	COAXIAL
● White	HDMI ARC
● Yellow	USB

## 5.4 Adjust the Volume

- Press the **VOL+ / VOL-** buttons on the unit or on the remote control to adjust the volume.
- If you wish to turn the sound off, press the **[M]** (MUTE) button on the remote control. Press the **[M]** (MUTE) button again or press the **VOL +/-** buttons to resume normal listening.

## 5.5 Turn the Surround Sound ON/OFF

- Press the **SURR** button on the remote control to turn on the surround sound. Press this button again to turn off the surround sound.

## 5.6 Select Equalizer (EQ) Effect

- While playing, press the **EQ** button on the remote control to select desired preset equalizers: **music, movie, news, game, sport, night**.

## 5.7 Adjust the Bass/Treble

- Press the **BASS +/-** buttons on the remote control to adjust bass level.
- Press the **TREBLE +/-** buttons on the remote control to adjust treble level.

## 5.8 Adjust the Brightness

- Press the **DIMMER +/-** button on the remote control to select brightness level.

## 5.9 Voice prompts ON/OFF

- In Standby mode, press and hold the **[⏻]** and **[VOL+]** button on the soundbar to enable or disable voice prompts.

Status	LED State
<b>Notice OFF</b>	● ● ● ● ● ● ● ● (Solidly red and white LEDs flash 3 times)
<b>Notice ON</b>	● ● ● ● ● ● ● ● (Solidly green and white LEDs flash 3 times)

## 5.10 Factory reset

Reset device to default setting.

- Switch the soundbar on the optical mode, press and hold the **[⏻]** button on the soundbar, the soundbar will enter factory reset mode and turn to standby state.

MODE	DEFAULT
SOURCE	OPTICAL
Volume	30
Surround	ON
Dimmer	MAX
Bass	0
Treble	0
EQ	Music
Auto Wake	OFF
Auto Standby	ON

## 6. AUX/ OPTICAL/COAXIAL/ HDMI ARC Operation

- 1 Ensure that the unit is connected to the TV or audio device.
- 2 Press the  button repeatedly on the unit or on the remote control to select **AUX, OPTICAL, COAXIAL, HDMI ARC** mode.
- 3 Operate your audio device directly for playback features.
- 4 Press the **VOL +/-** button to adjust the volume to your desired level.



**Tip:** The Soundbar may not be able to decode all digital audio formats from the input source. In this case, the Soundbar will mute. This is NOT a defect. Ensure that the audio setting of the input source (e.g. TV, game console, DVD player, etc.) is set to **PCM** or **Dolby Digital** (Refer to the user manual of the input source device for its audio setting details) with **HDMI ARC / OPTICAL/ COAXIAL** input.

## 7. USB Operation

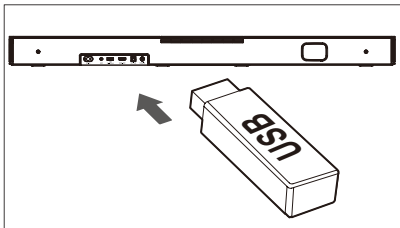
- 1 Insert the USB device.



- 2 Press the  button repeatedly on the unit or on the remote control to select **USB** mode.
- 3 During playback:

	Start, pause or resume play
	Skip to the previous or next track



### Tips:

- The unit can support USB devices with up to 32 GB of memory.
- This unit can play WAV / WMA / MP3 / FLAC.
- This product may not be compatible with certain types of USB storage devices.
- If you use a USB extension cable, USB hub, or USB Multifunctional card reader, the USB storage device may not be recognized.
- Do not remove the USB storage device while reading files.

## 8. Bluetooth Operation

Through Bluetooth, connect the Soundbar with your Bluetooth device (such as an iPad, iPhone, iPod touch, Android phone, or laptop), and then you can listen to the audio files stored on the device through your Soundbar speakers.

### First time pairing

- 1 Press the  (SOURCE) button on the unit or the  button on the remote control to select **Bluetooth** mode. The Blue indicator will flash slowly and the white running horse lamp rolling.
  - 2 Activate your Bluetooth device and select the search mode.
  - 3 Select **"Hisense HS2000"** in the pairing list. After audio prompt, the system is successfully connected and Blue indicator will light up solidly.
- If you want to connect your soundbar with another Bluetooth device, press and hold the  button on the remote control to disconnect the currently connected Bluetooth device. Follow step 2-3 to pair your Bluetooth device.

### To disconnect the Bluetooth function, you can :

- Switch to another function on the unit.
- Disable the function from your Bluetooth device.
- Press and hold the  button, the Bluetooth device will be disconnected from the soundbar.

## Listen to music from Bluetooth Device

- If the connected Bluetooth device supports Advanced Audio Distribution Profile (A2DP), you can listen to the music stored on the device through the player.
  - If the device also supports Audio Video Remote Control Profile (AVRCP), you can use the player's remote control to play music stored on the device.
1. Pair your device with the player.
  2. Play music via your device (if it supports A2DP).
  3. Use supplied remote control to control play (if it supports AVRCP).

---

 Start, pause or resume play

---

 Skip to the previous or next track

---

### Tips:

- The operational range between the Sound Bar and the device is approximately 8 metres.
- Before connecting a Bluetooth® device to the Sound Bar, ensure you know the device's capabilities.
- Compatibility with all Bluetooth® devices is not guaranteed.
- Any obstacle between the device and the Sound Bar can reduce operational range.
- Keep this player away from other electronic devices that may cause interference.
- The player will also be disconnected when your device is moved beyond the operational range.

## 9. Troubleshooting

To keep the warranty valid, never try to repair the system yourself. If you encounter problems when using this unit, check the following points before requesting service.



### No power

- Ensure that the AC cord of the apparatus is properly connected.
- Ensure that there is power at the AC outlet.
- Press standby button to turn the unit on.

## Remote control does not work

- Before you press any playback control button, first select the correct source.
- Reduce the distance between the remote control and the unit.
- Insert the battery with its polarities (+/-) aligned as indicated.
- Replace the battery.
- Aim the remote control directly at the sensor on the front of the unit.

## No sound

- Make sure that the unit is not muted. Press  or VOL+/- button to resume normal listening.
- Press  button on the unit or on the remote control to switch the soundbar to standby mode. Then press the  button again to switch the soundbar on.
- Ensure the audio setting of the input source (e.g. TV, game console, DVD player, etc.) is set to PCM or Dolby Digital mode while using digital (e.g. HDMI, OPTICAL, COAXIAL) connection.
- The unit may not be able to decode all digital audio formats from the input source. In this case, the unit will mute. This is NOT a defect. device is not muted.

## I can't find the Bluetooth name of this unit on my Bluetooth device for Bluetooth pairing

- Ensure the Bluetooth function is activated on your Bluetooth device.
- Ensure you have paired the unit with your Bluetooth device.

## The Soundbar turns off

- When the unit's external input signal level is too low, the unit will be turned off automatically in 15 minutes. Please increase the volume level of your external device.

## 10.Specifications

Brand	Hisense
Model	HS2000

### Soundbar

Power Supply	100-240V~ 50/60Hz
Power Consumption	<b>50 W</b> < 0.5 W (StandBy)
USB	5V --- 500mA Hi-Speed USB (2.0) / FAT32 / FAT16 32G (max) , WAV / WMA / MP3 / FLAC.
Dimension (WxHxD)	800 x 60 x <b>105 mm / 31.5" x 2.4" x 4.1"</b>
Net weight	<b>2.22 kg</b>
Audio input sensitivity	700mV
Frequency Response	40Hz - 20KHz
Operating Temperature	0°C - 45°C

### Wireless Specification (EU)

Bluetooth version / profiles	V 5.3 (A2DP, AVRCP)
Bluetooth frequency range	2400 MHz ~ 2483.5 MHz
Bluetooth Max. transmitting power	≤ 5 dBm

### Amplifier (max audio power)

Total	240 W
Soundbar	60 W x 2 + 120 W (built-in Subwoofer)

### Remote Control

Distance/Angle	19.7 feet (6m) / 30°
Battery type	AAA (1.5V x 2)

- Design and specifications are subject to change without notice.

# Trademarks

---



The Bluetooth® word mark and logos are registered trademarks owned by Bluetooth SIG, Inc. and any use of such marks by Hisense is under license. Other trademarks and trade names are those of their respective owners.



The terms HDMI, HDMI High-Definition Multimedia Interface, HDMI trade dress and the HDMI Logos are trademarks or registered trademarks of HDMI Licensing Administrator, Inc.



Manufactured under license from Dolby Laboratories. Dolby, Dolby Audio, and the double-D symbol are trademarks of Dolby Laboratories.



For DTS patents, see <http://patents.dts.com>. Manufactured under license from DTS, Inc. (for companies headquartered in the U.S./Japan/Taiwan) or under license from DTS Licensing Limited (for all other companies). DTS, Digital Surround, Virtual:X, and the DTS logo are registered trademarks or trademarks of DTS, Inc. in the United States and other countries. © 2021 DTS, Inc. ALL RIGHTS RESERVED.



- EN** Roku, the Roku logo, Roku TV, Roku TV Ready, and the Roku TV Ready logo are trademarks and/or registered trademarks of Roku, Inc. This product is Roku TV Ready-supported in the United States, Canada, United Kingdom and Mexico. Countries are subject to change. For the most current list of countries in which this product is Roku TV Ready-supported, please email [rokutvready@roku.com](mailto:rokutvready@roku.com).
- FR** Roku, le logo Roku, Roku TV, Roku TV Ready et le logo Roku TV Ready sont des marques de commerce et/ou des marques déposées de Roku Inc. Ce produit est certifié Roku TV Ready au/en états-Unis, Canada, Royaume-Uni, et Mexique. La liste de pays peut varier. Pour obtenir la liste la plus récente des pays dans lesquels ce produit est pris en charge par Roku TV Ready, veuillez envoyer un courriel à [rokutvready@roku.com](mailto:rokutvready@roku.com).
- ES** Roku, el logotipo de Roku, Roku TV, Roku TV Ready y el logotipo de Roku TV Ready son marcas comerciales o marcas comerciales registradas de Roku, Inc. Este producto es compatible con Roku TV Ready en Estados Unidos, Canadá, reino unido, y México. Los países están sujetos a cambios. Para obtener la lista más actualizada de países en los que este producto es compatible con Roku TV, envía un correo electrónico a [rokutvready@roku.com](mailto:rokutvready@roku.com).



**WARNING:** This product can expose you to chemicals including lead, which is known to the State of California to cause cancer and birth defects or other reproductive harm. For more information go to [www.P65Warnings.ca.gov](http://www.P65Warnings.ca.gov).



FR

EN

## FCC INFORMATION (for US customers)

### NOTE:

- This equipment has been tested and found to comply with the limits for a Class B digital device, pursuant to Part 15 of the FCC Rules. These limits are designed to provide reasonable protection against harmful interference in a residential installation. This equipment generates, uses and can radiate radio frequency energy and, if not installed and used in accordance with the instructions, may cause harmful interference to radio communications.
- However, there is no guarantee that interference will not occur in a particular installation. If this equipment does cause harmful interference to radio or television reception, which can be determined by turning the equipment off and on, the user is encouraged to try to correct the interference by one or more of the following measures:
  - Reorient or relocate the receiving antenna.
  - Increase the separation between the equipment and receiver.
  - Connect the equipment into an outlet on a circuit different from that to which the receiver is connected.
  - Consult the dealer or an experienced radio / TV technician for help.

This device complies with Part 15 of the FCC Rules. Operation is subject to the following two conditions:

- (1) this device may not cause harmful interference, and
  - (2) this device must accept any interference received, including interference that may cause undesired operation.
- Shielded cables must be used with this unit to ensure compliance with the Class B FCC limits.

### IC Notice: CAN ICES-3(B)/NMB-3(B)

This device contains licence-exempt transmitter(s)/receiver(s) that comply with Innovation, Science and Economic Development Canada's licence-exempt RSS(s). Operation is subject to the following two conditions:

1. This device may not cause interference.
2. This device must accept any interference, including interference that may cause undesired operation of the device.

### Warning:

- This equipment should be installed and operated with minimum distance 20cm between the radiator & your body.
- Changes or modifications to this unit not expressly approved by the party responsible for compliance could void the user's authority to operate the equipment."

## Règlement de la FCC (pour les clients américains)

### REMARQUE :

- Ce dispositif a été testé et déclaré conforme aux limites d'un dispositif numérique de classe B, conformément à la partie 15 des règles de la FCC.  
Ces limites ont pour but d'assurer une protection raisonnable contre le brouillage nuisible dans une installation résidentielle. Cet équipement produit, utilise et peut émettre de l'énergie en radio fréquence et, s'il n'est pas installé et utilisé conformément aux directives, il peut causer un brouillage nuisible dans les communications radio.
- Cependant, il n'est pas garanti que des interférences ne se produiront pas dans une installation particulière. Si cet appareil provoque des interférences nuisibles à la réception radio ou de télévision, ce qui peut être déterminé en mettant l'appareil hors tension, l'utilisateur est encouragé à essayer de corriger l'interférence par une ou plusieurs des mesures suivantes :
  - Réorienter ou déplacer l'antenne de réception.
  - Augmenter la distance entre l'appareil et le récepteur.
  - Brancher l'appareil à une prise sur un circuit différent de celui sur lequel le récepteur est branché.
  - Consulter le revendeur ou un technicien radio/TV expérimenté.

Cet appareil est conforme à la partie 15 des règles de la FCC. Son fonctionnement est soumis aux deux conditions suivantes :

- (1) ce dispositif ne peut pas causer d'interférences nuisibles et
  - (2) cet appareil doit accepter toute interférence reçue, y compris les interférences qui peuvent causer un mauvais fonctionnement.
- Des câbles blindés doivent être utilisés avec cet appareil pour assurer la conformité avec les limites de la classe B de la FCC. fonctionnement de l'appareil.

### Avis d'Industrie Canada: CAN ICES-3(B)/NMB-3(B)

L'émetteur/récepteur exempt de licence contenu dans le présent appareil est conforme aux CNR d'Innovation, Sciences et Développement économique Canada applicables aux appareils radio exempts de licence. L'exploitation est autorisée aux deux conditions suivantes :

1. L'appareil ne doit pas produire de brouillage;
2. L'appareil doit accepter tout brouillage radioélectrique subi, même si le brouillage est susceptible d'en compromettre le fonctionnement.

### Avvertimento :

- Pour rester en conformité avec les consignes d'exposition aux RF, placez le produit à au moins 20 cm des personnes proches.
- Les changements ou modifications de cet appareil non expressément approuvées par la partie responsable de la conformité pourraient annuler l'autorisation de l'utilisateur à utiliser l'équipement.



Séparez les éléments avant de trier