

For more indepthinformation, go to our Web site  
[www.richsound.com](http://www.richsound.com)

# RSR<sup>®</sup>

## TB311HWW

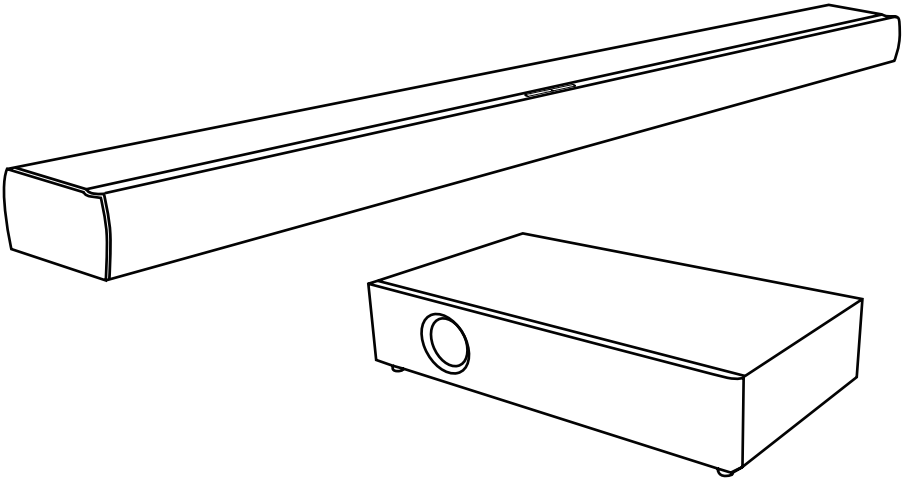

---

# USER MANUAL

---

# Contents

<b>Important Safety Instructions .....</b>	<b>3</b>
Safety.....	3
Warning .....	4
<b>Identifying the Parts .....</b>	<b>5</b>
Main Unit .....	5
Wireless Subwoofer .....	5
Remote Control .....	5
<b>Preparations .....</b>	<b>6</b>
Prepare the Remote Control .....	6
Replace the Remote Control Battery .....	6
<b>Connections .....</b>	<b>6</b>
Use the HDMI ARC socket.....	6
Use the OPTICAL Socket.....	7
Use the AUX Socket.....	7
Connect to Power .....	7
<b>Pairing the Wireless Subwoofer with the Main Unit.....</b>	<b>8</b>
Automatic pairing.....	8
Manual pairing.....	8
<b>Basic Operation .....</b>	<b>8</b>
Standby/ON .....	8
Select Modes .....	9
Adjust the Volume.....	9
Select Equaliser (EQ) Effect.....	9
<b>AUX / OPTICAL / HDMI ARC Operation.....</b>	<b>9</b>
<b>Bluetooth Operation.....</b>	<b>9</b>
Pair Bluetooth-enabled Devices.....	9
Listen to Music from Bluetooth Device .....	10
<b>Troubleshooting.....</b>	<b>11</b>
<b>Specifications .....</b>	<b>12</b>
<b>Standard Accessories .....</b>	<b>12</b>

# Important Safety Instructions

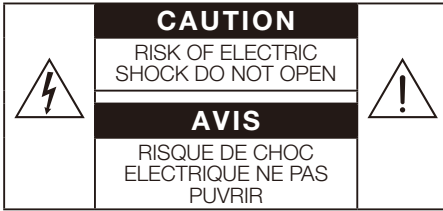

The lightning flash with arrowhead symbol, within an equilateral triangle, is intended to alert the user to the presence of uninsulated "dangerous voltage" within the product's enclosure that may be of sufficient magnitude as to constitute a risk of electric shock to persons.



The exclamation point within an equilateral triangle is intended to alert the user to the presence of important operating and maintenance (servicing) instructions in the literature accompanying the appliance.

## Safety

- 1 Read these instructions** – All the safety and operating instructions should be read before this product is operated.
- 2 Keep these instructions** – The safety and operating instructions should be retained for future reference.
- 3 Heed all warnings** – All warnings on the appliance and in the operating instructions should be adhered to.
- 4 Follow all instructions** – All operating and usage instructions should be followed.
- 5 Do not use this apparatus near water** – The appliance should not be used near water or moisture – for example, in a wet basement or near a swimming pool and the like.
- 6 Clean only with a dry cloth.**
- 7 Do not block any ventilation openings.** Install in accordance with the manufacturer's instructions.
- 8 Do not install near any heat sources** such as radiators, heaters, stoves, or other apparatus (including amplifiers) that produce heat.
- 9 Do not defeat the safety purpose of the polarized or grounding plug.** A polarized plug has two blades with one wider than the other. A grounding plug has two blades and a third grounding prong. The wide blade or the third prong is provided for your safety. If the provided plug does not fit into your outlet, consult an electrician for replacement of the obsolete outlet.
- 10 Protect the power cord from being walked on or pinched particularly at plugs, convenience receptacles, and the point where they exit from the apparatus.**
- 11 Only use attachments/accessories specified by the manufacturer.**
- 12**  Use only with the cart, stand, tripod, bracket or table specified by the manufacturer, or sold with the apparatus. When a cart or rack is used, use caution when moving the cart/apparatus combination to avoid injury from tip-over.
- 13 Unplug the apparatus during lightning storms or when unused for long periods of time.**
- 14 Refer all servicing to qualified personnel.** Servicing is required when the apparatus has been damaged in any way, such as power supply cord or plug is damaged, liquid has been spilled or objects have fallen into the apparatus, the unit has been exposed to rain or moisture, does not operate normally, or has been dropped.
- 15**  This equipment is a Class II or double insulated electrical appliance. It has been designed in such a way that it does not require a safety connection to electrical earth.
- 16 The apparatus shall not be exposed to dripping or splashing.** No objects filled with liquids, such as vases, shall be placed on the apparatus.
- 17 Minimum distance around the apparatus for sufficient ventilation is 5cm.**
- 18 The ventilation should not be impeded** by covering the ventilation openings with items, such as newspapers, table-cloths, curtains, etc...
- 19 No naked flame sources, such as lighted candles, should be placed on the apparatus.**
- 20 Batteries should be recycled or disposed of as per state and local guidelines.**
- 21 The use of apparatus in moderate climates.**

• **Caution:**

- Use of controls or adjustments or performance of procedures other than those described herein, may result in hazardous radiation exposure or other unsafe operation.
- To reduce the risk of fire or electric shock, do not expose this apparatus to rain or moisture. The apparatus must not be exposed to dripping or splashing and objects filled with liquids, such as vases, must not be placed on apparatus.
- The mains plug/appliance coupler is used as the disconnect device, the disconnect device must remain readily operable.
- Danger of explosion if battery is incorrectly replaced. Replace only with the same or equivalent type.

**Warning**

- The battery (batteries or battery pack) shall not be exposed to excessive heat such as sunshine, fire or the like.
- Before operating this system, check the voltage of this system to see if it is identical to the voltage of your local power supply.
- Do not place this unit close to strong magnetic fields.
- Do not place this unit on the amplifier or receiver.
- Do not place this unit close to damp areas as the moisture will affect the life of the laser head.
- If any solid object or liquid falls into the system, unplug the system and have it checked by qualified personnel before operating it any further.
- Do not attempt to clean the unit with chemical solvents as this may damage the finish. Use a clean, dry or slightly damp cloth.
- When removing the power plug from the wall outlet, always pull directly on the plug, never yank on the cord.
- Changes or modifications to this unit not expressly approved by the party responsible for compliance will void the user's authority to operate the equipment.
- The rating label is pasted on the bottom or back of the equipment.

**⚠ DO NOT INGEST BATTERY, CHEMICAL BURN HAZARD**

The remote control supplied with this product contains a coin/button cell battery. If the coin/button cell battery is swallowed, it can cause severe internal burns in just 2 hours and lead to death. Keep new and used batteries away from children. If the battery compartment does not close securely, stop using the product and keep it away from children. If you think batteries might have been swallowed or placed inside any part of the body, seek immediate medical attention.



Correct Disposal of this product. This marking indicates that this product should not be disposed with other household wastes throughout the EU. To prevent possible harm to the environment or human health from uncontrolled waste disposal, recycle it responsibly to promote the sustainable reuse of material resources. To return your used device, please use the return and collection systems or contact the retailer where the product was purchased. They can take this product for environmental safe recycling.



The Bluetooth word mark and logos are registered trademarks owned by Bluetooth SIG, Inc.



The terms HDMI and HDMI High-Definition Multimedia Interface, and the HDMI Logo are trademarks or registered trademarks of HDMI Licensing, LLC in the United States and other countries.

## **FCC INFORMATION** (for US customers)

### **Warning:**

- This equipment should be installed and operated with minimum distance 20cm between the radiator & your body.
- Changes or modifications to this unit not expressly approved by the party responsible for compliance could void the user's authority to operate the equipment. "

**NOTE:** This equipment has been tested and found to comply with the limits for a Class B digital device, pursuant to Part 15 of the FCC Rules. These limits are designed to provide reasonable protection against harmful interference in a residential installation. This equipment generates, uses and can radiate radio frequency energy and, if not installed and used in accordance with the instructions, may cause harmful interference to radio communications.

However, there is no guarantee that interference will not occur in a particular installation. If this equipment does cause harmful interference to radio or television reception, which can be determined by turning the equipment off and on, the user is encouraged to try to correct the interference by one or more of the following measures:

- Reorient or relocate the receiving antenna.
- Increase the separation between the equipment and receiver.
- Connect the equipment into an outlet on a circuit different from that to which the receiver is connected.
- Consult the dealer or an experienced radio / TV technician for help.

This device complies with Part 15 of the FCC Rules. Operation is subject to the following two conditions:

- (1) this device may not cause harmful interference, and
- (2) this device must accept any interference received, including interference that may cause undesired operation.

# Identifying the Parts

## Main Unit



### 1 Remote Control Sensor

### 2 LED Indicators

- Red indicator: In STANDBY mode.
- Green indicator: In AUX mode.
- Yellow indicator: In Optical mode.
- Blue indicator: In Bluetooth mode.
- White indicator: In HDMI ARC mode.

### 3 button

Switch the unit between ON and STANDBY mode.

### 4 SOURCE button

Select the play function.

### 5 VOL+/VOL- buttons

Increase/decrease the volume level.

### 6 AC~ Socket

Connect power cord.

### 7 OPTICAL Socket

### 8 AUX Socket

### 9 SERVICE ONLY Socket

The USB socket is for service only.

### 10 HDMI ARC Socket

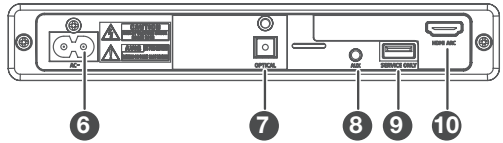
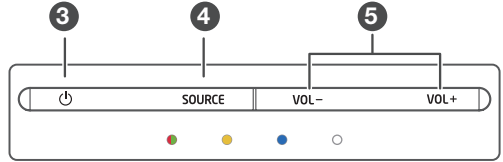

## Wireless Subwoofer

### 1 AC~ Socket

### 2 PAIR button

### 3 PAIR Indicator

Light up solidly when the pairing succeed.

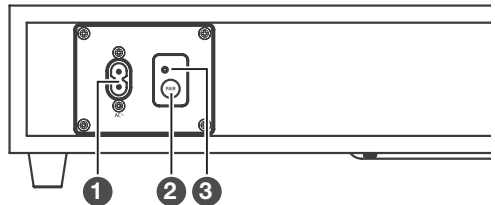

## Remote Control

### 1

Switch the unit between ON and STANDBY mode.

### 2 MUTE

Mute or resume the sound.

### 3 Function buttons

Select the play function.

### 4 VOL+/VOL-

Increase/decrease the volume level.

### 5 /

Skip to previous/next track in Bluetooth mode.

### 6 / PAIR

Play/pause/resume playback in Bluetooth mode.

### 7 EQ buttons

Press and hold to activate the pairing function in Bluetooth mode or disconnect the existing paired Bluetooth device.

Select a preset sound effect.

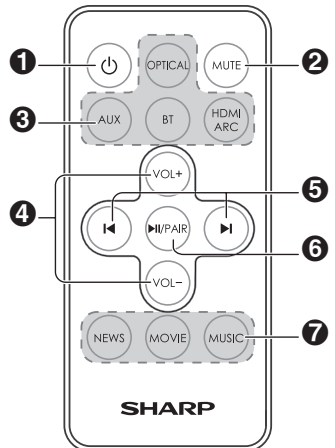

## Preparations

### Prepare the Remote Control

The provided Remote Control allows the unit to be operated from a distance.

- Even if the Remote Control is operated within the effective range (6m), remote control operation may be impossible if there are any obstacles between the unit and the remote control.
- If the Remote Control is operated near other products which generate infrared rays, or if other remote control devices using infra-red rays are used near the unit, it may operate incorrectly. Conversely, the other products may operate incorrectly.

- **First-time use:**

The unit has a pre-installed lithium CR2025 battery. Remove the protective tab to activate the remote control battery.

### Replace the Remote Control Battery

- 1 Pull out the battery tray and remove the old battery.
- 2 Place a new CR2025 battery into the battery tray with correct polarity (+/-) as indicated.
- 3 Insert the battery tray back into the slot.

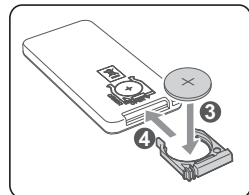
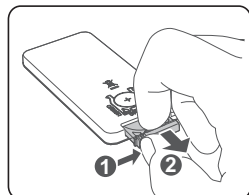
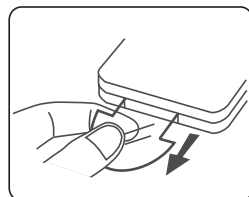

### Precautions Concerning Batteries

- When the Remote Control is not to be used for a long time (more than a month), remove the battery from the Remote Control to prevent it from leaking.
- If the batteries leak, wipe away the leakage inside the battery compartment and replace the batteries with new ones.
- Do not use any batteries other than those specified.
- Do not heat or disassemble batteries. Never throw them in fire or water.
- Do not carry or store batteries with other metallic objects. Doing so could cause batteries to short circuit, leak or explode.
- Never recharge a battery unless it is confirmed to be a rechargeable type.

## Connections

### Use the HDMI ARC socket

The ARC (Audio Return Channel) function allows you to send audio from your ARC-compliant TV to your sound bar through a single HDMI connection. To enjoy the ARC function, please ensure your TV is both HDMI-CEC and ARC compliant and set up accordingly. When correctly set up, you can use your TV remote control to adjust the volume output (VOL +/- and MUTE) of the sound bar.

- Connect the HDMI cable (not included) from unit's **HDMI (ARC)** socket to the HDMI (ARC) socket on your ARC compliant TV. Then press the remote control to select **HDMI ARC**.

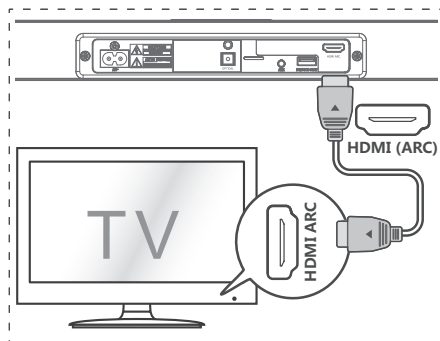

### Tips:

- Your TV must support the HDMI-CEC and ARC function. HDMI-CEC and ARC must be set to On.
- The setting method of HDMI-CEC and ARC may differ depending on the TV. For details about ARC function, please refer to your TV owner's manual.
- Only HDMI 1.4 cables can support the ARC function.

## Use the OPTICAL Socket

- Remove the protective cap of the OPTICAL socket, then connect an OPTICAL cable (not included) to the TV's OPTICAL OUT socket and the OPTICAL socket on the unit.
- **Tip:** While in **HDMI ARC/OPTICAL** mode, if there's no sound output from the unit and the **HDMI ARC/OPTICAL** lights flashes quickly, you may need to activate **PCM** signal output on your source device (eg. TV, DVD or Blu-ray player).

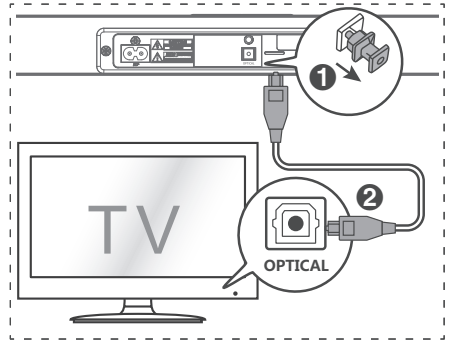

## Use the AUX Socket

- A. Use a RCA to 3.5mm audio cable (not included) to connect the TV's audio output sockets to the **AUX 1** socket on the unit.
- B. Use a 3.5mm to 3.5mm audio cable (not included) to connect the TV's or external audio device headphone socket to the **AUX 1** socket on the unit.

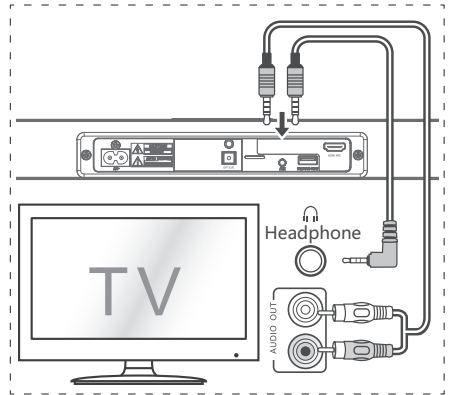

## Connect to Power

### Risk of product damage!

- Before connecting the AC power cord, ensure you have completed all other connections.
- Ensure that the power supply voltage corresponds to the voltage printed on the back or the underside of the unit.

### Soundbar

- Connect the mains cable to the **AC~** Socket of the unit and then into a mains socket.

### Subwoofer

- Connect the mains cable to the **AC~** Socket of the subwoofer and then into a mains socket.

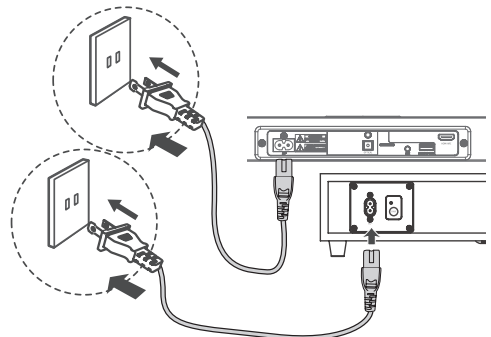



# Pairing the Wireless Subwoofer with the Main Unit

## Automatic pairing

The subwoofer and soundbar will automatically pair when both units are plugged into the mains sockets and turned on. No cable is needed for connecting the two units.

- When the subwoofer is pairing with the main unit, the Pair Indicator will flash fash.
- When the subwoofer is paired with the main unit, the Pair Indicator will light up.

### NOTE:

- Do not press the **Pair** button on the rear of the subwoofer, except for manual pairing.
- If the automatic pairing fails, pair the subwoofer with the main unit manually.

## Manual pairing

1. Ensure that all the cables are well connected and the main unit is in Standby mode.
2. Press and hold the **Pair** button on the rear of the subwoofer for a few seconds. The subwoofer will enter the pairing mode and the Pair Indicator will blink quickly.
3. Press the **⏻** button on the main unit or on the remote control to switch the main unit on.
4. After the wireless connection succeeded, the Pair Indicator will light up.
5. If the **Pair** indicator blinks, the wireless connection has failed. Unplug the cable of the subwoofer and then reconnect the main cable after 3 minutes. Repeat step 1 ~ 4.

### NOTE:

- If the wireless connection fails again, check if there is conflict or strong interference (for example, interference from an electronic device) around your location. Remove these conflicts or strong interferences and repeat the above procedures.
- The subwoofer should be within 6m of the soundbar in an open area.
- If a TV or an external device is connected, the main unit and the subwoofer will switch on automatically when the TV or the external device is switched on.
- If the main unit is not connected with the subwoofer and it is in On mode, the POWER Indicator will flash. Follow step 1 ~ 4 above to pair the subwoofer to the main unit.

# Basic Operation

## Standby/ON

When you first connect the main unit to the mains socket, the main unit will be in Standby mode.

- Press the **⏻** button on the unit or on the remote control to switch the unit ON.
- Press the **⏻** button again to switch the unit back to STANDBY mode. The POWER indicator will light up red.
- Disconnect the mains plug from the mains socket if you want to switch the unit OFF completely.
- When the unit has no input signal for over 15 minutes, it will automatically switch to Standby mode.

## Select Modes

Press the **SOURCE** button repeatedly on the unit or the **AUX, OPTICAL, HDMI ARC** and **BT** (Bluetooth) buttons on the remote control to select the desired mode.

- Red indicator: In STANDBY mode.
- Green indicator: In AUX mode.
- Yellow indicator: In Optical mode.
- Blue indicator: In Bluetooth mode.
- White indicator: In HDMI ARC mode.

## Adjust the Volume

- Press the **VOL+ / VOL-** buttons on the unit or on the remote control to adjust the volume.
- If you wish to turn the sound off, press the **MUTE** button on the remote control. Press the **MUTE** button again or press the **VOL+ / VOL-** buttons on the unit or on the remote control to resume normal listening.
- While adjusting the volume, the status indicator flashes quickly.
- While the volume level reaches its maximum level, if you press the **VOL+** button again, the status indicator flashes once. While the volume level reaches its minimum level, if you press the **VOL-** button again, the status indicator flashes once.

## Select Equaliser (EQ) Effect

- While playing, press the **EQ** button on the unit or the **NEWS, MOVIE** and **MUSIC** button on the remote control to select desired preset equalisers: **Movie** (recommended for viewing movies), **Music** (recommended for listening to music), **NEWS** (recommended for listening to NEWS).

## AUX / OPTICAL / HDMI ARC Operation

- 1 Ensure that the unit is connected to the TV or audio device.
- 2 While in ON mode, press the **SOURCE** button repeatedly on the unit or the **AUX, OPTICAL, HDMI ARC** buttons on the remote control to select the desired mode.
- 3 Operate your audio device directly for playback features.
- 4 Press the **VOL +/-** button to adjust the volume to your desired level.

### Tip:

- While in **HDMI ARC/OPTICAL** mode, if there's no sound output from the unit and the **HDMI ARC/ OPTICAL** lights flashes quickly, you may need to activate **PCM** signal output on your source device (eg. TV, DVD or Blu-ray player).

## Bluetooth Operation

You can listen to tracks from a media device if connected to the unit via Bluetooth.

## Pair Bluetooth-enabled Devices

The first time you connect your bluetooth device to this player, you need to pair your device to this player.

**Note:**

- The operational range between this player and a Bluetooth device is approximately 8 meters (without any object between the Bluetooth device and the unit).
  - Before you connect a Bluetooth device to this unit, ensure you know the device's capabilities.
  - Compatibility with all Bluetooth devices is not guaranteed.
  - Any obstacle between this unit and a Bluetooth device can reduce the operational range.
  - If the signal strength is weak, your Bluetooth receiver may disconnect, but it will re-enter pairing mode automatically.
- 1 While in ON mode, press the **SOURCE** button on the unit repeatedly or **BT** button on the remote control to select Bluetooth mode. The **Blue** indicator will light flash.
  - 2 Activate your Bluetooth device and select the search mode. "H6 %K K " will appear on your Bluetooth device list.
    - If you cannot find the unit, press and hold the "► II/PAIR" button on the remote control to be searchable. After the "Pairing" voice prompt and the Blue indicator will flash rapidly.
  - 3 Select "H6 %K K " in the pairing list. After the "Paired" voice prompt, the system is successfully connected and the Blue indicator will light up solidly.
  - 4 Begin playing music from the connected Bluetooth device.

**To disconnect the Bluetooth function, you can :**

- Switch to another function on the unit.
- Disable the Bluetooth function on your device. The device is successfully disconnected from the unit after the "Disconnected" voice prompt.
- Press and hold the "► II/PAIR" button on the remote control.

**Tips:**

- Enter "0000" for the password if necessary.
- If no other Bluetooth device pairs with this player within two minutes, the player will recover its previous connection.
- The player will also be disconnected when your device is moved beyond the operational range.
- If you want to reconnect your device to this player, place it within the operational range.
- If the device is moved beyond the operational range, when it is brought back, please check if the device is still connected to the player.
- If the connection is lost, follow the instructions above to pair your device to the player again.

**Listen to Music from Bluetooth Device**

- If the connected Bluetooth device supports Advanced Audio Distribution Profile (A2DP), you can listen to the music stored on the device through the player.
- If the device also supports Audio Video Remote Control Profile (AVRCP), you can use the player's remote control to play music stored on the device.
  1. Pair your device with the player.
  2. Play music via your device (if it supports A2DP).
  3. Use supplied remote control to control play (if it supports AVRCP).
    - To pause/resume play, press the ► II/PAIR button on the remote control.
    - To skip to a track, press the ◀/▶ buttons on the remote control.

# Troubleshooting

To keep the warranty valid, never try to repair the system yourself. If you encounter problems when using this unit, check the following points before requesting service.

- **No power**

- Ensure that the AC cord of the apparatus is properly connected.
- Ensure that there is power at the AC outlet.
- Press standby button to turn the unit on.

- **Remote control does not work**

- Before you press any playback control button, first select the correct source.
- Reduce the distance between the remote control and the unit.
- Insert the battery with its polarities (+/-) aligned as indicated.
- Replace the battery.
- Aim the remote control directly at the sensor on the front of the unit.

- **No response from the unit**

- Disconnect and reconnect the AC power plug, then turn the unit on again.

- **I can't find the Bluetooth name of this unit on my Bluetooth device**

Ensure the Bluetooth function is activated on your Bluetooth device.  
Re-pair the unit with your Bluetooth device.

- **This is a 15 mins power off function, one of the ERPII standard requirement for saving power**

When the unit's external input signal level is too low, the unit will be turned off automatically in 15 minutes. Please increase the volume level of your external device.

## Specifications

<b>Model Name</b>	HT-SBW160
<b>Soundbar</b>	
Bar Power Supply	AC 100-240V ~ 50/60Hz
Power Consumption	30W
USB (Service Only)	5V==500mA
Dimension (W x D x H)	900 x 86 x 45 mm
Audio input sensitivity	500mV
Frequency Response	120Hz - 20KHz
Impedance	8 Ω
<b>Bluetooth</b>	
Version	V 4.2
Maximum power transmitted	5 dbm
Frequency bands	2402 MHz ~ 2480 MHz
<b>Wireless Subwoofer</b>	
Bar Power Supply	AC 100-240V ~ 50/60Hz
Power Consumption	30W
Dimension (W x D x H)	465 x 255 x 94 mm
Frequency Response	40Hz - 120Hz
Impedance	4 Ω
Maximum power transmitted	6 dbm
Frequency bands	2400 MHz ~ 2483 MHz
<b>Power consumption of networked standby</b>	
Soundbar	0.43W
Wireless Subwoofer	0.34W
<b>Remote Control</b>	
Distance/Angle	6m / 30°
Battery type	CR 2025

## Standard Accessories

Remote Control .....	x 1
Instruction Manual .....	x 1
57 power cord .....	x 2

- Design and specifications are subject to change without notice.

