



RADIO TEST REPORT

FCC ID : Z8H89FT0085
Equipment : X7-35X Indoor Wi-Fi 7 2x2 Access Point
Brand Name : Cambium Networks
Model Name : X7-35X
Applicant : Cambium Networks Inc.
3800 Golf Road Suite 360 Rolling Meadows IL
United States 60008
Manufacturer : Cambium Networks Inc.
3800 Golf Road Suite 360 Rolling Meadows IL
United States 60008
Standard : 47 CFR FCC Part 15.247

The product was received on Nov. 24, 2023, and testing was started from Dec. 08, 2023 and completed on Feb. 27, 2024. We, Sporton International Inc. Hsinchu Laboratory, would like to declare that the tested sample has been evaluated in accordance with the procedures given in ANSI C63.10-2013 and shown compliance with the applicable technical standards.

The test results in this report apply exclusively to the tested model / sample. Without written approval of Sporton International Inc. Hsinchu Laboratory, the test report shall not be reproduced except in full.

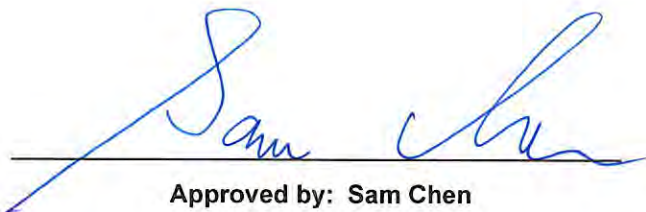

Approved by: Sam Chen

Sporton International Inc. Hsinchu Laboratory
No.8, Ln. 724, Bo'ai St., Zhubei City, Hsinchu County 302010, Taiwan (R.O.C.)



Table of Contents

History of this test report.....3

Summary of Test Result.....4

1 General Description5

1.1 Information.....5

1.2 Applicable Standards8

1.3 Testing Location Information8

1.4 Measurement Uncertainty9

2 Test Configuration of EUT10

2.1 Test Channel Mode10

2.2 The Worst Case Measurement Configuration11

2.3 EUT Operation during Test12

2.4 Accessories12

2.5 Support Equipment.....13

2.6 Test Setup Diagram14

3 Transmitter Test Result16

3.1 AC Power-line Conducted Emissions16

3.2 DTS Bandwidth.....18

3.3 Maximum Conducted Output Power19

3.4 Power Spectral Density22

3.5 Emissions in Non-restricted Frequency Bands24

3.6 Emissions in Restricted Frequency Bands.....25

4 Test Equipment and Calibration Data29

Appendix A. Test Results of AC Power-line Conducted Emissions

Appendix B. Test Results of DTS Bandwidth

Appendix C. Test Results of Maximum Conducted Output Power

Appendix D. Test Results of Power Spectral Density

Appendix E. Test Results of Emissions in Non-restricted Frequency Bands

Appendix F. Test Results of Emissions in Restricted Frequency Bands

Appendix G. Test Photos

Photographs of EUT v01



Summary of Test Result

Report Clause	Ref Std. Clause	Test Items	Result (PASS/FAIL)	Remark
1.1.2	15.203	Antenna Requirement	PASS	-
3.1	15.207	AC Power-line Conducted Emissions	PASS	-
3.2	15.247(a)	DTS Bandwidth	PASS	-
3.3	15.247(b)	Maximum Conducted Output Power	PASS	-
3.4	15.247(e)	Power Spectral Density	PASS	-
3.5	15.247(d)	Emissions in Non-restricted Frequency Bands	PASS	-
3.6	15.247(d)	Emissions in Restricted Frequency Bands	PASS	-

Conformity Assessment Condition:

1. The test results (PASS/FAIL) with all measurement uncertainty excluded are presented against the regulation limits or in accordance with the requirements stipulated by the applicant/matrix manufacturer who shall bear all the risks of non-compliance that may potentially occur if measurement uncertainty is taken into account.
2. The measurement uncertainty please refer to each test result in the chapter "Measurement Uncertainty".

Disclaimer:

The product specifications of the EUT presented in the test report that may affect the test assessments are declared by the manufacturer who shall take full responsibility for the authenticity.

Reviewed by: **Sam Chen**
Report Producer: **Cathy Chiu**



1 General Description

1.1 Information

1.1.1 RF General Information

Frequency Range (MHz)	Bluetooth Mode	Ch. Frequency (MHz)	Channel Number
2400-2483.5	LE	2402-2480	0-39 [40]

Band	Mode	BWch (MHz)	Nant
2.4-2.4835GHz	BT-LE(1Mbps)	1.0	1TX
2.4-2.4835GHz	BT-LE(2Mbps)	2.0	1TX

Note:

- ♦ Bluetooth LE uses a GFSK modulation.
- ♦ BWch is the nominal channel bandwidth.



1.1.2 Antenna Information

Ant.	Port			Brand	Model Name	Antenna Type	Connector	Gain (dBi)
	2.4GHz /5GHz	6GHz	Bluetooth/ Zigbee					
1	2	-	-	INPAQ	3010001479GD	PIFA Antenna	I-PEX	Note 1
2	1	-	-	INPAQ	3010001479GD	PIFA Antenna	I-PEX	
3	-	2	-	INPAQ	3010001479GD	PIFA Antenna	I-PEX	
4	-	1	-	INPAQ	3010001479GD	PIFA Antenna	I-PEX	
5	-	-	1	INPAQ	3010001479GD	Dipole Antenna	I-PEX	

Note 1:

Ant.	Port			WLAN 2.4GHz (dBi)	WLAN 5GHz (dBi)				WLAN 6GHz (dBi)				Bluetooth/ Zigbee (dBi)
	2.4GHz /5GHz	6GHz	Bluetooth/ Zigbee		UNII 1	UNII 2A	UNII 2C	UNII 3	UNII 5	UNII 6	UNII 7	UNII 8	
1	2	-	-	2.35	3.32	3.7	4.67	4.73	-	-	-	-	-
2	1	-	-	2.23	3.5	3.57	5.19	4.82	-	-	-	-	-
3	-	2	-	-	-	-	-	-	5.29	5.95	5.95	5.30	-
4	-	1	-	-	-	-	-	-	5.69	5.80	5.80	5.45	-
5	-	-	1	-	-	-	-	-	-	-	-	-	5.6

Directional Gain (dBi)											
WLAN 2.4GHz		WLAN 5GHz UNII 1		WLAN 5GHz UNII 2A		WLAN 5GHz UNII 2C		WLAN 5GHz UNII 3			
2T1S	2T2S	2T1S	2T2S	2T1S	2T2S	2T1S	2T2S	2T1S	2T2S	2T1S	2T2S
5.01	2.35	4.34	3.5	5.36	3.7	6.89	5.19	6.2	4.82		

Note 2: The above information (excepting WLAN 2.4GHz/5GHz gain) was declared by manufacturer.

Note 3: The WLAN 5GHz UNII2A~2C and WLAN 6GHz function of EUT was not enabled at this time.

<For 2.4GHz function>

For IEEE 802.11b/g/n/VHT/ax/be (2TX/2RX):

Port 1 and Port 2 can be used as transmitting/receiving antenna.

Port 1 and Port 2 could transmit/receive simultaneously.

<For 5GHz function>

For IEEE 802.11a/n/ac/ax/be (2TX/2RX):

Port 1 and Port 2 can be used as transmitting/receiving antenna.

Port 1 and Port 2 could transmit/receive simultaneously.

<For Bluetooth/Zigbee function> (1TX/1RX):

Only Port 1 can be used as transmitting/receiving antenna.

Port 1 could transmit/receive simultaneously.



1.1.3 Mode Test Duty Cycle

Mode	DC	DCF(dB)	T(s)	VBW(Hz) ≥ 1/T
BT-LE(1Mbps)	0.868	0.61	2.171m	1k
BT-LE(2Mbps)	0.591	2.28	1.114m	1k

Note:

- ♦ DC is Duty Cycle.
- ♦ DCF is Duty Cycle Factor.

1.1.4 EUT Operational Condition

EUT Power Type	From PoE			
Function	<input checked="" type="checkbox"/> Point-to-multipoint	<input checked="" type="checkbox"/> Point-to-point		
Test Software Version	QSPR V5.14.00227.1			
Support Mode	<input checked="" type="checkbox"/> LE 1M PHY: 1 Mb/s			
	<input type="checkbox"/> LE Coded PHY (S=2): 500 Kb/s			
	<input type="checkbox"/> LE Coded PHY (S=8): 125 Kb/s			
	<input checked="" type="checkbox"/> LE 2M PHY: 2 Mb/s			

Note: The above information was declared by manufacturer.

1.1.5 Table for EUT supports function

Function	Supports type
AP	Master
Mesh	Master
Slave	Slave without Radar detection

Note1: For above table list, only AP mode was tested and recorded in this test.

Note2: The above information was declared by manufacturer.



1.2 Applicable Standards

According to the specifications of the manufacturer, the EUT must comply with the requirements of the following standards:

- ◆ 47 CFR FCC Part 15.247
- ◆ ANSI C63.10-2013

The following reference test guidance is not within the scope of accreditation of TAF.

- ◆ FCC KDB 558074 D01 v05r02
- ◆ FCC KDB 414788 D01 v01r01

1.3 Testing Location Information

Testing Location Information	
Test Lab. : Sporton International Inc. Hsinchu Laboratory	
Hsinchu (TAF: 3787)	ADD: No.8, Ln. 724, Bo'ai St., Zhubei City, Hsinchu County 302010, Taiwan (R.O.C.) TEL: 886-3-656-9065 FAX: 886-3-656-9085 Test site Designation No. TW3787 with FCC. Conformity Assessment Body Identifier (CABID) TW3787 with ISED.

Test Condition	Test Site No.	Test Engineer	Test Environment (°C / %)	Test Date
RF Conducted	TH01-CB	KJ Chang	21.3~21.9 / 65~68	Dec. 27, 2023~ Dec. 30, 2023
Radiated (Below 1GHz)	03CH05-CB	Gordon Hung	21-22 / 56-59	Dec. 08, 2023~ Feb. 06, 2024
Radiated (Above 1GHz)	03CH06-CB	Gordon Hung	21.9-22.8 / 56-58	Dec. 08, 2023~ Feb. 06, 2024
AC Conduction	CO01-CB	Peter Wu	22~23 / 58~59	Feb. 27, 2024



1.4 Measurement Uncertainty

ISO/IEC 17025 requires that an estimate of the measurement uncertainties associated with the emissions test results be included in the report. The measurement uncertainties given below are based on a 95% confidence level (based on a coverage factor (k=2))

Test Items	Uncertainty	Remark
Conducted Emission (150kHz ~ 30MHz)	3.4 dB	Confidence levels of 95%
Radiated Emission (9kHz ~ 30MHz)	3.7 dB	Confidence levels of 95%
Radiated Emission (30MHz ~ 1,000MHz)	5.1 dB	Confidence levels of 95%
Radiated Emission (1GHz ~ 18GHz)	4.1 dB	Confidence levels of 95%
Radiated Emission (18GHz ~ 40GHz)	4.2 dB	Confidence levels of 95%
Conducted Emission	3.1 dB	Confidence levels of 95%
Output Power Measurement	0.8 dB	Confidence levels of 95%
Power Density Measurement	3.1 dB	Confidence levels of 95%
Bandwidth Measurement	2.2%	Confidence levels of 95%



2 Test Configuration of EUT

2.1 Test Channel Mode

Mode
BT-LE(1Mbps)
2402MHz
2440MHz
2478MHz
2480MHz
BT-LE(2Mbps)
2402MHz
2440MHz
2478MHz
2480MHz



2.2 The Worst Case Measurement Configuration

The Worst Case Mode for Following Conformance Tests	
Tests Item	AC power-line conducted emissions
Condition	AC power-line conducted measurement for line and neutral Test Voltage: 120Vac / 60Hz
Operating Mode	WLAN/Bluetooth (Normal Link), Zigbee (TX, RX)
1	EUT + Zigbee (TX) + PoE
2	EUT + Zigbee (RX) + PoE
3	EUT + Bluetooth + PoE
For operating mode 1 is the worst case and it was record in this test report.	

The Worst Case Mode for Following Conformance Tests	
Tests Item	DTS Bandwidth Maximum Conducted Output Power Power Spectral Density Emissions in Non-restricted Frequency Bands
Test Condition	Conducted measurement at transmit chains

The Worst Case Mode for Following Conformance Tests	
Tests Item	Emissions in Restricted Frequency Bands
Test Condition	Radiated measurement If EUT consist of multiple antenna assembly (multiple antenna are used in EUT regardless of spatial multiplexing MIMO configuration), the radiated test should be performed with highest antenna gain of each antenna type.
Operating Mode < 1GHz	CTX
The EUT was performed testing at X axis, Y axis and Z axis position for Radiated emission above 1GHz test, and the worst case was found below. Thus, the measurement will follow this same test configuration.	
1	EUT in Z axis + WLAN 2.4GHz + PoE
2	EUT in X axis + WLAN 5GHz + PoE
3	EUT in Y axis + Bluetooth + PoE
4	EUT in X axis + Zigbee + PoE
For operating mode 3 is the worst case and it was record in this test report.	
Operating Mode > 1GHz	CTX
After evaluating, and the worst case was found at Y axis, so it was selected to perform test and its test result was written in the report.	
1	EUT in Y axis



The Worst Case Mode for Following Conformance Tests	
Tests Item	Simultaneous Transmission Analysis - Co-location RF Exposure Evaluation
Operating Mode	CTX
1	Bluetooth + WLAN 2.4GHz + WLAN 5GHz
2	Zigbee + WLAN 2.4GHz + WLAN 5GHz

Refer to Sporton Test Report No.: FA3N2319 for Co-location RF Exposure Evaluation.

Note: The PoE below is for measurement only, would not be marketed.

The PoE information as below:

Support Unit	Brand Name	Model Number
PoE	Cambium Networks	P060U04

2.3 EUT Operation during Test

For CTX/CRX Mode:

The EUT was programmed to be in continuously transmitting/receiving mode.

For Normal Link:

During the test, the EUT operation to normal function.

2.4 Accessories

Accessories
Bracket type 1*1
Bracket type 2*1



2.5 Support Equipment

For AC Conduction:

Support Equipment				
No.	Equipment	Brand Name	Model Name	FCC ID
A	PoE	Cambium Networks	P060U04	N/A
B	Flash disk3.0	Transcend	JetFlash-700	N/A
C	LAN 2.5G NB	DELL	E6430	N/A
D	2.4G+5G Device	Cambium Networks	X7-35X	N/A
E	2.4G+5G Device NB	DELL	E6430	N/A
F	Zigbee Device	Cambium Networks	X7-35X	N/A
G	Zigbee PoE	H3C	N/A	N/A
H	Zigbee Device NB	DELL	E6430	N/A

For Radiated and RF Conducted:

Support Equipment				
No.	Equipment	Brand Name	Model Name	FCC ID
A	Notebook	DELL	E4300	N/A
B	PoE	Cambium Networks	P060U04	N/A

2.6 Test Setup Diagram

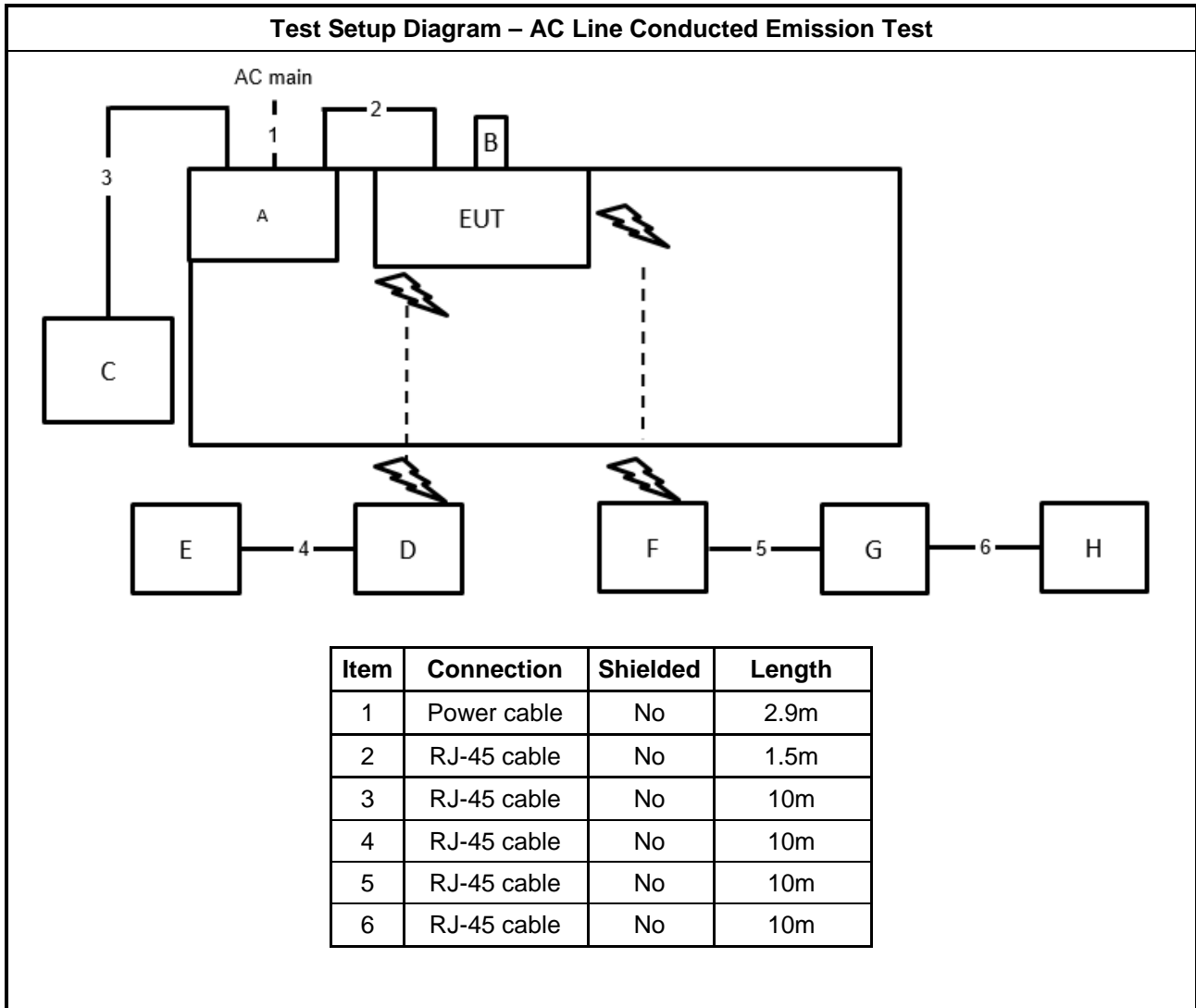



Test Setup Diagram - Radiated Test

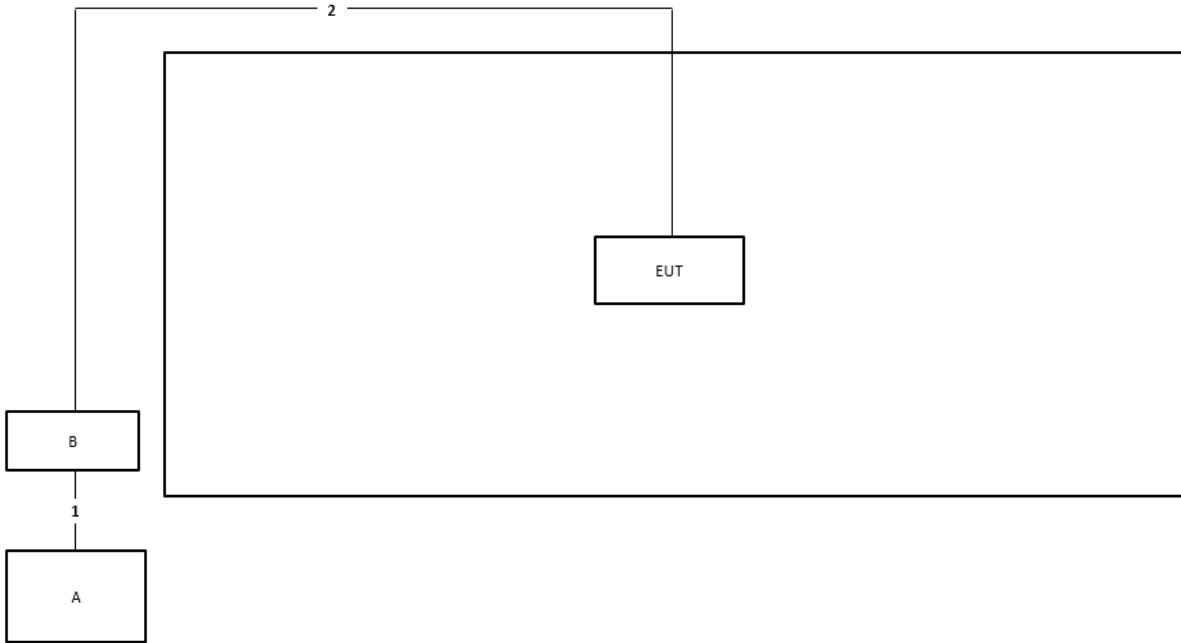

Item	Connection	Shielded	Length
1	RJ-45 cable	No	1m
2	RJ-45 cable	No	10m



3 Transmitter Test Result

3.1 AC Power-line Conducted Emissions

3.1.1 AC Power-line Conducted Emissions Limit

AC Power-line Conducted Emissions Limit		
Frequency Emission (MHz)	Quasi-Peak	Average
0.15-0.5	66 - 56 *	56 - 46 *
0.5-5	56	46
5-30	60	50

Note 1: * Decreases with the logarithm of the frequency.

3.1.2 Measuring Instruments

Refer a test equipment and calibration data table in this test report.

3.1.3 Test Procedures

Test Method
▪ Refer as ANSI C63.10-2013, clause 6.2 for AC power-line conducted emissions.

3.1.4 Test Setup

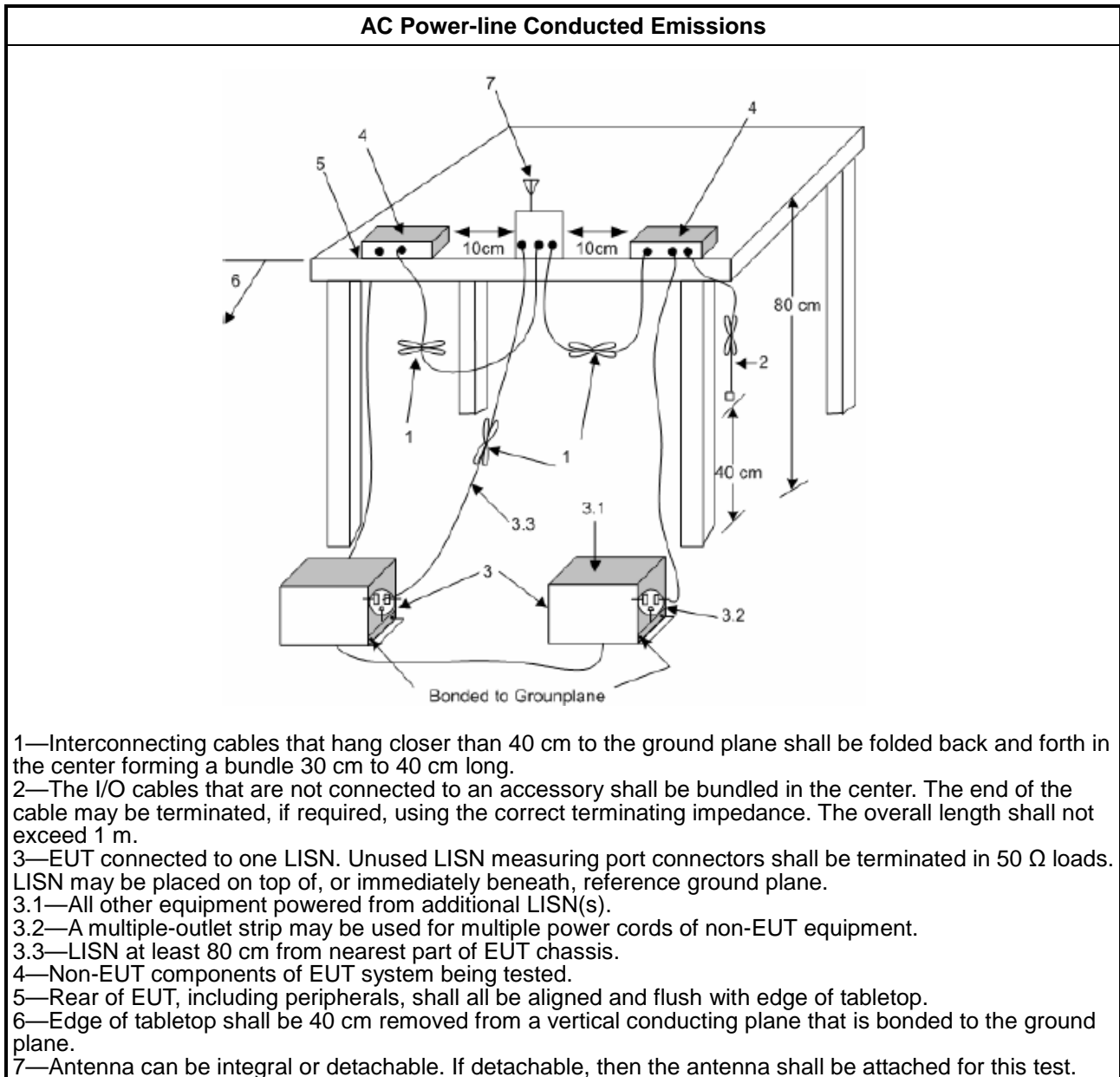

1.1.1. Measurement Results Calculation

The measured Level is calculated using:

- a. Corrected Reading: LISN Factor (LISN) + Attenuator (AT/AUX) + Cable Loss (CL) + Read Level (Raw) = Level
- b. Margin = -Limit + Level

3.1.5 Test Result of AC Power-line Conducted Emissions

Refer as Appendix A

3.2 DTS Bandwidth

3.2.1 6dB Bandwidth Limit

6dB Bandwidth Limit
Systems using digital modulation techniques:
<ul style="list-style-type: none"> ▪ 6 dB bandwidth \geq 500 kHz.

3.2.2 Measuring Instruments

Refer a test equipment and calibration data table in this test report.

3.2.3 Test Procedures

Test Method
<ul style="list-style-type: none"> ▪ For the emission bandwidth shall be measured using one of the options below:
<input checked="" type="checkbox"/> Refer as FCC KDB 558074, clause 8.2 & C63.10 clause 11.8.1 Option 1 for 6 dB bandwidth measurement.
<input type="checkbox"/> Refer as FCC KDB 558074, clause 8.2 & C63.10 clause 11.8.2 Option 2 for 6 dB bandwidth measurement.
<input type="checkbox"/> Refer as ANSI C63.10, clause 6.9.1 for occupied bandwidth testing.

3.2.4 Test Setup

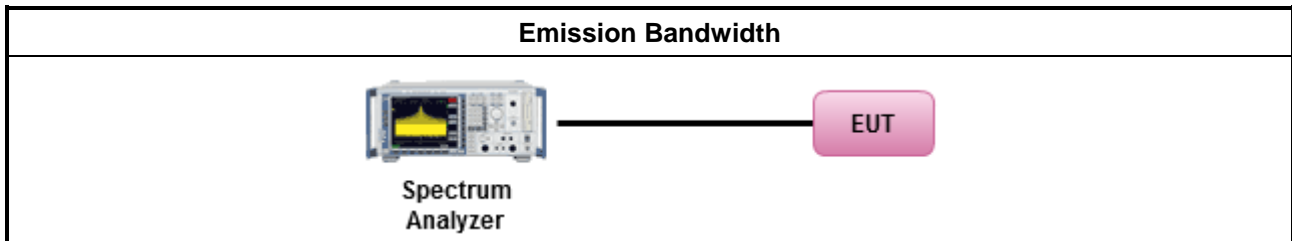

3.2.5 Test Result of Emission Bandwidth

Refer as Appendix B



3.3 Maximum Conducted Output Power

3.3.1 Maximum Conducted Output Power Limit

Maximum Conducted Output Power Limit	
	<ul style="list-style-type: none"> ▪ If $G_{TX} \leq 6$ dBi, then $P_{Out} \leq 30$ dBm (1 W)
	<ul style="list-style-type: none"> ▪ Point-to-multipoint systems (P2M): If $G_{TX} > 6$ dBi, then $P_{Out} = 30 - (G_{TX} - 6)$ dBm
	<ul style="list-style-type: none"> ▪ Point-to-point systems (P2P): If $G_{TX} > 6$ dBi, then $P_{Out} = 30 - (G_{TX} - 6)/3$ dBm
	<ul style="list-style-type: none"> ▪ Smart antenna system (SAS):
	<ul style="list-style-type: none"> - Single beam: If $G_{TX} > 6$ dBi, then $P_{Out} = 30 - (G_{TX} - 6)/3$ dBm
	<ul style="list-style-type: none"> - Overlap beam: If $G_{TX} > 6$ dBi, then $P_{Out} = 30 - (G_{TX} - 6)/3$ dBm
	<ul style="list-style-type: none"> - Aggregate power on all beams: If $G_{TX} > 6$ dBi, then $P_{Out} = 30 - (G_{TX} - 6)/3 + 8$ dB dBm
<p>P_{Out} = maximum peak conducted output power or maximum conducted output power in dBm, G_{TX} = the maximum transmitting antenna directional gain in dBi.</p>	

3.3.2 Measuring Instruments

Refer a test equipment and calibration data table in this test report.

3.3.3 Test Procedures

Test Method	
<ul style="list-style-type: none"> ▪ Maximum Peak Conducted Output Power 	
	<input type="checkbox"/> Refer as FCC KDB 558074, clause 8.3.1.1 & C63.10 clause 11.9.1.1 (RBW ≥ EBW method).
	<input type="checkbox"/> Refer as FCC KDB 558074, clause 8.3.1.3 & C63.10 clause 11.9.1.3 (peak power meter).
<ul style="list-style-type: none"> ▪ Maximum Conducted Output Power 	
[duty cycle ≥ 98% or external video / power trigger]	
	<input type="checkbox"/> Refer as FCC KDB 558074, clause 8.3.2.2 & C63.10 clause 11.9.2.2.2 Method AVGSA-1.
	<input type="checkbox"/> Refer as FCC KDB 558074, clause 8.3.2.2 & C63.10 clause 11.9.2.2.3 Method AVGSA-1A. (alternative)
duty cycle < 98% and average over on/off periods with duty factor	
	<input type="checkbox"/> Refer as FCC KDB 558074, clause 8.3.2.2 & C63.10 clause 11.9.2.2.4 Method AVGSA-2.
	<input type="checkbox"/> Refer as FCC KDB 558074, clause 8.3.2.2 & C63.10 clause 11.9.2.2.5 Method AVGSA-2A (alternative)
	<input type="checkbox"/> Refer as FCC KDB 558074, clause 8.3.2.2 & C63.10 clause 11.9.2.2.6 Method AVGSA-3
	<input type="checkbox"/> Refer as FCC KDB 558074, clause 8.3.2.2 & C63.10 clause 11.9.2.2.7 Method AVGSA-3A (alternative)
Measurement using a power meter (PM)	
	<input type="checkbox"/> Refer as FCC KDB 558074, clause 8.3.2.3 & C63.10 clause 11.9.2.3.1 Method AVGPM (using an RF average power meter).
	<input checked="" type="checkbox"/> Refer as FCC KDB 558074, clause 8.3.2.3 & C63.10 clause 11.9.2.3.2 Method AVGPM-G (using an gate RF average power meter).
<ul style="list-style-type: none"> ▪ For conducted measurement. 	
	<ul style="list-style-type: none"> ▪ If the EUT supports multiple transmit chains using options given below: Refer as FCC KDB 662911, In-band power measurements. Using the measure-and-sum approach, measured all transmit ports individually. Sum the power (in linear power units e.g., mW) of all ports for each individual sample and save them.
	<ul style="list-style-type: none"> ▪ If multiple transmit chains, EIRP calculation could be following as methods: $P_{total} = P_1 + P_2 + \dots + P_n$ (calculated in linear unit [mW] and transfer to log unit [dBm]) $EIRP_{total} = P_{total} + DG$

3.3.4 Test Setup

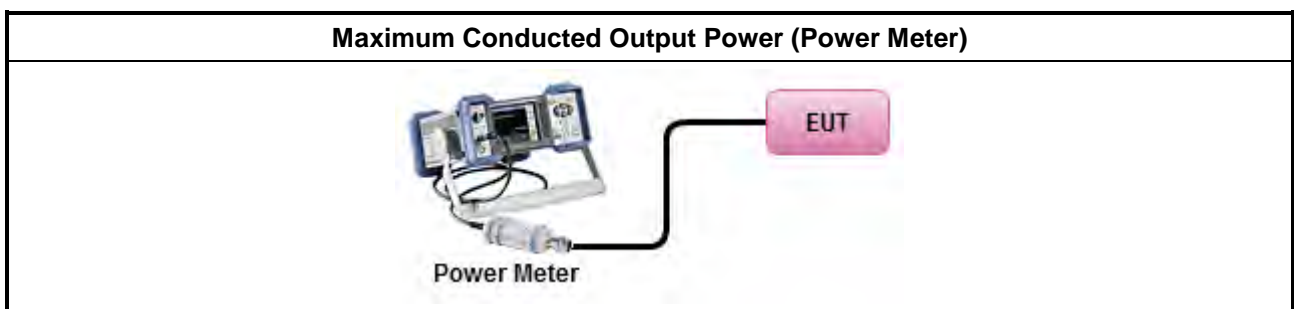



3.3.5 Test Result of Maximum Conducted Output Power

Refer as Appendix C



3.4 Power Spectral Density

3.4.1 Power Spectral Density Limit

Power Spectral Density Limit
<ul style="list-style-type: none"> Power Spectral Density (PSD) ≤ 8 dBm/3kHz

3.4.2 Measuring Instruments

Refer a test equipment and calibration data table in this test report.

3.4.3 Test Procedures

Test Method
<ul style="list-style-type: none"> Peak power spectral density procedures that the same method as used to determine the conducted output power. If maximum peak conducted output power was measured to demonstrate compliance to the output power limit, then the peak PSD procedure below (Method PKPSD) shall be used. If maximum conducted output power was measured to demonstrate compliance to the output power limit, then one of the average PSD procedures shall be used, as applicable based on the following criteria (the peak PSD procedure is also an acceptable option).
<input checked="" type="checkbox"/> Refer as FCC KDB 558074, clause 8.4 & C63.10 clause 11.10 Method Max. PSD. [duty cycle ≥ 98% or external video / power trigger]
<ul style="list-style-type: none"> For conducted measurement.
<ul style="list-style-type: none"> If The EUT supports multiple transmit chains using options given below: <ul style="list-style-type: none"> <input type="checkbox"/> Option 1: Measure and sum the spectra across the outputs. Refer as FCC KDB 662911, In-band power spectral density (PSD). Sample all transmit ports simultaneously using a spectrum analyzer for each transmit port. Where the trace bin-by-bin of each transmit port summing can be performed. (i.e., in the first spectral bin of output 1 is summed with that in the first spectral bin of output 2 and that from the first spectral bin of output 3, and so on up to the NTX output to obtain the value for the first frequency bin of the summed spectrum.). Add up the amplitude (power) values for the different transmit chains and use this as the new data trace. <input type="checkbox"/> Option 2: Measure and sum spectral maxima across the outputs. With this technique, spectra are measured at each output of the device at the required resolution bandwidth. The maximum value (peak) of each spectrum is determined. These maximum values are then summed mathematically in linear power units across the outputs. These operations shall be performed separately over frequency spans that have different out-of-band or spurious emission limits, <input type="checkbox"/> Option 3: Measure and add 10 log(N) dB, where N is the number of transmit chains. Refer as FCC KDB 662911, In-band power spectral density (PSD). Performed at each transmit chains and each transmit chains shall be compared with the limit have been reduced with 10 log(N). Or each transmit chains shall be add 10 log(N) to compared with the limit.

3.4.4 Test Setup

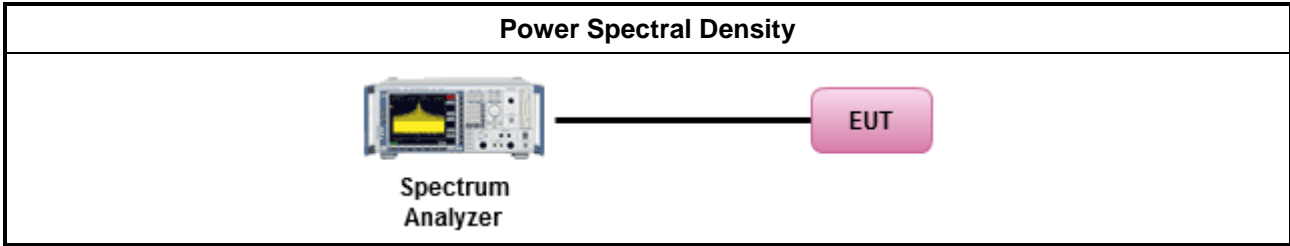

3.4.5 Test Result of Power Spectral Density

Refer as Appendix D

3.5 Emissions in Non-restricted Frequency Bands

3.5.1 Emissions in Non-restricted Frequency Bands Limit

Un-restricted Band Emissions Limit	
RF output power procedure	Limit (dBc)
Peak output power procedure	20
Average output power procedure	30

Note 1: If the peak output power procedure is used to measure the fundamental emission power to demonstrate compliance to requirements, then the peak conducted output power measured within any 100 kHz outside the authorized frequency band shall be attenuated by at least 20 dB relative to the maximum measured in-band peak PSD level.

Note 2: If the average output power procedure is used to measure the fundamental emission power to demonstrate compliance to requirements, then the power in any 100 kHz outside of the authorized frequency band shall be attenuated by at least 30 dB relative to the maximum measured in-band average PSD level.

3.5.2 Measuring Instruments

Refer a test equipment and calibration data table in this test report.

3.5.3 Test Procedures

Test Method
<ul style="list-style-type: none"> Refer as FCC KDB 558074, clause 8.5 for unwanted emissions into non-restricted bands.

3.5.4 Test Setup

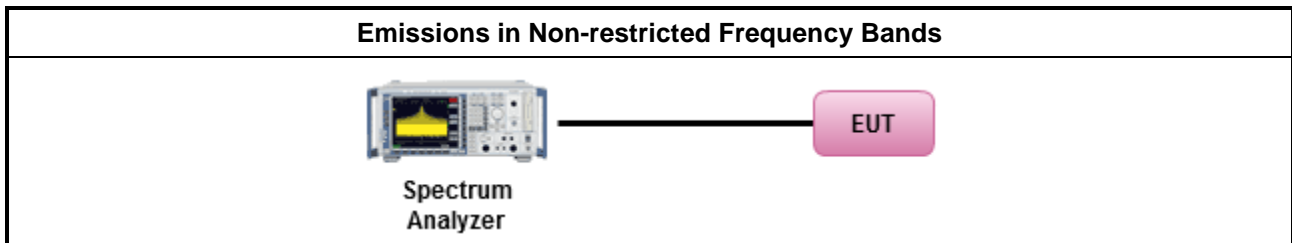

3.5.5 Test Result of Emissions in Non-restricted Frequency Bands

Refer as Appendix E



3.6 Emissions in Restricted Frequency Bands

3.6.1 Emissions in Restricted Frequency Bands Limit

Restricted Band Emissions Limit			
Frequency Range (MHz)	Field Strength (uV/m)	Field Strength (dBuV/m)	Measure Distance (m)
0.009~0.490	2400/F(kHz)	48.5 - 13.8	300
0.490~1.705	24000/F(kHz)	33.8 - 23	30
1.705~30.0	30	29	30
30~88	100	40	3
88~216	150	43.5	3
216~960	200	46	3
Above 960	500	54	3

Note 1: Test distance for frequencies at or above 30 MHz, measurements may be performed at a distance other than the limit distance provided they are not performed in the near field and the emissions to be measured can be detected by the measurement equipment. When performing measurements at a distance other than that specified, the results shall be extrapolated to the specified distance using an extrapolation factor of 20 dB/decade (inverse of linear distance for field-strength measurements, inverse of linear distance-squared for power-density measurements).

Note 2: Test distance for frequencies at below 30 MHz, measurements may be performed at a distance closer than the EUT limit distance; however, an attempt should be made to avoid making measurements in the near field. When performing measurements below 30 MHz at a closer distance than the limit distance, the results shall be extrapolated to the specified distance by either making measurements at a minimum of two or more distances on at least one radial to determine the proper extrapolation factor or by using the square of an inverse linear distance extrapolation factor (40 dB / decade). The test report shall specify the extrapolation method used to determine compliance of the EUT.

Note 3: Using the distance of 1m during the test for above 18 GHz, and the test value to correct for the distance factor at 3m.

3.6.2 Measuring Instruments

Refer a test equipment and calibration data table in this test report.



3.6.3 Test Procedures

Test Method	
<ul style="list-style-type: none"> ▪ The average emission levels shall be measured in [duty cycle \geq 98 or duty factor]. 	
<ul style="list-style-type: none"> ▪ Refer as ANSI C63.10, clause 6.10.3 band-edge testing shall be performed at the lowest frequency channel and highest frequency channel within the allowed operating band. 	
<ul style="list-style-type: none"> ▪ For the transmitter unwanted emissions shall be measured using following options below: 	
	<ul style="list-style-type: none"> ▪ Refer as FCC KDB 558074, clause 8.6 for unwanted emissions into restricted bands.
	<input type="checkbox"/> Refer as FCC KDB 558074, clause 8.6 & C63.10 clause 11.12.2.5.1(trace averaging for duty cycle \geq 98%).
	<input type="checkbox"/> Refer as FCC KDB 558074, clause 8.6 & C63.10 clause 11.12.2.5.2(trace averaging + duty factor).
	<input checked="" type="checkbox"/> Refer as FCC KDB 558074, clause 8.6 & C63.10 clause 11.12.2.5.3(Reduced VBW \geq 1/T).
	<input type="checkbox"/> Refer as ANSI C63.10, clause 11.12.2.5.3 (Reduced VBW). VBW \geq 1/T, where T is pulse time.
	<input type="checkbox"/> Refer as ANSI C63.10, clause 7.5 average value of pulsed emissions.
	<input checked="" type="checkbox"/> Refer as FCC KDB 558074, clause 8.6 & C63.10 clause 11.12.2.4 measurement procedure peak limit.
<ul style="list-style-type: none"> ▪ For the transmitter band-edge emissions shall be measured using following options below: 	
	<ul style="list-style-type: none"> ▪ Refer as FCC KDB 558074 clause 8.7 & c63.10 clause 11.13.1, When the performing peak or average radiated measurements, emissions within 2 MHz of the authorized band edge may be measured using the marker-delta method described below.
	<ul style="list-style-type: none"> ▪ Refer as FCC KDB 558074, clause 8.7 (ANSI C63.10, clause 6.10.6) for marker-delta method for band-edge measurements.
	<ul style="list-style-type: none"> ▪ Refer as FCC KDB 558074, clause 8.7 for narrower resolution bandwidth (100kHz) using the band power and summing the spectral levels (i.e., 1 MHz).
	<ul style="list-style-type: none"> ▪ For conducted unwanted emissions into restricted bands (absolute emission limits). Devices with multiple transmit chains using options given below: (1) Measure and sum the spectra across the outputs or (2) Measure and add 10 log(N) dB
	<ul style="list-style-type: none"> ▪ For FCC KDB 662911 The methodology described here may overestimate array gain, thereby resulting in apparent failures to satisfy the out-of-band limits even if the device is actually compliant. In such cases, compliance may be demonstrated by performing radiated tests around the frequencies at which the apparent failures occurred.

3.6.4 Test Setup

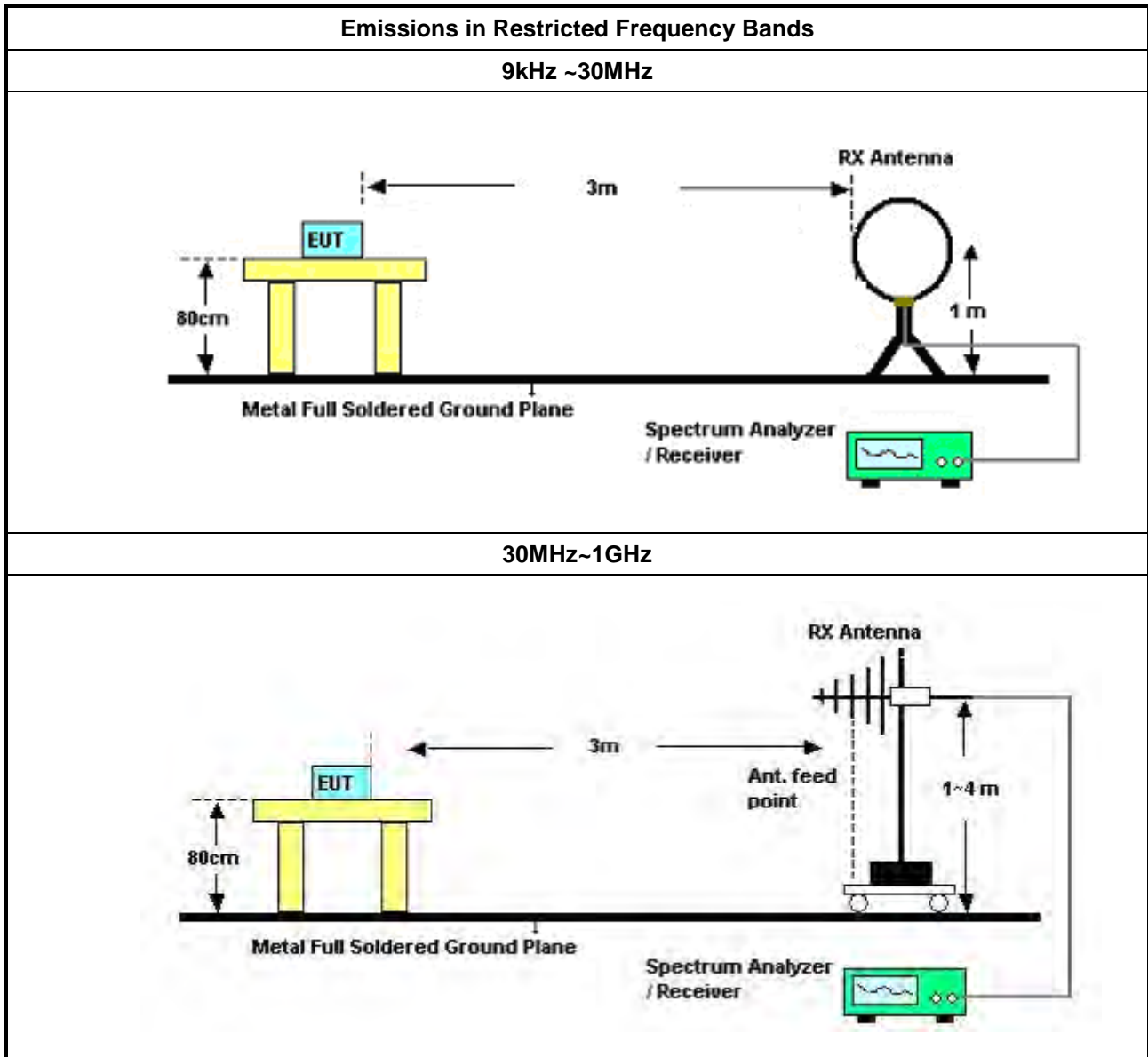

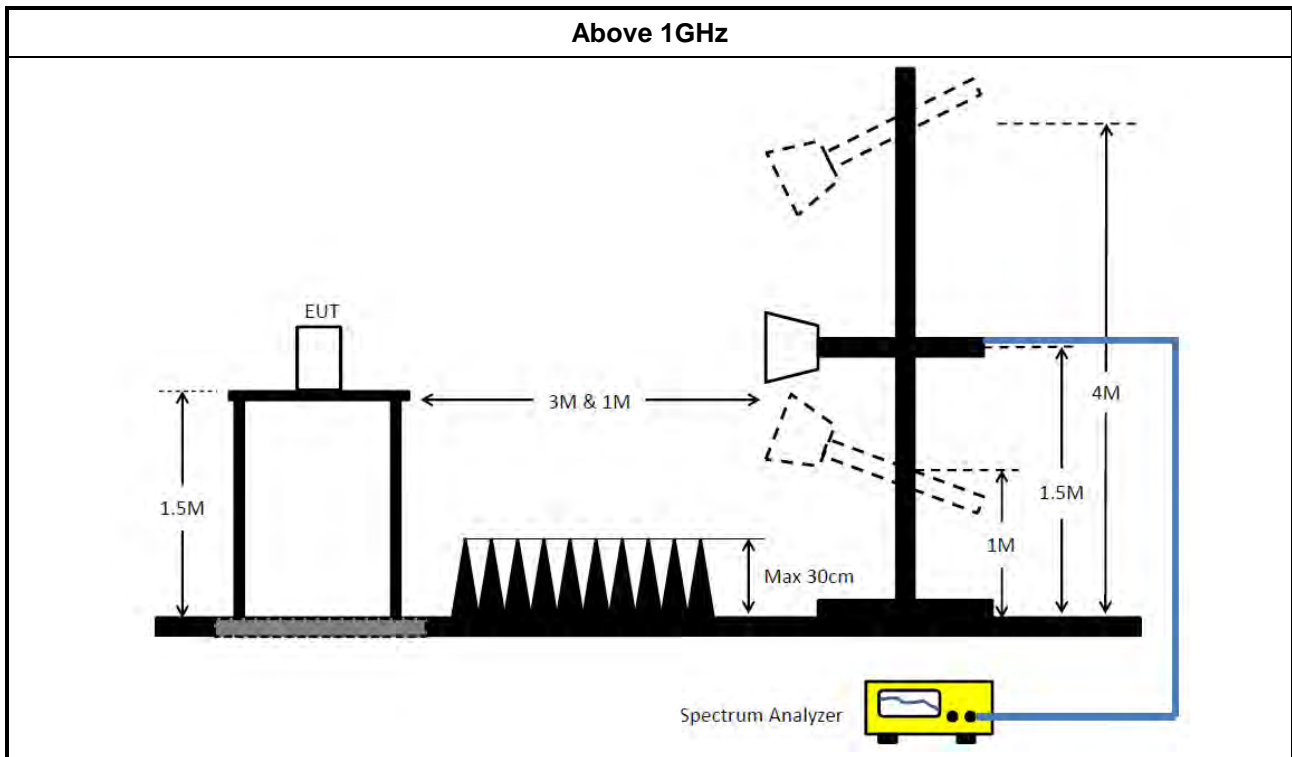

3.6.5 Measurement Results Calculation

The measured Level is calculated using:

Corrected Reading: Antenna factor (AF) + Cable loss (CL) + Read level (Raw) - Preamp factor (PA)(if applicable) = Level.

3.6.6 Emissions in Restricted Frequency Bands (Below 30MHz)

There is a comparison data of both open-field test site and alternative test site - semi-Anechoic chamber according to KDB414788 Radiated Test Site, and the result came out very similar.

All amplitude of spurious emissions that are attenuated by more than 20 dB below the permissible value has no need to be reported.

The radiated emissions were investigated from 9 kHz or the lowest frequency generated within the device, up to the 10th harmonic or 40 GHz, whichever is appropriate.

3.6.7 Test Result of Emissions in Restricted Frequency Bands

Refer as Appendix F



4 Test Equipment and Calibration Data

Instrument	Brand	Model No.	Serial No.	Characteristics	Calibration Date	Calibration Due Date	Remark
EMI Receiver	Agilent	N9038A	MY52260140	9kHz ~ 8.4GHz	May 18, 2023	May 17, 2024	Conduction (CO01-CB)
LISN	Schwarzbeck	NSLK 8127	8127478	9kHz ~ 30MHz	Dec. 29, 2023	Dec. 28, 2024	Conduction (CO01-CB)
LISN	Schwarzbeck	NSLK 8127	8127647	9kHz ~ 30MHz	Apr. 27, 2023	Apr. 26, 2024	Conduction (CO01-CB)
Pulse Limiter	Rohde&Schwarz	ESH3-Z2	100430	9kHz ~ 30MHz	Feb. 08, 2024	Feb. 07, 2025	Conduction (CO01-CB)
COND Cable	Woken	Cable	Low cable-CO01	9kHz ~ 30MHz	Oct. 17, 2023	Oct. 16, 2024	Conduction (CO01-CB)
Software	SPORTON	SENSE	V5.10	-	N.C.R.	N.C.R.	Conduction (CO01-CB)
Loop Antenna	Teseq	HLA 6121	65417	9kHz - 30 MHz	Oct. 13, 2023	Oct. 12, 2024	Radiation (03CH05-CB)
3m Semi Anechoic Chamber NSA	TDK	SAC-3M	03CH05-CB	30 MHz ~ 1 GHz	Aug. 02, 2023	Aug. 01, 2024	Radiation (03CH05-CB)
Bilog Antenna with 6dB Attenuator	TESEQ & EMCI	CBL 6112D & N-6-06	35236 & AT-N0610	30MHz ~ 2GHz	Mar. 24, 2023	Mar. 23, 2024	Radiation (03CH05-CB)
Amplifier	EMCI	EMC330N	980331	20MHz ~ 3GHz	May 03, 2023	May 02, 2024	Radiation (03CH05-CB)
Spectrum Analyzer	R&S	FSP40	100304	9kHz ~ 40GHz	Apr. 18, 2023	Apr. 17, 2024	Radiation (03CH05-CB)
EMI Test Receiver	R&S	ESCS	826547/017	9kHz ~ 2.75GHz	Jun. 13, 2023	Jun. 12, 2024	Radiation (03CH05-CB)
RF Cable-low	Woken	RG402	Low Cable-04+23	30MHz~1GHz	Dec. 06, 2023	Dec. 05, 2024	Radiation (03CH05-CB)
Test Software	SPORTON	SENSE	V5.10	-	N.C.R.	N.C.R.	Radiation (03CH05-CB)
3m Semi Anechoic Chamber VSWR	TDK	SAC-3M	03CH06-CB	1GHz ~18GHz 3m	Oct. 02, 2023	Oct. 01, 2024	Radiation (03CH06-CB)
Horn Antenna	SCHWARZBECK	BBHA9120 D	BBHA 9120D-1292	1GHz~18GHz	Jul. 31, 2023	Jul. 30, 2024	Radiation (03CH06-CB)
Horn Antenna	Schwarzbeck	BBHA 9170	BBHA9170252	15GHz ~ 40GHz	Sep. 04, 2023	Sep. 03, 2024	Radiation (03CH06-CB)
Pre-Amplifier	Agilent	83017A	MY53270064	0.5GHz ~ 26.5GHz	Aug. 01, 2023	Jul. 31, 2024	Radiation (03CH06-CB)
Signal Analyzer	R&S	FSV40	101904	9kHz ~ 40GHz	Apr. 21, 2023	Apr. 20, 2024	Radiation (03CH06-CB)
RF Cable-high	Woken	RG402	High Cable-05+68	1GHz~18GHz	Oct. 02, 2023	Oct. 01, 2024	Radiation (03CH06-CB)



Instrument	Brand	Model No.	Serial No.	Characteristics	Calibration Date	Calibration Due Date	Remark
High Cable	Woken	WCA0929M	40G#5+6	1GHz ~ 40 GHz	Dec. 06, 2023	Dec. 05, 2024	Radiation (03CH06-CB)
High Cable	Woken	WCA0929M	40G#5	1GHz ~ 40 GHz	Oct. 02, 2023	Oct. 01, 2024	Radiation (03CH06-CB)
High Cable	Woken	WCA0929M	40G#6	1GHz ~ 40 GHz	Oct. 02, 2023	Oct. 01, 2024	Radiation (03CH06-CB)
Test Software	SPORTON	SENSE	V5.10	-	N.C.R.	N.C.R.	Radiation (03CH06-CB)
Spectrum analyzer	R&S	FSV40	100979	9kHz~40GHz	May 29, 2023	May 28, 2024	Conducted (TH01-CB)
Switch	SPTCB	SP-SWI	SWI-01	1~26.5 GHz	Oct. 03, 2023	Oct. 02, 2024	Conducted (TH01-CB)
RF Cable-high	Woken	RG402	High Cable-06	1 GHz – 18 GHz	Oct. 02, 2023	Oct. 01, 2024	Conducted (TH01-CB)
RF Cable-high	Woken	RG402	High Cable-07	1 GHz – 18 GHz	Oct. 02, 2023	Oct. 01, 2024	Conducted (TH01-CB)
RF Cable-high	Woken	RG402	High Cable-08	1 GHz – 18 GHz	Oct. 02, 2023	Oct. 01, 2024	Conducted (TH01-CB)
RF Cable-high	Woken	RG402	High Cable-09	1 GHz – 18 GHz	Oct. 02, 2023	Oct. 01, 2024	Conducted (TH01-CB)
RF Cable-high	Woken	RG402	High Cable-10	1 GHz – 18 GHz	Oct. 02, 2023	Oct. 01, 2024	Conducted (TH01-CB)
RF Cable-high	Woken	RG402	High Cable-30	1 GHz – 18 GHz	Oct. 02, 2023	Oct. 01, 2024	Conducted (TH01-CB)
Power Sensor	Agilent	E9327A	US40442088	50MHz~18GHz	Feb. 22, 2023	Feb. 21, 2024	Conducted (TH01-CB)
Power Meter	Agilent	E4416A	GB41291199	50MHz~18GHz	Feb. 22, 2023	Feb. 21, 2024	Conducted (TH01-CB)
Test Software	SPORTON	SENSE	V5.10	-	N.C.R.	N.C.R.	Conducted (TH01-CB)

Note: Calibration Interval of instruments listed above is one year.
NCR means Non-Calibration required.



Summary

Mode	Result	Type	Freq (Hz)	Level (dBuV)	Limit (dBuV)	Margin (dB)	Condition
Mode 1	Pass	QP	150k	52.13	66.00	-13.87	Line

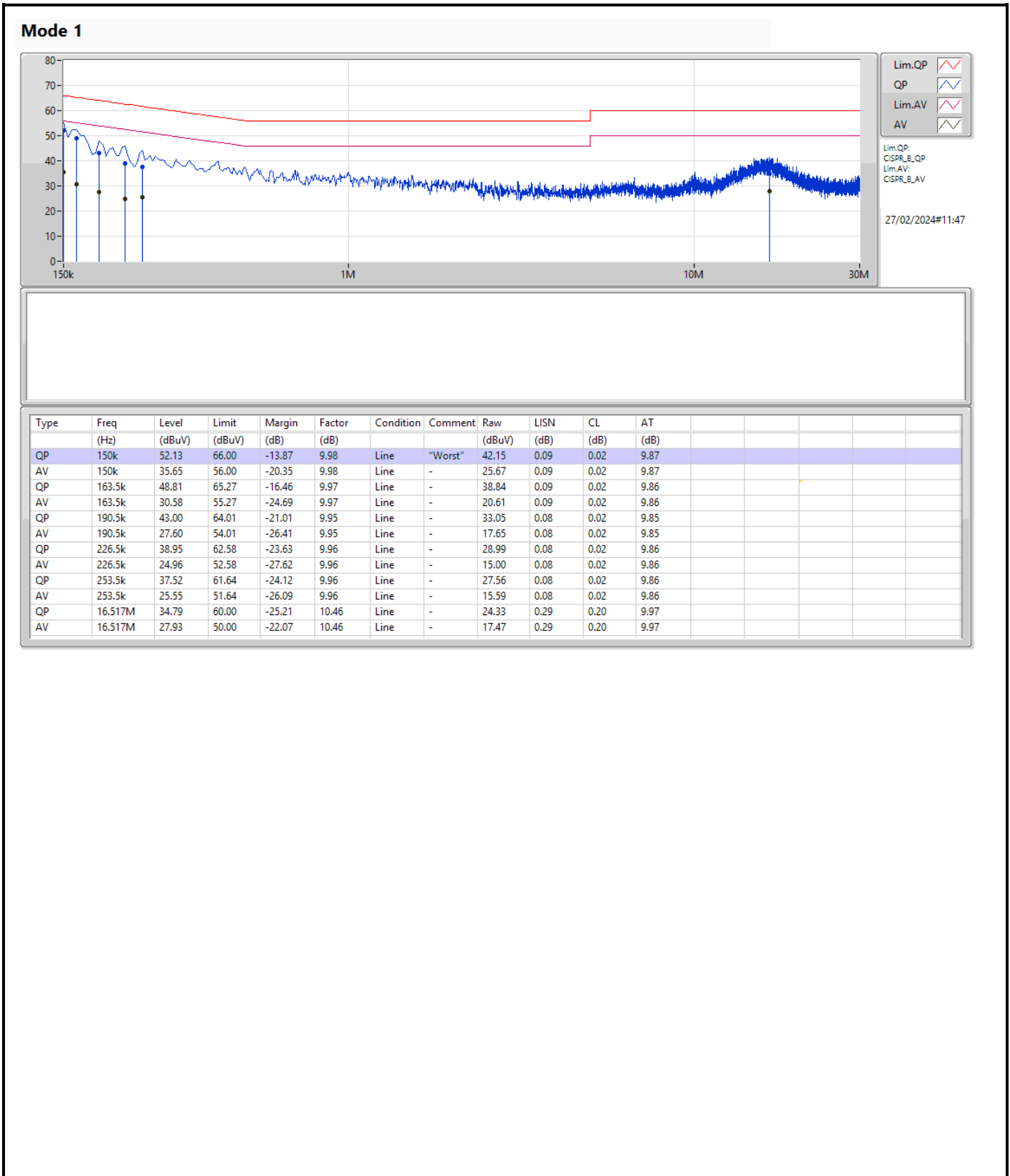

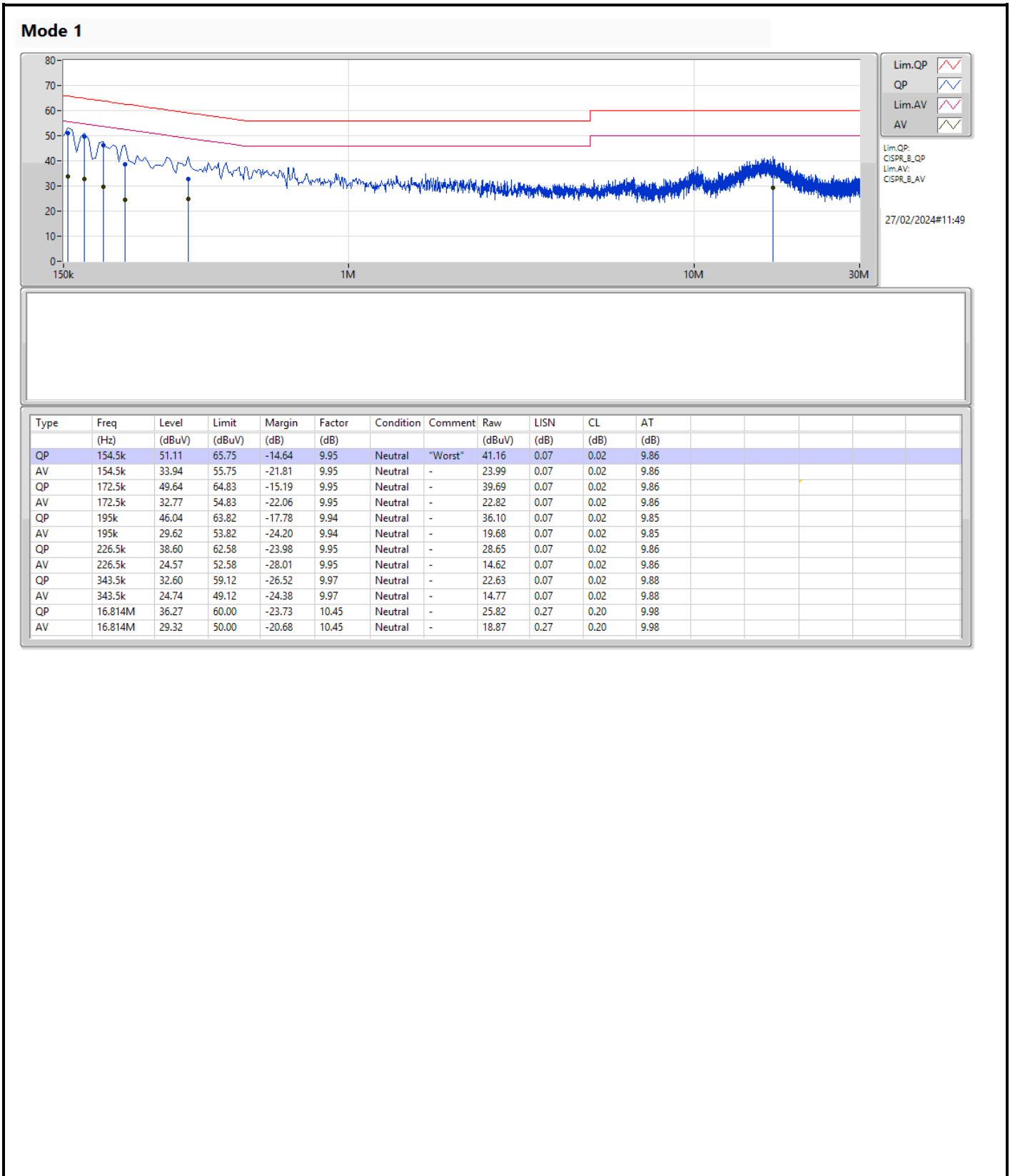



Summary

Mode	Max-N dB (Hz)	Max-OBW (Hz)	ITU-Code	Min-N dB (Hz)	Min-OBW (Hz)
2.4-2.4835GHz	-	-	-	-	-
BT-LE(1Mbps)	663.75k	1.052M	1M05F1D	585k	1.018M
BT-LE(2Mbps)	1.3M	2.099M	2M10F1D	655k	2.087M

Max-N dB = Maximum 6dB down bandwidth; Max-OBW = Maximum 99% occupied bandwidth;
Min-N dB = Minimum 6dB down bandwidth; Min-OBW = Minimum 99% occupied bandwidth



Result

Mode	Result	Limit (Hz)	Port 1-N dB (Hz)	Port 1-OBW (Hz)
BT-LE(1Mbps)	-	-	-	-
2402MHz	Pass	500k	663.75k	1.018M
2440MHz	Pass	500k	585k	1.037M
2480MHz	Pass	500k	632.5k	1.052M
BT-LE(2Mbps)	-	-	-	-
2402MHz	Pass	500k	655k	2.099M
2440MHz	Pass	500k	1.12M	2.087M
2480MHz	Pass	500k	1.3M	2.097M

Port X-N dB = Port X 6dB down bandwidth;
Port X-OBW = Port X 99% occupied bandwidth

2.4-2.4835GHz_BT-LE(1Mbps)

EBW-DTS

2402MHz

30/12/2023

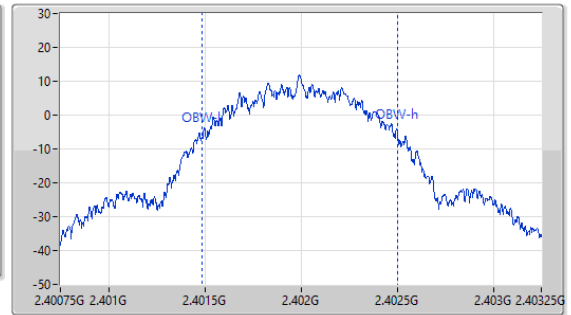
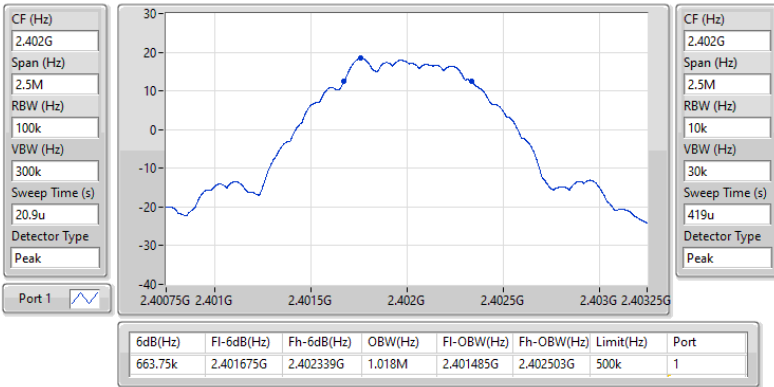

2.4-2.4835GHz_BT-LE(1Mbps)

EBW-DTS

2440MHz

30/12/2023

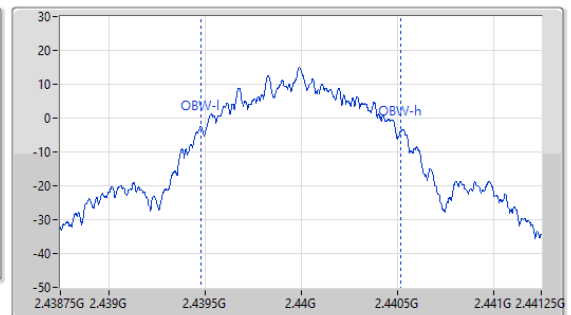
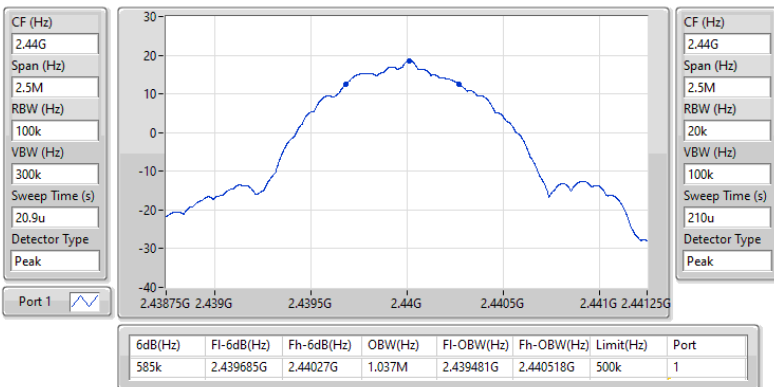

2.4-2.4835GHz_BT-LE(1Mbps)

EBW-DTS

2480MHz

30/12/2023

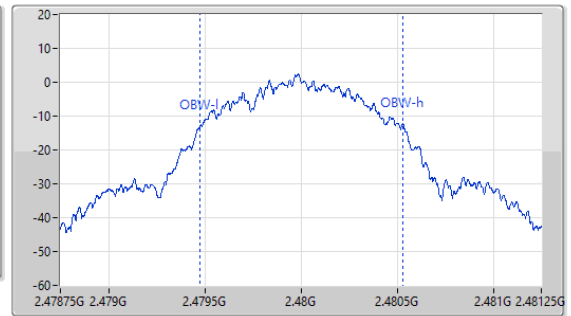
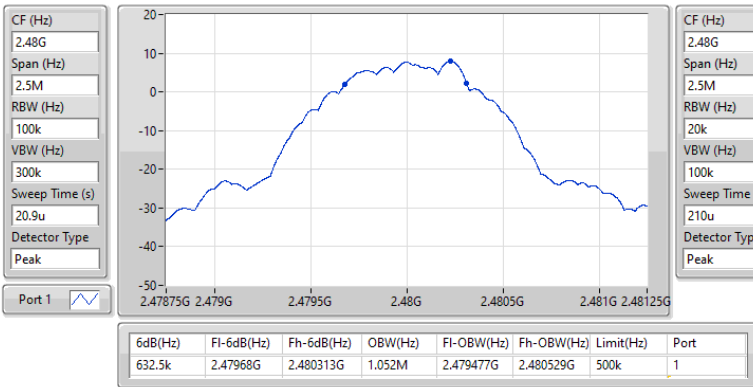

2.4-2.4835GHz_BT-LE(2Mbps)

EBW-DTS

2402MHz

30/12/2023

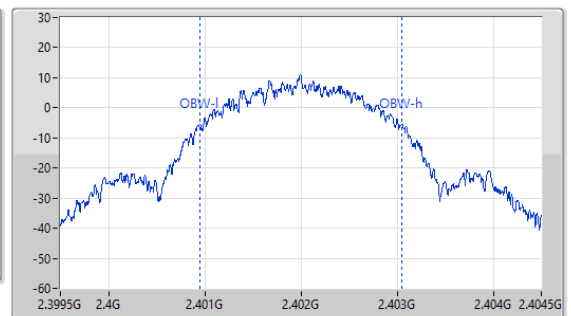
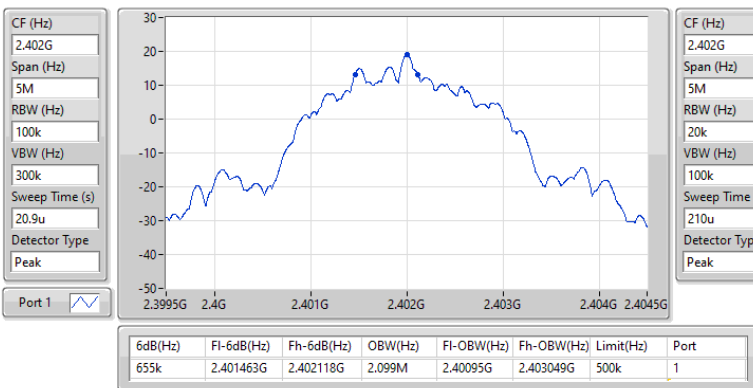

2.4-2.4835GHz_BT-LE(2Mbps)

EBW-DTS

2440MHz

30/12/2023

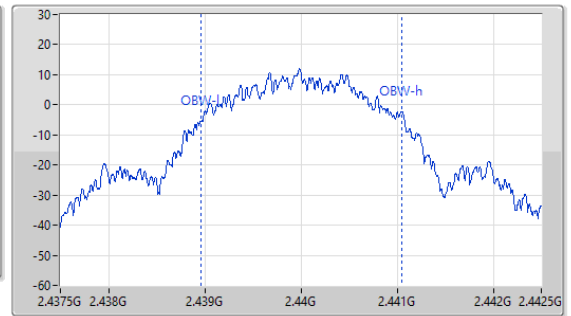
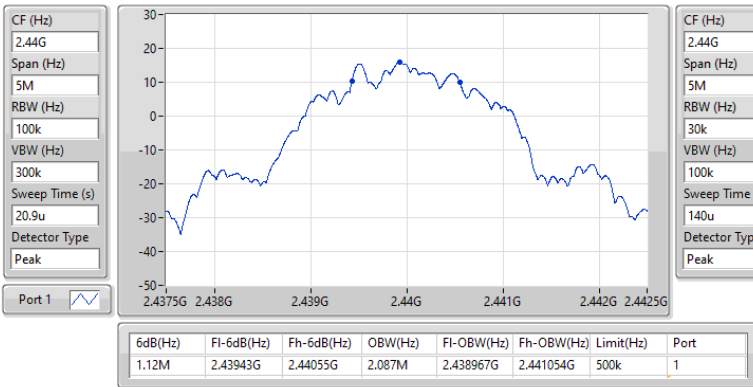

2.4-2.4835GHz_BT-LE(2Mbps)

EBW-DTS

2480MHz

30/12/2023

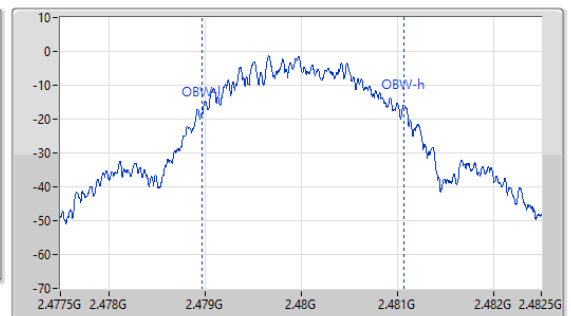
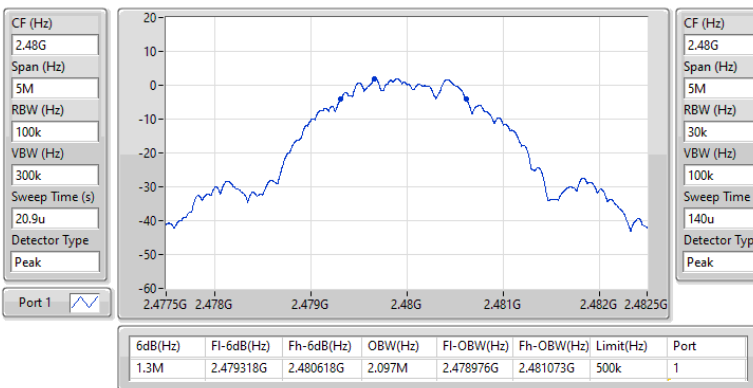



Summary

Mode	Total Power (dBm)	Total Power (W)
2.4-2.4835GHz	-	-
BT-LE(1Mbps)	19.42	0.08750
BT-LE(2Mbps)	19.32	0.08551



Result

Mode	Result	DG (dBi)	Total Power (dBm)	Power Limit (dBm)
BT-LE(1Mbps)	-	-	-	-
2402MHz	Pass	5.60	19.42	30.00
2440MHz	Pass	5.60	19.11	30.00
2478MHz	Pass	5.60	18.21	30.00
2480MHz	Pass	5.60	9.13	30.00
BT-LE(2Mbps)	-	-	-	-
2402MHz	Pass	5.60	19.32	30.00
2440MHz	Pass	5.60	19.16	30.00
2478MHz	Pass	5.60	6.99	30.00
2480MHz	Pass	5.60	6.23	30.00

DG = Directional Gain; Port X = Port X output power



Summary

Mode	PD (dBm/RBW)
2.4-2.4835GHz	-
BT-LE(1Mbps)	4.16
BT-LE(2Mbps)	2.10

RBW = 3kHz;



Result

Mode	Result	DG (dBi)	PD (dBm/RBW)	PD Limit (dBm/RBW)
BT-LE(1Mbps)	-	-	-	-
2402MHz	Pass	5.60	4.16	8.00
2440MHz	Pass	5.60	3.86	8.00
2480MHz	Pass	5.60	-6.76	8.00
BT-LE(2Mbps)	-	-	-	-
2402MHz	Pass	5.60	1.57	8.00
2440MHz	Pass	5.60	2.10	8.00
2480MHz	Pass	5.60	-10.06	8.00

DG = Directional Gain; RBW = 3kHz;
PD = trace bin-by-bin of each transmits port summing can be performed maximum power density; Port X = Port X Power Density;

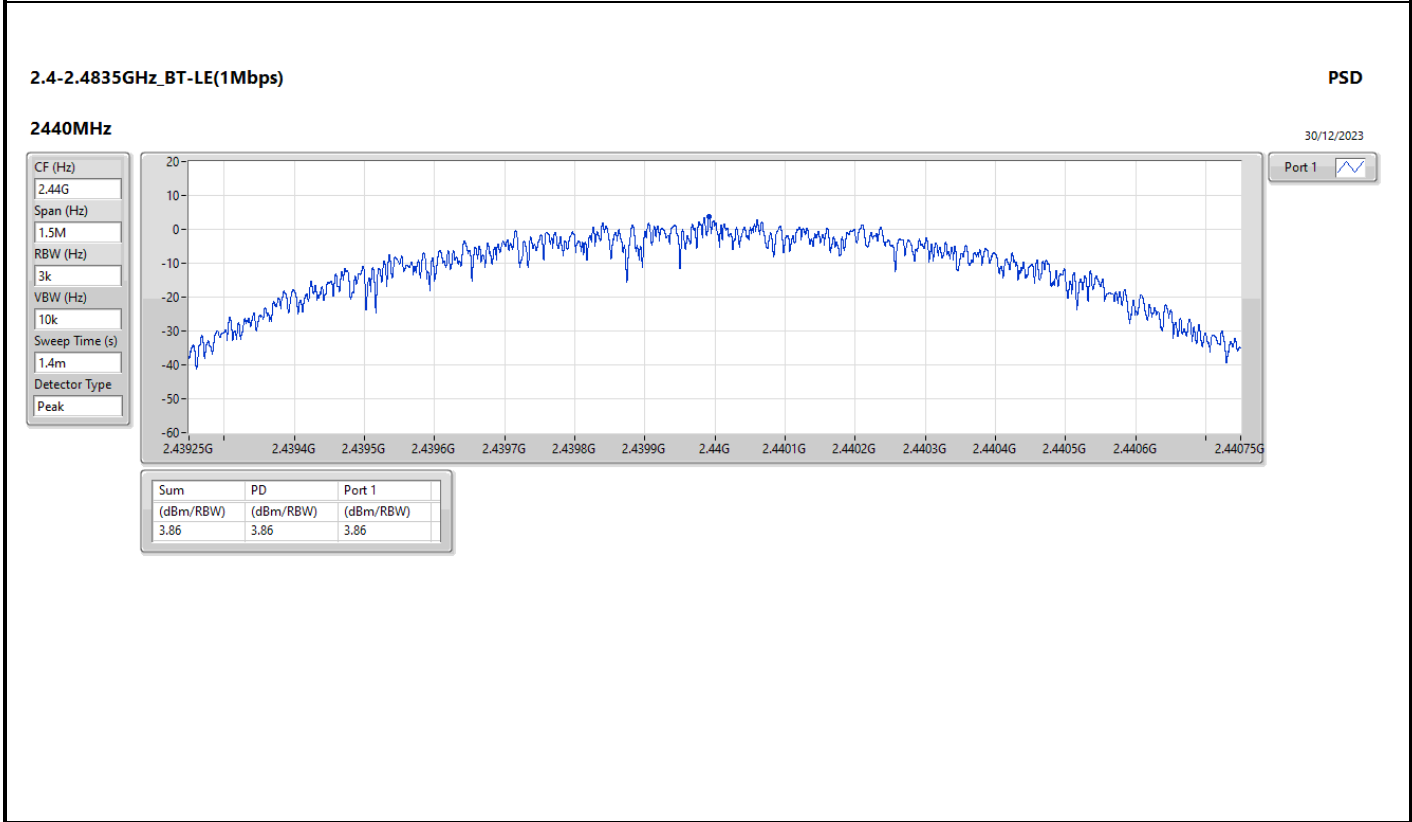
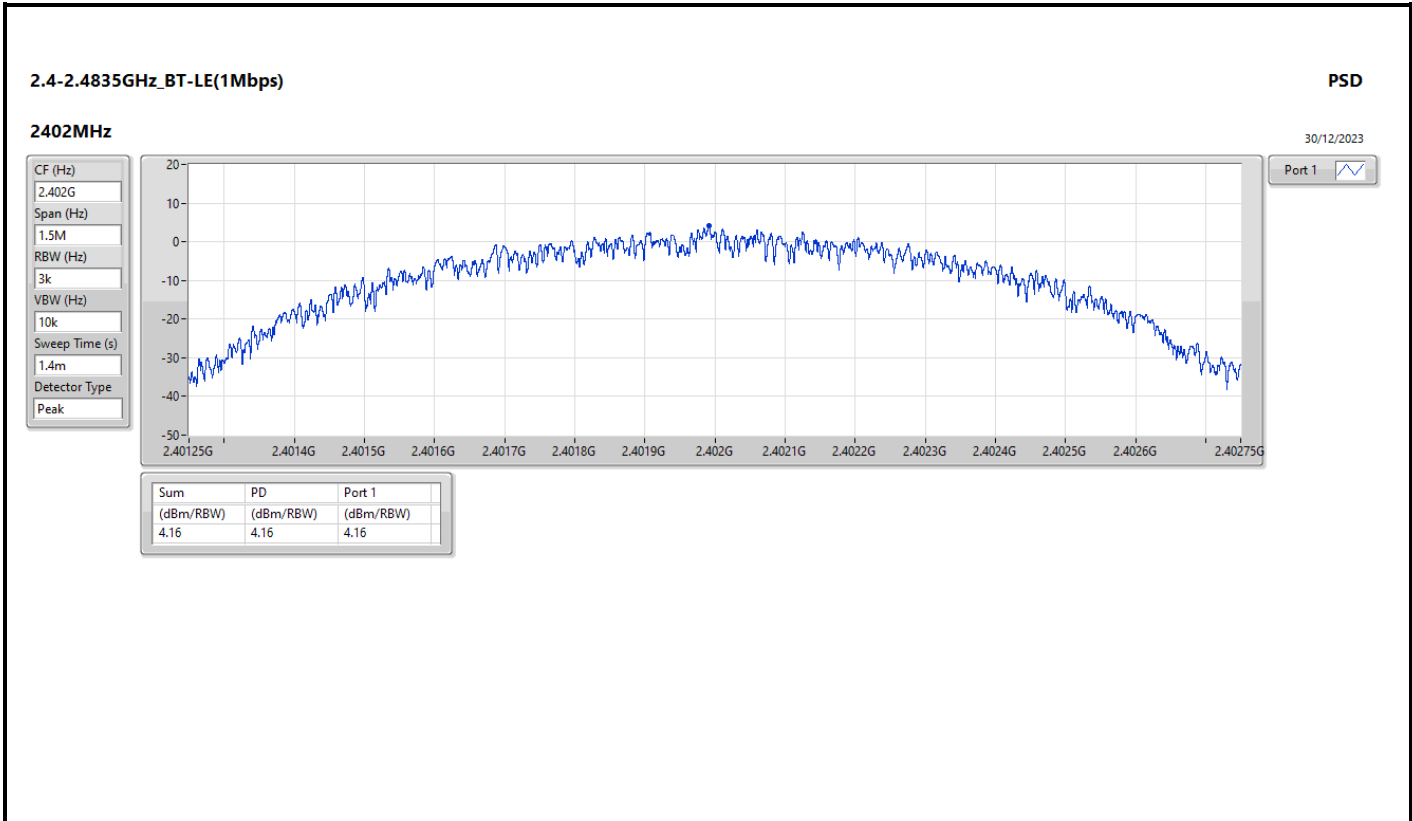

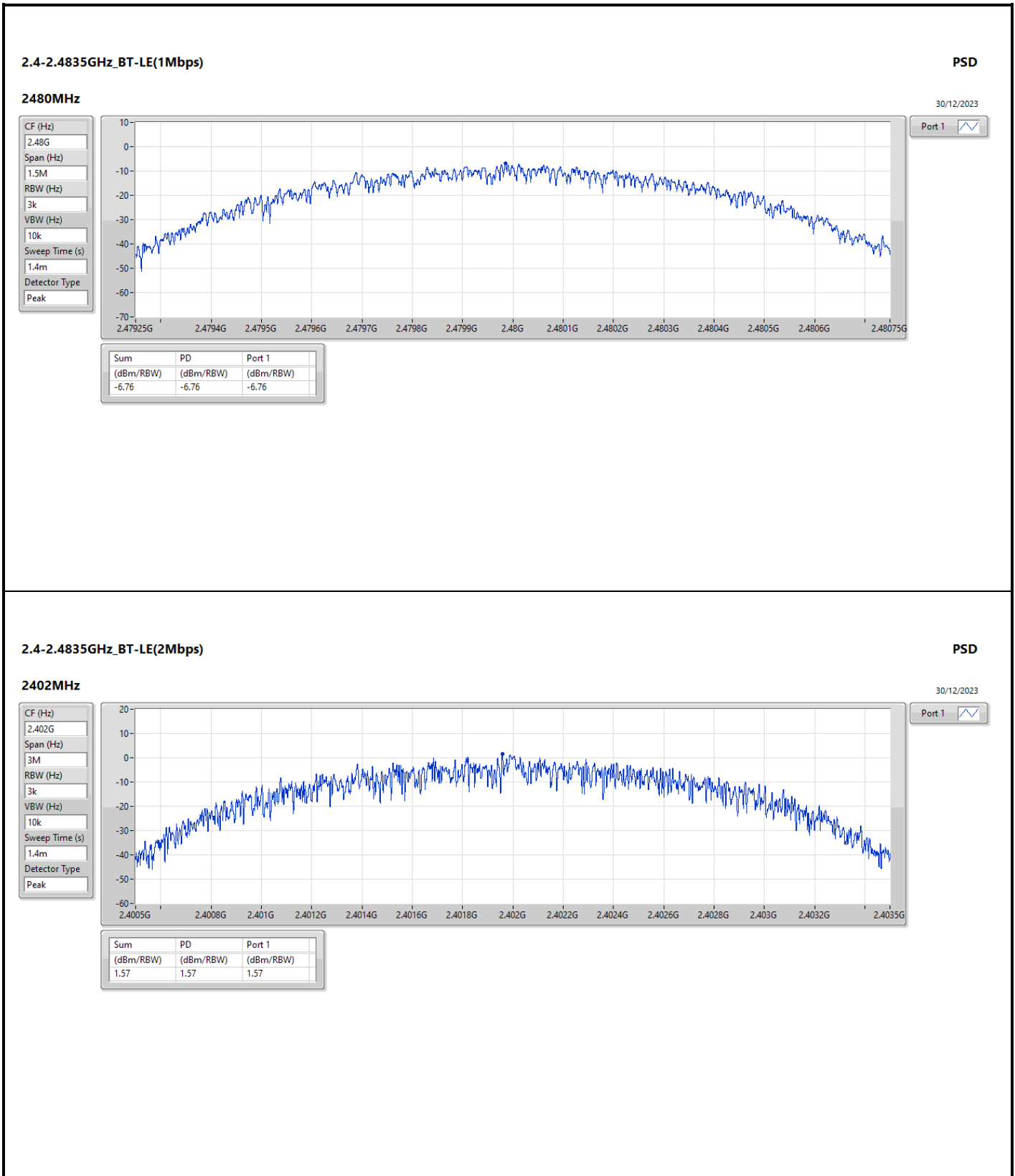

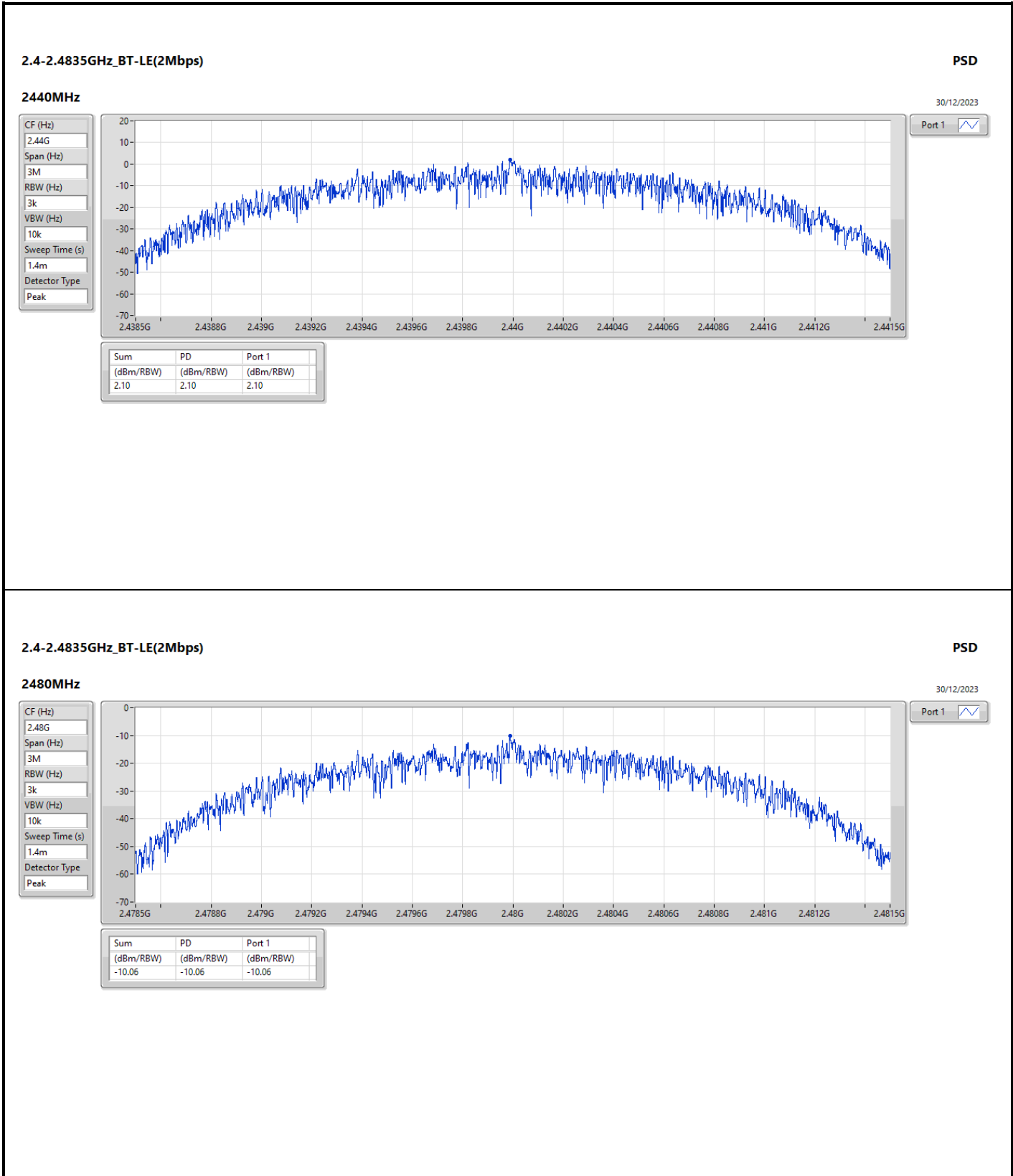



Summary

Mode	Result	Ref (Hz)	Ref (dBm)	Limit (dBm)	Freq (Hz)	Level (dBm)	Freq (Hz)	Level (dBm)	Freq (Hz)	Level (dBm)	Freq (Hz)	Level (dBm)	Freq (Hz)	Level (dBm)	Port
2.4-2.4835GHz	-	-	-	-	-	-	-	-	-	-	-	-	-	-	-
BT-LE(1Mbps)	Pass	2.40184G	19.17	-10.83	1.9429G	-54.34	2.39988G	-33.05	2.4G	-32.58	2.50018G	-52.33	21.5271G	-47.58	1
BT-LE(2Mbps)	Pass	2.402G	19.30	-10.70	2.10623G	-54.62	2.4G	-13.28	2.4G	-13.86	2.5019G	-52.54	21.49898G	-47.29	1

Result

Mode	Result	Ref (Hz)	Ref (dBm)	Limit (dBm)	Freq (Hz)	Level (dBm)	Freq (Hz)	Level (dBm)	Freq (Hz)	Level (dBm)	Freq (Hz)	Level (dBm)	Freq (Hz)	Level (dBm)	Port
BT-LE(1Mbps)	-	-	-	-	-	-	-	-	-	-	-	-	-	-	-
2402MHz	Pass	2.40184G	19.17	-10.83	1.9429G	-54.34	2.39988G	-33.05	2.4G	-32.58	2.50018G	-52.33	21.5271G	-47.58	1
2440MHz	Pass	2.44025G	18.22	-11.78	122.83M	-53.77	2.3954G	-52.23	2.4G	-55.67	2.50126G	-50.87	21.51867G	-47.56	1
2480MHz	Pass	2.48016G	8.90	-21.10	2.1262G	-53.68	2.3974G	-51.89	2.4G	-56.52	2.50114G	-52.28	21.61428G	-48.41	1
BT-LE(2Mbps)	-	-	-	-	-	-	-	-	-	-	-	-	-	-	-
2402MHz	Pass	2.402G	19.30	-10.70	2.10623G	-54.62	2.4G	-13.28	2.4G	-13.86	2.5019G	-52.54	21.49898G	-47.29	1
2440MHz	Pass	2.44008G	18.91	-11.09	2.12268G	-54.48	2.39428G	-51.48	2.4G	-54.37	2.50286G	-51.87	21.62834G	-47.20	1
2480MHz	Pass	2.48016G	6.15	-23.85	1.86653G	-54.13	2.39532G	-52.34	2.4G	-56.12	2.50198G	-52.38	21.41743G	-45.99	1

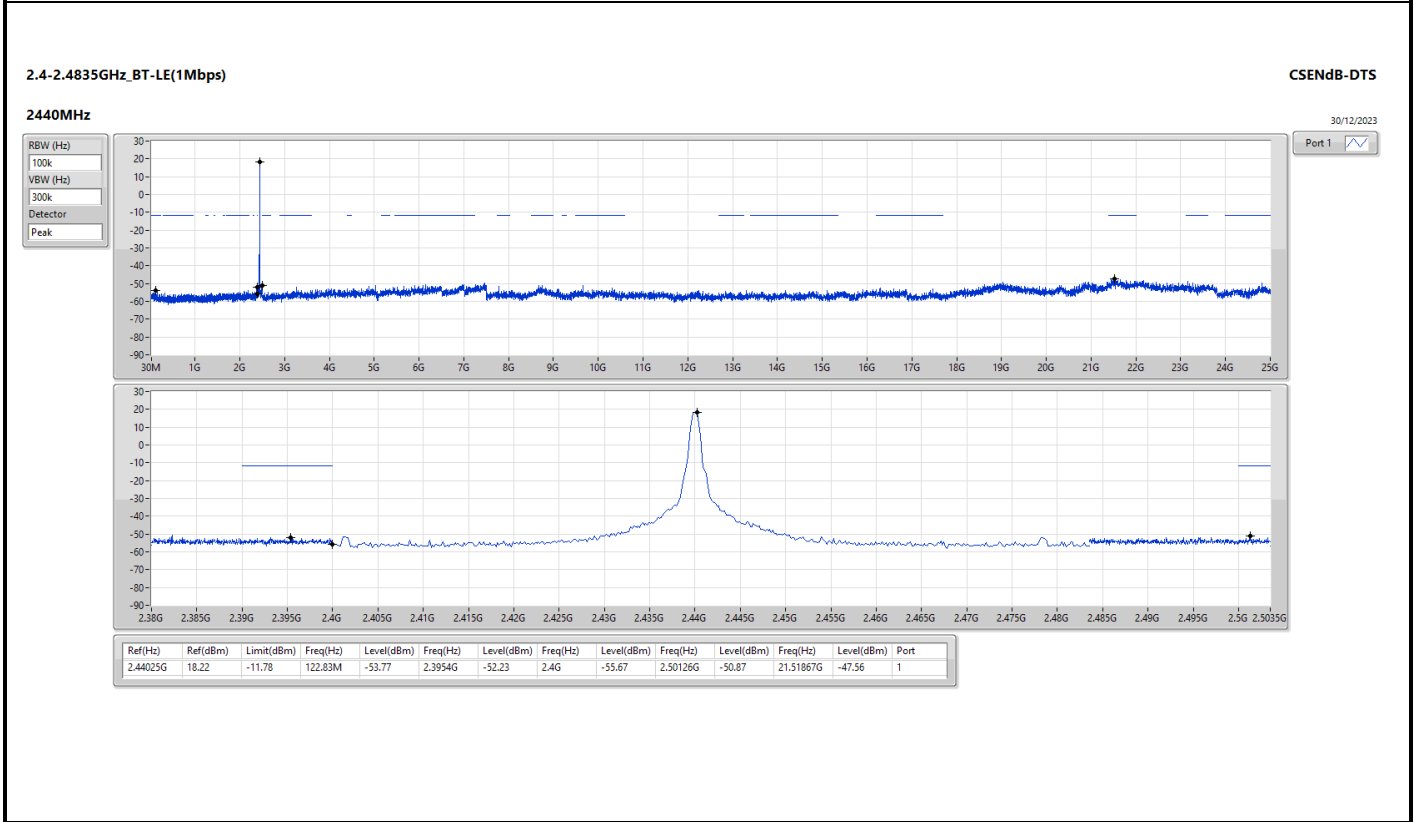
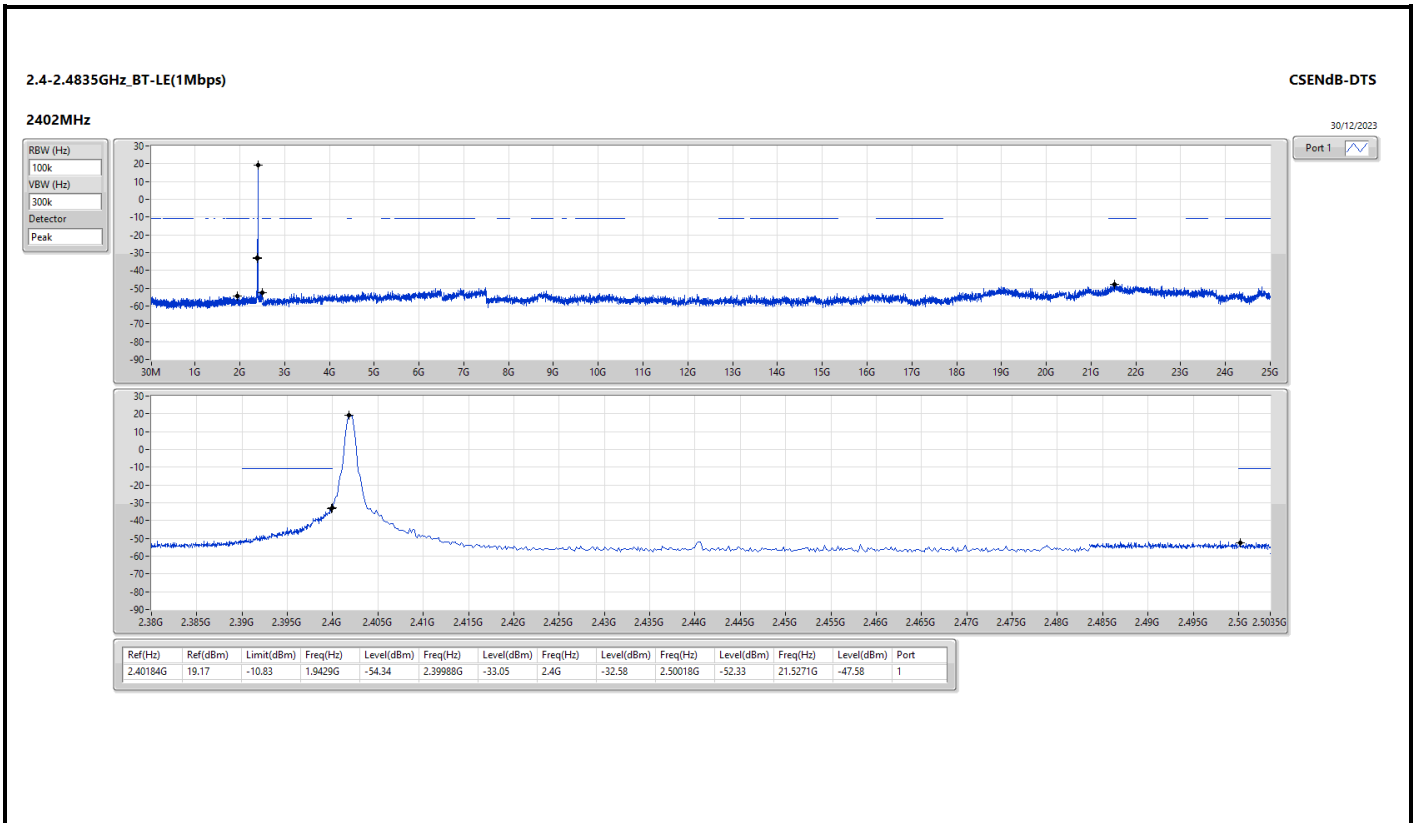

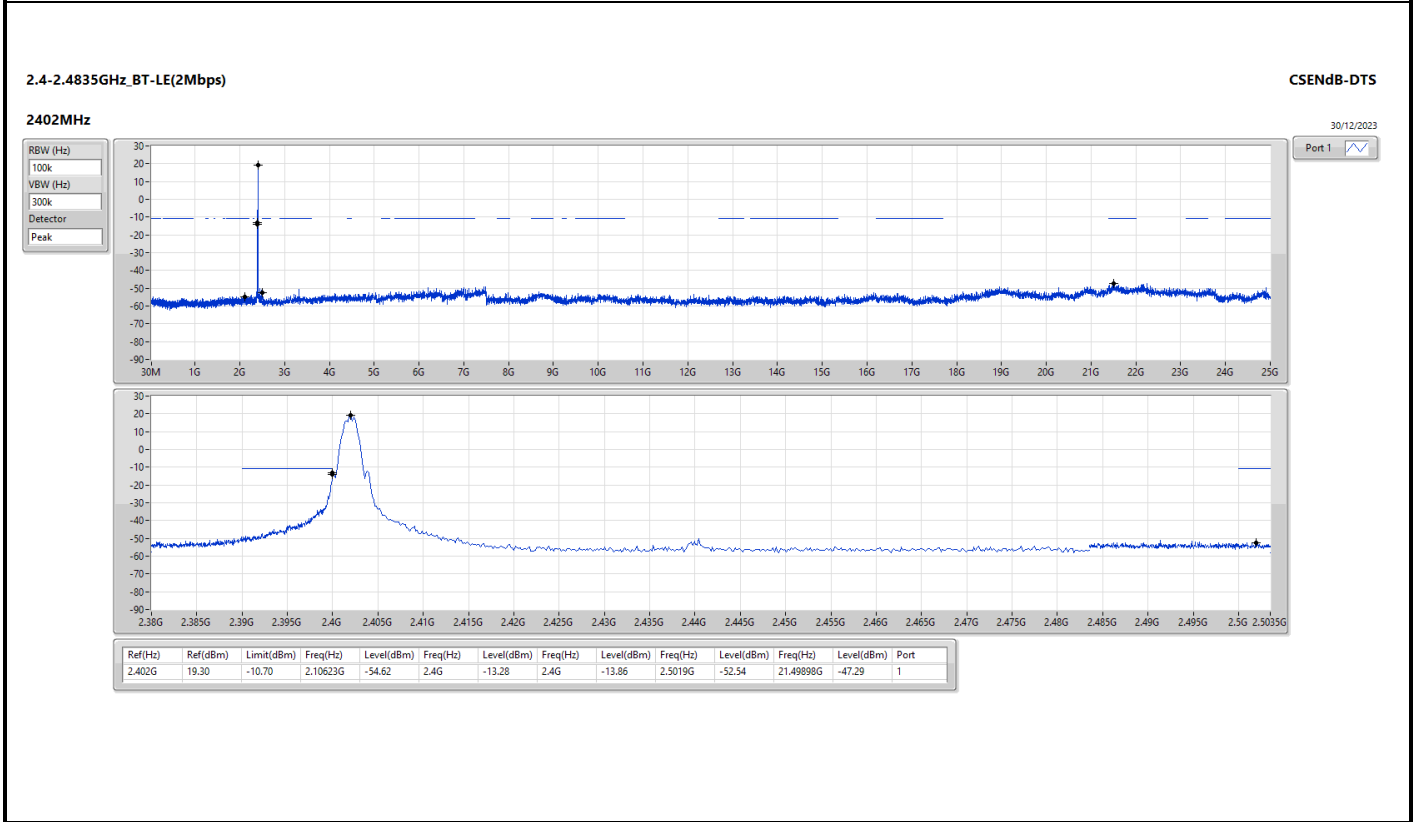
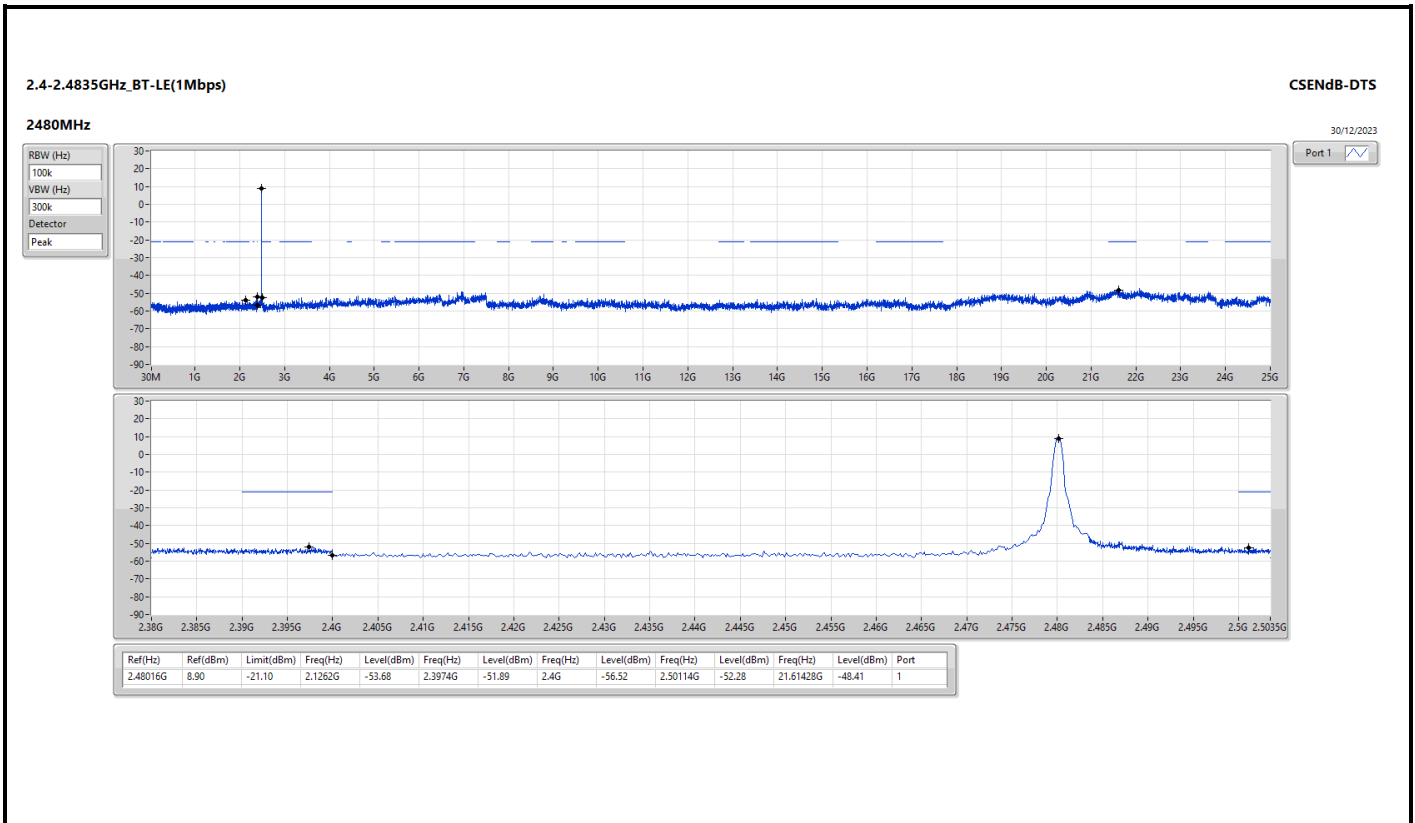

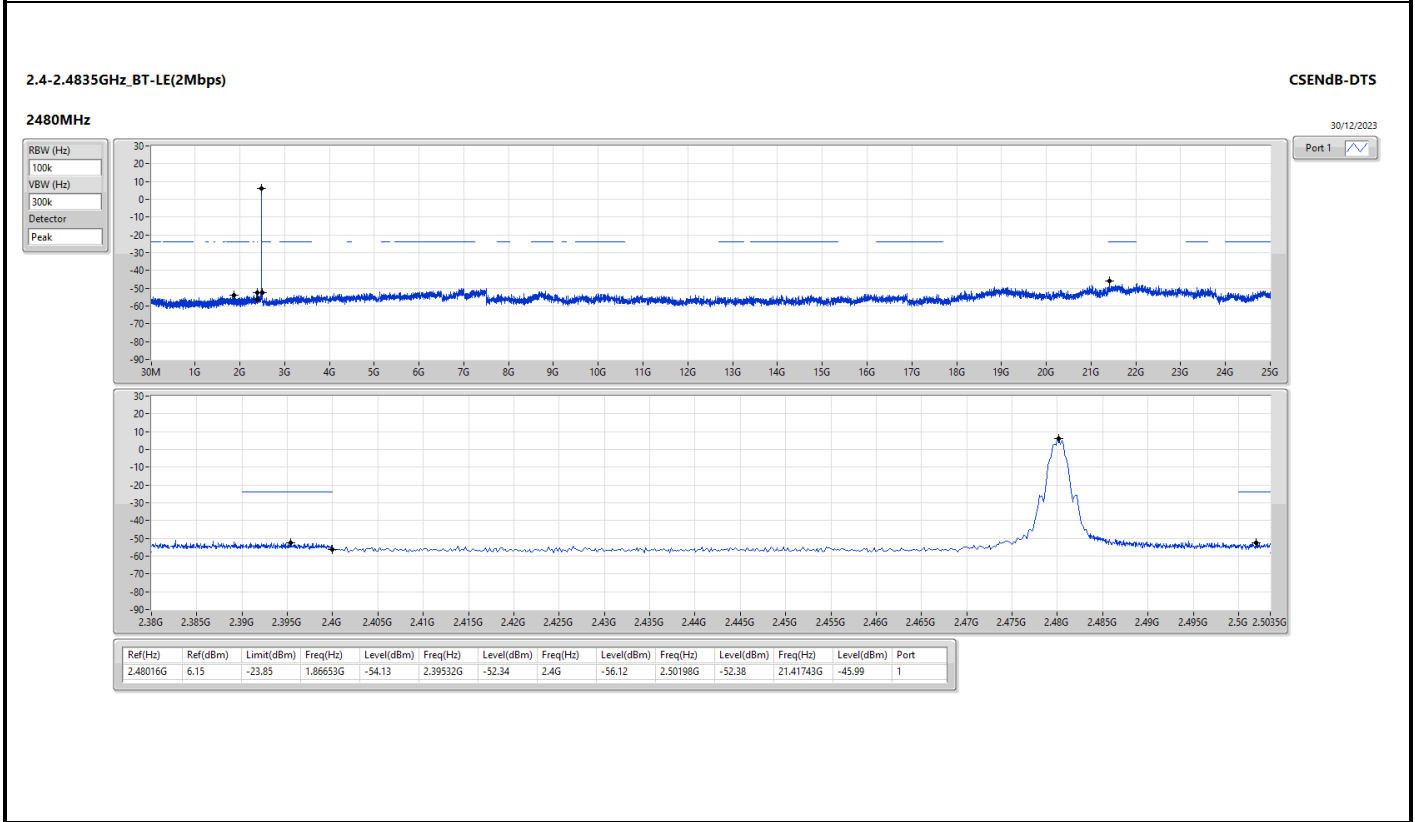
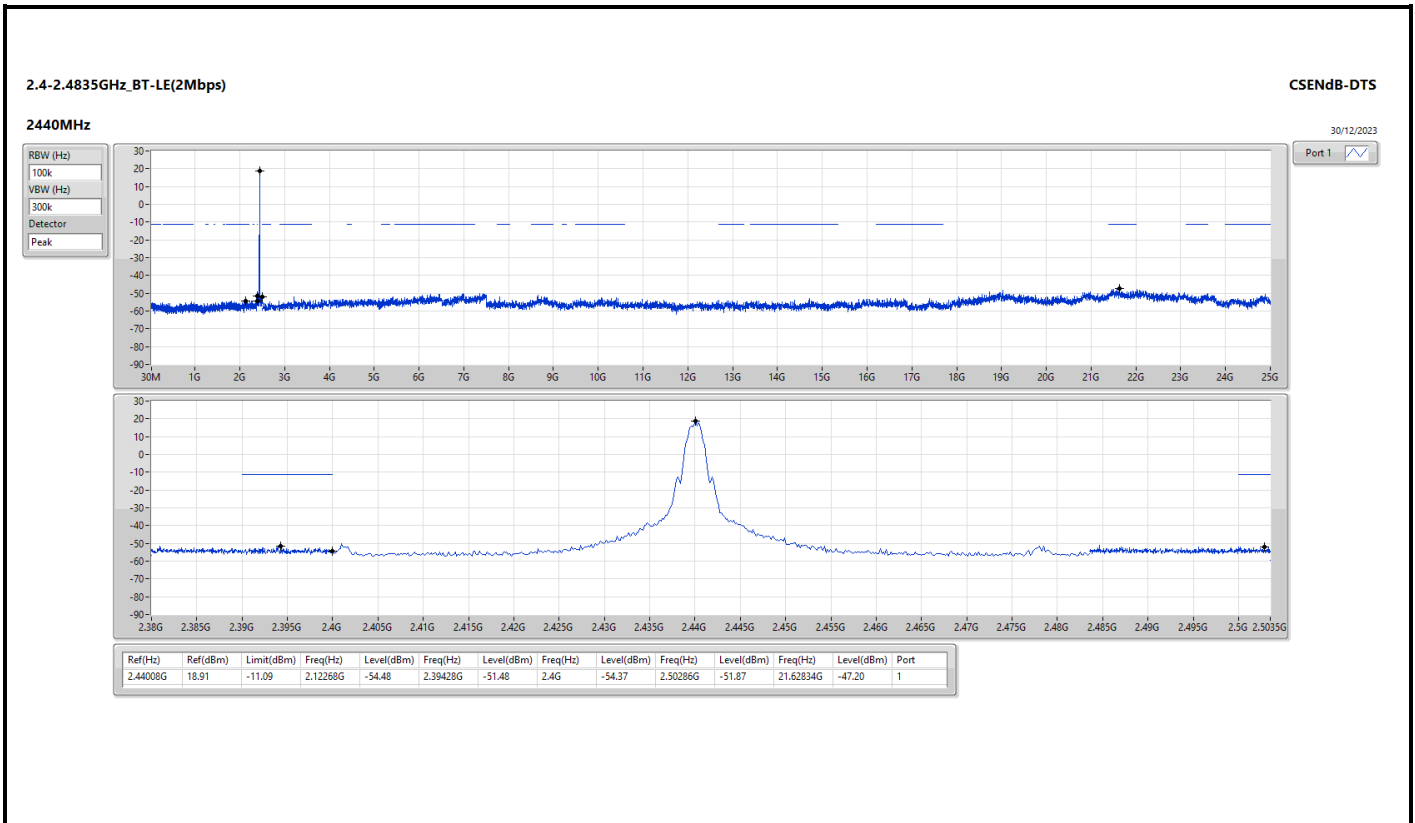



Summary

Mode	Result	Type	Freq (Hz)	Level (dBuV/m)	Limit (dBuV/m)	Margin (dB)	Condition
Mode 3	Pass	QP	36.79M	36.63	40.00	-3.37	Vertical

Mode 3

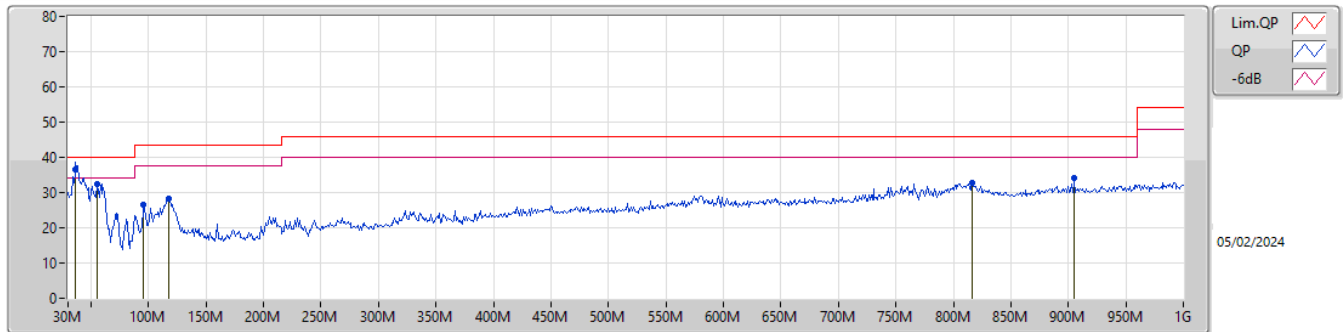

Type	Freq (Hz)	Level (dBuV/m)	Limit (dBuV/m)	Margin (dB)	Factor (dB/m)	Dist (m)	Condition	Azimuth (°)	Height (m)	Comment	Raw (dBuV/m)	AF (dB/m)	CL (dB)	PA (dB)
QP	36.79M	36.63	40.00	-3.37	-10.10	3	Vertical	24	1.00	"Worst"	46.73	20.49	1.12	31.71
PK	55.22M	32.44	40.00	-7.56	-17.70	3	Vertical	318	1.50	-	50.14	12.85	1.33	31.88
PK	95.96M	26.62	43.50	-16.88	-14.11	3	Vertical	84	1.50	-	40.73	16.15	1.73	31.99
PK	117.3M	28.21	43.50	-15.29	-11.84	3	Vertical	180	1.00	-	40.05	18.22	1.91	31.97
PK	816.67M	32.84	46.00	-13.16	-1.49	3	Vertical	360	1.25	-	34.33	25.65	5.49	32.63
PK	904.94M	34.15	46.00	-11.85	-0.22	3	Vertical	0	1.50	-	34.37	26.39	5.85	32.46

Mode 3

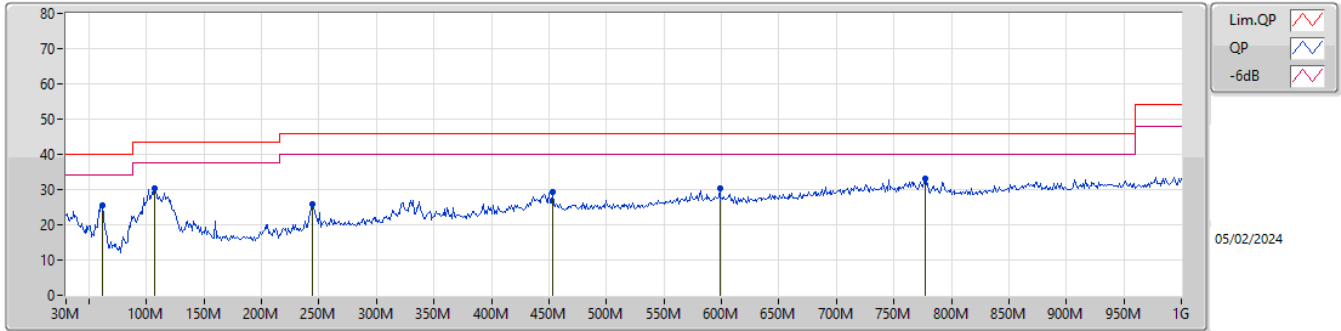

Type	Freq (Hz)	Level (dBuV/m)	Limit (dBuV/m)	Margin (dB)	Factor (dB/m)	Dist (m)	Condition	Azimuth (°)	Height (m)	Comment	Raw (dBuV/m)	AF (dB/m)	CL (dB)	PA (dB)
PK	62.01M	25.50	40.00	-14.50	-18.35	3	Horizontal	93	3.00	-	43.85	12.17	1.41	31.93
PK	106.63M	30.26	43.50	-13.24	-12.44	3	Horizontal	249	3.00	-	42.70	17.70	1.81	31.95
PK	244.37M	25.75	46.00	-20.25	-11.54	3	Horizontal	130	1.25	-	37.29	17.71	2.79	32.04
PK	452.92M	29.32	46.00	-16.68	-5.83	3	Horizontal	63	2.00	-	35.15	22.55	3.95	32.33
PK	598.42M	30.47	46.00	-15.53	-3.56	3	Horizontal	140	1.50	-	34.03	24.37	4.60	32.53
PK	776.9M	33.19	46.00	-12.81	-1.74	3	Horizontal	100	1.25	"Worst"	34.93	25.55	5.34	32.63



Summary

Mode	Result	Type	Freq (Hz)	Level (dBuV/m)	Limit (dBuV/m)	Margin (dB)	Dist (m)	Condition	Azimuth (°)	Height (m)	Comments
2.4-2.4835GHz	-	-	-	-	-	-	-	-	-	-	-
BT-LE(1Mbps)	Pass	AV	2.4835G	53.80	54.00	-0.20	3	Vertical	140	2.01	-

2.4-2.4835GHz_BT-LE(1Mbps)

2402MHz_TX

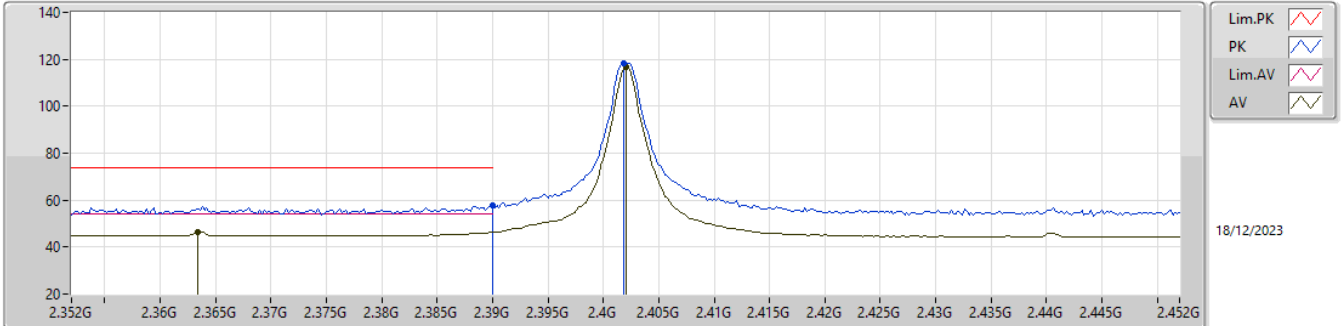

EUT_Y_1TX
Setting 20
06-D-A-4

Type	Freq (Hz)	Level (dBuV/m)	Limit (dBuV/m)	Margin (dB)	Raw (dBuV)	Dist (m)	Condition	Azimuth (°)	Height (m)	Comment	AF (dB)	CL (dB)	PA (dB)
PK	2.39G	57.76	74.00	-16.24	25.35	3	Vertical	324	2.37	-	27.70	4.71	-
AV	2.3634G	46.57	54.00	-7.43	14.02	3	Vertical	324	2.37	-	27.87	4.68	-
PK	2.4018G	118.45	Inf	-Inf	86.05	3	Vertical	324	2.37	-	27.68	4.72	-
AV	2.402G	116.91	Inf	-Inf	84.51	3	Vertical	324	2.37	-	27.68	4.72	-

2.4-2.4835GHz_BT-LE(1Mbps)

2402MHz_TX

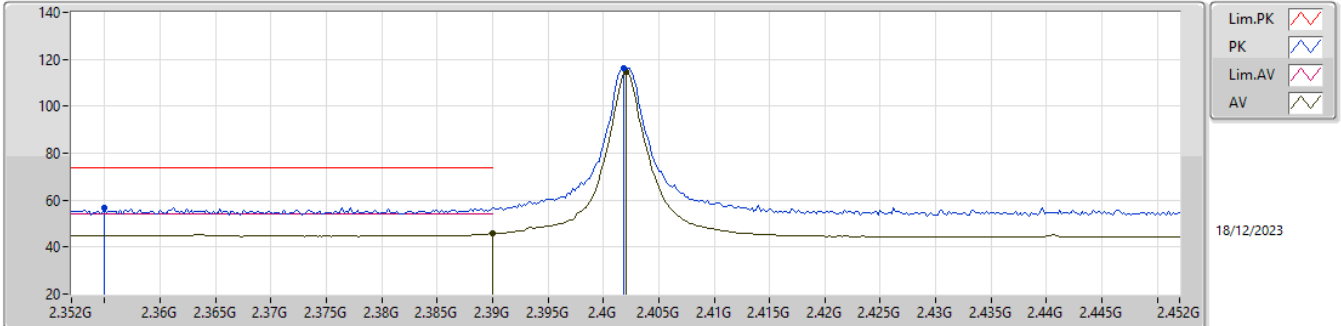

EUT_Y_1TX
Setting 20
06-D-A-4

Type	Freq (Hz)	Level (dBuV/m)	Limit (dBuV/m)	Margin (dB)	Raw (dBuV)	Dist (m)	Condition	Azimuth (°)	Height (m)	Comment	AF (dB)	CL (dB)	PA (dB)
PK	2.355G	56.89	74.00	-17.11	24.32	3	Horizontal	12	3.00	-	27.90	4.67	-
AV	2.39G	45.79	54.00	-8.21	13.38	3	Horizontal	12	3.00	-	27.70	4.71	-
PK	2.4018G	116.12	Inf	-Inf	83.72	3	Horizontal	12	3.00	-	27.68	4.72	-
AV	2.402G	114.61	Inf	-Inf	82.21	3	Horizontal	12	3.00	-	27.68	4.72	-

2.4-2.4835GHz_BT-LE(1Mbps)

2402MHz_TX

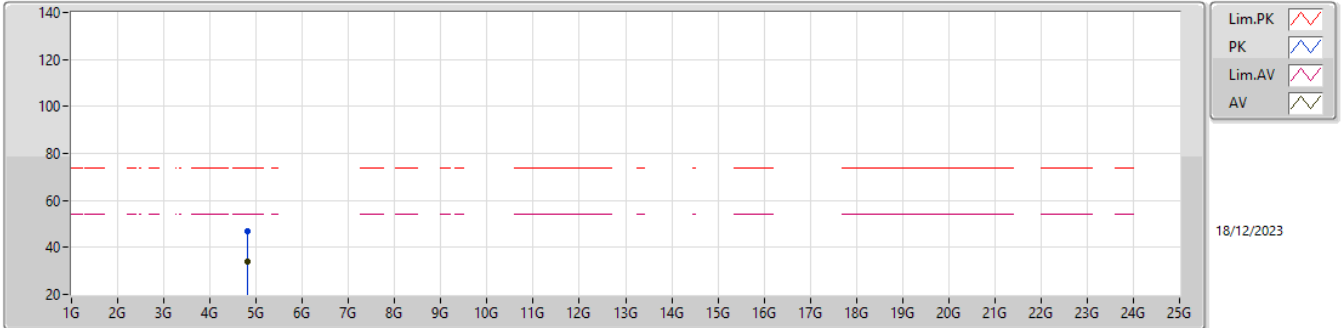

EUT_Y_1TX
Setting 20
06-D-A-4

Type	Freq (Hz)	Level (dBuV/m)	Limit (dBuV/m)	Margin (dB)	Raw (dBuV)	Dist (m)	Condition	Azimuth (°)	Height (m)	Comment	AF (dB)	CL (dB)	PA (dB)
PK	4.80162G	47.02	74.00	-26.98	39.55	3	Vertical	26	1.54	-	31.30	6.67	30.50
AV	4.802G	33.77	54.00	-20.23	26.30	3	Vertical	26	1.54	-	31.30	6.67	30.50

2.4-2.4835GHz_BT-LE(1Mbps)

2402MHz_TX

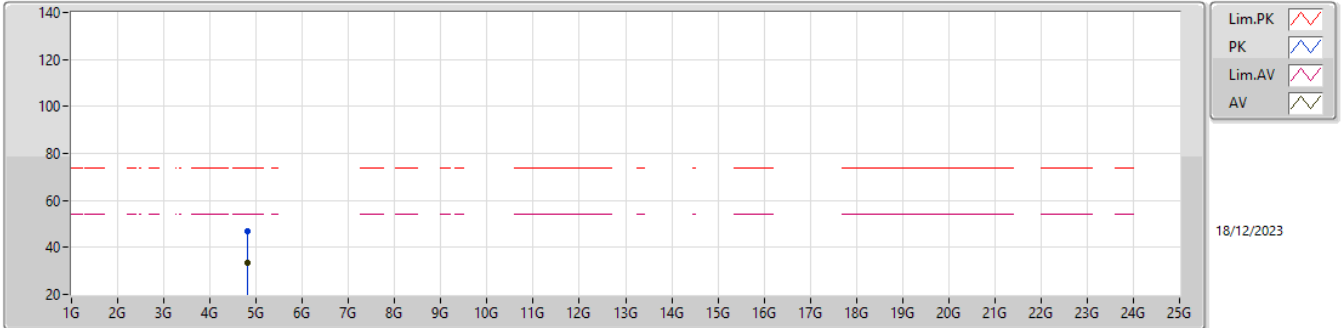

EUT_Y_1TX
Setting 20
06-D-A-4

Type	Freq (Hz)	Level (dBuV/m)	Limit (dBuV/m)	Margin (dB)	Raw (dBuV)	Dist (m)	Condition	Azimuth (°)	Height (m)	Comment	AF (dB)	CL (dB)	PA (dB)
PK	4.80302G	46.69	74.00	-27.31	39.22	3	Horizontal	120	2.33	-	31.30	6.67	30.50
AV	4.8073G	33.66	54.00	-20.34	26.18	3	Horizontal	120	2.33	-	31.30	6.68	30.50

2.4-2.4835GHz_BT-LE(1Mbps)

2440MHz_TX

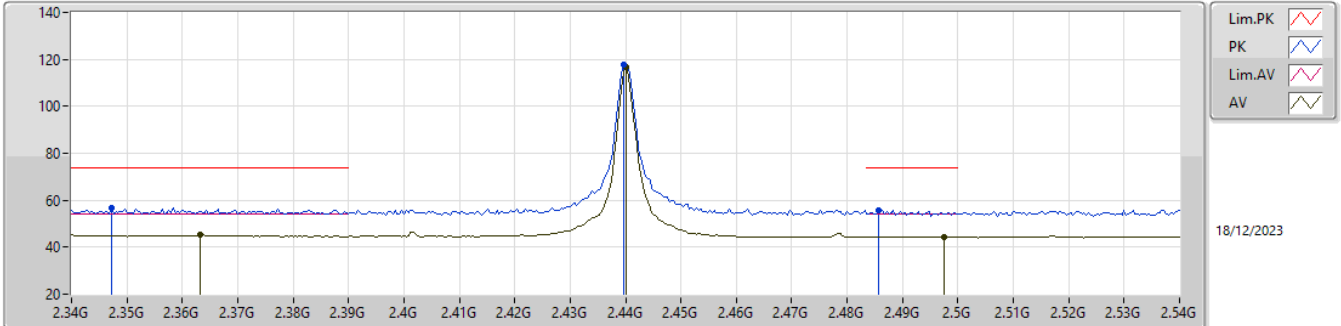

EUT_Y_1TX
Setting 20
06-D-A-4

Type	Freq (Hz)	Level (dBuV/m)	Limit (dBuV/m)	Margin (dB)	Raw (dBuV)	Dist (m)	Condition	Azimuth (°)	Height (m)	Comment	AF (dB)	CL (dB)	PA (dB)
PK	2.3472G	56.64	74.00	-17.36	24.08	3	Vertical	326	2.58	-	27.90	4.66	-
AV	2.3632G	45.17	54.00	-8.83	12.62	3	Vertical	326	2.58	-	27.87	4.68	-
PK	2.4396G	117.98	Inf	-Inf	85.72	3	Vertical	326	2.58	-	27.50	4.76	-
AV	2.44G	116.50	Inf	-Inf	84.24	3	Vertical	326	2.58	-	27.50	4.76	-
PK	2.4856G	55.61	74.00	-18.39	23.41	3	Vertical	326	2.58	-	27.40	4.80	-
AV	2.4976G	44.44	54.00	-9.56	12.23	3	Vertical	326	2.58	-	27.40	4.81	-

2.4-2.4835GHz_BT-LE(1Mbps)

2440MHz_TX

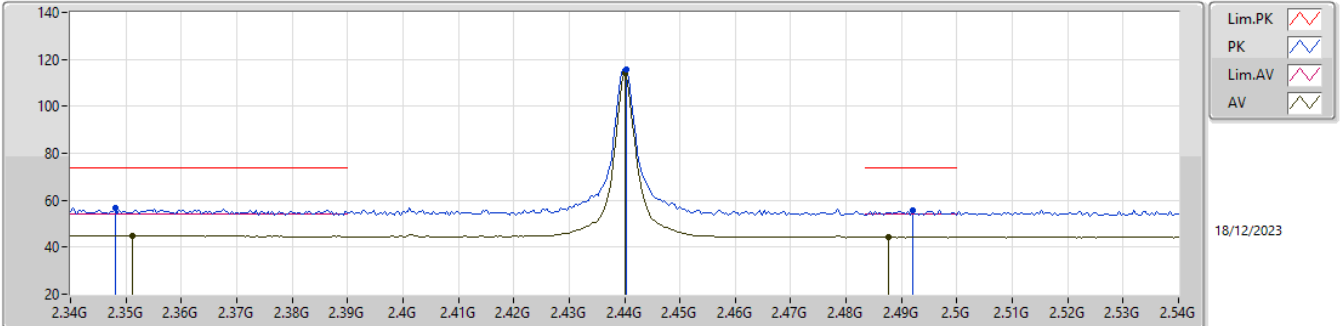

EUT_Y_1TX
Setting 20
06-D-A-4

Type	Freq (Hz)	Level (dBuV/m)	Limit (dBuV/m)	Margin (dB)	Raw (dBuV)	Dist (m)	Condition	Azimuth (°)	Height (m)	Comment	AF (dB)	CL (dB)	PA (dB)
PK	2.348G	56.63	74.00	-17.37	24.06	3	Horizontal	10	2.94	-	27.90	4.67	-
AV	2.3512G	45.03	54.00	-8.97	12.46	3	Horizontal	10	2.94	-	27.90	4.67	-
PK	2.4404G	115.60	Inf	-Inf	83.34	3	Horizontal	10	2.94	-	27.50	4.76	-
AV	2.44G	114.09	Inf	-Inf	81.83	3	Horizontal	10	2.94	-	27.50	4.76	-
PK	2.492G	55.94	74.00	-18.06	23.74	3	Horizontal	10	2.94	-	27.40	4.80	-
AV	2.4876G	44.42	54.00	-9.58	12.22	3	Horizontal	10	2.94	-	27.40	4.80	-

2.4-2.4835GHz_BT-LE(1Mbps)

2440MHz_TX

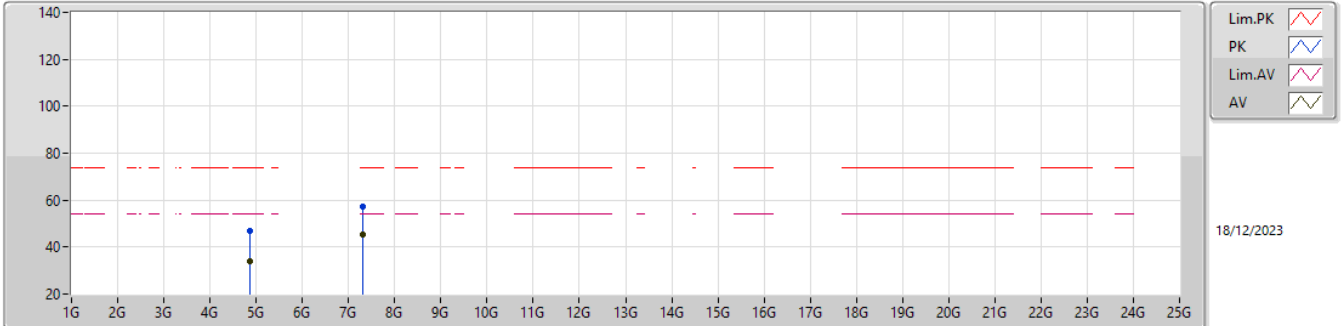

EUT_Y_1TX
Setting 20
06-D-A-4

Type	Freq (Hz)	Level (dBuV/m)	Limit (dBuV/m)	Margin (dB)	Raw (dBuV)	Dist (m)	Condition	Azimuth (°)	Height (m)	Comment	AF (dB)	CL (dB)	PA (dB)
PK	4.87634G	46.98	74.00	-27.02	39.39	3	Vertical	355	3.00	-	31.30	6.73	30.44
AV	4.87678G	33.92	54.00	-20.08	26.32	3	Vertical	355	3.00	-	31.30	6.74	30.44
PK	7.32074G	57.13	74.00	-16.87	43.57	3	Vertical	357	2.51	-	36.60	8.34	31.38
AV	7.3194G	45.19	54.00	-8.81	31.63	3	Vertical	357	2.51	-	36.60	8.34	31.38

2.4-2.4835GHz_BT-LE(1Mbps)

2440MHz_TX

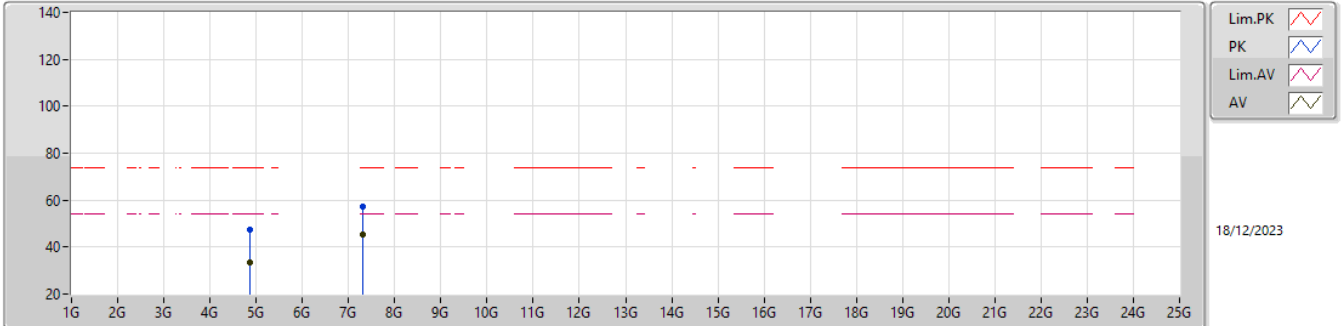

EUT_Y_1TX
Setting 20
06-D-A-4

Type	Freq (Hz)	Level (dBuV/m)	Limit (dBuV/m)	Margin (dB)	Raw (dBuV)	Dist (m)	Condition	Azimuth (°)	Height (m)	Comment	AF (dB)	CL (dB)	PA (dB)
PK	4.87576G	47.26	74.00	-26.74	39.67	3	Horizontal	222	1.46	-	31.30	6.73	30.44
AV	4.87526G	33.65	54.00	-20.35	26.06	3	Horizontal	222	1.46	-	31.30	6.73	30.44
PK	7.32068G	57.39	74.00	-16.61	43.83	3	Horizontal	315	1.72	-	36.60	8.34	31.38
AV	7.3194G	45.46	54.00	-8.54	31.90	3	Horizontal	315	1.72	-	36.60	8.34	31.38

2.4-2.4835GHz_BT-LE(1Mbps)

2478MHz_TX

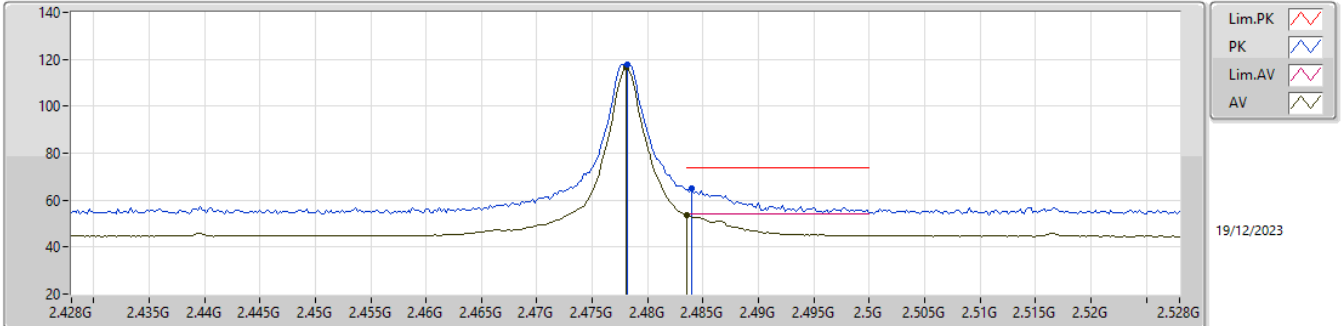

EUT_Y_1TX
Setting 19
06-D-S-4

Type	Freq (Hz)	Level (dBuV/m)	Limit (dBuV/m)	Margin (dB)	Raw (dBuV)	Dist (m)	Condition	Azimuth (°)	Height (m)	Comment	AF (dB)	CL (dB)	PA (dB)
PK	2.4782G	117.89	Inf	-Inf	85.70	3	Vertical	140	2.01	-	27.40	4.79	-
AV	2.478G	116.49	Inf	-Inf	84.30	3	Vertical	140	2.01	-	27.40	4.79	-
PK	2.484G	65.12	74.00	-8.88	32.92	3	Vertical	140	2.01	-	27.40	4.80	-
AV	2.4835G	53.80	54.00	-0.20	21.60	3	Vertical	140	2.01	-	27.40	4.80	-

2.4-2.4835GHz_BT-LE(1Mbps)

2478MHz_TX

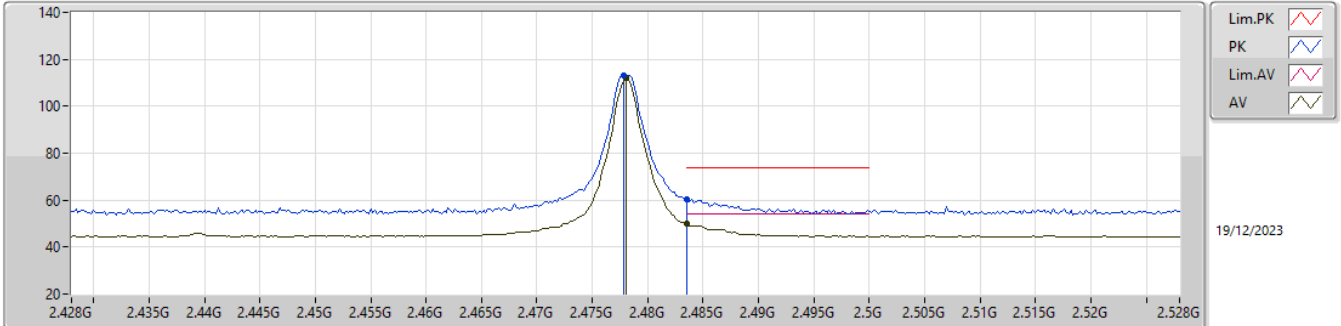

EUT_Y_1TX
Setting 19
06-D-S-4

Type	Freq (Hz)	Level (dBuV/m)	Limit (dBuV/m)	Margin (dB)	Raw (dBuV)	Dist (m)	Condition	Azimuth (°)	Height (m)	Comment	AF (dB)	CL (dB)	PA (dB)
PK	2.4778G	113.35	Inf	-Inf	81.16	3	Horizontal	192	2.87	-	27.40	4.79	-
AV	2.478G	111.93	Inf	-Inf	79.74	3	Horizontal	192	2.87	-	27.40	4.79	-
PK	2.4835G	60.50	74.00	-13.50	28.30	3	Horizontal	192	2.87	-	27.40	4.80	-
AV	2.4835G	49.86	54.00	-4.14	17.66	3	Horizontal	192	2.87	-	27.40	4.80	-

2.4-2.4835GHz_BT-LE(1Mbps)

2478MHz_TX

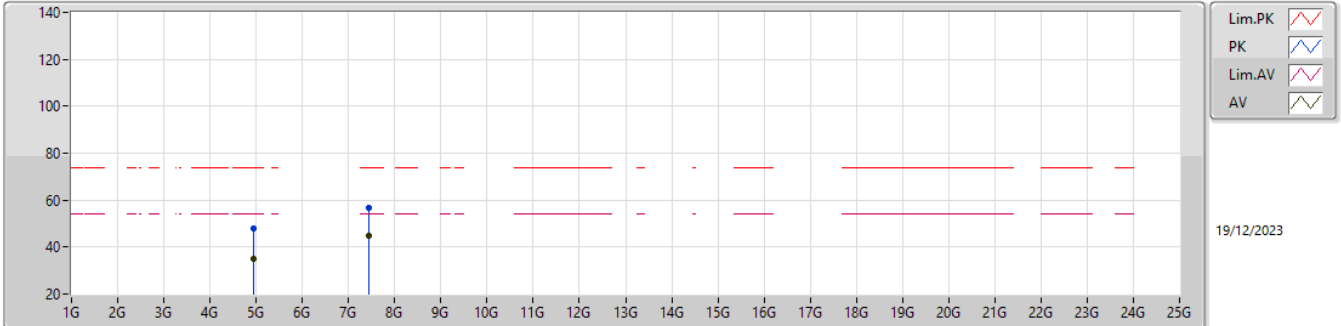

EUT_Y_1TX
Setting 19
06-D-S-4

Type	Freq (Hz)	Level (dBuV/m)	Limit (dBuV/m)	Margin (dB)	Raw (dBuV)	Dist (m)	Condition	Azimuth (°)	Height (m)	Comment	AF (dB)	CL (dB)	PA (dB)
PK	4.95555G	48.18	74.00	-25.82	40.23	3	Vertical	290	2.38	-	31.52	6.80	30.37
AV	4.95605G	34.98	54.00	-19.02	27.03	3	Vertical	290	2.38	-	31.52	6.80	30.37
PK	7.43432G	56.98	74.00	-17.02	43.19	3	Vertical	158	2.68	-	36.67	8.37	31.25
AV	7.43336G	44.70	54.00	-9.30	30.91	3	Vertical	158	2.68	-	36.67	8.37	31.25

2.4-2.4835GHz_BT-LE(1Mbps)

2478MHz_TX

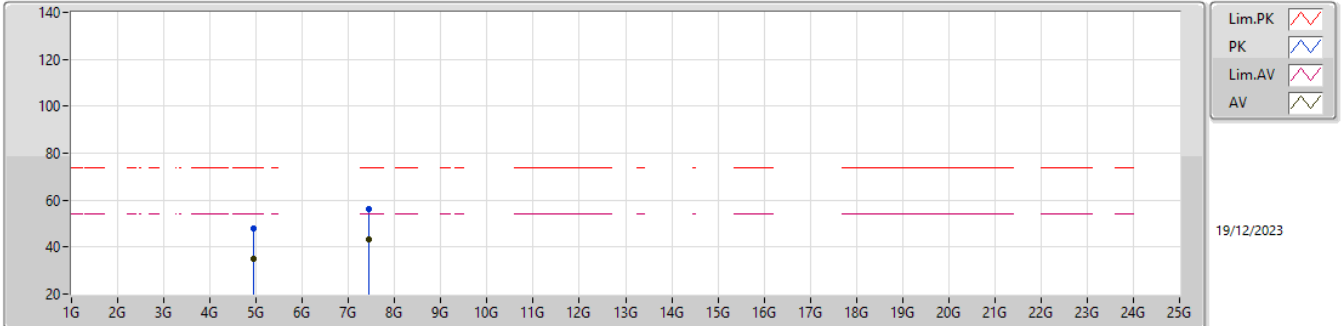

EUT_Y_1TX
Setting 19
06-D-S-4

Type	Freq (Hz)	Level (dBuV/m)	Limit (dBuV/m)	Margin (dB)	Raw (dBuV)	Dist (m)	Condition	Azimuth (°)	Height (m)	Comment	AF (dB)	CL (dB)	PA (dB)
PK	4.95592G	47.81	74.00	-26.19	39.86	3	Horizontal	150	2.50	-	31.52	6.80	30.37
AV	4.95593G	34.83	54.00	-19.17	26.88	3	Horizontal	150	2.50	-	31.52	6.80	30.37
PK	7.43437G	55.97	74.00	-18.03	42.18	3	Horizontal	247	2.05	-	36.67	8.37	31.25
AV	7.43386G	43.14	54.00	-10.86	29.35	3	Horizontal	247	2.05	-	36.67	8.37	31.25

2.4-2.4835GHz_BT-LE(1Mbps)

2480MHz_TX

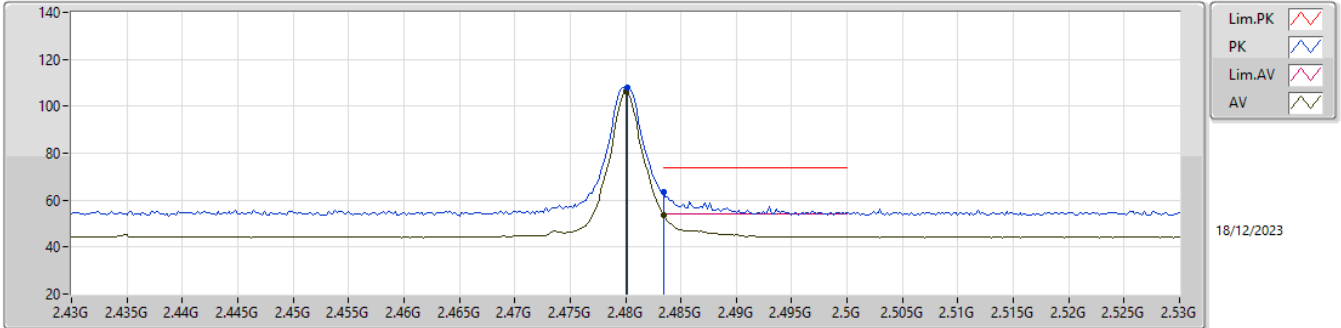

EUT_Y_1TX
Setting 10
06-D-A-4

Type	Freq (Hz)	Level (dBuV/m)	Limit (dBuV/m)	Margin (dB)	Raw (dBuV)	Dist (m)	Condition	Azimuth (°)	Height (m)	Comment	AF (dB)	CL (dB)	PA (dB)
PK	2.4802G	107.81	Inf	-Inf	75.62	3	Vertical	327	2.21	-	27.40	4.79	-
AV	2.48G	106.31	Inf	-Inf	74.12	3	Vertical	327	2.21	-	27.40	4.79	-
PK	2.4835G	63.23	74.00	-10.77	31.03	3	Vertical	327	2.21	-	27.40	4.80	-
AV	2.4835G	53.68	54.00	-0.32	21.48	3	Vertical	327	2.21	-	27.40	4.80	-

2.4-2.4835GHz_BT-LE(1Mbps)

2480MHz_TX

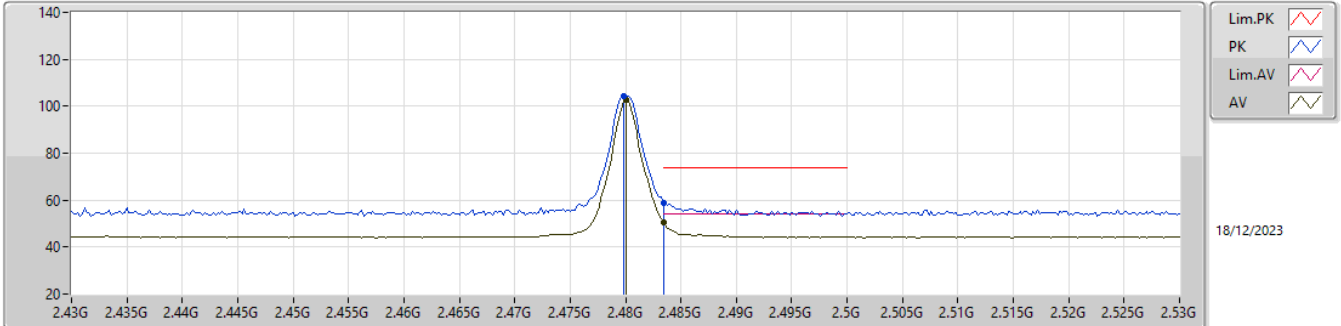

EUT_Y_1TX
Setting 10
06-D-A-4

Type	Freq (Hz)	Level (dBuV/m)	Limit (dBuV/m)	Margin (dB)	Raw (dBuV)	Dist (m)	Condition	Azimuth (°)	Height (m)	Comment	AF (dB)	CL (dB)	PA (dB)
PK	2.4798G	104.11	Inf	-Inf	71.92	3	Horizontal	14	2.87	-	27.40	4.79	-
AV	2.48G	102.60	Inf	-Inf	70.41	3	Horizontal	14	2.87	-	27.40	4.79	-
PK	2.4835G	58.65	74.00	-15.35	26.45	3	Horizontal	14	2.87	-	27.40	4.80	-
AV	2.4835G	50.42	54.00	-3.58	18.22	3	Horizontal	14	2.87	-	27.40	4.80	-

2.4-2.4835GHz_BT-LE(1Mbps)

2480MHz_TX

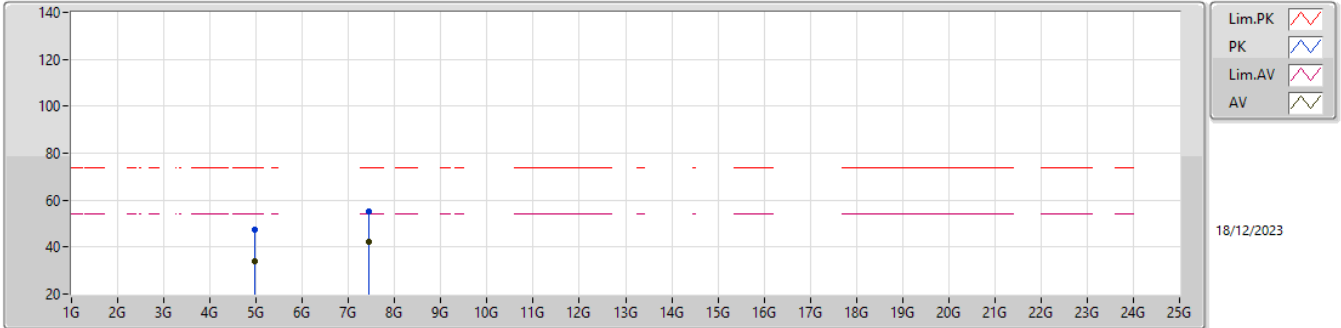

EUT_Y_1TX
Setting 10
06-D-A-4

Type	Freq (Hz)	Level (dBuV/m)	Limit (dBuV/m)	Margin (dB)	Raw (dBuV)	Dist (m)	Condition	Azimuth (°)	Height (m)	Comment	AF (dB)	CL (dB)	PA (dB)
PK	4.95622G	47.23	74.00	-26.77	39.28	3	Vertical	0	1.80	-	31.52	6.80	30.37
AV	4.96374G	33.94	54.00	-20.06	25.94	3	Vertical	0	1.80	-	31.55	6.81	30.36
PK	7.4358G	55.15	74.00	-18.85	41.35	3	Vertical	332	1.22	-	36.67	8.37	31.24
AV	7.44158G	42.21	54.00	-11.79	28.39	3	Vertical	332	1.22	-	36.68	8.38	31.24

2.4-2.4835GHz_BT-LE(1Mbps)

2480MHz_TX

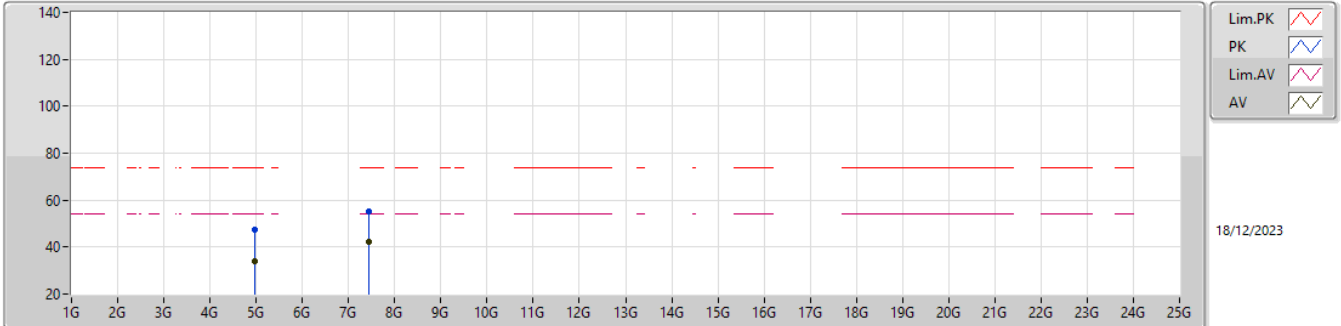

EUT_Y_1TX
Setting 10
06-D-A-4

Type	Freq (Hz)	Level (dBuV/m)	Limit (dBuV/m)	Margin (dB)	Raw (dBuV)	Dist (m)	Condition	Azimuth (°)	Height (m)	Comment	AF (dB)	CL (dB)	PA (dB)
PK	4.9602G	47.26	74.00	-26.74	39.28	3	Horizontal	20	1.67	-	31.54	6.81	30.37
AV	4.96046G	33.73	54.00	-20.27	25.74	3	Horizontal	20	1.67	-	31.54	6.81	30.36
PK	7.44422G	55.28	74.00	-18.72	41.44	3	Horizontal	168	1.05	-	36.69	8.38	31.23
AV	7.44488G	42.32	54.00	-11.68	28.48	3	Horizontal	168	1.05	-	36.69	8.38	31.23

2.4-2.4835GHz_BT-LE(2Mbps)

2402MHz_TX

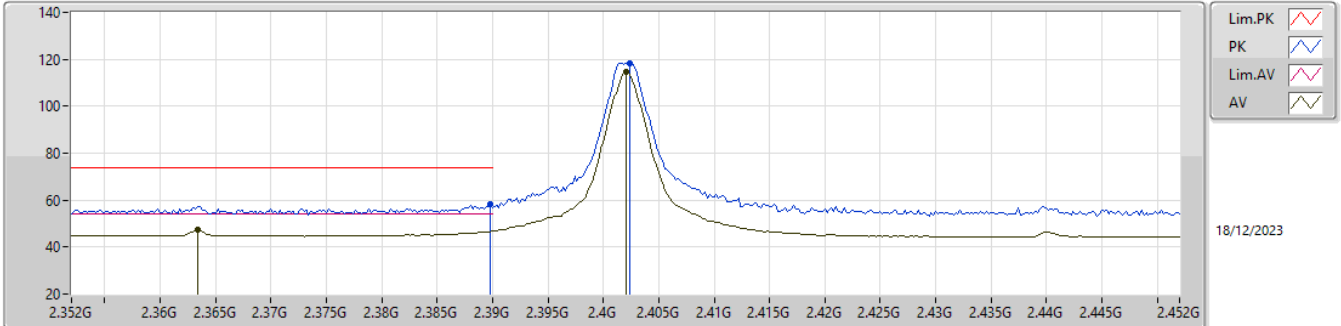

EUT_Y_1TX
Setting 20
06-D-A-4

Type	Freq (Hz)	Level (dBuV/m)	Limit (dBuV/m)	Margin (dB)	Raw (dBuV)	Dist (m)	Condition	Azimuth (°)	Height (m)	Comment	AF (dB)	CL (dB)	PA (dB)
PK	2.3898G	58.14	74.00	-15.86	25.73	3	Vertical	329	2.37	-	27.70	4.71	-
AV	2.3634G	47.16	54.00	-6.84	14.61	3	Vertical	329	2.37	-	27.87	4.68	-
PK	2.4024G	118.40	Inf	-Inf	86.00	3	Vertical	329	2.37	-	27.68	4.72	-
AV	2.402G	114.79	Inf	-Inf	82.39	3	Vertical	329	2.37	-	27.68	4.72	-

2.4-2.4835GHz_BT-LE(2Mbps)

2402MHz_TX

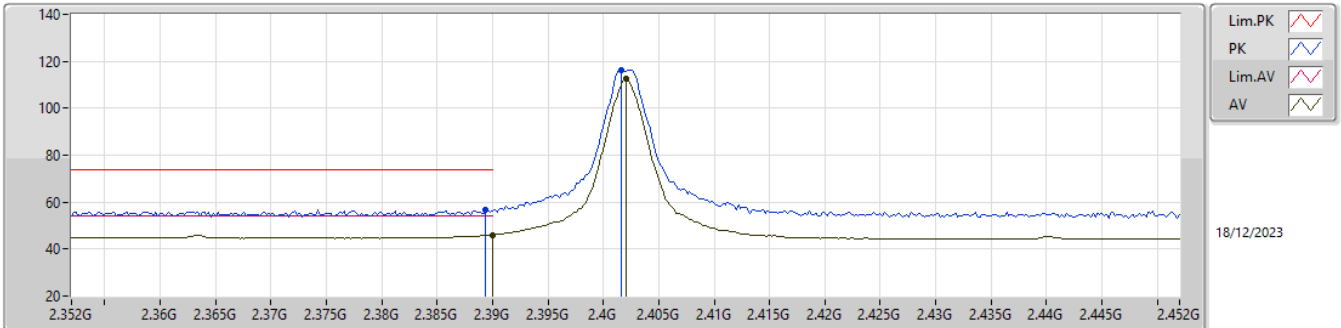

EUT_Y_1TX
Setting 20
06-D-A-4

Type	Freq (Hz)	Level (dBuV/m)	Limit (dBuV/m)	Margin (dB)	Raw (dBuV)	Dist (m)	Condition	Azimuth (°)	Height (m)	Comment	AF (dB)	CL (dB)	PA (dB)
PK	2.3894G	56.65	74.00	-17.35	24.24	3	Horizontal	12	3.00	-	27.70	4.71	-
AV	2.39G	45.97	54.00	-8.03	13.56	3	Horizontal	12	3.00	-	27.70	4.71	-
PK	2.4016G	116.18	Inf	-Inf	83.78	3	Horizontal	12	3.00	-	27.68	4.72	-
AV	2.402G	112.65	Inf	-Inf	80.25	3	Horizontal	12	3.00	-	27.68	4.72	-

2.4-2.4835GHz_BT-LE(2Mbps)

2402MHz_TX

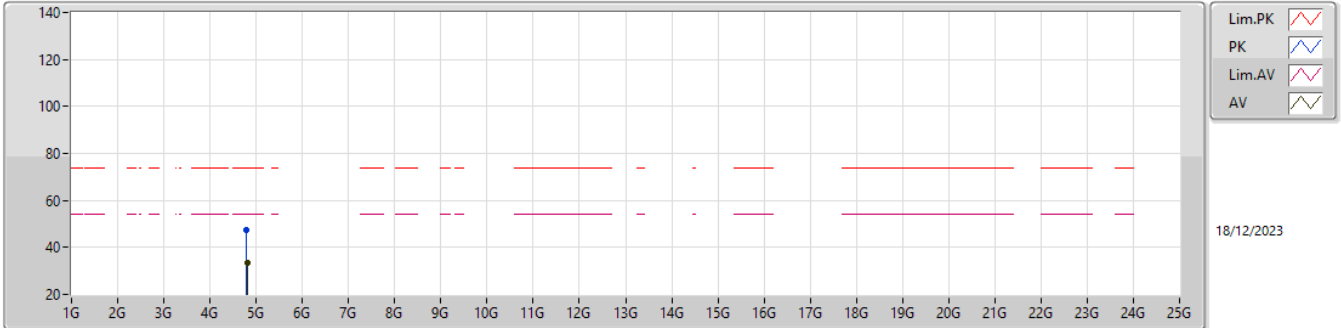

EUT_Y_1TX
Setting 20
06-D-A-4

Type	Freq (Hz)	Level (dBuV/m)	Limit (dBuV/m)	Margin (dB)	Raw (dBuV)	Dist (m)	Condition	Azimuth (°)	Height (m)	Comment	AF (dB)	CL (dB)	PA (dB)
PK	4.79832G	47.36	74.00	-26.64	39.90	3	Vertical	193	1.80	-	31.30	6.67	30.51
AV	4.80648G	33.68	54.00	-20.32	26.20	3	Vertical	193	1.80	-	31.30	6.68	30.50

2.4-2.4835GHz_BT-LE(2Mbps)

2402MHz_TX

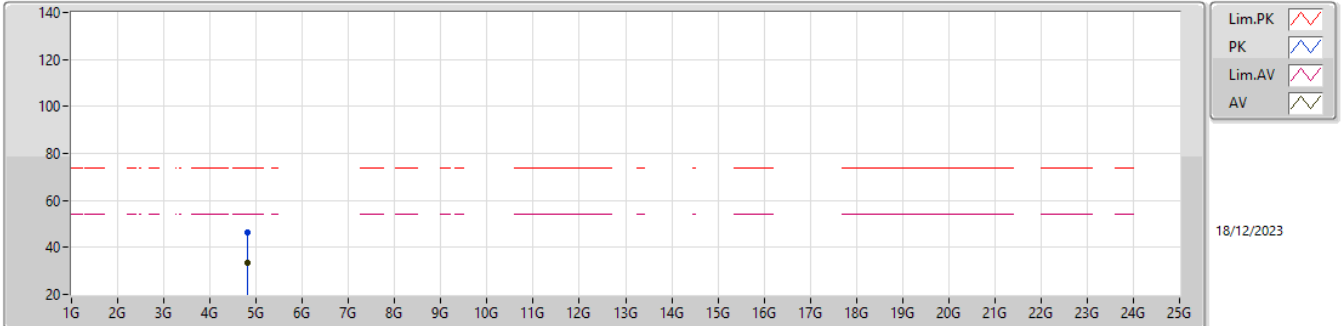

EUT_Y_1TX
Setting 20
06-D-A-4

Type	Freq (Hz)	Level (dBuV/m)	Limit (dBuV/m)	Margin (dB)	Raw (dBuV)	Dist (m)	Condition	Azimuth (°)	Height (m)	Comment	AF (dB)	CL (dB)	PA (dB)
PK	4.80796G	46.62	74.00	-27.38	39.14	3	Horizontal	143	2.16	-	31.30	6.68	30.50
AV	4.81072G	33.65	54.00	-20.35	26.17	3	Horizontal	143	2.16	-	31.30	6.68	30.50

2.4-2.4835GHz_BT-LE(2Mbps)

2440MHz_TX

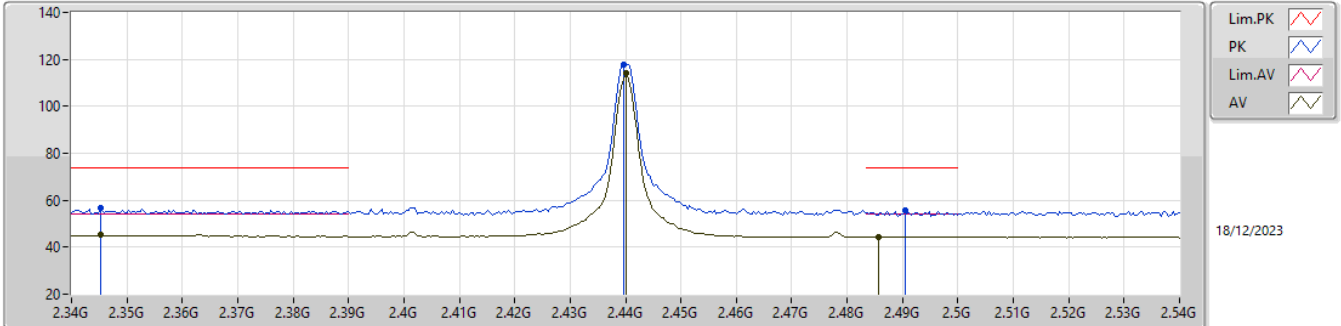

EUT_Y_1TX
Setting 20
06-D-A-4

Type	Freq (Hz)	Level (dBuV/m)	Limit (dBuV/m)	Margin (dB)	Raw (dBuV)	Dist (m)	Condition	Azimuth (°)	Height (m)	Comment	AF (dB)	CL (dB)	PA (dB)
PK	2.3452G	56.66	74.00	-17.34	24.10	3	Vertical	327	2.88	-	27.90	4.66	-
AV	2.3452G	45.17	54.00	-8.83	12.61	3	Vertical	327	2.88	-	27.90	4.66	-
PK	2.4396G	117.90	Inf	-Inf	85.64	3	Vertical	327	2.88	-	27.50	4.76	-
AV	2.44G	114.12	Inf	-Inf	81.86	3	Vertical	327	2.88	-	27.50	4.76	-
PK	2.4904G	55.62	74.00	-18.38	23.42	3	Vertical	327	2.88	-	27.40	4.80	-
AV	2.4856G	44.49	54.00	-9.51	12.29	3	Vertical	327	2.88	-	27.40	4.80	-

2.4-2.4835GHz_BT-LE(2Mbps)

2440MHz_TX

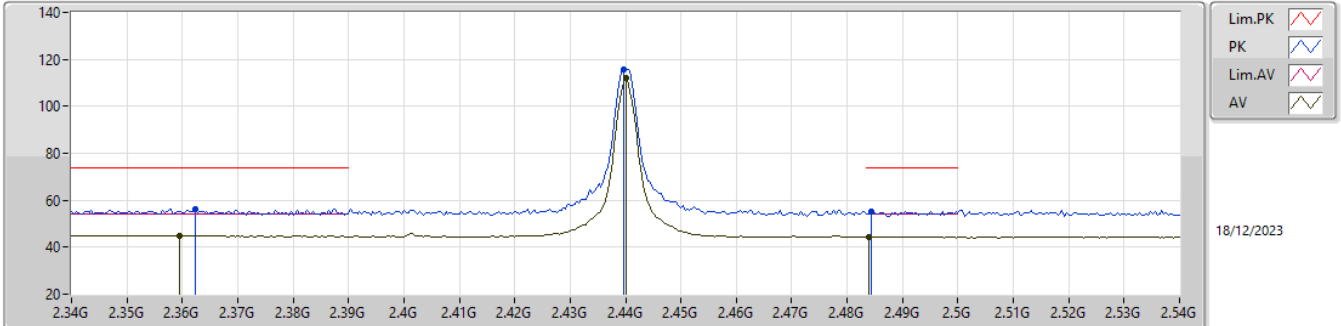

EUT_Y_1TX
Setting 20
06-D-A-4

Type	Freq (Hz)	Level (dBuV/m)	Limit (dBuV/m)	Margin (dB)	Raw (dBuV)	Dist (m)	Condition	Azimuth (°)	Height (m)	Comment	AF (dB)	CL (dB)	PA (dB)
PK	2.3624G	56.09	74.00	-17.91	23.53	3	Horizontal	10	2.94	-	27.88	4.68	-
AV	2.3596G	45.02	54.00	-8.98	12.44	3	Horizontal	10	2.94	-	27.90	4.68	-
PK	2.4396G	115.64	Inf	-Inf	83.38	3	Horizontal	10	2.94	-	27.50	4.76	-
AV	2.44G	112.18	Inf	-Inf	79.92	3	Horizontal	10	2.94	-	27.50	4.76	-
PK	2.4844G	55.41	74.00	-18.59	23.21	3	Horizontal	10	2.94	-	27.40	4.80	-
AV	2.484G	44.36	54.00	-9.64	12.16	3	Horizontal	10	2.94	-	27.40	4.80	-

2.4-2.4835GHz_BT-LE(2Mbps)

2440MHz_TX

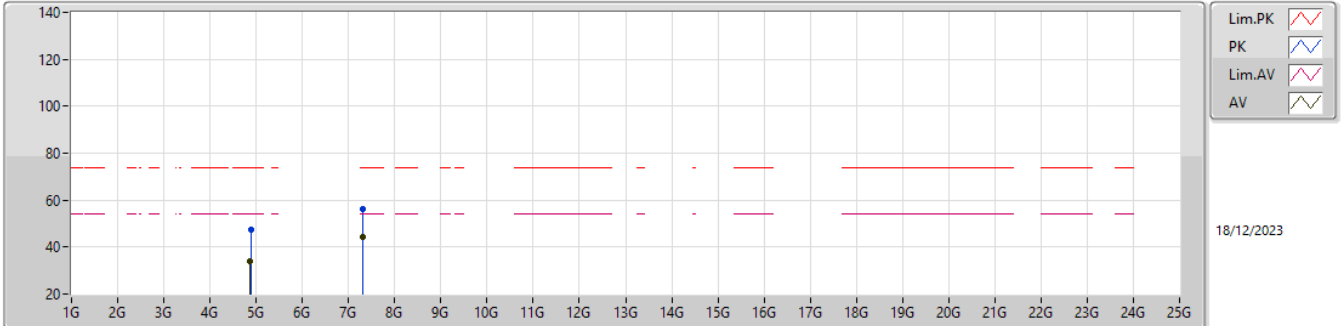

EUT_Y_1TX
Setting 20
06-D-A-4

Type	Freq (Hz)	Level (dBuV/m)	Limit (dBuV/m)	Margin (dB)	Raw (dBuV)	Dist (m)	Condition	Azimuth (°)	Height (m)	Comment	AF (dB)	CL (dB)	PA (dB)
PK	4.88104G	47.66	74.00	-26.34	40.05	3	Vertical	360	1.80	-	31.30	6.74	30.43
AV	4.87536G	34.03	54.00	-19.97	26.44	3	Vertical	360	1.80	-	31.30	6.73	30.44
PK	7.31868G	56.39	74.00	-17.61	42.83	3	Vertical	356	2.49	-	36.60	8.34	31.38
AV	7.31882G	44.49	54.00	-9.51	30.93	3	Vertical	356	2.49	-	36.60	8.34	31.38

2.4-2.4835GHz_BT-LE(2Mbps)

2440MHz_TX

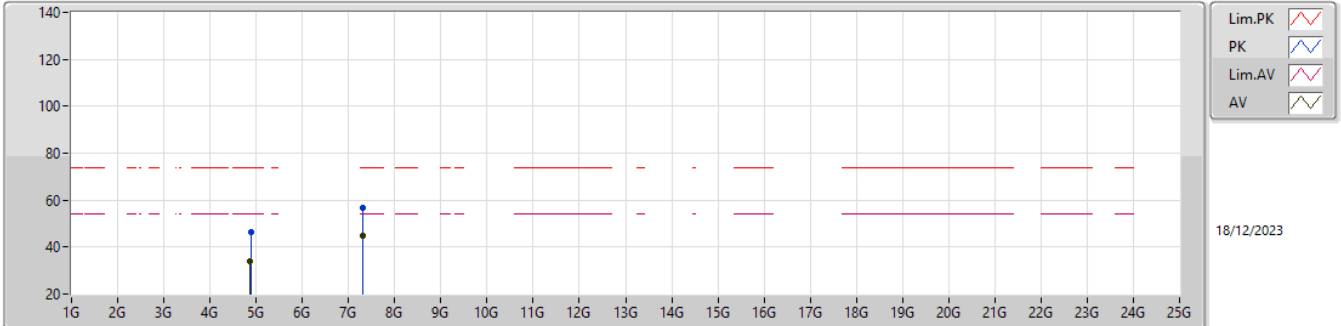

EUT_Y_1TX
Setting 20
06-D-A-4

Type	Freq (Hz)	Level (dBuV/m)	Limit (dBuV/m)	Margin (dB)	Raw (dBuV)	Dist (m)	Condition	Azimuth (°)	Height (m)	Comment	AF (dB)	CL (dB)	PA (dB)
PK	4.88112G	46.59	74.00	-27.41	38.98	3	Horizontal	359	1.80	-	31.30	6.74	30.43
AV	4.87714G	33.76	54.00	-20.24	26.16	3	Horizontal	359	1.80	-	31.30	6.74	30.44
PK	7.32164G	56.70	74.00	-17.30	43.14	3	Horizontal	313	1.80	-	36.60	8.34	31.38
AV	7.31882G	44.83	54.00	-9.17	31.27	3	Horizontal	313	1.80	-	36.60	8.34	31.38

2.4-2.4835GHz_BT-LE(2Mbps)

2478MHz_TX

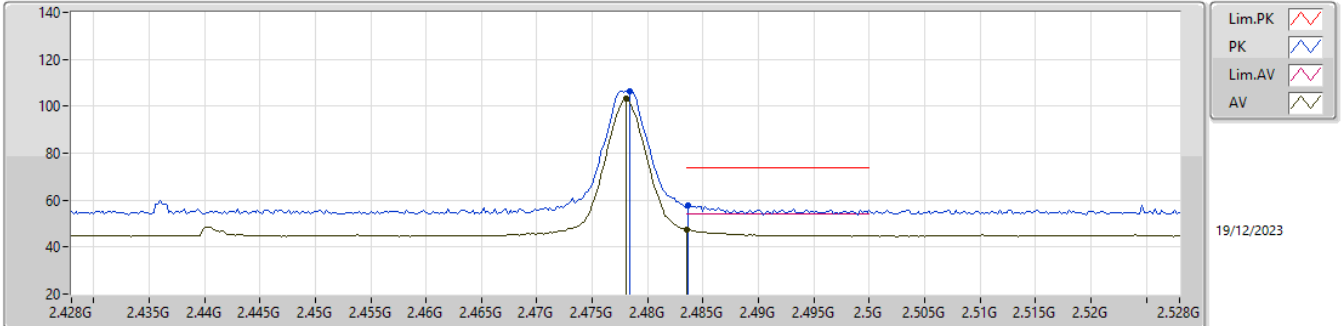

EUT_Y_1TX
Setting 20
06-D-S-4

Type	Freq (Hz)	Level (dBuV/m)	Limit (dBuV/m)	Margin (dB)	Raw (dBuV)	Dist (m)	Condition	Azimuth (°)	Height (m)	Comment	AF (dB)	CL (dB)	PA (dB)
PK	2.4784G	106.21	Inf	-Inf	74.02	3	Vertical	328	1.00	-	27.40	4.79	-
AV	2.478G	103.04	Inf	-Inf	70.85	3	Vertical	328	1.00	-	27.40	4.79	-
PK	2.4836G	57.62	74.00	-16.38	25.42	3	Vertical	328	1.00	-	27.40	4.80	-
AV	2.4835G	47.41	54.00	-6.59	15.21	3	Vertical	328	1.00	-	27.40	4.80	-

2.4-2.4835GHz_BT-LE(2Mbps)

2478MHz_TX

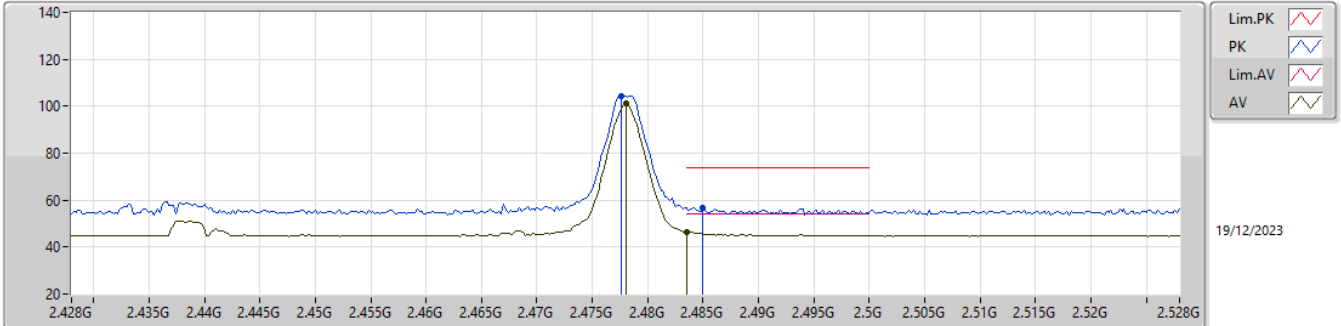

EUT_Y_1TX
Setting 20
06-D-S-4

Type	Freq (Hz)	Level (dBuV/m)	Limit (dBuV/m)	Margin (dB)	Raw (dBuV)	Dist (m)	Condition	Azimuth (°)	Height (m)	Comment	AF (dB)	CL (dB)	PA (dB)
PK	2.4776G	104.41	Inf	-Inf	72.22	3	Horizontal	11	2.88	-	27.40	4.79	-
AV	2.478G	101.01	Inf	-Inf	68.82	3	Horizontal	11	2.88	-	27.40	4.79	-
PK	2.485G	56.76	74.00	-17.24	24.56	3	Horizontal	11	2.88	-	27.40	4.80	-
AV	2.4835G	46.47	54.00	-7.53	14.27	3	Horizontal	11	2.88	-	27.40	4.80	-

2.4-2.4835GHz_BT-LE(2Mbps)

2478MHz_TX

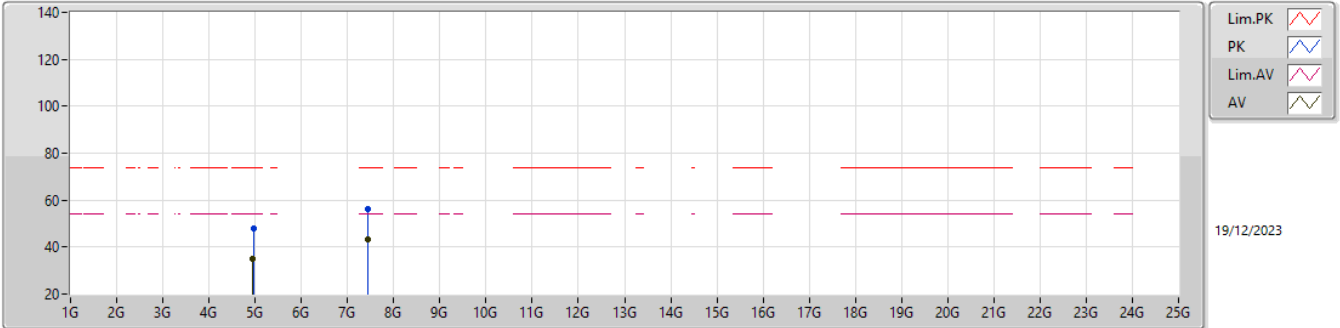

EUT_Y_1TX
Setting 20
06-D-S-4

Type	Freq (Hz)	Level (dBuV/m)	Limit (dBuV/m)	Margin (dB)	Raw (dBuV)	Dist (m)	Condition	Azimuth (°)	Height (m)	Comment	AF (dB)	CL (dB)	PA (dB)
PK	4.9564G	47.83	74.00	-26.17	39.87	3	Vertical	135	2.32	-	31.53	6.80	30.37
AV	4.95562G	34.82	54.00	-19.18	26.87	3	Vertical	135	2.32	-	31.52	6.80	30.37
PK	7.43439G	55.98	74.00	-18.02	42.19	3	Vertical	53	1.43	-	36.67	8.37	31.25
AV	7.43387G	43.15	54.00	-10.85	29.36	3	Vertical	53	1.43	-	36.67	8.37	31.25

2.4-2.4835GHz_BT-LE(2Mbps)

2478MHz_TX

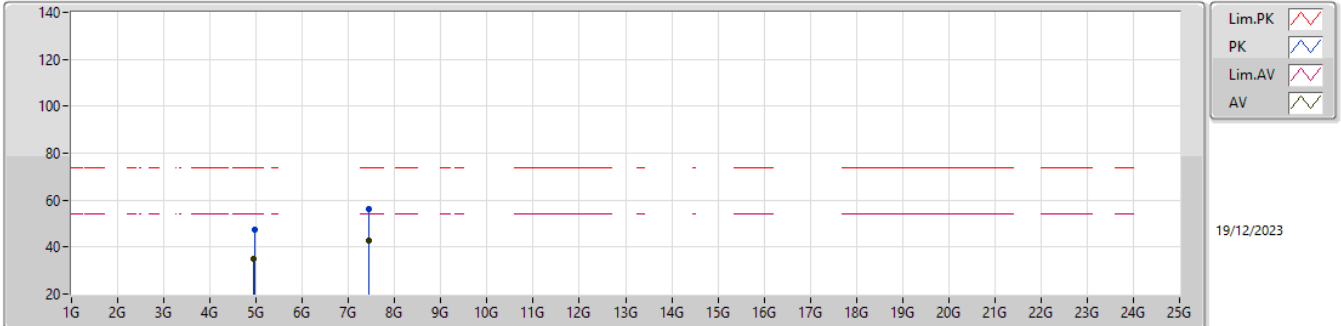

EUT_Y_1TX
Setting 20
06-D-S-4

Type	Freq (Hz)	Level (dBuV/m)	Limit (dBuV/m)	Margin (dB)	Raw (dBuV)	Dist (m)	Condition	Azimuth (°)	Height (m)	Comment	AF (dB)	CL (dB)	PA (dB)
PK	4.9562G	47.66	74.00	-26.34	39.71	3	Horizontal	308	1.57	-	31.52	6.80	30.37
AV	4.95555G	34.95	54.00	-19.05	27.00	3	Horizontal	308	1.57	-	31.52	6.80	30.37
PK	7.43438G	56.10	74.00	-17.90	42.31	3	Horizontal	115	1.32	-	36.67	8.37	31.25
AV	7.4338G	42.93	54.00	-11.07	29.14	3	Horizontal	115	1.32	-	36.67	8.37	31.25

2.4-2.4835GHz_BT-LE(2Mbps)

2480MHz_TX

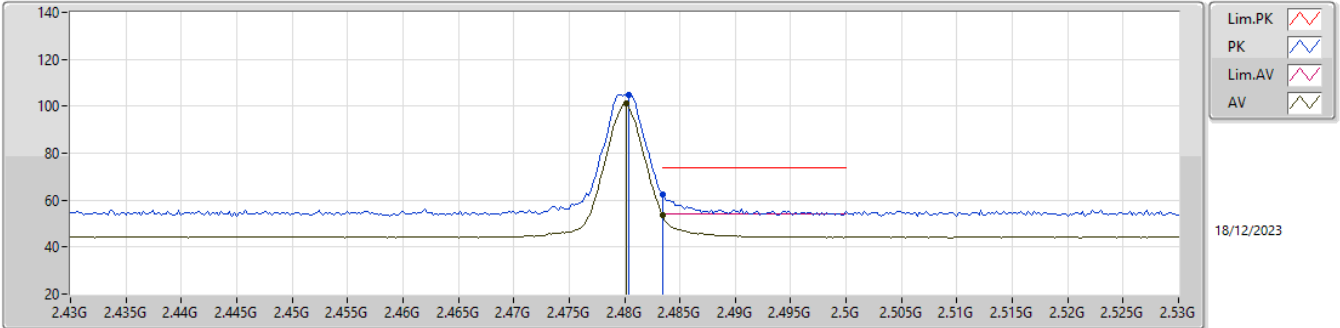

EUT_Y_1TX
Setting 8
06-D-A-4

Type	Freq (Hz)	Level (dBuV/m)	Limit (dBuV/m)	Margin (dB)	Raw (dBuV)	Dist (m)	Condition	Azimuth (°)	Height (m)	Comment	AF (dB)	CL (dB)	PA (dB)
PK	2.4804G	104.82	Inf	-Inf	72.63	3	Vertical	326	2.48	-	27.40	4.79	-
AV	2.4802G	101.15	Inf	-Inf	68.96	3	Vertical	326	2.48	-	27.40	4.79	-
PK	2.4835G	62.33	74.00	-11.67	30.13	3	Vertical	326	2.48	-	27.40	4.80	-
AV	2.4835G	53.64	54.00	-0.36	21.44	3	Vertical	326	2.48	-	27.40	4.80	-

2.4-2.4835GHz_BT-LE(2Mbps)

2480MHz_TX

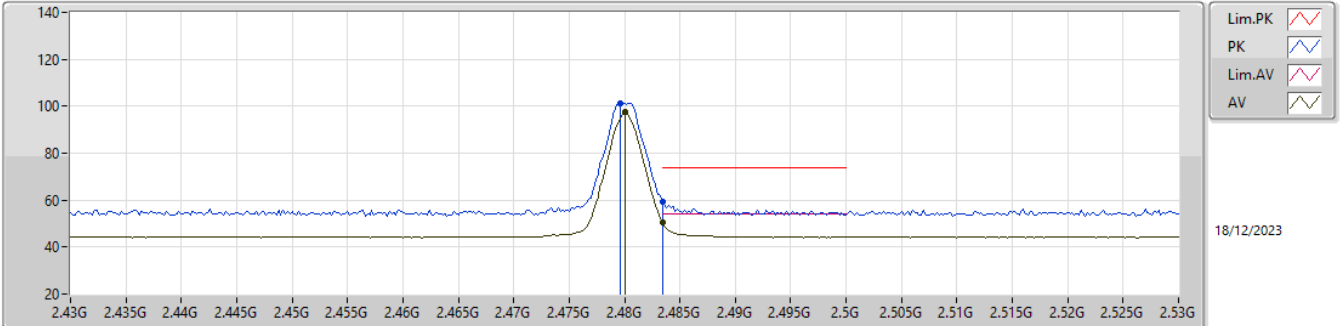

EUT_Y_1TX
Setting 8
06-D-A-4

Type	Freq (Hz)	Level (dBuV/m)	Limit (dBuV/m)	Margin (dB)	Raw (dBuV)	Dist (m)	Condition	Azimuth (°)	Height (m)	Comment	AF (dB)	CL (dB)	PA (dB)
PK	2.4796G	101.23	Inf	-Inf	69.04	3	Horizontal	15	2.86	-	27.40	4.79	-
AV	2.48G	97.66	Inf	-Inf	65.47	3	Horizontal	15	2.86	-	27.40	4.79	-
PK	2.4835G	59.37	74.00	-14.63	27.17	3	Horizontal	15	2.86	-	27.40	4.80	-
AV	2.4835G	50.42	54.00	-3.58	18.22	3	Horizontal	15	2.86	-	27.40	4.80	-

2.4-2.4835GHz_BT-LE(2Mbps)

2480MHz_TX

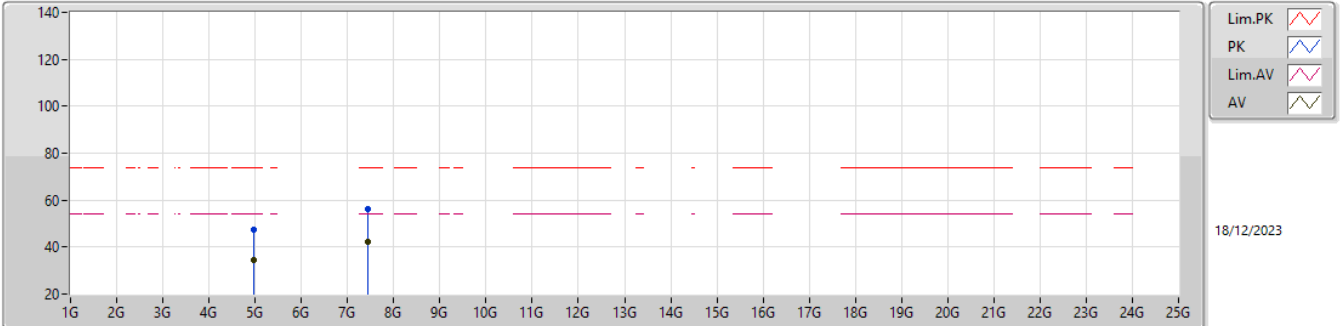

EUT_Y_1TX
Setting 8
06-D-A-4

Type	Freq (Hz)	Level (dBuV/m)	Limit (dBuV/m)	Margin (dB)	Raw (dBuV)	Dist (m)	Condition	Azimuth (°)	Height (m)	Comment	AF (dB)	CL (dB)	PA (dB)
PK	4.9613G	47.49	74.00	-26.51	39.49	3	Vertical	359	1.80	-	31.55	6.81	30.36
AV	4.96232G	34.33	54.00	-19.67	26.33	3	Vertical	359	1.80	-	31.55	6.81	30.36
PK	7.44224G	56.35	74.00	-17.65	42.53	3	Vertical	10	1.80	-	36.68	8.38	31.24
AV	7.44034G	42.47	54.00	-11.53	28.65	3	Vertical	10	1.80	-	36.68	8.38	31.24

2.4-2.4835GHz_BT-LE(2Mbps)

2480MHz_TX

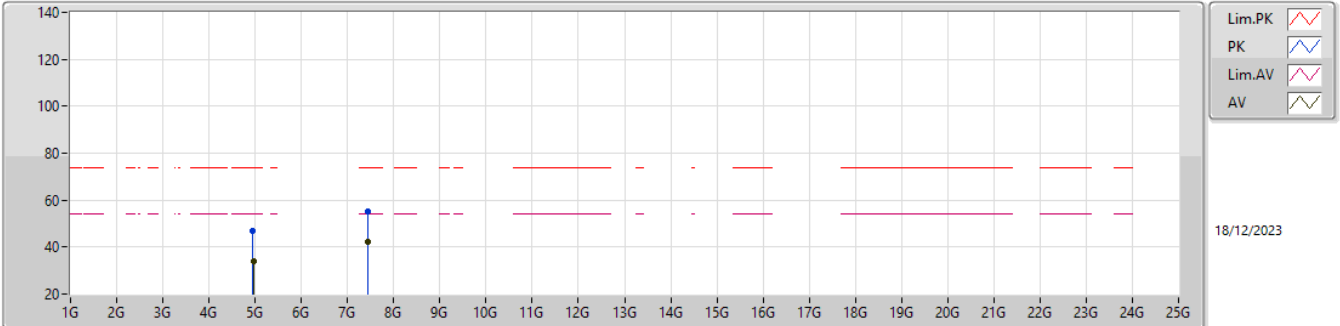

EUT_Y_1TX
Setting 8
06-D-A-4

Type	Freq (Hz)	Level (dBuV/m)	Limit (dBuV/m)	Margin (dB)	Raw (dBuV)	Dist (m)	Condition	Azimuth (°)	Height (m)	Comment	AF (dB)	CL (dB)	PA (dB)
PK	4.95598G	47.06	74.00	-26.94	39.11	3	Horizontal	320	2.75	-	31.52	6.80	30.37
AV	4.95694G	34.00	54.00	-20.00	26.04	3	Horizontal	320	2.75	-	31.53	6.80	30.37
PK	7.4414G	55.43	74.00	-18.57	41.61	3	Horizontal	124	1.51	-	36.68	8.38	31.24
AV	7.43596G	42.24	54.00	-11.76	28.44	3	Horizontal	124	1.51	-	36.67	8.37	31.24