

Cambium XV2-21X Antenna Test Report Vt00d

DVT Report



Antenna Team
December 27, 2022

Antenna Set Definition

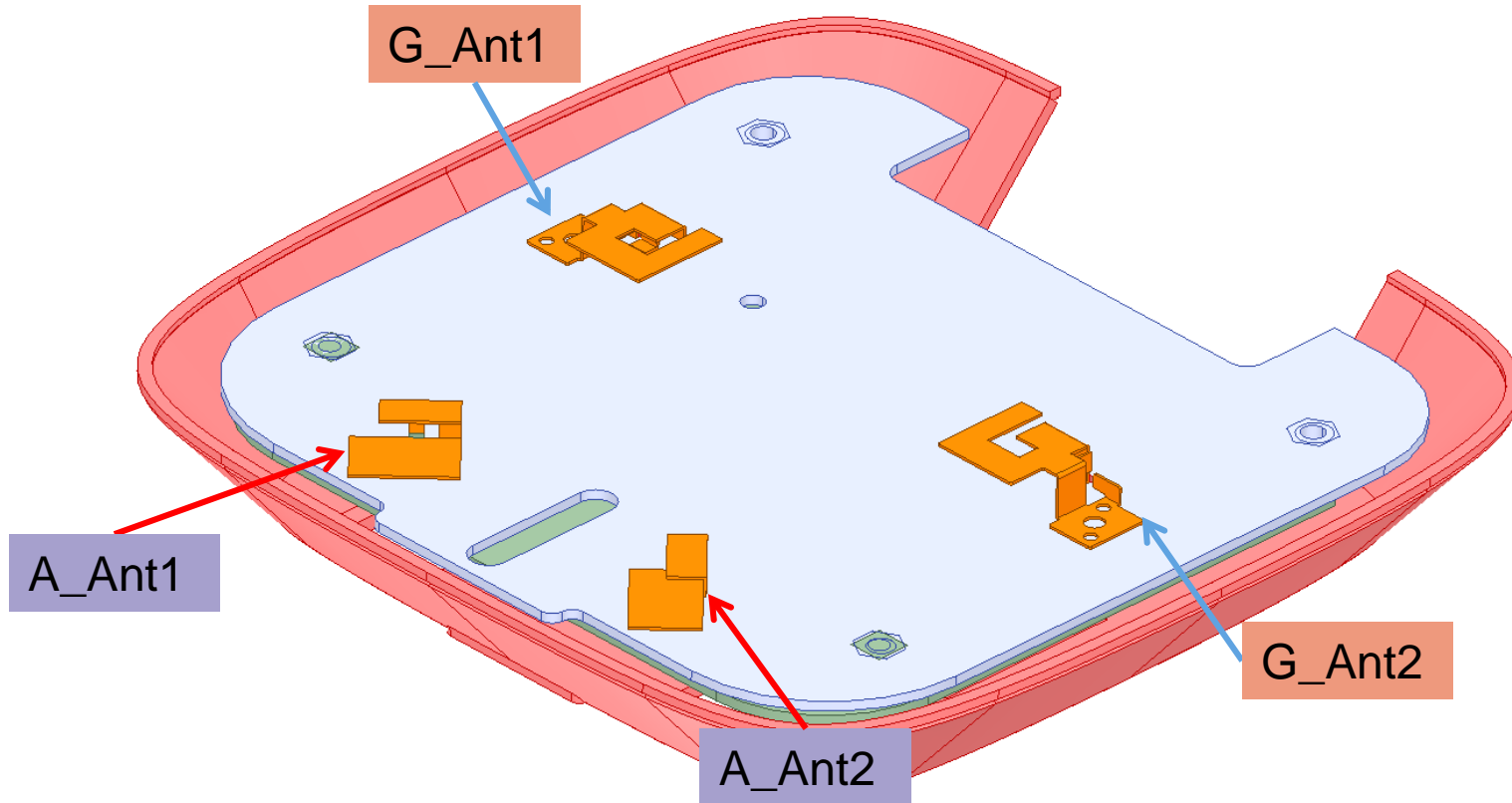

G Band Antenna Return Loss & Isolation

G_Ant2

5/11/2022 9:58:22 AM
1334.3330K44-101440-be

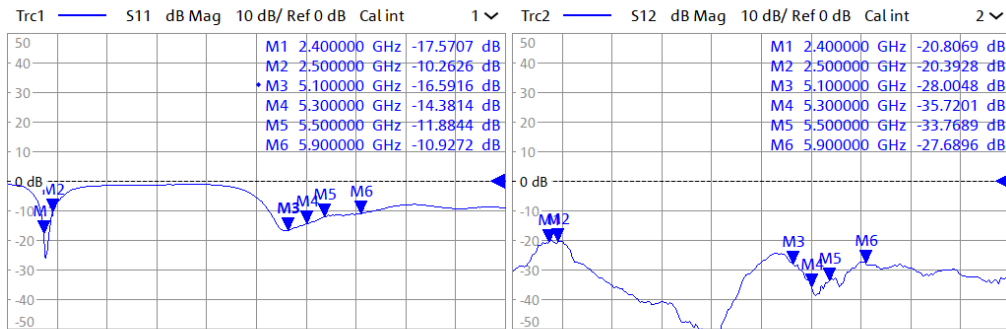

Ch1 Start 2 GHz Pwr -10 dBm Bw 10 kHz Stop 7.5 GHz Ch1 Start 2 GHz Pwr -10 dBm Bw 10 kHz Stop 7.5 GHz

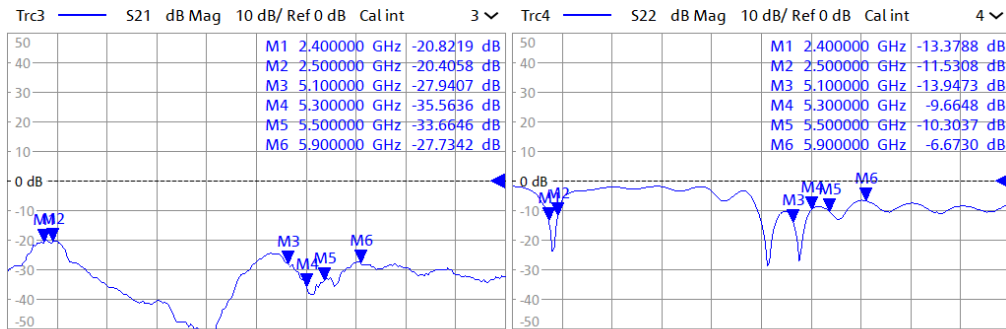

Ch1 Start 2 GHz Pwr -10 dBm Bw 10 kHz Stop 7.5 GHz Ch1 Start 2 GHz Pwr -10 dBm Bw 10 kHz Stop 7.5 GHz

G_Ant1

A Band Antenna Return Loss & Isolation

A_Ant2

5/11/2022 9:57:25 AM
1334.3330K44-101440-be

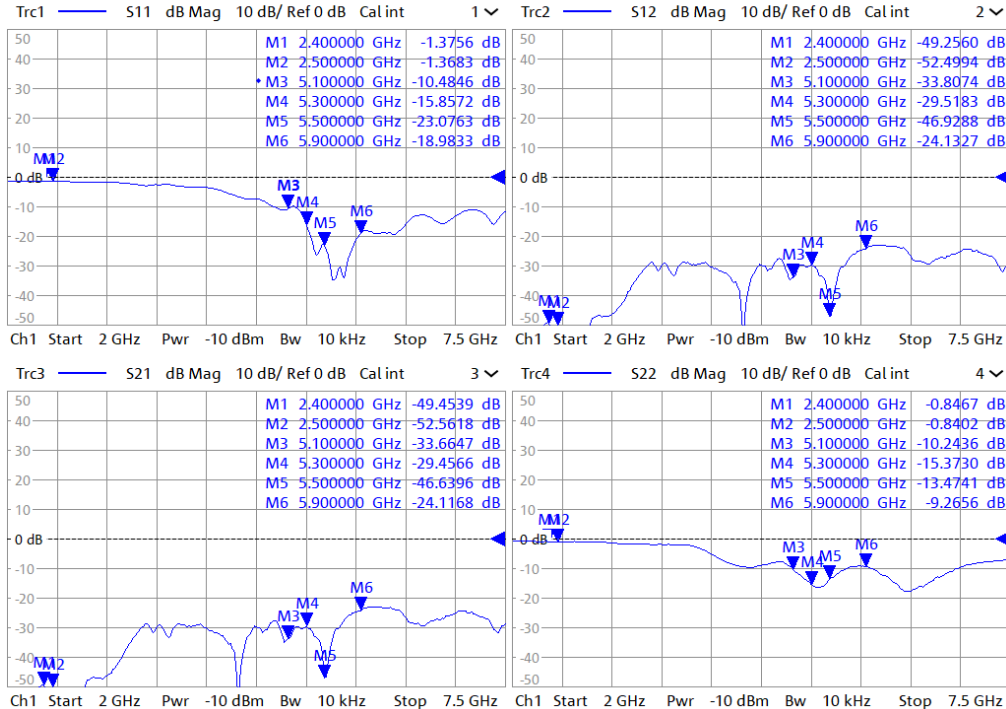

A_Ant1

Antenna Coordinate System Definition

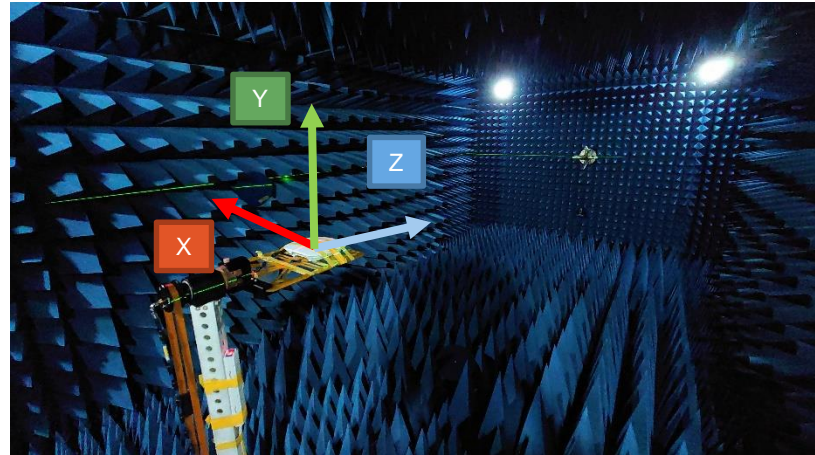
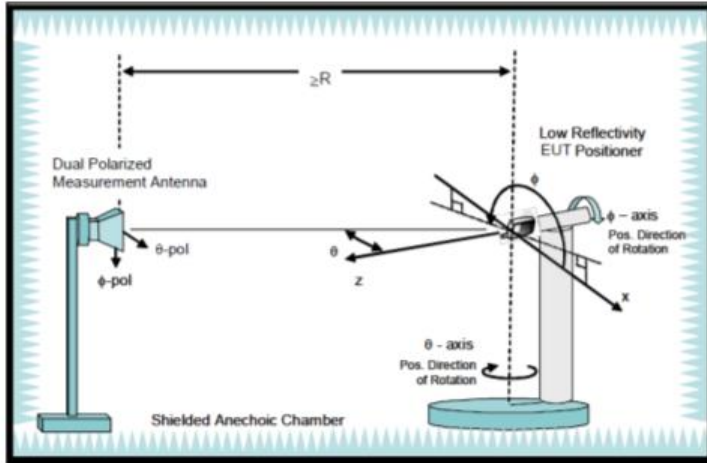

G_ANT1 Gain Total (dBi) Pattern

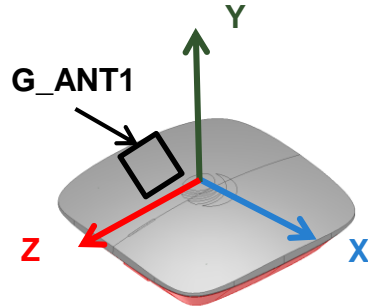
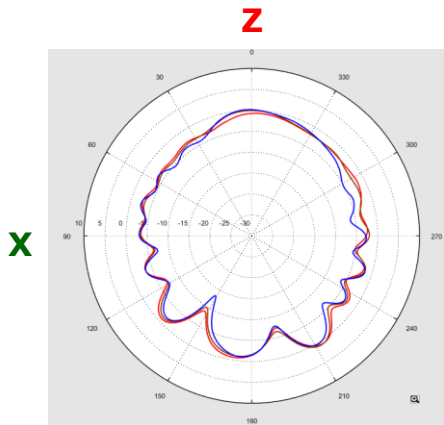

2400MHz ———
2450MHz ———
2500MHz ———

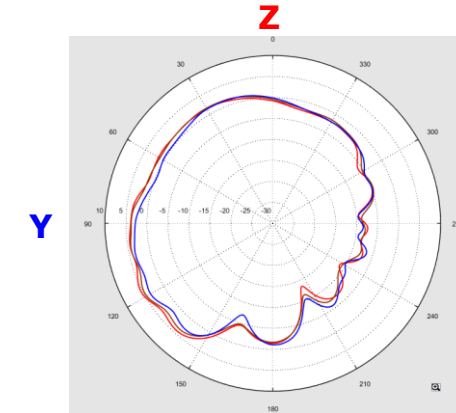
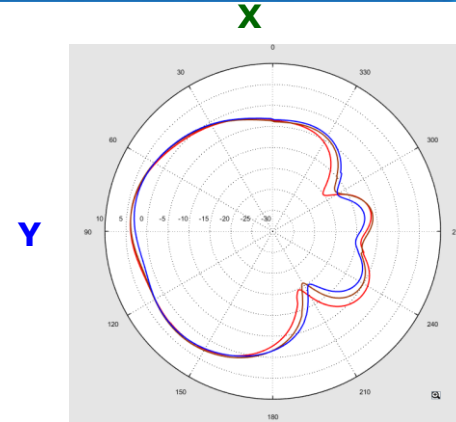

G_ANT2 Gain Total (dBi) Pattern

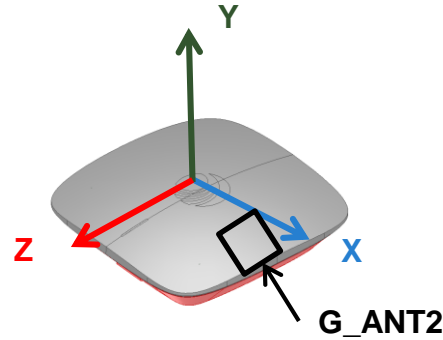
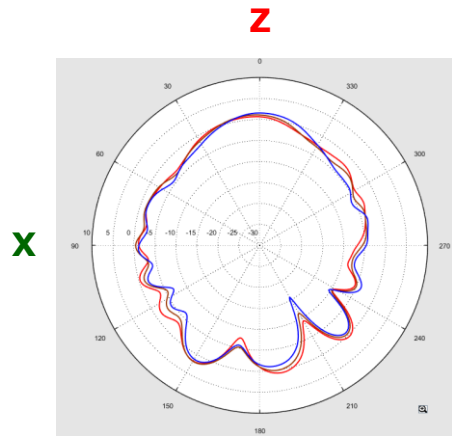

2400MHz ———
2450MHz ———
2500MHz ———

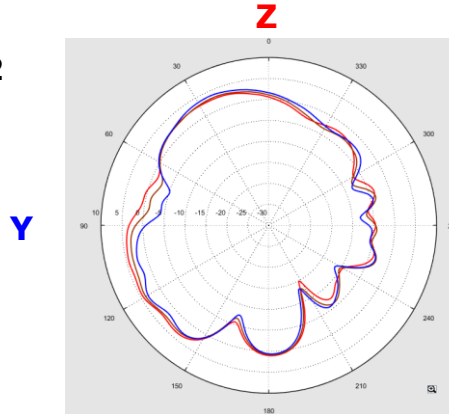
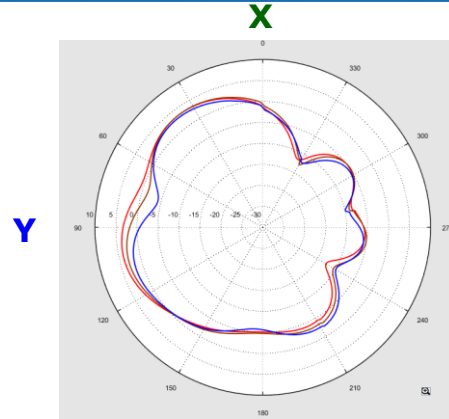

A_ANT1 Gain Total (dBi) Pattern

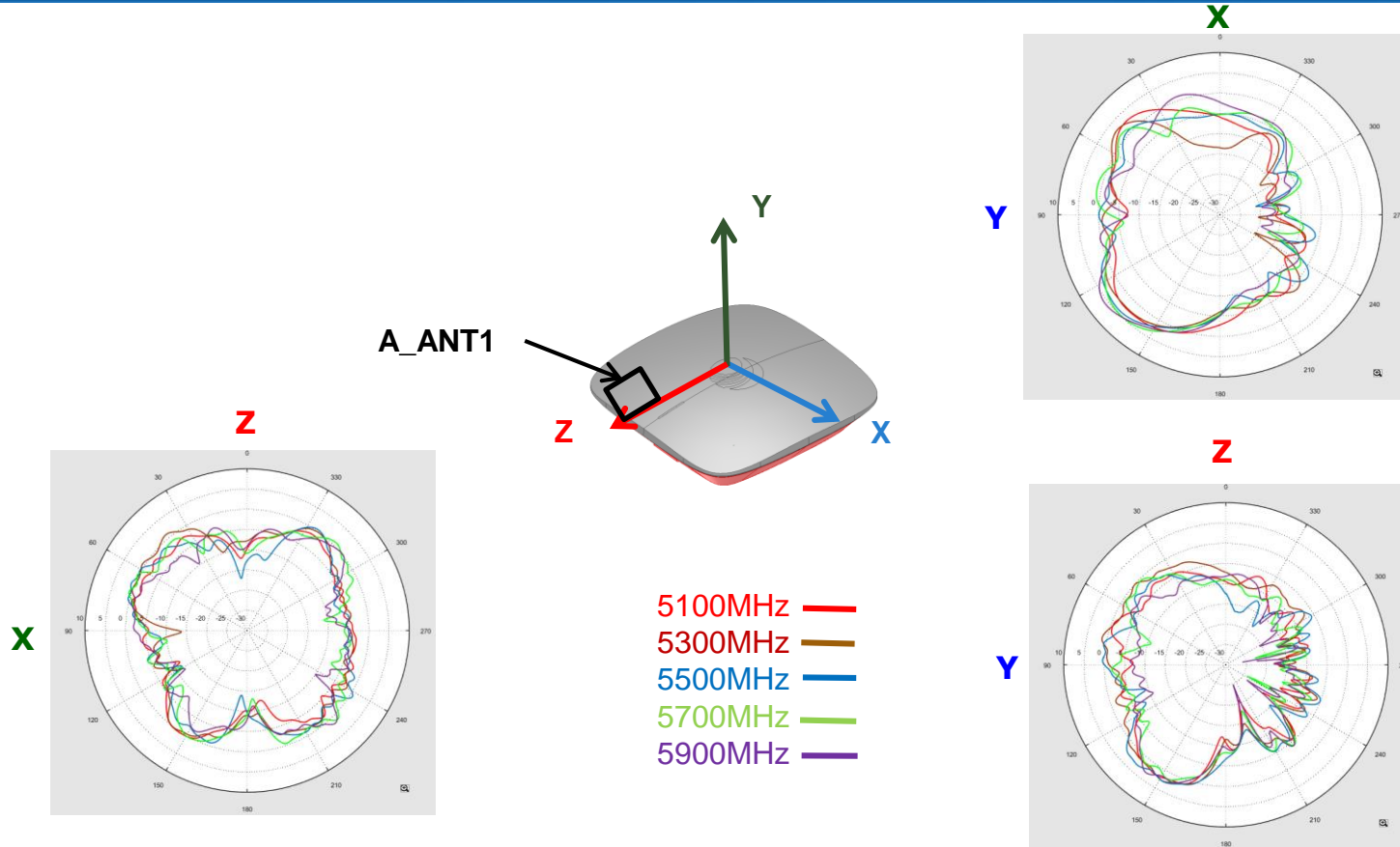

A_ANT2 Gain Total (dBi) Pattern

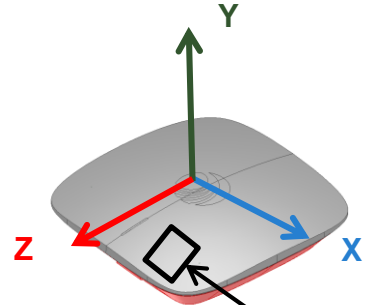
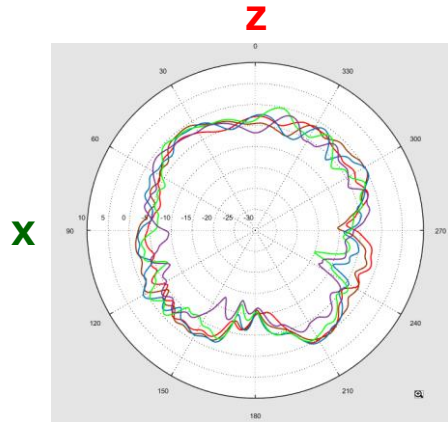

- A_ANT2
- 5100MHz — (Red line)
 - 5300MHz — (Brown line)
 - 5500MHz — (Blue line)
 - 5700MHz — (Green line)
 - 5900MHz — (Purple line)

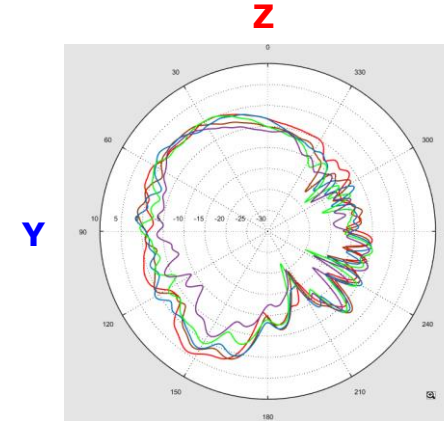
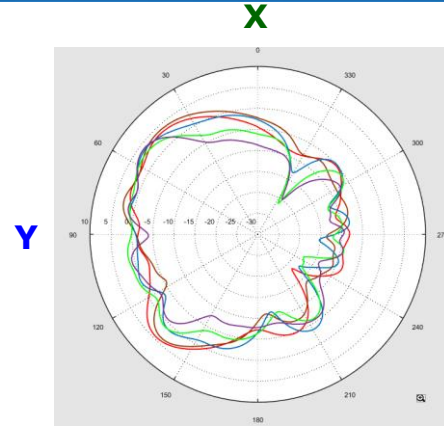

G_ANT Composite Gain Total (dBi) Pattern

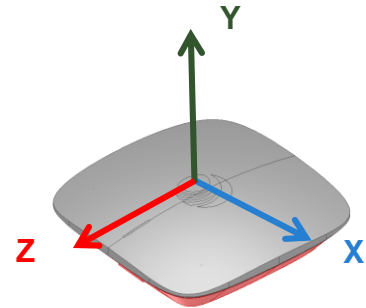
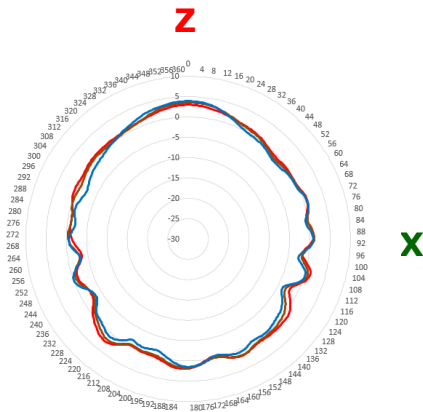

- 2400MHz — (red line)
- 2450MHz — (brown line)
- 2500MHz — (blue line)

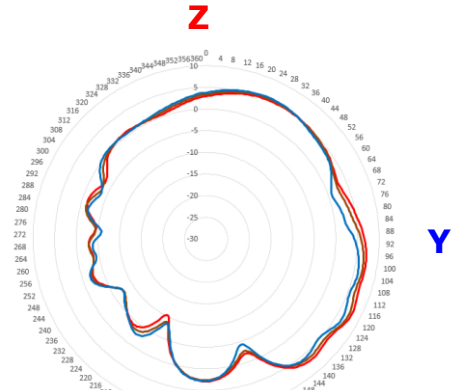
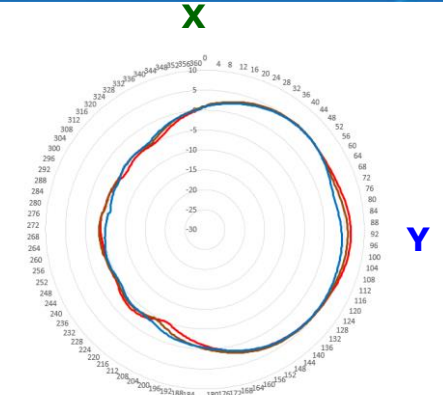

A_ANT Composite Gain Total (dBi) Pattern

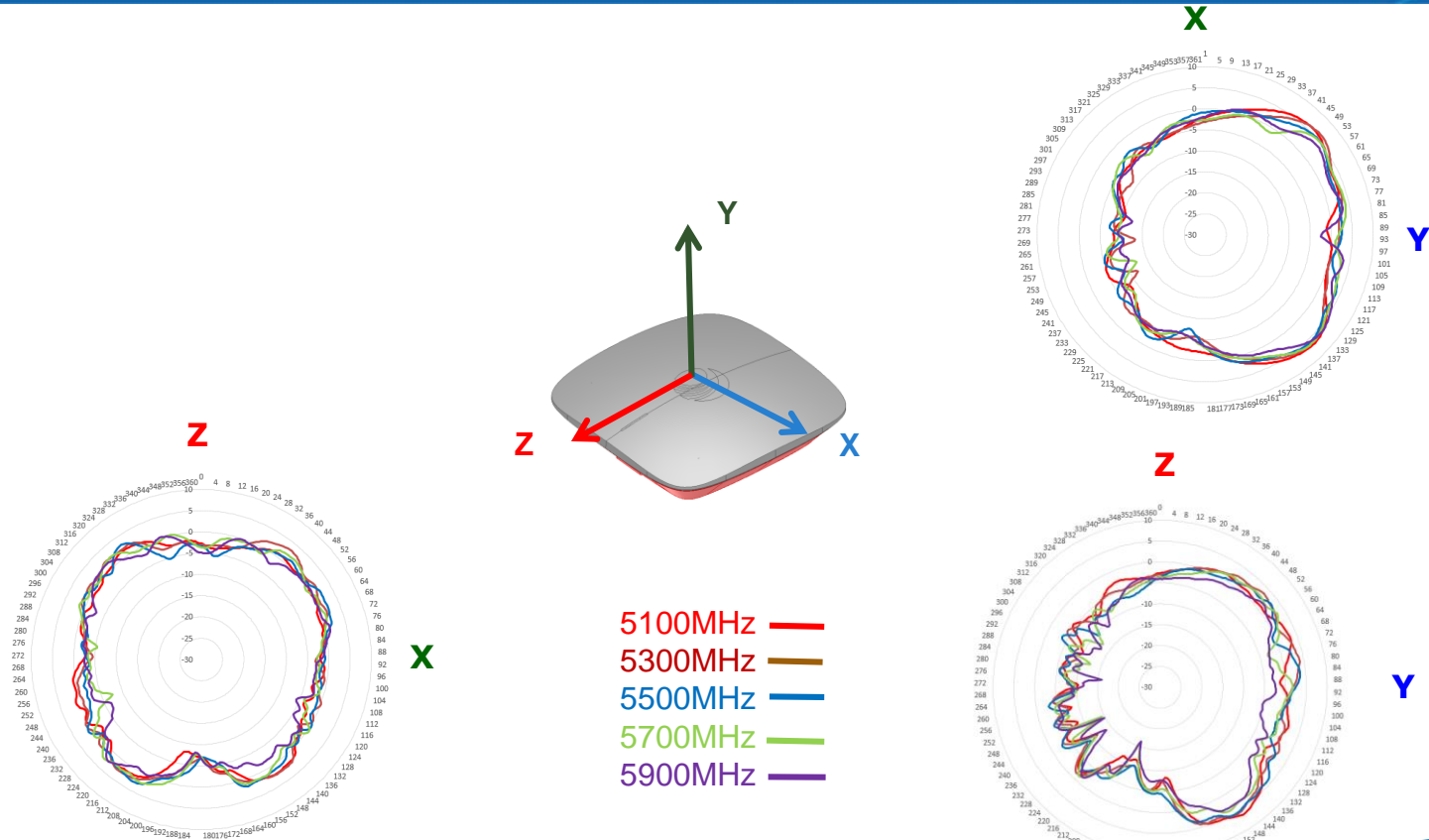

Antenna 2.4G /5G Efficiency

WIFI G Band Antenna Efficiency (%)

Frequency (MHz)	2400	2450	2500
G_ANT1 (Cable Loss : 0.6dB)	83.7	79.3	77.4
G_ANT2 (Cable Loss : 0.35dB)	80.1	77.4	66.4

WIFI A Band Antenna Efficiency (%)

Frequency (MHz)	5100	5300	5500	5700	5900
A_ANT1(Cable Loss : 0.9 dB)	70	80.3	84	86	81
A_ANT2(Cable Loss : 0.4 dB)	81.5	86.5	82.4	79.4	60.7

Noted: The antenna gain excludes the cable loss, Cable Loss is refer to D1.13 low loss cable datasheet, the attenuation at 5GHz is 4.5 dB per meter.(including IPEX PLUG)

Antenna (2.4G/5G) Peak gain

WIFI G Band Antenna Peak Gain (dBi)			
Frequency (MHz)	2400	2450	2500
G_ANT1 (Cable Loss : 0.6dB)	5.65	5.17	4.3
Peak Gain @	Theta:120/Phi:90	Theta:120/Phi:75	Theta:105/Phi:90
G_ANT2 (Cable Loss : 0.35dB)	5	4.43	4.47
Peak Gain @	Theta:105/Phi:90	Theta:120/Phi:105	Theta:120/Phi:120

WIFI A Band Antenna Peak Gain(dBi)					
Frequency (MHz)	5100	5300	5500	5700	5900
A_ANT1(Cable Loss : 0.9 dB)	6.32	7.2	6.57	7.76	7.79
Peak Gain @	Theta:135/Phi:45	Theta:135/Phi:45	Theta:135/Phi:45	Theta:150/Phi:60	Theta:105/Phi:125
A_ANT2(Cable Loss : 0.4 dB)	6.92	6.89	8.16	8.15	7.48
Peak Gain @	Theta:135/Phi:135	Theta:135/Phi:135	Theta:150/Phi:135	Theta:150/Phi:135	Theta:150/Phi:135

Noted: The antenna gain excludes the cable loss, Cable Loss is refer to D1.13 low loss cable datasheet, the attenuation at 2.4GHz is 3.2dB per meter.(including IPEX PLUG)

Measurement Environment

Chamber type	Operation Band: 700 MHz ~ 18 GHz Chamber Size: 7m(L) * 3.5m(W) * 3.5m(H) 		
Antenna type	Types of measurement antennas (Frequency Range)		
Test Equipment	Instrument	Brand	Model No.
	VNA	ROHDE & SCHWARZ	ZNB8

Measurement Environment (cont'd)

Coordinate definition

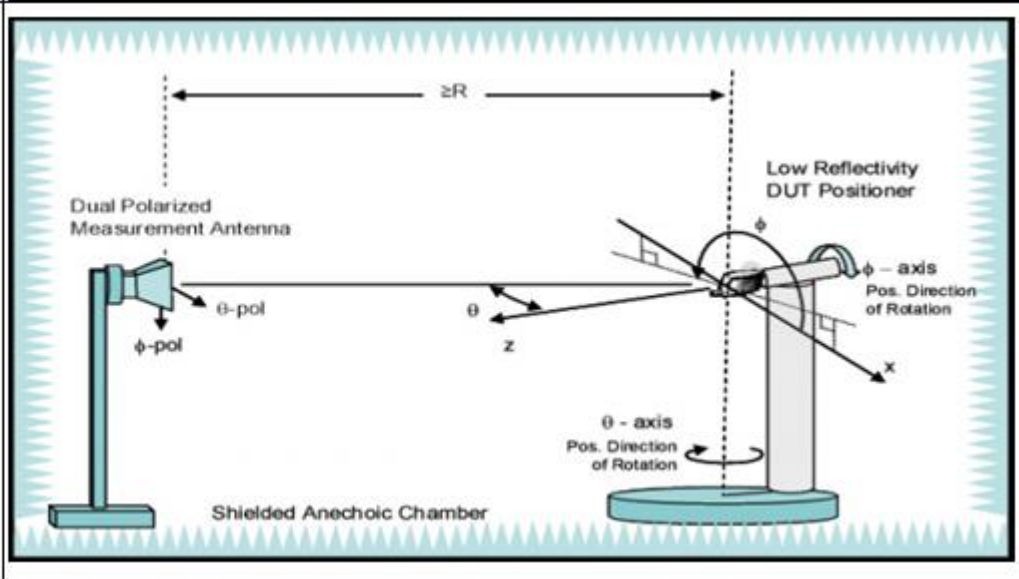

Test method / Test Procedure

- Measurement Method

Absolute gain

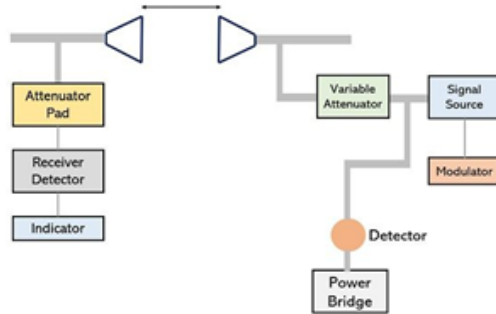

Suppose the two antennas (transmitting and receiving) are separated at a distance r . Here, P_t and P_r represent the transmitted and received power respectively. While A_{et} and A_{er} are the effective apertures of transmitting and receiving antennas.

As the two antennas are identical. Therefore, $A_{et} = A_{er} = \frac{G_0 \lambda^2}{4\pi}$

By Friis's transmission equation, $\frac{P_r}{P_t} = \left(\frac{A_{et} A_{er}}{\lambda^2 r^2}\right) = \left(\frac{G_0 \lambda^2}{4\pi}\right) \left(\frac{G_0 \lambda^2}{4\pi}\right) \frac{1}{\lambda^2 r^2}$

Test method / Test Procedure (cont'd)

$$\frac{P_r}{P_t} = \left(\frac{G_0 \lambda}{4\pi r}\right)^2$$

$$\sqrt{\frac{P_r}{P_t}} = \frac{G_0 \lambda}{4\pi r}$$

Thus, $G_0 = \frac{4\pi r}{\lambda} \sqrt{\frac{P_r}{P_t}}$

While if we consider the effect of direct and indirect rays in case of ground

reflection then, $G_0 = \frac{4\pi r}{\lambda F} \sqrt{\frac{P_r}{P_t}}$

: F is the propagation constant due to interference.

$$\text{Gain} = \frac{\text{Maximum amount of power received from subject antenna}}{\text{Maximum amount of power received from reference antenna}}$$

Hence, $G = \frac{P_1}{P_2}$

The calibration data for the test environment

Antenna G_{Total} Calculation

- G_{Theta} or G_{Phi} = S21(VNA reading value) – Path Loss
- **Antenna G_{Total}**

Step1: Each angle Gain(G_{Theta} and G_{Phi}) transfer to linear data : $10^{(G / 10)}$

Step2: Each angle total linear = G_{Theta} linear + G_{Phi} linear

Step3: data transfer dB scale : $G_{Total} = 10 * \text{LOG}_{10}(\text{Each angle total linear})$

The calibration data for the test environment (cont'd)

- **Path Loss Calculation**

- PL : Path Loss , P_{ISO} : Isotropic power , P_{TE} : Receive power from VNA

$$PL = P_{ISO} - P_{TE}$$

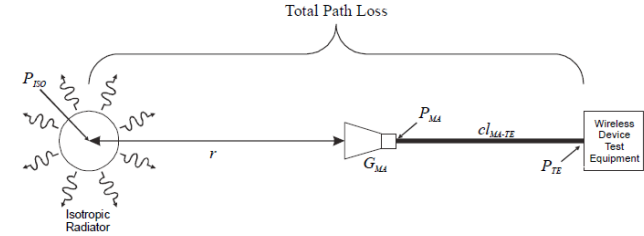

- G_{RA} : Gain from reference antenna , P_{SG} : Power from Signal Generator , Cl_{SG-RA} : Cable Loss from Signal Generator to reference antenna

$$P_{ISO} = (P_{SG} - Cl_{SG-RA}) + G_{RA}$$

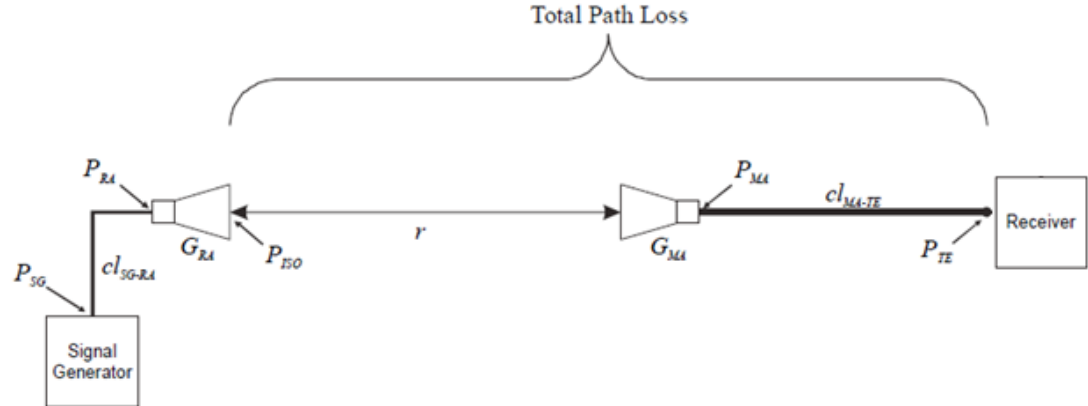

$$P_{RA} = P_{SG} - Cl_{SG-RA}$$

$$PL = (P_{RA} + G_{RA}) - P_{TE}$$

Antenna Information

Antenna PN: 180-100-1491R

- Antenna factory address:

蘇州市相城區陽澄湖鎮岸山開發區田多裡路號

An shan Development Zone , Yang chenghu Town , Xiangcheng District , Suzhou City , Jiangsu province