

**160 MHz CHANNEL BANDWIDTH DFS PORTION of  
FCC 47 CFR PART 15 SUBPART E  
ISED CANADA RSS-247 ISSUE 2**

**CERTIFICATION TEST REPORT**

**FOR**

**XV2-22H WALLPLATE WiFi 6 2x2 ACCESS POINT**

**MODEL NUMBER: XV2-22H**

**FCC ID: Z8H89FT0077  
ISED ID: 109W-0077**

**REPORT NUMBER: 14526301-E3V1**

**ISSUE DATE: 2023-01-27**

*Prepared for*  
**CAMBIUM NETWORKS, INC.  
3800 GOLF RD., SUITE 360  
ROLLING MEADOWS  
IL., 60008, U.S.A.**

*Prepared by*  
**UL VERIFICATION SERVICES INC.  
47173 BENICIA STREET  
FREMONT, CA 94538, U.S.A.  
TEL: (510) 319-4000  
FAX: (510) 661-0888**



Revision History

<u>Rev.</u>	<u>Issue Date</u>	<u>Revisions</u>	<u>Revised By</u>
V1	23/01/27	Initial Issue	

## TABLE OF CONTENTS

<b>1. ATTESTATION OF TEST RESULTS .....</b>	<b>5</b>
<b>2. TEST METHODOLOGY .....</b>	<b>6</b>
<b>3. SUMMARY OF TEST RESULTS.....</b>	<b>6</b>
<b>4. REFERENCE DOCUMENTS.....</b>	<b>6</b>
<b>5. FACILITIES AND ACCREDITATION .....</b>	<b>6</b>
<b>6. DECISION RULES AND MEASUREMENT UNCERTAINTY .....</b>	<b>7</b>
6.1. METROLOGICAL TRACEABILITY .....	7
6.2. DECISION RULES.....	7
<b>7. DYNAMIC FREQUENCY SELECTION.....</b>	<b>8</b>
7.1. OVERVIEW .....	8
7.1.1. LIMITS.....	8
7.1.2. TEST AND MEASUREMENT SYSTEM.....	12
7.1.3. TEST AND MEASUREMENT SOFTWARE .....	15
7.1.4. TEST ROOM ENVIRONMENT .....	15
7.1.5. SETUP OF EUT.....	16
7.1.6. DESCRIPTION OF EUT .....	18
7.2. LOWER BAND MASTER RESULTS FOR 160 MHz BANDWIDTH.....	20
7.2.1. TEST CHANNEL .....	20
7.2.2. RADAR WAVEFORMS AND TRAFFIC.....	20
7.2.3. CHANNEL AVAILABILITY CHECK TIME.....	29
7.2.4. OVERLAPPING CHANNEL TESTS.....	34
7.2.5. MOVE AND CLOSING TIME .....	34
7.2.6. NON-OCCUPANCY PERIOD .....	39
7.2.7. DETECTION BANDWIDTH.....	40
7.2.8. IN-SERVICE MONITORING .....	42
7.3. UPPER BAND MASTER RESULTS FOR 160 MHz BANDWIDTH.....	50
7.3.1. TEST CHANNEL .....	50
7.3.2. RADAR WAVEFORMS AND TRAFFIC.....	50
7.3.3. CHANNEL AVAILABILITY CHECK TIME.....	59
7.3.4. OVERLAPPING CHANNEL TESTS.....	64
7.3.5. MOVE AND CLOSING TIME .....	64
7.3.6. NON-OCCUPANCY PERIOD .....	69
7.3.7. DETECTION BANDWIDTH.....	70
7.3.8. IN-SERVICE MONITORING .....	72
7.4. BRIDGE MODE RESULTS.....	82
7.5. SLAVE RESULTS FOR 160 MHz BANDWIDTH.....	83
7.5.1. TEST CHANNEL .....	83
7.5.2. RADAR WAVEFORM AND TRAFFIC.....	83
7.5.3. OVERLAPPING CHANNEL TESTS.....	88
7.5.4. MOVE AND CLOSING TIME .....	88
7.5.5. 30-MINUTE NON-OCCUPANCY PERIOD.....	92

**8. SETUP PHOTOS.....93**

# 1. ATTESTATION OF TEST RESULTS

**COMPANY NAME:** CAMBIUM NETWORKS, INC.  
3800 GOLF RD., SUITE 360  
ROLLING MEADOWS, IL., 60008, U.S.A.

**EUT DESCRIPTION:** XV2-22H WALLPLATE WiFi 6 2x2 ACCESS POINT

**MODEL:** XV2-22H

**SERIAL NUMBER:** W6YG0040WVZD (MASTER DEVICE) and  
W6YG003G84DT (MESH SLAVE DEVICE)

**DATE TESTED:** OCTOBER 11 to 12, 2022

APPLICABLE STANDARDS	
STANDARD	TEST RESULTS
DFS Portion of CFR 47 Part 15 Subpart E	Complies
DFS Portion of ISED CANADA RSS-247 Issue 2	Complies

UL Verification Services Inc. tested the above equipment in accordance with the requirements set forth in the above standards. The test results show that the equipment tested is capable of demonstrating compliance with the requirements as documented in this report.

The results documented in this report apply only to the tested sample, under the conditions and modes of operation as described herein. It is the manufacturer's responsibility to assure that additional production units of this model are manufactured with identical electrical and mechanical components. All samples tested were in good operating condition throughout the entire test program. Measurement Uncertainties are published for informational purposes only and were not taken into account unless noted otherwise.

This document may not be altered or revised in any way unless done so by UL Verification Services Inc. and all revisions are duly noted in the revisions section. Any alteration of this document not carried out by UL Verification Services Inc. will constitute fraud and shall nullify the document.

Approved & Released For  
UL Verification Services Inc. By:

Prepared By:



Edgard Rincand  
Operations Leader  
CONSUMER TECHNOLOGY DIVISION  
UL Verification Services Inc.

DOUG ANDERSON  
Test Engineer  
CONSUMER TECHNOLOGY DIVISION  
UL Verification Services Inc.

## 2. TEST METHODOLOGY

The tests documented in this report were performed in accordance with the DFS portion of FCC CFR 47 Part 2, FCC CFR 47 Part 15, FCC KDB 789033, KDB 905462 D02 and D03 and RSS-247 Issue 2.

## 3. SUMMARY OF TEST RESULTS

Requirement Description	Result	Remarks
DFS Portion of FCC 47 CFR PART 15 SUBPART E	Complies	
DFS Portion of ISED CANADA RSS-247 ISSUE 2	Complies	

## 4. REFERENCE DOCUMENTS

Measurements of transmitter parameters as referenced in this report and all other manufacturer's declarations relevant to the RF test requirements are documented in Sporton Labs FCC report and IC report number FR261023AB.

This report contains data provided by the customer which can impact the validity of results. UL Verification Services Inc. is only responsible for the validity of results after the integration of the data provided by the customer.

DFS test results for all other channel bandwidths supported by the EUT are documented in UL Verification Services report number 14492992-E1V1.

## 5. FACILITIES AND ACCREDITATION

UL Verification Services Inc. is accredited by A2LA, Certificate Number 0751.05, for all testing performed within the scope of this report. Testing was performed at the locations noted below.

	Address	ISED CABID	ISED Company Number	FCC Registration
<input checked="" type="checkbox"/>	Building 1: 47173 Benicia Street, Fremont, California, USA	US0104	2324A	550739
	Building 2: 47266 Benicia Street, Fremont, California, USA	US0104	2324A	550739
	Building 4: 47658 Kato Rd, Fremont, California, USA	US0104	2324A	550739

## **6. DECISION RULES AND MEASUREMENT UNCERTAINTY**

### **6.1. METROLOGICAL TRACEABILITY**

All test and measuring equipment utilized to perform the tests documented in this report are calibrated on a regular basis, with a maximum time between calibrations of one year or the manufacturers' recommendation, whichever is less, and where applicable is traceable to recognized national standards.

### **6.2. DECISION RULES**

The Decision Rule is based on Simple Acceptance in accordance with ISO Guide 98-4:2012 Clause 8.2. (Measurement uncertainty is not taken into account when stating conformity with a specified requirement).

## 7. DYNAMIC FREQUENCY SELECTION

### 7.1. OVERVIEW

#### 7.1.1. LIMITS

#### **INNOVATION, SCIENCE and ECONOMIC DEVELOPMENT CANADA (ISED)**

ISED RSS-247 is closely harmonized with FCC Part 15 DFS rules. The deviations are as follows:

RSS-247 Issue 2

**Note:** For the band 5600–5650 MHz, no operation is permitted.

Until further notice, devices subject to this annex shall not be capable of transmitting in the band 5600–5650 MHz. This restriction is for the protection of Environment Canada weather radars operating in this band.

#### **FCC**

§15.407 (h), FCC KDB 905462 D02 “COMPLIANCE MEASUREMENT PROCEDURES FOR UNLICENSED-NATIONAL INFORMATION INFRASTRUCTURE DEVICES OPERATING IN THE 5250-5350 MHz AND 5470-5725 MHz BANDS INCORPORATING DYNAMIC FREQUENCY SELECTION” and KDB 905462 D03 “U-NII CLIENT DEVICES WITHOUT RADAR DETECTION CAPABILITY”.



**Table 1: Applicability of DFS requirements prior to use of a channel**

Requirement	Operational Mode		
	Master	Client (without radar detection)	Client (with radar detection)
Non-Occupancy Period	Yes	Not required	Yes
DFS Detection Threshold	Yes	Not required	Yes
Channel Availability Check Time	Yes	Not required	Not required
U-NII Detection Bandwidth	Yes	Not required	Yes

**Table 2: Applicability of DFS requirements during normal operation**

Requirement	Operational Mode		
	Master	Client (without DFS)	Client (with DFS)
DFS Detection Threshold	Yes	Not required	Yes
Channel Closing Transmission Time	Yes	Yes	Yes
Channel Move Time	Yes	Yes	Yes
U-NII Detection Bandwidth	Yes	Not required	Yes

Additional requirements for devices with multiple bandwidth modes	Master Device or Client with Radar DFS	Client (without DFS)
<i>U-NII Detection Bandwidth and Statistical Performance Check</i>	All BW modes must be tested	Not required
<i>Channel Move Time and Channel Closing Transmission Time</i>	Test using widest BW mode available	Test using the widest BW mode available for the link
<i>All other tests</i>	Any single BW mode	Not required
<b>Note:</b> Frequencies selected for statistical performance check (Section 7.8.4) should include several frequencies within the radar detection bandwidth and frequencies near the edge of the radar detection bandwidth. For 802.11 devices it is suggested to select frequencies in all 20 MHz channel blocks and a null frequency between the bonded 20 MHz channel blocks.		

**Table 3: Interference Threshold values, Master or Client incorporating In-Service Monitoring**

Maximum Transmit Power	Value (see notes)
E.I.R.P. $\geq$ 200 mill watt	-64 dBm
E.I.R.P. < 200 mill watt and power spectral density < 10 dBm/MHz	-62 dBm
E.I.R.P. < 200 mill watt that do not meet power spectral density requirement	-64 dBm
<p><b>Note 1:</b> This is the level at the input of the receiver assuming a 0 dBi receive antenna</p> <p><b>Note 2:</b> Throughout these test procedures an additional 1 dB has been added to the amplitude of the test transmission waveforms to account for variations in measurement equipment. This will ensure that the test signal is at or above the detection threshold level to trigger a DFS response.</p> <p><b>Note 3:</b> E.I.R.P. is based on the highest antenna gain. For MIMO devices refer to KDB publication 662911 D01.</p>	

**Table 4: DFS Response requirement values**

Parameter	Value
<i>Non-occupancy period</i>	30 minutes
<i>Channel Availability Check Time</i>	60 seconds
<i>Channel Move Time</i>	10 seconds (See Note 1)
<i>Channel Closing Transmission Time</i>	200 milliseconds + approx. 60 milliseconds over remaining 10 second period. (See Notes 1 and 2)
<i>U-NII Detection Bandwidth</i>	Minimum 100% of the U-NII 99% transmission power bandwidth. (See Note 3)
<p><b>Note 1:</b> <i>Channel Move Time</i> and the <i>Channel Closing Transmission Time</i> should be performed with Radar Type 0. The measurement timing begins at the end of the Radar Type 0 burst.</p> <p><b>Note 2:</b> The <i>Channel Closing Transmission Time</i> is comprised of 200 milliseconds starting at the beginning of the <i>Channel Move Time</i> plus any additional intermittent control signals required to facilitate a <i>Channel</i> move (an aggregate of 60 milliseconds) during the remainder of the 10 second period. The aggregate duration of control signals will not count quiet periods in between transmissions.</p> <p><b>Note 3:</b> During the <i>U-NII Detection Bandwidth</i> detection test, radar type 0 should be used. For each frequency step the minimum percentage of detection is 90 percent. Measurements are performed with no data traffic.</p>	

**Table 5 – Short Pulse Radar Test Waveforms**

Radar Type	Pulse Width (usec)	PRI (usec)	Pulses	Minimum Percentage of Successful Detection	Minimum Trials
0	1	1428	18	See Note 1	See Note 1
1	1	Test A: 15 unique PRI values randomly selected from the list of 23 PRI values in table 5a	Roundup: $\{(1/360) \times (19 \times 10^6 / \text{PRI}_{\text{usec}})\}$	60%	30
		Test B: 15 unique PRI values randomly selected within the range of 518-3066 usec. With a minimum increment of 1 usec, excluding PRI values selected in Test A			
2	1-5	150-230	23-29	60%	30
3	6-10	200-500	16-18	60%	30
4	11-20	200-500	12-16	60%	30
Aggregate (Radar Types 1-4)				80%	120
<b>Note 1:</b> Short Pulse Radar Type 0 should be used for the <i>Detection Bandwidth</i> test, <i>Channel Move Time</i> , and <i>Channel Closing Time</i> tests.					

**Table 6 – Long Pulse Radar Test Signal**

Radar Waveform Type	Pulse Width (µsec)	Chirp Width (MHz)	PRI (µsec)	Pulses per Burst	Number of Bursts	Minimum Percentage of Successful Detection	Minimum Trials
5	50-100	5-20	1000-2000	1-3	8-20	80%	30

**Table 7 – Frequency Hopping Radar Test Signal**

Radar Waveform Type	Pulse Width (µsec)	PRI (µsec)	Pulses per Hop	Hopping Rate (kHz)	Hopping Sequence Length (msec)	Minimum Percentage of Successful Detection	Minimum Trials
6	1	333	9	0.333	300	70%	30

### 7.1.2. TEST AND MEASUREMENT SYSTEM

#### CONDUCTED METHOD SYSTEM BLOCK DIAGRAM

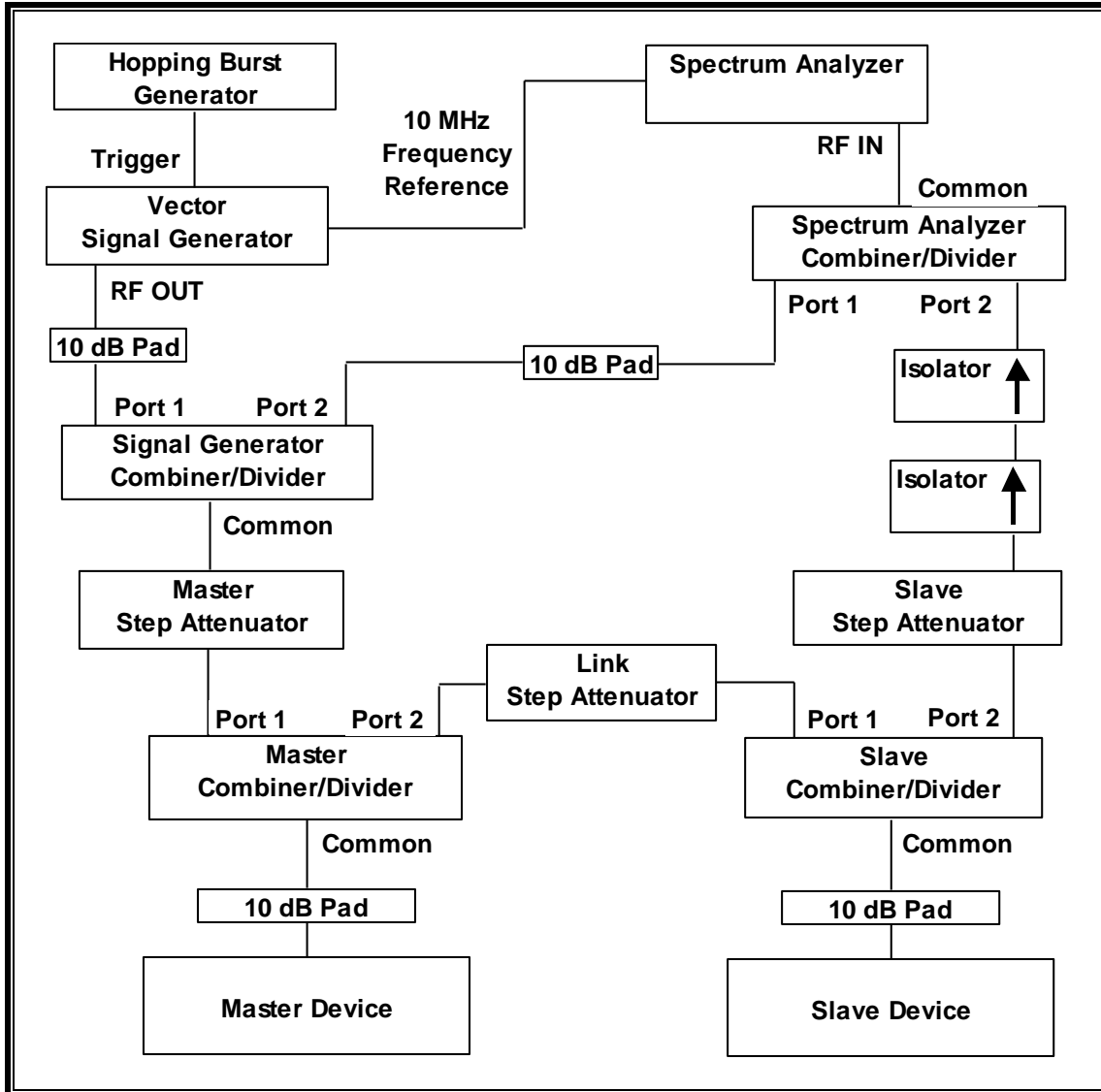

## **SYSTEM OVERVIEW**

The short pulse and long pulse signal generating system utilizes the NTIA software. The Vector Signal Generator has been validated by the NTIA. The hopping signal generating system utilizes the CCS simulated hopping method and system, which has been validated by the DoD, FCC and NTIA. The software selects waveform parameters from within the bounds of the signal type on a random basis using uniform distribution.

The short pulse types 1, 2, 3 and 4, and the long pulse type 5 parameters are randomized at run-time.

The hopping type 6 pulse parameters are fixed while the hopping sequence is based on the August 2005 NTIA Hopping Frequency List. The initial starting point randomized at run-time and each subsequent starting point is incremented by 475. Each frequency in the 100-length segment is compared to the boundaries of the EUT Detection Bandwidth and the software creates a hopping burst pattern in accordance with Section 7.4.1.3 Method #2 Simulated Frequency Hopping Radar Waveform Generating Subsystem of KDB 905462 D02. The frequency of the signal generator is incremented in 1 MHz steps from  $F_L$  to  $F_H$  for each successive trial. This incremental sequence is repeated as required to generate a minimum of 30 total trials and to maintain a uniform frequency distribution over the entire Detection Bandwidth.

The signal monitoring equipment consists of a spectrum analyzer. The aggregate ON time is calculated by multiplying the number of bins above a threshold during a particular observation period by the dwell time per bin, with the analyzer set to peak detection and max hold.

Should multiple RF ports be utilized for the Master and/or Slave devices (for example, for diversity or MIMO implementations), additional combiner/dividers are inserted between the Master Combiner/Divider and the pad connected to the Master Device (and/or between the Slave Combiner/Divider and the pad connected to the Slave Device). Additional pads may be utilized such that there is one pad at each RF port on each EUT.

## **SYSTEM CALIBRATION**

A 50-ohm load is connected in place of the spectrum analyzer, and the spectrum analyzer is connected in place of the master device. The signal generator is set to CW mode. The amplitude of the signal generator is adjusted to yield a level of  $-64$  dBm as measured on the spectrum analyzer.

Without changing any of the instrument settings, the spectrum analyzer is reconnected to the Common port of the Spectrum Analyzer Combiner/Divider. The Reference Level Offset of the spectrum analyzer is adjusted so that the displayed amplitude of the signal is  $-64$  dBm.

The spectrum analyzer displays the level of the signal generator as received at the antenna ports of the Master Device. The interference detection threshold may be varied from the calibrated value of  $-64$  dBm and the spectrum analyzer will still indicate the level as received by the Master Device.

**ADJUSTMENT OF DISPLAYED TRAFFIC LEVEL**

A link is established between the Master and Slave and the Link Step Attenuator between the units is adjusted as needed to provide a suitable received level at the Master and Slave devices. Traffic that meets or exceed the minimum loading requirement is streamed from the Master device to the Slave Device. The WLAN traffic level, as displayed on the spectrum analyzer, is confirmed to be at lower amplitude than the radar detection threshold and is confirmed to be the Radar Detection Device rather than the associated device. If a different setting of the Master Step Attenuator is required to meet the above conditions, a new System Calibration is performed for the new Master Step Attenuator setting.

**TEST AND MEASUREMENT EQUIPMENT**

The following test and measurement RF equipment was utilized for the tests documented in this report:

**MASTER DEVICE**

TEST EQUIPMENT LIST				
Description	Manufacturer	Model	ID No.	Cal Due
Spectrum Analyzer, PXA, 3Hz to 8.4GHz	Keysight	N9030A	150667	01/27/23
Signal Generator, MXG X-Series RF Vector	Keysight	N5182B	215999	02/08/23
Frequency Extender	Keysight	N5182BX	213906	12/29/22
Arbitrary Waveform Generator	Agilent / HP	33220A	80815	01/24/23

**MESH SLAVE DEVICE**

TEST EQUIPMENT LIST				
Description	Manufacturer	Model	ID No.	Cal Due
Spectrum Analyzer, PXA, 3Hz to 8.4GHz	Keysight	N9030A	150667	01/27/23
Signal Generator, MXG X-Series RF Vector	Keysight	N5182B	215999	02/08/23
Frequency Extender	Keysight	N5182BX	213906	12/29/22

**Note:** An MXG series Signal Generator and separate external Frequency Extender module are shown in the preceding test system block diagram as a stand-alone Vector Signal Generator.

### 7.1.3. TEST AND MEASUREMENT SOFTWARE

The following test and measurement software was utilized for the tests documented in this report:

#### MASTER DEVICE

TEST SOFTWARE LIST		
Name	Version	Test / Function
Aggregate Time-PXA	3.1	Channel Loading and Aggregate Closing Time
FCC 2014 Detection Bandwidth-PXA	3.1.1	Detection Bandwidth in 5 MHz Steps
In Service Monitoring-PXA	4.1	In-Service Monitoring (Probability of Detection)
PXA Read	3.1	Signal Generator Screen Capture
SGXProject.exe	1.7	Radar Waveform Generation and Download

#### MESH SLAVE DEVICE

TEST SOFTWARE LIST		
Name	Version	Test / Function
Aggregate Time-PXA	3.1	Channel Loading and Aggregate Closing Time
PXA Read	3.1	Signal Generator Screen Capture
SGXProject.exe	1.7	Radar Waveform Generation and Download

### 7.1.4. TEST ROOM ENVIRONMENT

The test room temperature and humidity shall be maintained within normal temperature of 15~35 °C and normal humidity 20~75% (relative humidity).

#### ENVIRONMENT CONDITION

Parameter	Value
Temperature	22.6 and 21.9 °C
Humidity	58 and 59 %

### 7.1.5. SETUP OF EUT

#### CONDUCTED METHOD EUT TEST SETUP

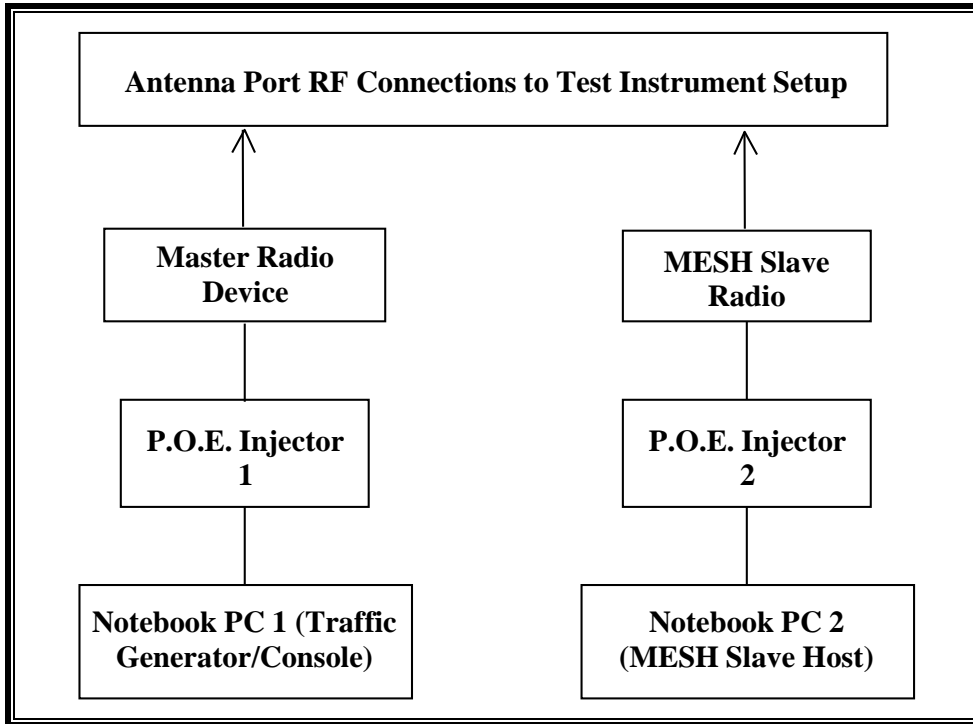



**SUPPORT EQUIPMENT**

The following support equipment was utilized for the tests documented in this report:

**MASTER DEVICE**

PERIPHERAL SUPPORT EQUIPMENT LIST				
Description	Manufacturer	Model	Serial Number	FCC ID
P.O.E. Injector 1 (Master)	Cambium Networks	NET-P60-56IN	N000000L142A2153000 001	DoC
Notebook PC 1 (Master Console)	Lenovo	Type 4236-B92	PB-HEX04 12/05	DoC
AC Adapter 1 (Notebook PC 1)	Lenovo	42T4418	11S42T4418Z1ZGWWG0 8R90M	DoC
XV2-22H Wallplate WiFi 6 2x2 Access Point (MESH Slave Radio)	Cambium Networks	XV2-22H	W6YG003G84DT	Z8H89FT0077
P.O.E. Injector 2 (MESH Slave)	Cambium Networks	NET-P60-56IN	N000000L142A2028000 0149	DoC
Notebook PC 2 (MESH Slave Host)	Lenovo	Type 20B7-S0A200	PF-02JN9J 14/06	DoC
AC Adapter 2 (Notebook PC 2)	Lenovo	ADLX65NLC2A	11S45N0259Z1ZS9745 94A9	DoC

**MESH SLAVE DEVICE**

PERIPHERAL SUPPORT EQUIPMENT LIST				
Description	Manufacturer	Model	Serial Number	FCC ID
P.O.E. Injector 1 (Master)	Cambium Networks	NET-P60-56IN	N000000L142A2153000 001	DoC
Notebook PC 1 (Master Console)	Lenovo	Type 4236-B92	PB-HEX04 12/05	DoC
AC Adapter 1 (Notebook PC 1)	Lenovo	42T4418	11S42T4418Z1ZGWWG0 8R90M	DoC
XV2-22H Wallplate WiFi 6 2x2 Access Point (Master Radio Device)	Cambium Networks	XV2-22H	W6YG0040WVZD	Z8H89FT0077
P.O.E. Injector 2 (MESH Slave)	Cambium Networks	NET-P60-56IN	N000000L142A2028000 0149	DoC
Notebook PC 2 (MESH Slave Host)	Lenovo	Type 20B7-S0A200	PF-02JN9J 14/06	DoC
AC Adapter 2 (Notebook PC 2)	Lenovo	ADLX65NLC2A	11S45N0259Z1ZS9745 94A9	DoC

### 7.1.6. DESCRIPTION OF EUT

For FCC the EUT operates over the 5250-5350 MHz and 5470-5725 MHz ranges.

For ISED the EUT operates over the 5250-5350 MHz and 5470-5725 MHz ranges, excluding the 5600-5650 MHz range.

The EUT can be configured as a Master Device or a Mesh Slave Device without Radar Detection.

The manufacturer has declared that the highest power level within these bands is 30 dBm EIRP in the 5250-5350 MHz band and 30 dBm EIRP in the 5470-5725 MHz band.

The manufacturer has declared that the highest gain antenna assembly utilized with the EUT has a gain of 5 dBi in the 5250-5350 MHz band and 5 dBi in the 5470-5725 MHz band. The manufacturer has declared that the lowest gain antenna assembly utilized with the EUT has a gain of 5 dBi in the 5250-5350 MHz band and 5 dBi in the 5470-5725 MHz band.

Two identical antennas are utilized to meet the diversity and MIMO operational requirements.

The rated output power of the Master unit is > 23dBm (EIRP). Therefore the required interference threshold level is -64 dBm. After correction for antenna gain and procedural adjustments, the required conducted threshold at the antenna port is  $-64 + 5 + 1 = -58$  dBm.

The calibrated conducted DFS Detection Threshold level is set to -63 dBm.

The EUT uses two transmitter/receiver chains, each connected to a 50-ohm coaxial antenna port.

The Slave device associated with the EUT during these tests does not have radar detection capability.

WLAN traffic that meets or exceeds the minimum required loading was generated by transferring a data stream from the Master Device to the Slave Device using iPerf version 2.0.5 software package.

TPC is required since the maximum EIRP is greater than 500 mW (27 dBm).

The EUT utilizes the 802.11ax architecture. Four nominal channel bandwidths are implemented: 20 MHz, 40 MHz, 80 MHz and 160 MHz.

Channel puncturing is not supported by the EUT.

The software installed in the EUT is revision 6.5-a0.

The software installed in the access point during Mesh Slave testing is revision 6.5-a0.

### **UNIFORM CHANNEL SPREADING**

This function is not required per KDB 905462.

### **OVERVIEW OF MASTER DEVICE WITH RESPECT TO §15.407 (h) REQUIREMENTS**

The Master Device is a Cambium XV2-22H Wallplate WiFi 6 2x2 Access Point, FCC ID: Z8H89FT0077. The minimum antenna gain for the Master Device is 5 dBi.

The rated output power of the Master unit is > 23dBm (EIRP). Therefore the required interference threshold level is -64 dBm. After correction for antenna gain and procedural adjustments, the required conducted threshold at the antenna port is  $-64 + 5 + 1 = -58$  dBm.

The calibrated conducted DFS Detection Threshold level is set to -63 dBm.

The software installed in the access point is revision 6.5-a0.

## 7.2. LOWER BAND MASTER RESULTS FOR 160 MHz BANDWIDTH

### 7.2.1. TEST CHANNEL

All tests were performed at a channel center frequency of 5250 MHz.

### 7.2.2. RADAR WAVEFORMS AND TRAFFIC

#### RADAR WAVEFORMS

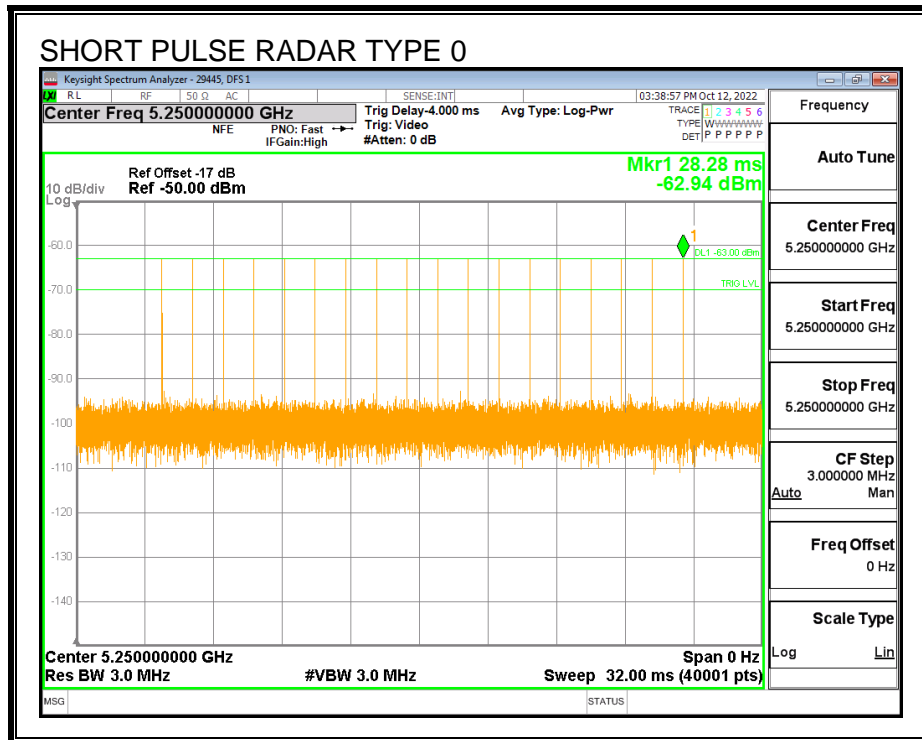

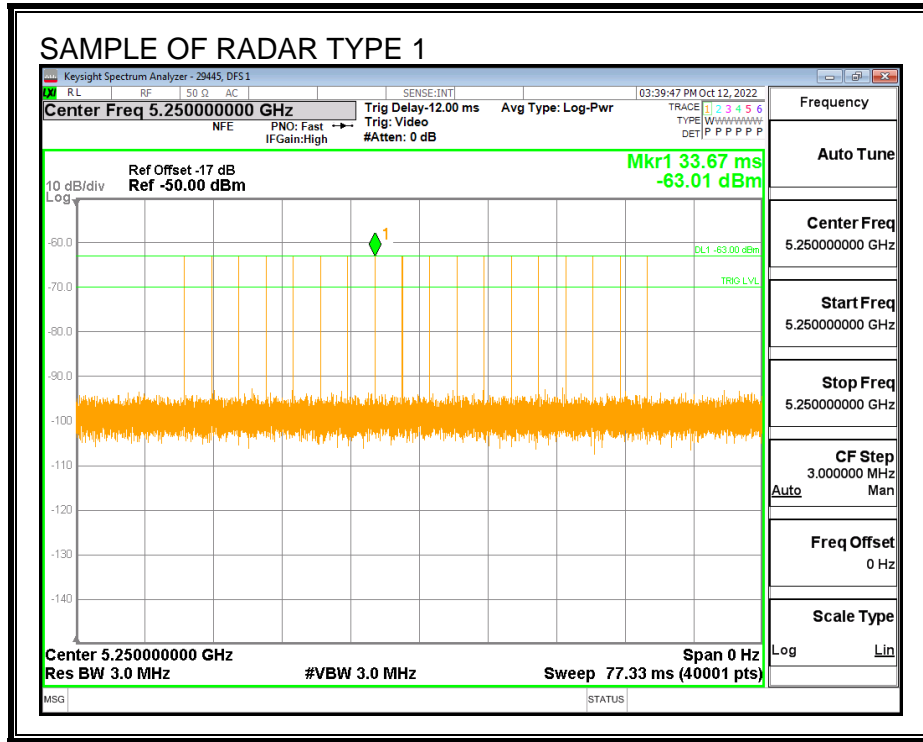

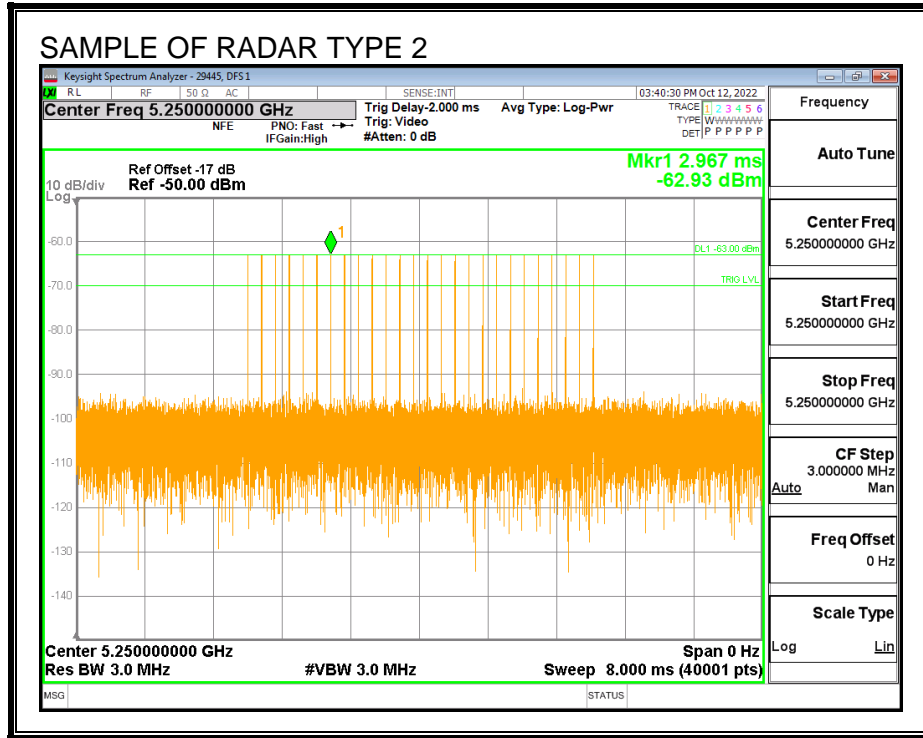

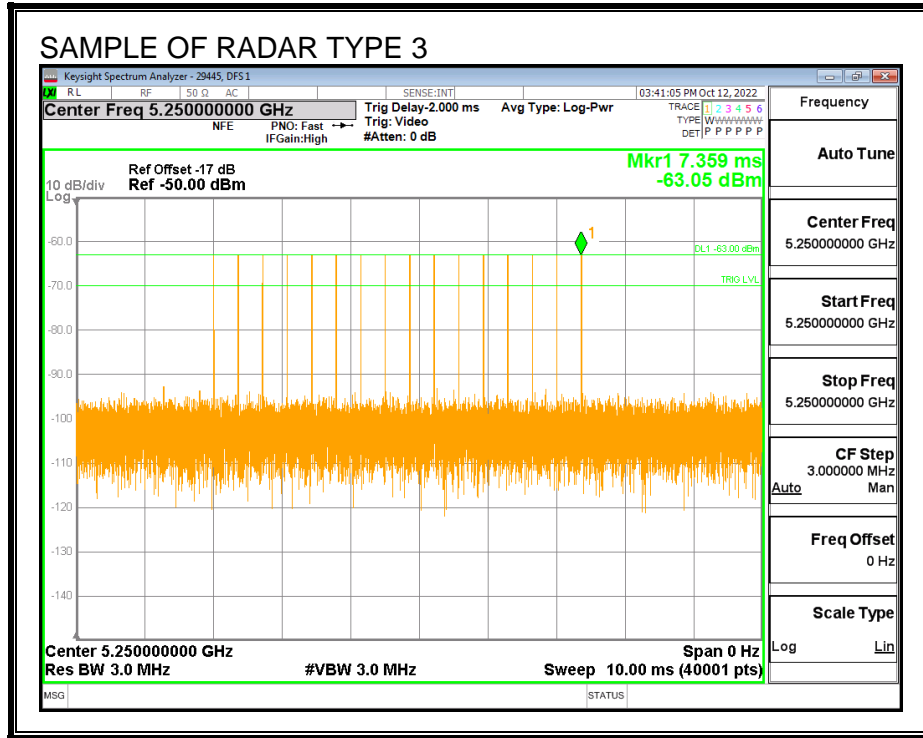

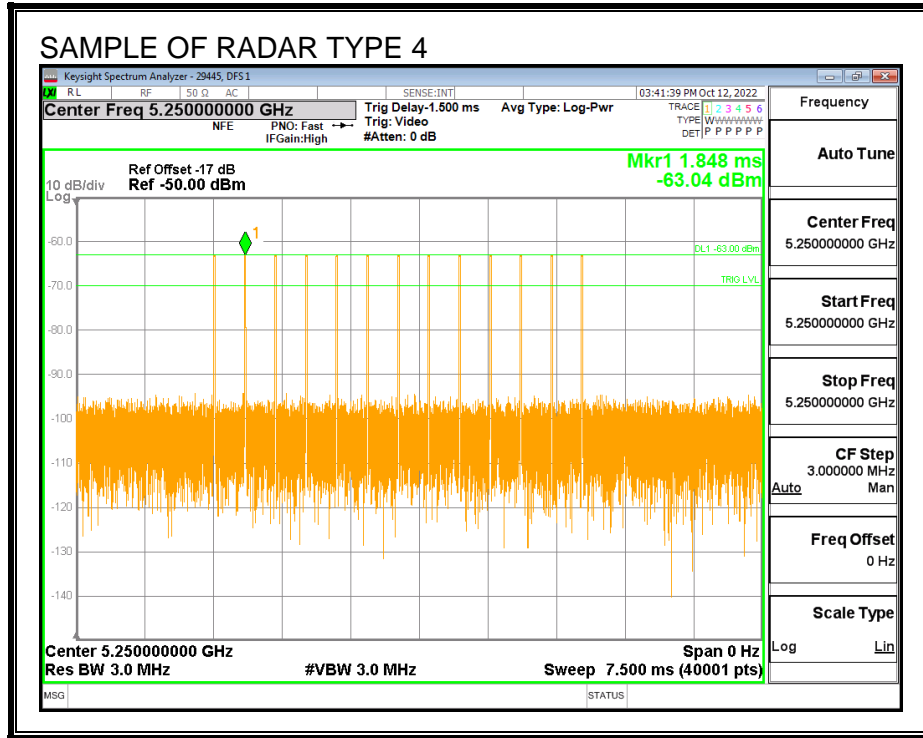



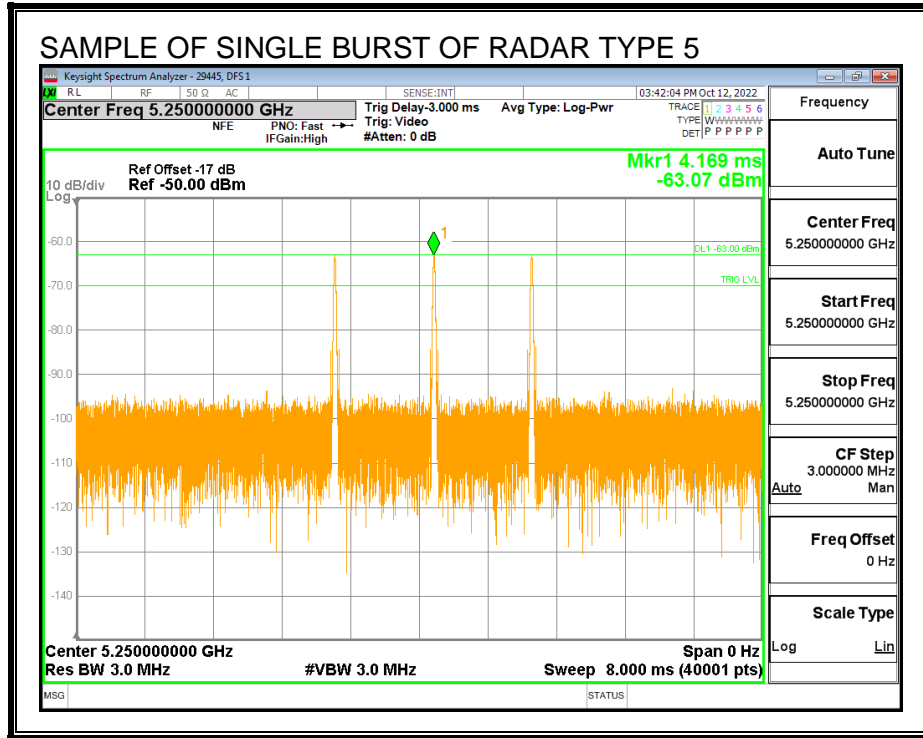

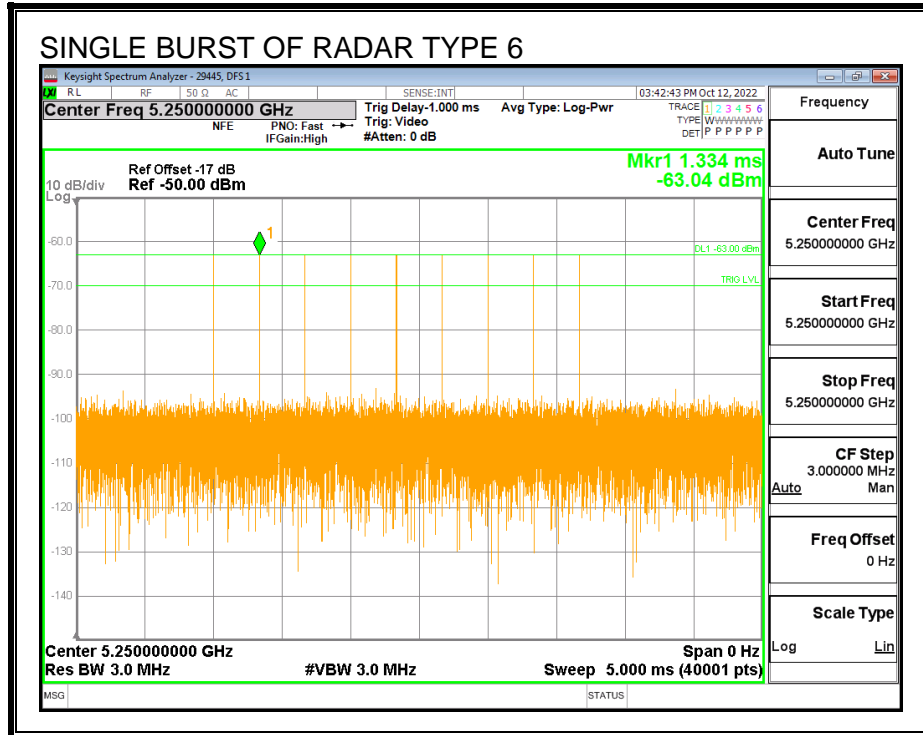

**TRAFFIC**

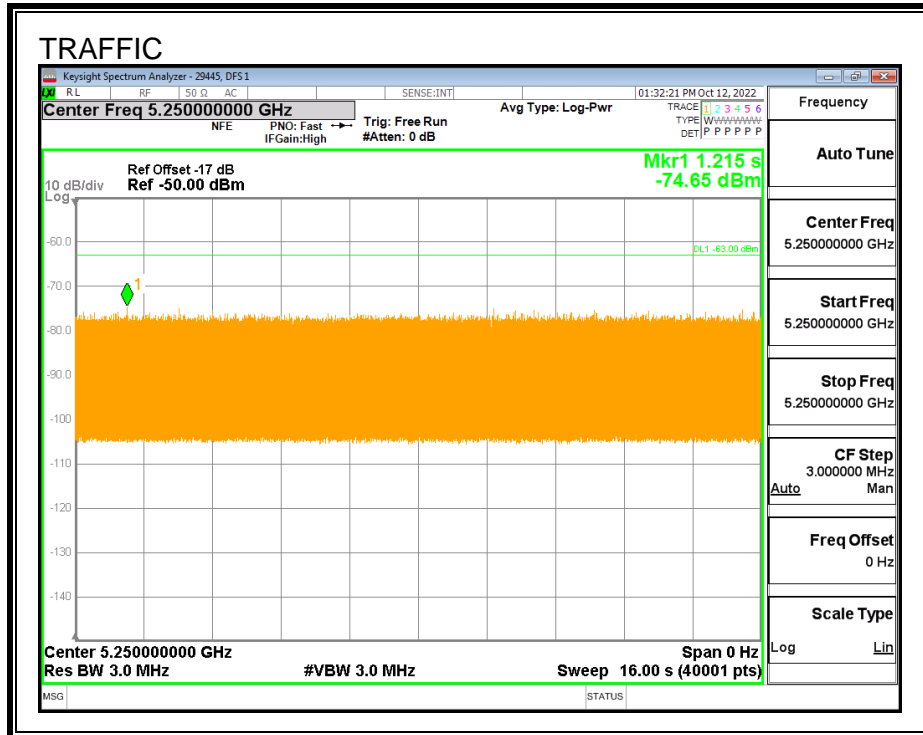

**CHANNEL LOADING**

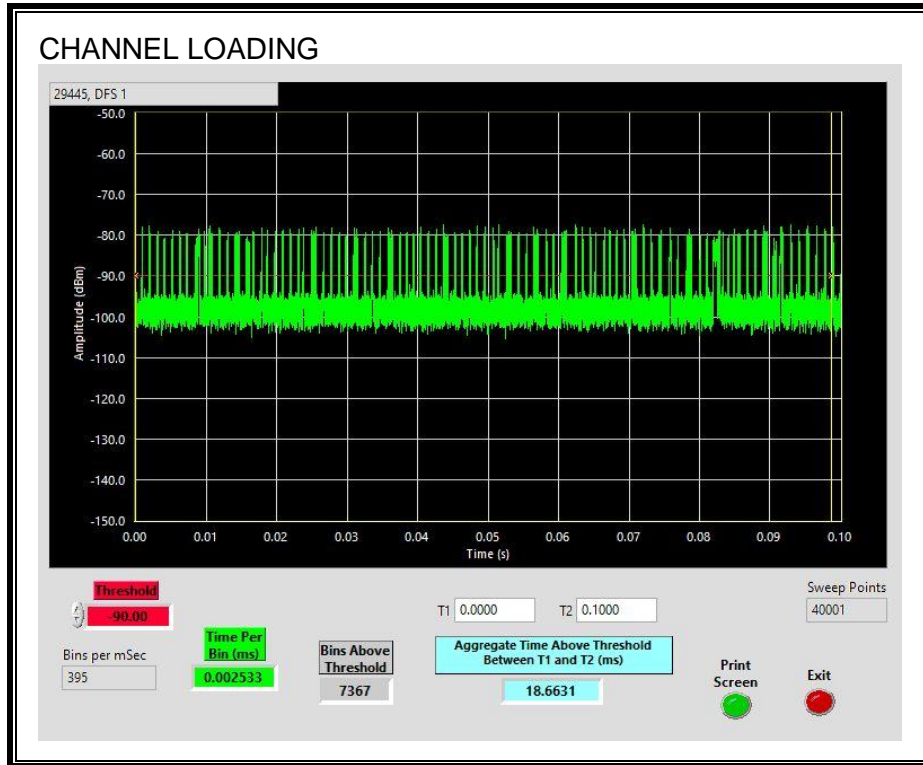

The level of traffic loading on the channel by the EUT is 18.66%

### **7.2.3. CHANNEL AVAILABILITY CHECK TIME**

#### **PROCEDURE TO DETERMINE INITIAL POWER-UP CYCLE TIME**

A link was established on channel then the EUT was rebooted. The time from the cessation of traffic to the re-initialization of traffic was measured as the time required for the EUT to complete the total power-up cycle. The time to complete the initial power-up period is 60 seconds less than this total power-up time.

#### **PROCEDURE FOR TIMING OF RADAR BURST**

With a link established on channel, the EUT was rebooted. A radar signal was triggered within 0 to 6 seconds after the initial power-up period, and transmissions on the channel were monitored on the spectrum analyzer.

The Non-Occupancy list was cleared. With a link established on channel, the EUT was rebooted. A radar signal was triggered within 54 to 60 seconds after the initial power-up period, and transmissions on the channel were monitored on the spectrum analyzer.

**QUANTITATIVE RESULTS**

**No Radar Triggered**

Timing of Reboot (sec)	Timing of Start of Traffic (sec)	Total Power-up Cycle Time (sec)	Initial Power-up Cycle Time (sec)
30.1	229.0	198.9	138.9

**Radar Near Beginning of CAC**

Timing of Reboot (sec)	Timing of Radar Burst (sec)	Radar Relative to Reboot (sec)	Radar Relative to Start of CAC (sec)
30.3	172.5	142.2	3.3

**Radar Near End of CAC**

Timing of Reboot (sec)	Timing of Radar Burst (sec)	Radar Relative to Reboot (sec)	Radar Relative to Start of CAC (sec)
30.62	226.8	196.2	57.3

**QUALITATIVE RESULTS**

Timing of Radar Burst	Display on Control Computer	Spectrum Analyzer Display
No Radar Triggered	EUT marks Channel as active	Transmissions begin on channel after completion of the initial power-up cycle and the CAC
Within 0 to 6 second window	EUT indicates radar detected	No transmissions on channel
Within 54 to 60 second window	EUT indicates radar detected	No transmissions on channel

**TIMING WITHOUT RADAR DURING CAC**

AP is rebooted  
Traffic ceases  
Start of Initial Power-up cycle

End of Initial Power-up cycle  
Start of CAC

End of CAC  
Traffic is Initiated

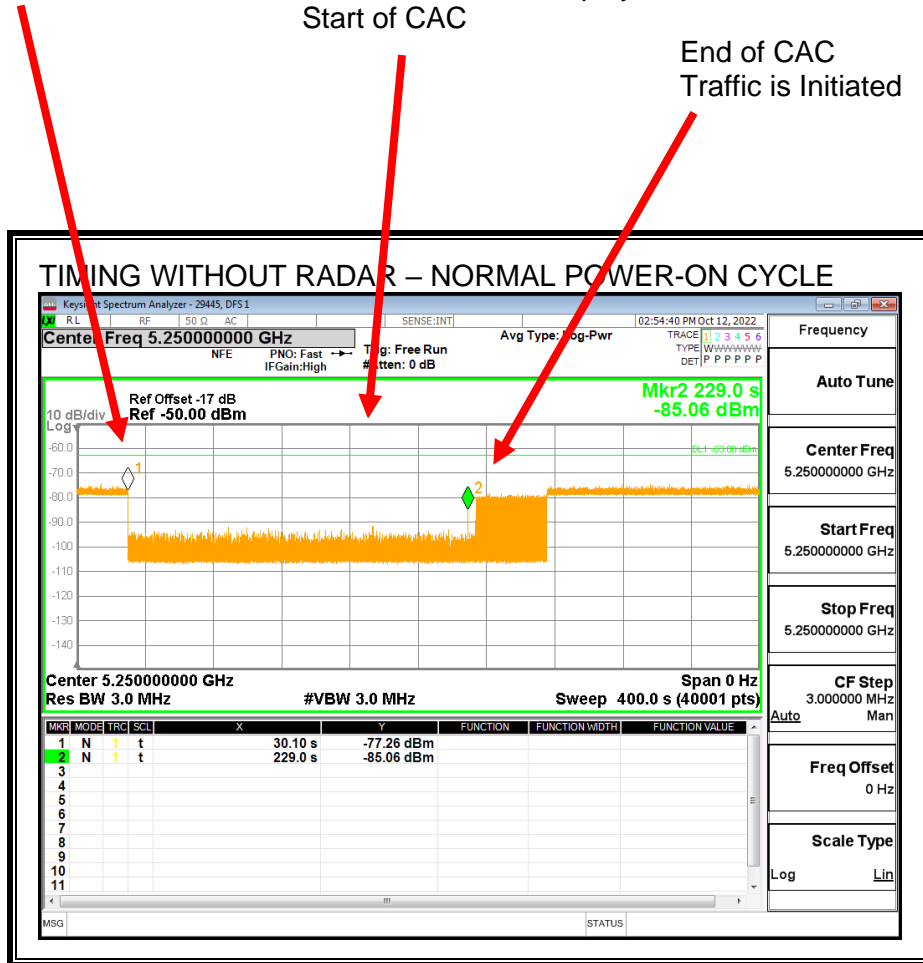

Transmissions begin on channel after completion of the initial power-up cycle and the CAC.

**TIMING WITH RADAR NEAR BEGINNING OF CAC**

AP is rebooted  
Traffic ceases  
Start of Initial Power-up cycle

End of Initial Power-up cycle  
Start of CAC

Radar Signal Applied

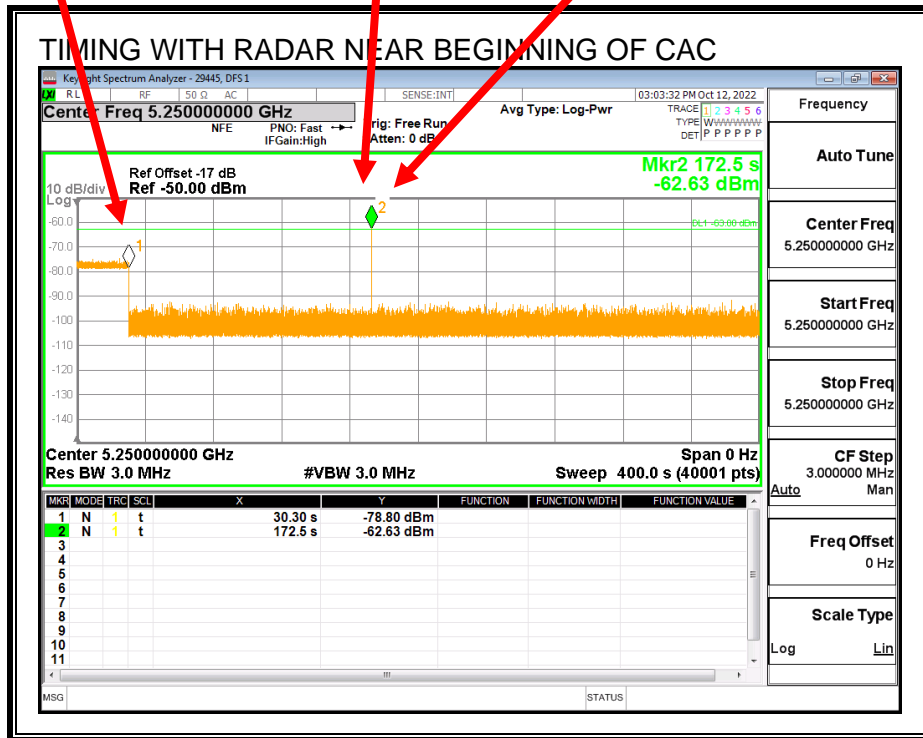

No EUT transmissions were observed after the radar signal.



**TIMING WITH RADAR NEAR END OF CAC**

AP is rebooted  
Traffic ceases  
Start of Initial Power-up cycle

End of Initial Power-up cycle  
Start of CAC

Radar Signal Applied

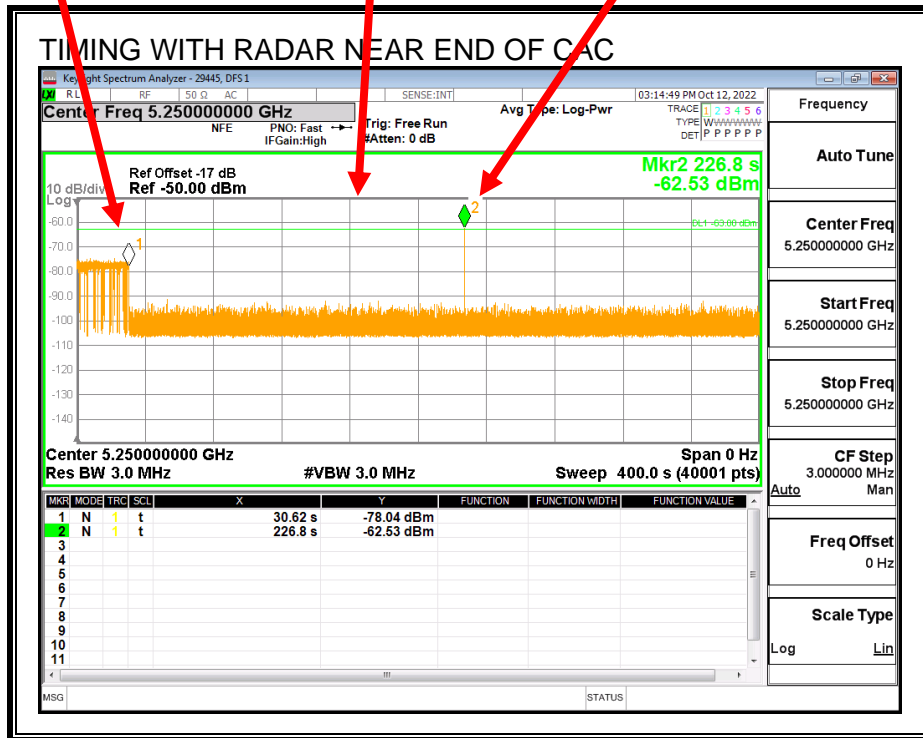

No EUT transmissions were observed after the radar signal.

### 7.2.4. OVERLAPPING CHANNEL TESTS

#### RESULTS

The channel spacing is not less than the channel bandwidth therefore the EUT does not have an overlapping channel plan.

### 7.2.5. MOVE AND CLOSING TIME

#### REPORTING NOTES

The reference marker is set at the end of last radar pulse.

The delta marker is set at the end of the last WLAN transmission following the radar pulse. This delta is the channel move time.

The aggregate channel closing transmission time is calculated as follows:

Aggregate Transmission Time =  
(Number of analyzer bins showing transmission) \* (dwell time per bin)

The observation period over which the aggregate time is calculated begins at (Reference Marker + 200 msec) and ends no earlier than (Reference Marker + 10 sec).

#### RESULTS

Channel Move Time (sec)	Limit (sec)
0.5612	10

Aggregate Channel Closing Transmission Time (msec)	Limit (msec)
4.0	60

**MOVE TIME**

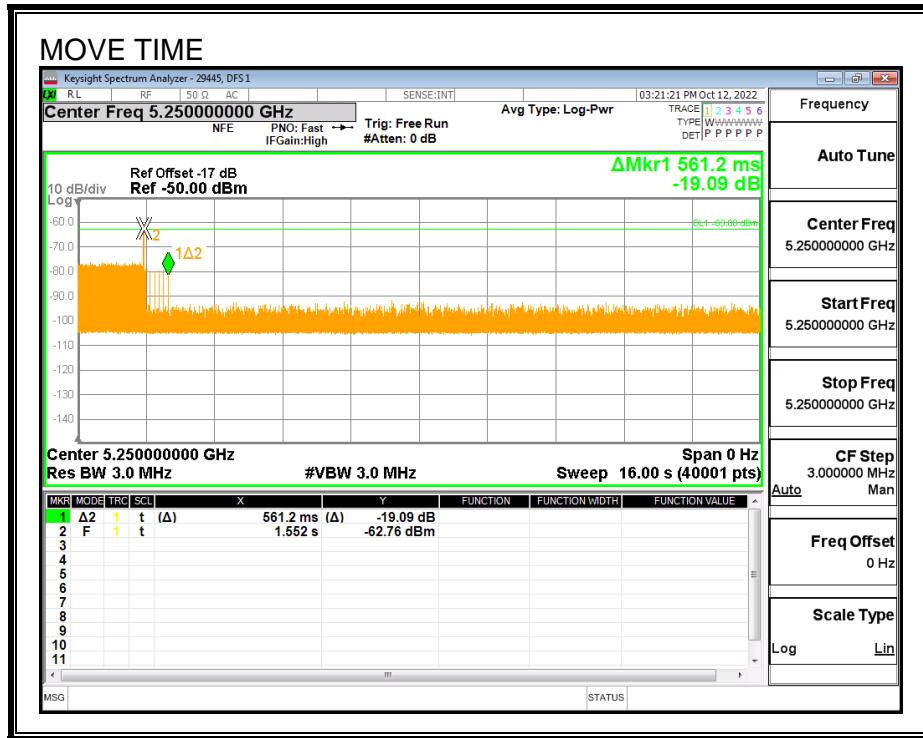

**CHANNEL CLOSING TIME**

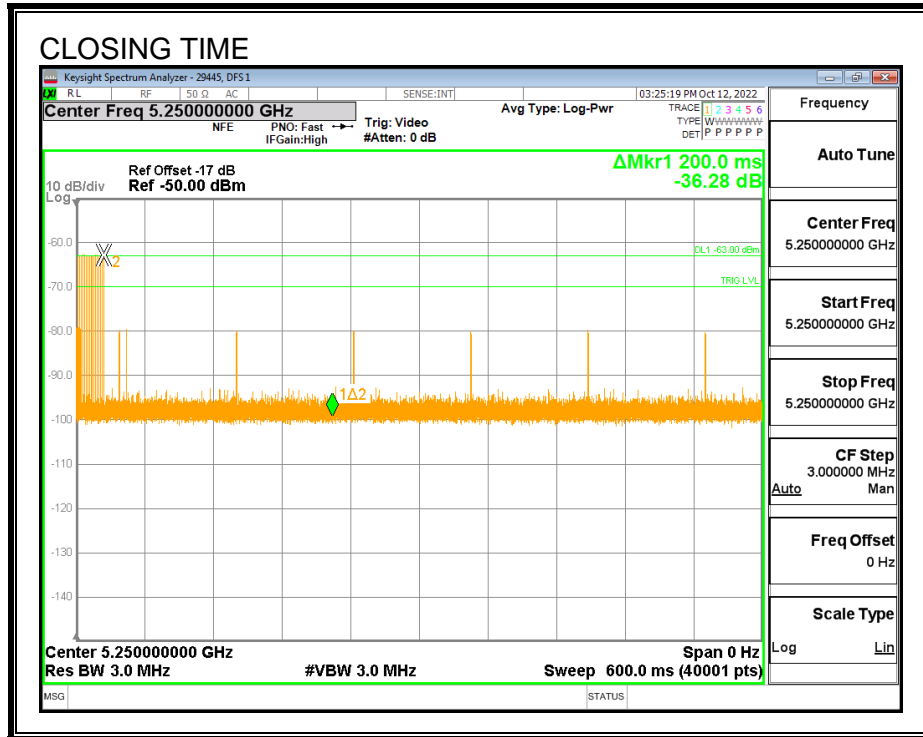

**AGGREGATE CHANNEL CLOSING TRANSMISSION TIME**

Only intermittent transmissions are observed during the aggregate monitoring period.

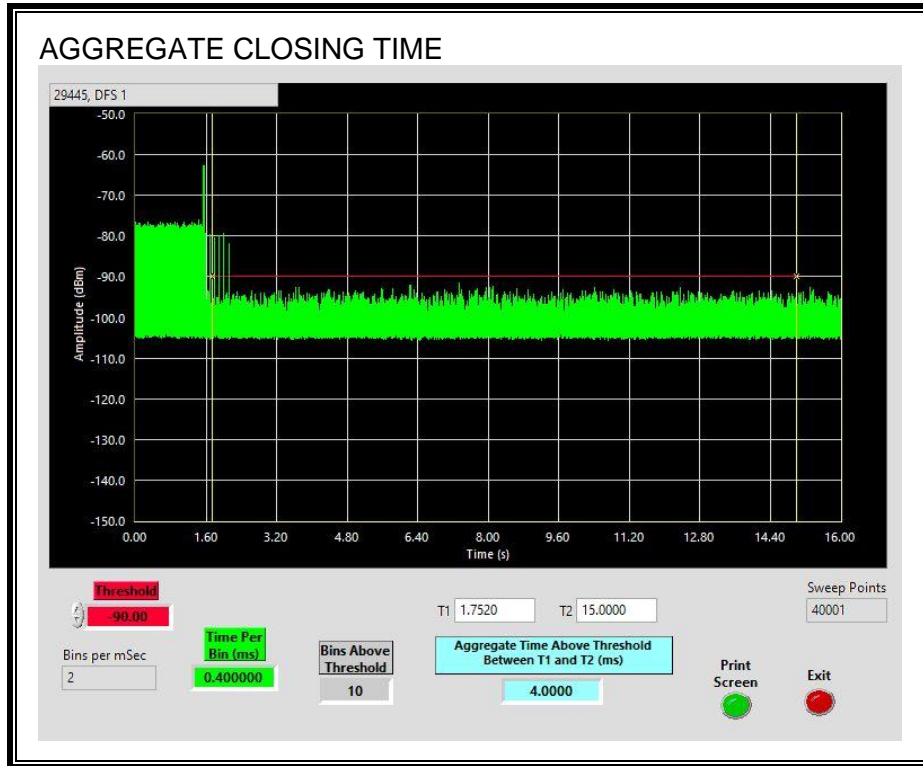

**LONG PULSE CHANNEL MOVE TIME**

The traffic ceases prior to 10 seconds after the end of the radar waveform.

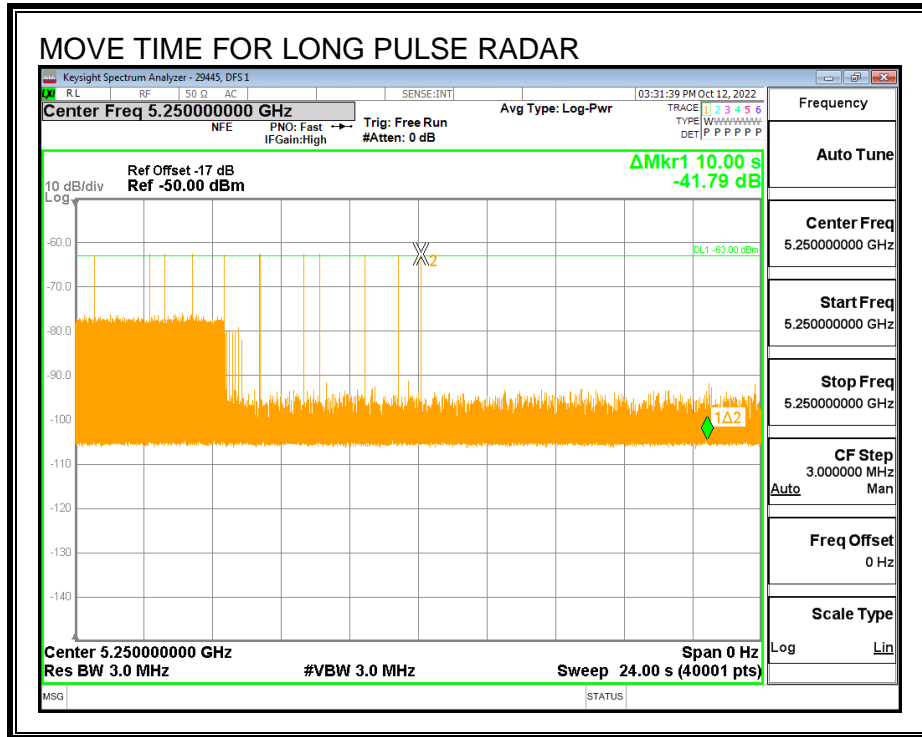

### 7.2.6. NON-OCCUPANCY PERIOD

#### RESULTS

No EUT transmissions were observed on the test channel during the 30-minute observation time.

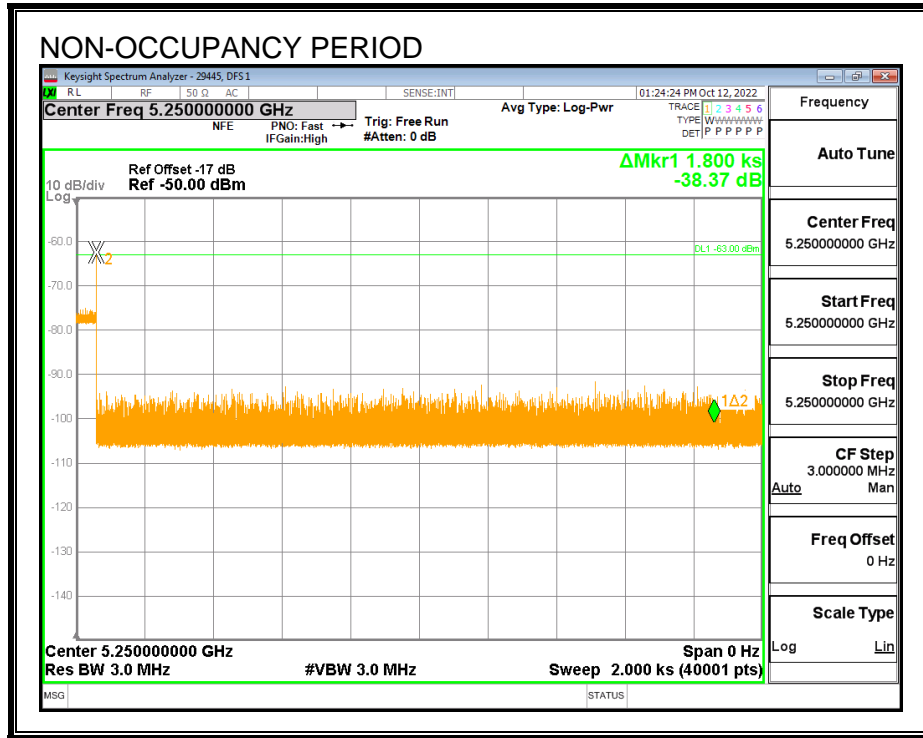

## 7.2.7. DETECTION BANDWIDTH

### REFERENCE PLOT OF 99% POWER BANDWIDTH

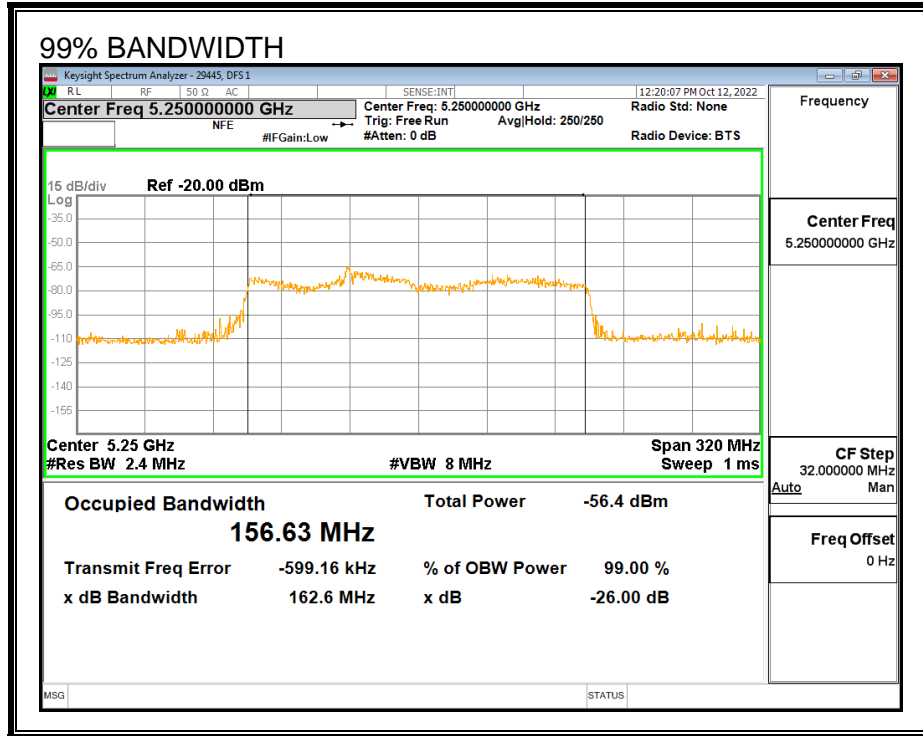

### RESULTS

$F_L$ (MHz)	$F_H$ (MHz)	Detection Bandwidth (MHz)	Full Span of 99% Power Bandwidth (MHz)	DFS Portion of the 99% Power Bandwidth (MHz)	Ratio of Detection BW to 99% Power BW (%)	Minimum Limit (%)
5250	5330	80	156.63	78.315	102.2	100

**Note:** Radar detection capability is not required below 5250 MHz and by design the EUT does not detect radar at frequencies below the 5250 MHz to 5350 MHz DFS band. Therefore, to demonstrate compliance to the requirements for Detection Bandwidth and In-Service Monitoring the occupied bandwidth used within the 5250 MHz to 5350 MHz DFS band while the EUT is operating at a channel bandwidth of 160 MHz is one half of the full span of the 99% power bandwidth.



**DETECTION BANDWIDTH PROBABILITY**

DETECTION BANDWIDTH PROBABILITY RESULTS				
Detection Bandwidth Test Results		29445	DFS 1	
FCC Type 0 Waveform: 1 us Pulse Width, 1428 us PRI, 18 Pulses per Burst				
Frequency (MHz)	Number of Trials	Number Detected	Detection (%)	Mark
5249	10	0	0	
5250	10	10	100	FL
5255	10	10	100	
5260	10	10	100	
5265	10	10	100	
5270	10	10	100	
5275	10	10	100	
5280	10	10	100	
5285	10	10	100	
5290	10	10	100	
5295	10	10	100	
5300	10	10	100	
5305	10	10	100	
5310	10	10	100	
5315	10	10	100	
5320	10	10	100	
5325	10	10	100	
5330	10	9	90	FH

## 7.2.8. IN-SERVICE MONITORING

### RESULTS

FCC Radar Test Summary										
Signal Type	Number of Trials	Detection (%)	Limit (%)	Pass/Fail	Detection Bandwidth		OBW	Test Location	Employee Number	In-Service Monitoring Version
					FL	FH				
FCC Short Pulse Type 1	30	100.00	60	Pass	5250	5330	156.63	DFS 1	29445	v4.1
FCC Short Pulse Type 2	30	100.00	60	Pass	5250	5330	156.63	DFS 1	29445	v4.1
FCC Short Pulse Type 3	30	96.67	60	Pass	5250	5330	156.63	DFS 1	29445	v4.1
FCC Short Pulse Type 4	30	86.67	60	Pass	5250	5330	156.63	DFS 1	29445	v4.1
Aggregate		95.83	80	Pass						
FCC Long Pulse Type 5	30	100.00	80	Pass	5250	5330	78.31	DFS 1	29445	v4.1
FCC Hopping Type 6	81	100.00	70	Pass	5250	5330		DFS 1	29445	v4.1

**TYPE 1 DETECTION PROBABILITY**

Data Sheet for FCC Short Pulse Radar Type 1						
Waveform	Pulse Width (us)	PRI (us)	Pulses Per Burst	Test (A/B)	Frequency (MHz)	Successful Detection (Yes/No)
1001	1	3066	18	A	5262	Yes
1002	1	558	95	A	5279	Yes
1003	1	838	63	A	5298	Yes
1004	1	538	99	A	5327	Yes
1005	1	778	68	A	5250	Yes
1006	1	898	59	A	5301	Yes
1007	1	878	61	A	5293	Yes
1008	1	578	92	A	5291	Yes
1009	1	518	102	A	5304	Yes
1010	1	798	67	A	5286	Yes
1011	1	698	76	A	5273	Yes
1012	1	858	62	A	5322	Yes
1013	1	658	81	A	5278	Yes
1014	1	918	58	A	5277	Yes
1015	1	598	89	A	5318	Yes
1016	1	987	54	B	5252	Yes
1017	1	748	71	B	5306	Yes
1018	1	2187	25	B	5324	Yes
1019	1	2078	26	B	5319	Yes
1020	1	2293	24	B	5280	Yes
1021	1	1119	48	B	5280	Yes
1022	1	2817	19	B	5281	Yes
1023	1	1772	30	B	5266	Yes
1024	1	2405	22	B	5279	Yes
1025	1	1490	36	B	5279	Yes
1026	1	2252	24	B	5276	Yes
1027	1	1466	37	B	5258	Yes
1028	1	1163	46	B	5309	Yes
1029	1	1861	29	B	5257	Yes
1030	1	2882	19	B	5282	Yes

**TYPE 2 DETECTION PROBABILITY**

Data Sheet for FCC Short Pulse Radar Type 2					
Waveform	Pulse Width (us)	PRI (us)	Pulses Per Burst	Frequency (MHz)	Successful Detection (Yes/No)
2001	1.6	161	26	5255	Yes
2002	1.3	153	27	5259	Yes
2003	3.7	219	29	5255	Yes
2004	1.7	215	23	5322	Yes
2005	2.3	205	29	5288	Yes
2006	4.6	167	24	5276	Yes
2007	1.4	161	23	5263	Yes
2008	3.9	170	29	5261	Yes
2009	3	167	29	5270	Yes
2010	1.6	181	28	5313	Yes
2011	1	226	24	5293	Yes
2012	4.1	162	28	5266	Yes
2013	3.7	173	25	5281	Yes
2014	4.9	195	28	5265	Yes
2015	2.8	210	26	5263	Yes
2016	2.2	197	29	5272	Yes
2017	4.4	217	28	5328	Yes
2018	4.1	208	25	5265	Yes
2019	2.4	194	27	5269	Yes
2020	4.5	190	28	5289	Yes
2021	1	179	27	5309	Yes
2022	3.3	222	29	5262	Yes
2023	4.2	216	28	5316	Yes
2024	2.6	225	27	5287	Yes
2025	1.7	223	23	5254	Yes
2026	2.5	155	29	5298	Yes
2027	3.8	200	29	5298	Yes
2028	2.8	217	25	5288	Yes
2029	2.4	228	29	5297	Yes
2030	3.6	169	26	5314	Yes

**TYPE 3 DETECTION PROBABILITY**

Data Sheet for FCC Short Pulse Radar Type 3					
Waveform	Pulse Width (us)	PRI (us)	Pulses Per Burst	Frequency (MHz)	Successful Detection (Yes/No)
3001	6.5	357	16	5328	No
3002	6	318	16	5279	Yes
3003	8.1	378	17	5267	Yes
3004	7.8	352	16	5273	Yes
3005	6.1	308	18	5290	Yes
3006	8.2	295	17	5273	Yes
3007	8.8	262	16	5286	Yes
3008	7	395	17	5303	Yes
3009	7.9	258	18	5259	Yes
3010	6.3	404	16	5307	Yes
3011	9.5	280	18	5274	Yes
3012	6.2	438	17	5263	Yes
3013	9.7	327	16	5292	Yes
3014	6.5	380	16	5287	Yes
3015	6.1	415	18	5281	Yes
3016	9.5	481	16	5292	Yes
3017	9.3	277	17	5283	Yes
3018	8.8	490	18	5303	Yes
3019	6.8	299	16	5321	Yes
3020	6.5	273	18	5258	Yes
3021	7	479	17	5255	Yes
3022	6.9	466	16	5277	Yes
3023	7.5	434	16	5291	Yes
3024	9.8	316	18	5271	Yes
3025	6.6	430	18	5321	Yes
3026	7.1	325	18	5266	Yes
3027	8.2	451	17	5286	Yes
3028	9	359	16	5258	Yes
3029	8.4	498	18	5261	Yes
3030	9.4	434	18	5315	Yes

**TYPE 4 DETECTION PROBABILITY**

Data Sheet for FCC Short Pulse Radar Type 4					
Waveform	Pulse Width (us)	PRI (us)	Pulses Per Burst	Frequency (MHz)	Successful Detection (Yes/No)
4001	17.6	335	13	5309	Yes
4002	15.9	402	16	5305	Yes
4003	15.5	449	12	5264	Yes
4004	14.3	410	14	5320	Yes
4005	19.1	470	15	5316	Yes
4006	18.4	445	13	5265	Yes
4007	19.4	400	12	5280	Yes
4008	19.2	269	13	5251	Yes
4009	11.6	488	15	5253	Yes
4010	16.6	488	14	5280	Yes
4011	18.6	350	13	5268	Yes
4012	19.8	496	15	5304	Yes
4013	13.1	372	12	5298	No
4014	14.8	279	12	5263	Yes
4015	13.4	301	14	5324	No
4016	15.6	355	14	5275	Yes
4017	14.7	256	12	5306	Yes
4018	13.1	456	14	5318	Yes
4019	12.6	370	15	5302	No
4020	11.4	331	13	5305	Yes
4021	16.2	391	14	5253	Yes
4022	11.3	499	12	5293	No
4023	16.6	320	16	5255	Yes
4024	12	441	12	5284	Yes
4025	17.8	408	16	5302	Yes
4026	13.7	290	12	5264	Yes
4027	15.7	271	12	5256	Yes
4028	16.9	417	16	5284	Yes
4029	19.3	292	16	5316	Yes
4030	12	333	15	5276	Yes

**TYPE 5 DETECTION PROBABILITY**

<b>Data Sheet for FCC Long Pulse Radar Type 5</b>		
<b>Trial</b>	<b>Frequency (MHz)</b>	<b>Successful Detection (Yes/No)</b>
1	5289	Yes
2	5289	Yes
3	5289	Yes
4	5289	Yes
5	5289	Yes
6	5289	Yes
7	5289	Yes
8	5289	Yes
9	5289	Yes
10	5289	Yes
11	5252	Yes
12	5255	Yes
13	5255	Yes
14	5252	Yes
15	5255	Yes
16	5255	Yes
17	5252	Yes
18	5255	Yes
19	5255	Yes
20	5256	Yes
21	5324	Yes
22	5323	Yes
23	5321	Yes
24	5324	Yes
25	5323	Yes
26	5325	Yes
27	5321	Yes
28	5325	Yes
29	5325	Yes
30	5323	Yes

Note: The Type 5 randomized parameters tested are shown in a separate document.

**TYPE 6 DETECTION PROBABILITY**

Data Sheet for FCC Hopping Radar Type 6				
1 us Pulse Width, 333 us PRI, 9 Pulses per Burst, 1 Burst per Hop				
NTIA August 2005 Hopping Sequence				
Trial	Starting Index Within Sequence	Signal Generator Frequency (MHz)	Hops within Detection BW	Successful Detection (Yes/No)
1	797	5250	21	Yes
2	1272	5251	25	Yes
3	1747	5252	14	Yes
4	2222	5253	13	Yes
5	2697	5254	19	Yes
6	3172	5255	18	Yes
7	3647	5256	9	Yes
8	4122	5257	13	Yes
9	4597	5258	19	Yes
10	5072	5259	18	Yes
11	5547	5260	21	Yes
12	6022	5261	25	Yes
13	6497	5262	17	Yes
14	6972	5263	19	Yes
15	7447	5264	13	Yes
16	7922	5265	20	Yes
17	8397	5266	19	Yes
18	8872	5267	14	Yes
19	9347	5268	15	Yes
20	9822	5269	20	Yes
21	10297	5270	17	Yes
22	10772	5271	13	Yes
23	11247	5272	13	Yes
24	11722	5273	13	Yes
25	12197	5274	21	Yes
26	12672	5275	15	Yes
27	13147	5276	18	Yes
28	13622	5277	14	Yes
29	14097	5278	15	Yes
30	14572	5279	17	Yes
31	15047	5280	16	Yes
32	15522	5281	11	Yes
33	15997	5282	18	Yes
34	16472	5283	20	Yes
35	16947	5284	19	Yes
36	17422	5285	22	Yes
37	17897	5286	19	Yes
38	18372	5287	13	Yes
39	18847	5288	17	Yes



**TYPE 6 DETECTION PROBABILITY (CONTINUED)**

40	19322	5289	15	Yes
41	19797	5290	17	Yes
42	20272	5291	10	Yes
43	20747	5292	16	Yes
44	21222	5293	15	Yes
45	21697	5294	15	Yes
46	22172	5295	12	Yes
47	22647	5296	18	Yes
48	23122	5297	19	Yes
49	23597	5298	16	Yes
50	24072	5299	15	Yes
51	24547	5300	12	Yes
52	25022	5301	22	Yes
53	25497	5302	20	Yes
54	25972	5303	18	Yes
55	26447	5304	25	Yes
56	26922	5305	16	Yes
57	27397	5306	14	Yes
58	27872	5307	15	Yes
59	28347	5308	18	Yes
60	28822	5309	19	Yes
61	29297	5310	14	Yes
62	29772	5311	10	Yes
63	30247	5312	22	Yes
64	30722	5313	20	Yes
65	31197	5314	14	Yes
66	31672	5315	16	Yes
67	32147	5316	20	Yes
68	32622	5317	17	Yes
69	33097	5318	16	Yes
70	33572	5319	21	Yes
71	34047	5320	13	Yes
72	34522	5321	18	Yes
73	34997	5322	16	Yes
74	35472	5323	13	Yes
75	35947	5324	11	Yes
76	36422	5325	14	Yes
77	36897	5326	19	Yes
78	37372	5327	18	Yes
79	37847	5328	21	Yes
80	38322	5329	16	Yes
81	38797	5330	18	Yes

### 7.3. UPPER BAND MASTER RESULTS FOR 160 MHz BANDWIDTH

#### 7.3.1. TEST CHANNEL

All tests were performed at a channel center frequency of 5570 MHz.

#### 7.3.2. RADAR WAVEFORMS AND TRAFFIC

##### RADAR WAVEFORMS

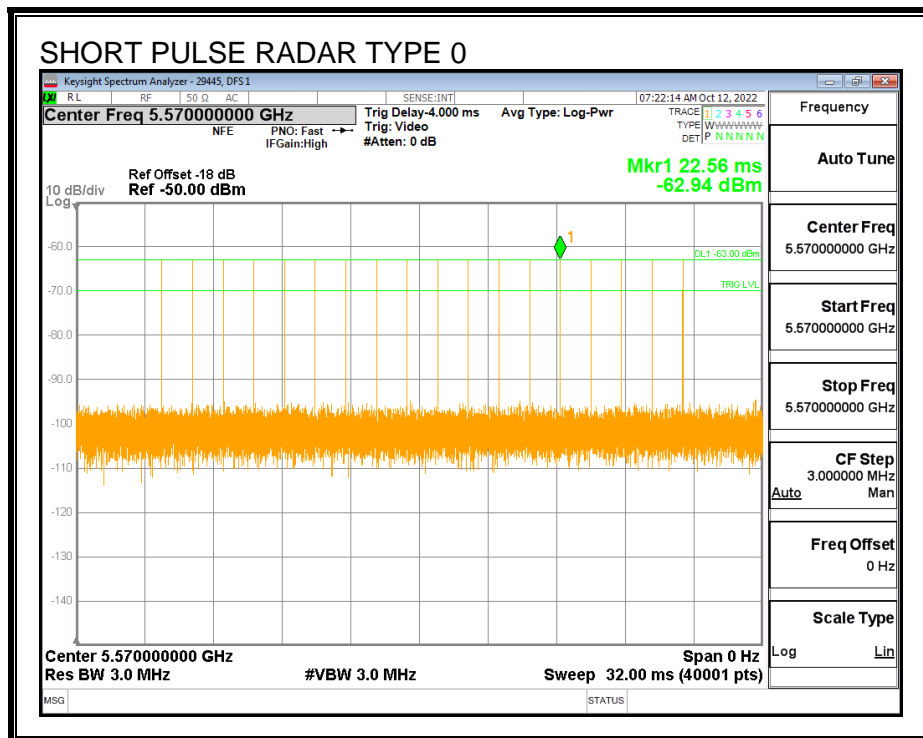

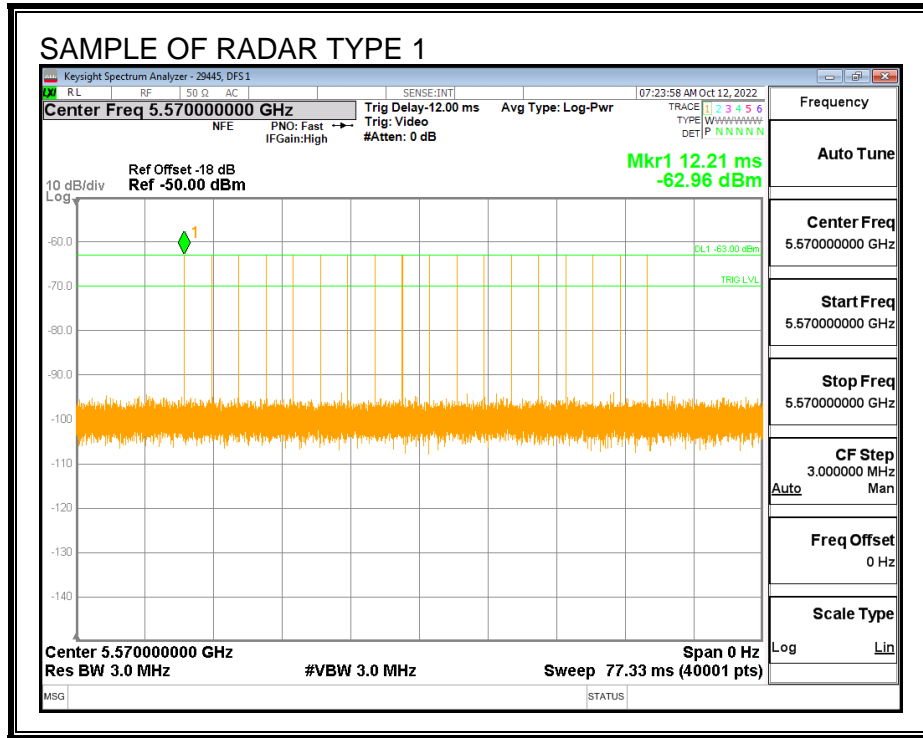

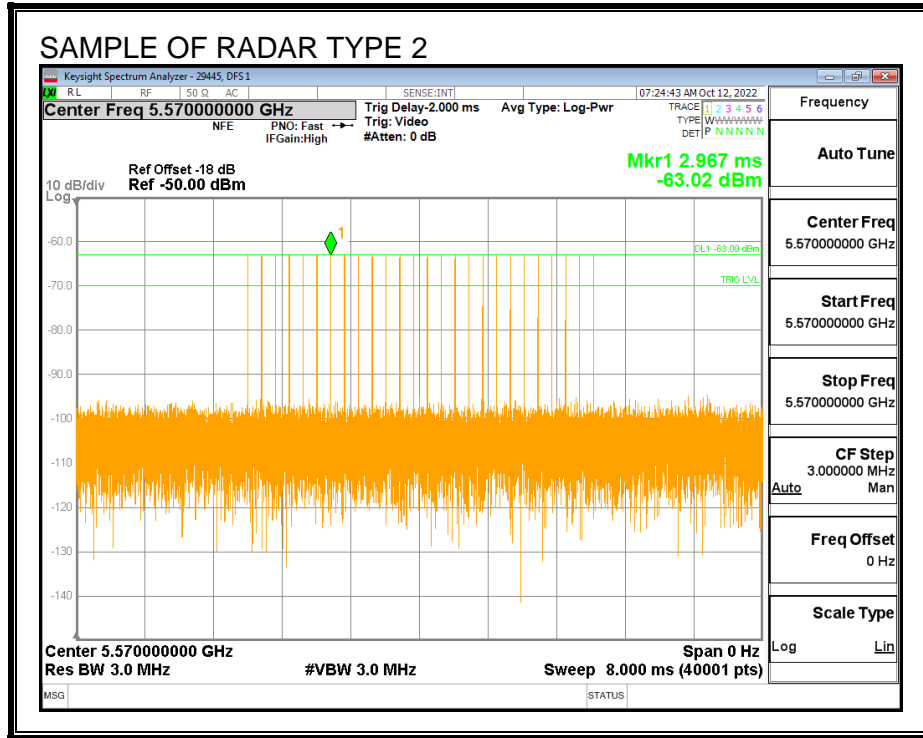

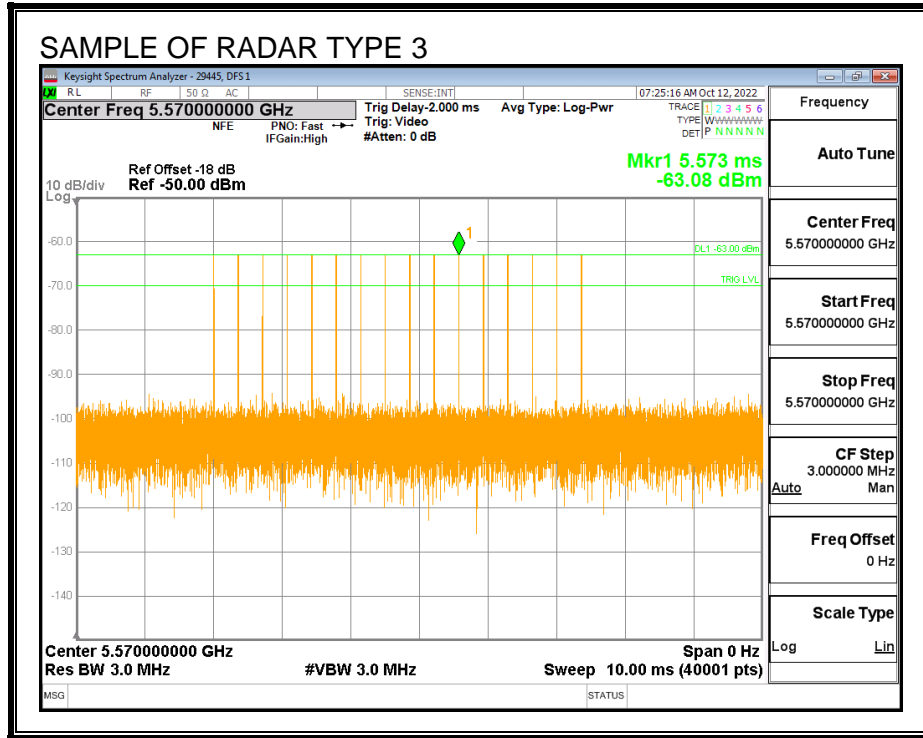

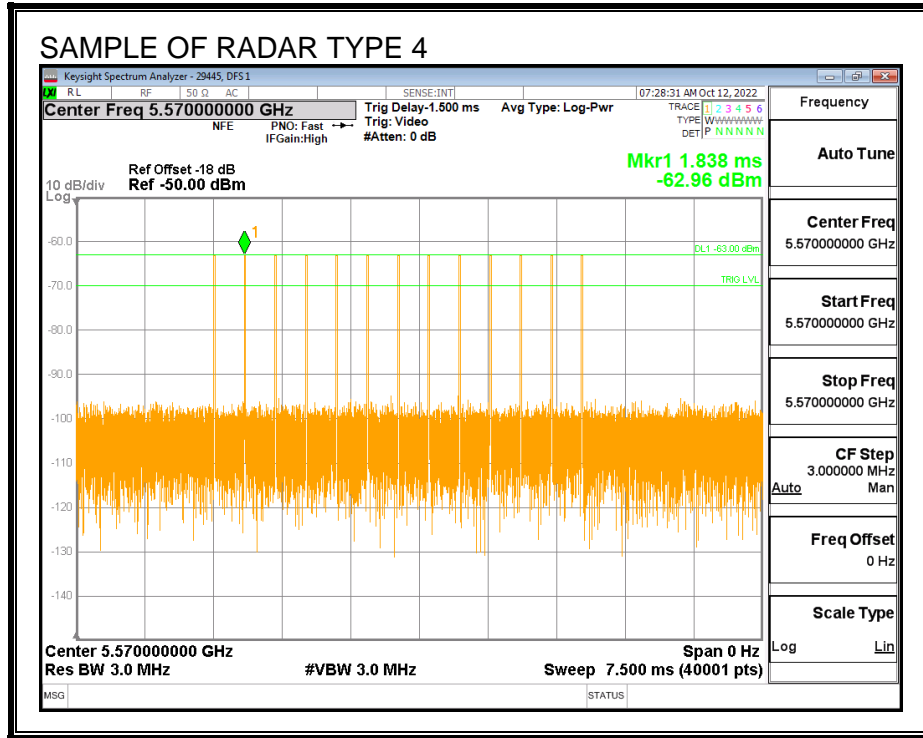

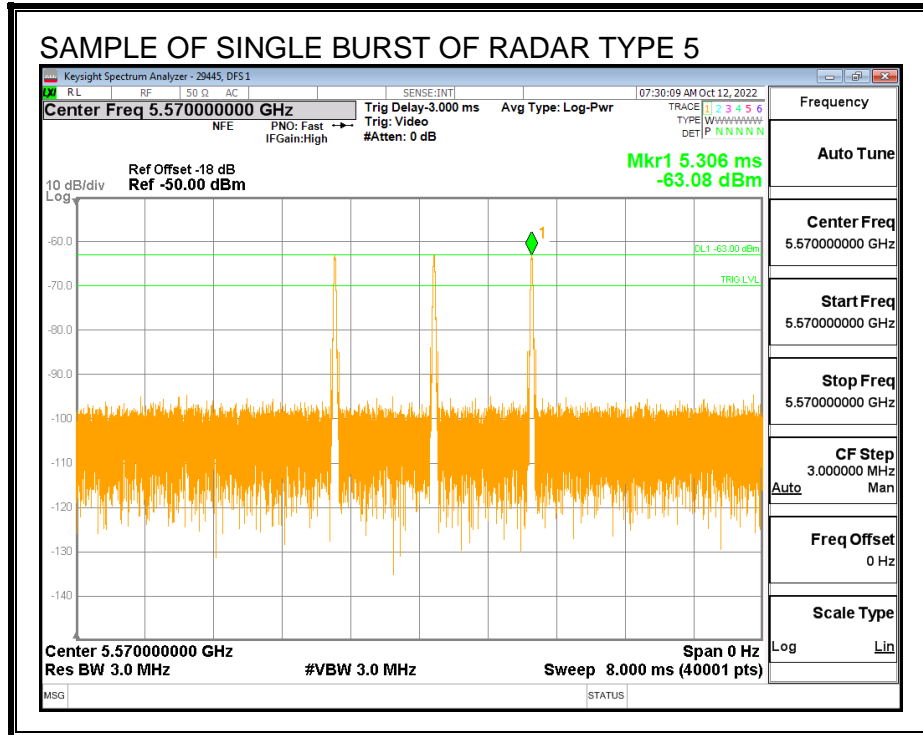

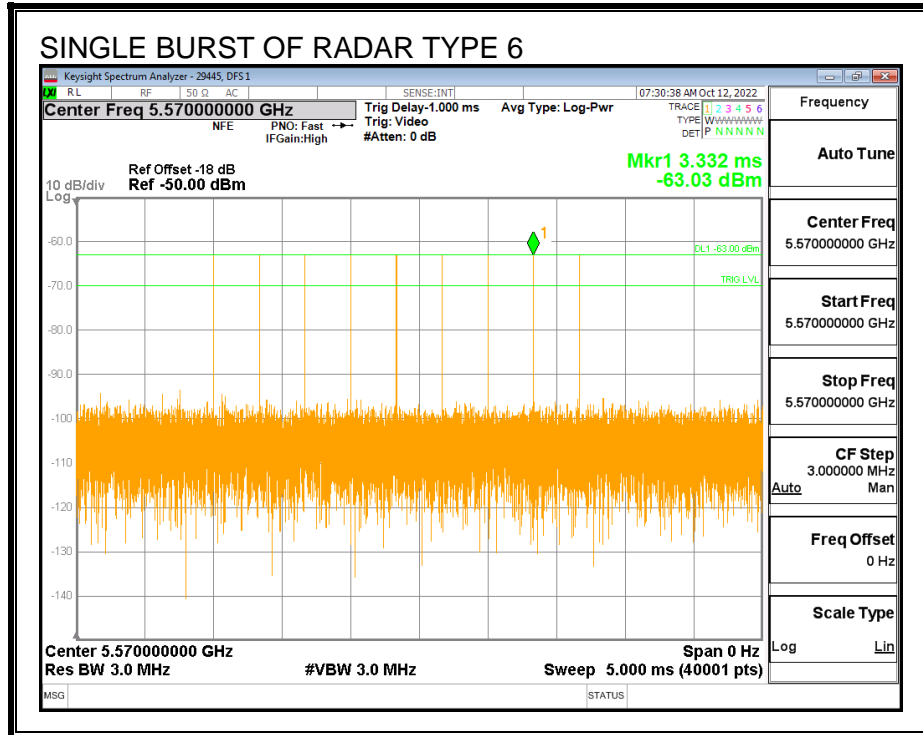



**TRAFFIC**

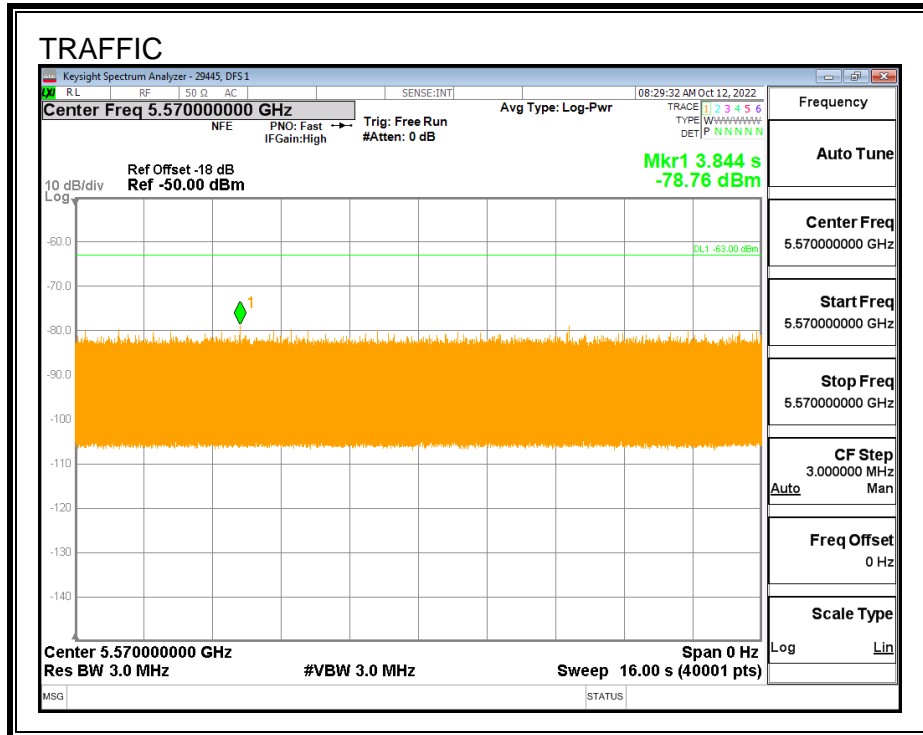

**CHANNEL LOADING**

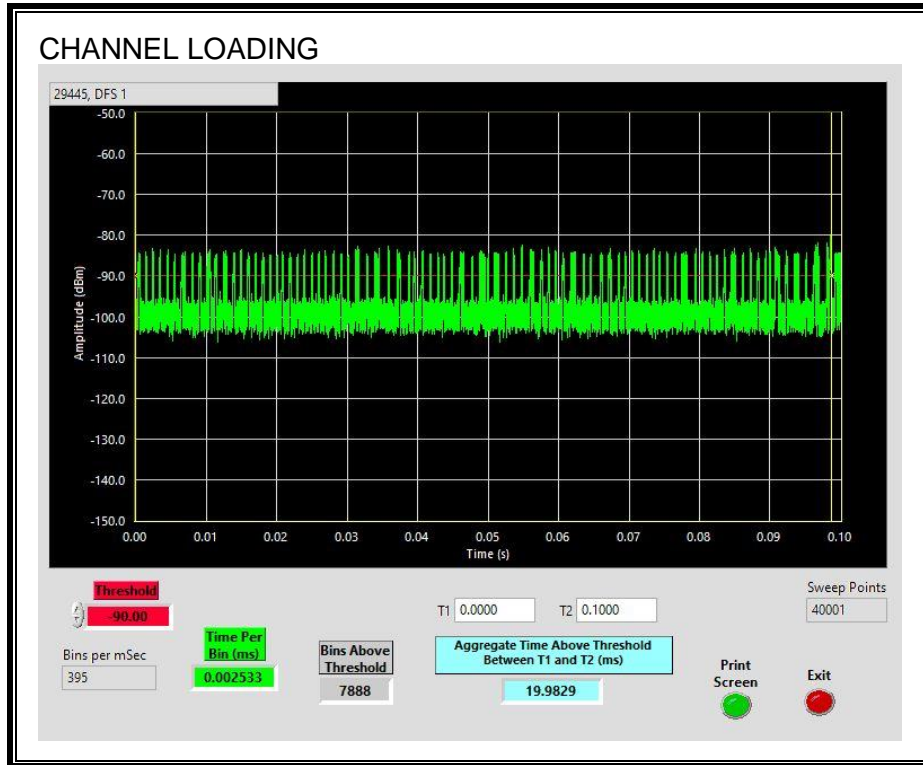

The level of traffic loading on the channel by the EUT is 19.98%

### **7.3.3. CHANNEL AVAILABILITY CHECK TIME**

#### **PROCEDURE TO DETERMINE INITIAL POWER-UP CYCLE TIME**

A link was established on channel then the EUT was rebooted. The time from the cessation of traffic to the re-initialization of traffic was measured as the time required for the EUT to complete the total power-up cycle. The time to complete the initial power-up period is 60 seconds less than this total power-up time.

#### **PROCEDURE FOR TIMING OF RADAR BURST**

With a link established on channel, the EUT was rebooted. A radar signal was triggered within 0 to 6 seconds after the initial power-up period, and transmissions on the channel were monitored on the spectrum analyzer.

The Non-Occupancy list was cleared. With a link established on channel, the EUT was rebooted. A radar signal was triggered within 54 to 60 seconds after the initial power-up period, and transmissions on the channel were monitored on the spectrum analyzer.

**QUANTITATIVE RESULTS**

**No Radar Triggered**

Timing of Reboot (sec)	Timing of Start of Traffic (sec)	Total Power-up Cycle Time (sec)	Initial Power-up Cycle Time (sec)
30.77	229.3	198.5	138.5

**Radar Near Beginning of CAC**

Timing of Reboot (sec)	Timing of Radar Burst (sec)	Radar Relative to Reboot (sec)	Radar Relative to Start of CAC (sec)
29.83	171.6	141.8	3.2

**Radar Near End of CAC**

Timing of Reboot (sec)	Timing of Radar Burst (sec)	Radar Relative to Reboot (sec)	Radar Relative to Start of CAC (sec)
30.13	226.0	195.9	57.3

**QUALITATIVE RESULTS**

Timing of Radar Burst	Display on Control Computer	Spectrum Analyzer Display
No Radar Triggered	EUT marks Channel as active	Transmissions begin on channel after completion of the initial power-up cycle and the CAC
Within 0 to 6 second window	EUT indicates radar detected	No transmissions on channel
Within 54 to 60 second window	EUT indicates radar detected	No transmissions on channel

**TIMING WITHOUT RADAR DURING CAC**

AP is rebooted  
Traffic ceases  
Start of Initial Power-up cycle

End of Initial Power-up cycle  
Start of CAC

End of CAC  
Traffic is Initiated

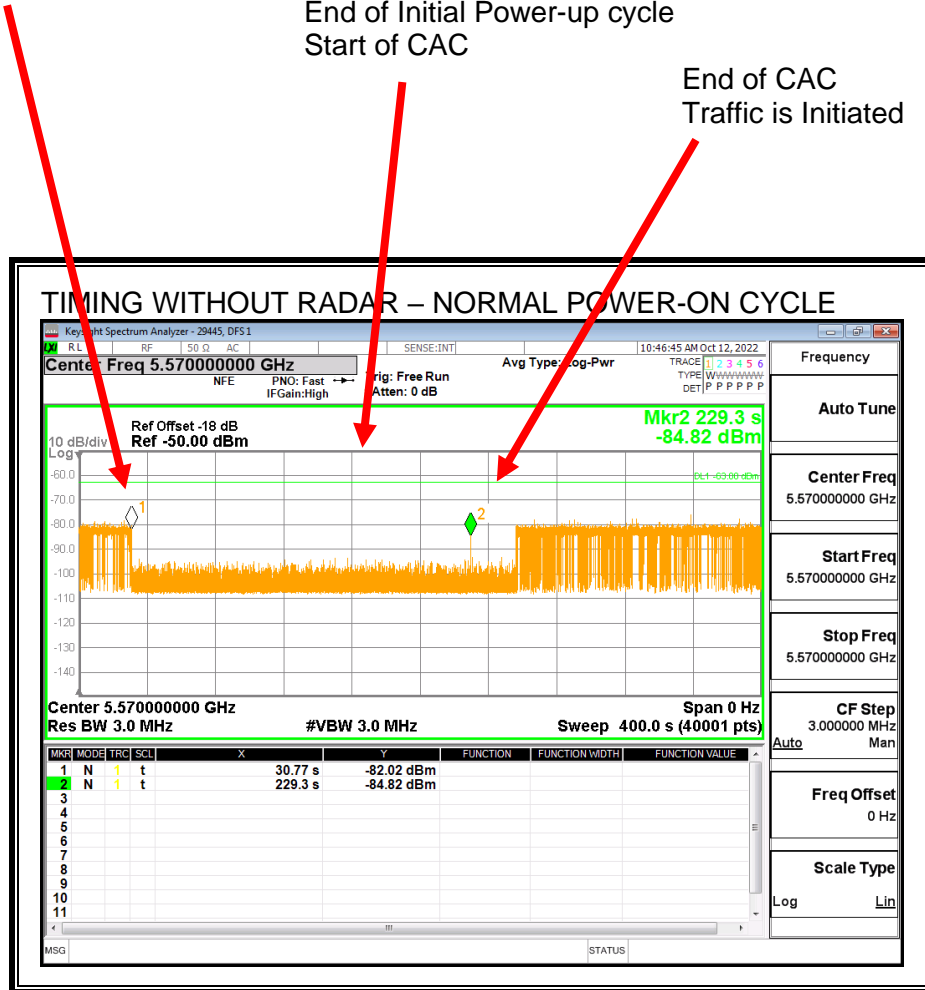

Transmissions begin on channel after completion of the initial power-up cycle and the CAC.

**TIMING WITH RADAR NEAR BEGINNING OF CAC**

AP is rebooted  
Traffic ceases  
Start of Initial Power-up cycle

End of Initial Power-up cycle  
Start of CAC

Radar Signal Applied

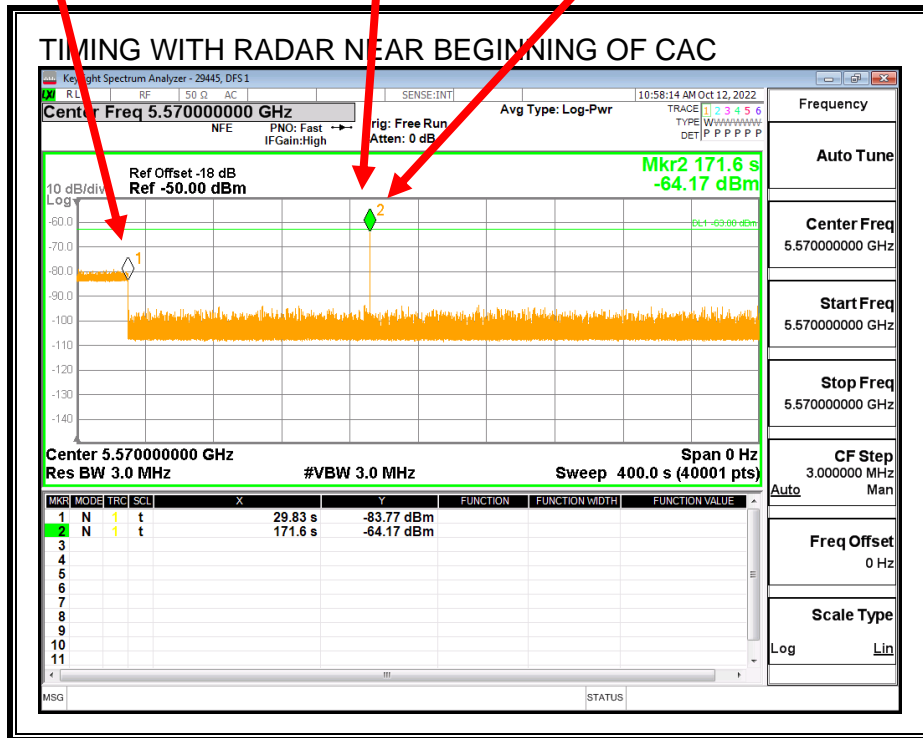

No EUT transmissions were observed after the radar signal.

**TIMING WITH RADAR NEAR END OF CAC**

AP is rebooted  
Traffic ceases  
Start of Initial Power-up cycle

End of Initial Power-up cycle  
Start of CAC

Radar Signal Applied

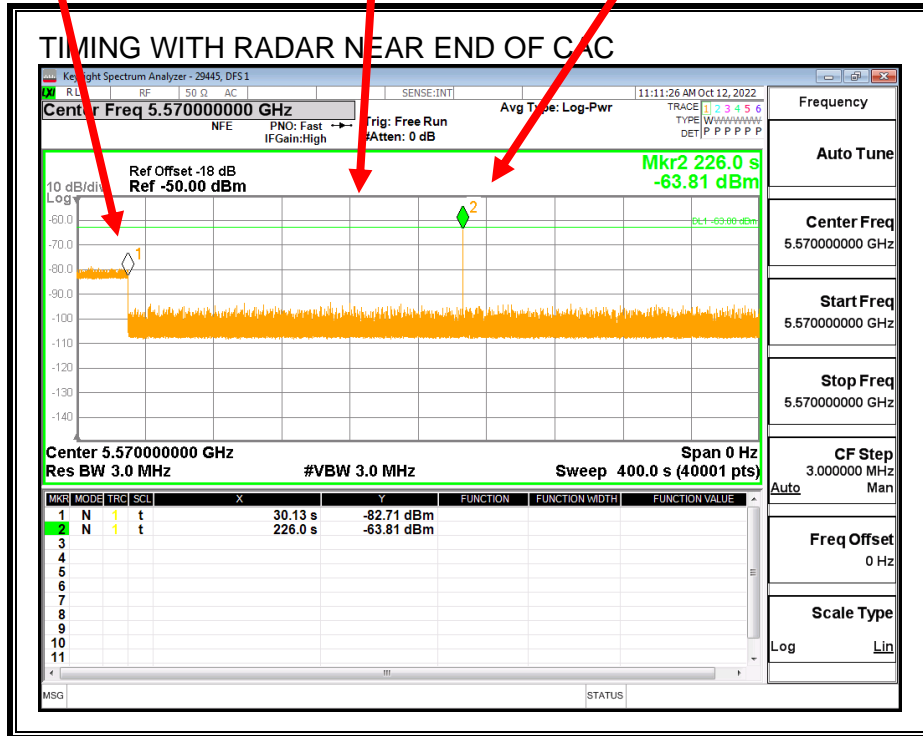

No EUT transmissions were observed after the radar signal.

### 7.3.4. OVERLAPPING CHANNEL TESTS

#### RESULTS

The channel spacing is not less than the channel bandwidth therefore the EUT does not have an overlapping channel plan.

### 7.3.5. MOVE AND CLOSING TIME

#### REPORTING NOTES

The reference marker is set at the end of last radar pulse.

The delta marker is set at the end of the last WLAN transmission following the radar pulse. This delta is the channel move time.

The aggregate channel closing transmission time is calculated as follows:

Aggregate Transmission Time =  
(Number of analyzer bins showing transmission) \* (dwell time per bin)

The observation period over which the aggregate time is calculated begins at (Reference Marker + 200 msec) and ends no earlier than (Reference Marker + 10 sec).

#### RESULTS

<b>Channel Move Time (sec)</b>	<b>Limit (sec)</b>
<b>0.0</b>	<b>10</b>

<b>Aggregate Channel Closing Transmission Time (msec)</b>	<b>Limit (msec)</b>
<b>0.0</b>	<b>60</b>



**MOVE TIME**

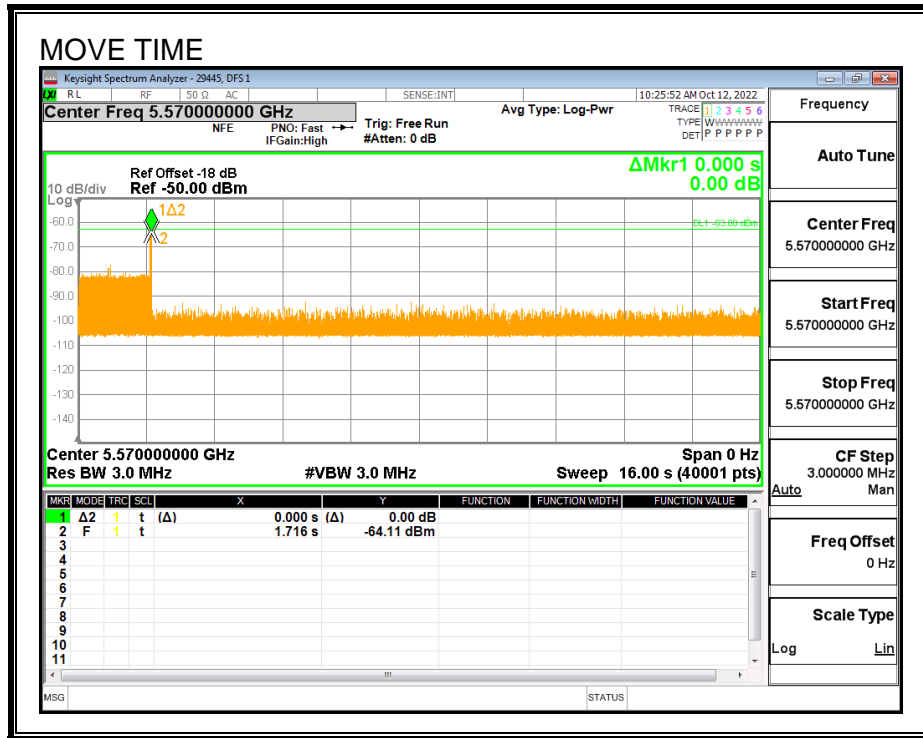

**CHANNEL CLOSING TIME**

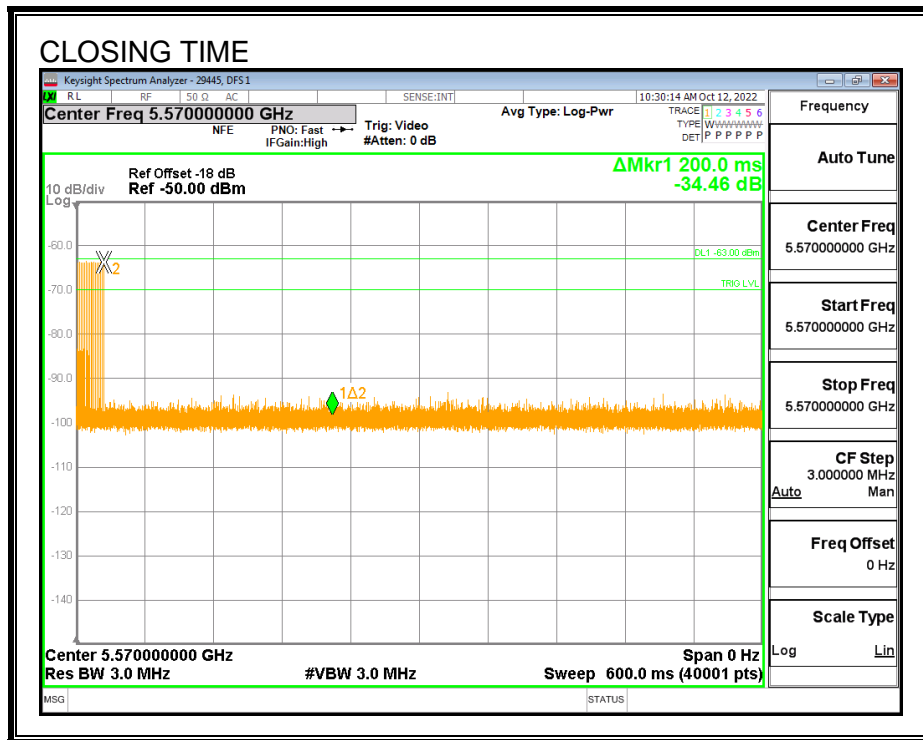

**AGGREGATE CHANNEL CLOSING TRANSMISSION TIME**

No transmissions are observed during the aggregate monitoring period.

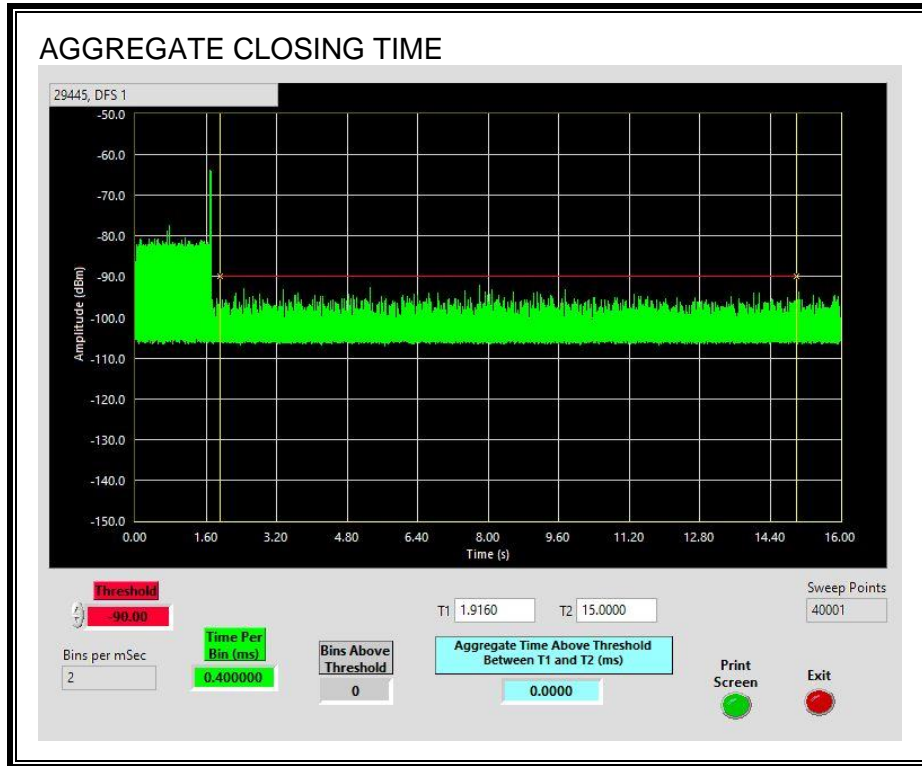

**LONG PULSE CHANNEL MOVE TIME**

The traffic ceases prior to 10 seconds after the end of the radar waveform.

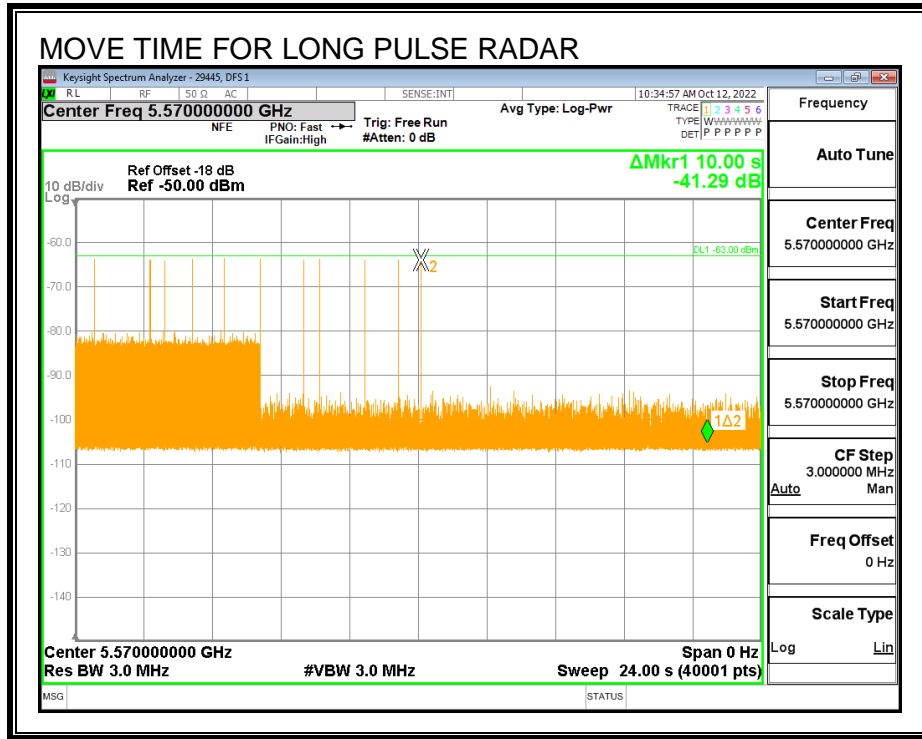

### 7.3.6. NON-OCCUPANCY PERIOD

#### RESULTS

No EUT transmissions were observed on the test channel during the 30-minute observation time.

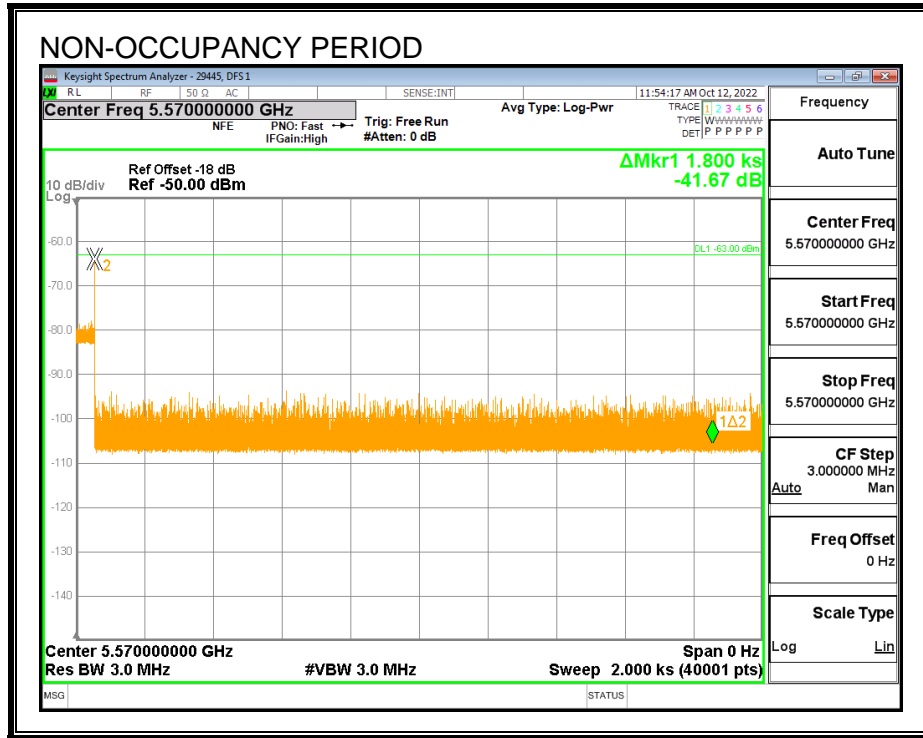

### 7.3.7. DETECTION BANDWIDTH

#### REFERENCE PLOT OF 99% POWER BANDWIDTH

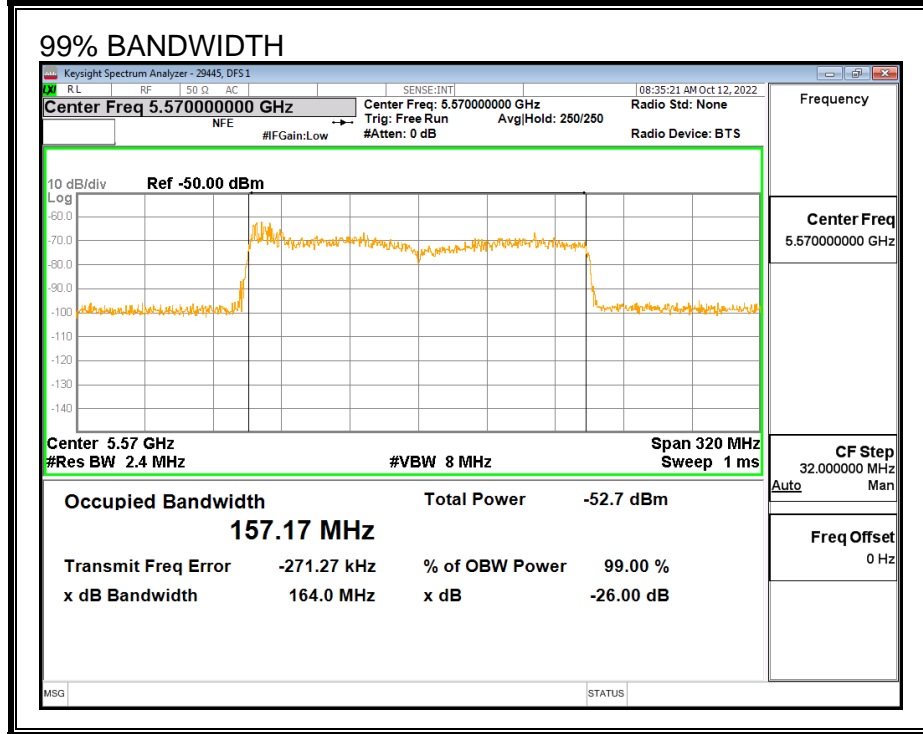

#### RESULTS

$F_L$ (MHz)	$F_H$ (MHz)	Detection Bandwidth (MHz)	99% Power Bandwidth (MHz)	Ratio of Detection BW to 99% Power BW (%)	Minimum Limit (%)
5490	5650	160	157.17	101.8	100

**DETECTION BANDWIDTH PROBABILITY**

DETECTION BANDWIDTH PROBABILITY RESULTS				
Detection Bandwidth Test Results		29445	DFS 1	
FCC Type 0 Waveform: 1 us Pulse Width, 1428 us PRI, 18 Pulses per Burst				
Frequency (MHz)	Number of Trials	Number Detected	Detection (%)	Mark
5490	10	9	90	FL
5495	10	10	100	
5500	10	10	100	
5505	10	10	100	
5510	10	10	100	
5515	10	10	100	
5520	10	10	100	
5525	10	10	100	
5530	10	10	100	
5535	10	10	100	
5540	10	10	100	
5545	10	10	100	
5550	10	10	100	
5555	10	10	100	
5560	10	10	100	
5565	10	10	100	
5570	10	10	100	
5575	10	10	100	
5580	10	10	100	
5585	10	10	100	
5590	10	10	100	
5595	10	10	100	
5600	10	10	100	
5605	10	10	100	
5610	10	10	100	
5615	10	10	100	
5620	10	10	100	
5625	10	10	100	
5630	10	10	100	
5635	10	10	100	
5640	10	10	100	
5645	10	10	100	
5650	10	10	100	FH

### 7.3.8. IN-SERVICE MONITORING

#### RESULTS

FCC Radar Test Summary										
Signal Type	Number of Trials	Detection (%)	Limit (%)	Pass/Fail	Detection Bandwidth		OBW	Test Location	Employee Number	In-Service Monitoring Version
					FL	FH				
FCC Short Pulse Type 1	30	96.67	60	Pass	5490	5650	157.17	DFS 1	29445	v4.1
FCC Short Pulse Type 2	30	96.67	60	Pass	5490	5650	157.17	DFS 1	29445	v4.1
FCC Short Pulse Type 3	30	93.33	60	Pass	5490	5650	157.17	DFS 1	29445	v4.1
FCC Short Pulse Type 4	30	90.00	60	Pass	5490	5650	157.17	DFS 1	29445	v4.1
Aggregate		94.17	80	Pass						
FCC Long Pulse Type 5	30	100.00	80	Pass	5490	5650	157.17	DFS 1	29445	v4.1
FCC Hopping Type 6	161	100.00	70	Pass	5490	5650		DFS 1	29445	v4.1



**TYPE 1 DETECTION PROBABILITY**

Data Sheet for FCC Short Pulse Radar Type 1						
Waveform	Pulse Width (us)	PRI (us)	Pulses Per Burst	Test (A/B)	Frequency (MHz)	Successful Detection (Yes/No)
1001	1	3066	18	A	5523	No
1002	1	558	95	A	5602	Yes
1003	1	838	63	A	5644	Yes
1004	1	538	99	A	5581	Yes
1005	1	778	68	A	5588	Yes
1006	1	898	59	A	5644	Yes
1007	1	878	61	A	5503	Yes
1008	1	578	92	A	5548	Yes
1009	1	518	102	A	5535	Yes
1010	1	798	67	A	5615	Yes
1011	1	698	76	A	5591	Yes
1012	1	858	62	A	5608	Yes
1013	1	658	81	A	5524	Yes
1014	1	918	58	A	5518	Yes
1015	1	598	89	A	5590	Yes
1016	1	987	54	B	5512	Yes
1017	1	748	71	B	5500	Yes
1018	1	2187	25	B	5507	Yes
1019	1	2078	26	B	5531	Yes
1020	1	2293	24	B	5523	Yes
1021	1	1119	48	B	5523	Yes
1022	1	2817	19	B	5581	Yes
1023	1	1772	30	B	5645	Yes
1024	1	2405	22	B	5515	Yes
1025	1	1490	36	B	5534	Yes
1026	1	2252	24	B	5648	Yes
1027	1	1466	37	B	5570	Yes
1028	1	1163	46	B	5558	Yes
1029	1	1861	29	B	5569	Yes
1030	1	2882	19	B	5519	Yes

**TYPE 2 DETECTION PROBABILITY**

Data Sheet for FCC Short Pulse Radar Type 2					
Waveform	Pulse Width (us)	PRI (us)	Pulses Per Burst	Frequency (MHz)	Successful Detection (Yes/No)
2001	1.6	161	26	5605	Yes
2002	1.3	153	27	5544	Yes
2003	3.7	219	29	5574	No
2004	1.7	215	23	5549	Yes
2005	2.3	205	29	5517	Yes
2006	4.6	167	24	5590	Yes
2007	1.4	161	23	5650	Yes
2008	3.9	170	29	5617	Yes
2009	3	167	29	5635	Yes
2010	1.6	181	28	5577	Yes
2011	1	226	24	5617	Yes
2012	4.1	162	28	5502	Yes
2013	3.7	173	25	5559	Yes
2014	4.9	195	28	5525	Yes
2015	2.8	210	26	5538	Yes
2016	2.2	197	29	5646	Yes
2017	4.4	217	28	5626	Yes
2018	4.1	208	25	5513	Yes
2019	2.4	194	27	5493	Yes
2020	4.5	190	28	5621	Yes
2021	1	179	27	5577	Yes
2022	3.3	222	29	5553	Yes
2023	4.2	216	28	5598	Yes
2024	2.6	225	27	5644	Yes
2025	1.7	223	23	5549	Yes
2026	2.5	155	29	5583	Yes
2027	3.8	200	29	5509	Yes
2028	2.8	217	25	5552	Yes
2029	2.4	228	29	5582	Yes
2030	3.6	169	26	5649	Yes

**TYPE 3 DETECTION PROBABILITY**

Data Sheet for FCC Short Pulse Radar Type 3					
Waveform	Pulse Width (us)	PRI (us)	Pulses Per Burst	Frequency (MHz)	Successful Detection (Yes/No)
3001	6.5	357	16	5626	Yes
3002	6	318	16	5600	Yes
3003	8.1	378	17	5498	Yes
3004	7.8	352	16	5551	Yes
3005	6.1	308	18	5642	Yes
3006	8.2	295	17	5635	Yes
3007	8.8	262	16	5552	No
3008	7	395	17	5520	No
3009	7.9	258	18	5561	Yes
3010	6.3	404	16	5518	Yes
3011	9.5	280	18	5581	Yes
3012	6.2	438	17	5590	Yes
3013	9.7	327	16	5516	Yes
3014	6.5	380	16	5619	Yes
3015	6.1	415	18	5540	Yes
3016	9.5	481	16	5512	Yes
3017	9.3	277	17	5550	Yes
3018	8.8	490	18	5584	Yes
3019	6.8	299	16	5650	Yes
3020	6.5	273	18	5543	Yes
3021	7	479	17	5527	Yes
3022	6.9	466	16	5528	Yes
3023	7.5	434	16	5559	Yes
3024	9.8	316	18	5541	Yes
3025	6.6	430	18	5504	Yes
3026	7.1	325	18	5608	Yes
3027	8.2	451	17	5515	Yes
3028	9	359	16	5512	Yes
3029	8.4	498	18	5644	Yes
3030	9.4	434	18	5505	Yes

**TYPE 4 DETECTION PROBABILITY**

Data Sheet for FCC Short Pulse Radar Type 4					
Waveform	Pulse Width (us)	PRI (us)	Pulses Per Burst	Frequency (MHz)	Successful Detection (Yes/No)
4001	17.6	335	13	5540	Yes
4002	15.9	402	16	5574	Yes
4003	15.5	449	12	5541	Yes
4004	14.3	410	14	5582	Yes
4005	19.1	470	15	5500	Yes
4006	18.4	445	13	5494	Yes
4007	19.4	400	12	5549	Yes
4008	19.2	269	13	5519	Yes
4009	11.6	488	15	5530	Yes
4010	16.6	488	14	5536	Yes
4011	18.6	350	13	5628	Yes
4012	19.8	496	15	5597	Yes
4013	13.1	372	12	5547	Yes
4014	14.8	279	12	5491	Yes
4015	13.4	301	14	5647	Yes
4016	15.6	355	14	5627	Yes
4017	14.7	256	12	5560	Yes
4018	13.1	456	14	5622	Yes
4019	12.6	370	15	5535	Yes
4020	11.4	331	13	5644	Yes
4021	16.2	391	14	5594	Yes
4022	11.3	499	12	5650	Yes
4023	16.6	320	16	5624	No
4024	12	441	12	5640	Yes
4025	17.8	408	16	5533	No
4026	13.7	290	12	5513	Yes
4027	15.7	271	12	5534	Yes
4028	16.9	417	16	5640	No
4029	19.3	292	16	5607	Yes
4030	12	333	15	5504	Yes

**TYPE 5 DETECTION PROBABILITY**

<b>Data Sheet for FCC Long Pulse Radar Type 5</b>		
<b>Trial</b>	<b>Frequency (MHz)</b>	<b>Successful Detection (Yes/No)</b>
1	5570	Yes
2	5570	Yes
3	5570	Yes
4	5570	Yes
5	5570	Yes
6	5570	Yes
7	5570	Yes
8	5570	Yes
9	5570	Yes
10	5570	Yes
11	5494	Yes
12	5497	Yes
13	5497	Yes
14	5494	Yes
15	5497	Yes
16	5497	Yes
17	5494	Yes
18	5497	Yes
19	5497	Yes
20	5498	Yes
21	5644	Yes
22	5643	Yes
23	5642	Yes
24	5645	Yes
25	5643	Yes
26	5645	Yes
27	5641	Yes
28	5645	Yes
29	5646	Yes
30	5643	Yes

Note: The Type 5 randomized parameters tested are shown in a separate document.

**TYPE 6 DETECTION PROBABILITY**

Data Sheet for FCC Hopping Radar Type 6				
1 us Pulse Width, 333 us PRI, 9 Pulses per Burst, 1 Burst per Hop				
NTIA August 2005 Hopping Sequence				
Trial	Starting Index Within Sequence	Signal Generator Frequency (MHz)	Hops within Detection BW	Successful Detection (Yes/No)
1	624	5490	41	Yes
2	1099	5491	35	Yes
3	1574	5492	35	Yes
4	2049	5493	31	Yes
5	2524	5494	33	Yes
6	2999	5495	35	Yes
7	3474	5496	32	Yes
8	3949	5497	28	Yes
9	4424	5498	28	Yes
10	4899	5499	33	Yes
11	5374	5500	35	Yes
12	5849	5501	41	Yes
13	6324	5502	28	Yes
14	6799	5503	31	Yes
15	7274	5504	32	Yes
16	7749	5505	37	Yes
17	8224	5506	34	Yes
18	8699	5507	38	Yes
19	9174	5508	31	Yes
20	9649	5509	40	Yes
21	10124	5510	38	Yes
22	10599	5511	32	Yes
23	11074	5512	34	Yes
24	11549	5513	31	Yes
25	12024	5514	37	Yes
26	12499	5515	34	Yes
27	12974	5516	28	Yes
28	13449	5517	40	Yes
29	13924	5518	31	Yes
30	14399	5519	24	Yes
31	14874	5520	36	Yes
32	15349	5521	37	Yes
33	15824	5522	36	Yes
34	16299	5523	33	Yes
35	16774	5524	37	Yes
36	17249	5525	25	Yes
37	17724	5526	32	Yes
38	18199	5527	35	Yes
39	18674	5528	42	Yes

**TYPE 6 DETECTION PROBABILITY (CONTINUED)**

40	19149	5529	34	Yes
41	19624	5530	39	Yes
42	20099	5531	36	Yes
43	20574	5532	37	Yes
44	21049	5533	30	Yes
45	21524	5534	32	Yes
46	21999	5535	34	Yes
47	22474	5536	32	Yes
48	22949	5537	34	Yes
49	23424	5538	33	Yes
50	23899	5539	33	Yes
51	24374	5540	34	Yes
52	24849	5541	28	Yes
53	25324	5542	37	Yes
54	25799	5543	29	Yes
55	26274	5544	44	Yes
56	26749	5545	34	Yes
57	27224	5546	37	Yes
58	27699	5547	31	Yes
59	28174	5548	33	Yes
60	28649	5549	34	Yes
61	29124	5550	37	Yes
62	29599	5551	37	Yes
63	30074	5552	26	Yes
64	30549	5553	28	Yes
65	31024	5554	35	Yes
66	31499	5555	31	Yes
67	31974	5556	37	Yes
68	32449	5557	27	Yes
69	32924	5558	36	Yes
70	33399	5559	34	Yes
71	33874	5560	26	Yes
72	34349	5561	29	Yes
73	34824	5562	35	Yes
74	35299	5563	37	Yes
75	35774	5564	30	Yes
76	36249	5565	30	Yes
77	36724	5566	36	Yes
78	37199	5567	41	Yes
79	37674	5568	32	Yes

**TYPE 6 DETECTION PROBABILITY (CONTINUED)**

80	38149	5569	31	Yes
81	38624	5570	27	Yes
82	39099	5571	41	Yes
83	39574	5572	29	Yes
84	40049	5573	31	Yes
85	40524	5574	26	Yes
86	40999	5575	32	Yes
87	41474	5576	41	Yes
88	41949	5577	35	Yes
89	42424	5578	32	Yes
90	42899	5579	38	Yes
91	43374	5580	34	Yes
92	43849	5581	36	Yes
93	44324	5582	38	Yes
94	44799	5583	40	Yes
95	45274	5584	33	Yes
96	45749	5585	29	Yes
97	46224	5586	31	Yes
98	46699	5587	38	Yes
99	47174	5588	41	Yes
100	47649	5589	34	Yes
101	48124	5590	34	Yes
102	48599	5591	26	Yes
103	49074	5592	38	Yes
104	49549	5593	40	Yes
105	50024	5594	37	Yes
106	50499	5595	39	Yes
107	50974	5596	39	Yes
108	51449	5597	36	Yes
109	51924	5598	29	Yes
110	52399	5599	30	Yes
111	52874	5600	39	Yes
112	53349	5601	30	Yes
113	53824	5602	28	Yes
114	54299	5603	28	Yes
115	54774	5604	36	Yes
116	55249	5605	32	Yes
117	55724	5606	29	Yes
118	56199	5607	36	Yes
119	56674	5608	31	Yes



**TYPE 6 DETECTION PROBABILITY (CONTINUED)**

120	57149	5609	30	Yes
121	57624	5610	28	Yes
122	58099	5611	35	Yes
123	58574	5612	41	Yes
124	59049	5613	31	Yes
125	59524	5614	27	Yes
126	59999	5615	34	Yes
127	60474	5616	30	Yes
128	60949	5617	35	Yes
129	61424	5618	33	Yes
130	61899	5619	26	Yes
131	62374	5620	37	Yes
132	62849	5621	34	Yes
133	63324	5622	33	Yes
134	63799	5623	29	Yes
135	64274	5624	27	Yes
136	64749	5625	34	Yes
137	65224	5626	34	Yes
138	163	5627	37	Yes
139	638	5628	39	Yes
140	1113	5629	36	Yes
141	1588	5630	36	Yes
142	2063	5631	29	Yes
143	2538	5632	33	Yes
144	3013	5633	35	Yes
145	3488	5634	37	Yes
146	3963	5635	28	Yes
147	4438	5636	25	Yes
148	4913	5637	34	Yes
149	5388	5638	33	Yes
150	5863	5639	43	Yes
151	6338	5640	29	Yes
152	6813	5641	33	Yes
153	7288	5642	30	Yes
154	7763	5643	39	Yes
155	8238	5644	40	Yes
156	8713	5645	35	Yes
157	9188	5646	34	Yes
158	9663	5647	39	Yes
159	10138	5648	41	Yes
160	10613	5649	35	Yes
161	11088	5650	29	Yes

## 7.4. BRIDGE MODE RESULTS

Per KDB 905462 D02, Section 5.1 (footnote 2):

Networks Access Points with Bridge and/or MESH modes of operation are permitted to operate in the DFS bands but must employ a DFS function. The functionality of the Bridge mode as specified in §15.403(a) must be validated in the DFS test report. Devices operating as relays where they act as master and client must also employ DFS function for the master. The method used to validate the functionality must be documented and validation data must be documented. Bridge mode can be validated by performing a test statistical performance check (Section 7.8.4) on any one of the radar types. This is an abbreviated test to verify DFS functionality. MESH mode operational methodology must be submitted in the application for certification for evaluation by the FCC.

This device does not support Bridge Mode therefore this test was not performed.

## 7.5. SLAVE RESULTS FOR 160 MHz BANDWIDTH

### 7.5.1. TEST CHANNEL

All tests were performed at a channel center frequency of 5570 MHz.

### 7.5.2. RADAR WAVEFORM AND TRAFFIC

#### RADAR WAVEFORM

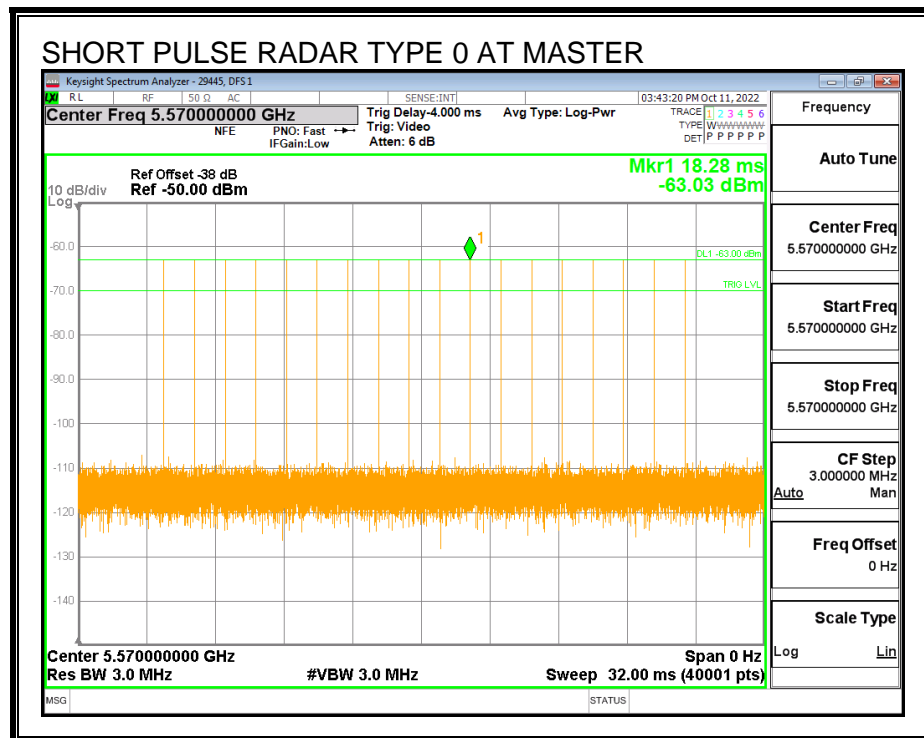

**MESH SLAVE TRAFFIC**

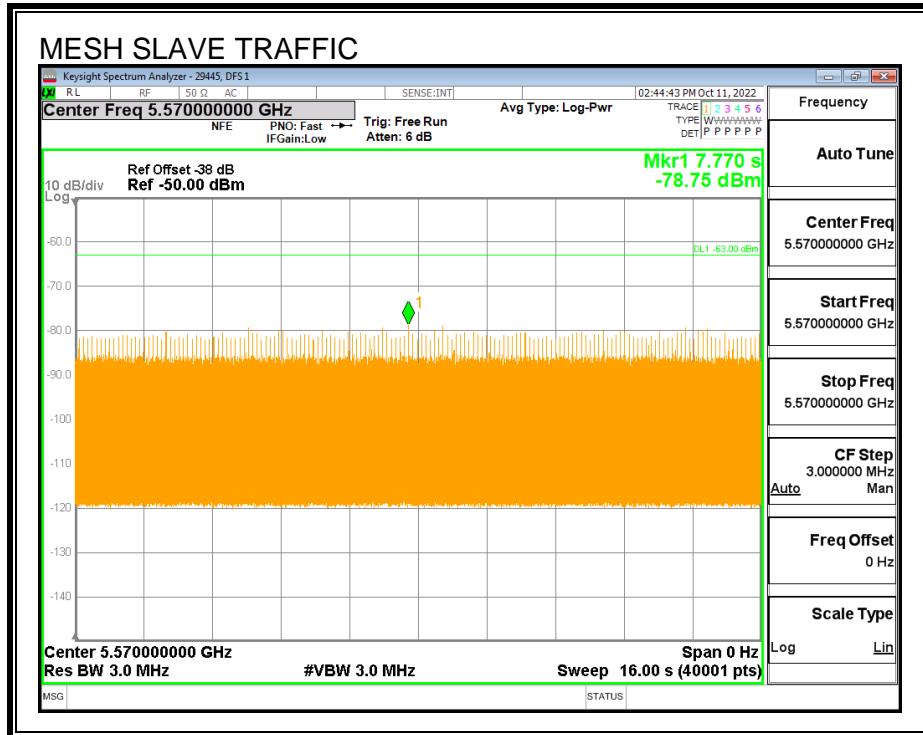

**MESH SLAVE DEVICE CHANNEL LOADING**

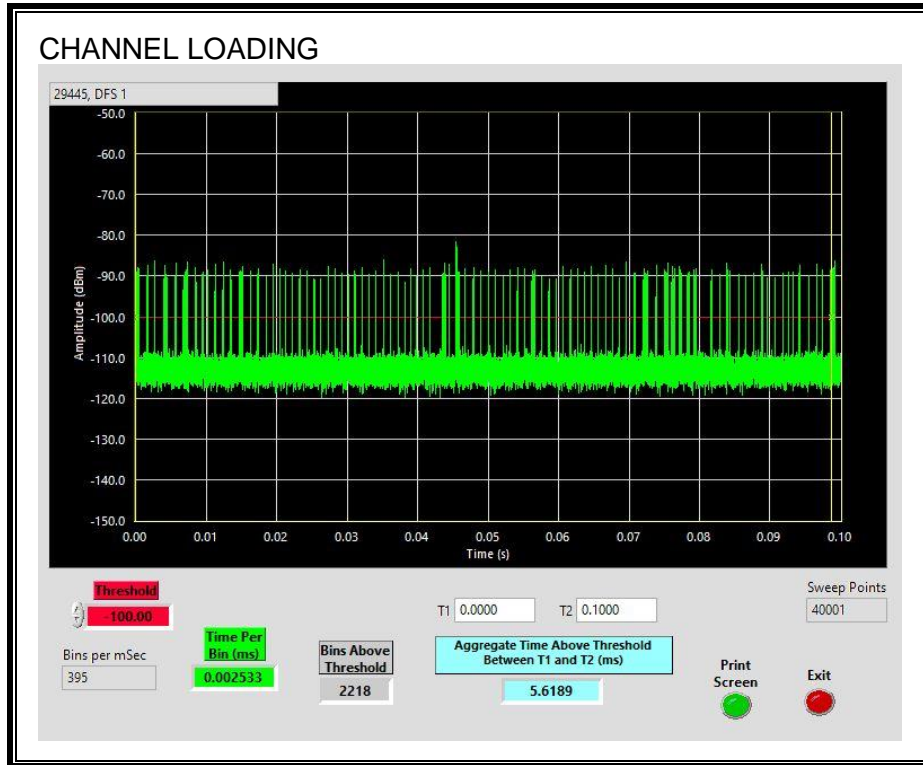

The level of traffic loading on the channel by the EUT is 5.618%

Per KDB 905462 D02 page 2, channel Loading is defined as the data transfer from the Master device to a client device. Therefore, the channel loading upon the Master Device meets the requirement as shown in the following plots taken from the Master Device test results.

**MASTER DEVICE TRAFFIC**

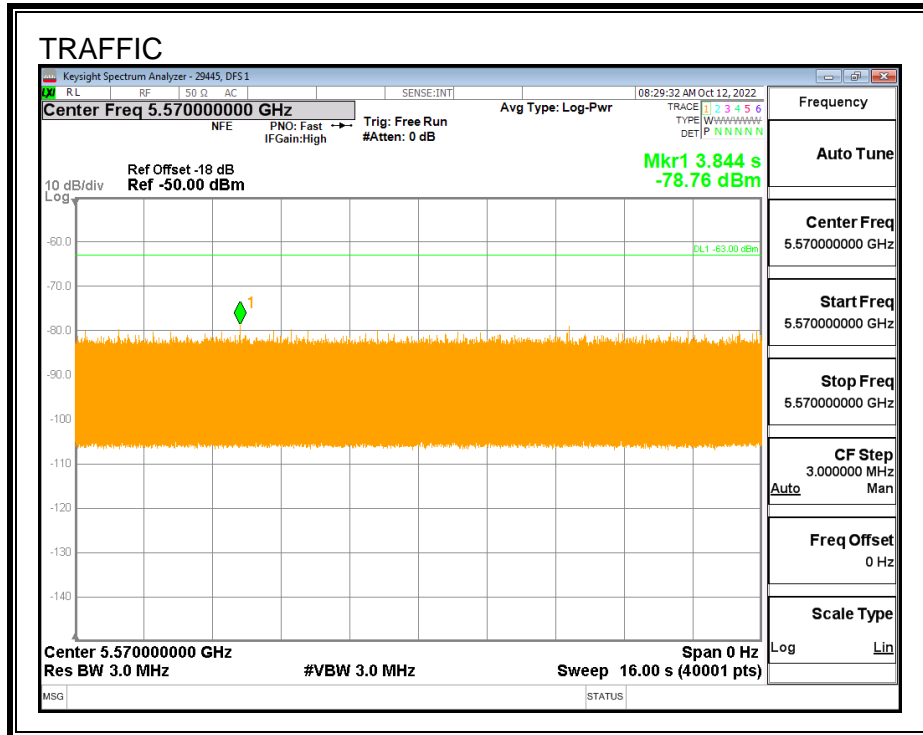

**MASTER DEVICE CHANNEL LOADING**

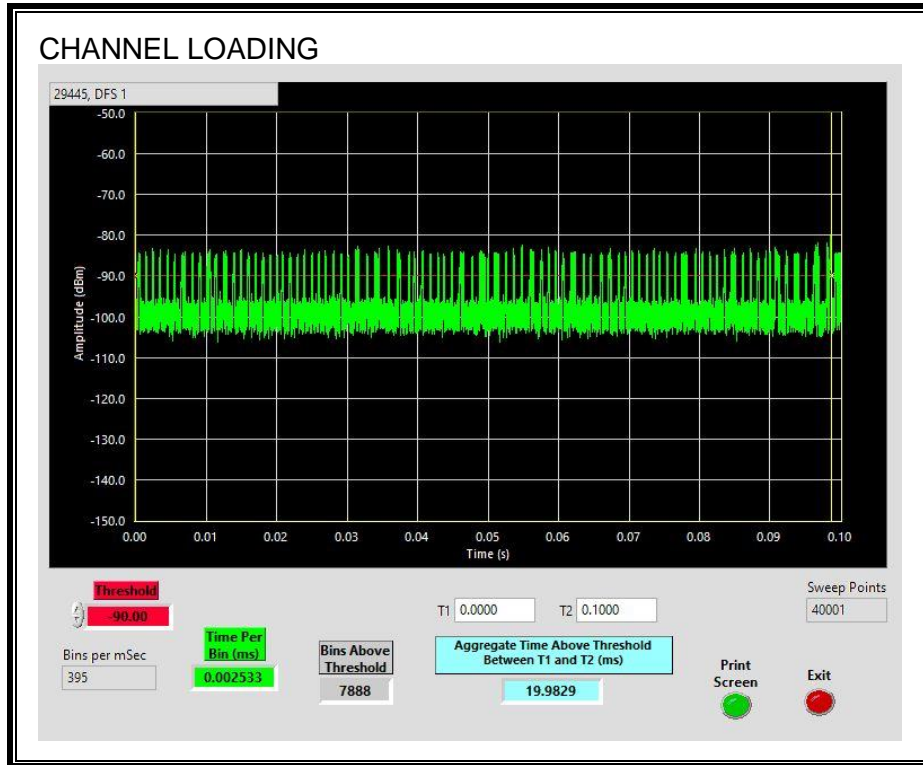

The level of traffic loading on the channel by the EUT is 19.98%

### 7.5.3. OVERLAPPING CHANNEL TESTS

#### RESULTS

These tests are not applicable.

### 7.5.4. MOVE AND CLOSING TIME

#### REPORTING NOTES

The reference marker is set at the end of last radar pulse.

The delta marker is set at the end of the last WLAN transmission following the radar pulse. This delta is the channel move time.

The aggregate channel closing transmission time is calculated as follows:

Aggregate Transmission Time =  
(Number of analyzer bins showing transmission) \* (dwell time per bin)

The observation period over which the aggregate time is calculated begins at (Reference Marker + 200 msec) and ends no earlier than (Reference Marker + 10 sec).

#### RESULTS

Channel Move Time (sec)	Limit (sec)
0.0	10

Aggregate Channel Closing Transmission Time (msec)	Limit (msec)
0.0	60



**MOVE TIME**

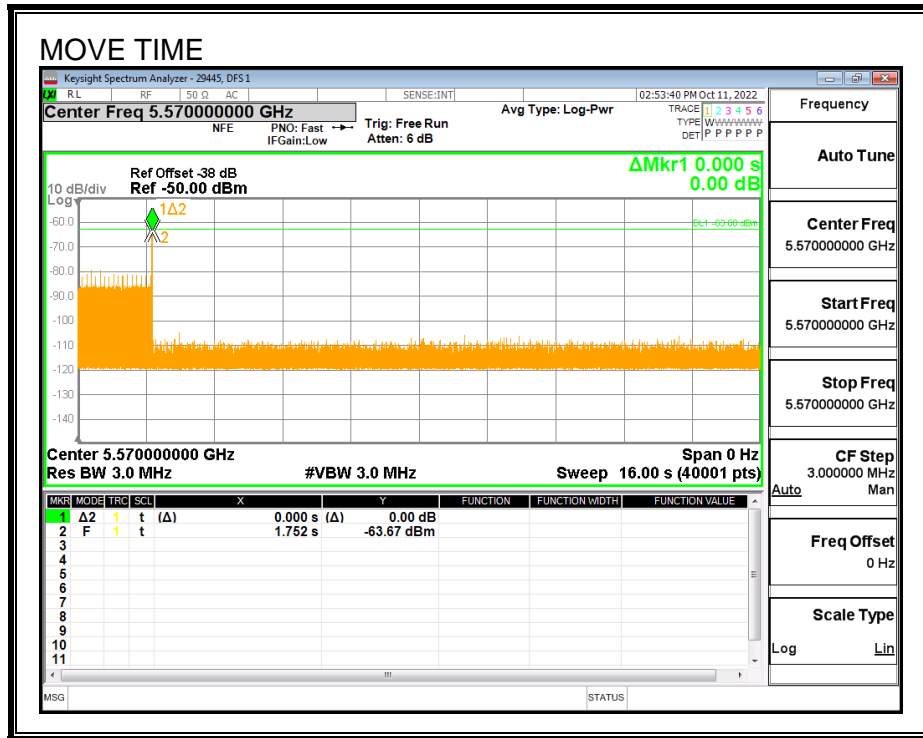

**CHANNEL CLOSING TIME**

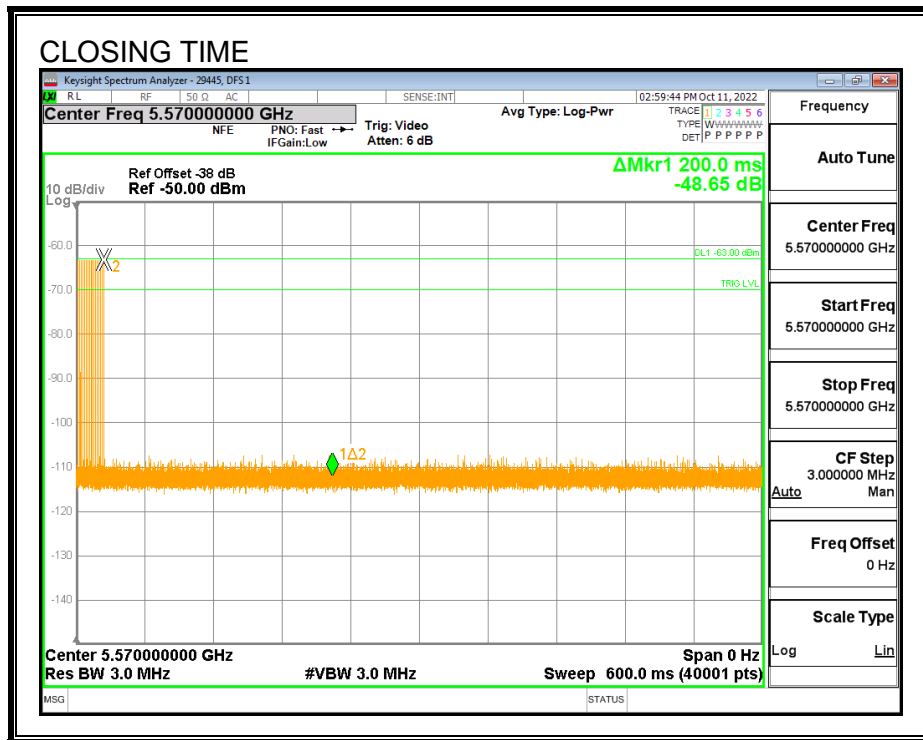

**AGGREGATE CHANNEL CLOSING TRANSMISSION TIME**

No transmissions are observed during the aggregate monitoring period.

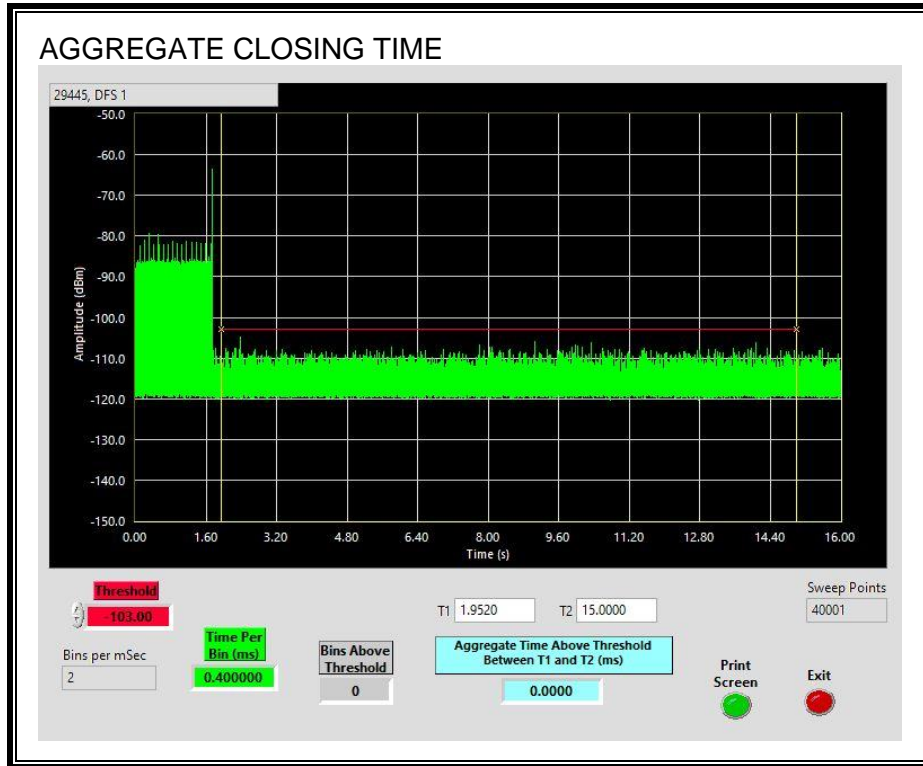

### 7.5.5. 30-MINUTE NON-OCCUPANCY PERIOD

#### RESULTS

No EUT transmissions were observed on the test channel during the 30-minute observation time.

