

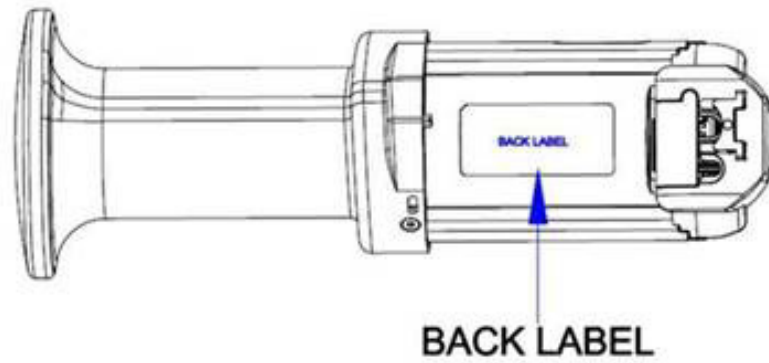



Label and location





 **Cambium Networks™**
Ashburton, TQ13 7UP, UK

ePMP 6 GHz Force 4625 SM
V_{in}: 56V $\overline{\text{---}}$; I_{max}: 0.268A
FCC ID: Z8H89FT0075
IC ID: 109W-0075

MODEL NO/HVIN: C068940P142A

PART NO: C068940M142A

MSN: E6YMXXXXXXXX

ESN: XXXXXXXXXXXXX

Wireless MAC: XXXXXXXXXXXXX

MADE IN CHINA

IMPORTANT
See the System User Guide before connecting to AC power.
The guide is available online at www.cambiumnetworks.com/guides

FC