



**DFS PORTION of FCC 47 CFR PART 15 SUBPART E
DFS PORTION of ISED CANADA RSS-247 ISSUE 2**

CERTIFICATION TEST REPORT

FOR

Wi-Fi 6 OUTDOOR ACCESS POINT

MODEL NUMBER: XV2-2T

FCC ID: Z8H89FT0066

ISED ID: 109W-0066

REPORT NUMBER: 13962689-E1V1

ISSUE DATE: SEPTEMBER 1, 2021

Prepared for
**CAMBIUM NETWORKS, INC.
3800 GOLF RD., SUITE 360
ROLLING MEADOWS
IL., 60008, U.S.A.**

Prepared by
**UL VERIFICATION SERVICES INC.
47173 BENICIA STREET
FREMONT, CA 94538, U.S.A.
TEL: (510) 319-4000
FAX: (510) 661-0888**



Revision History

<u>Rev.</u>	<u>Issue Date</u>	<u>Revisions</u>	<u>Revised By</u>
V1	09/01/21	Initial Issue	--

TABLE OF CONTENTS

1. ATTESTATION OF TEST RESULTS	5
2. TEST METHODOLOGY	7
3. SUMMARY OF TEST RESULTS.....	7
4. REFERENCE DOCUMENTS.....	7
5. FACILITIES AND ACCREDITATION	7
6. DECISION RULES AND MEASUREMENT UNCERTAINTY	8
6.1. METROLOGICAL TRACEABILITY	8
6.2. DECISION RULES.....	8
7. DYNAMIC FREQUENCY SELECTION.....	9
7.1. OVERVIEW	9
7.1.1. LIMITS.....	9
7.1.2. TEST AND MEASUREMENT SYSTEM	13
7.1.3. TEST AND MEASUREMENT SOFTWARE	15
7.1.4. TEST ROOM ENVIRONMENT	16
7.1.5. SETUP OF EUT.....	17
7.1.6. DESCRIPTION OF EUT	18
7.2. RESULTS FOR 20 MHz BANDWIDTH	20
7.2.1. TEST CHANNEL	20
7.2.2. RADAR WAVEFORMS AND TRAFFIC.....	20
7.2.1. CHANNEL AVAILABILITY CHECK TIME.....	29
7.2.2. OVERLAPPING CHANNEL TESTS.....	29
7.2.1. MOVE AND CLOSING TIME	29
7.3. DETECTION BANDWIDTH.....	30
7.3.1. IN-SERVICE MONITORING	32
7.4. RESULTS FOR 40 MHz BANDWIDTH	39
7.4.1. TEST CHANNEL	39
7.4.2. RADAR WAVEFORMS AND TRAFFIC.....	39
7.4.1. CHANNEL AVAILABILITY CHECK TIME.....	48
7.4.2. OVERLAPPING CHANNEL TESTS.....	48
7.4.3. MOVE AND CLOSING TIME	48
7.4.4. DETECTION BANDWIDTH.....	49
7.4.5. IN-SERVICE MONITORING	51
7.5. RESULTS FOR 80 MHz BANDWIDTH	58
7.5.1. TEST CHANNEL	58
7.5.2. RADAR WAVEFORMS AND TRAFFIC.....	58
7.5.3. CHANNEL AVAILABILITY CHECK TIME.....	67
7.5.4. OVERLAPPING CHANNEL TESTS.....	72
7.5.5. MOVE AND CLOSING TIME	72
7.5.6. NON-OCCUPANCY PERIOD	77
7.5.7. DETECTION BANDWIDTH.....	78
7.5.8. IN-SERVICE MONITORING	80

7.6. BRIDGE MODE RESULTS88

8. SETUP PHOTOS.....89

1. ATTESTATION OF TEST RESULTS

COMPANY NAME: CAMBIUM NETWORKS, INC.
3800 GOLF RD., SUITE 360
ROLLING MEADOWS, IL., 60008, U.S.A.

EUT DESCRIPTION: Wi-Fi 6 OUTDOOR ACCESS POINT

MODEL: XV2-2T

SERIAL NUMBER: WLXC0036MQZ1

DATE TESTED: AUGUST 16 to 18, 2021

APPLICABLE STANDARDS	
STANDARD	TEST RESULTS
DFS Portion of CFR 47 Part 15 Subpart E	Complies
DFS Portion of ISED CANADA RSS-247 Issue 2	Complies

UL Verification Services Inc. tested the above equipment in accordance with the requirements set forth in the above standards. The test results show that the equipment tested is capable of demonstrating compliance with the requirements as documented in this report.

The results documented in this report apply only to the tested sample, under the conditions and modes of operation as described herein. It is the manufacturer's responsibility to assure that additional production units of this model are manufactured with identical electrical and mechanical components. All samples tested were in good operating condition throughout the entire test program. Measurement Uncertainties are published for informational purposes only and were not taken into account unless noted otherwise.

This document may not be altered or revised in any way unless done so by UL Verification Services Inc. and all revisions are duly noted in the revisions section. Any alteration of this document not carried out by UL Verification Services Inc. will constitute fraud and shall nullify the document. This report must not be used by the client to claim product certification, approval, or endorsement by A2LA, NIST, any agency of the Federal Government, or any agency of the U.S. government.

Approved & Released For
UL Verification Services Inc. By:



Edgard Rincand
Operations Leader
CONSUMER TECHNOLOGY DIVISION
UL Verification Services Inc.

Prepared By:



DOUG ANDERSON
Test Engineer
CONSUMER TECHNOLOGY DIVISION
UL Verification Services Inc.

2. TEST METHODOLOGY

The tests documented in this report were performed in accordance with the DFS portion of FCC CFR 47 Part 2, FCC CFR 47 Part 15, FCC KDB 789033, KDB 905462 D02 and D03 and RSS-247 Issue 2.

3. SUMMARY OF TEST RESULTS

Requirement Description	Result	Remarks
DFS Portion of FCC 47 CFR PART 15 SUBPART E	Complies	
DFS Portion of ISED CANADA RSS-247 ISSUE 2	Complies	

4. REFERENCE DOCUMENTS

Measurements of transmitter parameters as referenced in this report and all other manufacturer's declarations relevant to the RF test requirements are documented in Sporton Labs FCC report: FR142329AN and IC report: CR142329AN

This report contains data provided by the customer which can impact the validity of results. UL Verification Services Inc. is only responsible for the validity of results after the integration of the data provided by the customer.

5. FACILITIES AND ACCREDITATION

UL Verification Services Inc. is accredited by A2LA, Certificate Number 0751.05, for all testing performed within the scope of this report. Testing was performed at the locations noted below.

	Address	ISED CABID	ISED Company Number	FCC Registration
<input checked="" type="checkbox"/>	Building 1: 47173 Benicia Street, Fremont, California, USA	US0104	2324A	208313
	Building 2: 47266 Benicia Street, Fremont, California, USA	US0104	2324A	208313
	Building 4: 47658 Kato Rd, Fremont, California, USA	US0104	2324A	208313

6. DECISION RULES AND MEASUREMENT UNCERTAINTY

6.1. METROLOGICAL TRACEABILITY

All test and measuring equipment utilized to perform the tests documented in this report are calibrated on a regular basis, with a maximum time between calibrations of one year or the manufacturers' recommendation, whichever is less, and where applicable is traceable to recognized national standards.

6.2. DECISION RULES

The Decision Rule is based on Simple Acceptance in accordance with ISO Guide 98-4:2012 Clause 8.2. (Measurement uncertainty is not taken into account when stating conformity with a specified requirement).

7. DYNAMIC FREQUENCY SELECTION

7.1. OVERVIEW

7.1.1. LIMITS

INNOVATION, SCIENCE and ECONOMIC DEVELOPMENT CANADA (ISED)

ISED RSS-247 is closely harmonized with FCC Part 15 DFS rules. The deviations are as follows:

RSS-247 Issue 2

Note: For the band 5600–5650 MHz, no operation is permitted.

Until further notice, devices subject to this annex shall not be capable of transmitting in the band 5600–5650 MHz. This restriction is for the protection of Environment Canada weather radars operating in this band.

FCC

§15.407 (h), FCC KDB 905462 D02 “COMPLIANCE MEASUREMENT PROCEDURES FOR UNLICENSED-NATIONAL INFORMATION INFRASTRUCTURE DEVICES OPERATING IN THE 5250-5350 MHz AND 5470-5725 MHz BANDS INCORPORATING DYNAMIC FREQUENCY SELECTION” and KDB 905462 D03 “U-NII CLIENT DEVICES WITHOUT RADAR DETECTION CAPABILITY”.

Table 1: Applicability of DFS requirements prior to use of a channel

Requirement	Operational Mode		
	Master	Client (without radar detection)	Client (with radar detection)
Non-Occupancy Period	Yes	Not required	Yes
DFS Detection Threshold	Yes	Not required	Yes
Channel Availability Check Time	Yes	Not required	Not required
U-NII Detection Bandwidth	Yes	Not required	Yes

Table 2: Applicability of DFS requirements during normal operation

Requirement	Operational Mode		
	Master	Client (without DFS)	Client (with DFS)
DFS Detection Threshold	Yes	Not required	Yes
Channel Closing Transmission Time	Yes	Yes	Yes
Channel Move Time	Yes	Yes	Yes
U-NII Detection Bandwidth	Yes	Not required	Yes

Additional requirements for devices with multiple bandwidth modes	Master Device or Client with Radar DFS	Client (without DFS)
<i>U-NII Detection Bandwidth and Statistical Performance Check</i>	All BW modes must be tested	Not required
<i>Channel Move Time and Channel Closing Transmission Time</i>	Test using widest BW mode available	Test using the widest BW mode available for the link
<i>All other tests</i>	Any single BW mode	Not required
Note: Frequencies selected for statistical performance check (Section 7.8.4) should include several frequencies within the radar detection bandwidth and frequencies near the edge of the radar detection bandwidth. For 802.11 devices it is suggested to select frequencies in all 20 MHz channel blocks and a null frequency between the bonded 20 MHz channel blocks.		

Table 3: Interference Threshold values, Master or Client incorporating In-Service Monitoring

Maximum Transmit Power	Value (see notes)
E.I.R.P. \geq 200 mill watt	-64 dBm
E.I.R.P. $<$ 200 mill watt and power spectral density $<$ 10 dBm/MHz	-62 dBm
E.I.R.P. $<$ 200 mill watt that do not meet power spectral density requirement	-64 dBm
<p>Note 1: This is the level at the input of the receiver assuming a 0 dBi receive antenna</p> <p>Note 2: Throughout these test procedures an additional 1 dB has been added to the amplitude of the test transmission waveforms to account for variations in measurement equipment. This will ensure that the test signal is at or above the detection threshold level to trigger a DFS response.</p> <p>Note 3: E.I.R.P. is based on the highest antenna gain. For MIMO devices refer to KDB publication 662911 D01.</p>	

Table 4: DFS Response requirement values

Parameter	Value
<i>Non-occupancy period</i>	30 minutes
<i>Channel Availability Check Time</i>	60 seconds
<i>Channel Move Time</i>	10 seconds (See Note 1)
<i>Channel Closing Transmission Time</i>	200 milliseconds + approx. 60 milliseconds over remaining 10 second period. (See Notes 1 and 2)
<i>U-NII Detection Bandwidth</i>	Minimum 100% of the U-NII 99% transmission power bandwidth. (See Note 3)
<p>Note 1: <i>Channel Move Time</i> and the <i>Channel Closing Transmission Time</i> should be performed with Radar Type 0. The measurement timing begins at the end of the Radar Type 0 burst.</p> <p>Note 2: The <i>Channel Closing Transmission Time</i> is comprised of 200 milliseconds starting at the beginning of the <i>Channel Move Time</i> plus any additional intermittent control signals required to facilitate a <i>Channel</i> move (an aggregate of 60 milliseconds) during the remainder of the 10 second period. The aggregate duration of control signals will not count quiet periods in between transmissions.</p> <p>Note 3: During the <i>U-NII Detection Bandwidth</i> detection test, radar type 0 should be used. For each frequency step the minimum percentage of detection is 90 percent. Measurements are performed with no data traffic.</p>	

Table 5 – Short Pulse Radar Test Waveforms

Radar Type	Pulse Width (usec)	PRI (usec)	Pulses	Minimum Percentage of Successful Detection	Minimum Trials
0	1	1428	18	See Note 1	See Note 1
1	1	Test A: 15 unique PRI values randomly selected from the list of 23 PRI values in table 5a	Roundup: $\{(1/360) \times (19 \times 10^6 \text{ PRI}_{\text{usec}})\}$	60%	30
		Test B: 15 unique PRI values randomly selected within the range of 518-3066 usec. With a minimum increment of 1 usec, excluding PRI values selected in Test A			
2	1-5	150-230	23-29	60%	30
3	6-10	200-500	16-18	60%	30
4	11-20	200-500	12-16	60%	30
Aggregate (Radar Types 1-4)				80%	120
Note 1: Short Pulse Radar Type 0 should be used for the <i>Detection Bandwidth</i> test, <i>Channel Move Time</i> , and <i>Channel Closing Time</i> tests.					

Table 6 – Long Pulse Radar Test Signal

Radar Waveform Type	Pulse Width (µsec)	Chirp Width (MHz)	PRI (µsec)	Pulses per Burst	Number of Bursts	Minimum Percentage of Successful Detection	Minimum Trials
5	50-100	5-20	1000-2000	1-3	8-20	80%	30

Table 7 – Frequency Hopping Radar Test Signal

Radar Waveform Type	Pulse Width (µsec)	PRI (µsec)	Pulses per Hop	Hopping Rate (kHz)	Hopping Sequence Length (msec)	Minimum Percentage of Successful Detection	Minimum Trials
6	1	333	9	0.333	300	70%	30

7.1.2. TEST AND MEASUREMENT SYSTEM

CONDUCTED METHOD SYSTEM BLOCK DIAGRAM

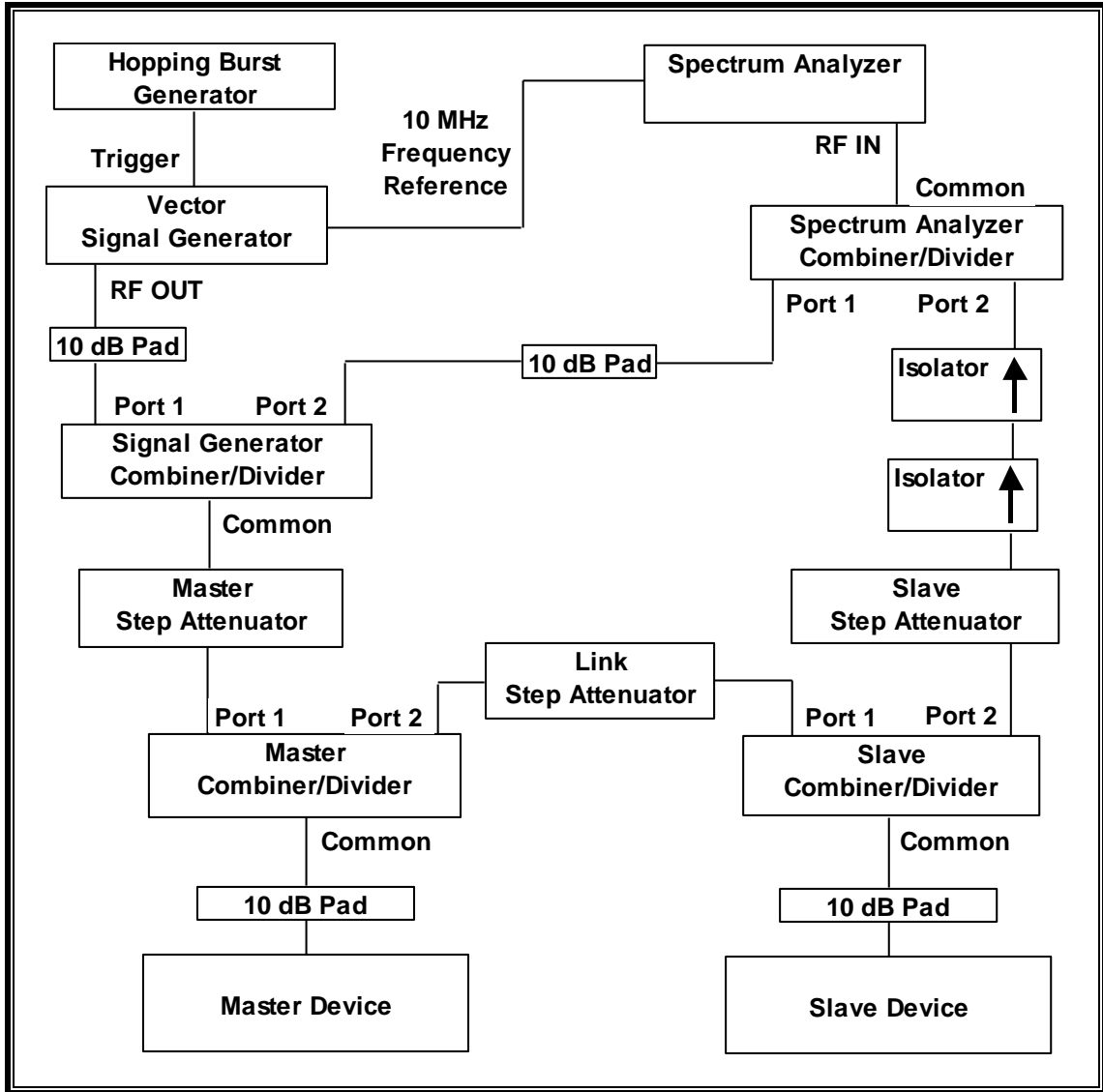

SYSTEM OVERVIEW

The short pulse and long pulse signal generating system utilizes the NTIA software. The Vector Signal Generator has been validated by the NTIA. The hopping signal generating system utilizes the CCS simulated hopping method and system, which has been validated by the DoD, FCC and NTIA. The software selects waveform parameters from within the bounds of the signal type on a random basis using uniform distribution.

The short pulse types 1, 2, 3 and 4, and the long pulse type 5 parameters are randomized at run-time.

The hopping type 6 pulse parameters are fixed while the hopping sequence is based on the August 2005 NTIA Hopping Frequency List. The initial starting point randomized at run-time and each subsequent starting point is incremented by 475. Each frequency in the 100-length segment is compared to the boundaries of the EUT Detection Bandwidth and the software creates a hopping burst pattern in accordance with Section 7.4.1.3 Method #2 Simulated Frequency Hopping Radar Waveform Generating Subsystem of KDB 905462 D02. The frequency of the signal generator is incremented in 1 MHz steps from F_L to F_H for each successive trial. This incremental sequence is repeated as required to generate a minimum of 30 total trials and to maintain a uniform frequency distribution over the entire Detection Bandwidth.

The signal monitoring equipment consists of a spectrum analyzer. The aggregate ON time is calculated by multiplying the number of bins above a threshold during a particular observation period by the dwell time per bin, with the analyzer set to peak detection and max hold.

Should multiple RF ports be utilized for the Master and/or Slave devices (for example, for diversity or MIMO implementations), additional combiner/dividers are inserted between the Master Combiner/Divider and the pad connected to the Master Device (and/or between the Slave Combiner/Divider and the pad connected to the Slave Device). Additional pads may be utilized such that there is one pad at each RF port on each EUT.

SYSTEM CALIBRATION

A 50-ohm load is connected in place of the spectrum analyzer, and the spectrum analyzer is connected in place of the master device. The signal generator is set to CW mode. The amplitude of the signal generator is adjusted to yield a level of -64 dBm as measured on the spectrum analyzer.

Without changing any of the instrument settings, the spectrum analyzer is reconnected to the Common port of the Spectrum Analyzer Combiner/Divider. The Reference Level Offset of the spectrum analyzer is adjusted so that the displayed amplitude of the signal is -64 dBm.

The spectrum analyzer displays the level of the signal generator as received at the antenna ports of the Master Device. The interference detection threshold may be varied from the calibrated value of -64 dBm and the spectrum analyzer will still indicate the level as received by the Master Device.

ADJUSTMENT OF DISPLAYED TRAFFIC LEVEL

A link is established between the Master and Slave and the Link Step Attenuator between the units is adjusted as needed to provide a suitable received level at the Master and Slave devices. Traffic that meets or exceed the minimum loading requirement is streamed from the Master device to the Slave Device. The WLAN traffic level, as displayed on the spectrum analyzer, is confirmed to be at lower amplitude than the radar detection threshold and is confirmed to be the Radar Detection Device rather than the associated device. If a different setting of the Master Step Attenuator is required to meet the above conditions, a new System Calibration is performed for the new Master Step Attenuator setting.

TEST AND MEASUREMENT EQUIPMENT

The following test and measurement equipment was utilized for the tests documented in this report:

TEST EQUIPMENT LIST				
Description	Manufacturer	Model	ID No.	Cal Due
Spectrum Analyzer, PXA, 3Hz to 44GHz	Keysight	N9030A	150667	02/24/22
Signal Generator, MXG X-Series RF Vector	Agilent	N5182B	150666	01/26/22
Arbitrary Waveform Generator	Agilent / HP	33220A	80815	01/28/22

7.1.3. TEST AND MEASUREMENT SOFTWARE

The following test and measurement software was utilized for the tests documented in this report:

TEST SOFTWARE LIST		
Name	Version	Test / Function
Aggregate Time-PXA	3.1	Channel Loading and Aggregate Closing Time
FCC 2014 Detection Bandwidth-PXA	3.1.1	Detection Bandwidth in 5 MHz Steps
In Service Monitoring-PXA	4.1	In-Service Monitoring (Probability of Detection)
PXA Read	3.1	Signal Generator Screen Capture
SGXProject.exe	1.7	Radar Waveform Generation and Download

7.1.4. TEST ROOM ENVIRONMENT

The test room temperature and humidity shall be maintained within normal temperature of 15~35 °C and normal humidity 20~75% (relative humidity).

ENVIRONMENT CONDITION

Parameter	Value
Temperature	24.7, 24.2 and 24.4 °C
Humidity	43, 42 and 40 %

7.1.5. SETUP OF EUT

CONDUCTED METHOD EUT TEST SETUP

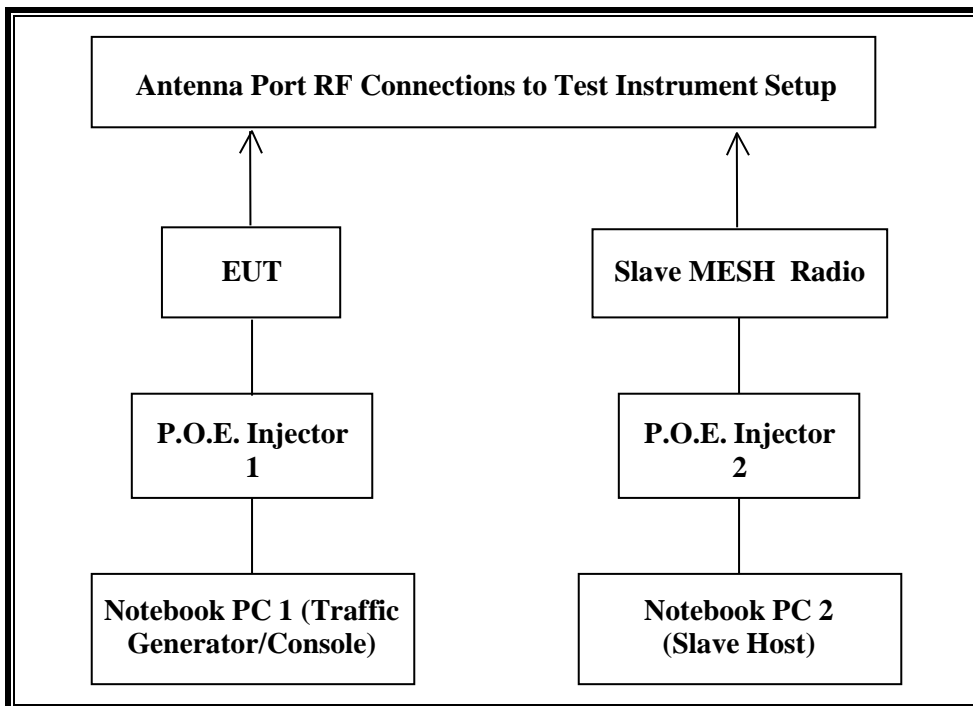

SUPPORT EQUIPMENT

The following support equipment was utilized for the tests documented in this report:

PERIPHERAL SUPPORT EQUIPMENT LIST				
Description	Manufacturer	Model	Serial Number	FCC ID
P.O.E. Injector 1 (EUT)	Cambium Networks	NET-P60-56IN	N000000L142A2028 000149	DoC
Notebook PC 1 (EUT Console)	Lenovo	Type 4236-B92	PB-HEX04 12/05	DoC
AC Adapter 1 (Notebook PC 1)	Lenovo	42T4418	11S42T4418Z1ZG WG08R90M	DoC
802.11ax 2x2 WiFi6 Outdoor Access Point (Slave MESH Radio)	Cambium Networks	XV2-2T	WLXC003DD3VT	Z8H89FT0066
P.O.E. Injector 2 (Slave)	Cambium Networks	NET-P30-56IN	N000000L034A1819 004355	DoC
Notebook PC 2 (Slave Host)	Lenovo	Type 20B7-S0A200	PF-02JN9J 14/06	DoC
AC Adapter 2 (Notebook PC 2)	Lenovo	ADLX65NLC2A	11S45N0259Z1ZS9 74594A9	DoC

7.1.6. DESCRIPTION OF EUT

For FCC the EUT operates over the 5250-5350 MHz and 5470-5725 MHz ranges.

For ISED the EUT operates over the 5250-5350 MHz and 5470-5725 MHz ranges, excluding the 5600-5650 MHz range.

The EUT is a Master Device with MESH capability and has been tested as such.

The highest power level within these bands is 30 dBm EIRP in the 5250-5350 MHz band and 30 dBm EIRP in the 5470-5725 MHz band.

The manufacturer has declared that the highest gain antenna assembly utilized with the EUT has a gain of 13 dBi in the 5250-5350 MHz band and 13 dBi in the 5470-5725 MHz band. The manufacturer has declared that the lowest gain antenna assembly utilized with the EUT has a gain of 9 dBi in the 5250-5350 MHz band and 9 dBi in the 5470-5725 MHz band.

One dual input Omni antenna assembly is utilized to meet the diversity and MIMO operational requirements.

The rated output power of the Master unit is > 23dBm (EIRP). Therefore the required interference threshold level is -64 dBm. After correction for antenna gain and procedural adjustments, the required conducted threshold at the antenna port is $-64 + 9 + 1 = -54$ dBm.

The calibrated conducted DFS Detection Threshold level is set to -54 dBm.

The EUT uses two transmitter/receiver chains, each connected to a 50-ohm coaxial antenna port. All antenna ports are connected to the test system via a power divider to perform conducted tests.

The Slave MESH client device associated with the EUT during these tests does not have radar detection capability.

WLAN traffic that meets or exceeds the minimum required loading was generated by transferring a data stream from the Master Device to the Slave Device using iPerf version 2.0.5 software package.

TPC is required since the maximum EIRP is greater than 500 mW (27 dBm).

The EUT utilizes the 802.11ax architecture. Three nominal channel bandwidths are implemented: 20 MHz, 40 MHz and 80 MHz.

Channel puncturing is not supported by the EUT.

The software installed in the EUT is revision 6.4-a0.

UNIFORM CHANNEL SPREADING

This function is not required per KDB 905462.

OVERVIEW OF MASTER DEVICE WITH RESPECT TO §15.407 (h) REQUIREMENTS

The Master Device is a Cambium Networks 802.11ax 2x2 WiFi6 Outdoor Access Point, FCC ID: Z8H89FT0066. The minimum antenna gain for the Master Device is 9 dBi.

The rated output power of the Master unit is > 23dBm (EIRP). Therefore the required interference threshold level is -64 dBm. After correction for antenna gain and procedural adjustments, the required conducted threshold at the antenna port is $-64 + 9 + 1 = -54$ dBm.

The calibrated radiated DFS Detection Threshold level is set to -54 dBm.

The software installed in the Master EUT is 6.4-a0.

7.2. RESULTS FOR 20 MHz BANDWIDTH

7.2.1. TEST CHANNEL

All tests were performed at a channel center frequency of 5500 MHz.

7.2.2. RADAR WAVEFORMS AND TRAFFIC

RADAR WAVEFORMS

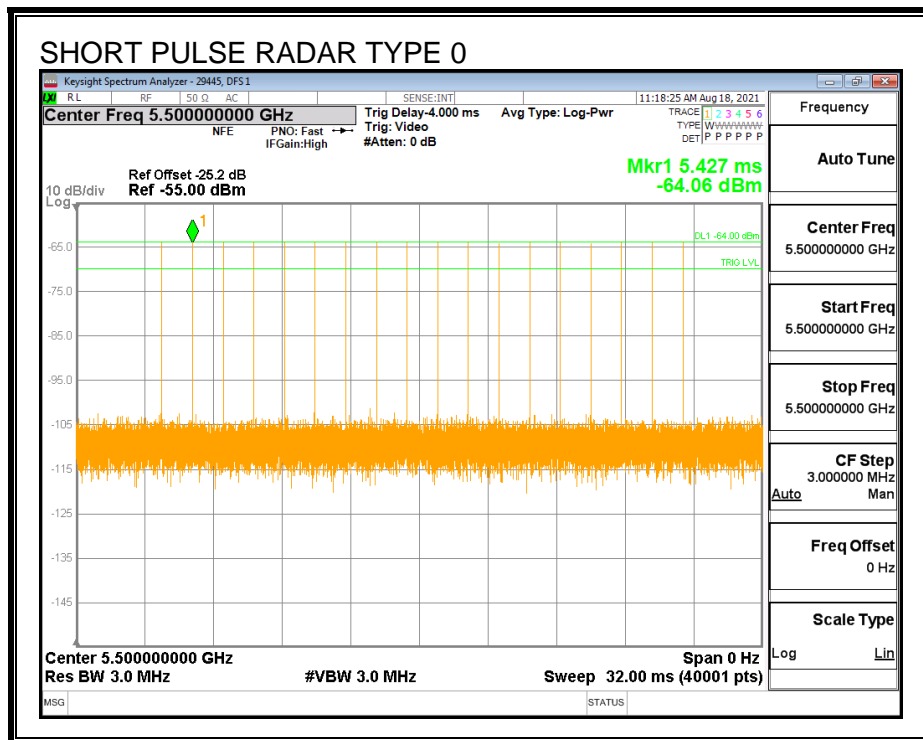

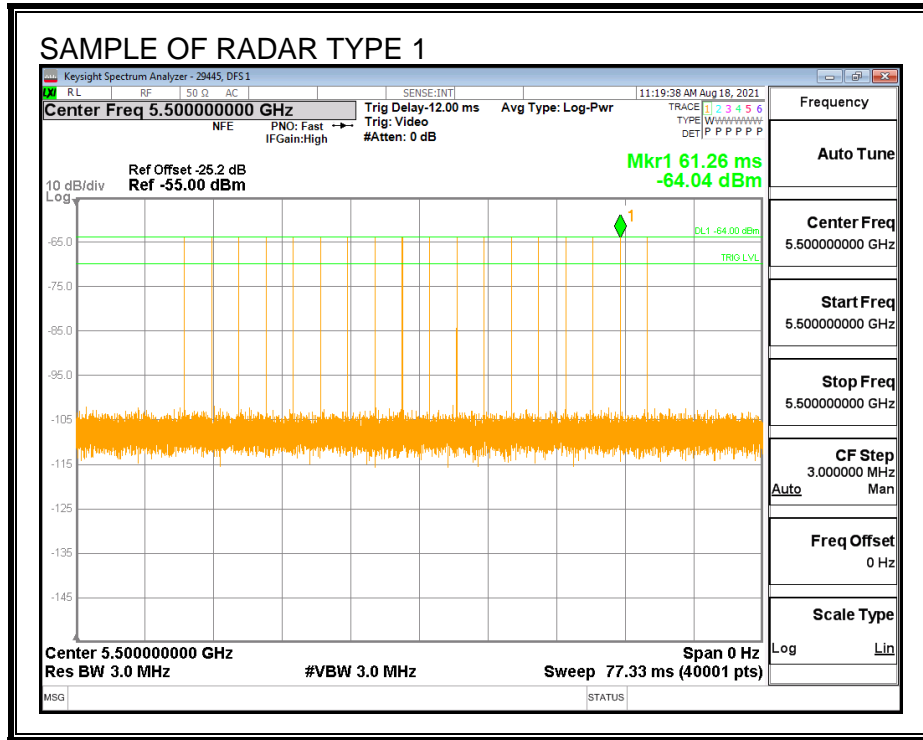

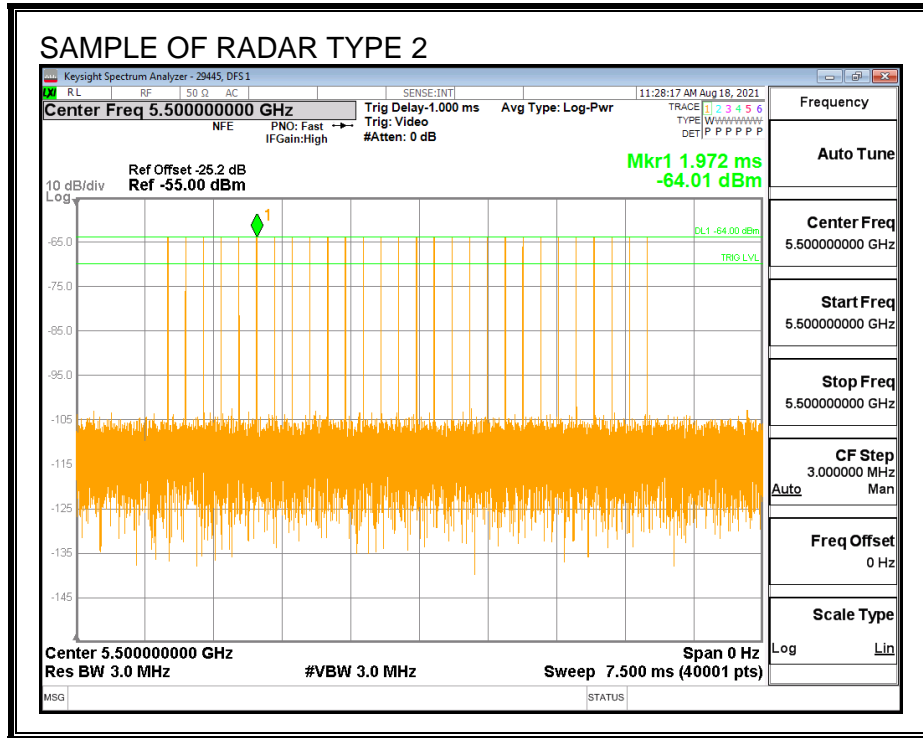

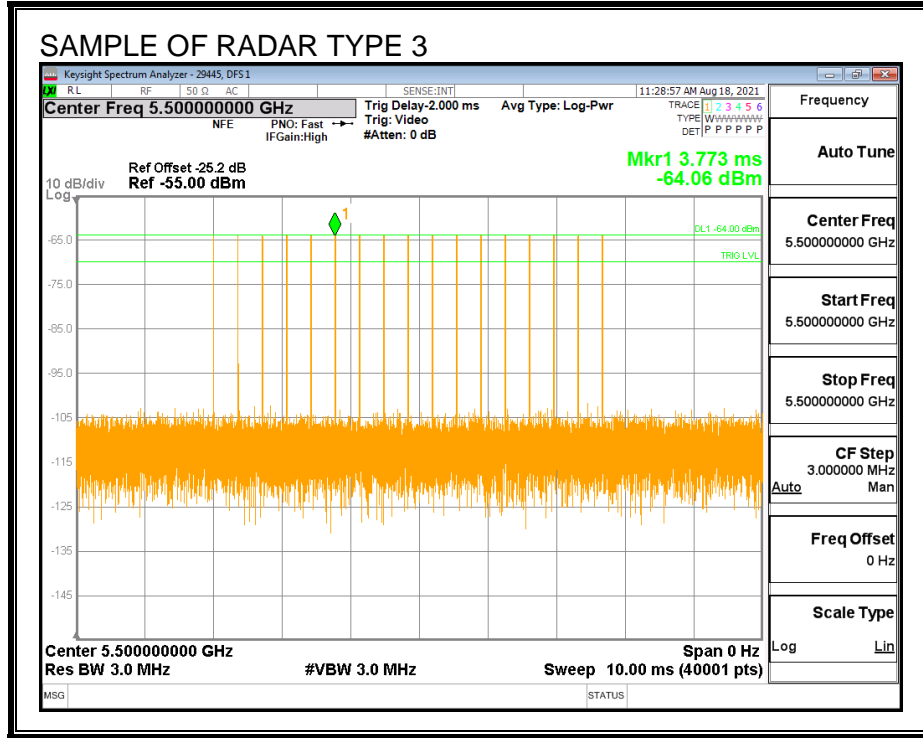

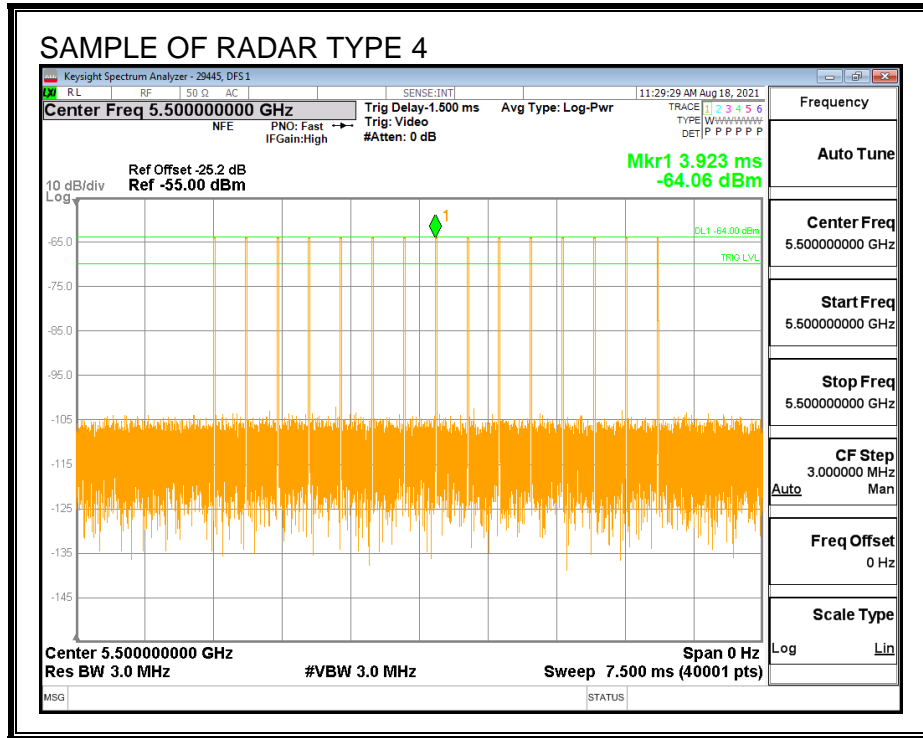

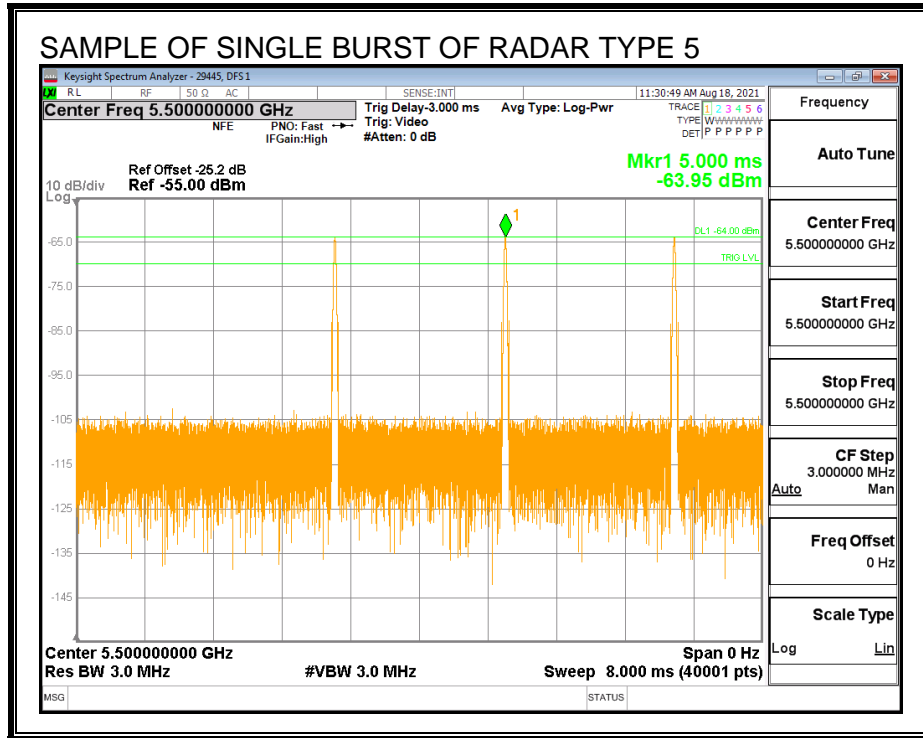

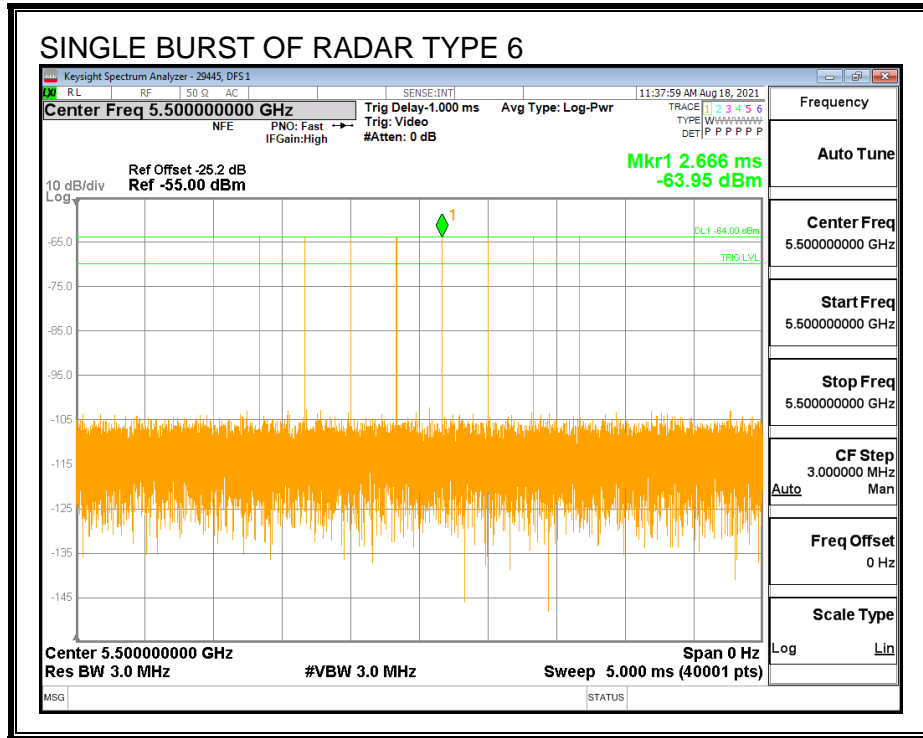

TRAFFIC

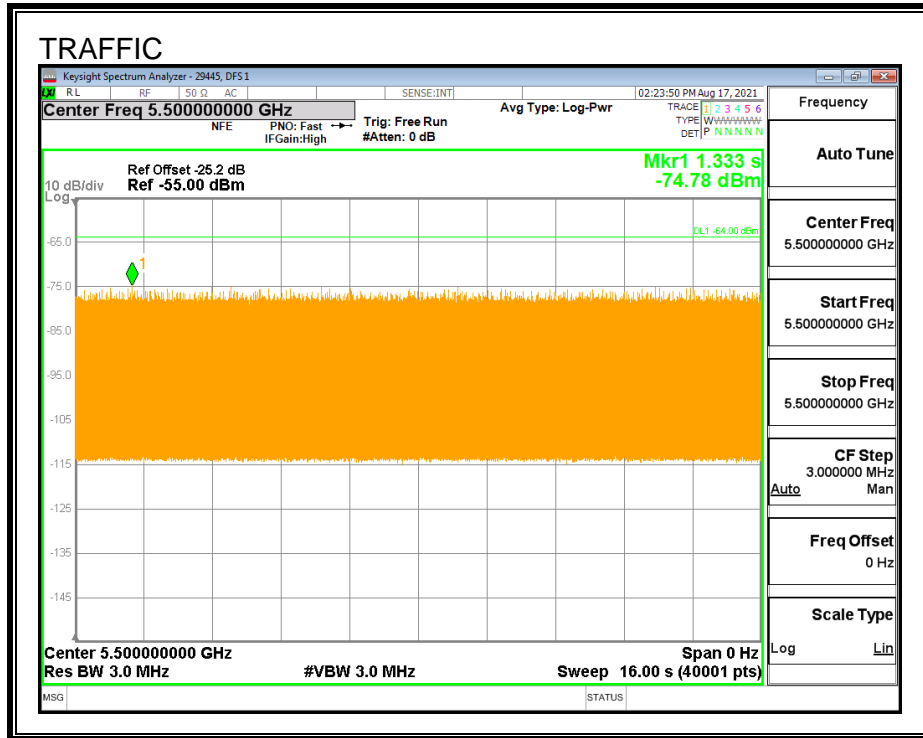

CHANNEL LOADING

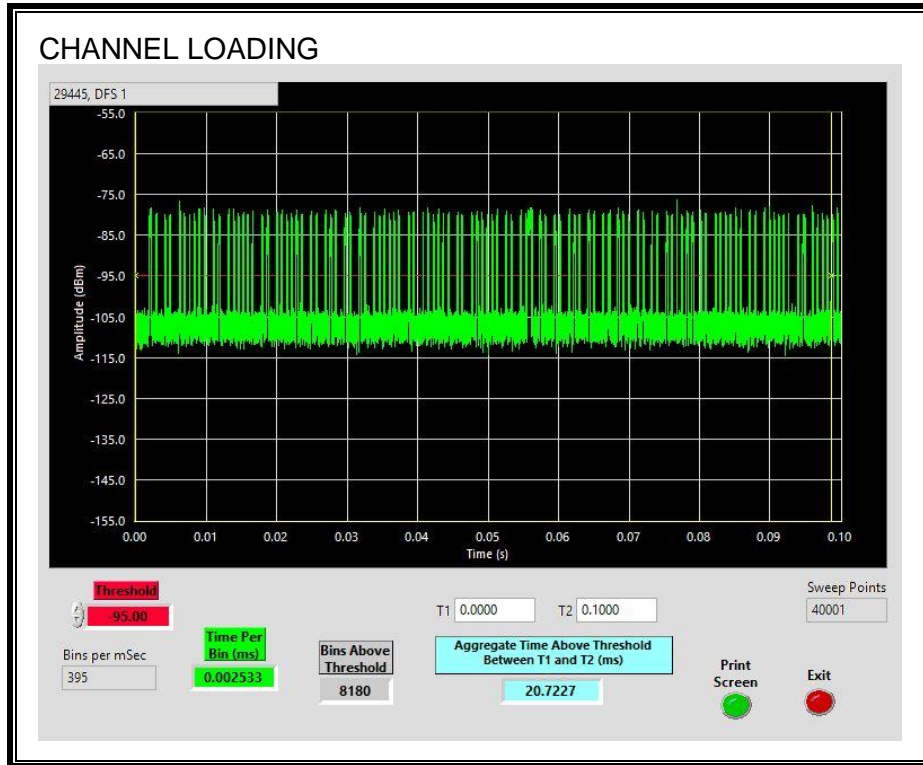

The level of traffic loading on the channel by the EUT is 20.72%

7.2.1. CHANNEL AVAILABILITY CHECK TIME

Per Table 2 on page 6 of KDB 905462 D02, Channel Move Time and Channel Closing Transmission Time are only required to be tested using the widest supported channel bandwidth mode and all other timing tests may be tested using any single channel bandwidth mode. Therefore this test has not been performed for this channel bandwidth.

7.2.2. OVERLAPPING CHANNEL TESTS

RESULTS

The channel spacing is not less than the channel bandwidth therefore the EUT does not have an overlapping channel plan.

7.2.1. MOVE AND CLOSING TIME

Per Table 2 on page 6 of KDB 905462 D02, Channel Move Time and Channel Closing Transmission Time are only required to be tested using the widest supported channel bandwidth mode and all other timing tests may be tested using any single channel bandwidth mode. Therefore this test has not been performed for this channel bandwidth.

7.3. DETECTION BANDWIDTH

REFERENCE PLOT OF 99% POWER BANDWIDTH

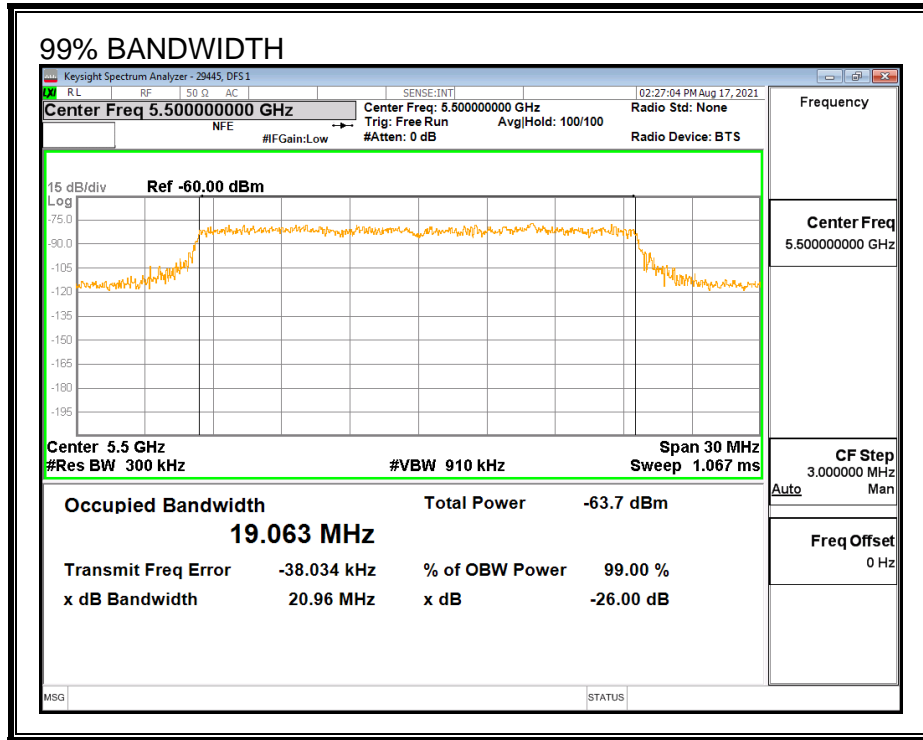

RESULTS

F_L (MHz)	F_H (MHz)	Detection Bandwidth (MHz)	99% Power Bandwidth (MHz)	Ratio of Detection BW to 99% Power BW (%)	Minimum Limit (%)
5490	5510	20	19.063	104.9	100

DETECTION BANDWIDTH PROBABILITY

DETECTION BANDWIDTH PROBABILITY RESULTS				
Detection Bandwidth Test Results		29445	DFS 1	
FCC Type 0 Waveform: 1 us Pulse Width, 1428 us PRI, 18 Pulses per Burst				
Frequency (MHz)	Number of Trials	Number Detected	Detection (%)	Mark
5490	10	10	100	FL
5495	10	10	100	
5500	10	10	100	
5505	10	10	100	
5510	10	10	100	FH

7.3.1. IN-SERVICE MONITORING

RESULTS

FCC Radar Test Summary										
Signal Type	Number of Trials	Detection (%)	Limit (%)	Pass/Fail	Detection Bandwidth		OBW	Test Location	Employee Number	In-Service Monitoring Version
					FL	FH				
FCC Short Pulse Type 1	30	100.00	60	Pass	5490	5510	19.06	DFS 1	29445	v4.1
FCC Short Pulse Type 2	30	100.00	60	Pass	5490	5510	19.06	DFS 1	29445	v4.1
FCC Short Pulse Type 3	30	90.00	60	Pass	5490	5510	19.06	DFS 1	29445	v4.1
FCC Short Pulse Type 4	30	100.00	60	Pass	5490	5510	19.06	DFS 1	29445	v4.1
Aggregate		97.50	80	Pass						
FCC Long Pulse Type 5	30	100.00	80	Pass	5490	5510	19.06	DFS 1	29445	v4.1
FCC Hopping Type 6	42	100.00	70	Pass	5490	5510		DFS 1	29445	v4.1

TYPE 1 DETECTION PROBABILITY

Data Sheet for FCC Short Pulse Radar Type 1						
Waveform	Pulse Width (us)	PRI (us)	Pulses Per Burst	Test (A/B)	Frequency (MHz)	Successful Detection (Yes/No)
1001	1	3066	18	A	5494	Yes
1002	1	798	67	A	5495	Yes
1003	1	778	68	A	5493	Yes
1004	1	618	86	A	5500	Yes
1005	1	698	76	A	5507	Yes
1006	1	518	102	A	5493	Yes
1007	1	838	63	A	5509	Yes
1008	1	678	78	A	5509	Yes
1009	1	818	65	A	5510	Yes
1010	1	918	58	A	5509	Yes
1011	1	738	72	A	5504	Yes
1012	1	718	74	A	5503	Yes
1013	1	858	62	A	5494	Yes
1014	1	598	89	A	5495	Yes
1015	1	638	83	A	5493	Yes
1016	1	2641	20	B	5494	Yes
1017	1	1791	30	B	5504	Yes
1018	1	746	71	B	5508	Yes
1019	1	1379	39	B	5498	Yes
1020	1	3012	18	B	5497	Yes
1021	1	1226	44	B	5500	Yes
1022	1	2989	18	B	5501	Yes
1023	1	2685	20	B	5500	Yes
1024	1	835	64	B	5495	Yes
1025	1	1856	29	B	5502	Yes
1026	1	1488	36	B	5507	Yes
1027	1	1444	37	B	5497	Yes
1028	1	2400	22	B	5497	Yes
1029	1	1291	41	B	5506	Yes
1030	1	1182	45	B	5493	Yes

TYPE 2 DETECTION PROBABILITY

Data Sheet for FCC Short Pulse Radar Type 2					
Waveform	Pulse Width (us)	PRI (us)	Pulses Per Burst	Frequency (MHz)	Successful Detection (Yes/No)
2001	3.2	194	28	5507	Yes
2002	4.3	154	27	5493	Yes
2003	5	167	27	5500	Yes
2004	4.4	212	23	5509	Yes
2005	1.3	230	23	5509	Yes
2006	5	198	23	5497	Yes
2007	4.2	181	23	5506	Yes
2008	4	154	24	5491	Yes
2009	3.5	222	28	5503	Yes
2010	1.6	203	23	5502	Yes
2011	3.4	195	24	5495	Yes
2012	1.7	219	26	5499	Yes
2013	3.8	176	27	5508	Yes
2014	2.3	166	26	5508	Yes
2015	4.6	209	28	5494	Yes
2016	3.5	203	27	5492	Yes
2017	1.9	169	26	5491	Yes
2018	3	210	25	5498	Yes
2019	3.7	223	24	5503	Yes
2020	3.1	187	28	5493	Yes
2021	4.1	204	27	5507	Yes
2022	3.7	172	28	5496	Yes
2023	2.9	156	28	5499	Yes
2024	4.9	171	29	5491	Yes
2025	4.4	196	26	5493	Yes
2026	4.4	178	28	5503	Yes
2027	2.1	170	29	5492	Yes
2028	4.5	193	23	5505	Yes
2029	2.5	151	25	5504	Yes
2030	1	221	24	5509	Yes

TYPE 3 DETECTION PROBABILITY

Data Sheet for FCC Short Pulse Radar Type 3					
Waveform	Pulse Width (us)	PRI (us)	Pulses Per Burst	Frequency (MHz)	Successful Detection (Yes/No)
3001	6.3	354	17	5503	Yes
3002	7.2	335	16	5502	Yes
3003	9.7	481	16	5497	Yes
3004	8.9	357	16	5497	Yes
3005	7.5	397	18	5505	Yes
3006	6.8	286	17	5504	Yes
3007	7.8	339	18	5508	Yes
3008	9.6	492	17	5490	Yes
3009	6.6	440	16	5494	Yes
3010	8.6	488	17	5492	Yes
3011	8.1	449	16	5510	Yes
3012	6.2	258	17	5500	Yes
3013	9.9	483	17	5492	Yes
3014	8.2	438	18	5509	No
3015	6.2	425	18	5500	Yes
3016	6.9	393	18	5504	Yes
3017	9.1	275	16	5503	Yes
3018	10	256	18	5497	Yes
3019	8.4	284	18	5494	Yes
3020	7.6	277	18	5499	Yes
3021	6.2	318	17	5498	Yes
3022	9.6	457	16	5500	Yes
3023	8.7	260	17	5499	No
3024	8.3	295	16	5508	Yes
3025	9.4	361	18	5497	No
3026	7.3	408	16	5500	Yes
3027	6.8	370	18	5508	Yes
3028	9	430	17	5495	Yes
3029	8.6	404	16	5501	Yes
3030	6.9	359	17	5493	Yes

TYPE 4 DETECTION PROBABILITY

Data Sheet for FCC Short Pulse Radar Type 4					
Waveform	Pulse Width (us)	PRI (us)	Pulses Per Burst	Frequency (MHz)	Successful Detection (Yes/No)
4001	17.7	346	15	5508	Yes
4002	19.2	314	14	5492	Yes
4003	15.1	447	15	5510	Yes
4004	17.1	427	15	5509	Yes
4005	13.5	455	14	5503	Yes
4006	11.6	449	16	5491	Yes
4007	13.4	490	16	5494	Yes
4008	16.2	378	16	5499	Yes
4009	14.1	432	13	5497	Yes
4010	13.2	466	16	5509	Yes
4011	15.8	281	13	5496	Yes
4012	11.1	329	12	5500	Yes
4013	19	290	12	5493	Yes
4014	14.8	350	13	5498	Yes
4015	14.1	324	16	5505	Yes
4016	19.3	279	15	5496	Yes
4017	14.8	266	13	5509	Yes
4018	16.3	485	13	5509	Yes
4019	12.3	367	14	5499	Yes
4020	14.2	481	16	5508	Yes
4021	19.7	376	12	5497	Yes
4022	17.9	252	15	5492	Yes
4023	19.6	410	14	5498	Yes
4024	18.2	299	12	5506	Yes
4025	11.3	352	16	5504	Yes
4026	19.4	387	14	5506	Yes
4027	17.8	453	12	5493	Yes
4028	17.3	500	13	5502	Yes
4029	16.2	462	15	5505	Yes
4030	11.9	271	16	5496	Yes

TYPE 5 DETECTION PROBABILITY

Data Sheet for FCC Long Pulse Radar Type 5		
Trial	Frequency (MHz)	Successful Detection (Yes/No)
1	5500	Yes
2	5500	Yes
3	5500	Yes
4	5500	Yes
5	5500	Yes
6	5500	Yes
7	5500	Yes
8	5500	Yes
9	5500	Yes
10	5500	Yes
11	5497	Yes
12	5497	Yes
13	5496	Yes
14	5498	Yes
15	5496	Yes
16	5496	Yes
17	5499	Yes
18	5499	Yes
19	5499	Yes
20	5498	Yes
21	5504	Yes
22	5502	Yes
23	5501	Yes
24	5502	Yes
25	5503	Yes
26	5501	Yes
27	5503	Yes
28	5501	Yes
29	5501	Yes
30	5502	Yes

Note: The Type 5 randomized parameters tested are shown in a separate document.

TYPE 6 DETECTION PROBABILITY

Data Sheet for FCC Hopping Radar Type 6				
1 us Pulse Width, 333 us PRI, 9 Pulses per Burst, 1 Burst per Hop				
NTIA August 2005 Hopping Sequence				
Trial	Starting Index Within Sequence	Signal Generator Frequency (MHz)	Hops within Detection BW	Successful Detection (Yes/No)
1	775	5490	4	Yes
2	1250	5491	2	Yes
3	1725	5492	5	Yes
4	2200	5493	4	Yes
5	2675	5494	4	Yes
6	3150	5495	4	Yes
7	3625	5496	3	Yes
8	4100	5497	5	Yes
9	4575	5498	5	Yes
10	5050	5499	1	Yes
11	5525	5500	2	Yes
12	6000	5501	4	Yes
13	6475	5502	3	Yes
14	6950	5503	4	Yes
15	7425	5504	4	Yes
16	7900	5505	4	Yes
17	8375	5506	2	Yes
18	8850	5507	2	Yes
19	9325	5508	4	Yes
20	9800	5509	6	Yes
21	10275	5510	3	Yes
22	10750	5490	4	Yes
23	11225	5491	5	Yes
24	11700	5492	4	Yes
25	12175	5493	3	Yes
26	12650	5494	3	Yes
27	13125	5495	1	Yes
28	13600	5496	4	Yes
29	14075	5497	3	Yes
30	14550	5498	3	Yes
31	15025	5499	6	Yes
32	15500	5500	4	Yes
33	15975	5501	3	Yes
34	16450	5502	7	Yes
35	16925	5503	5	Yes
36	17400	5504	3	Yes
37	17875	5505	4	Yes
38	18350	5506	4	Yes
39	18825	5507	3	Yes
40	19300	5508	3	Yes
41	19775	5509	3	Yes
42	20250	5510	5	Yes

7.4. RESULTS FOR 40 MHz BANDWIDTH

7.4.1. TEST CHANNEL

All tests were performed at a channel center frequency of 5510 MHz.

7.4.2. RADAR WAVEFORMS AND TRAFFIC

RADAR WAVEFORMS

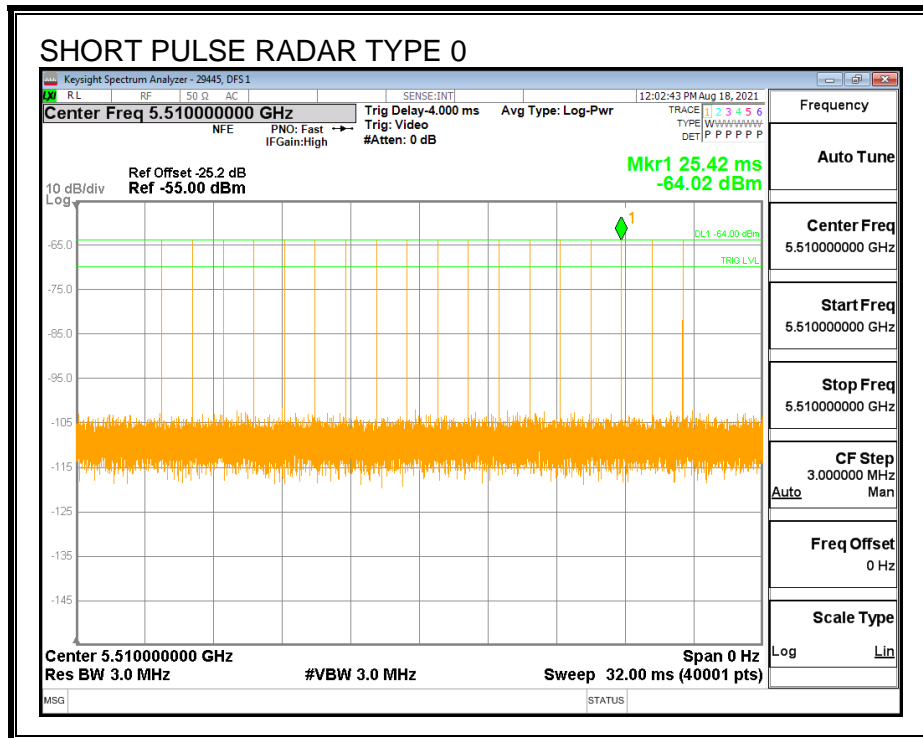

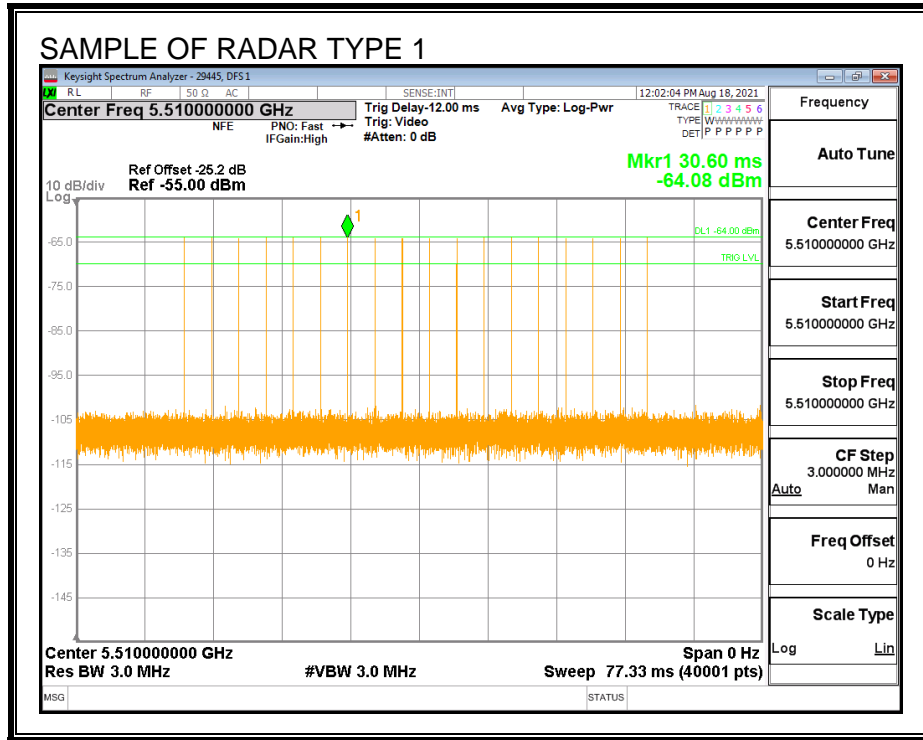

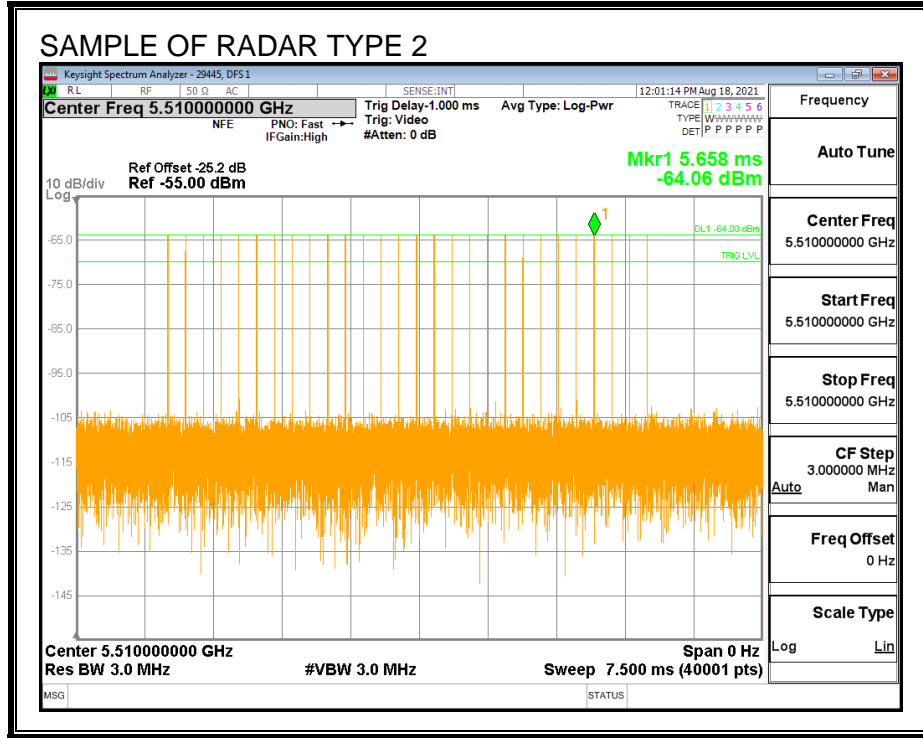

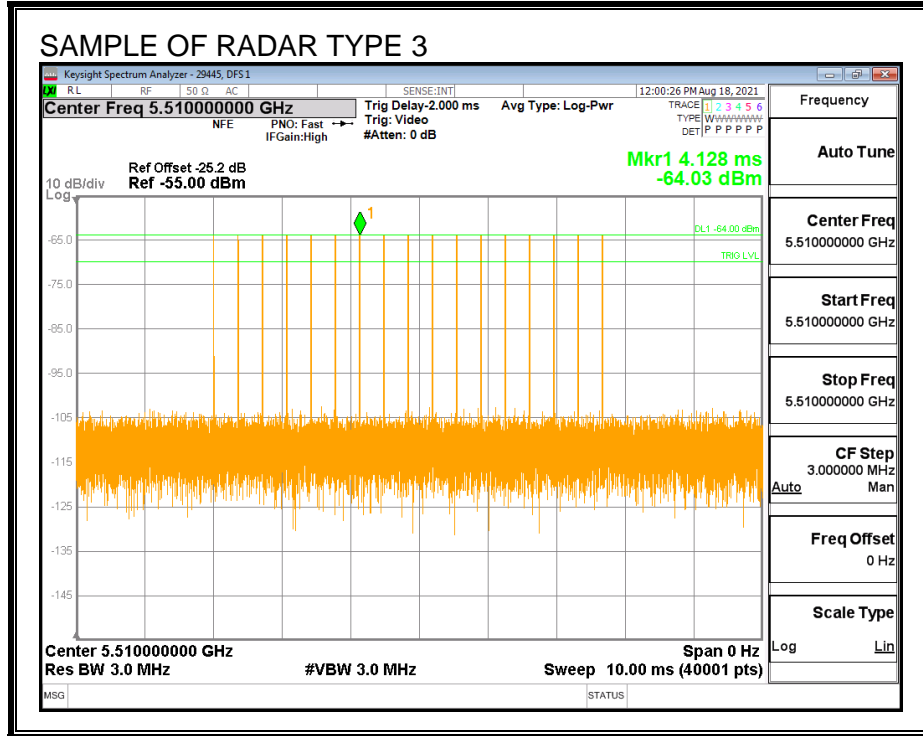

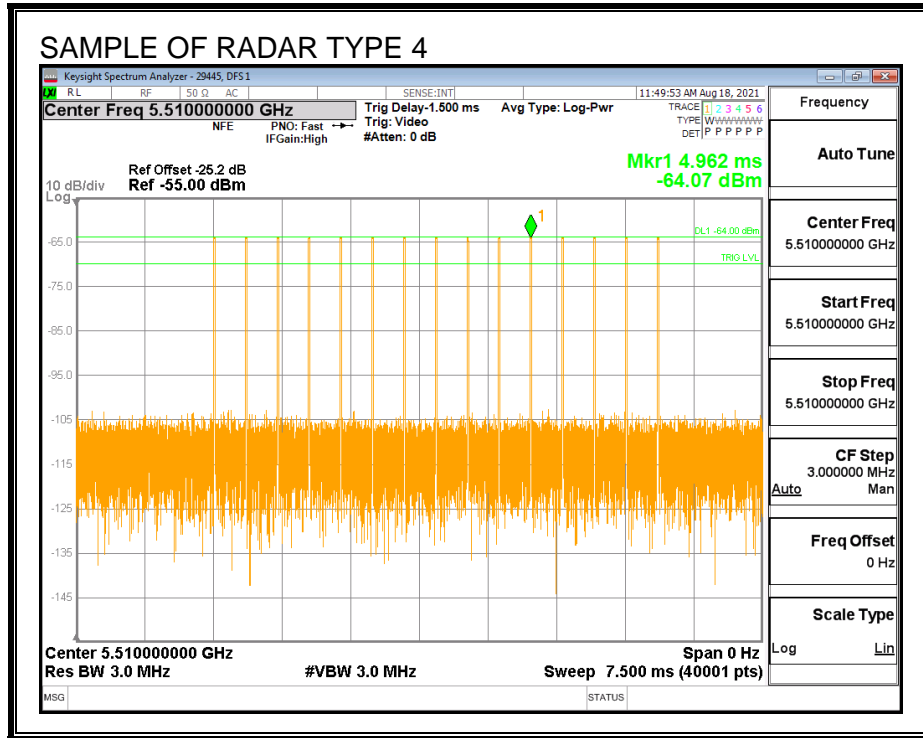

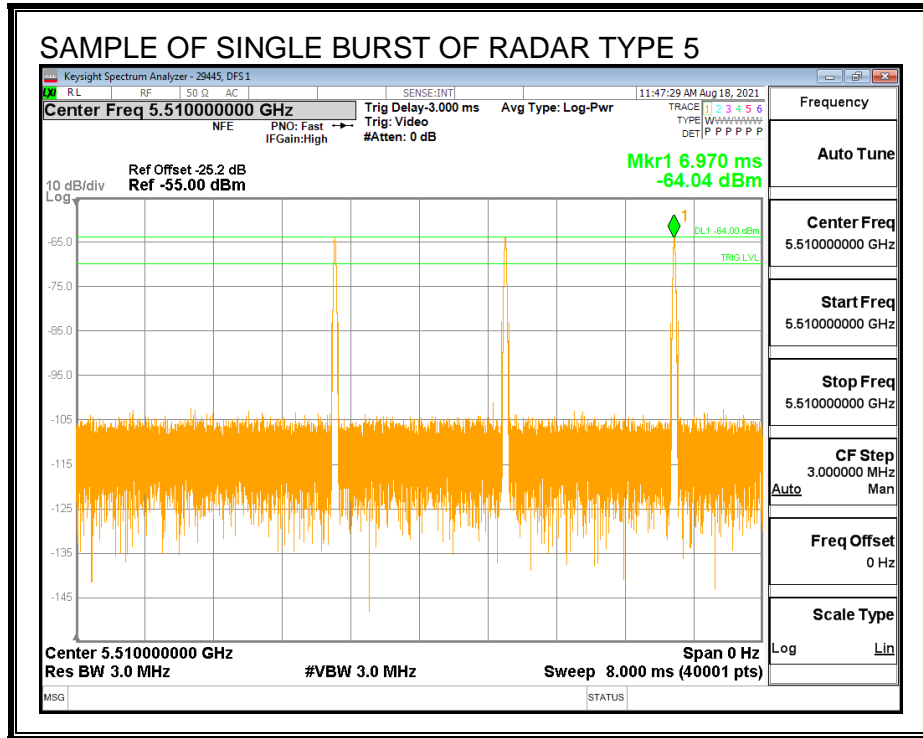

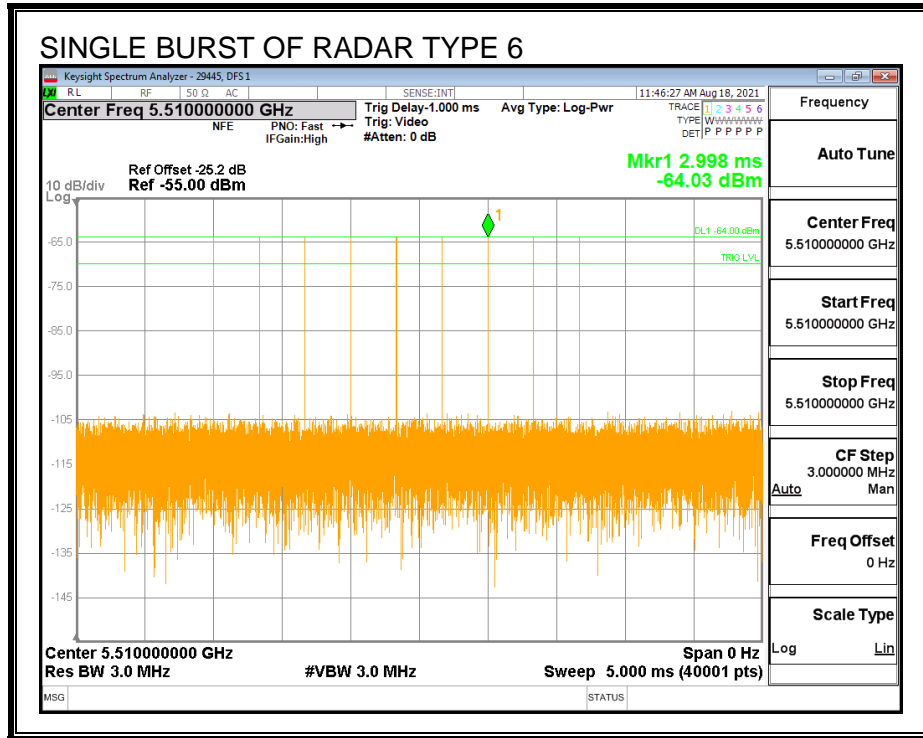

TRAFFIC

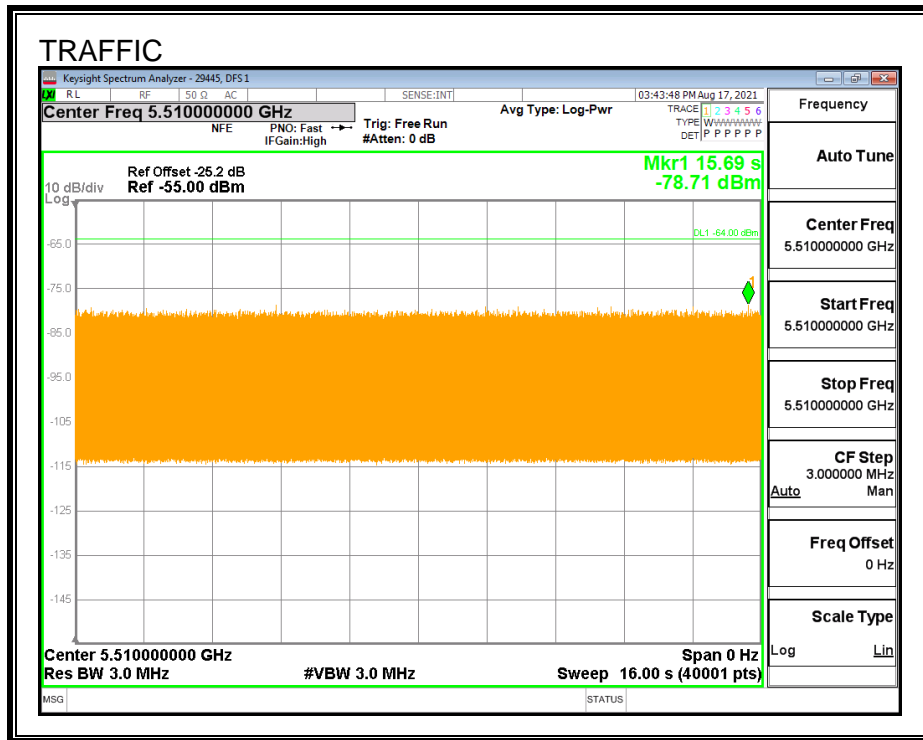

CHANNEL LOADING

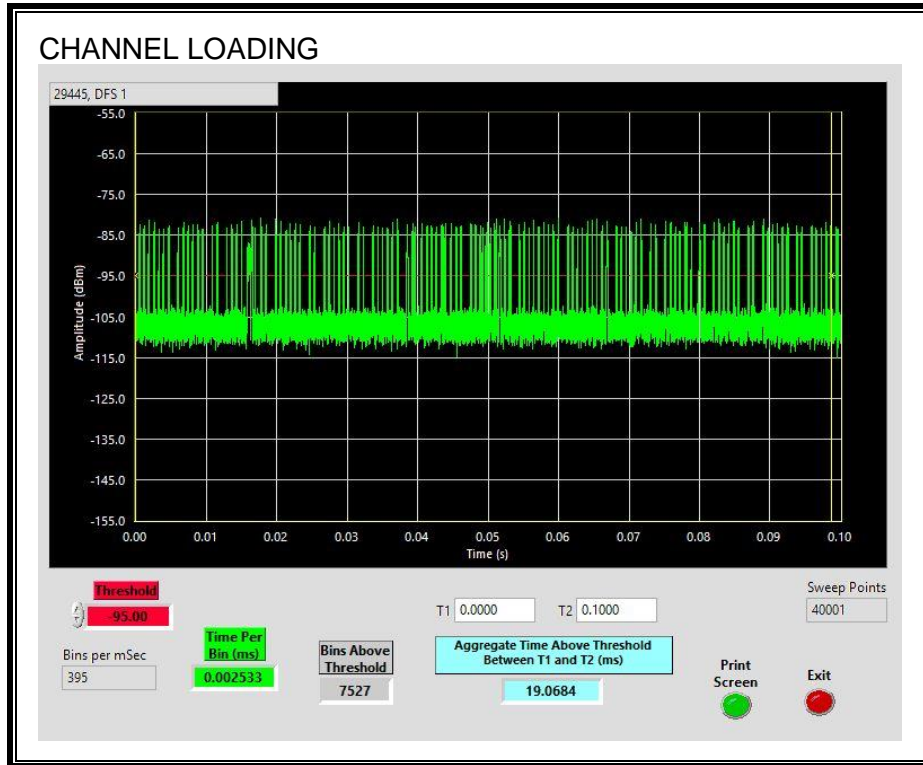

The level of traffic loading on the channel by the EUT is 19.06%

7.4.1. CHANNEL AVAILABILITY CHECK TIME

Per Table 2 on page 6 of KDB 905462 D02, Channel Move Time and Channel Closing Transmission Time are only required to be tested using the widest supported channel bandwidth mode and all other timing tests may be tested using any single channel bandwidth mode. Therefore this test has not been performed for this channel bandwidth.

7.4.2. OVERLAPPING CHANNEL TESTS

RESULTS

The channel spacing is not less than the channel bandwidth therefore the EUT does not have an overlapping channel plan.

7.4.3. MOVE AND CLOSING TIME

Per Table 2 on page 6 of KDB 905462 D02, Channel Move Time and Channel Closing Transmission Time are only required to be tested using the widest supported channel bandwidth mode and all other timing tests may be tested using any single channel bandwidth mode. Therefore this test has not been performed for this channel bandwidth.

7.4.4. DETECTION BANDWIDTH

REFERENCE PLOT OF 99% POWER BANDWIDTH

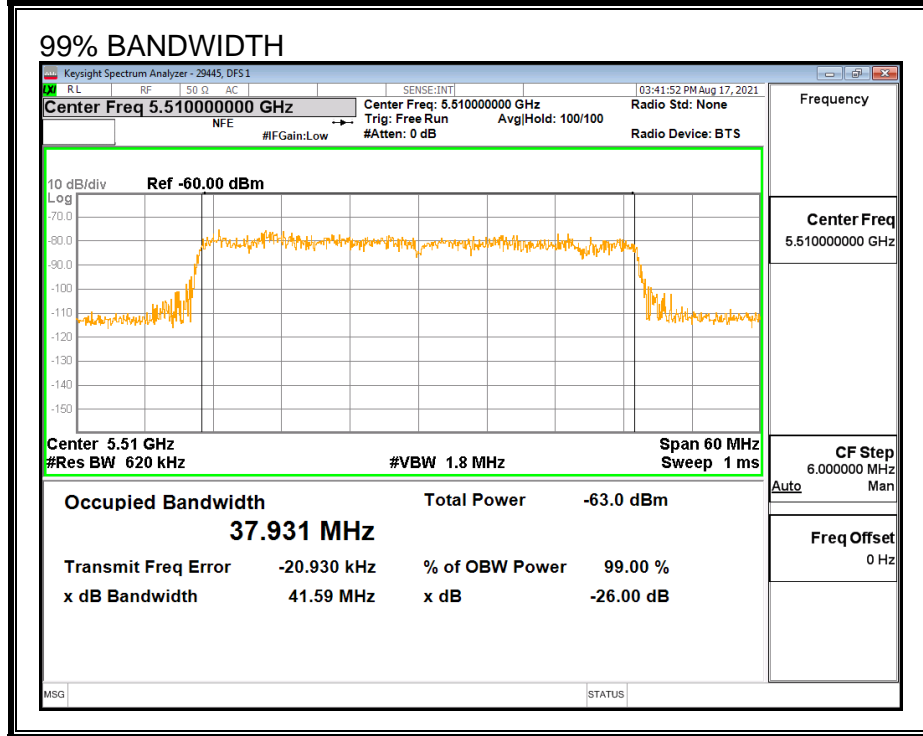

RESULTS

F_L (MHz)	F_H (MHz)	Detection Bandwidth (MHz)	99% Power Bandwidth (MHz)	Ratio of Detection BW to 99% Power BW (%)	Minimum Limit (%)
5490	5530	40	37.931	105.5	100

DETECTION BANDWIDTH PROBABILITY

DETECTION BANDWIDTH PROBABILITY RESULTS				
Detection Bandwidth Test Results		29445	DFS 1	
FCC Type 0 Waveform: 1 us Pulse Width, 1428 us PRI, 18 Pulses per Burst				
Frequency (MHz)	Number of Trials	Number Detected	Detection (%)	Mark
5490	10	10	100	FL
5495	10	10	100	
5500	10	10	100	
5505	10	10	100	
5510	10	10	100	
5515	10	10	100	
5520	10	10	100	
5525	10	10	100	
5530	10	10	100	FH

7.4.5. IN-SERVICE MONITORING

RESULTS

FCC Radar Test Summary										
Signal Type	Number of Trials	Detection (%)	Limit (%)	Pass/Fail	Detection Bandwidth		OBW	Test Location	Employee Number	In-Service Monitoring Version
					FL	FH				
FCC Short Pulse Type 1	30	96.67	60	Pass	5490	5530	37.93	DFS 1	29445	v4.1
FCC Short Pulse Type 2	30	100.00	60	Pass	5490	5530	37.93	DFS 1	29445	v4.1
FCC Short Pulse Type 3	30	100.00	60	Pass	5490	5530	37.93	DFS 1	29445	v4.1
FCC Short Pulse Type 4	30	100.00	60	Pass	5490	5530	37.93	DFS 1	29445	v4.1
Aggregate		99.17	80	Pass						
FCC Long Pulse Type 5	30	100.00	80	Pass	5490	5530	37.93	DFS 1	29445	v4.1
FCC Hopping Type 6	41	100.00	70	Pass	5490	5530		DFS 1	29445	v4.1

TYPE 1 DETECTION PROBABILITY

Data Sheet for FCC Short Pulse Radar Type 1						
Waveform	Pulse Width (us)	PRI (us)	Pulses Per Burst	Test (A/B)	Frequency (MHz)	Successful Detection (Yes/No)
1001	1	3066	18	A	5510	Yes
1002	1	798	67	A	5499	Yes
1003	1	778	68	A	5505	Yes
1004	1	618	86	A	5495	Yes
1005	1	698	76	A	5498	Yes
1006	1	518	102	A	5497	Yes
1007	1	838	63	A	5508	Yes
1008	1	678	78	A	5498	Yes
1009	1	818	65	A	5504	Yes
1010	1	918	58	A	5508	Yes
1011	1	738	72	A	5505	Yes
1012	1	718	74	A	5507	No
1013	1	858	62	A	5497	Yes
1014	1	598	89	A	5503	Yes
1015	1	638	83	A	5496	Yes
1016	1	2641	20	B	5507	Yes
1017	1	1791	30	B	5497	Yes
1018	1	746	71	B	5495	Yes
1019	1	1379	39	B	5502	Yes
1020	1	3012	18	B	5494	Yes
1021	1	1226	44	B	5498	Yes
1022	1	2989	18	B	5494	Yes
1023	1	2685	20	B	5495	Yes
1024	1	835	64	B	5502	Yes
1025	1	1856	29	B	5491	Yes
1026	1	1488	36	B	5504	Yes
1027	1	1444	37	B	5509	Yes
1028	1	2400	22	B	5509	Yes
1029	1	1291	41	B	5496	Yes
1030	1	1182	45	B	5510	Yes

TYPE 2 DETECTION PROBABILITY

Data Sheet for FCC Short Pulse Radar Type 2					
Waveform	Pulse Width (us)	PRI (us)	Pulses Per Burst	Frequency (MHz)	Successful Detection (Yes/No)
2001	3.2	194	28	5494	Yes
2002	4.3	154	27	5510	Yes
2003	5	167	27	5496	Yes
2004	4.4	212	23	5496	Yes
2005	1.3	230	23	5504	Yes
2006	5	198	23	5501	Yes
2007	4.2	181	23	5492	Yes
2008	4	154	24	5497	Yes
2009	3.5	222	28	5502	Yes
2010	1.6	203	23	5492	Yes
2011	3.4	195	24	5509	Yes
2012	1.7	219	26	5505	Yes
2013	3.8	176	27	5491	Yes
2014	2.3	166	26	5510	Yes
2015	4.6	209	28	5504	Yes
2016	3.5	203	27	5493	Yes
2017	1.9	169	26	5505	Yes
2018	3	210	25	5496	Yes
2019	3.7	223	24	5503	Yes
2020	3.1	187	28	5494	Yes
2021	4.1	204	27	5492	Yes
2022	3.7	172	28	5498	Yes
2023	2.9	156	28	5504	Yes
2024	4.9	171	29	5494	Yes
2025	4.4	196	26	5505	Yes
2026	4.4	178	28	5505	Yes
2027	2.1	170	29	5498	Yes
2028	4.5	193	23	5497	Yes
2029	2.5	151	25	5493	Yes
2030	1	221	24	5508	Yes

TYPE 3 DETECTION PROBABILITY

Data Sheet for FCC Short Pulse Radar Type 3					
Waveform	Pulse Width (us)	PRI (us)	Pulses Per Burst	Frequency (MHz)	Successful Detection (Yes/No)
3001	6.3	354	17	5499	Yes
3002	7.2	335	16	5509	Yes
3003	9.7	481	16	5505	Yes
3004	8.9	357	16	5492	Yes
3005	7.5	397	18	5500	Yes
3006	6.8	286	17	5493	Yes
3007	7.8	339	18	5496	Yes
3008	9.6	492	17	5495	Yes
3009	6.6	440	16	5499	Yes
3010	8.6	488	17	5497	Yes
3011	8.1	449	16	5503	Yes
3012	6.2	258	17	5492	Yes
3013	9.9	483	17	5506	Yes
3014	8.2	438	18	5507	Yes
3015	6.2	425	18	5497	Yes
3016	6.9	393	18	5496	Yes
3017	9.1	275	16	5492	Yes
3018	10	256	18	5504	Yes
3019	8.4	284	18	5509	Yes
3020	7.6	277	18	5496	Yes
3021	6.2	318	17	5505	Yes
3022	9.6	457	16	5496	Yes
3023	8.7	260	17	5491	Yes
3024	8.3	295	16	5497	Yes
3025	9.4	361	18	5497	Yes
3026	7.3	408	16	5509	Yes
3027	6.8	370	18	5494	Yes
3028	9	430	17	5502	Yes
3029	8.6	404	16	5500	Yes
3030	6.9	359	17	5491	Yes

TYPE 4 DETECTION PROBABILITY

Data Sheet for FCC Short Pulse Radar Type 4					
Waveform	Pulse Width (us)	PRI (us)	Pulses Per Burst	Frequency (MHz)	Successful Detection (Yes/No)
4001	17.7	346	15	5506	Yes
4002	19.2	314	14	5493	Yes
4003	15.1	447	15	5505	Yes
4004	17.1	427	15	5495	Yes
4005	13.5	455	14	5496	Yes
4006	11.6	449	16	5498	Yes
4007	13.4	490	16	5495	Yes
4008	16.2	378	16	5503	Yes
4009	14.1	432	13	5510	Yes
4010	13.2	466	16	5497	Yes
4011	15.8	281	13	5496	Yes
4012	11.1	329	12	5502	Yes
4013	19	290	12	5490	Yes
4014	14.8	350	13	5505	Yes
4015	14.1	324	16	5502	Yes
4016	19.3	279	15	5501	Yes
4017	14.8	266	13	5497	Yes
4018	16.3	485	13	5503	Yes
4019	12.3	367	14	5494	Yes
4020	14.2	481	16	5494	Yes
4021	19.7	376	12	5492	Yes
4022	17.9	252	15	5507	Yes
4023	19.6	410	14	5509	Yes
4024	18.2	299	12	5508	Yes
4025	11.3	352	16	5496	Yes
4026	19.4	387	14	5491	Yes
4027	17.8	453	12	5495	Yes
4028	17.3	500	13	5503	Yes
4029	16.2	462	15	5493	Yes
4030	11.9	271	16	5501	Yes

TYPE 5 DETECTION PROBABILITY

Data Sheet for FCC Long Pulse Radar Type 5		
Trial	Frequency (MHz)	Successful Detection (Yes/No)
1	5510	Yes
2	5510	Yes
3	5510	Yes
4	5510	Yes
5	5510	Yes
6	5510	Yes
7	5510	Yes
8	5510	Yes
9	5510	Yes
10	5510	Yes
11	5497	Yes
12	5498	Yes
13	5497	Yes
14	5498	Yes
15	5497	Yes
16	5497	Yes
17	5499	Yes
18	5500	Yes
19	5500	Yes
20	5499	Yes
21	5524	Yes
22	5522	Yes
23	5521	Yes
24	5522	Yes
25	5522	Yes
26	5521	Yes
27	5523	Yes
28	5521	Yes
29	5521	Yes
30	5521	Yes

Note: The Type 5 randomized parameters tested are shown in a separate document.

TYPE 6 DETECTION PROBABILITY

Data Sheet for FCC Hopping Radar Type 6				
1 us Pulse Width, 333 us PRI, 9 Pulses per Burst, 1 Burst per Hop				
NTIA August 2005 Hopping Sequence				
Trial	Starting Index Within Sequence	Signal Generator Frequency (MHz)	Hops within Detection BW	Successful Detection (Yes/No)
1	520	5490	9	Yes
2	995	5491	9	Yes
3	1470	5492	6	Yes
4	1945	5493	11	Yes
5	2420	5494	18	Yes
6	2895	5495	8	Yes
7	3370	5496	7	Yes
8	3845	5497	7	Yes
9	4320	5498	10	Yes
10	4795	5499	8	Yes
11	5270	5500	7	Yes
12	5745	5501	8	Yes
13	6220	5502	6	Yes
14	6695	5503	12	Yes
15	7170	5504	9	Yes
16	7645	5505	10	Yes
17	8120	5506	13	Yes
18	8595	5507	5	Yes
19	9070	5508	5	Yes
20	9545	5509	11	Yes
21	10020	5510	10	Yes
22	10495	5511	9	Yes
23	10970	5512	7	Yes
24	11445	5513	8	Yes
25	11920	5514	9	Yes
26	12395	5515	8	Yes
27	12870	5516	7	Yes
28	13345	5517	9	Yes
29	13820	5518	15	Yes
30	14295	5519	7	Yes
31	14770	5520	9	Yes
32	15245	5521	6	Yes
33	15720	5522	12	Yes
34	16195	5523	10	Yes
35	16670	5524	9	Yes
36	17145	5525	5	Yes
37	17620	5526	9	Yes
38	18095	5527	11	Yes
39	18570	5528	6	Yes
40	19045	5529	9	Yes
41	19520	5530	4	Yes

7.5. RESULTS FOR 80 MHz BANDWIDTH

7.5.1. TEST CHANNEL

All tests were performed at a channel center frequency of 5530 MHz.

7.5.2. RADAR WAVEFORMS AND TRAFFIC

RADAR WAVEFORMS

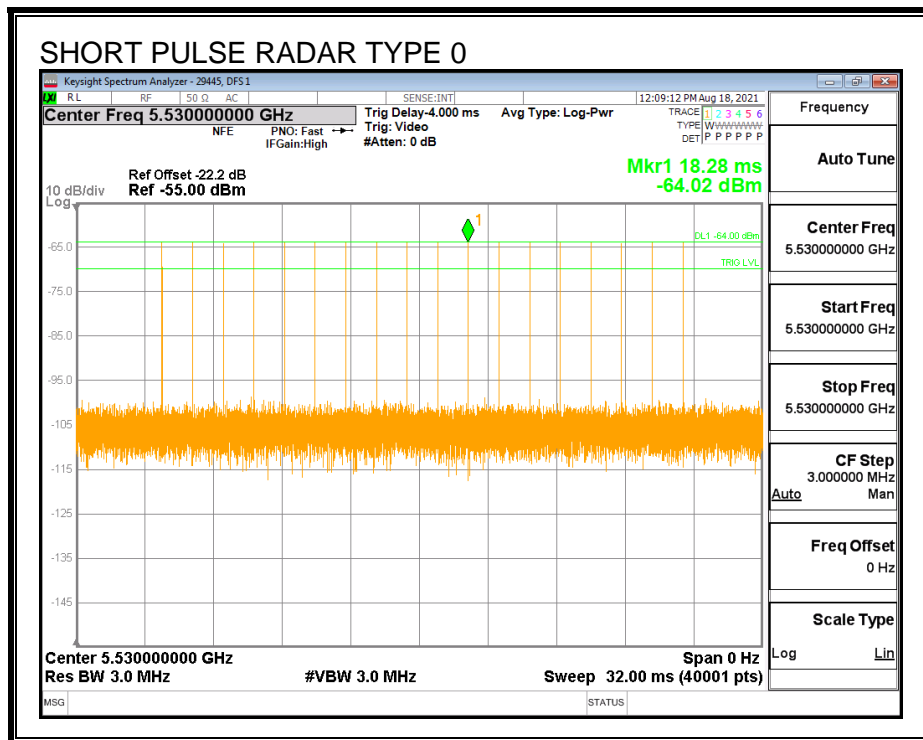

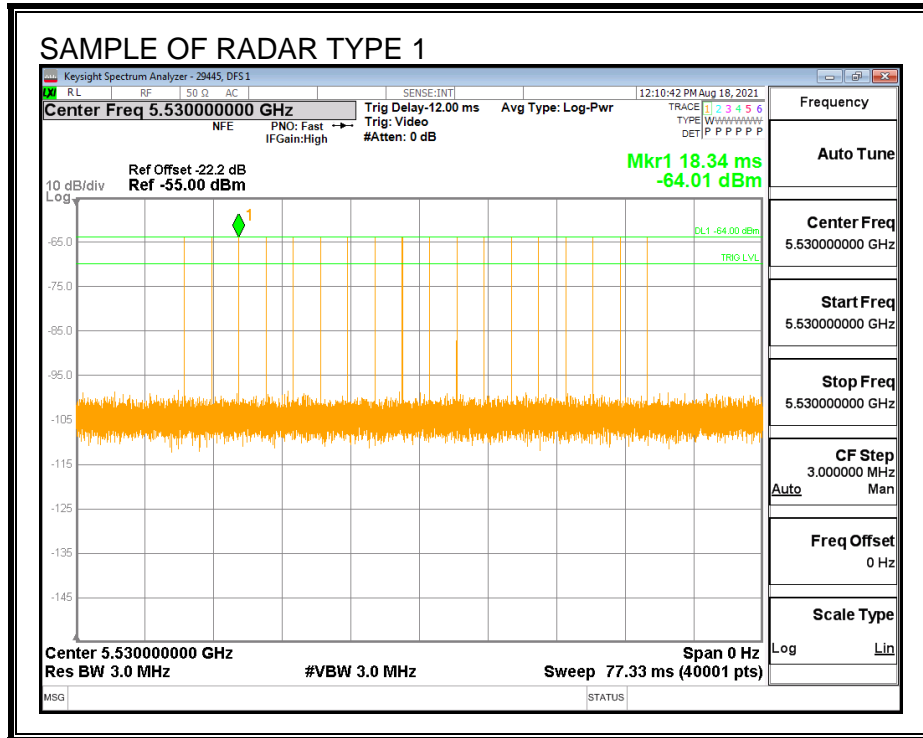

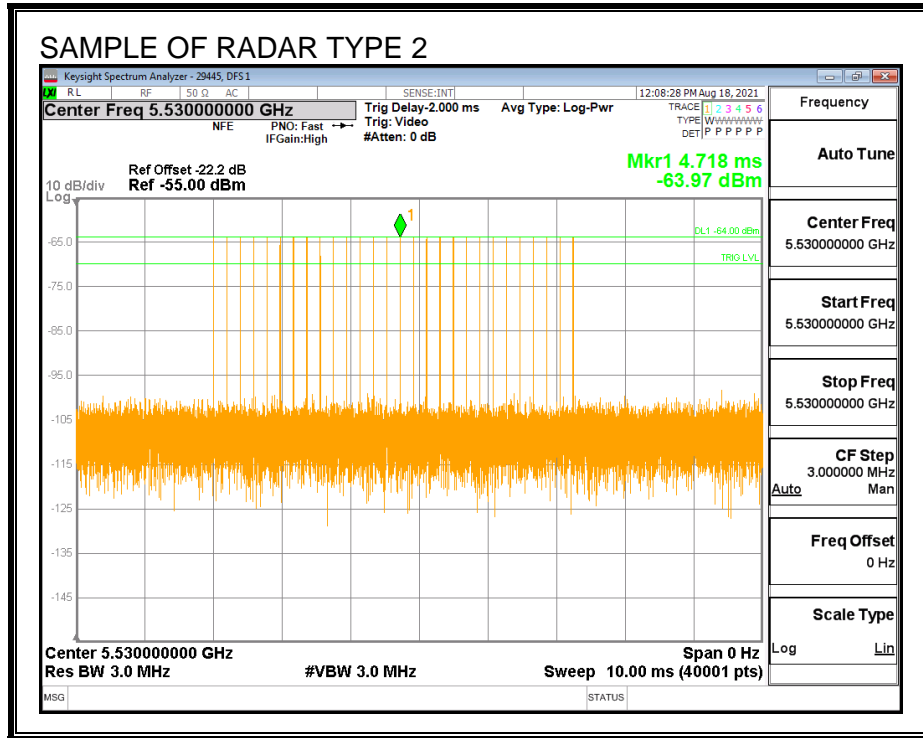

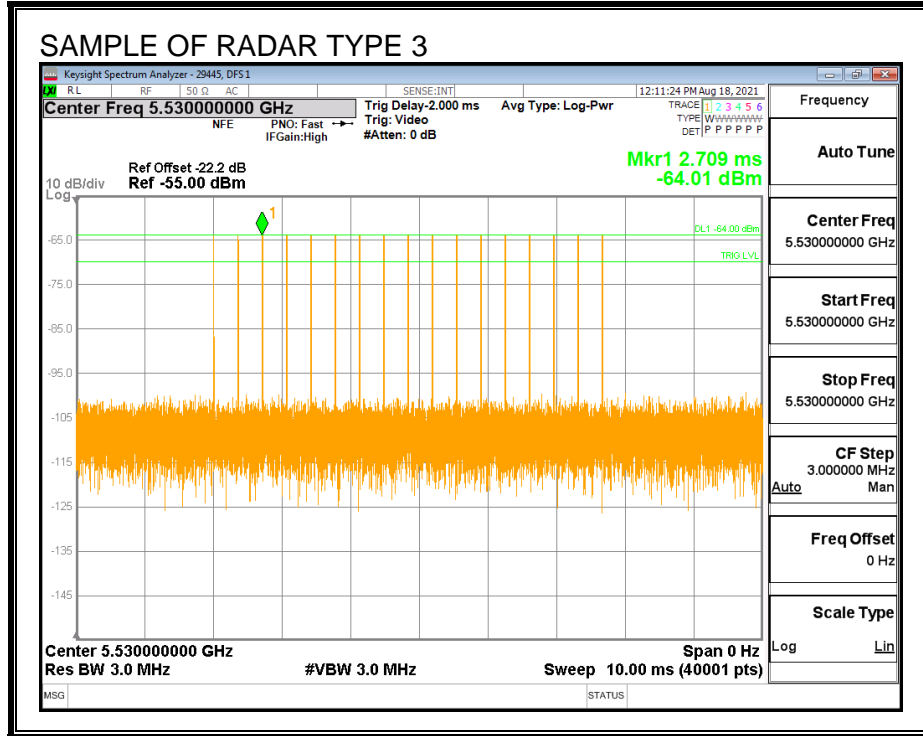

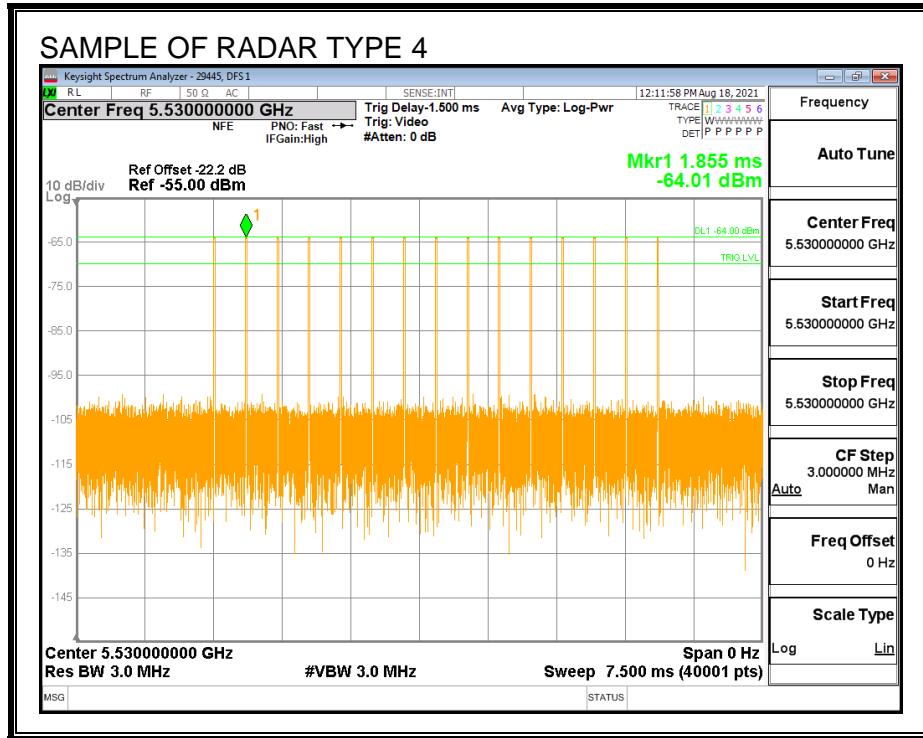

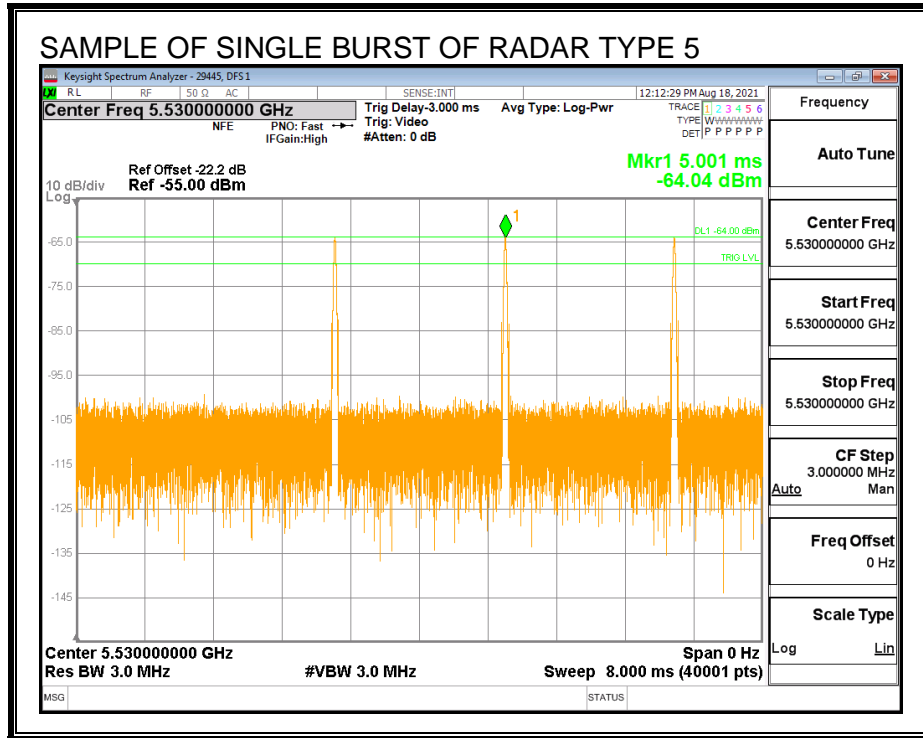

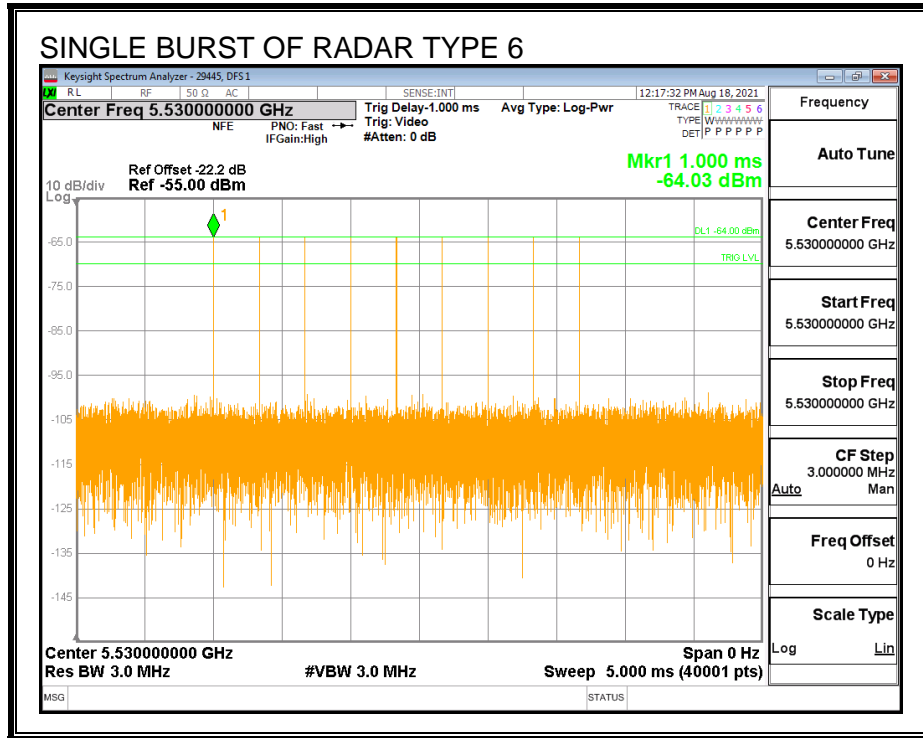

TRAFFIC

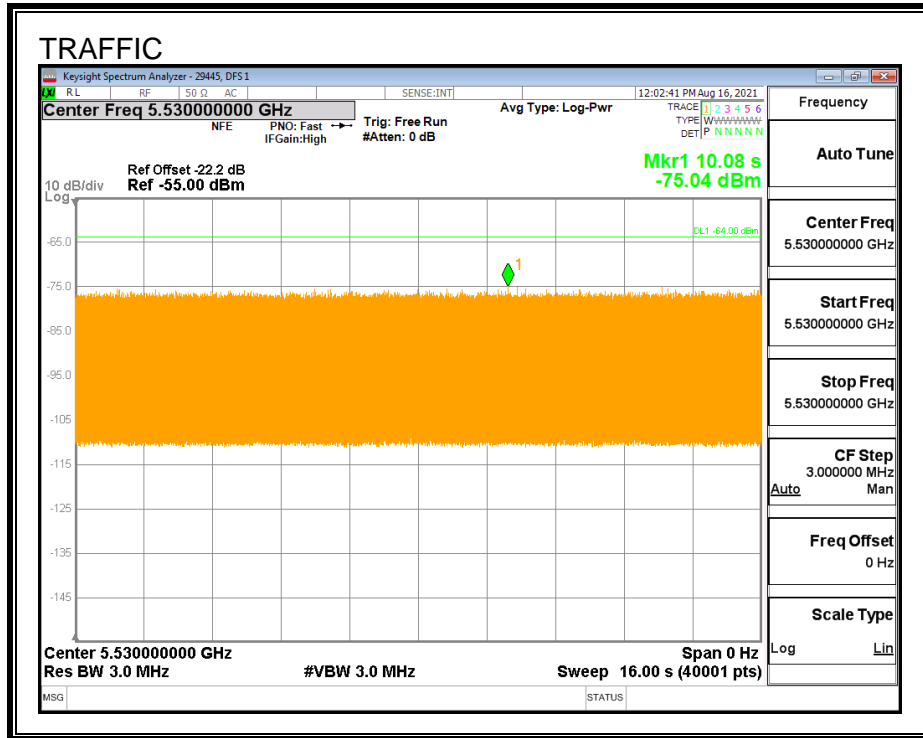

CHANNEL LOADING

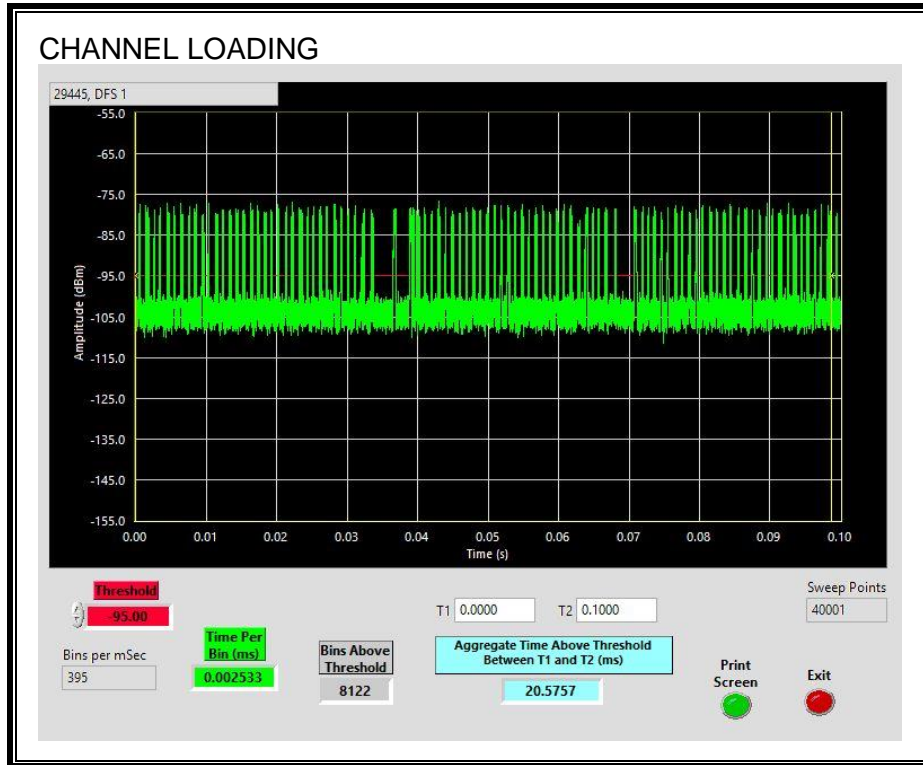

The level of traffic loading on the channel by the EUT is 20.57%

7.5.3. CHANNEL AVAILABILITY CHECK TIME

PROCEDURE TO DETERMINE INITIAL POWER-UP CYCLE TIME

A link was established on channel then the EUT was rebooted. The time from the cessation of traffic to the re-initialization of traffic was measured as the time required for the EUT to complete the total power-up cycle. The time to complete the initial power-up period is 60 seconds less than this total power-up time.

PROCEDURE FOR TIMING OF RADAR BURST

With a link established on channel, the EUT was rebooted. A radar signal was triggered within 0 to 6 seconds after the initial power-up period, and transmissions on the channel were monitored on the spectrum analyzer.

The Non-Occupancy list was cleared. With a link established on channel, the EUT was rebooted. A radar signal was triggered within 54 to 60 seconds after the initial power-up period, and transmissions on the channel were monitored on the spectrum analyzer.

QUANTITATIVE RESULTS

Timing of Reboot (sec)	Timing of Start of Traffic (sec)	Total Power-up Cycle Time (sec)	Initial Power-up Cycle Time (sec)
30.09	203.6	173.5	113.5

Radar Near Beginning of CAC

Timing of Reboot (sec)	Timing of Radar Burst (sec)	Radar Relative to Reboot (sec)	Radar Relative to Start of CAC (sec)
30.47	148.3	117.8	4.3

Radar Near End of CAC

Timing of Reboot (sec)	Timing of Radar Burst (sec)	Radar Relative to Reboot (sec)	Radar Relative to Start of CAC (sec)
29.5	200.8	171.3	57.8

QUALITATIVE RESULTS

Timing of Radar Burst	Display on Control Computer	Spectrum Analyzer Display
No Radar Triggered	EUT marks Channel as active	Transmissions begin on channel after completion of the initial power-up cycle and the CAC
Within 0 to 6 second window	EUT indicates radar detected	No transmissions on channel
Within 54 to 60 second window	EUT indicates radar detected	No transmissions on channel

TIMING WITHOUT RADAR DURING CAC

AP is rebooted
Traffic ceases
Start of Initial Power-up cycle

End of Initial Power-up cycle
Start of CAC

End of CAC
Traffic is Initiated

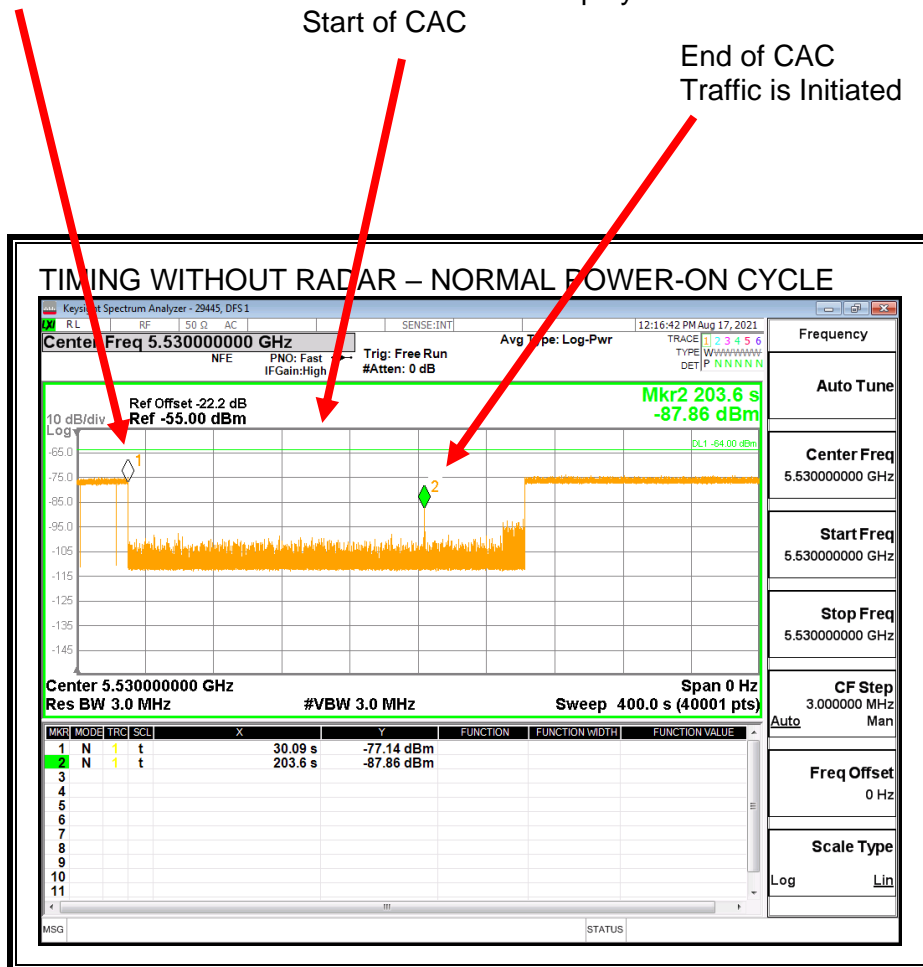

Transmissions begin on channel after completion of the initial power-up cycle and the CAC.

TIMING WITH RADAR NEAR BEGINNING OF CAC

AP is rebooted
Traffic ceases
Start of Initial Power-up cycle

End of Initial Power-up cycle
Start of CAC

Radar Signal Applied

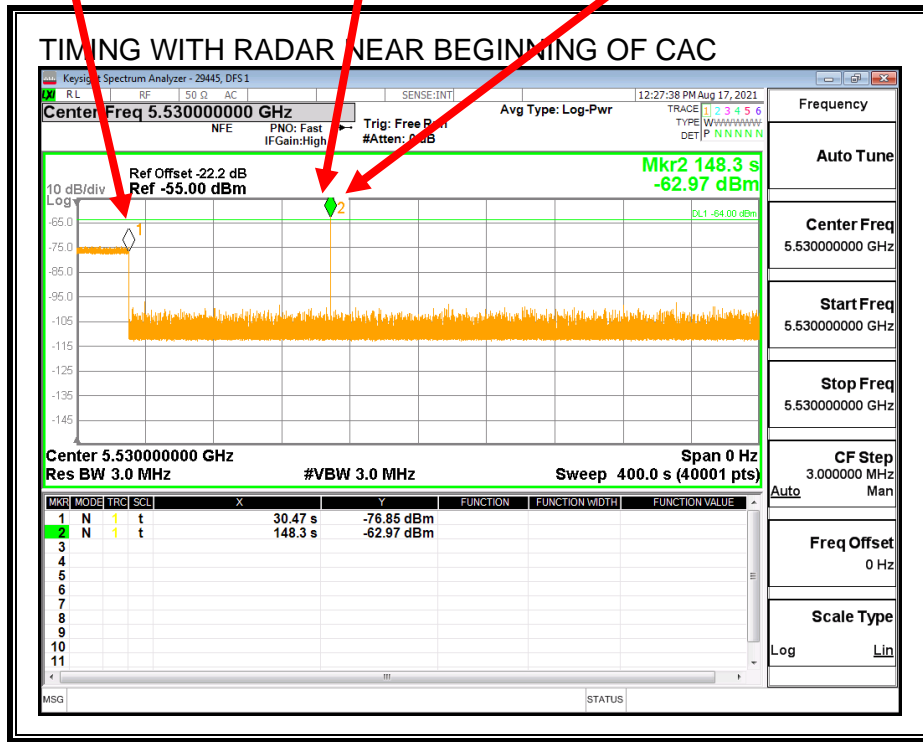

No EUT transmissions were observed after the radar signal.

TIMING WITH RADAR NEAR END OF CAC

AP is rebooted
Traffic ceases
Start of Initial Power-up cycle

End of Initial Power-up cycle
Start of CAC

Radar Signal Applied

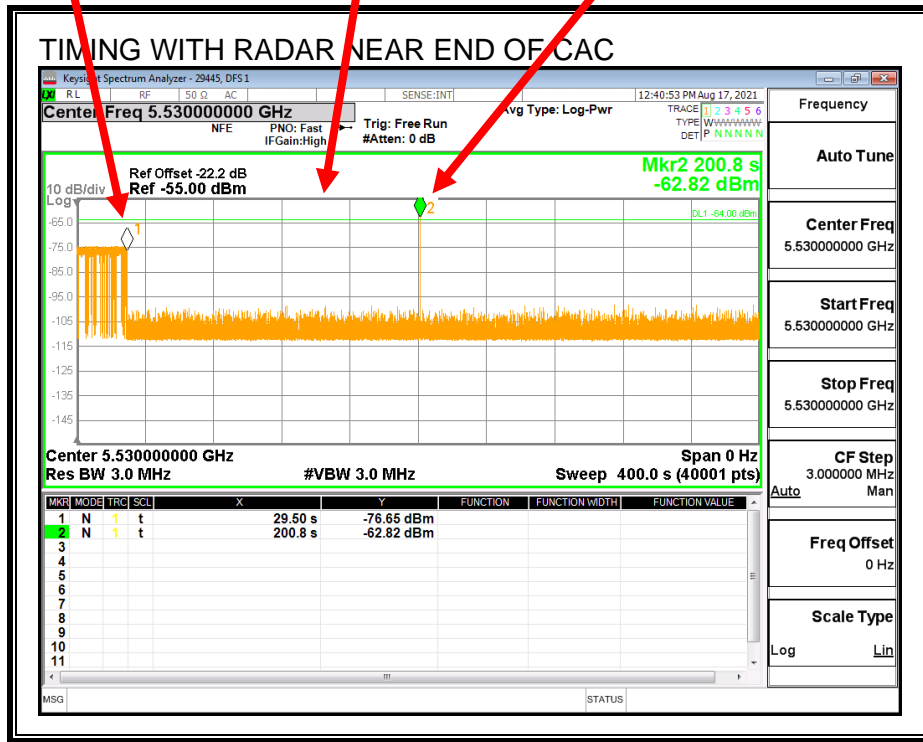

No EUT transmissions were observed after the radar signal.

7.5.4. OVERLAPPING CHANNEL TESTS

RESULTS

The channel spacing is not less than the channel bandwidth therefore the EUT does not have an overlapping channel plan.

7.5.5. MOVE AND CLOSING TIME

REPORTING NOTES

The reference marker is set at the end of last radar pulse.

The delta marker is set at the end of the last WLAN transmission following the radar pulse. This delta is the channel move time.

The aggregate channel closing transmission time is calculated as follows:

Aggregate Transmission Time =
(Number of analyzer bins showing transmission) * (dwell time per bin)

The observation period over which the aggregate time is calculated begins at (Reference Marker + 200 msec) and ends no earlier than (Reference Marker + 10 sec).

RESULTS

Channel Move Time (sec)	Limit (sec)
0.0	10

Aggregate Channel Closing Transmission Time (msec)	Limit (msec)
0.0	60

MOVE TIME

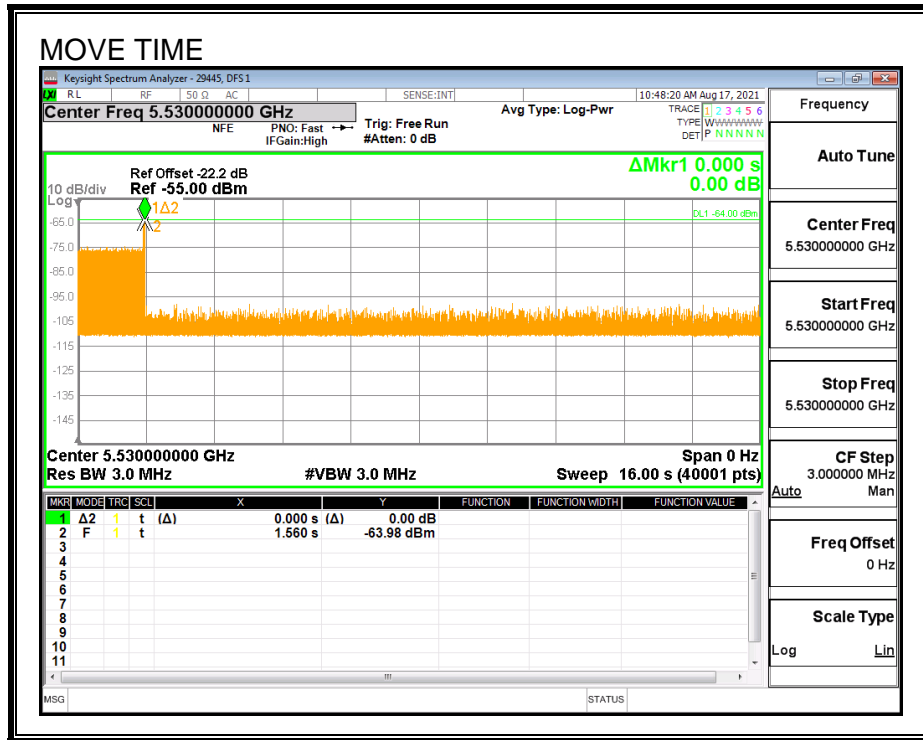

CHANNEL CLOSING TIME

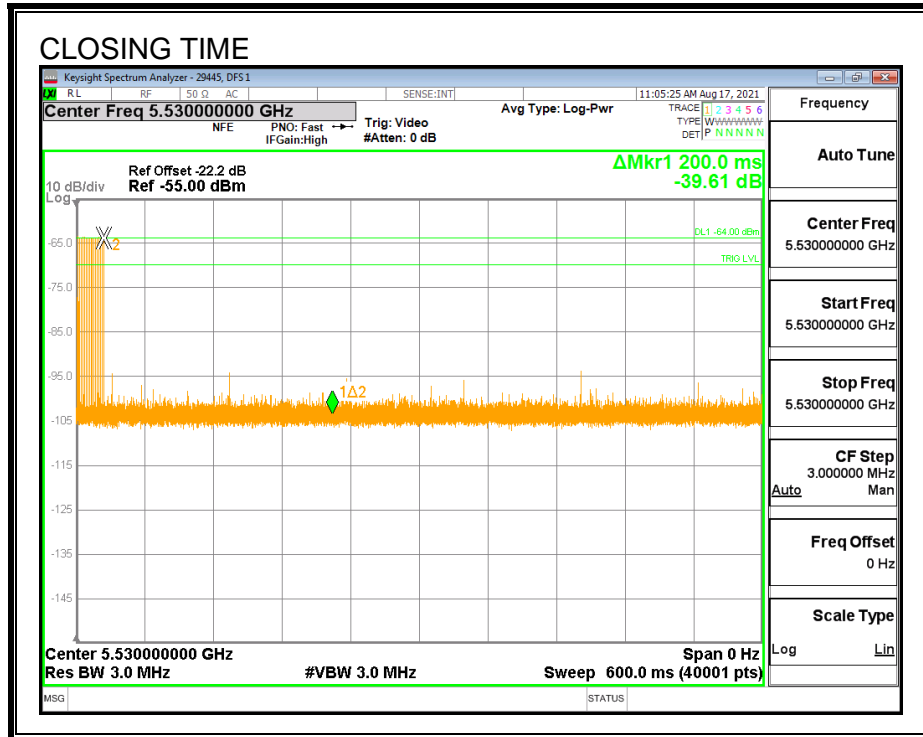

AGGREGATE CHANNEL CLOSING TRANSMISSION TIME

No transmissions are observed during the aggregate monitoring period.

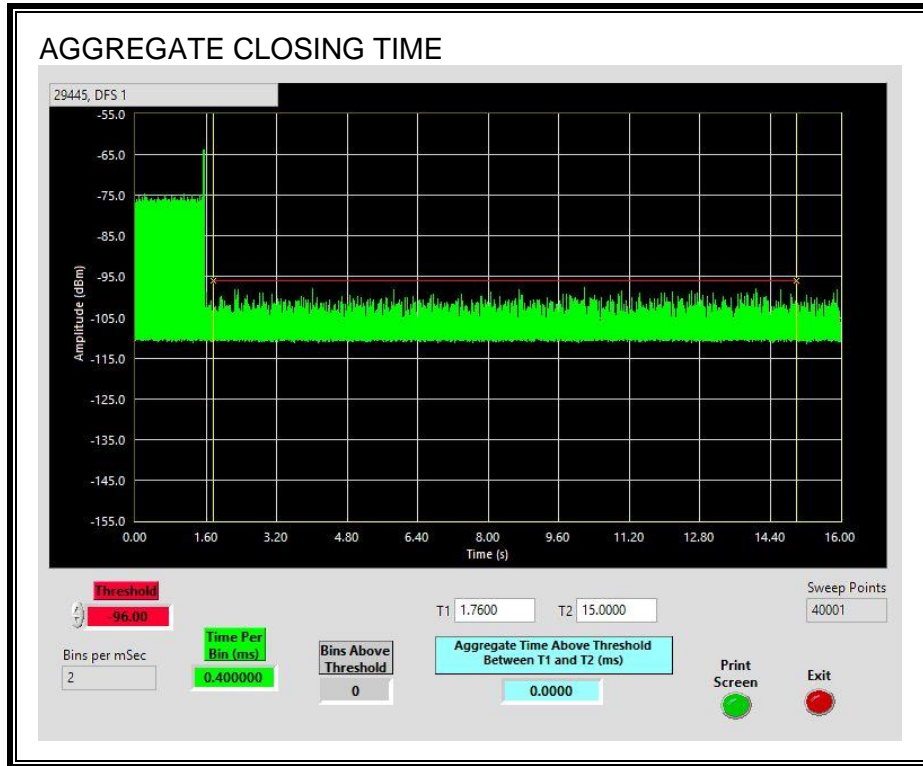

LONG PULSE CHANNEL MOVE TIME

The traffic ceases prior to 10 seconds after the end of the radar waveform.

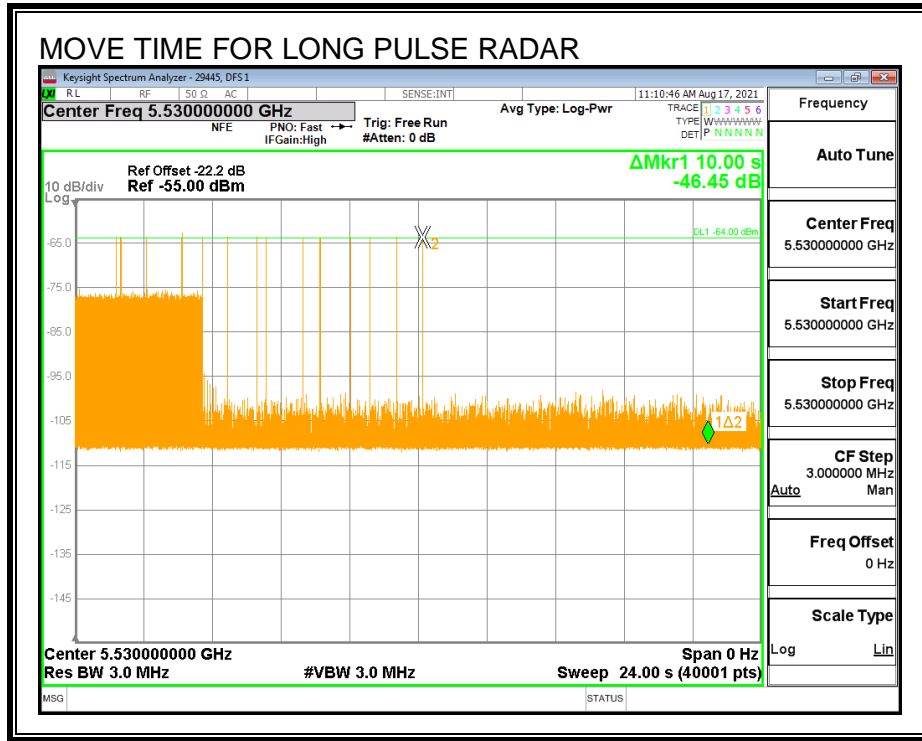

7.5.6. NON-OCCUPANCY PERIOD

RESULTS

No EUT transmissions were observed on the test channel during the 30-minute observation time.

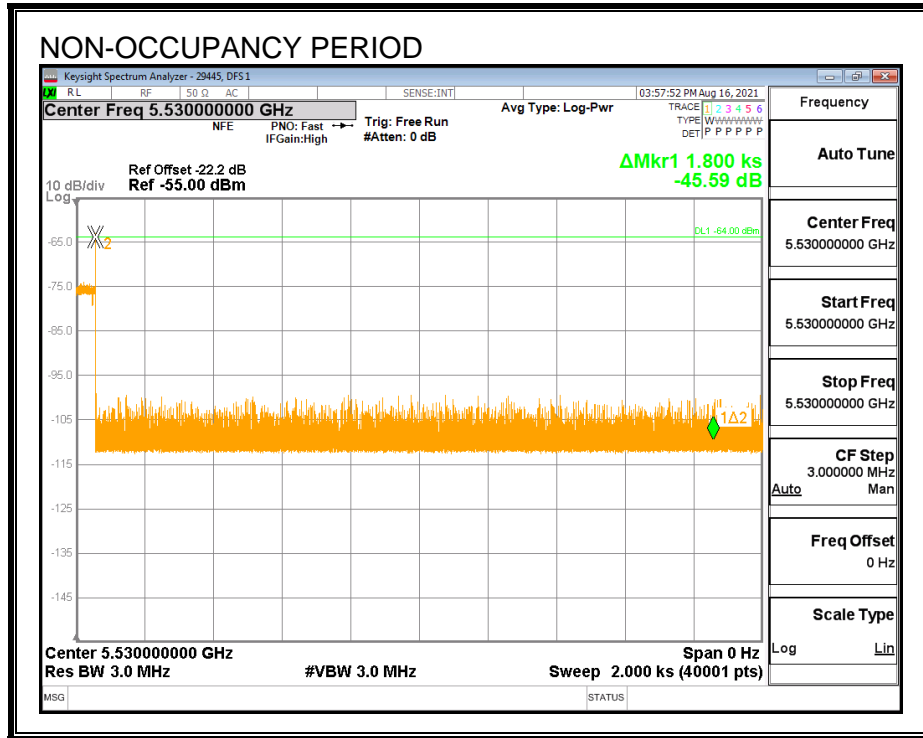

7.5.7. DETECTION BANDWIDTH

REFERENCE PLOT OF 99% POWER BANDWIDTH

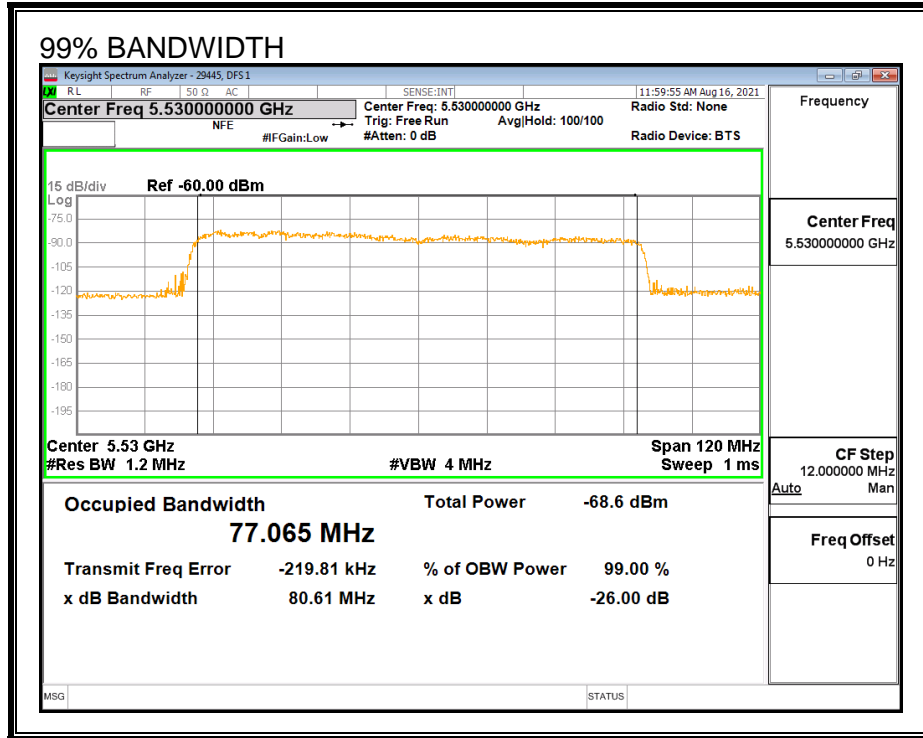

RESULTS

F_L (MHz)	F_H (MHz)	Detection Bandwidth (MHz)	99% Power Bandwidth (MHz)	Ratio of Detection BW to 99% Power BW (%)	Minimum Limit (%)
5490	5570	80	77.065	103.8	100

DETECTION BANDWIDTH PROBABILITY

DETECTION BANDWIDTH PROBABILITY RESULTS				
Detection Bandwidth Test Results		29445	DFS 1	
FCC Type 0 Waveform: 1 us Pulse Width, 1428 us PRI, 18 Pulses per Burst				
Frequency (MHz)	Number of Trials	Number Detected	Detection (%)	Mark
5490	10	10	100	FL
5495	10	9	90	
5500	10	10	100	
5505	10	10	100	
5510	10	10	100	
5515	10	10	100	
5520	10	10	100	
5525	10	10	100	
5530	10	10	100	
5535	10	10	100	
5540	10	10	100	
5545	10	10	100	
5550	10	10	100	
5555	10	10	100	
5560	10	10	100	
5565	10	10	100	
5570	10	10	100	FH

7.5.8. IN-SERVICE MONITORING

RESULTS

FCC Radar Test Summary										
Signal Type	Number of Trials	Detection (%)	Limit (%)	Pass/Fail	Detection Bandwidth		OBW	Test Location	Employee Number	In-Service Monitoring Version
					FL	FH				
FCC Short Pulse Type 1	30	96.67	60	Pass	5490	5570	77.06	DFS 1	29445	v4.1
FCC Short Pulse Type 2	30	96.67	60	Pass	5490	5570	77.06	DFS 1	29445	v4.1
FCC Short Pulse Type 3	30	93.33	60	Pass	5490	5570	77.06	DFS 1	29445	v4.1
FCC Short Pulse Type 4	30	70.00	60	Pass	5490	5570	77.06	DFS 1	29445	v4.1
Aggregate		89.17	80	Pass						
FCC Long Pulse Type 5	30	100.00	80	Pass	5490	5570	77.06	DFS 1	29445	v4.1
FCC Hopping Type 6	81	100.00	70	Pass	5490	5570		DFS 1	29445	v4.1

TYPE 1 DETECTION PROBABILITY

Data Sheet for FCC Short Pulse Radar Type 1						
Waveform	Pulse Width (us)	PRI (us)	Pulses Per Burst	Test (A/B)	Frequency (MHz)	Successful Detection (Yes/No)
1001	1	3066	18	A	5556	Yes
1002	1	798	67	A	5564	Yes
1003	1	778	68	A	5543	Yes
1004	1	618	86	A	5506	Yes
1005	1	698	76	A	5502	Yes
1006	1	518	102	A	5532	Yes
1007	1	838	63	A	5501	Yes
1008	1	678	78	A	5523	Yes
1009	1	818	65	A	5536	Yes
1010	1	918	58	A	5510	Yes
1011	1	738	72	A	5495	Yes
1012	1	718	74	A	5492	Yes
1013	1	858	62	A	5568	Yes
1014	1	598	89	A	5514	Yes
1015	1	638	83	A	5514	Yes
1016	1	2641	20	B	5552	No
1017	1	1791	30	B	5556	Yes
1018	1	746	71	B	5503	Yes
1019	1	1379	39	B	5547	Yes
1020	1	3012	18	B	5502	Yes
1021	1	1226	44	B	5553	Yes
1022	1	2989	18	B	5510	Yes
1023	1	2685	20	B	5551	Yes
1024	1	835	64	B	5501	Yes
1025	1	1856	29	B	5492	Yes
1026	1	1488	36	B	5565	Yes
1027	1	1444	37	B	5528	Yes
1028	1	2400	22	B	5548	Yes
1029	1	1291	41	B	5549	Yes
1030	1	1182	45	B	5506	Yes

TYPE 2 DETECTION PROBABILITY

Data Sheet for FCC Short Pulse Radar Type 2					
Waveform	Pulse Width (us)	PRI (us)	Pulses Per Burst	Frequency (MHz)	Successful Detection (Yes/No)
2001	3.2	194	28	5529	Yes
2002	4.3	154	27	5559	Yes
2003	5	167	27	5569	Yes
2004	4.4	212	23	5538	Yes
2005	1.3	230	23	5512	Yes
2006	5	198	23	5498	No
2007	4.2	181	23	5567	Yes
2008	4	154	24	5543	Yes
2009	3.5	222	28	5549	Yes
2010	1.6	203	23	5554	Yes
2011	3.4	195	24	5546	Yes
2012	1.7	219	26	5506	Yes
2013	3.8	176	27	5538	Yes
2014	2.3	166	26	5497	Yes
2015	4.6	209	28	5547	Yes
2016	3.5	203	27	5547	Yes
2017	1.9	169	26	5515	Yes
2018	3	210	25	5547	Yes
2019	3.7	223	24	5550	Yes
2020	3.1	187	28	5520	Yes
2021	4.1	204	27	5555	Yes
2022	3.7	172	28	5544	Yes
2023	2.9	156	28	5494	Yes
2024	4.9	171	29	5499	Yes
2025	4.4	196	26	5515	Yes
2026	4.4	178	28	5509	Yes
2027	2.1	170	29	5507	Yes
2028	4.5	193	23	5532	Yes
2029	2.5	151	25	5511	Yes
2030	1	221	24	5490	Yes

TYPE 3 DETECTION PROBABILITY

Data Sheet for FCC Short Pulse Radar Type 3					
Waveform	Pulse Width (us)	PRI (us)	Pulses Per Burst	Frequency (MHz)	Successful Detection (Yes/No)
3001	6.3	354	17	5569	Yes
3002	7.2	335	16	5536	Yes
3003	9.7	481	16	5538	Yes
3004	8.9	357	16	5541	Yes
3005	7.5	397	18	5514	No
3006	6.8	286	17	5509	Yes
3007	7.8	339	18	5504	Yes
3008	9.6	492	17	5553	Yes
3009	6.6	440	16	5509	Yes
3010	8.6	488	17	5561	Yes
3011	8.1	449	16	5560	Yes
3012	6.2	258	17	5501	Yes
3013	9.9	483	17	5550	Yes
3014	8.2	438	18	5566	Yes
3015	6.2	425	18	5554	Yes
3016	6.9	393	18	5506	Yes
3017	9.1	275	16	5520	Yes
3018	10	256	18	5506	Yes
3019	8.4	284	18	5517	Yes
3020	7.6	277	18	5555	Yes
3021	6.2	318	17	5537	No
3022	9.6	457	16	5518	Yes
3023	8.7	260	17	5516	Yes
3024	8.3	295	16	5533	Yes
3025	9.4	361	18	5522	Yes
3026	7.3	408	16	5544	Yes
3027	6.8	370	18	5539	Yes
3028	9	430	17	5546	Yes
3029	8.6	404	16	5532	Yes
3030	6.9	359	17	5531	Yes

TYPE 4 DETECTION PROBABILITY

Data Sheet for FCC Short Pulse Radar Type 4					
Waveform	Pulse Width (us)	PRI (us)	Pulses Per Burst	Frequency (MHz)	Successful Detection (Yes/No)
4001	17.7	346	15	5557	Yes
4002	19.2	314	14	5534	No
4003	15.1	447	15	5553	No
4004	17.1	427	15	5545	Yes
4005	13.5	455	14	5539	Yes
4006	11.6	449	16	5516	Yes
4007	13.4	490	16	5507	Yes
4008	16.2	378	16	5496	No
4009	14.1	432	13	5502	Yes
4010	13.2	466	16	5497	Yes
4011	15.8	281	13	5503	Yes
4012	11.1	329	12	5553	Yes
4013	19	290	12	5549	Yes
4014	14.8	350	13	5514	No
4015	14.1	324	16	5542	Yes
4016	19.3	279	15	5493	Yes
4017	14.8	266	13	5513	No
4018	16.3	485	13	5502	Yes
4019	12.3	367	14	5497	Yes
4020	14.2	481	16	5523	Yes
4021	19.7	376	12	5498	Yes
4022	17.9	252	15	5531	Yes
4023	19.6	410	14	5533	Yes
4024	18.2	299	12	5542	Yes
4025	11.3	352	16	5495	No
4026	19.4	387	14	5504	Yes
4027	17.8	453	12	5553	No
4028	17.3	500	13	5551	No
4029	16.2	462	15	5499	No
4030	11.9	271	16	5516	Yes

TYPE 5 DETECTION PROBABILITY

Data Sheet for FCC Long Pulse Radar Type 5		
Trial	Frequency (MHz)	Successful Detection (Yes/No)
1	5530	Yes
2	5530	Yes
3	5530	Yes
4	5530	Yes
5	5530	Yes
6	5530	Yes
7	5530	Yes
8	5530	Yes
9	5530	Yes
10	5530	Yes
11	5498	Yes
12	5498	Yes
13	5497	Yes
14	5499	Yes
15	5497	Yes
16	5497	Yes
17	5500	Yes
18	5500	Yes
19	5500	Yes
20	5499	Yes
21	5563	Yes
22	5561	Yes
23	5560	Yes
24	5561	Yes
25	5562	Yes
26	5560	Yes
27	5563	Yes
28	5561	Yes
29	5560	Yes
30	5561	Yes

Note: The Type 5 randomized parameters tested are shown in a separate document.

TYPE 6 DETECTION PROBABILITY

Data Sheet for FCC Hopping Radar Type 6				
1 us Pulse Width, 333 us PRI, 9 Pulses per Burst, 1 Burst per Hop				
NTIA August 2005 Hopping Sequence				
Trial	Starting Index Within Sequence	Signal Generator Frequency (MHz)	Hops within Detection BW	Successful Detection (Yes/No)
1	645	5490	20	Yes
2	1120	5491	19	Yes
3	1595	5492	15	Yes
4	2070	5493	12	Yes
5	2545	5494	17	Yes
6	3020	5495	18	Yes
7	3495	5496	19	Yes
8	3970	5497	18	Yes
9	4445	5498	11	Yes
10	4920	5499	21	Yes
11	5395	5500	13	Yes
12	5870	5501	15	Yes
13	6345	5502	14	Yes
14	6820	5503	16	Yes
15	7295	5504	19	Yes
16	7770	5505	18	Yes
17	8245	5506	23	Yes
18	8720	5507	14	Yes
19	9195	5508	19	Yes
20	9670	5509	27	Yes
21	10145	5510	18	Yes
22	10620	5511	12	Yes
23	11095	5512	14	Yes
24	11570	5513	20	Yes
25	12045	5514	16	Yes
26	12520	5515	14	Yes
27	12995	5516	18	Yes
28	13470	5517	22	Yes
29	13945	5518	18	Yes
30	14420	5519	8	Yes
31	14895	5520	22	Yes
32	15370	5521	21	Yes
33	15845	5522	18	Yes
34	16320	5523	14	Yes
35	16795	5524	20	Yes
36	17270	5525	14	Yes
37	17745	5526	17	Yes
38	18220	5527	20	Yes
39	18695	5528	17	Yes

TYPE 6 DETECTION PROBABILITY (CONTINUED)

40	19170	5529	14	Yes
41	19645	5530	20	Yes
42	20120	5531	16	Yes
43	20595	5532	23	Yes
44	21070	5533	14	Yes
45	21545	5534	9	Yes
46	22020	5535	14	Yes
47	22495	5536	14	Yes
48	22970	5537	20	Yes
49	23445	5538	15	Yes
50	23920	5539	15	Yes
51	24395	5540	16	Yes
52	24870	5541	15	Yes
53	25345	5542	18	Yes
54	25820	5543	13	Yes
55	26295	5544	20	Yes
56	26770	5545	16	Yes
57	27245	5546	21	Yes
58	27720	5547	11	Yes
59	28195	5548	11	Yes
60	28670	5549	19	Yes
61	29145	5550	18	Yes
62	29620	5551	20	Yes
63	30095	5552	17	Yes
64	30570	5553	18	Yes
65	31045	5554	19	Yes
66	31520	5555	19	Yes
67	31995	5556	18	Yes
68	32470	5557	12	Yes
69	32945	5558	16	Yes
70	33420	5559	17	Yes
71	33895	5560	8	Yes
72	34370	5561	18	Yes
73	34845	5562	17	Yes
74	35320	5563	14	Yes
75	35795	5564	17	Yes
76	36270	5565	13	Yes
77	36745	5566	19	Yes
78	37220	5567	17	Yes
79	37695	5568	13	Yes
80	38170	5569	14	Yes
81	38645	5570	12	Yes

7.6. BRIDGE MODE RESULTS

Per KDB 905462 D02, Section 5.1 (footnote 2):

Networks Access Points with Bridge and/or MESH modes of operation are permitted to operate in the DFS bands but must employ a DFS function. The functionality of the Bridge mode as specified in §15.403(a) must be validated in the DFS test report. Devices operating as relays where they act as master and client must also employ DFS function for the master. The method used to validate the functionality must be documented and validation data must be documented. Bridge mode can be validated by performing a test statistical performance check (Section 7.8.4) on any one of the radar types. This is an abbreviated test to verify DFS functionality. MESH mode operational methodology must be submitted in the application for certification for evaluation by the FCC.

This device does not support Bridge Mode therefore this test was not performed.