



FCC Test Report

Equipment : cnPilot e502S Outdoor
Brand Name : Cambium Networks
Model No. : cnPilot e502S Outdoor
FCC ID : Z8H89FT0037
Standard : 47 CFR FCC Part 15.247
Operating Band : 2400 MHz – 2483.5 MHz
Function : Point-to-multipoint; Point-to-point
Applicant / Manufacturer : Cambium Networks Inc.
3800 Golf Road, Suite 360 Rolling Meadows, IL
60008, USA

The product sample received on Aug. 16, 2017 and completely tested on Aug. 23, 2017. We, SPORTON, would like to declare that the tested sample has been evaluated in accordance with the procedures given in ANSI C63.10-2013 and shown compliance with the applicable technical standards.

The test results in this report apply exclusively to the tested model / sample. Without written approval of SPORTON INTERNATIONAL INC., the test report shall not be reproduced except in full.

Phoenix Chen
SPORTON INTERNATIONAL INC.





Table of Contents

1	GENERAL DESCRIPTION	5
1.1	Information.....	5
1.2	Testing Applied Standards	7
1.3	Testing Location Information	7
1.4	Measurement Uncertainty	7
2	TEST CONFIGURATION OF EUT.....	8
2.1	Test Condition	8
2.2	Test Channel Mode	8
2.3	The Worst Case Measurement Configuration.....	9
2.4	Support Equipment.....	10
2.5	Test Setup Diagram	11
3	TRANSMITTER TEST RESULT	13
3.1	AC Power-line Conducted Emissions	13
3.2	DTS Bandwidth.....	14
3.3	Maximum Conducted Output Power	15
3.4	Power Spectral Density	17
3.5	Emissions in Non-restricted Frequency Bands	18
3.6	Emissions in Restricted Frequency Bands.....	19
4	TEST EQUIPMENT AND CALIBRATION DATA	23
APPENDIX A. TEST RESULTS OF AC POWER-LINE CONDUCTED EMISSIONS		
APPENDIX B. TEST RESULTS OF DTS BANDWIDTH		
APPENDIX C. TEST RESULTS OF MAXIMUM CONDUCTED OUTPUT POWER		
APPENDIX D. TEST RESULTS OF POWER SPECTRAL DENSITY		
APPENDIX E. TEST RESULTS OF EMISSIONS IN NON-RESTRICTED FREQUENCY BANDS		
APPENDIX F. TEST RESULTS OF EMISSIONS IN RESTRICTED FREQUENCY BANDS		
APPENDIX G. TEST PHOTOS		
PHOTOGRAPHS OF EUT V01		



Summary of Test Result

Conformance Test Specifications				
Report Clause	Ref. Std. Clause	Description	Limit	Result
1.1.2	15.203	Antenna Requirement	FCC 15.203	Complied
3.1	15.207	AC Power-line Conducted Emissions	FCC 15.207	Complied
3.2	15.247(a)	DTS Bandwidth	≥500kHz	Complied
3.3	15.247(b)	Maximum Conducted Output Power	Power [dBm]:30	Complied
3.4	15.247(e)	Power Spectral Density	PSD [dBm/3kHz]:8	Complied
3.5	15.247(d)	Emissions in Non-restricted Frequency Bands	Non-Restricted Bands: > 30 dBc	Complied
3.6	15.247(d)	Emissions in Restricted Frequency Bands	Restricted Bands: FCC 15.209	Complied



1 General Description

1.1 Information

1.1.1 RF General Information

Frequency Range (MHz)	IEEE Std. 802.11	Ch. Frequency (MHz)	Channel Number
2400-2483.5	b, g, n (HT20)	2412-2462	1-11 [11]
2400-2483.5	n (HT40)	2422-2452	3-9 [7]

Band	Mode	BWch (MHz)	Nant
2.4-2.4835GHz	802.11b	20	2TX
2.4-2.4835GHz	802.11g	20	2TX
2.4-2.4835GHz	802.11n HT20	20	2TX
2.4-2.4835GHz	802.11n HT40	40	2TX

Note:

- ♦ 11b mode uses a combination of DSSS-DBPSK, DQPSK, CCK modulation.
- ♦ 11g, HT20 and HT40 use a combination of OFDM-BPSK, QPSK, 16QAM, 64QAM modulation.
- ♦ BWch is the nominal channel bandwidth.

1.1.2 Antenna Information

Ant.	Port	Brand	P/N	Antenna Type	Connector	Gain (dBi)
1	1	Cambium	A005378	Sector antenna	I-PEX	12.8
2	2	Cambium	A005378	Sector antenna	I-PEX	12.5

Note 1: 802.11b/g/n used two antennas are for signal transmitting and receiving.(2T2R Spatial Multiplexing MIMO configuration)



1.1.3 EUT Information

Operational Condition	
EUT Power Type	From POE
Beamforming Function	<input type="checkbox"/> With beamforming <input checked="" type="checkbox"/> Without beamforming
Type of EUT	
<input checked="" type="checkbox"/>	Stand-alone
<input type="checkbox"/>	Combined (EUT where the radio part is fully integrated within another device)
	Combined Equipment - Brand Name / Model No.: ...
<input type="checkbox"/>	Plug-in radio (EUT intended for a variety of host systems)
	Host System - Brand Name / Model No.: ...
<input type="checkbox"/>	Other:

1.1.4 Mode Test Duty Cycle

Mode	DC	DCF(dB)	T(s)	VBW(Hz) ≥ 1/T
802.11b	0.996	0.017	n/a (DC>=0.98)	n/a (DC>=0.98)
802.11g	0.977	0.101	2.027m	1k
802.11n HT20	0.975	0.11	1.891m	1k
802.11n HT40	0.942	0.259	929.688u	3k

1.2 Testing Applied Standards

According to the specifications of the manufacturer, the EUT must comply with the requirements of the following standards:

- ◆ 47 CFR FCC Part 15
- ◆ ANSI C63.10-2013
- ◆ KDB 558074 D01 v04
- ◆ KDB 662911 D01 v02r01

1.3 Testing Location Information

Testing Location		
<input checked="" type="checkbox"/>	HWA YA	ADD : No. 52, Huaya 1st Rd., Guishan Dist., Taoyuan City, Taiwan (R.O.C.) TEL : 886-3-327-3456 FAX : 886-3-327-0973
Test site Designation No. TW1190 with FCC.		
<input type="checkbox"/>	JHUBEI	ADD : No.8, Ln. 724, Bo'ai St., Zhubei City, Hsinchu County, Taiwan (R.O.C.) TEL : 886-3-656-9065 FAX : 886-3-656-9085
Test site Designation No. TW0006 with FCC.		

Test Condition	Test Site No.	Test Engineer	Test Environment	Test Date
RF Conducted	TH07-HY	Ryan	24.5°C / 65%	23/Aug/2017
Radiated	03CH09-HY	Jerry	26.5°C / 45%	21/Aug/2017
AC Conduction	CO04-HY	Bear	22°C / 56%	21/Aug/2017

1.4 Measurement Uncertainty

ISO/IEC 17025 requires that an estimate of the measurement uncertainties associated with the emissions test results be included in the report. The measurement uncertainties given below are based on a 95% confidence level (based on a coverage factor (k=2))

Test Items	Uncertainty	Remark
Conducted Emission (150kHz ~ 30MHz)	3.6 dB	Confidence levels of 95%
Radiated Emission (30MHz ~ 1,000MHz)	2.1 dB	Confidence levels of 95%
Radiated Emission (1GHz ~ 18GHz)	2.6 dB	Confidence levels of 95%
Radiated Emission (18GHz ~ 40GHz)	2.9 dB	Confidence levels of 95%
Conducted Emission	1.3 dB	Confidence levels of 95%



2 Test Configuration of EUT

2.1 Test Condition

RF Conducted	Abbreviation	Remark
TnomVnom	Tnom	20°C
-	Vnom	120V

2.2 Test Channel Mode

Test Software	ART2
---------------	------

Mode	Power Setting
802.11b_Nss1,(1Mbps)_2TX	-
2412MHz	20.5
2437MHz	20.5
2462MHz	20.5
802.11g_Nss1,(6Mbps)_2TX	-
2412MHz	19
2437MHz	21.5
2462MHz	21.5
802.11n HT20_Nss1,(MCS0)_2TX	-
2412MHz	18.5
2437MHz	21.5
2462MHz	20
802.11n HT40_Nss1,(MCS0)_2TX	-
2422MHz	14
2437MHz	19
2452MHz	16

2.3 The Worst Case Measurement Configuration

The Worst Case Mode for Following Conformance Tests	
Tests Item	AC power-line conducted emissions
Condition	AC power-line conducted measurement for line and neutral
Operating Mode	Normal Link
1	PoE Mode

The Worst Case Mode for Following Conformance Tests	
Tests Item	DTS Bandwidth Maximum Conducted Output Power Power Spectral Density Emissions in Non-restricted Frequency Bands
Test Condition	Conducted measurement at transmit chains

The Worst Case Mode for Following Conformance Tests	
Tests Item	Emissions in Restricted Frequency Bands
Test Condition	Radiated measurement If EUT consist of multiple antenna assembly (multiple antenna are used in EUT regardless of spatial multiplexing MIMO configuration), the radiated test should be performed with highest antenna gain of each antenna type.
Operating Mode	CTX
1	PoE Mode
Orthogonal Planes of EUT	Y Plane 
	V
Worst Planes of EUT	

The Worst Case Mode for Following Conformance Tests	
Tests Item	Simultaneous Transmission Analysis
Operating Mode	CTX
1	WLAN 2.4GHz+WLAN 5GHz
Refer to Sporton Test Report No.: FA781425 for Co-location RF Exposure Evaluation.	



2.4 Support Equipment

Support Equipment – RF Conducted				
No.	Equipment	Brand Name	Model Name	FCC ID
1	Notebook	DELL	E5410	DoC
2	Adapter for NB	DELL	HA65NM130	DoC
3	AC Source	G.W	APS-9102	-

Support Equipment – Radiated Emission				
No.	Equipment	Brand Name	Model Name	FCC ID
1	PoE	Cambium Networks	NET-P30-56IN	-

Note. Support equipment No.1 was provided by customer.

Support Equipment – AC Conduction				
No.	Equipment	Brand Name	Model Name	FCC ID
A	PoE	Cambium Networks	NET-P30-56IN	-
Z	Notebook	DELL	Latitude E5430	DoC
Z	Terminal (Client Provided)	TUV	MRLBB-1302	-
Z	Notebook	DELL	P55G	DoC
Z	Notebook	DELL	P55G	DoC

Note. Support equipment No.A was provided by customer.

2.5 Test Setup Diagram

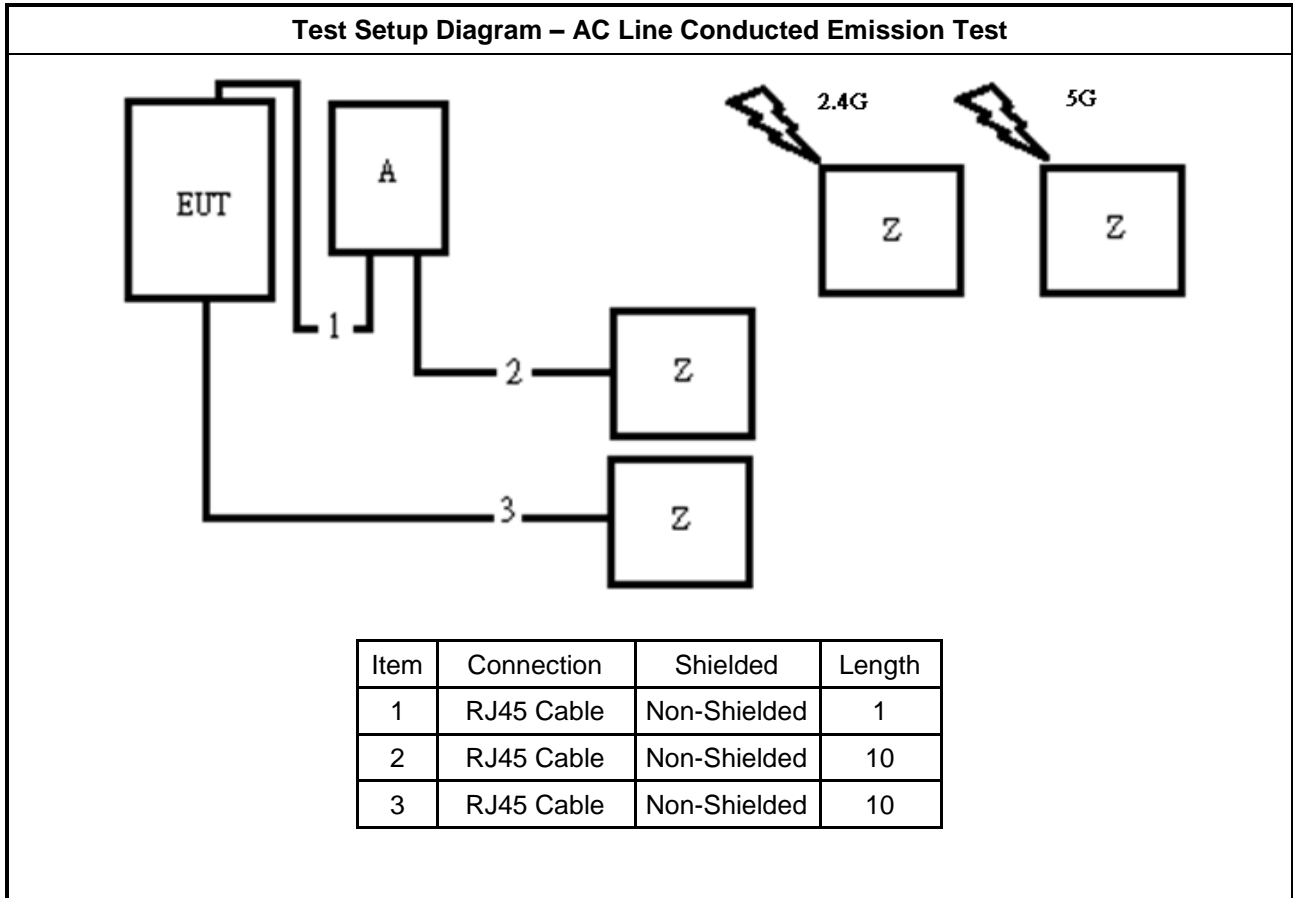

Test Setup Diagram - Radiated Test

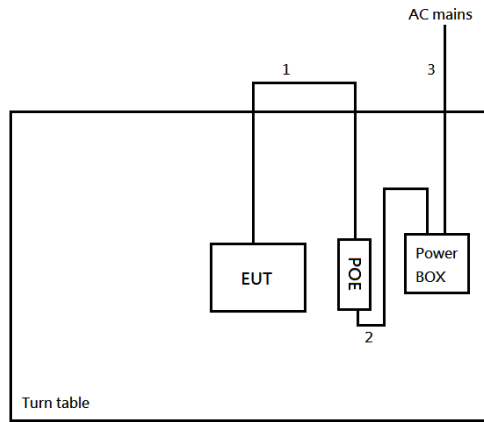

Item	Connection	Shielded	Length
1	RJ45 cable	No	3m
2	AC Power line	No	0.8m
3	AC Power line	No	1.8m

3 Transmitter Test Result

3.1 AC Power-line Conducted Emissions

3.1.1 AC Power-line Conducted Emissions Limit

AC Power-line Conducted Emissions Limit		
Frequency Emission (MHz)	Quasi-Peak	Average
0.15-0.5	66 - 56 *	56 - 46 *
0.5-5	56	46
5-30	60	50

Note 1: * Decreases with the logarithm of the frequency.

3.1.2 Measuring Instruments

Refer a test equipment and calibration data table in this test report.

3.1.3 Test Procedures

Test Method
<input checked="" type="checkbox"/> Refer as ANSI C63.10-2013, clause 6.2 for AC power-line conducted emissions.

3.1.4 Test Setup

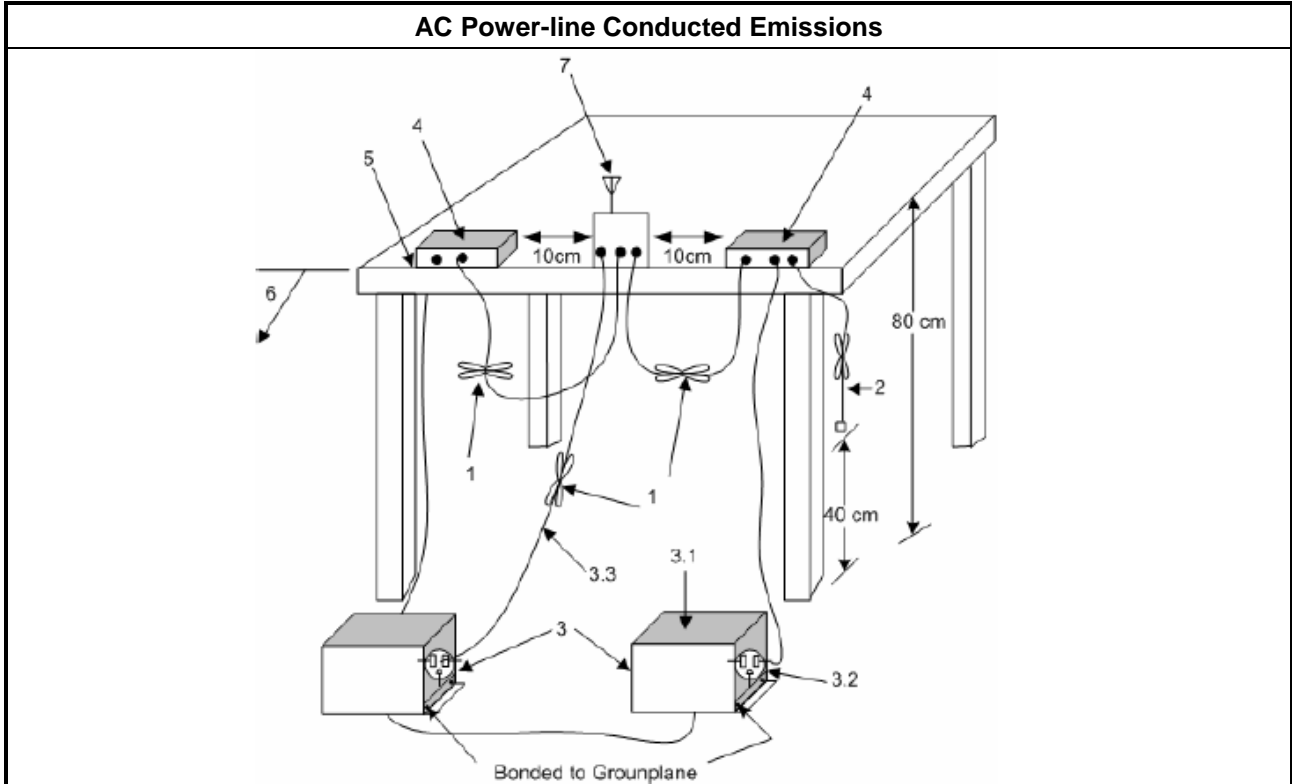

3.1.5 Test Result of AC Power-line Conducted Emissions

Refer as Appendix A

3.2 DTS Bandwidth

3.2.1 6dB Bandwidth Limit

6dB Bandwidth Limit
Systems using digital modulation techniques:
<ul style="list-style-type: none"> ▪ 6 dB bandwidth \geq 500 kHz.

3.2.2 Measuring Instruments

Refer a test equipment and calibration data table in this test report.

3.2.3 Test Procedures

Test Method	
<ul style="list-style-type: none"> ▪ For the emission bandwidth shall be measured using one of the options below: 	
<input checked="" type="checkbox"/>	Refer as KDB 558074, clause 8.1 Option 1 for 6 dB bandwidth measurement.
<input type="checkbox"/>	Refer as KDB 558074, clause 8.2 Option 2 for 6 dB bandwidth measurement.
<input type="checkbox"/>	Refer as RSS-Gen, clause 6.6 for for occupied bandwidth testing.
<input type="checkbox"/>	Refer as ANSI C63.10, clause 6.9.3 for occupied bandwidth testing.

3.2.4 Test Setup

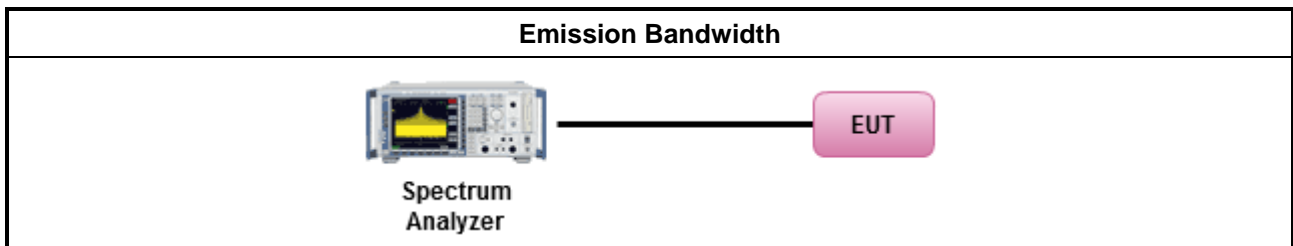

3.2.5 Test Result of Emission Bandwidth

Refer as Appendix B

3.3 Maximum Conducted Output Power

3.3.1 Maximum Conducted Output Power Limit

Maximum Conducted Output Power Limit	
	<ul style="list-style-type: none"> ▪ If $G_{TX} \leq 6$ dBi, then $P_{Out} \leq 30$ dBm (1 W)
	<ul style="list-style-type: none"> ▪ Point-to-multipoint systems (P2M): If $G_{TX} > 6$ dBi, then $P_{Out} = 30 - (G_{TX} - 6)$ dBm
	<ul style="list-style-type: none"> ▪ Point-to-point systems (P2P): If $G_{TX} > 6$ dBi, then $P_{Out} = 30 - (G_{TX} - 6)/3$ dBm
	<ul style="list-style-type: none"> ▪ Smart antenna system (SAS):
	<ul style="list-style-type: none"> - Single beam: If $G_{TX} > 6$ dBi, then $P_{Out} = 30 - (G_{TX} - 6)/3$ dBm
	<ul style="list-style-type: none"> - Overlap beam: If $G_{TX} > 6$ dBi, then $P_{Out} = 30 - (G_{TX} - 6)/3$ dBm
	<ul style="list-style-type: none"> - Aggregate power on all beams: If $G_{TX} > 6$ dBi, then $P_{Out} = 30 - (G_{TX} - 6)/3 + 8$ dBm
e.i.r.p. Power Limit:	
	<ul style="list-style-type: none"> ▪ 2400-2483.5 MHz Band
	<ul style="list-style-type: none"> ▪ Point-to-multipoint systems (P2M): $P_{eirp} \leq 36$ dBm (4 W)
	<ul style="list-style-type: none"> ▪ Point-to-point systems (P2P): $P_{eirp} \leq \text{MAX}(36, [P_{Out} + G_{TX}])$ dBm
	<ul style="list-style-type: none"> ▪ Smart antenna system (SAS)
	<ul style="list-style-type: none"> - Single beam: $P_{eirp} \leq \text{MAX}(36, P_{Out} + G_{TX})$ dBm
	<ul style="list-style-type: none"> - Overlap beam: $P_{eirp} \leq \text{MAX}(36, P_{Out} + G_{TX})$ dBm
	<ul style="list-style-type: none"> - Aggregate power on all beams: $P_{eirp} \leq \text{MAX}(36, [P_{Out} + G_{TX} + 8])$ dBm
<p>P_{Out} = maximum peak conducted output power or maximum conducted output power in dBm, G_{TX} = the maximum transmitting antenna directional gain in dBi.</p>	

3.3.2 Measuring Instruments

Refer a test equipment and calibration data table in this test report.

3.3.3 Test Procedures

Test Method	
<ul style="list-style-type: none"> ▪ Maximum Peak Conducted Output Power 	
<input type="checkbox"/>	Refer as KDB 558074, clause 9.1.1 Option 1 (RBW ≥ EBW method).
<input type="checkbox"/>	Refer as KDB 558074, clause 9.1.2 Option 2 (integrated band power method)
<input type="checkbox"/>	Refer as KDB 558074, clause 9.1.3 Option 3 (peak power meter for VBW ≥ DTS BW)
<ul style="list-style-type: none"> ▪ Maximum Average Conducted Output Power 	
Duty cycle ≥ 98%	
<input type="checkbox"/>	Refer as KDB 558074, clause 9.2.2.4 Method AVGSA-2 (spectral trace averaging).
Duty cycle < 98%	
<input type="checkbox"/>	Refer as KDB 558074, clause 9.2.2.5 Method AVGSA-2 Alt. (slow sweep speed)
RF power meter and average over on/off periods with duty factor or gated trigger	
<input checked="" type="checkbox"/>	Refer as KDB 558074, clause 9.2.3.1 Method AVGPM (using an RF average power meter).
<ul style="list-style-type: none"> ▪ For conducted measurement. 	
<ul style="list-style-type: none"> ▪ If the EUT supports multiple transmit chains using options given below: Refer as KDB 662911, In-band power measurements. Using the measure-and-sum approach, measured all transmit ports individually. Sum the power (in linear power units e.g., mW) of all ports for each individual sample and save them. 	
<ul style="list-style-type: none"> ▪ If multiple transmit chains, EIRP calculation could be following as methods: $P_{total} = P_1 + P_2 + \dots + P_n$ (calculated in linear unit [mW] and transfer to log unit [dBm]) $EIRP_{total} = P_{total} + DG$ 	

3.3.4 Test Setup

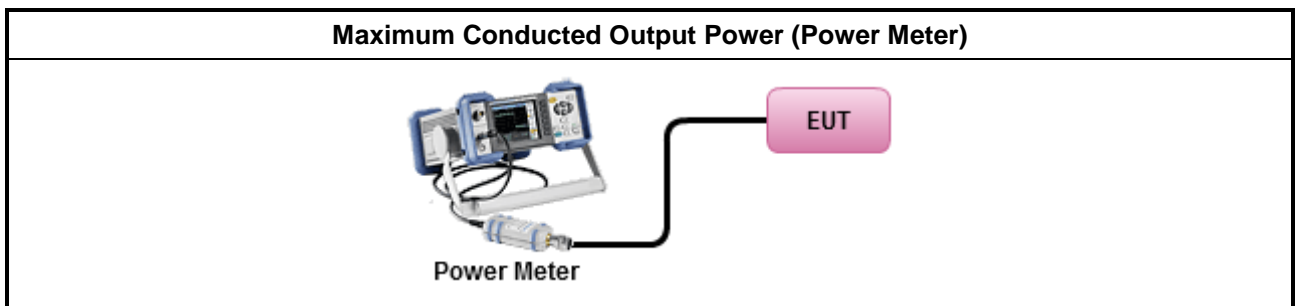

3.3.5 Test Result of Maximum Conducted Output Power

Refer as Appendix C

3.4 Power Spectral Density

3.4.1 Power Spectral Density Limit

Power Spectral Density Limit
<ul style="list-style-type: none"> Power Spectral Density (PSD) \leq 8 dBm/3kHz

3.4.2 Measuring Instruments

Refer a test equipment and calibration data table in this test report.

3.4.3 Test Procedures

Test Method
<ul style="list-style-type: none"> Peak power spectral density procedures that the same method as used to determine the conducted output power. If maximum peak conducted output power was measured to demonstrate compliance to the output power limit, then the peak PSD procedure below (Method PKPSD) shall be used. If maximum conducted output power was measured to demonstrate compliance to the output power limit, then one of the average PSD procedures shall be used, as applicable based on the following criteria (the peak PSD procedure is also an acceptable option).
<input checked="" type="checkbox"/> Refer as KDB 558074, clause 10.2 Method PKPSD (RBW=3-100kHz; Detector=peak).
<ul style="list-style-type: none"> For conducted measurement.
<ul style="list-style-type: none"> If The EUT supports multiple transmit chains using options given below: <ul style="list-style-type: none"> Measure and sum the spectra across the outputs. Refer as KDB 662911, In-band power spectral density (PSD). Sample all transmit ports simultaneously using a spectrum analyzer for each transmit port. Where the trace bin-by-bin of each transmit port summing can be performed. (i.e., in the first spectral bin of output 1 is summed with that in the first spectral bin of output 2 and that from the first spectral bin of output 3, and so on up to the NTX output to obtain the value for the first frequency bin of the summed spectrum.). Add up the amplitude (power) values for the different transmit chains and use this as the new data trace.

3.4.4 Test Setup

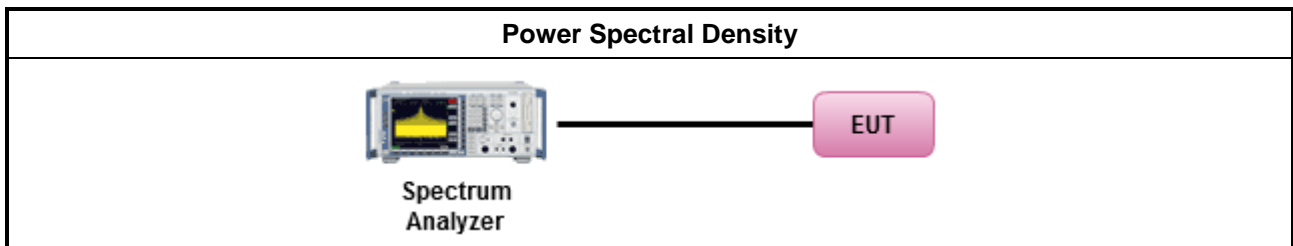

3.4.5 Test Result of Power Spectral Density

Refer as Appendix D

3.5 Emissions in Non-restricted Frequency Bands

3.5.1 Emissions in Non-restricted Frequency Bands Limit

Un-restricted Band Emissions Limit	
RF output power procedure	Limit (dB)
Peak output power procedure	20
Average output power procedure	30

Note 1: If the peak output power procedure is used to measure the fundamental emission power to demonstrate compliance to requirements, then the peak conducted output power measured within any 100 kHz outside the authorized frequency band shall be attenuated by at least 20 dB relative to the maximum measured in-band peak PSD level.

Note 2: If the average output power procedure is used to measure the fundamental emission power to demonstrate compliance to requirements, then the power in any 100 kHz outside of the authorized frequency band shall be attenuated by at least 30 dB relative to the maximum measured in-band average PSD level.

3.5.2 Measuring Instruments

Refer a test equipment and calibration data table in this test report.

3.5.3 Test Procedures

Test Method
<ul style="list-style-type: none"> Refer as KDB 558074, clause 11 for unwanted emissions into non-restricted bands.

3.5.4 Test Setup

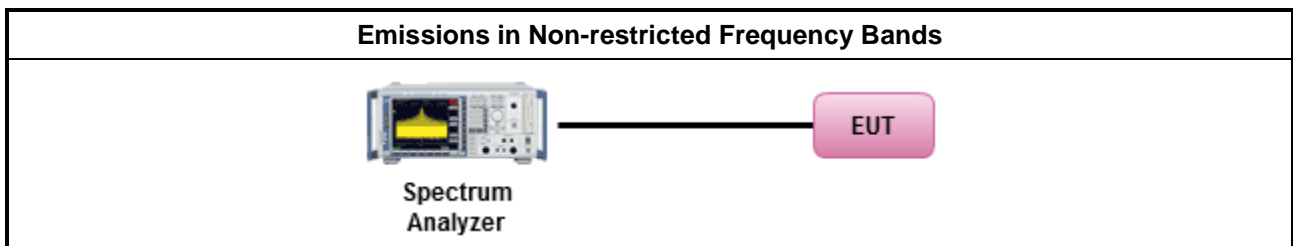

3.5.5 Test Result of Emissions in Non-restricted Frequency Bands

Refer as Appendix E



3.6 Emissions in Restricted Frequency Bands

3.6.1 Emissions in Restricted Frequency Bands Limit

Restricted Band Emissions Limit			
Frequency Range (MHz)	Field Strength (uV/m)	Field Strength (dBuV/m)	Measure Distance (m)
0.009~0.490	2400/F(kHz)	48.5 - 13.8	300
0.490~1.705	24000/F(kHz)	33.8 - 23	30
1.705~30.0	30	29	30
30~88	100	40	3
88~216	150	43.5	3
216~960	200	46	3
Above 960	500	54	3

Note 1: Test distance for frequencies at or above 30 MHz, measurements may be performed at a distance other than the limit distance provided they are not performed in the near field and the emissions to be measured can be detected by the measurement equipment. When performing measurements at a distance other than that specified, the results shall be extrapolated to the specified distance using an extrapolation factor of 20 dB/decade (inverse of linear distance for field-strength measurements, inverse of linear distance-squared for power-density measurements).

Note 2: Test distance for frequencies at below 30 MHz, measurements may be performed at a distance closer than the EUT limit distance; however, an attempt should be made to avoid making measurements in the near field. When performing measurements below 30 MHz at a closer distance than the limit distance, the results shall be extrapolated to the specified distance by either making measurements at a minimum of two or more distances on at least one radial to determine the proper extrapolation factor or by using the square of an inverse linear distance extrapolation factor (40 dB/decade). The test report shall specify the extrapolation method used to determine compliance of the EUT.

3.6.2 Measuring Instruments

Refer a test equipment and calibration data table in this test report.



3.6.3 Test Procedures

Test Method	
<ul style="list-style-type: none"> ▪ The average emission levels shall be measured in [duty cycle \geq 98 or duty factor]. 	
<ul style="list-style-type: none"> ▪ Refer as ANSI C63.10, clause 6.10.3 band-edge testing shall be performed at the lowest frequency channel and highest frequency channel within the allowed operating band. 	
<ul style="list-style-type: none"> ▪ For the transmitter unwanted emissions shall be measured using following options below: 	
<ul style="list-style-type: none"> ▪ Refer as KDB 558074, clause 12 for unwanted emissions into restricted bands. 	
	<ul style="list-style-type: none"> <input checked="" type="checkbox"/> Refer as KDB 558074, clause 12.2.5.3 (ANSI C63.10, clause 4.1.4.2.3), Reduced VBW\geq1/T.
	<ul style="list-style-type: none"> <input checked="" type="checkbox"/> Refer as KDB 558074, clause 12.2.4 measurement procedure peak limit.
<ul style="list-style-type: none"> ▪ For the transmitter band-edge emissions shall be measured using following options below: 	
	<ul style="list-style-type: none"> ▪ Refer as KDB 558074 clause 13.1, When the performing peak or average radiated measurements, emissions within 2 MHz of the authorized band edge may be measured using the marker-delta method described below.
	<ul style="list-style-type: none"> ▪ Refer as KDB 558074, clause 13.2 (ANSI C63.10, clause 6.10.6) for marker-delta method for band-edge measurements.
	<ul style="list-style-type: none"> ▪ Refer as KDB 558074, clause 13.3 for narrower resolution bandwidth (100kHz) using the band power and summing the spectral levels (i.e., 1 MHz).
<ul style="list-style-type: none"> ▪ For conducted and cabinet radiation measurement, refer as KDB 558074, clause 12.2.2. 	
	<ul style="list-style-type: none"> ▪ For conducted unwanted emissions into restricted bands (absolute emission limits). Devices with multiple transmit chains using options given below: (1) Measure and sum the spectra across the outputs or (2) Measure and add 10 log(N) dB
	<ul style="list-style-type: none"> ▪ For KDB 662911 The methodology described here may overestimate array gain, thereby resulting in apparent failures to satisfy the out-of-band limits even if the device is actually compliant. In such cases, compliance may be demonstrated by performing radiated tests around the frequencies at which the apparent failures occurred.

3.6.4 Test Setup

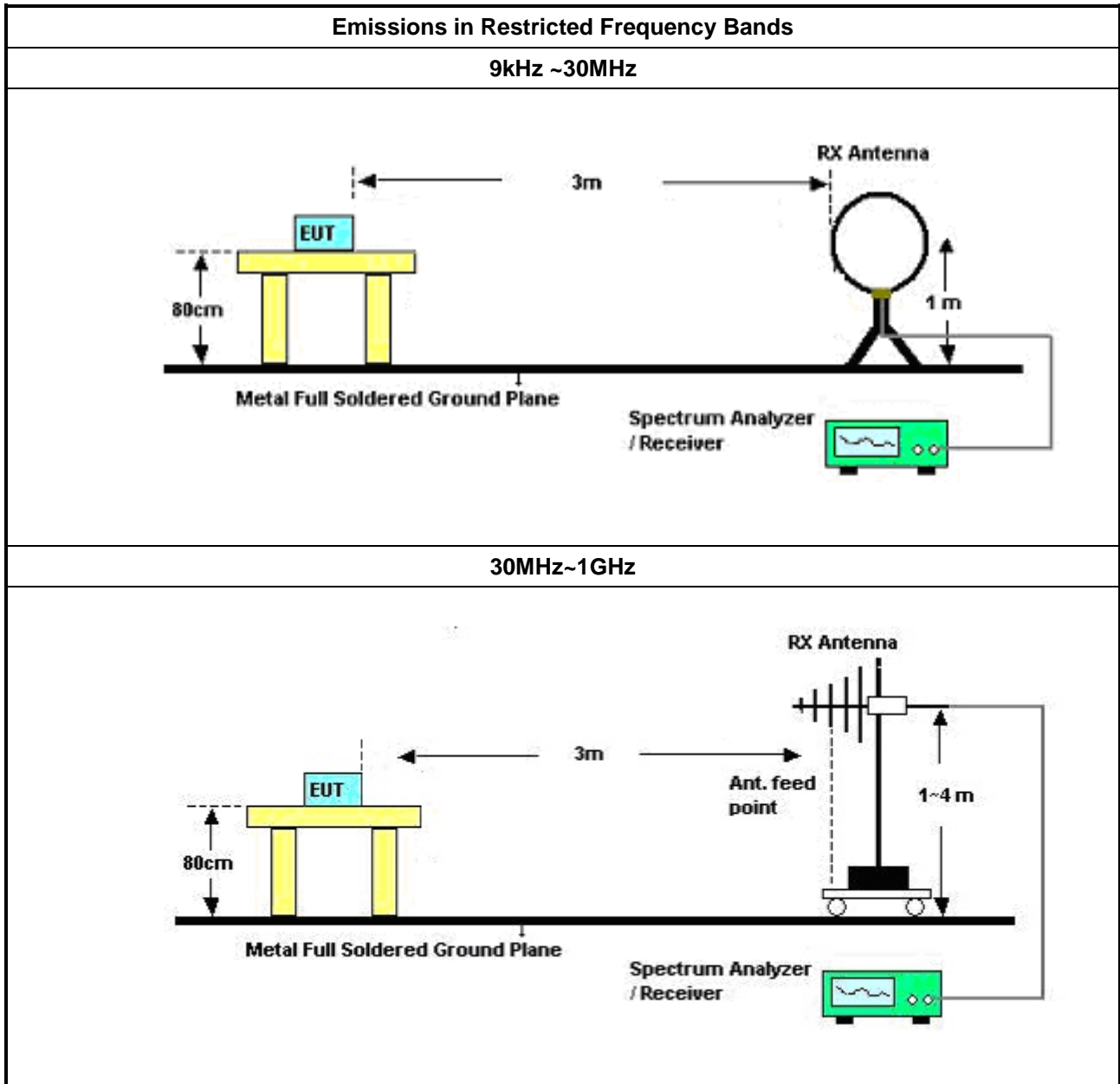

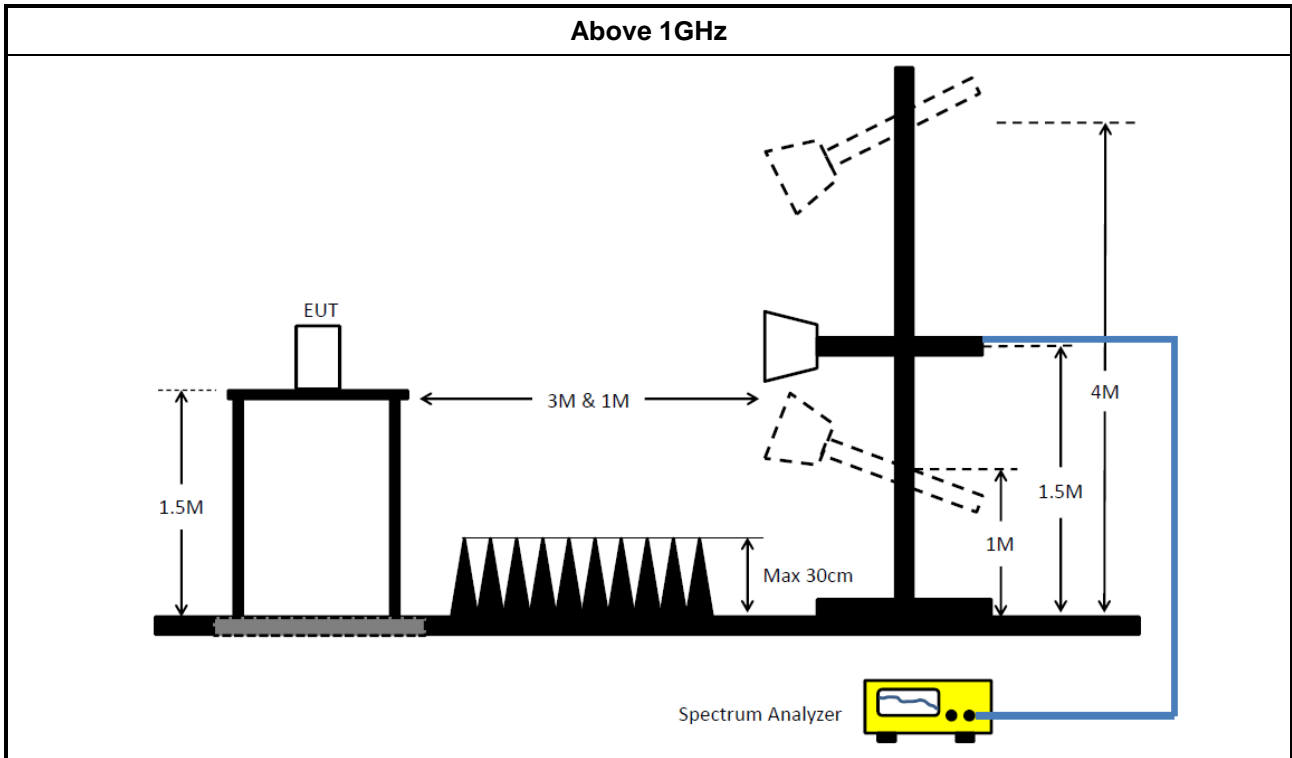

3.6.5 Test Result of Emissions in Restricted Frequency Bands (Below 30MHz)

The amplitude of spurious emissions which are attenuated by more than 20dB below the permissible value has no need to be reported. All amplitude of spurious emissions that are attenuated by more than 20 dB below the permissible value has no need to be reported.

3.6.6 Test Result of Emissions in Restricted Frequency Bands

Refer as Appendix F



4 Test Equipment and Calibration Data

Instrument for AC Conduction

Instrument	Manufacturer	Model No.	Serial No.	Spec.	Calibration Date	Calibration Due Date
EMC Receiver	R&S	ESR3	102051	9KHz ~ 3.6GHz	29/Apr/2017	28/Apr/2018
LISN	R&S	ENV216	101295	9kHz ~ 30MHz	15/Nov/2016	14/Nov/2017
RF Cable-CON	HUBER+SUHNER	RG213/U	0761183202000 1	9kHz ~ 30MHz	24/Oct/2016	23/Oct/2017
Impedance Stabilization Network	TESEQ	ISN T800	30330	9kHz ~ 30MHz	13/Apr/2017	12/Apr/2018
Impuls Begrenzer Pulse Limiter	R&S	ESH3-Z2	100921	10 kHz ~ 30 MHz	20/Oct/2016	21/Oct/2017

NCR : Non-Calibration Require

Instrument for Radiated Test

Instrument	Manufacturer	Model No.	Serial No.	Spec.	Calibration Date	Calibration Due Date
Spectrum Analyzer	R&S	FSP40	100593	9KHz - 40GHz	26/Oct/2016	25/Oct/2017
3m Semi Anechoic	SIDT FRANKONIA	SAC-3M	03CH02-HY	30MHz-1GHz	21/Oct/2016	20/Oct/2017
3m Semi Anechoic	SIDT FRANKONIA	SAC-3M	03CH02-HY	1GHz ~ 18GHz	12/Dec/2016	11/Dec/2017
Amplifier	Agilent	8447D	2944A11149	100KHz-1.3GHz	29/Jun/2017	28/Jun/2018
Amplifier	Agilent	8449B	3008A02373	1GHz-26.5GHz	02/Sep/2016	01/Sep/2017
Horn Antenna	SCHWARZBECK	BBHA9120D	BBHA9120D 01531	1GHz-18GHz	11/May/2017	10/May/2018
Horn Antenna	SCHWARZBECK	BBHA9170	BBHA9170154	18GHz-40GHz	06/Feb/2017	05/Feb/2018
Bilog Antenna	SCHAFFNER	CBL6112B	2723	30MHz-1GHz	01/Oct/2016	30/Sep/2017
Microwave Preamplifier with 6dB Attenuator	EMC INSTRUMENTS	EMC184045B & PE7005-	1840917	18GHz-40GHz	24/Aug/2016	23/Aug/2017
Loop Antenna	TESEQ	HLA 6120	31244	9KHz-30MHz	02/Mar/2017	01/Mar/2018
RF Cable-high	SUHNER	SUCOFLEX104	MY34918/4	1GHz ~ 40GHz	26/Jan/2017	25/Jan/2018
RF Cable-R03m	Jye Bao	RG142	CB017	9kHz ~ 1GHz	26/Jan/2017	25/Jan/2018
Receiver	R&S	ESU-26	100422/026	20Hz ~ 26.5GHz	21/Sep/2016	20/Sep/2017

Instrument for Conducted Test

Instrument	Manufacturer	Model No.	Serial No.	Spec.	Calibration Date	Calibration Due Date
Spectrum Analyzer	R&S	FSV 40	101500	9kHz-40GHz	28/Jun/2017	27/Jun/2018
Power Sensor	Anritsu	MA2411B	1027452	300MHz ~ 40GHz	27/Oct/2016	26/Oct/2017
Power Meter	Anritsu	ML2495A	1124009	300MHz ~ 40GHz	27/Oct/2016	26/Oct/2017
Signal Generator	R&S	SMR40	100116	10MHz ~ 40GHz	27/Jul/2017	26/Jul/2018



Instrument	Manufacturer	Model No.	Serial No.	Spec.	Calibration Date	Calibration Due Date
RF Cable-0.2m	HUBER+SUHN ER	SUCOFLEX_10 4	MY10709/4	30MHz ~ 26.5GHz	02/Oct/2016	01/Oct/2017
RF Cable-0.2m	HUBER+SUHN ER	SUCOFLEX_10 4	MY10710/4	30MHz ~ 26.5GHz	02/Oct/2016	01/Oct/2017
RF Cable-0.5m	HUBER+SUHN ER	SUCOFLEX_10 4	MY10713/4	30MHz ~ 26.5GHz	02/Oct/2016	01/Oct/2017



AC Power-line Conducted Emissions Result																																																																																																																																	
Operating Mode	1	Power Phase	Neutral																																																																																																																														
Operating Function	PoE mode																																																																																																																																
<div style="display: flex; justify-content: space-between;"> <div> </div> <div style="text-align: right;">Date: 2017-08-21</div> </div>																																																																																																																																	
<table border="1" style="width: 100%; border-collapse: collapse;"> <thead> <tr> <th></th> <th>Freq</th> <th>Level</th> <th>Over Limit</th> <th>Limit Line</th> <th>Read Level</th> <th>LISN Factor</th> <th>Cable Loss</th> <th>Remark</th> </tr> <tr> <th></th> <th>MHz</th> <th>dBuV</th> <th>dB</th> <th>dBuV</th> <th>dBuV</th> <th>dB</th> <th>dB</th> <th></th> </tr> </thead> <tbody> <tr><td>1</td><td>0.15</td><td>41.13</td><td>-14.87</td><td>56.00</td><td>31.31</td><td>9.60</td><td>0.22</td><td>Average</td></tr> <tr><td>2</td><td>0.15</td><td>54.40</td><td>-11.60</td><td>66.00</td><td>44.58</td><td>9.60</td><td>0.22</td><td>QP</td></tr> <tr><td>3</td><td>0.20</td><td>37.82</td><td>-15.98</td><td>53.80</td><td>27.87</td><td>9.66</td><td>0.29</td><td>Average</td></tr> <tr><td>4</td><td>0.20</td><td>48.43</td><td>-15.37</td><td>63.80</td><td>38.48</td><td>9.66</td><td>0.29</td><td>QP</td></tr> <tr><td>5</td><td>0.24</td><td>35.07</td><td>-17.19</td><td>52.26</td><td>25.16</td><td>9.66</td><td>0.25</td><td>Average</td></tr> <tr><td>6</td><td>0.24</td><td>42.76</td><td>-19.50</td><td>62.26</td><td>32.85</td><td>9.66</td><td>0.25</td><td>QP</td></tr> <tr><td>7</td><td>0.29</td><td>40.62</td><td>-9.79</td><td>50.41</td><td>30.78</td><td>9.65</td><td>0.19</td><td>Average</td></tr> <tr><td>8</td><td>0.29</td><td>48.71</td><td>-11.70</td><td>60.41</td><td>38.87</td><td>9.65</td><td>0.19</td><td>QP</td></tr> <tr><td>9</td><td>0.37</td><td>31.69</td><td>-16.92</td><td>48.61</td><td>21.92</td><td>9.64</td><td>0.13</td><td>Average</td></tr> <tr><td>10</td><td>0.37</td><td>41.29</td><td>-17.32</td><td>58.61</td><td>31.52</td><td>9.64</td><td>0.13</td><td>QP</td></tr> <tr><td>11 MAX</td><td>19.73</td><td>44.19</td><td>-5.81</td><td>50.00</td><td>34.10</td><td>9.89</td><td>0.20</td><td>Average</td></tr> <tr><td>12</td><td>19.73</td><td>47.98</td><td>-12.02</td><td>60.00</td><td>37.89</td><td>9.89</td><td>0.20</td><td>QP</td></tr> </tbody> </table>					Freq	Level	Over Limit	Limit Line	Read Level	LISN Factor	Cable Loss	Remark		MHz	dBuV	dB	dBuV	dBuV	dB	dB		1	0.15	41.13	-14.87	56.00	31.31	9.60	0.22	Average	2	0.15	54.40	-11.60	66.00	44.58	9.60	0.22	QP	3	0.20	37.82	-15.98	53.80	27.87	9.66	0.29	Average	4	0.20	48.43	-15.37	63.80	38.48	9.66	0.29	QP	5	0.24	35.07	-17.19	52.26	25.16	9.66	0.25	Average	6	0.24	42.76	-19.50	62.26	32.85	9.66	0.25	QP	7	0.29	40.62	-9.79	50.41	30.78	9.65	0.19	Average	8	0.29	48.71	-11.70	60.41	38.87	9.65	0.19	QP	9	0.37	31.69	-16.92	48.61	21.92	9.64	0.13	Average	10	0.37	41.29	-17.32	58.61	31.52	9.64	0.13	QP	11 MAX	19.73	44.19	-5.81	50.00	34.10	9.89	0.20	Average	12	19.73	47.98	-12.02	60.00	37.89	9.89	0.20	QP
	Freq	Level	Over Limit	Limit Line	Read Level	LISN Factor	Cable Loss	Remark																																																																																																																									
	MHz	dBuV	dB	dBuV	dBuV	dB	dB																																																																																																																										
1	0.15	41.13	-14.87	56.00	31.31	9.60	0.22	Average																																																																																																																									
2	0.15	54.40	-11.60	66.00	44.58	9.60	0.22	QP																																																																																																																									
3	0.20	37.82	-15.98	53.80	27.87	9.66	0.29	Average																																																																																																																									
4	0.20	48.43	-15.37	63.80	38.48	9.66	0.29	QP																																																																																																																									
5	0.24	35.07	-17.19	52.26	25.16	9.66	0.25	Average																																																																																																																									
6	0.24	42.76	-19.50	62.26	32.85	9.66	0.25	QP																																																																																																																									
7	0.29	40.62	-9.79	50.41	30.78	9.65	0.19	Average																																																																																																																									
8	0.29	48.71	-11.70	60.41	38.87	9.65	0.19	QP																																																																																																																									
9	0.37	31.69	-16.92	48.61	21.92	9.64	0.13	Average																																																																																																																									
10	0.37	41.29	-17.32	58.61	31.52	9.64	0.13	QP																																																																																																																									
11 MAX	19.73	44.19	-5.81	50.00	34.10	9.89	0.20	Average																																																																																																																									
12	19.73	47.98	-12.02	60.00	37.89	9.89	0.20	QP																																																																																																																									
<p>Note 1: ">20dB" means emission levels that exceed the level of 20 dB below the applicable limit. Note 2: "N/F" means Nothing Found emissions (No emissions were detected.)</p>																																																																																																																																	



AC Power-line Conducted Emissions Result

Operating Mode	1	Power Phase	Line
Operating Function	PoE mode		

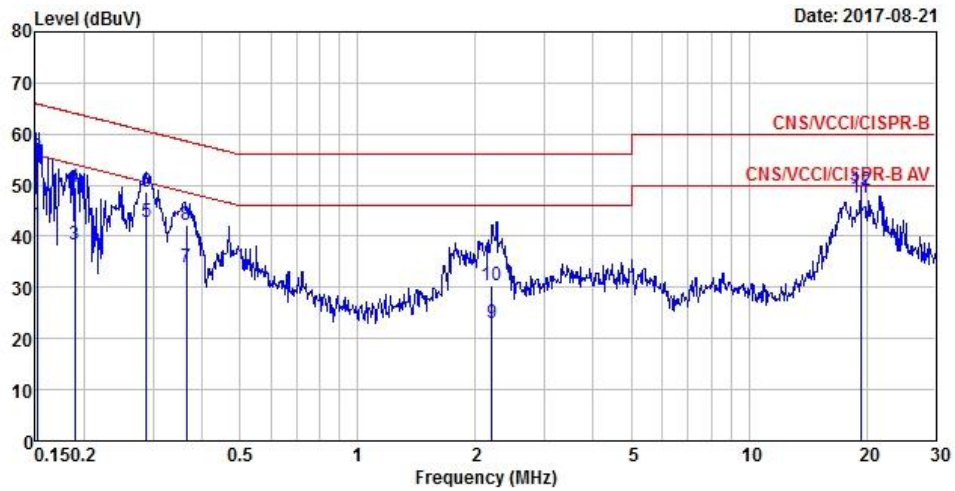

	Freq	Level	Over	Limit	Read	LISN	Cable	Remark
	MHz	dBuV	Limit	Line	Level	Factor	Loss	
			dB	dBuV	dBuV	dB	dB	
1	0.15	42.17	-13.74	55.91	32.29	9.66	0.22	Average
2	0.15	55.37	-10.54	65.91	45.49	9.66	0.22	QP
3	0.19	38.37	-15.69	54.06	28.43	9.65	0.29	Average
4	0.19	49.64	-14.42	64.06	39.70	9.65	0.29	QP
5	0.29	42.75	-7.84	50.59	32.88	9.67	0.20	Average
6	0.29	48.71	-11.88	60.59	38.84	9.67	0.20	QP
7	0.37	34.00	-14.61	48.61	24.19	9.68	0.13	Average
8	0.37	42.17	-16.44	58.61	32.36	9.68	0.13	QP
9	2.20	23.03	-22.97	46.00	12.97	9.79	0.27	Average
10	2.20	30.36	-25.64	56.00	20.30	9.79	0.27	QP
11 MAX	19.31	47.57	-2.43	50.00	37.48	9.89	0.20	Average
12	19.31	48.95	-11.05	60.00	38.86	9.89	0.20	QP

Note 1: ">20dB" means emission levels that exceed the level of 20 dB below the applicable limit.
 Note 2: "N/F" means Nothing Found emissions (No emissions were detected.)

Summary

Mode	Max-N dB (Hz)	Max-OBW (Hz)	ITU-Code	Min-N dB (Hz)	Min-OBW (Hz)
802.11b_Nss1,(1Mbps)_2TX	-	-	-	-	-
2.4-2.4835GHz	7.525M	12.019M	12M0G1D	7.025M	11.869M
802.11g_Nss1,(6Mbps)_2TX	-	-	-	-	-
2.4-2.4835GHz	16.35M	16.642M	16M6D1D	16.3M	16.542M
802.11n HT20_Nss1,(MCS0)_2TX	-	-	-	-	-
2.4-2.4835GHz	17.575M	17.791M	17M8D1D	17.5M	17.741M
802.11n HT40_Nss1,(MCS0)_2TX	-	-	-	-	-
2.4-2.4835GHz	36.3M	36.332M	36M3D1D	35.65M	36.232M

Max-N dB = Maximum 6dB down bandwidth; **Max-OBW** = Maximum 99% occupied bandwidth;
Min-N dB = Minimum 6dB down bandwidth; **Min-OBW** = Minimum 99% occupied bandwidth;

Result

Mode	Result	Limit (Hz)	Port 1-N dB (Hz)	Port 1-OBW (Hz)	Port 2-N dB (Hz)	Port 2-OBW (Hz)
802.11b_Nss1,(1Mbps)_2TX	-	-	-	-	-	-
2412MHz	Pass	500k	7.025M	11.944M	7.075M	11.919M
2437MHz	Pass	500k	7.05M	12.019M	7.05M	11.944M
2462MHz	Pass	500k	7.025M	11.994M	7.525M	11.869M
802.11g_Nss1,(6Mbps)_2TX	-	-	-	-	-	-
2412MHz	Pass	500k	16.3M	16.567M	16.325M	16.567M
2437MHz	Pass	500k	16.325M	16.592M	16.35M	16.592M
2462MHz	Pass	500k	16.325M	16.642M	16.35M	16.542M
802.11n HT20_Nss1,(MCS0)_2TX	-	-	-	-	-	-
2412MHz	Pass	500k	17.575M	17.766M	17.5M	17.741M
2437MHz	Pass	500k	17.575M	17.791M	17.575M	17.766M
2462MHz	Pass	500k	17.525M	17.741M	17.55M	17.766M
802.11n HT40_Nss1,(MCS0)_2TX	-	-	-	-	-	-
2422MHz	Pass	500k	36.05M	36.282M	35.95M	36.282M
2437MHz	Pass	500k	36M	36.332M	36.3M	36.282M
2452MHz	Pass	500k	35.65M	36.282M	35.9M	36.232M

Port X-N dB = Port X 6dB down bandwidth; **Port X-OBW** = Port X 99% occupied bandwidth;

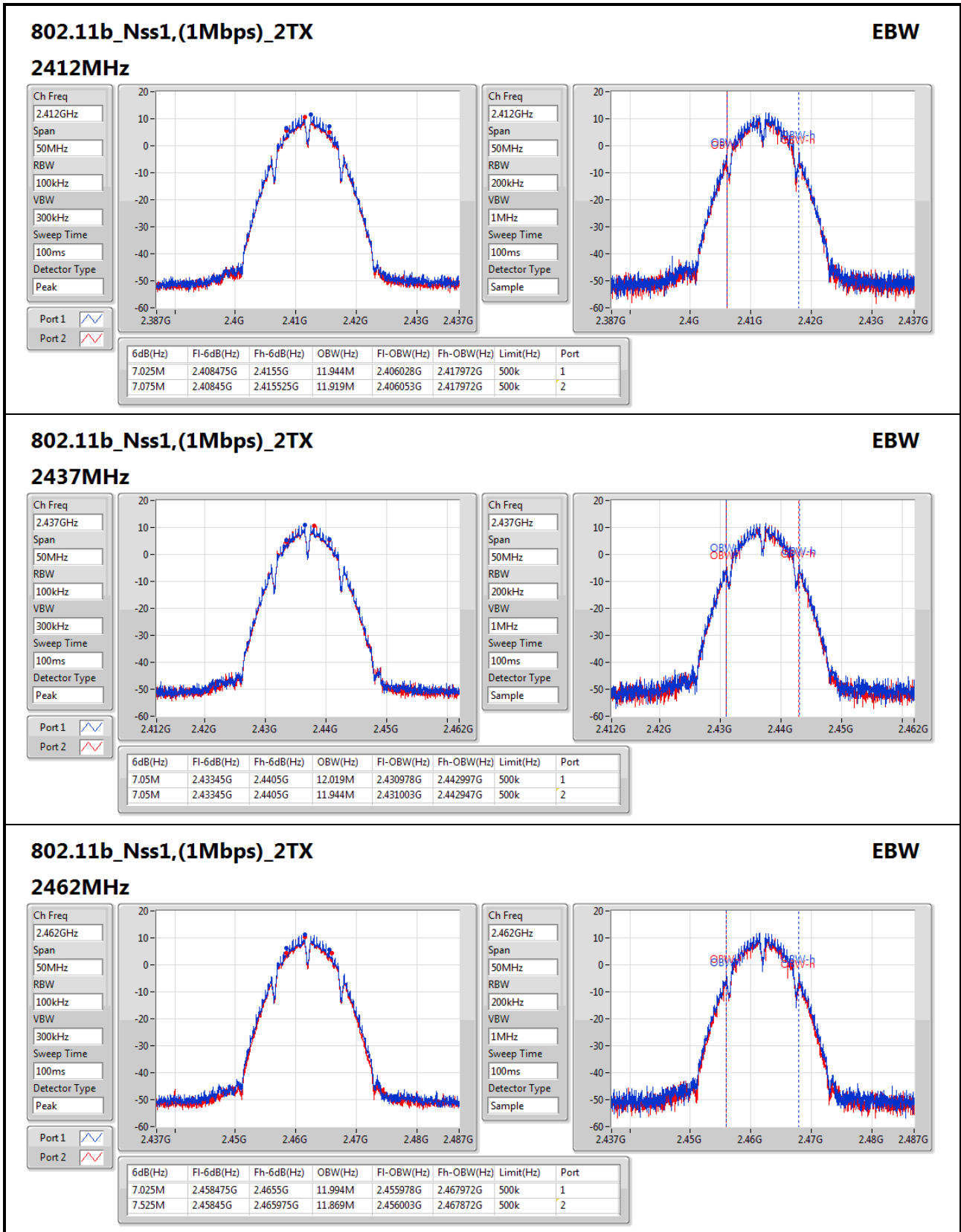

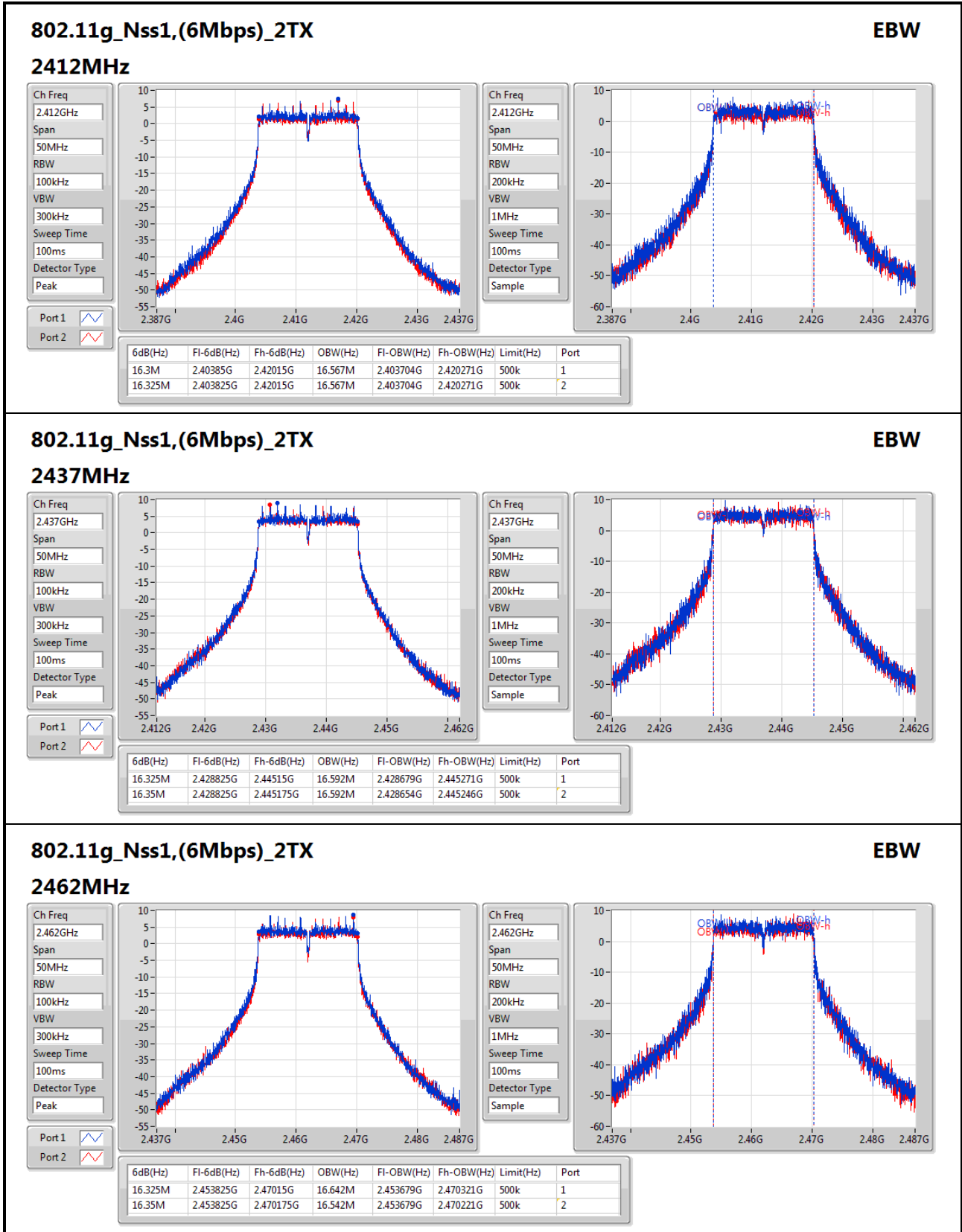

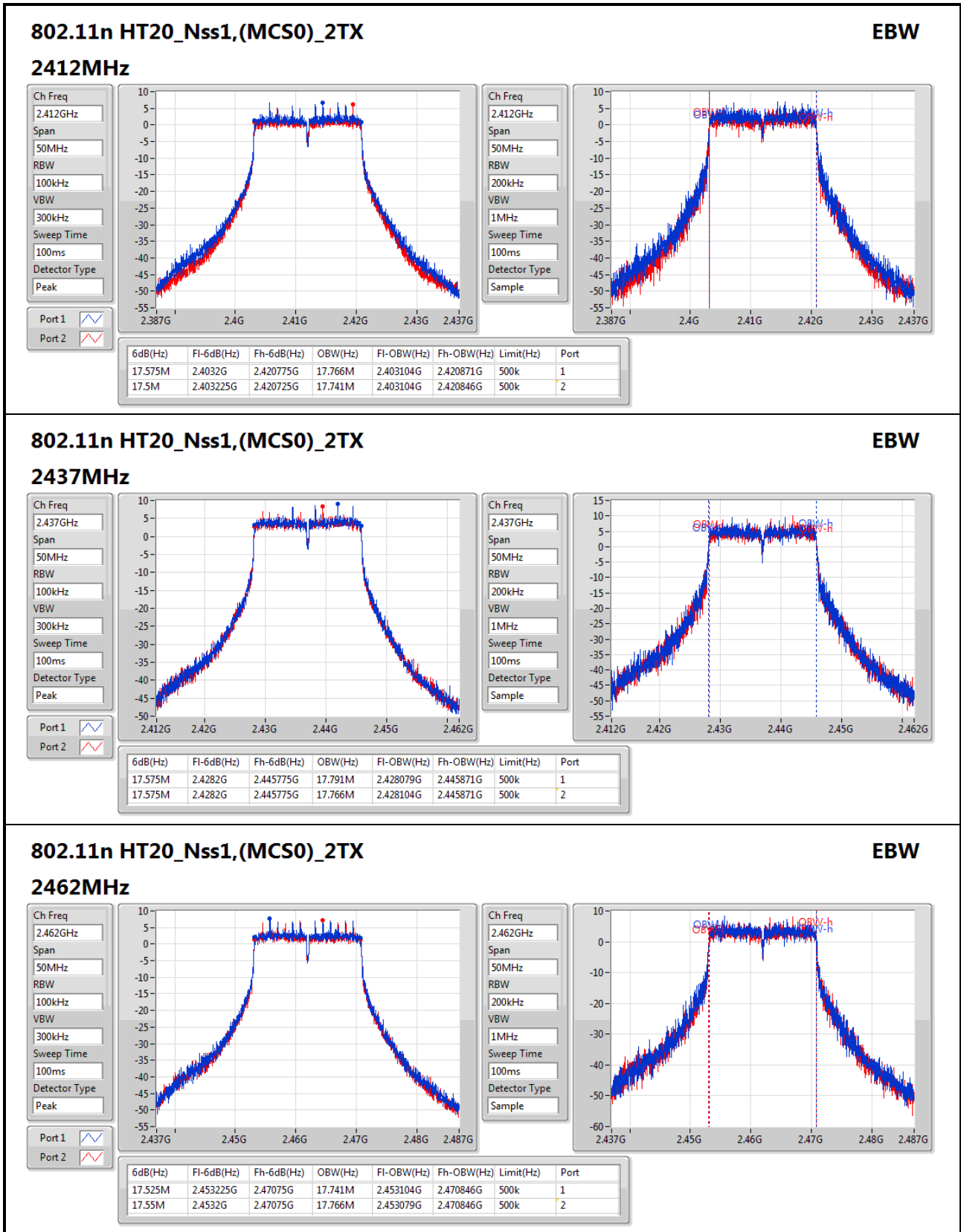

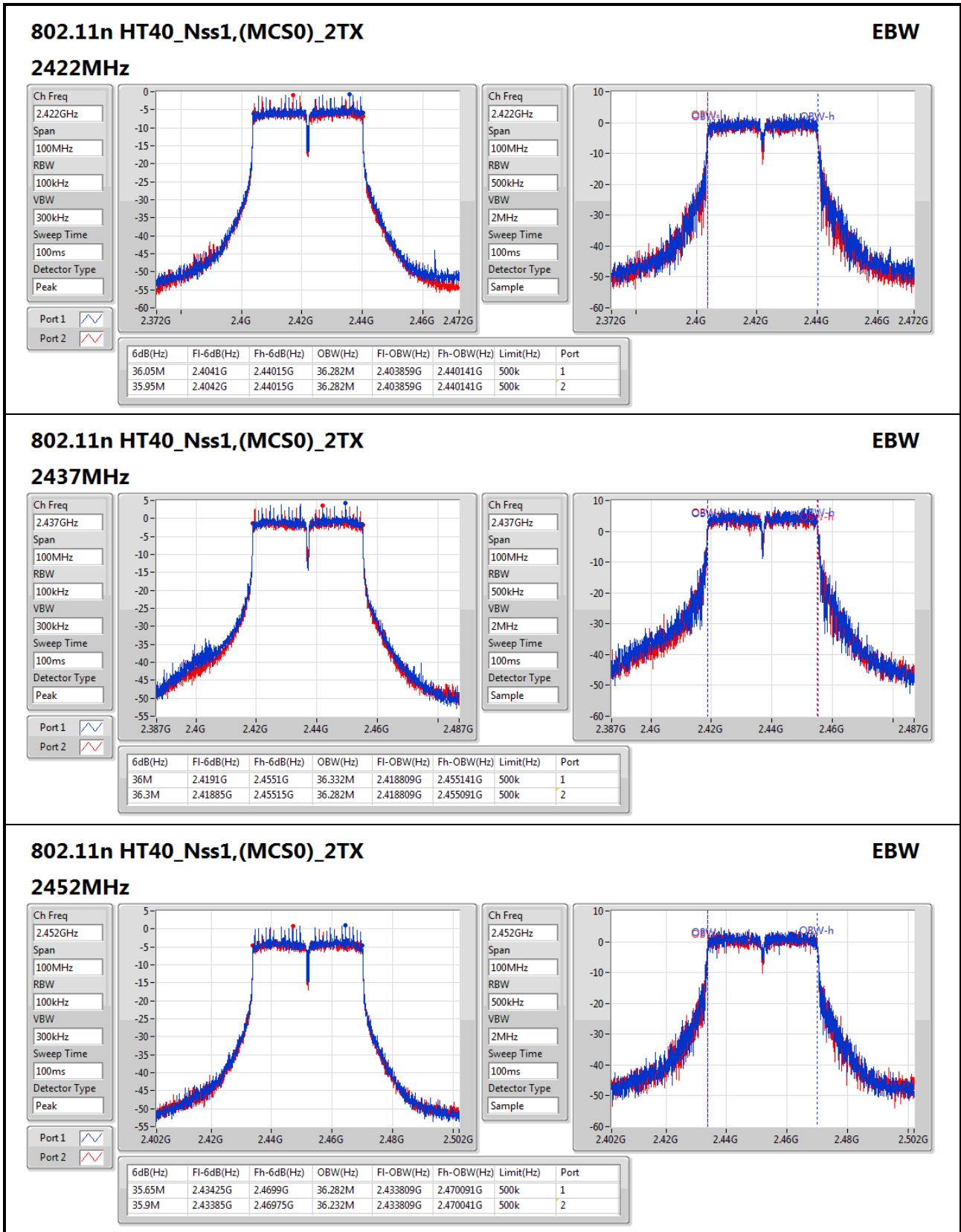



Summary

Mode	Total Power (dBm)	Total Power (W)
802.11b_Nss1,(1Mbps)_2TX	-	-
2.4-2.4835GHz	22.56	0.18030
802.11g_Nss1,(6Mbps)_2TX	-	-
2.4-2.4835GHz	23.18	0.20797
802.11n HT20_Nss1,(MCS0)_2TX	-	-
2.4-2.4835GHz	23.15	0.20654
802.11n HT40_Nss1,(MCS0)_2TX	-	-
2.4-2.4835GHz	21.21	0.13213

Result

Mode	Result	DG (dBi)	Port 1 (dBm)	Port 2 (dBm)	Total Power (dBm)	Power Limit (dBm)
802.11b_Nss1,(1Mbps)_2TX	-	-	-	-	-	-
2412MHz	Pass	12.80	19.75	19.34	22.56	23.20
2437MHz	Pass	12.80	19.21	19.34	22.29	23.20
2462MHz	Pass	12.80	19.66	19.03	22.37	23.20
802.11g_Nss1,(6Mbps)_2TX	-	-	-	-	-	-
2412MHz	Pass	12.80	18.45	17.77	21.13	23.20
2437MHz	Pass	12.80	20.28	20.06	23.18	23.20
2462MHz	Pass	12.80	20.03	19.53	22.80	23.20
802.11n HT20_Nss1,(MCS0)_2TX	-	-	-	-	-	-
2412MHz	Pass	12.80	18.01	17.35	20.70	23.20
2437MHz	Pass	12.80	20.17	20.11	23.15	23.20
2462MHz	Pass	12.80	19.15	18.68	21.93	23.20
802.11n HT40_Nss1,(MCS0)_2TX	-	-	-	-	-	-
2422MHz	Pass	12.80	13.69	13.19	16.46	23.20
2437MHz	Pass	12.80	18.50	17.87	21.21	23.20
2452MHz	Pass	12.80	15.16	14.93	18.06	23.20

DG = Directional Gain; Port X = Port X output power



Summary

Mode	PD (dBm/RBW)
802.11b_Nss1,(1Mbps)_2TX 2.4-2.4835GHz	- -1.78
802.11g_Nss1,(6Mbps)_2TX 2.4-2.4835GHz	- -4.52
802.11n HT20_Nss1,(MCS0)_2TX 2.4-2.4835GHz	- -4.84
802.11n HT40_Nss1,(MCS0)_2TX 2.4-2.4835GHz	- -7.23

RBW=3kHz.

Result

Mode	Result	DG (dBi)	Port 1 (dBm/RBW)	Port 2 (dBm/RBW)	PD (dBm/RBW)	PD Limit (dBm/RBW)
802.11b_Nss1,(1Mbps)_2TX	-	-	-	-	-	-
2412MHz	Pass	15.66	-3.33	-4.34	-1.78	-1.66
2437MHz	Pass	15.66	-4.34	-2.85	-2.07	-1.66
2462MHz	Pass	15.66	-3.68	-4.04	-2.02	-1.66
802.11g_Nss1,(6Mbps)_2TX	-	-	-	-	-	-
2412MHz	Pass	15.66	-7.24	-7.30	-6.21	-1.66
2437MHz	Pass	15.66	-6.14	-5.93	-4.52	-1.66
2462MHz	Pass	15.66	-5.20	-5.70	-4.65	-1.66
802.11n HT20_Nss1,(MCS0)_2TX	-	-	-	-	-	-
2412MHz	Pass	15.66	-8.24	-7.44	-6.83	-1.66
2437MHz	Pass	15.66	-5.88	-7.10	-4.84	-1.66
2462MHz	Pass	15.66	-7.34	-7.91	-5.68	-1.66
802.11n HT40_Nss1,(MCS0)_2TX	-	-	-	-	-	-
2422MHz	Pass	15.66	-13.22	-16.03	-12.36	-1.66
2437MHz	Pass	15.66	-10.68	-10.90	-9.16	-1.66
2452MHz	Pass	15.66	-8.41	-13.18	-7.23	-1.66

DG = Directional Gain; RBW=3kHz;

PD = trace bin-by-bin of each transmits port summing can be performed maximum power density; Port X = Port X power density;

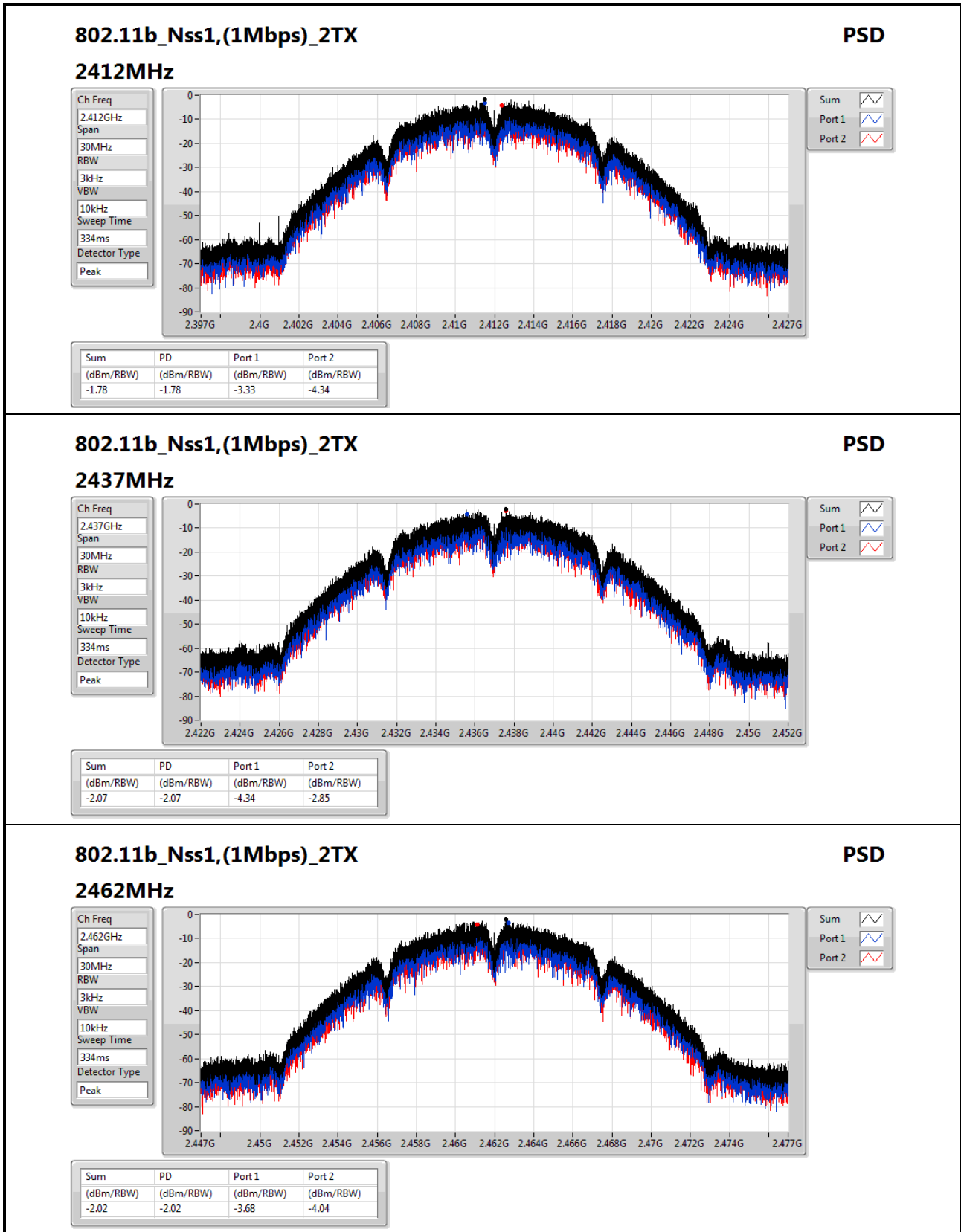

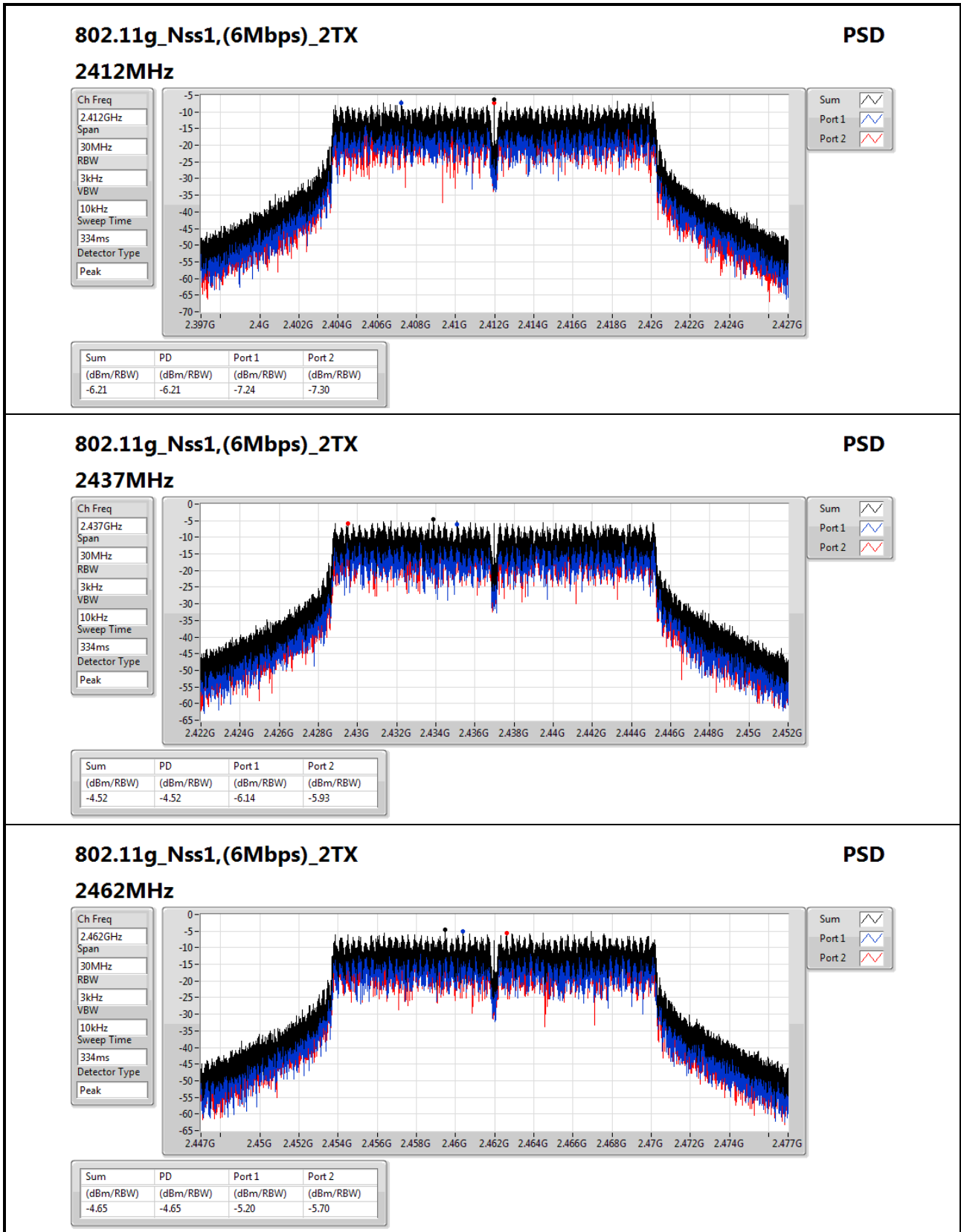

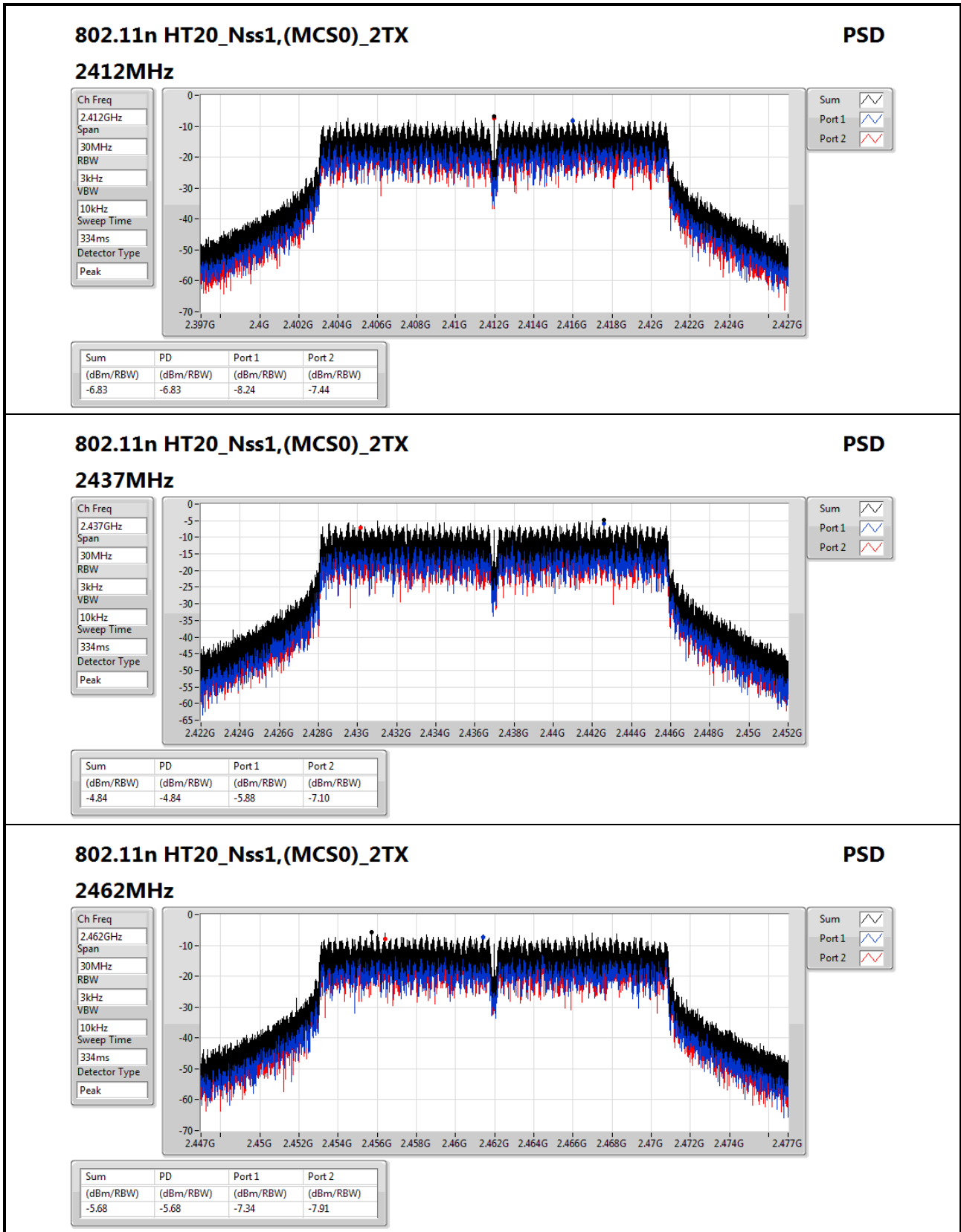

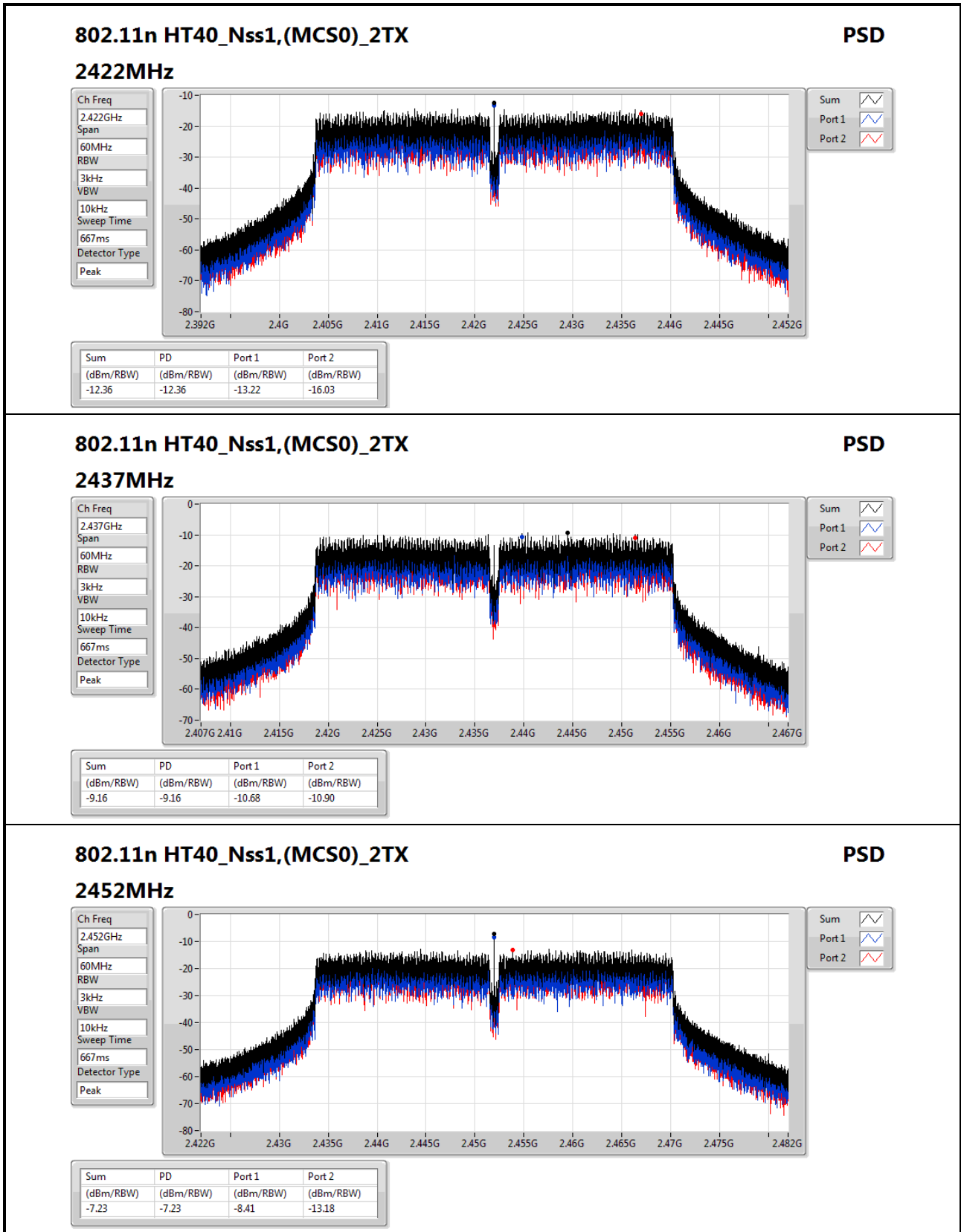



Summary

Mode	Result	Ref (Hz)	Ref (dBm)	Limit (dBm)	Freq (Hz)	Level (dBm)	Freq (Hz)	Level (dBm)	Freq (Hz)	Level (dBm)	Freq (Hz)	Level (dBm)	Port
802.11g_Nss1,(6Mbps)_2TX	-	-	-	-	-	-	-	-	-	-	-	-	-
2.4-2.4835GHz	Pass	2.430728G	8.50	-21.50	147.665M	-38.62	2.39976G	-25.20	2.48958G	-48.36	2.638692G	-50.08	1

Result

Mode	Result	Ref (Hz)	Ref (dBm)	Limit (dBm)	Freq (Hz)	Level (dBm)	Freq (Hz)	Level (dBm)	Freq (Hz)	Level (dBm)	Freq (Hz)	Level (dBm)	Port
802.11b_Nss1,(1Mbps)_2TX	-	-	-	-	-	-	-	-	-	-	-	-	-
2412MHz	Pass	2.412859G	11.28	-18.72	147.665M	-38.82	2.39856G	-44.70	2.49062G	-48.16	2.638692G	-49.51	1
2412MHz	Pass	2.412859G	11.28	-18.72	147.665M	-38.60	2.39952G	-46.62	2.49174G	-49.83	2.5235G	-52.74	2
2437MHz	Pass	2.412859G	11.28	-18.72	147.665M	-38.63	2.396G	-48.94	2.5195G	-48.68	2.638692G	-49.02	1
2437MHz	Pass	2.412859G	11.28	-18.72	147.665M	-38.60	2.396G	-50.06	2.51838G	-48.60	2.665643G	-52.69	2
2462MHz	Pass	2.412859G	11.28	-18.72	147.665M	-38.63	2.39704G	-50.24	2.50014G	-48.58	2.638692G	-48.55	1
2462MHz	Pass	2.412859G	11.28	-18.72	147.665M	-38.75	2.39712G	-50.91	2.51998G	-48.80	2.543167G	-52.09	2
802.11g_Nss1,(6Mbps)_2TX	-	-	-	-	-	-	-	-	-	-	-	-	-
2412MHz	Pass	2.430728G	8.50	-21.50	147.665M	-38.62	2.39976G	-25.20	2.48958G	-48.36	2.638692G	-50.08	1
2412MHz	Pass	2.430728G	8.50	-21.50	147.665M	-38.63	2.39976G	-27.26	2.5019G	-48.25	2.529119G	-50.23	2
2437MHz	Pass	2.430728G	8.50	-21.50	147.665M	-38.70	2.39208G	-49.16	2.51462G	-48.91	2.5235G	-50.76	1
2437MHz	Pass	2.430728G	8.50	-21.50	147.665M	-38.68	2.39992G	-47.36	2.51478G	-47.72	2.545977G	-50.12	2
2462MHz	Pass	2.430728G	8.50	-21.50	147.665M	-38.64	2.3976G	-50.18	2.48358G	-43.79	2.545977G	-51.19	1
2462MHz	Pass	2.430728G	8.50	-21.50	147.665M	-38.60	2.39016G	-52.43	2.4839G	-44.13	2.638692G	-51.28	2
802.11n HT20_Nss1,(MCS0)_2TX	-	-	-	-	-	-	-	-	-	-	-	-	-
2412MHz	Pass	2.444422G	8.98	-21.02	147.665M	-38.74	2.39976G	-24.95	2.48862G	-48.45	2.638692G	-51.39	1
2412MHz	Pass	2.444422G	8.98	-21.02	147.665M	-38.52	2.39936G	-25.48	2.50438G	-47.86	2.531929G	-49.72	2
2437MHz	Pass	2.444422G	8.98	-21.02	147.665M	-38.73	2.39912G	-49.22	2.5147G	-47.14	2.638692G	-50.08	1
2437MHz	Pass	2.444422G	8.98	-21.02	147.665M	-38.64	2.3908G	-48.90	2.5231G	-48.35	2.529119G	-49.59	2
2462MHz	Pass	2.444422G	8.98	-21.02	147.665M	-38.69	2.39272G	-50.49	2.48358G	-44.71	2.529119G	-51.79	1
2462MHz	Pass	2.444422G	8.98	-21.02	147.665M	-38.54	2.39008G	-50.29	2.48422G	-46.01	2.548786G	-51.52	2
802.11n HT40_Nss1,(MCS0)_2TX	-	-	-	-	-	-	-	-	-	-	-	-	-
2422MHz	Pass	2.440748G	3.65	-26.35	146.79M	-38.75	2.39984G	-32.23	2.50478G	-51.32	2.639223G	-52.61	1
2422MHz	Pass	2.440748G	3.65	-26.35	146.79M	-38.77	2.39984G	-32.77	2.51998G	-52.40	2.639223G	-51.46	2
2437MHz	Pass	2.440748G	3.65	-26.35	146.79M	-38.69	2.39968G	-35.96	2.4851G	-49.32	2.639223G	-49.87	1
2437MHz	Pass	2.440748G	3.65	-26.35	146.79M	-38.72	2.39984G	-40.76	2.48366G	-47.48	2.577523G	-50.89	2
2452MHz	Pass	2.440748G	3.65	-26.35	146.79M	-38.74	2.39776G	-51.19	2.48382G	-45.93	2.5635G	-52.35	1
2452MHz	Pass	2.440748G	3.65	-26.35	146.79M	-38.64	2.3912G	-51.14	2.48382G	-45.66	2.5635G	-52.26	2

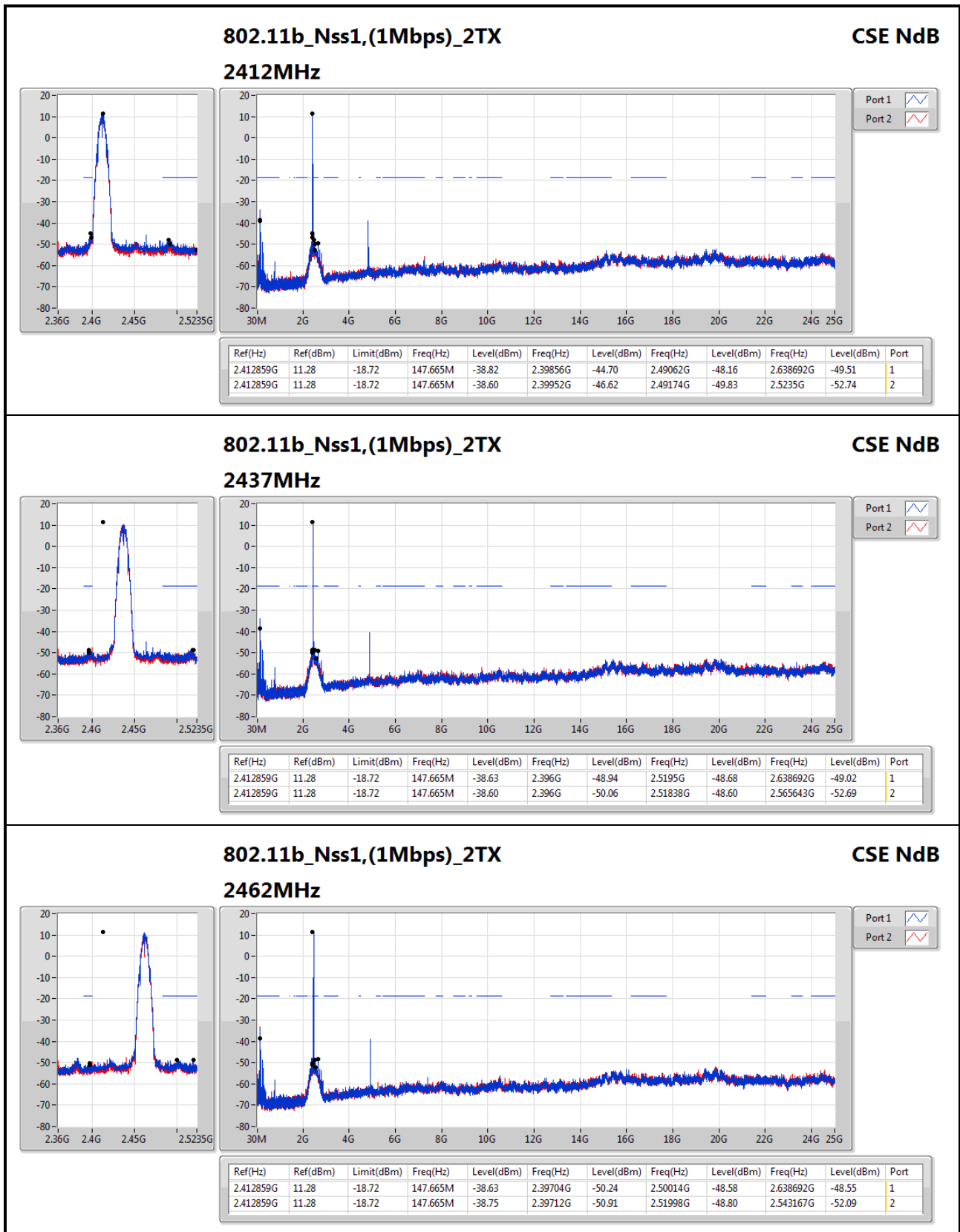

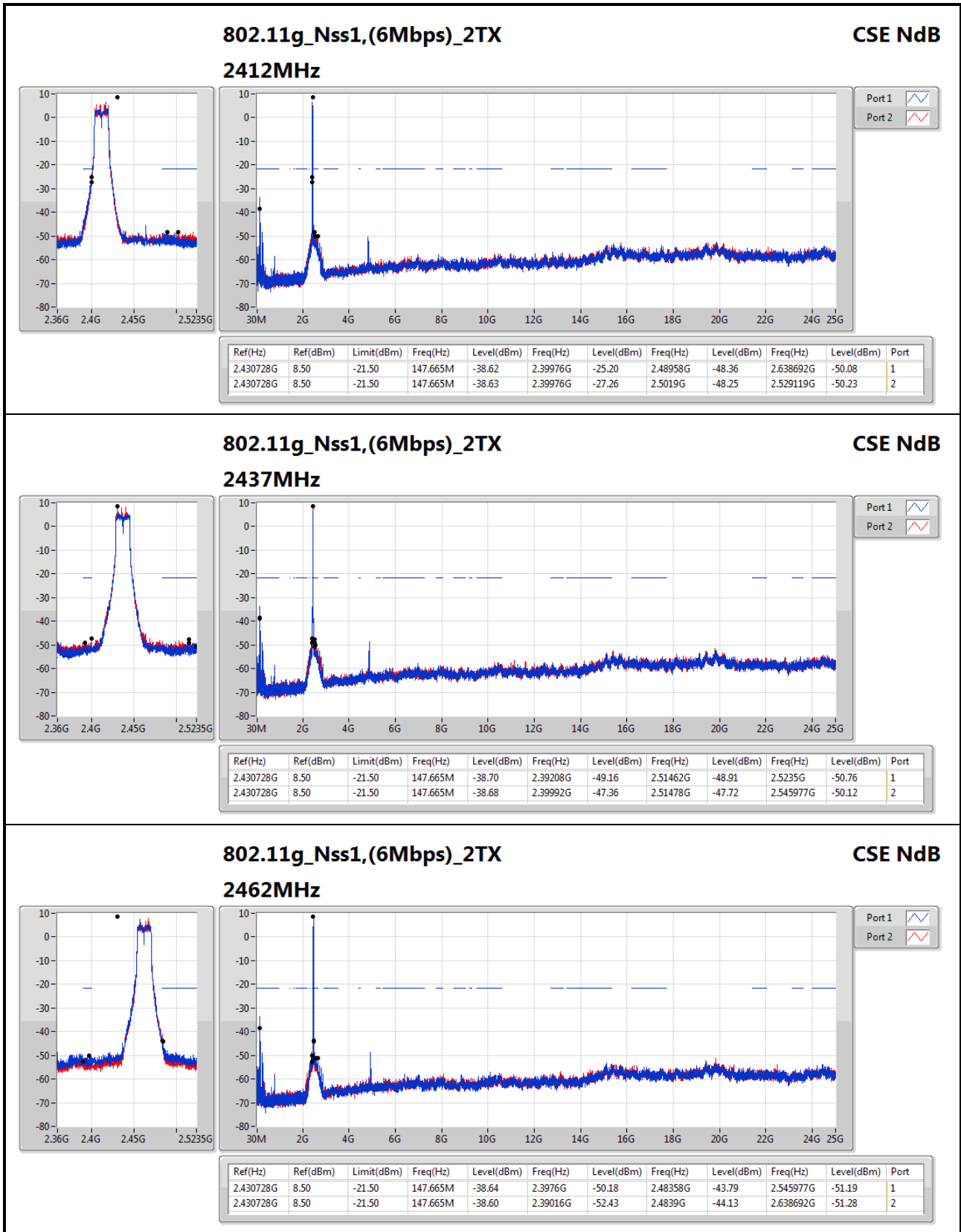

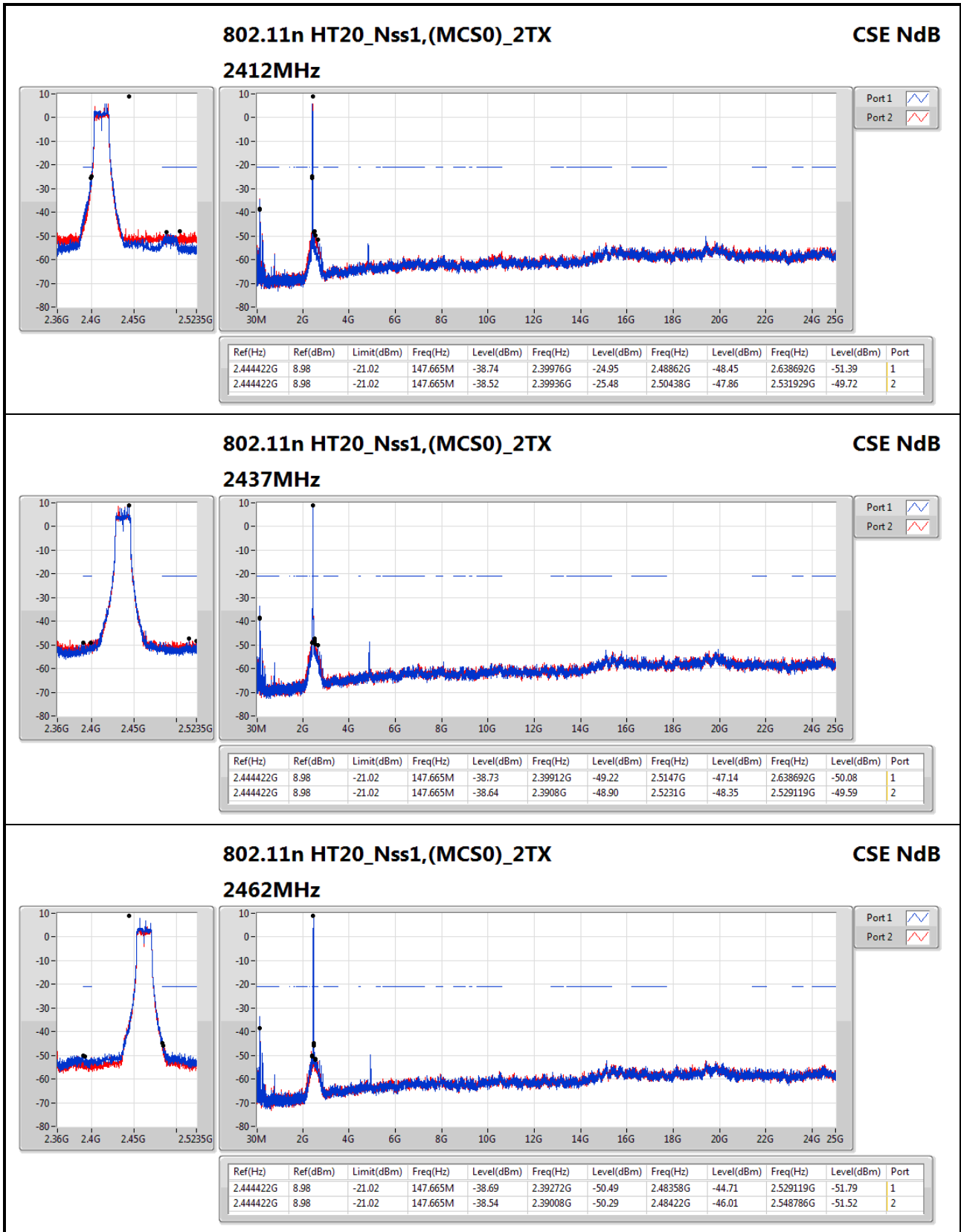

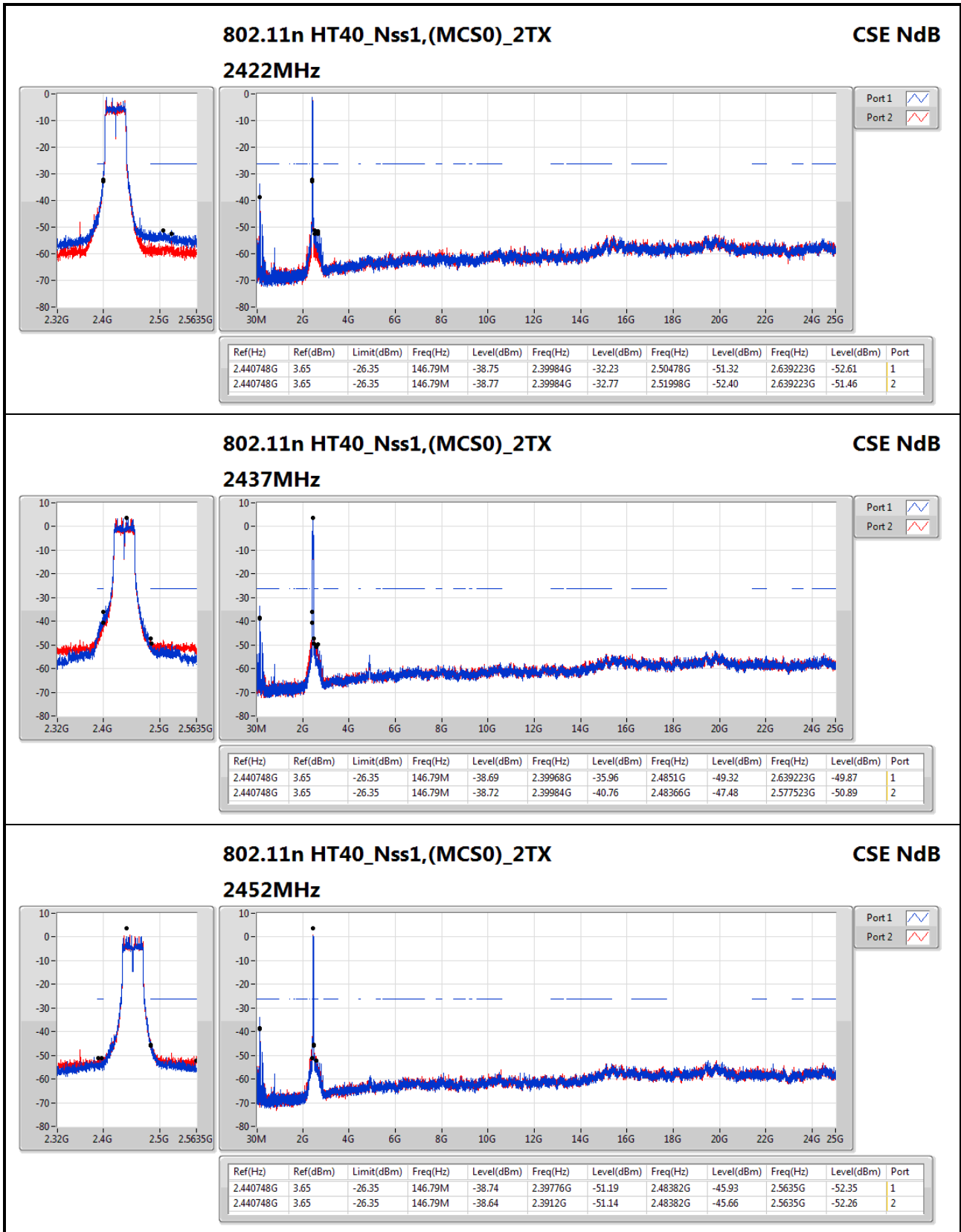



Summary

Mode	Result	Type	Freq (Hz)	Level (dBuV/m)	Limit (dBuV/m)	Margin (dB)	Factor (dB)	Dist (m)	Condition	Azimuth (°)	Height (m)	Comments
802.11n HT40_Nss1,(MCS0)_2TX	-	-	-	-	-	-	-	-	-	-	-	-
2.4-2.4835GHz	Pass	QP	375.32M	42.93	46.00	-3.07	-4.78	3	Horizontal	294	1.00	-



Result

Mode	Result	Type	Freq (Hz)	Level (dBuV/m)	Limit (dBuV/m)	Margin (dB)	Factor (dB)	Dist (m)	Condition	Azimuth (°)	Height (m)	Comments
802.11n HT40_Nss1,(MCS0)_2TX	-	-	-	-	-	-	-	-	-	-	-	-
2437MHz	Pass	QP	33.88M	28.29	40.00	-11.71	-6.70	3	Horizontal	0	2.89	-
2437MHz	Pass	QP	125.06M	30.69	43.50	-12.81	-8.94	3	Horizontal	296	3.33	-
2437MHz	Pass	QP	249.22M	22.09	46.00	-23.91	-7.80	3	Horizontal	270	1.20	-
2437MHz	Pass	QP	375.32M	42.93	46.00	-3.07	-4.78	3	Horizontal	294	1.00	-
2437MHz	Pass	QP	712.88M	36.44	46.00	-9.56	-0.08	3	Horizontal	206	1.00	-
2437MHz	Pass	QP	730.34M	33.76	46.00	-12.24	0.29	3	Horizontal	6	1.34	-
2437MHz	Pass	QP	33.88M	31.51	40.00	-8.49	-6.70	3	Vertical	177	1.00	-
2437MHz	Pass	QP	99.84M	22.49	43.50	-21.01	-10.37	3	Vertical	203	1.00	-
2437MHz	Pass	QP	125.06M	31.48	43.50	-12.02	-8.94	3	Vertical	335	1.00	-
2437MHz	Pass	QP	375.32M	42.17	46.00	-3.83	-4.78	3	Vertical	249	1.21	-
2437MHz	Pass	QP	625.58M	38.94	46.00	-7.06	-0.96	3	Vertical	190	1.76	-
2437MHz	Pass	QP	712.88M	34.62	46.00	-11.38	-0.08	3	Vertical	12	1.32	-

802.11n HT40_Nss1,(MCS0)_2TX

2437MHz_PoE

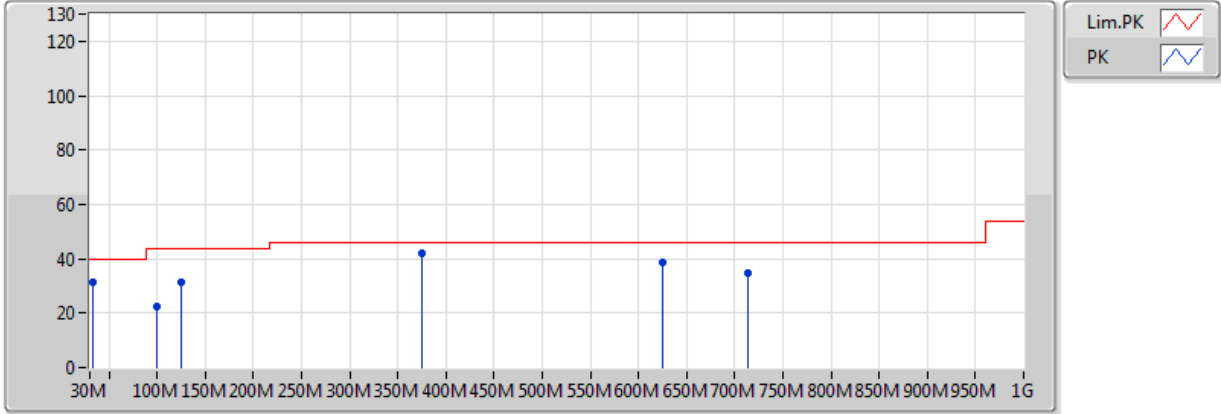

EUT = Y

Type	Freq (Hz)	Level (dBuV/m)	Limit (dBuV/m)	Margin (dB)	Factor (dB)	Dist (m)	Condition	Azimuth (°)	Height (m)	Comments	Raw (dBuV)	AF (dB)	CL (dB)	PA (dB)
QP	33.88M	31.51	40.00	-8.49	-6.70	3	Vertical	177	1.00	-	38.21	20.36	0.74	27.80
QP	99.84M	22.49	43.50	-21.01	-10.37	3	Vertical	203	1.00	-	32.86	16.00	1.44	27.81
QP	125.06M	31.48	43.50	-12.02	-8.94	3	Vertical	335	1.00	-	40.42	17.12	1.66	27.72
QP	375.32M	42.17	46.00	-3.83	-4.78	3	Vertical	249	1.21	-	46.95	20.19	2.80	27.77
QP	625.58M	38.94	46.00	-7.06	-0.96	3	Vertical	190	1.76	-	39.90	23.85	3.71	28.51
QP	712.88M	34.62	46.00	-11.38	-0.08	3	Vertical	12	1.32	-	34.70	24.15	4.12	28.34

802.11n HT40_Nss1,(MCS0)_2TX

2437MHz_PoE

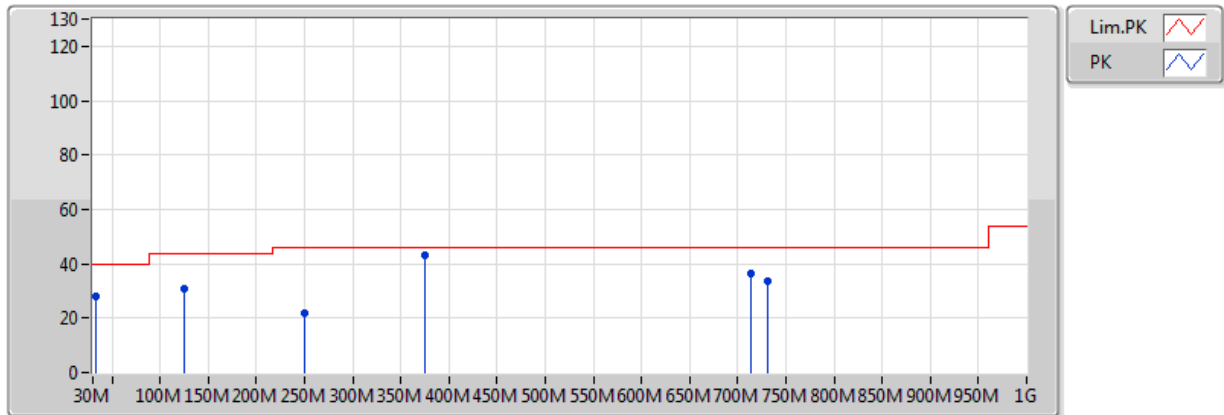

EUT = Y

Type	Freq (Hz)	Level (dBuV/m)	Limit (dBuV/m)	Margin (dB)	Factor (dB)	Dist (m)	Condition	Azimuth (°)	Height (m)	Comments	Raw (dBuV)	AF (dB)	CL (dB)	PA (dB)
QP	33.88M	28.29	40.00	-11.71	-6.70	3	Horizontal	0	2.89	-	34.99	20.36	0.74	27.80
QP	125.06M	30.69	43.50	-12.81	-8.94	3	Horizontal	296	3.33	-	39.63	17.12	1.66	27.72
QP	249.22M	22.09	46.00	-23.91	-7.80	3	Horizontal	270	1.20	-	29.89	17.32	2.20	27.32
QP	375.32M	42.93	46.00	-3.07	-4.78	3	Horizontal	294	1.00	-	47.71	20.19	2.80	27.77
QP	712.88M	36.44	46.00	-9.56	-0.08	3	Horizontal	206	1.00	-	36.52	24.15	4.12	28.34
QP	730.34M	33.76	46.00	-12.24	0.29	3	Horizontal	6	1.34	-	33.47	24.44	4.14	28.29



Summary

Mode	Result	Type	Freq (Hz)	Level (dBuV/m)	Limit (dBuV/m)	Margin (dB)	Factor (dB)	Dist (m)	Condition	Azimuth (°)	Height (m)	Comments
802.11n HT40_Nss1,(MCS0)_2TX	-	-	-	-	-	-	-	-	-	-	-	-
2.4-2.4835GHz	Pass	AV	2.483594G	53.80	54.00	-0.20	31.27	3	Vertical	12	2.27	-



Result

Mode	Result	Type	Freq (Hz)	Level (dBuV/m)	Limit (dBuV/m)	Margin (dB)	Factor (dB)	Dist (m)	Condition	Azimuth (°)	Height (m)	Comments
802.11b_(1Mbps)_2TX	-	-	-	-	-	-	-	-	-	-	-	-
2412MHz	Pass	AV	2.3728G	50.99	54.00	-3.01	30.87	3	Horizontal	10	1.50	-
2412MHz	Pass	AV	2.4128G	115.81	Inf	-Inf	31.02	3	Horizontal	10	1.50	-
2412MHz	Pass	PK	2.3882G	61.52	74.00	-12.48	30.93	3	Horizontal	10	1.50	-
2412MHz	Pass	PK	2.4128G	118.28	Inf	-Inf	31.02	3	Horizontal	10	1.50	-
2412MHz	Pass	AV	2.3892G	53.50	54.00	-0.50	30.93	3	Vertical	5	2.30	-
2412MHz	Pass	AV	2.4128G	118.45	Inf	-Inf	31.02	3	Vertical	5	2.30	-
2412MHz	Pass	PK	2.3724G	65.14	74.00	-8.86	30.87	3	Vertical	5	2.30	-
2412MHz	Pass	PK	2.4128G	121.03	Inf	-Inf	31.02	3	Vertical	5	2.30	-
2412MHz	Pass	AV	4.824G	29.74	54.00	-24.26	2.16	3	Horizontal	165	1.50	-
2412MHz	Pass	PK	4.824G	43.67	74.00	-30.33	2.16	3	Horizontal	165	1.50	-
2412MHz	Pass	AV	4.824G	29.57	54.00	-24.43	2.16	3	Vertical	93	2.27	-
2412MHz	Pass	PK	4.824G	43.78	74.00	-30.22	2.16	3	Vertical	93	2.27	-
2437MHz	Pass	AV	2.3374G	47.79	54.00	-6.21	30.75	3	Horizontal	0	1.63	-
2437MHz	Pass	AV	2.4378G	117.89	Inf	-Inf	31.11	3	Horizontal	0	1.63	-
2437MHz	Pass	AV	2.483502G	49.17	54.00	-4.83	31.27	3	Horizontal	0	1.63	-
2437MHz	Pass	PK	2.3618G	60.59	74.00	-13.41	30.84	3	Horizontal	0	1.63	-
2437MHz	Pass	PK	2.4378G	119.97	Inf	-Inf	31.11	3	Horizontal	0	1.63	-
2437MHz	Pass	PK	2.4978G	59.88	74.00	-14.12	31.32	3	Horizontal	0	1.63	-
2437MHz	Pass	AV	2.3866G	50.35	54.00	-3.65	30.92	3	Vertical	9	2.57	-
2437MHz	Pass	AV	2.4362G	120.85	Inf	-Inf	31.10	3	Vertical	9	2.57	-
2437MHz	Pass	AV	2.483502G	50.97	54.00	-3.03	31.27	3	Vertical	9	2.57	-
2437MHz	Pass	PK	2.355G	65.15	74.00	-8.85	30.81	3	Vertical	9	2.57	-
2437MHz	Pass	PK	2.4362G	122.33	Inf	-Inf	31.10	3	Vertical	9	2.57	-
2437MHz	Pass	PK	2.4838G	62.20	74.00	-11.80	31.27	3	Vertical	9	2.57	-
2437MHz	Pass	AV	4.874G	29.76	54.00	-24.24	2.32	3	Horizontal	95	1.70	-
2437MHz	Pass	PK	4.874G	44.35	74.00	-29.65	2.32	3	Horizontal	95	1.70	-
2437MHz	Pass	AV	4.874G	29.78	54.00	-24.22	2.32	3	Vertical	30	1.51	-
2437MHz	Pass	PK	4.874G	43.45	74.00	-30.55	2.32	3	Vertical	30	1.51	-
2462MHz	Pass	AV	2.462725G	116.80	Inf	-Inf	31.20	3	Horizontal	12	1.34	-
2462MHz	Pass	AV	2.484754G	51.98	54.00	-2.02	31.28	3	Horizontal	12	1.34	-
2462MHz	Pass	PK	2.46287G	119.31	Inf	-Inf	31.20	3	Horizontal	12	1.34	-
2462MHz	Pass	PK	2.499826G	61.62	74.00	-12.38	31.33	3	Horizontal	12	1.34	-
2462MHz	Pass	AV	2.461275G	117.58	Inf	-Inf	31.19	3	Vertical	11	2.67	-
2462MHz	Pass	AV	2.487362G	53.06	54.00	-0.94	31.28	3	Vertical	11	2.67	-
2462MHz	Pass	PK	2.46113G	119.33	Inf	-Inf	31.19	3	Vertical	11	2.67	-
2462MHz	Pass	PK	2.498957G	63.02	74.00	-10.98	31.33	3	Vertical	11	2.67	-
2462MHz	Pass	AV	4.924G	28.97	54.00	-25.03	1.77	3	Horizontal	243	1.50	-
2462MHz	Pass	PK	4.924G	44.19	74.00	-29.81	1.77	3	Horizontal	243	1.50	-
2462MHz	Pass	AV	4.924G	29.07	54.00	-24.93	1.77	3	Vertical	270	2.01	-
2462MHz	Pass	PK	4.924G	44.45	74.00	-29.55	1.77	3	Vertical	270	2.01	-
802.11g_(6Mbps)_2TX	-	-	-	-	-	-	-	-	-	-	-	-
2412MHz	Pass	AV	2.389998G	51.33	54.00	-2.67	30.93	3	Horizontal	1	1.50	-
2412MHz	Pass	AV	2.417797G	101.94	Inf	-Inf	31.03	3	Horizontal	1	1.50	-
2412MHz	Pass	PK	2.389826G	67.40	74.00	-6.60	30.93	3	Horizontal	1	1.50	-
2412MHz	Pass	PK	2.417652G	112.83	Inf	-Inf	31.03	3	Horizontal	1	1.50	-
2412MHz	Pass	AV	2.389998G	53.46	54.00	-0.54	30.93	3	Vertical	6	2.33	-
2412MHz	Pass	AV	2.404899G	104.11	Inf	-Inf	30.99	3	Vertical	6	2.33	-



RSE TX above 1GHz Result

Appendix F.2

Mode	Result	Type	Freq (Hz)	Level (dBuV/m)	Limit (dBuV/m)	Margin (dB)	Factor (dB)	Dist (m)	Condition	Azimuth (°)	Height (m)	Comments
2412MHz	Pass	PK	2.389536G	68.52	74.00	-5.48	30.93	3	Vertical	6	2.33	-
2412MHz	Pass	PK	2.414899G	115.38	Inf	-Inf	31.02	3	Vertical	6	2.33	-
2412MHz	Pass	AV	4.824G	30.77	54.00	-23.23	2.16	3	Horizontal	222	2.11	-
2412MHz	Pass	PK	4.824G	44.68	74.00	-29.32	2.16	3	Horizontal	222	2.11	-
2412MHz	Pass	AV	4.824G	30.69	54.00	-23.31	2.16	3	Vertical	193	2.21	-
2412MHz	Pass	PK	4.824G	43.52	74.00	-30.48	2.16	3	Vertical	193	2.21	-
2437MHz	Pass	AV	2.389998G	51.65	54.00	-2.35	30.93	3	Horizontal	13	1.39	-
2437MHz	Pass	AV	2.441928G	111.11	Inf	-Inf	31.12	3	Horizontal	13	1.39	-
2437MHz	Pass	AV	2.483502G	53.19	54.00	-0.81	31.27	3	Horizontal	13	1.39	-
2437MHz	Pass	PK	2.388594G	70.68	74.00	-3.32	30.93	3	Horizontal	13	1.39	-
2437MHz	Pass	PK	2.43642G	122.19	Inf	-Inf	31.10	3	Horizontal	13	1.39	-
2437MHz	Pass	PK	2.485406G	72.83	74.00	-1.17	31.28	3	Horizontal	13	1.39	-
2437MHz	Pass	AV	2.389464G	52.92	54.00	-1.08	30.93	3	Vertical	6	2.09	-
2437MHz	Pass	AV	2.434391G	112.39	Inf	-Inf	31.09	3	Vertical	6	2.09	-
2437MHz	Pass	AV	2.483502G	53.58	54.00	-0.42	31.27	3	Vertical	6	2.09	-
2437MHz	Pass	PK	2.352652G	70.35	74.00	-3.65	30.80	3	Vertical	6	2.09	-
2437MHz	Pass	PK	2.434391G	122.19	Inf	-Inf	31.09	3	Vertical	6	2.09	-
2437MHz	Pass	PK	2.486275G	68.75	74.00	-5.25	31.28	3	Vertical	6	2.09	-
2437MHz	Pass	AV	4.874G	30.81	54.00	-23.19	2.32	3	Horizontal	62	1.11	-
2437MHz	Pass	PK	4.874G	44.27	74.00	-29.73	2.32	3	Horizontal	62	1.11	-
2437MHz	Pass	AV	4.874G	30.60	54.00	-23.40	2.32	3	Vertical	31	1.01	-
2437MHz	Pass	PK	4.874G	44.41	74.00	-29.59	2.32	3	Vertical	31	1.01	-
2462MHz	Pass	AV	2.467362G	104.77	Inf	-Inf	31.21	3	Horizontal	9	1.63	-
2462MHz	Pass	AV	2.483502G	52.42	54.00	-1.58	31.27	3	Horizontal	9	1.63	-
2462MHz	Pass	PK	2.467217G	116.23	Inf	-Inf	31.21	3	Horizontal	9	1.63	-
2462MHz	Pass	PK	2.483502G	70.57	74.00	-3.43	31.27	3	Horizontal	9	1.63	-
2462MHz	Pass	AV	2.455478G	105.50	Inf	-Inf	31.17	3	Vertical	12	2.04	-
2462MHz	Pass	AV	2.483502G	53.69	54.00	-0.31	31.27	3	Vertical	12	2.04	-
2462MHz	Pass	PK	2.466058G	115.19	Inf	-Inf	31.21	3	Vertical	12	2.04	-
2462MHz	Pass	PK	2.485333G	69.06	74.00	-4.94	31.28	3	Vertical	12	2.04	-
2462MHz	Pass	AV	4.924G	31.00	54.00	-23.00	2.48	3	Horizontal	152	1.15	-
2462MHz	Pass	PK	4.924G	45.24	74.00	-28.76	2.48	3	Horizontal	152	1.15	-
2462MHz	Pass	AV	4.924G	31.09	54.00	-22.91	2.48	3	Vertical	340	2.42	-
2462MHz	Pass	PK	4.924G	44.20	74.00	-29.80	2.48	3	Vertical	340	2.42	-
802.11n HT20_Nss1_(MCS0)_2TX	-	-	-	-	-	-	-	-	-	-	-	-
2412MHz	Pass	AV	2.389681G	52.08	54.00	-1.92	30.93	3	Horizontal	9	1.50	-
2412MHz	Pass	AV	2.415623G	101.69	Inf	-Inf	31.03	3	Horizontal	9	1.50	-
2412MHz	Pass	PK	2.389536G	67.83	74.00	-6.17	30.93	3	Horizontal	9	1.50	-
2412MHz	Pass	PK	2.417217G	112.44	Inf	-Inf	31.03	3	Horizontal	9	1.50	-
2412MHz	Pass	AV	2.389998G	53.50	54.00	-0.50	30.93	3	Vertical	1	2.28	-
2412MHz	Pass	AV	2.414899G	103.38	Inf	-Inf	31.02	3	Vertical	1	2.28	-
2412MHz	Pass	PK	2.389826G	71.96	74.00	-2.04	30.93	3	Vertical	1	2.28	-
2412MHz	Pass	PK	2.415478G	113.72	Inf	-Inf	31.03	3	Vertical	1	2.28	-
2412MHz	Pass	AV	4.824G	30.58	54.00	-23.42	2.16	3	Horizontal	73	1.30	-
2412MHz	Pass	PK	4.824G	44.04	74.00	-29.96	2.16	3	Horizontal	73	1.30	-
2412MHz	Pass	AV	4.824G	30.49	54.00	-23.51	2.16	3	Vertical	37	1.90	-
2412MHz	Pass	PK	4.824G	44.93	74.00	-29.07	2.16	3	Vertical	37	1.90	-
2437MHz	Pass	AV	2.389754G	52.35	54.00	-1.65	30.93	3	Horizontal	9	1.50	-
2437MHz	Pass	AV	2.435261G	110.52	Inf	-Inf	31.10	3	Horizontal	9	1.50	-



RSE TX above 1GHz Result

Appendix F.2

Mode	Result	Type	Freq (Hz)	Level (dBuV/m)	Limit (dBuV/m)	Margin (dB)	Factor (dB)	Dist (m)	Condition	Azimuth (°)	Height (m)	Comments
2437MHz	Pass	AV	2.483502G	53.29	54.00	-0.71	31.27	3	Horizontal	9	1.50	-
2437MHz	Pass	PK	2.389754G	70.49	74.00	-3.51	30.93	3	Horizontal	9	1.50	-
2437MHz	Pass	PK	2.43642G	120.99	Inf	-Inf	31.10	3	Horizontal	9	1.50	-
2437MHz	Pass	PK	2.483502G	73.74	74.00	-0.26	31.27	3	Horizontal	9	1.50	-
2437MHz	Pass	AV	2.389998G	53.15	54.00	-0.85	30.93	3	Vertical	7	2.06	-
2437MHz	Pass	AV	2.433812G	111.78	Inf	-Inf	31.09	3	Vertical	7	2.06	-
2437MHz	Pass	AV	2.483502G	53.58	54.00	-0.42	31.27	3	Vertical	7	2.06	-
2437MHz	Pass	PK	2.389998G	72.27	74.00	-1.73	30.93	3	Vertical	7	2.06	-
2437MHz	Pass	PK	2.437G	122.24	Inf	-Inf	31.10	3	Vertical	7	2.06	-
2437MHz	Pass	PK	2.485696G	71.58	74.00	-2.42	31.28	3	Vertical	7	2.06	-
2437MHz	Pass	AV	4.874G	30.90	54.00	-23.10	2.32	3	Horizontal	5	1.13	-
2437MHz	Pass	PK	4.874G	43.97	74.00	-30.03	2.32	3	Horizontal	5	1.13	-
2437MHz	Pass	AV	4.874G	30.70	54.00	-23.30	2.32	3	Vertical	59	1.25	-
2437MHz	Pass	PK	4.874G	44.26	74.00	-29.74	2.32	3	Vertical	59	1.25	-
2462MHz	Pass	AV	2.466058G	102.78	Inf	-Inf	31.21	3	Horizontal	2	1.50	-
2462MHz	Pass	AV	2.483594G	51.75	54.00	-2.25	31.27	3	Horizontal	2	1.50	-
2462MHz	Pass	PK	2.465188G	113.02	Inf	-Inf	31.20	3	Horizontal	2	1.50	-
2462MHz	Pass	PK	2.483594G	69.78	74.00	-4.22	31.27	3	Horizontal	2	1.50	-
2462MHz	Pass	AV	2.456058G	104.49	Inf	-Inf	31.17	3	Vertical	11	2.68	-
2462MHz	Pass	AV	2.483502G	53.56	54.00	-0.44	31.27	3	Vertical	11	2.68	-
2462MHz	Pass	PK	2.457652G	114.75	Inf	-Inf	31.18	3	Vertical	11	2.68	-
2462MHz	Pass	PK	2.484174G	68.29	74.00	-5.71	31.27	3	Vertical	11	2.68	-
2462MHz	Pass	AV	4.924G	30.90	54.00	-23.10	2.48	3	Horizontal	2	1.62	-
2462MHz	Pass	PK	4.924G	44.45	74.00	-29.55	2.48	3	Horizontal	2	1.62	-
2462MHz	Pass	AV	4.924G	31.14	54.00	-22.86	2.48	3	Vertical	91	1.10	-
2462MHz	Pass	PK	4.924G	44.38	74.00	-29.62	2.48	3	Vertical	91	1.10	-
802.11n HT40_Nss1,(MCS0)_2TX	-	-	-	-	-	-	-	-	-	-	-	-
2422MHz	Pass	AV	2.389998G	50.65	54.00	-3.35	30.93	3	Horizontal	12	1.15	-
2422MHz	Pass	AV	2.437362G	95.06	Inf	-Inf	31.10	3	Horizontal	12	1.15	-
2422MHz	Pass	AV	2.488087G	49.48	54.00	-4.52	31.29	3	Horizontal	12	1.15	-
2422MHz	Pass	PK	2.389246G	65.00	74.00	-9.00	30.93	3	Horizontal	12	1.15	-
2422MHz	Pass	PK	2.435623G	105.04	Inf	-Inf	31.10	3	Horizontal	12	1.15	-
2422MHz	Pass	PK	2.498522G	63.62	74.00	-10.38	31.32	3	Horizontal	12	1.15	-
2422MHz	Pass	AV	2.389536G	53.48	54.00	-0.52	30.93	3	Vertical	1	2.53	-
2422MHz	Pass	AV	2.424899G	97.24	Inf	-Inf	31.06	3	Vertical	1	2.53	-
2422MHz	Pass	AV	2.486638G	49.76	54.00	-4.24	31.28	3	Vertical	1	2.53	-
2422MHz	Pass	PK	2.389998G	70.08	74.00	-3.92	30.93	3	Vertical	1	2.53	-
2422MHz	Pass	PK	2.432725G	107.33	Inf	-Inf	31.09	3	Vertical	1	2.53	-
2422MHz	Pass	PK	2.486348G	63.91	74.00	-10.09	31.28	3	Vertical	1	2.53	-
2422MHz	Pass	AV	4.844G	31.66	54.00	-22.34	2.23	3	Horizontal	292	1.25	-
2422MHz	Pass	PK	4.844G	44.80	74.00	-29.20	2.23	3	Horizontal	292	1.25	-
2422MHz	Pass	AV	4.844G	31.77	54.00	-22.23	2.23	3	Vertical	325	1.41	-
2422MHz	Pass	PK	4.844G	43.88	74.00	-30.12	2.23	3	Vertical	325	1.41	-
2437MHz	Pass	AV	2.389754G	50.95	54.00	-3.05	30.93	3	Horizontal	357	1.45	-
2437MHz	Pass	AV	2.449174G	100.17	Inf	-Inf	31.15	3	Horizontal	357	1.45	-
2437MHz	Pass	AV	2.483502G	51.02	54.00	-2.98	31.27	3	Horizontal	357	1.45	-
2437MHz	Pass	PK	2.381058G	63.84	74.00	-10.16	30.90	3	Horizontal	357	1.45	-
2437MHz	Pass	PK	2.446275G	109.65	Inf	-Inf	31.14	3	Horizontal	357	1.45	-
2437MHz	Pass	PK	2.488304G	64.55	74.00	-9.45	31.29	3	Horizontal	357	1.45	-



RSE TX above 1GHz Result

Appendix F.2

Mode	Result	Type	Freq (Hz)	Level (dBuV/m)	Limit (dBuV/m)	Margin (dB)	Factor (dB)	Dist (m)	Condition	Azimuth (°)	Height (m)	Comments
2437MHz	Pass	AV	2.389998G	53.45	54.00	-0.55	30.93	3	Vertical	6	2.54	-
2437MHz	Pass	AV	2.435551G	101.26	Inf	-Inf	31.10	3	Vertical	6	2.54	-
2437MHz	Pass	AV	2.483667G	51.27	54.00	-2.73	31.27	3	Vertical	6	2.54	-
2437MHz	Pass	PK	2.389998G	67.65	74.00	-6.35	30.93	3	Vertical	6	2.54	-
2437MHz	Pass	PK	2.443957G	111.19	Inf	-Inf	31.13	3	Vertical	6	2.54	-
2437MHz	Pass	PK	2.490623G	65.08	74.00	-8.92	31.30	3	Vertical	6	2.54	-
2437MHz	Pass	AV	4.874G	31.99	54.00	-22.01	2.32	3	Horizontal	349	1.25	-
2437MHz	Pass	PK	4.874G	44.54	74.00	-29.46	2.32	3	Horizontal	349	1.25	-
2437MHz	Pass	AV	4.874G	32.16	54.00	-21.84	2.32	3	Vertical	174	1.92	-
2437MHz	Pass	PK	4.874G	43.76	74.00	-30.24	2.32	3	Vertical	174	1.92	-
2452MHz	Pass	AV	2.352G	48.37	54.00	-5.63	30.80	3	Horizontal	358	1.50	-
2452MHz	Pass	AV	2.456638G	97.41	Inf	-Inf	31.17	3	Horizontal	358	1.50	-
2452MHz	Pass	AV	2.483594G	52.17	54.00	-1.83	31.27	3	Horizontal	358	1.50	-
2452MHz	Pass	PK	2.355478G	63.25	74.00	-10.75	30.81	3	Horizontal	358	1.50	-
2452MHz	Pass	PK	2.455478G	106.56	Inf	-Inf	31.17	3	Horizontal	358	1.50	-
2452MHz	Pass	PK	2.483884G	69.48	74.00	-4.52	31.27	3	Horizontal	358	1.50	-
2452MHz	Pass	AV	2.381565G	49.67	54.00	-4.33	30.91	3	Vertical	12	2.27	-
2452MHz	Pass	AV	2.456058G	98.40	Inf	-Inf	31.17	3	Vertical	12	2.27	-
2452MHz	Pass	AV	2.483594G	53.80	54.00	-0.20	31.27	3	Vertical	12	2.27	-
2452MHz	Pass	PK	2.363014G	64.30	74.00	-9.70	30.84	3	Vertical	12	2.27	-
2452MHz	Pass	PK	2.446493G	108.14	Inf	-Inf	31.14	3	Vertical	12	2.27	-
2452MHz	Pass	PK	2.483884G	70.09	74.00	-3.91	31.27	3	Vertical	12	2.27	-
2452MHz	Pass	AV	4.904G	31.55	54.00	-22.45	2.41	3	Horizontal	269	2.40	-
2452MHz	Pass	PK	4.904G	43.85	74.00	-30.15	2.41	3	Horizontal	269	2.40	-
2452MHz	Pass	AV	4.904G	32.18	54.00	-21.82	2.41	3	Vertical	86	1.04	-
2452MHz	Pass	PK	4.904G	44.23	74.00	-29.77	2.41	3	Vertical	86	1.04	-

802.11b_(1Mbps)_2TX

2412MHz_TX

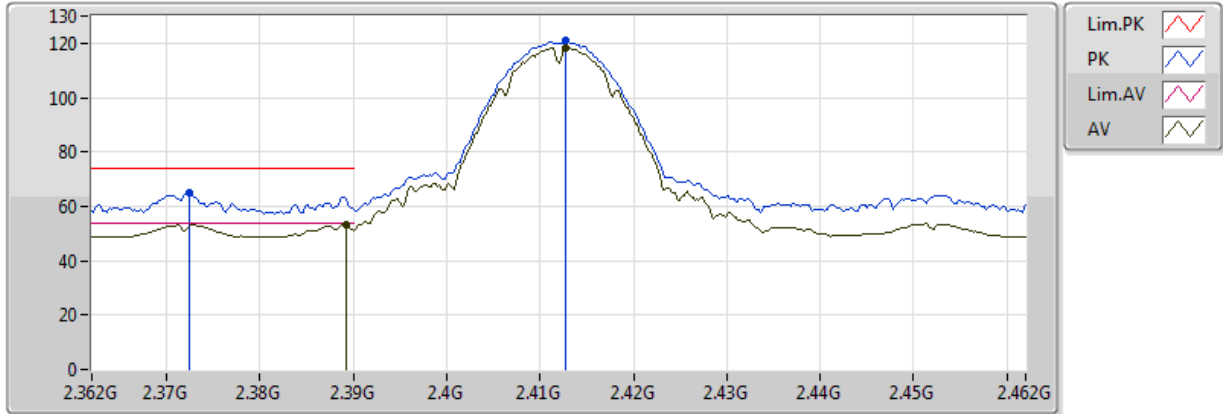

EUT = Y

Type	Freq (Hz)	Level (dBuV/m)	Limit (dBuV/m)	Margin (dB)	Factor (dB)	Dist (m)	Condition	Azimuth (°)	Height (m)	Comments	Raw (dBuV)	AF (dB)	CL (dB)	PA (dB)
AV	2.3892G	53.50	54.00	-0.50	30.93	3	Vertical	5	2.30	-	22.57	27.31	3.62	-
AV	2.4128G	118.45	Inf	-Inf	31.02	3	Vertical	5	2.30	-	87.44	27.37	3.64	-
PK	2.3724G	65.14	74.00	-8.86	30.87	3	Vertical	5	2.30	-	34.27	27.27	3.61	-
PK	2.4128G	121.03	Inf	-Inf	31.02	3	Vertical	5	2.30	-	90.02	27.37	3.64	-

802.11b_(1Mbps)_2TX

2412MHz_TX

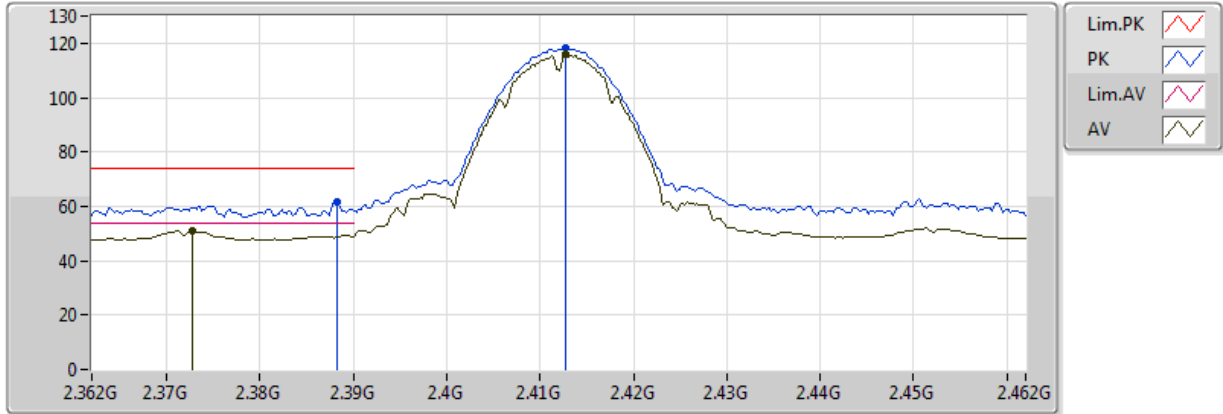

EUT = Y

Type	Freq (Hz)	Level (dBuV/m)	Limit (dBuV/m)	Margin (dB)	Factor (dB)	Dist (m)	Condition	Azimuth (°)	Height (m)	Comments	Raw (dBuV)	AF (dB)	CL (dB)	PA (dB)
AV	2.3728G	50.99	54.00	-3.01	30.87	3	Horizontal	10	1.50	-	20.12	27.27	3.61	-
AV	2.4128G	115.81	Inf	-Inf	31.02	3	Horizontal	10	1.50	-	84.80	27.37	3.64	-
PK	2.3882G	61.52	74.00	-12.48	30.93	3	Horizontal	10	1.50	-	30.59	27.31	3.62	-
PK	2.4128G	118.28	Inf	-Inf	31.02	3	Horizontal	10	1.50	-	87.26	27.37	3.64	-

802.11b_(1Mbps)_2TX

2412MHz_TX

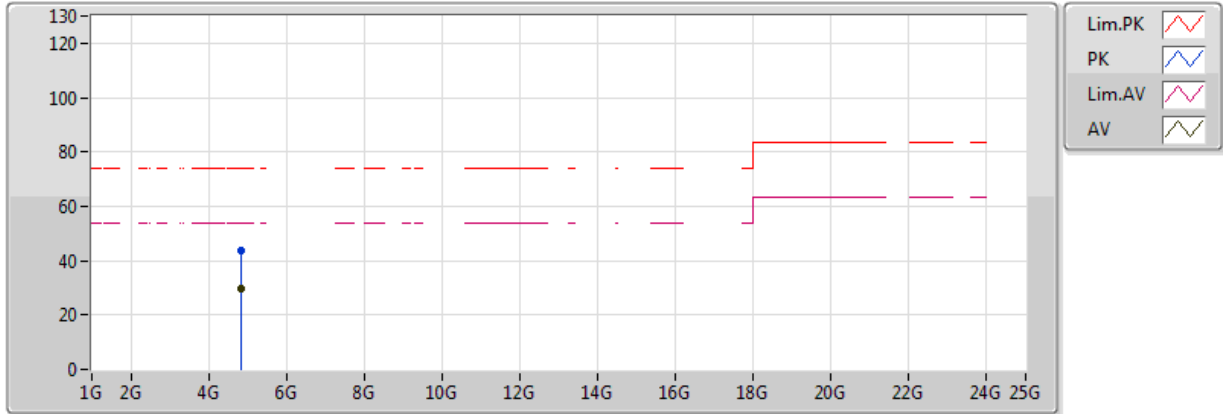

EUT = Y

Type	Freq (Hz)	Level (dBuV/m)	Limit (dBuV/m)	Margin (dB)	Factor (dB)	Dist (m)	Condition	Azimuth (°)	Height (m)	Comments	Raw (dBuV)	AF (dB)	CL (dB)	PA (dB)
AV	4.824G	29.57	54.00	-24.43	2.16	3	Vertical	93	2.27	-	27.41	31.28	5.41	34.53
PK	4.824G	43.78	74.00	-30.22	2.16	3	Vertical	93	2.27	-	41.62	31.28	5.41	34.53

802.11b_(1Mbps)_2TX

2412MHz_TX

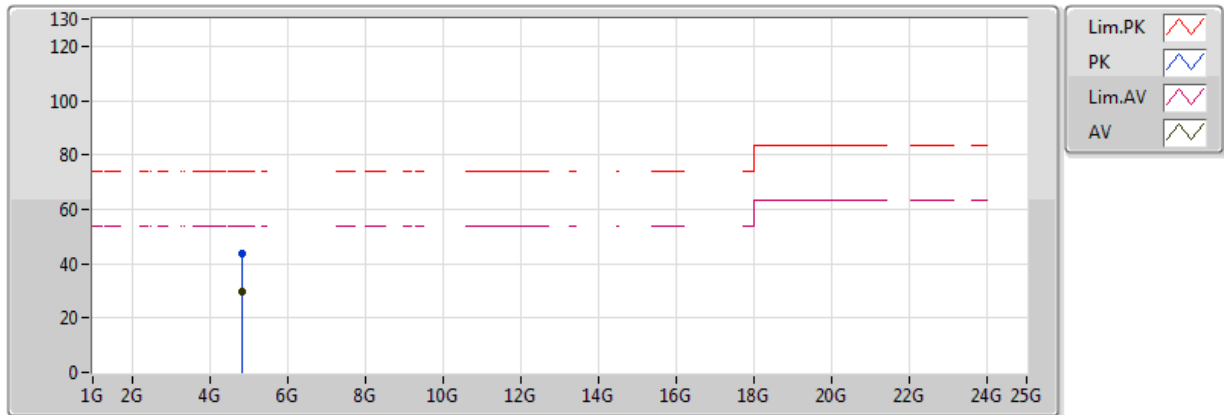

EUT = Y

Type	Freq (Hz)	Level (dBuV/m)	Limit (dBuV/m)	Margin (dB)	Factor (dB)	Dist (m)	Condition	Azimuth (°)	Height (m)	Comments	Raw (dBuV)	AF (dB)	CL (dB)	PA (dB)
AV	4.824G	29.74	54.00	-24.26	2.16	3	Horizontal	165	1.50	-	27.58	31.28	5.41	34.53
PK	4.824G	43.67	74.00	-30.33	2.16	3	Horizontal	165	1.50	-	41.51	31.28	5.41	34.53

802.11b_(1Mbps)_2TX

2437MHz_TX

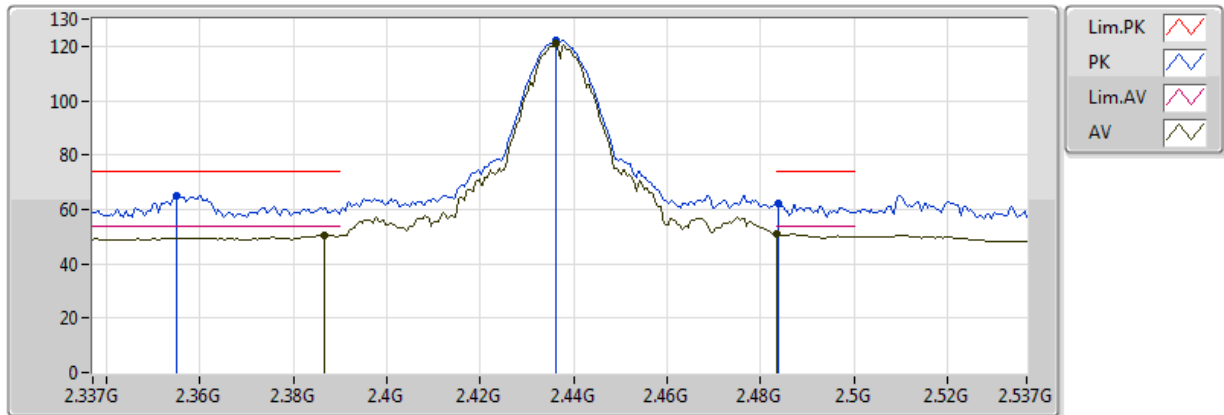

EUT = Y

Type	Freq (Hz)	Level (dBuV/m)	Limit (dBuV/m)	Margin (dB)	Factor (dB)	Dist (m)	Condition	Azimuth (°)	Height (m)	Comments	Raw (dBuV)	AF (dB)	CL (dB)	PA (dB)
AV	2.3866G	50.35	54.00	-3.65	30.92	3	Vertical	9	2.57	-	19.43	27.31	3.62	-
AV	2.4362G	120.85	Inf	-Inf	31.10	3	Vertical	9	2.57	-	89.75	27.43	3.67	-
AV	2.483502G	50.97	54.00	-3.03	31.27	3	Vertical	9	2.57	-	19.69	27.56	3.71	-
PK	2.355G	65.15	74.00	-8.85	30.81	3	Vertical	9	2.57	-	34.34	27.22	3.59	-
PK	2.4362G	122.33	Inf	-Inf	31.10	3	Vertical	9	2.57	-	91.23	27.43	3.67	-
PK	2.4838G	62.20	74.00	-11.80	31.27	3	Vertical	9	2.57	-	30.93	27.56	3.71	-

802.11b_(1Mbps)_2TX

2437MHz_TX

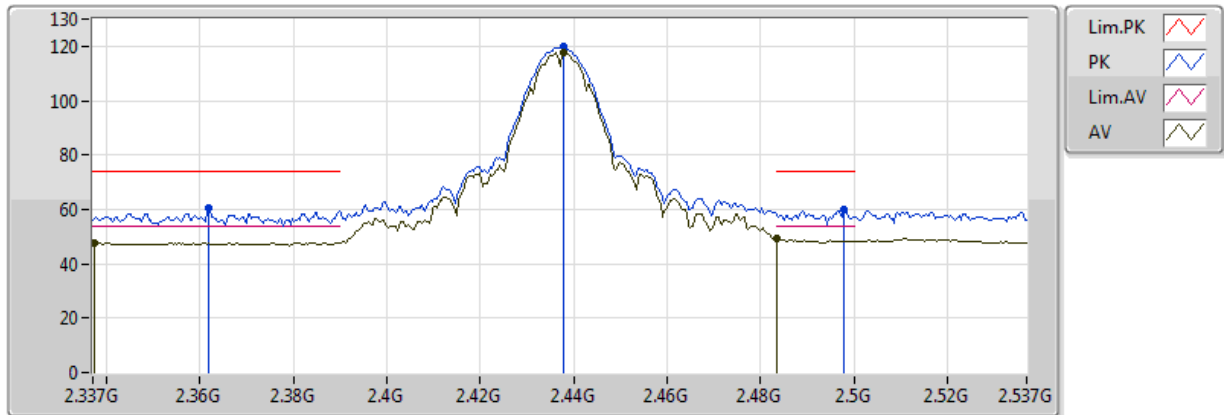

EUT = Y

Type	Freq (Hz)	Level (dBuV/m)	Limit (dBuV/m)	Margin (dB)	Factor (dB)	Dist (m)	Condition	Azimuth (°)	Height (m)	Comments	Raw (dBuV)	AF (dB)	CL (dB)	PA (dB)
AV	2.3374G	47.79	54.00	-6.21	30.75	3	Horizontal	0	1.63	-	17.04	27.18	3.57	-
AV	2.4378G	117.89	Inf	-Inf	31.11	3	Horizontal	0	1.63	-	86.78	27.44	3.67	-
AV	2.483502G	49.17	54.00	-4.83	31.27	3	Horizontal	0	1.63	-	17.90	27.56	3.71	-
PK	2.3618G	60.59	74.00	-13.41	30.84	3	Horizontal	0	1.63	-	29.75	27.24	3.60	-
PK	2.4378G	119.97	Inf	-Inf	31.11	3	Horizontal	0	1.63	-	88.87	27.44	3.67	-
PK	2.4978G	59.88	74.00	-14.12	31.32	3	Horizontal	0	1.63	-	28.56	27.59	3.73	-

802.11b_(1Mbps)_2TX

2437MHz_TX

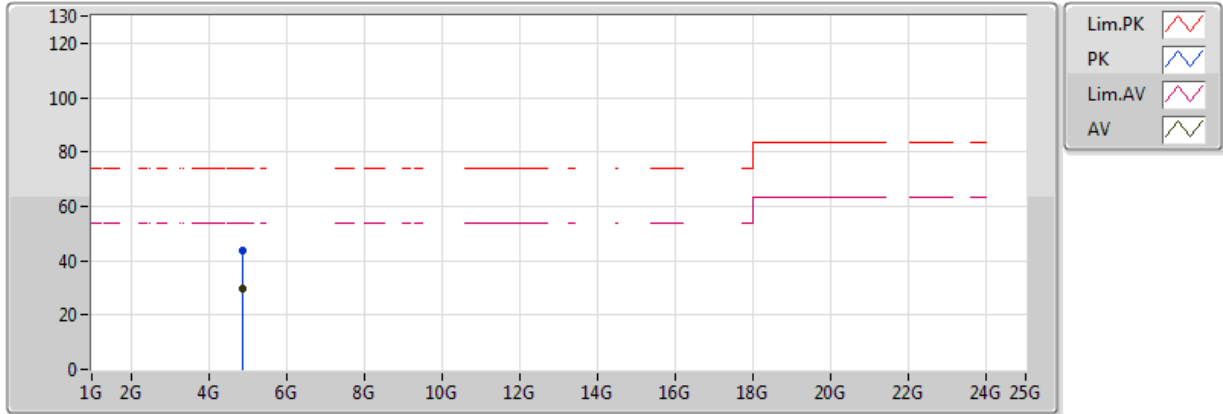

EUT = Y

Type	Freq (Hz)	Level (dBuV/m)	Limit (dBuV/m)	Margin (dB)	Factor (dB)	Dist (m)	Condition	Azimuth (°)	Height (m)	Comments	Raw (dBuV)	AF (dB)	CL (dB)	PA (dB)
AV	4.874G	29.78	54.00	-24.22	2.32	3	Vertical	30	1.51	-	27.46	31.37	5.46	34.52
PK	4.874G	43.45	74.00	-30.55	2.32	3	Vertical	30	1.51	-	41.13	31.37	5.46	34.52

802.11b_(1Mbps)_2TX

2437MHz_TX

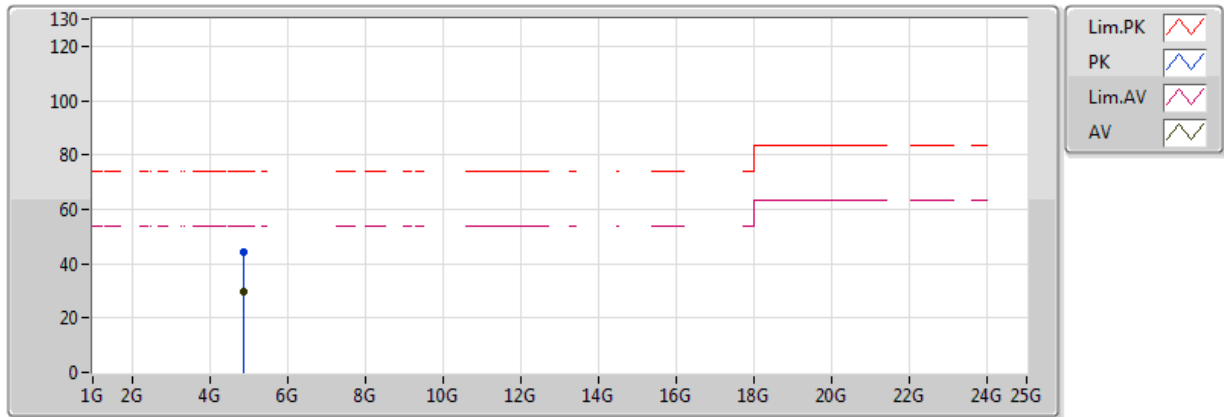

EUT = Y

Type	Freq (Hz)	Level (dBuV/m)	Limit (dBuV/m)	Margin (dB)	Factor (dB)	Dist (m)	Condition	Azimuth (°)	Height (m)	Comments	Raw (dBuV)	AF (dB)	CL (dB)	PA (dB)
AV	4.874G	29.76	54.00	-24.24	2.32	3	Horizontal	95	1.70	-	27.44	31.37	5.46	34.52
PK	4.874G	44.35	74.00	-29.65	2.32	3	Horizontal	95	1.70	-	42.03	31.37	5.46	34.52

802.11b_(1Mbps)_2TX

2462MHz_TX

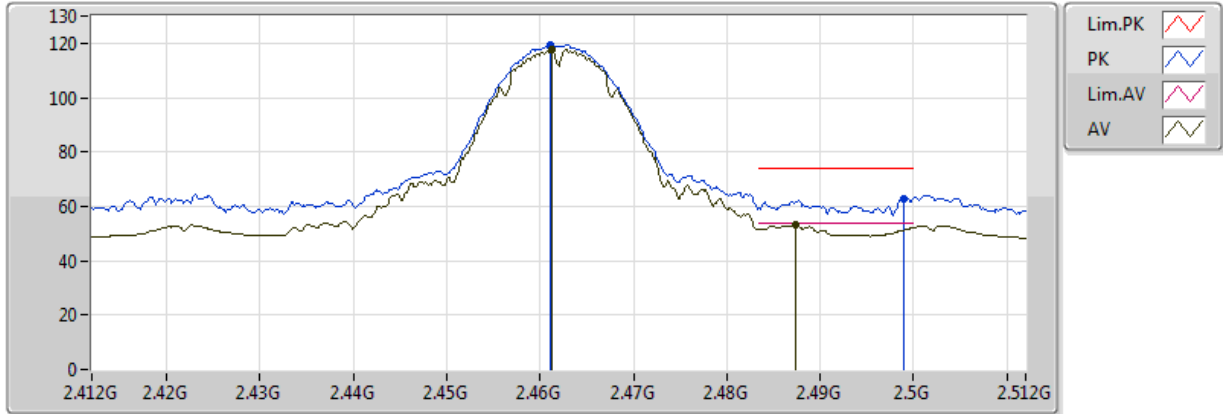

EUT = Y

Type	Freq (Hz)	Level (dBuV/m)	Limit (dBuV/m)	Margin (dB)	Factor (dB)	Dist (m)	Condition	Azimuth (°)	Height (m)	Comments	Raw (dBuV)	AF (dB)	CL (dB)	PA (dB)
AV	2.461275G	117.58	Inf	-Inf	31.19	3	Vertical	11	2.67	-	86.39	27.50	3.69	-
AV	2.487362G	53.06	54.00	-0.94	31.28	3	Vertical	11	2.67	-	21.77	27.57	3.72	-
PK	2.46113G	119.33	Inf	-Inf	31.19	3	Vertical	11	2.67	-	88.14	27.50	3.69	-
PK	2.498957G	63.02	74.00	-10.98	31.33	3	Vertical	11	2.67	-	31.70	27.60	3.73	-

802.11b_(1Mbps)_2TX

2462MHz_TX

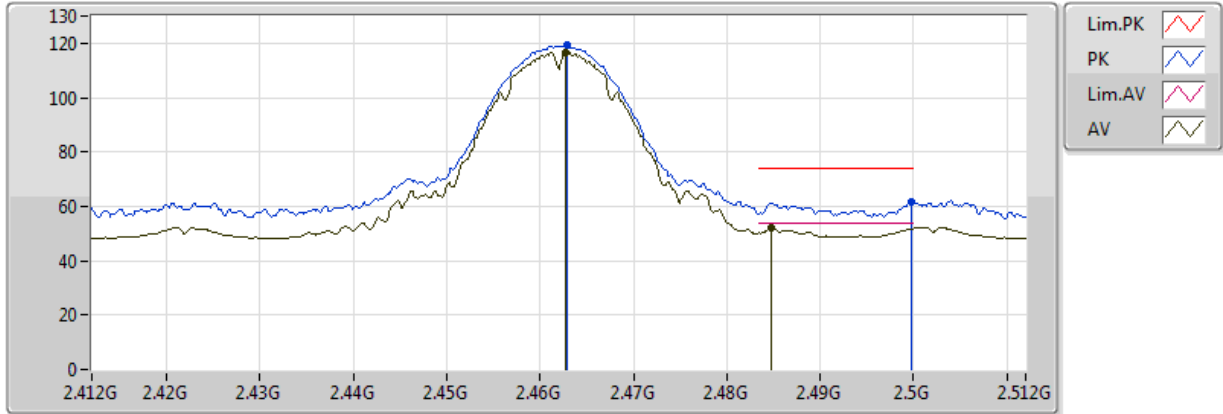

EUT = Y

Type	Freq (Hz)	Level (dBuV/m)	Limit (dBuV/m)	Margin (dB)	Factor (dB)	Dist (m)	Condition	Azimuth (°)	Height (m)	Comments	Raw (dBuV)	AF (dB)	CL (dB)	PA (dB)
AV	2462725G	116.80	Inf	-Inf	31.20	3	Horizontal	12	1.34	-	85.60	27.50	3.69	-
AV	2484754G	51.98	54.00	-2.02	31.28	3	Horizontal	12	1.34	-	20.70	27.56	3.71	-
PK	246287G	119.31	Inf	-Inf	31.20	3	Horizontal	12	1.34	-	88.11	27.50	3.69	-
PK	2499826G	61.62	74.00	-12.38	31.33	3	Horizontal	12	1.34	-	30.29	27.60	3.73	-

802.11b_(1Mbps)_2TX

2462MHz_TX

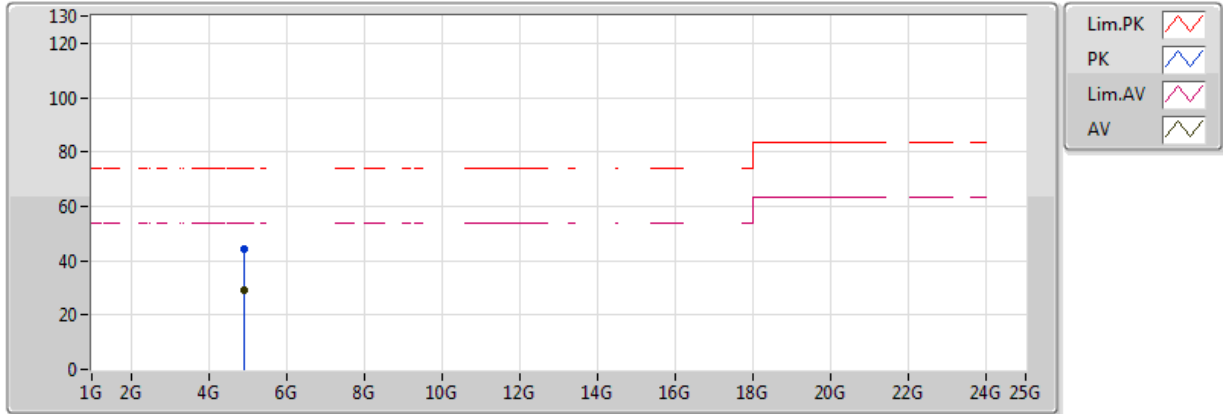

EUT = Y

Type	Freq (Hz)	Level (dBuV/m)	Limit (dBuV/m)	Margin (dB)	Factor (dB)	Dist (m)	Condition	Azimuth (°)	Height (m)	Comments	Raw (dBuV)	AF (dB)	CL (dB)	PA (dB)
AV	4.924G	29.07	54.00	-24.93	1.77	3	Vertical	270	2.01	-	27.30	31.46	5.52	35.20
PK	4.924G	44.45	74.00	-29.55	1.77	3	Vertical	270	2.01	-	42.68	31.46	5.52	35.20

802.11b_(1Mbps)_2TX

2462MHz_TX

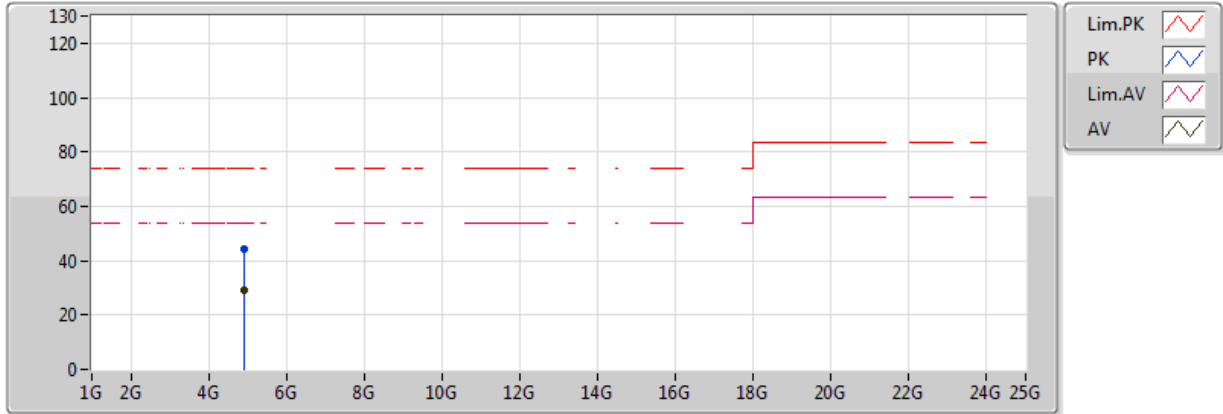

EUT = Y

Type	Freq (Hz)	Level (dBuV/m)	Limit (dBuV/m)	Margin (dB)	Factor (dB)	Dist (m)	Condition	Azimuth (°)	Height (m)	Comments	Raw (dBuV)	AF (dB)	CL (dB)	PA (dB)
AV	4.924G	28.97	54.00	-25.03	1.77	3	Horizontal	243	1.50	-	27.20	31.46	5.52	35.20
PK	4.924G	44.19	74.00	-29.81	1.77	3	Horizontal	243	1.50	-	42.42	31.46	5.52	35.20

802.11g_(6Mbps)_2TX

2412MHz_TX

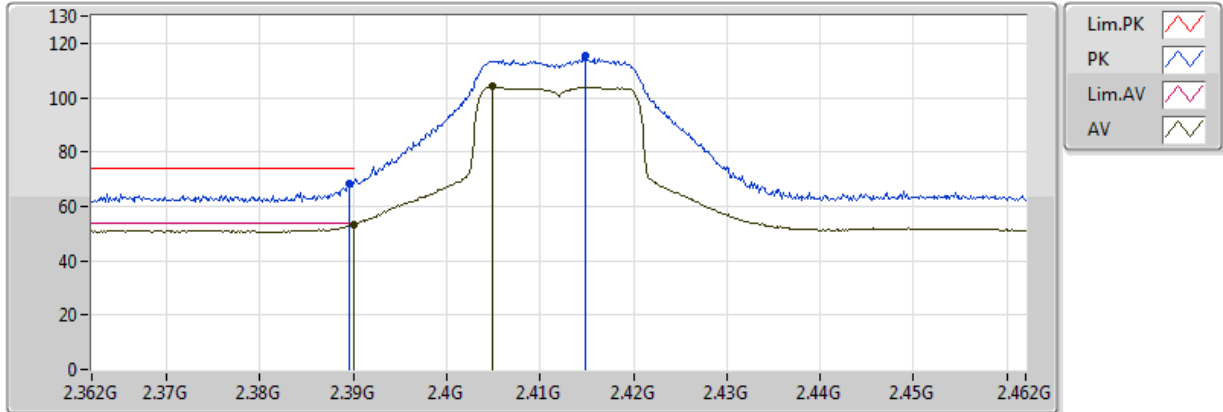

EUT = Y

Type	Freq (Hz)	Level (dBuV/m)	Limit (dBuV/m)	Margin (dB)	Factor (dB)	Dist (m)	Condition	Azimuth (°)	Height (m)	Comments	Raw (dBuV)	AF (dB)	CL (dB)	PA (dB)
AV	2.389998G	53.46	54.00	-0.54	30.93	3	Vertical	6	2.33	-	22.53	27.31	3.62	-
AV	2.404899G	104.11	Inf	-Inf	30.99	3	Vertical	6	2.33	-	73.13	27.35	3.63	-
PK	2.389536G	68.52	74.00	-5.48	30.93	3	Vertical	6	2.33	-	37.58	27.31	3.62	-
PK	2.414899G	115.38	Inf	-Inf	31.02	3	Vertical	6	2.33	-	84.36	27.38	3.64	-

802.11g_(6Mbps)_2TX

2412MHz_TX

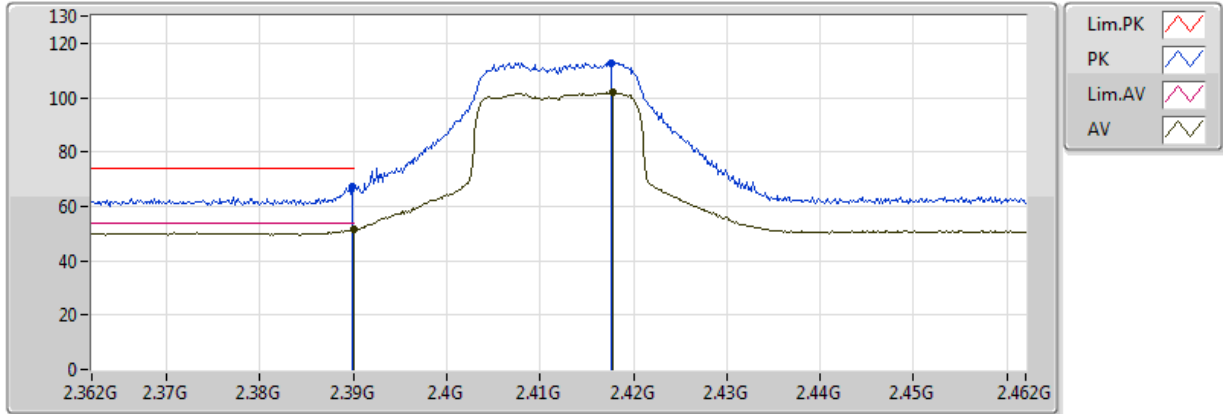

EUT = Y

Type	Freq (Hz)	Level (dBuV/m)	Limit (dBuV/m)	Margin (dB)	Factor (dB)	Dist (m)	Condition	Azimuth (°)	Height (m)	Comments	Raw (dBuV)	AF (dB)	CL (dB)	PA (dB)
AV	2.389998G	51.33	54.00	-2.67	30.93	3	Horizontal	1	1.50	-	20.39	27.31	3.62	-
AV	2.417797G	101.94	Inf	-Inf	31.03	3	Horizontal	1	1.50	-	70.91	27.39	3.65	-
PK	2.389826G	67.40	74.00	-6.60	30.93	3	Horizontal	1	1.50	-	36.46	27.31	3.62	-
PK	2.417652G	112.83	Inf	-Inf	31.03	3	Horizontal	1	1.50	-	81.79	27.39	3.65	-

802.11g_(6Mbps)_2TX

2412MHz_TX

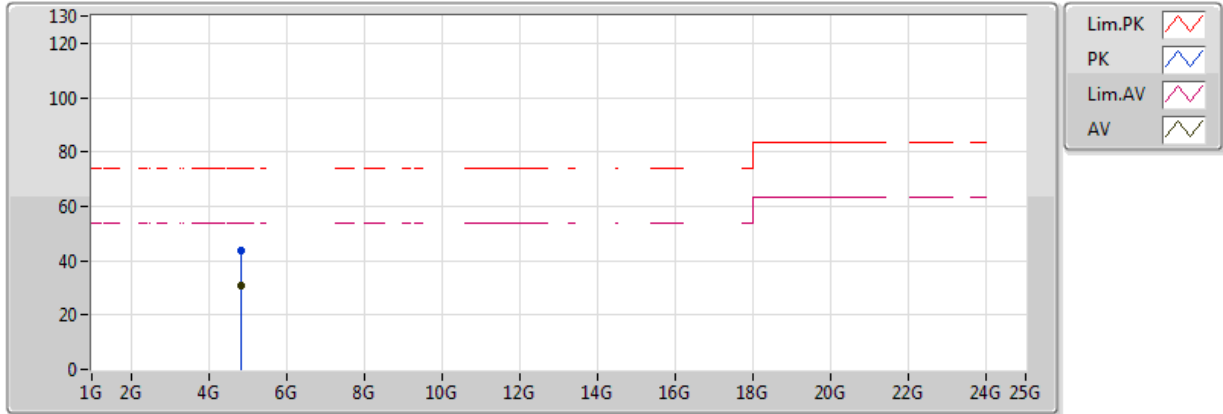

EUT = Y

Type	Freq (Hz)	Level (dBuV/m)	Limit (dBuV/m)	Margin (dB)	Factor (dB)	Dist (m)	Condition	Azimuth (°)	Height (m)	Comments	Raw (dBuV)	AF (dB)	CL (dB)	PA (dB)
AV	4.824G	30.69	54.00	-23.31	2.16	3	Vertical	193	2.21	-	28.53	31.28	5.41	34.53
PK	4.824G	43.52	74.00	-30.48	2.16	3	Vertical	193	2.21	-	41.36	31.28	5.41	34.53

802.11g_(6Mbps)_2TX

2412MHz_TX

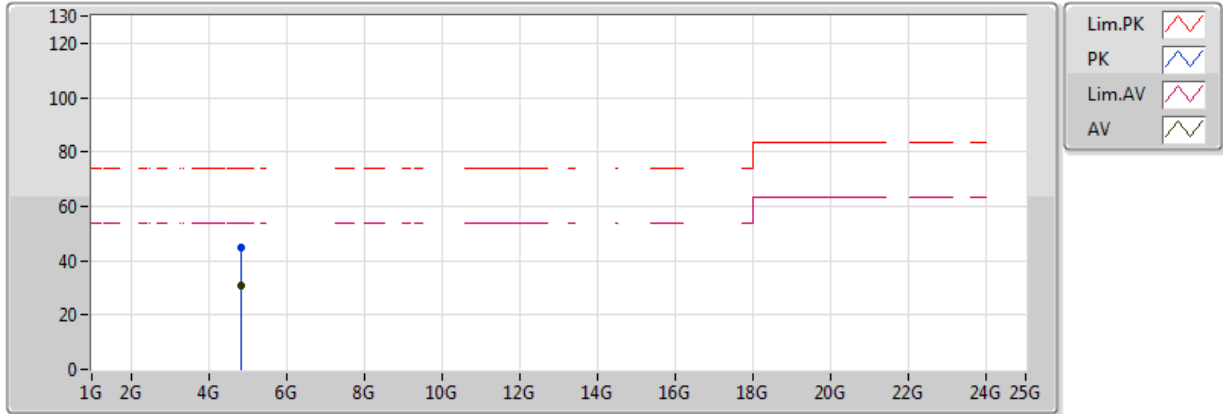

EUT = Y

Type	Freq (Hz)	Level (dBuV/m)	Limit (dBuV/m)	Margin (dB)	Factor (dB)	Dist (m)	Condition	Azimuth (°)	Height (m)	Comments	Raw (dBuV)	AF (dB)	CL (dB)	PA (dB)
AV	4.824G	30.77	54.00	-23.23	2.16	3	Horizontal	222	2.11	-	28.61	31.28	5.41	34.53
PK	4.824G	44.68	74.00	-29.32	2.16	3	Horizontal	222	2.11	-	42.52	31.28	5.41	34.53

802.11g_(6Mbps)_2TX

2437MHz_TX

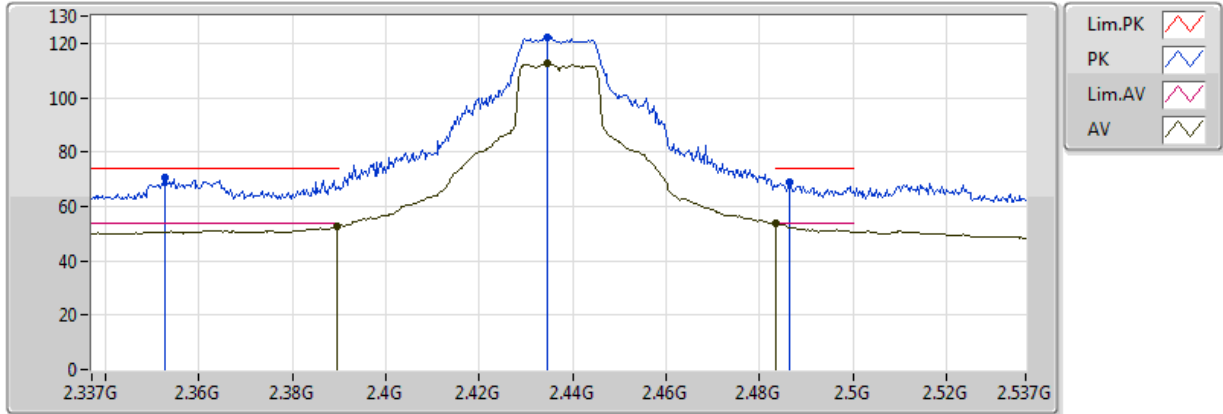

EUT = Y

Type	Freq (Hz)	Level (dBuV/m)	Limit (dBuV/m)	Margin (dB)	Factor (dB)	Dist (m)	Condition	Azimuth (°)	Height (m)	Comments	Raw (dBuV)	AF (dB)	CL (dB)	PA (dB)
AV	2.389464G	52.92	54.00	-1.08	30.93	3	Vertical	6	2.09	-	21.99	27.31	3.62	-
AV	2.434391G	112.39	Inf	-Inf	31.09	3	Vertical	6	2.09	-	81.29	27.43	3.66	-
AV	2.483502G	53.58	54.00	-0.42	31.27	3	Vertical	6	2.09	-	22.31	27.56	3.71	-
PK	2.352652G	70.35	74.00	-3.65	30.80	3	Vertical	6	2.09	-	39.54	27.22	3.59	-
PK	2.434391G	122.19	Inf	-Inf	31.09	3	Vertical	6	2.09	-	91.10	27.43	3.66	-
PK	2.486275G	68.75	74.00	-5.25	31.28	3	Vertical	6	2.09	-	37.47	27.56	3.72	-

802.11g_(6Mbps)_2TX

2437MHz_TX

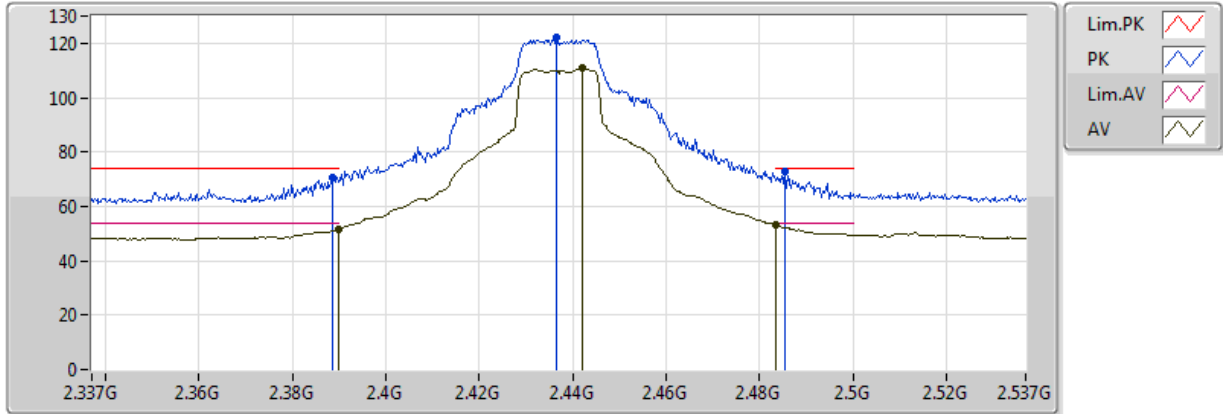

EUT = Y

Type	Freq (Hz)	Level (dBuV/m)	Limit (dBuV/m)	Margin (dB)	Factor (dB)	Dist (m)	Condition	Azimuth (°)	Height (m)	Comments	Raw (dBuV)	AF (dB)	CL (dB)	PA (dB)
AV	2.389998G	51.65	54.00	-2.35	30.93	3	Horizontal	13	1.39	-	20.71	27.31	3.62	-
AV	2.441928G	111.11	Inf	-Inf	31.12	3	Horizontal	13	1.39	-	79.99	27.45	3.67	-
AV	2.483502G	53.19	54.00	-0.81	31.27	3	Horizontal	13	1.39	-	21.92	27.56	3.71	-
PK	2.388594G	70.68	74.00	-3.32	30.93	3	Horizontal	13	1.39	-	39.75	27.31	3.62	-
PK	2.43642G	122.19	Inf	-Inf	31.10	3	Horizontal	13	1.39	-	91.09	27.43	3.67	-
PK	2.485406G	72.83	74.00	-1.17	31.28	3	Horizontal	13	1.39	-	41.55	27.56	3.72	-

802.11g_(6Mbps)_2TX

2437MHz_TX

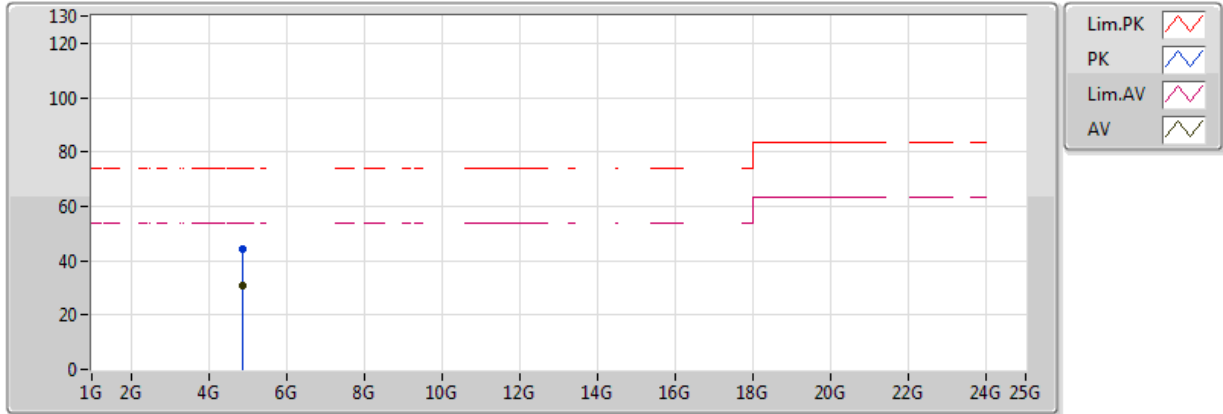

EUT = Y

Type	Freq (Hz)	Level (dBuV/m)	Limit (dBuV/m)	Margin (dB)	Factor (dB)	Dist (m)	Condition	Azimuth (°)	Height (m)	Comments	Raw (dBuV)	AF (dB)	CL (dB)	PA (dB)
AV	4.874G	30.60	54.00	-23.40	2.32	3	Vertical	31	1.01	-	28.28	31.37	5.46	34.52
PK	4.874G	44.41	74.00	-29.59	2.32	3	Vertical	31	1.01	-	42.09	31.37	5.46	34.52

802.11g_(6Mbps)_2TX

2437MHz_TX

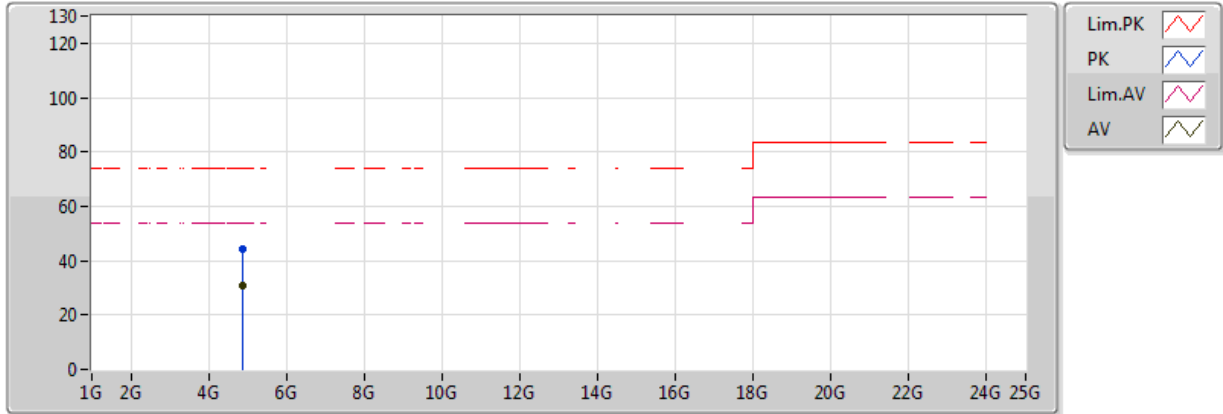

EUT = Y

Type	Freq (Hz)	Level (dBuV/m)	Limit (dBuV/m)	Margin (dB)	Factor (dB)	Dist (m)	Condition	Azimuth (°)	Height (m)	Comments	Raw (dBuV)	AF (dB)	CL (dB)	PA (dB)
AV	4.874G	30.81	54.00	-23.19	2.32	3	Horizontal	62	1.11	-	28.49	31.37	5.46	34.52
PK	4.874G	44.27	74.00	-29.73	2.32	3	Horizontal	62	1.11	-	41.95	31.37	5.46	34.52

802.11g_(6Mbps)_2TX

2462MHz_TX

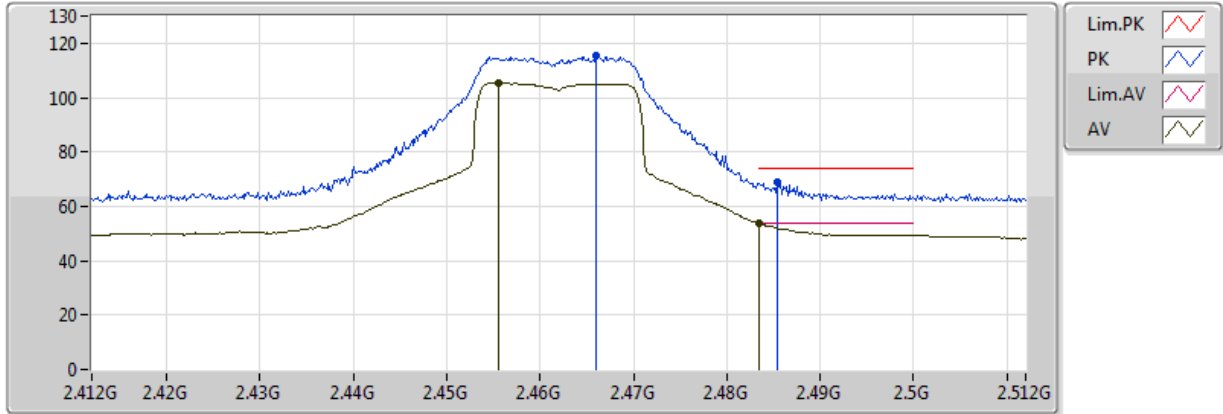

EUT = Y

Type	Freq (Hz)	Level (dBuV/m)	Limit (dBuV/m)	Margin (dB)	Factor (dB)	Dist (m)	Condition	Azimuth (°)	Height (m)	Comments	Raw (dBuV)	AF (dB)	CL (dB)	PA (dB)
AV	2.455478G	105.50	Inf	-Inf	31.17	3	Vertical	12	2.04	-	74.33	27.48	3.69	-
AV	2.483502G	53.69	54.00	-0.31	31.27	3	Vertical	12	2.04	-	22.42	27.56	3.71	-
PK	2.466058G	115.19	Inf	-Inf	31.21	3	Vertical	12	2.04	-	83.99	27.51	3.70	-
PK	2.485333G	69.06	74.00	-4.94	31.28	3	Vertical	12	2.04	-	37.78	27.56	3.72	-

802.11g_(6Mbps)_2TX

2462MHz_TX

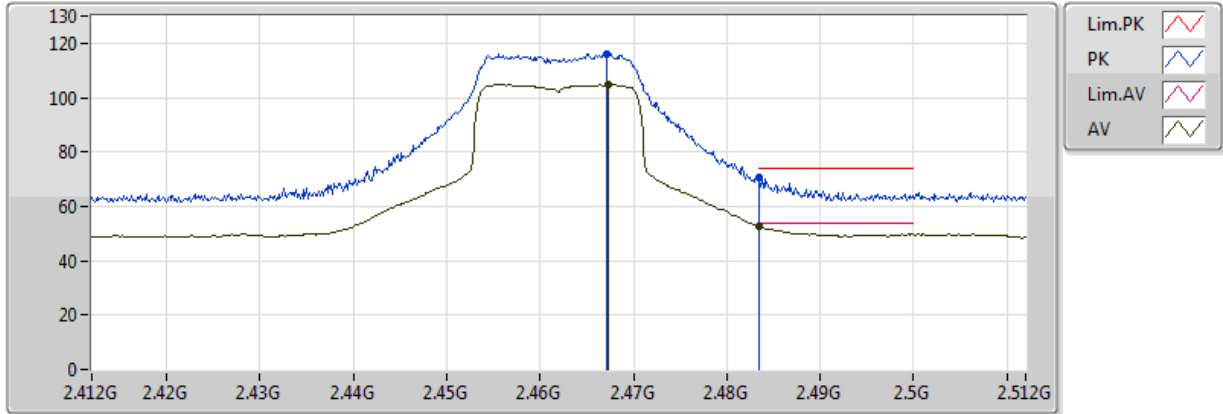

EUT = Y

Type	Freq (Hz)	Level (dBuV/m)	Limit (dBuV/m)	Margin (dB)	Factor (dB)	Dist (m)	Condition	Azimuth (°)	Height (m)	Comments	Raw (dBuV)	AF (dB)	CL (dB)	PA (dB)
AV	2.467362G	104.77	Inf	-Inf	31.21	3	Horizontal	9	1.63	-	73.56	27.52	3.70	-
AV	2.483502G	52.42	54.00	-1.58	31.27	3	Horizontal	9	1.63	-	21.15	27.56	3.71	-
PK	2.467217G	116.23	Inf	-Inf	31.21	3	Horizontal	9	1.63	-	85.01	27.51	3.70	-
PK	2.483502G	70.57	74.00	-3.43	31.27	3	Horizontal	9	1.63	-	39.30	27.56	3.71	-

802.11g_(6Mbps)_2TX

2462MHz_TX

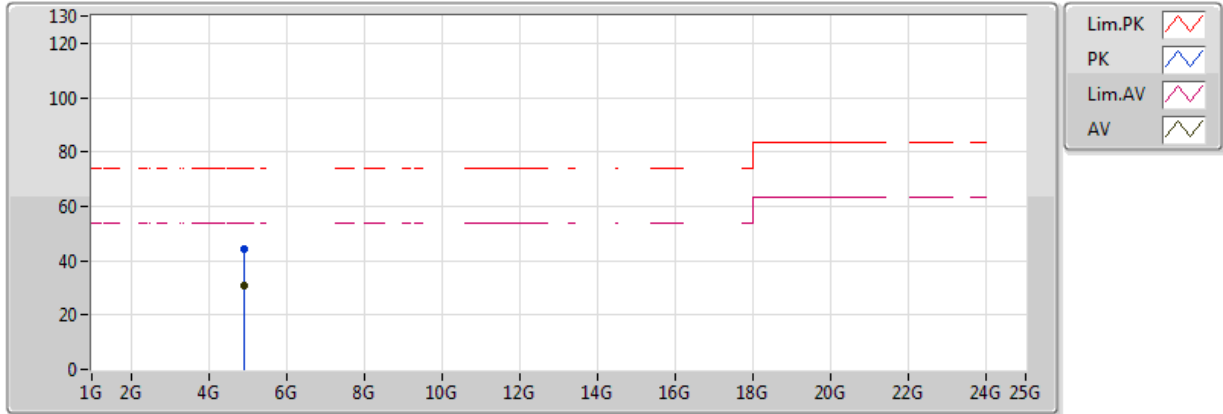

EUT = Y

Type	Freq (Hz)	Level (dBuV/m)	Limit (dBuV/m)	Margin (dB)	Factor (dB)	Dist (m)	Condition	Azimuth (°)	Height (m)	Comments	Raw (dBuV)	AF (dB)	CL (dB)	PA (dB)
AV	4.924G	31.09	54.00	-22.91	2.48	3	Vertical	340	2.42	-	28.61	31.46	5.52	34.50
PK	4.924G	44.20	74.00	-29.80	2.48	3	Vertical	340	2.42	-	41.72	31.46	5.52	34.50

802.11g_(6Mbps)_2TX

2462MHz_TX

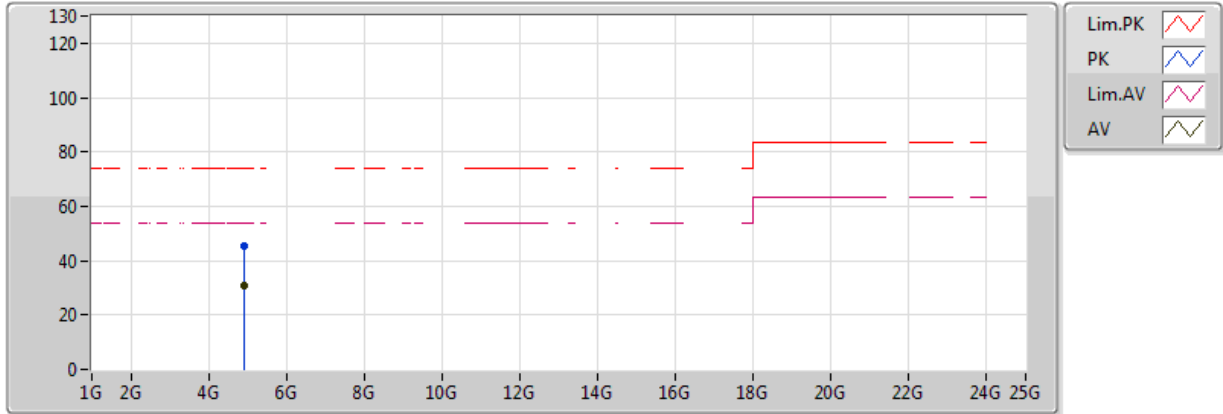

EUT = Y

Type	Freq (Hz)	Level (dBuV/m)	Limit (dBuV/m)	Margin (dB)	Factor (dB)	Dist (m)	Condition	Azimuth (°)	Height (m)	Comments	Raw (dBuV)	AF (dB)	CL (dB)	PA (dB)
AV	4.924G	31.00	54.00	-23.00	2.48	3	Horizontal	152	1.15	-	28.52	31.46	5.52	34.50
PK	4.924G	45.24	74.00	-28.76	2.48	3	Horizontal	152	1.15	-	42.76	31.46	5.52	34.50

802.11n HT20_Nss1,(MCS0)_2TX

2412MHz_TX

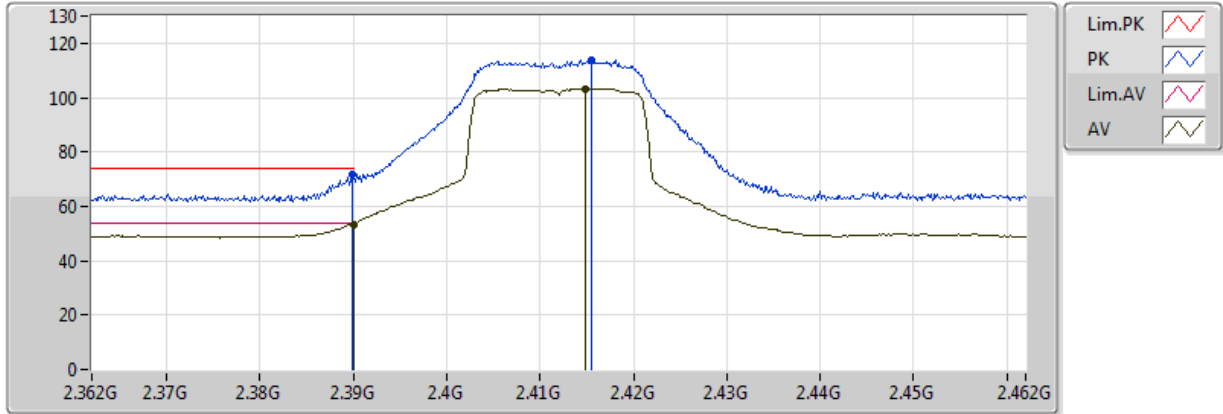

EUT = Y

Type	Freq (Hz)	Level (dBuV/m)	Limit (dBuV/m)	Margin (dB)	Factor (dB)	Dist (m)	Condition	Azimuth (°)	Height (m)	Comments	Raw (dBuV)	AF (dB)	CL (dB)	PA (dB)
AV	2.389998G	53.50	54.00	-0.50	30.93	3	Vertical	1	2.28	-	22.56	27.31	3.62	-
AV	2.414899G	103.38	Inf	-Inf	31.02	3	Vertical	1	2.28	-	72.36	27.38	3.64	-
PK	2.389826G	71.96	74.00	-2.04	30.93	3	Vertical	1	2.28	-	41.02	27.31	3.62	-
PK	2.415478G	113.72	Inf	-Inf	31.03	3	Vertical	1	2.28	-	82.70	27.38	3.65	-

802.11n HT20_Nss1,(MCS0)_2TX

2412MHz_TX

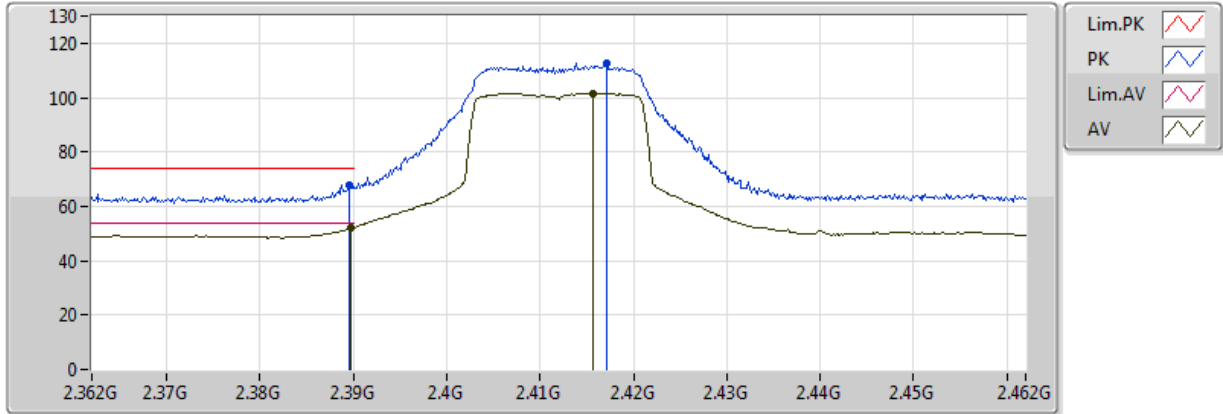

EUT = Y

Type	Freq (Hz)	Level (dBuV/m)	Limit (dBuV/m)	Margin (dB)	Factor (dB)	Dist (m)	Condition	Azimuth (°)	Height (m)	Comments	Raw (dBuV)	AF (dB)	CL (dB)	PA (dB)
AV	2.389681G	52.08	54.00	-1.92	30.93	3	Horizontal	9	1.50	-	21.15	27.31	3.62	-
AV	2.415623G	101.69	Inf	-Inf	31.03	3	Horizontal	9	1.50	-	70.66	27.38	3.65	-
PK	2.389536G	67.83	74.00	-6.17	30.93	3	Horizontal	9	1.50	-	36.90	27.31	3.62	-
PK	2.417217G	112.44	Inf	-Inf	31.03	3	Horizontal	9	1.50	-	81.40	27.38	3.65	-

**802.11n HT20_Nss1,(MCS0)_2TX
2412MHz_TX**

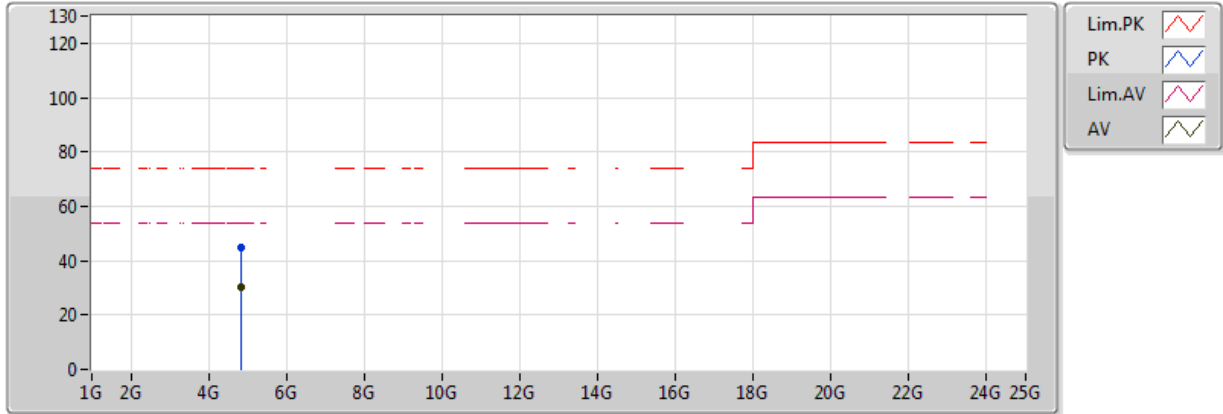

EUT = Y

Type	Freq (Hz)	Level (dBuV/m)	Limit (dBuV/m)	Margin (dB)	Factor (dB)	Dist (m)	Condition	Azimuth (°)	Height (m)	Comments	Raw (dBuV)	AF (dB)	CL (dB)	PA (dB)
AV	4.824G	30.49	54.00	-23.51	2.16	3	Vertical	37	1.90	-	28.33	31.28	5.41	34.53
PK	4.824G	44.93	74.00	-29.07	2.16	3	Vertical	37	1.90	-	42.77	31.28	5.41	34.53

**802.11n HT20_Nss1,(MCS0)_2TX
2412MHz_TX**

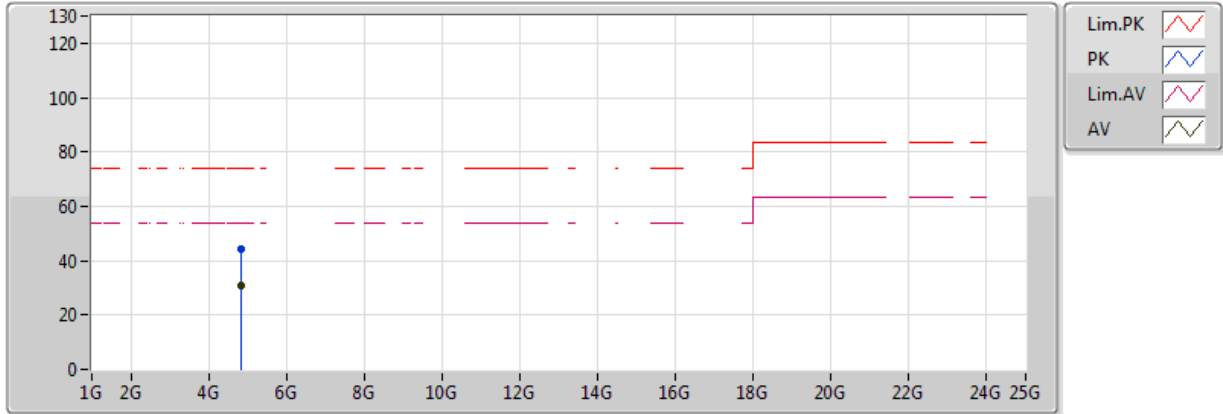

EUT = Y

Type	Freq (Hz)	Level (dBuV/m)	Limit (dBuV/m)	Margin (dB)	Factor (dB)	Dist (m)	Condition	Azimuth (°)	Height (m)	Comments	Raw (dBuV)	AF (dB)	CL (dB)	PA (dB)
AV	4.824G	30.58	54.00	-23.42	2.16	3	Horizontal	73	1.30	-	28.42	31.28	5.41	34.53
PK	4.824G	44.04	74.00	-29.96	2.16	3	Horizontal	73	1.30	-	41.88	31.28	5.41	34.53

802.11n HT20_Nss1,(MCS0)_2TX

2437MHz_TX

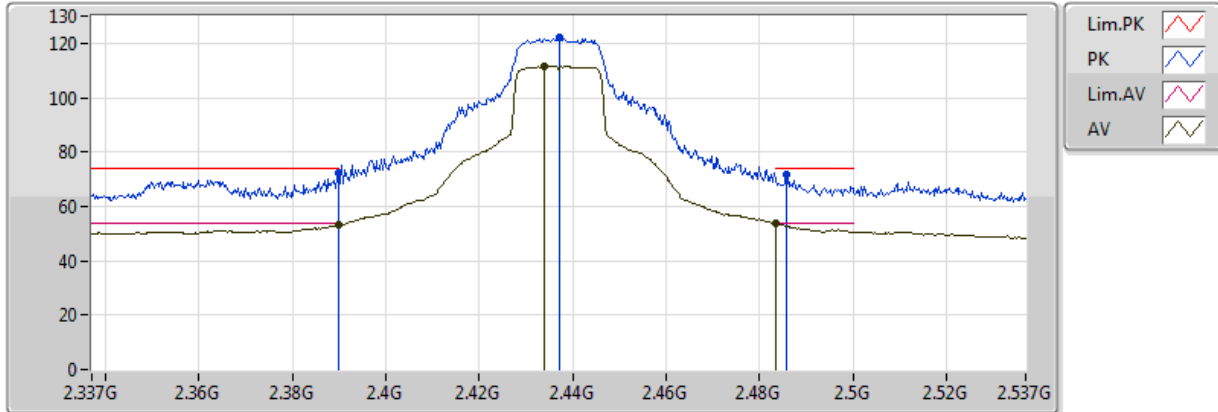

EUT = Y

Type	Freq (Hz)	Level (dBuV/m)	Limit (dBuV/m)	Margin (dB)	Factor (dB)	Dist (m)	Condition	Azimuth (°)	Height (m)	Comments	Raw (dBuV)	AF (dB)	CL (dB)	PA (dB)
AV	2.389998G	53.15	54.00	-0.85	30.93	3	Vertical	7	2.06	-	22.21	27.31	3.62	-
AV	2.433812G	111.78	Inf	-Inf	31.09	3	Vertical	7	2.06	-	80.68	27.43	3.66	-
AV	2.483502G	53.58	54.00	-0.42	31.27	3	Vertical	7	2.06	-	22.31	27.56	3.71	-
PK	2.389998G	72.27	74.00	-1.73	30.93	3	Vertical	7	2.06	-	41.34	27.31	3.62	-
PK	2.437G	122.24	Inf	-Inf	31.10	3	Vertical	7	2.06	-	91.14	27.44	3.67	-
PK	2.485696G	71.58	74.00	-2.42	31.28	3	Vertical	7	2.06	-	40.30	27.56	3.72	-

**802.11n HT20_Nss1,(MCS0)_2TX
2437MHz_TX**

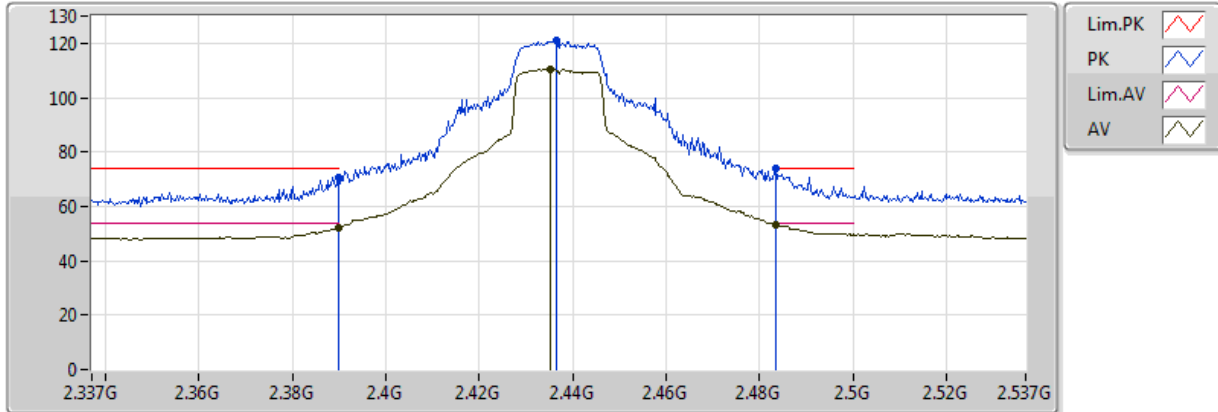

EUT = Y

Type	Freq (Hz)	Level (dBuV/m)	Limit (dBuV/m)	Margin (dB)	Factor (dB)	Dist (m)	Condition	Azimuth (°)	Height (m)	Comments	Raw (dBuV)	AF (dB)	CL (dB)	PA (dB)
AV	2.389754G	52.35	54.00	-1.65	30.93	3	Horizontal	9	1.50	-	21.42	27.31	3.62	-
AV	2.435261G	110.52	Inf	-Inf	31.10	3	Horizontal	9	1.50	-	79.42	27.43	3.67	-
AV	2.483502G	53.29	54.00	-0.71	31.27	3	Horizontal	9	1.50	-	22.02	27.56	3.71	-
PK	2.389754G	70.49	74.00	-3.51	30.93	3	Horizontal	9	1.50	-	39.55	27.31	3.62	-
PK	2.43642G	120.99	Inf	-Inf	31.10	3	Horizontal	9	1.50	-	89.89	27.43	3.67	-
PK	2.483502G	73.74	74.00	-0.26	31.27	3	Horizontal	9	1.50	-	42.47	27.56	3.71	-

802.11n HT20_Nss1,(MCS0)_2TX

2437MHz_TX

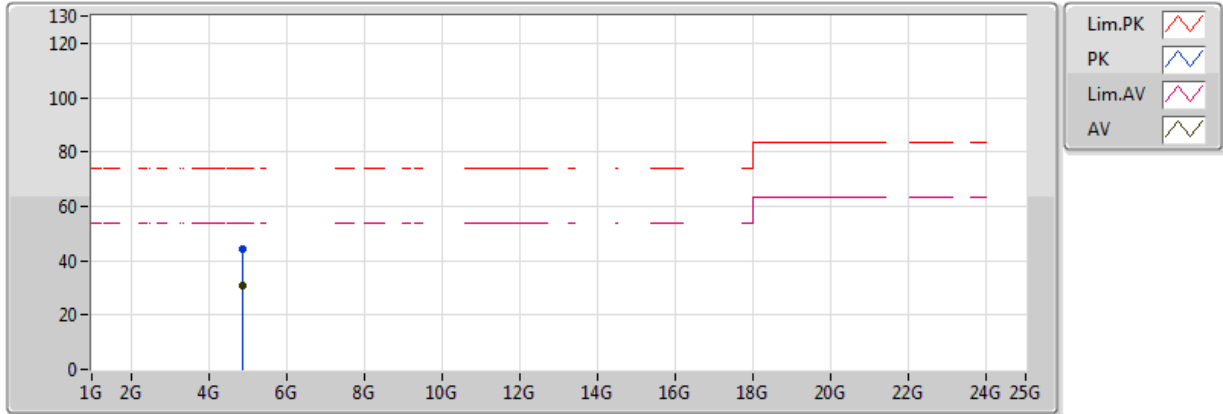

EUT = Y

Type	Freq (Hz)	Level (dBuV/m)	Limit (dBuV/m)	Margin (dB)	Factor (dB)	Dist (m)	Condition	Azimuth (°)	Height (m)	Comments	Raw (dBuV)	AF (dB)	CL (dB)	PA (dB)
AV	4.874G	30.70	54.00	-23.30	2.32	3	Vertical	59	1.25	-	28.38	31.37	5.46	34.52
PK	4.874G	44.26	74.00	-29.74	2.32	3	Vertical	59	1.25	-	41.94	31.37	5.46	34.52

802.11n HT20_Nss1,(MCS0)_2TX

2437MHz_TX

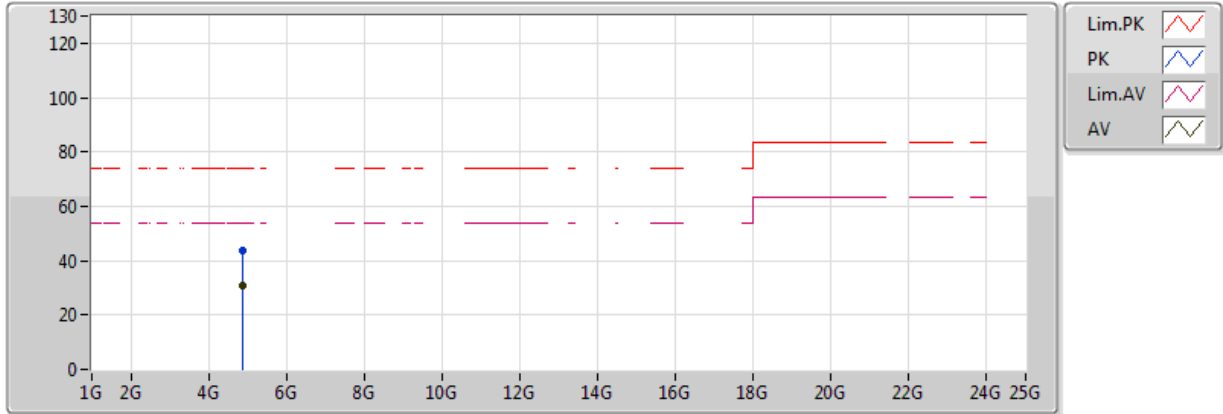

EUT = Y

Type	Freq (Hz)	Level (dBuV/m)	Limit (dBuV/m)	Margin (dB)	Factor (dB)	Dist (m)	Condition	Azimuth (°)	Height (m)	Comments	Raw (dBuV)	AF (dB)	CL (dB)	PA (dB)
AV	4.874G	30.90	54.00	-23.10	2.32	3	Horizontal	5	1.13	-	28.58	31.37	5.46	34.52
PK	4.874G	43.97	74.00	-30.03	2.32	3	Horizontal	5	1.13	-	41.65	31.37	5.46	34.52

802.11n HT20_Nss1,(MCS0)_2TX

2462MHz_TX

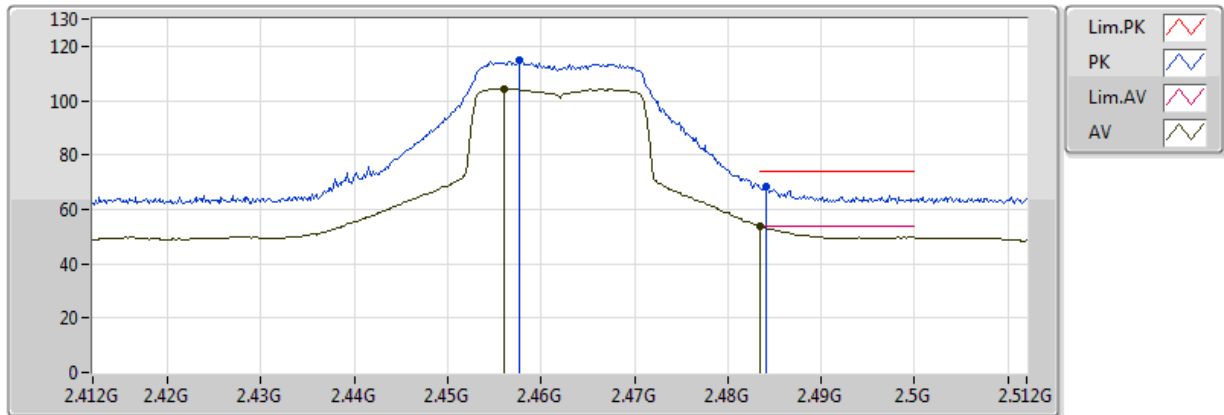

EUT = Y

Type	Freq (Hz)	Level (dBuV/m)	Limit (dBuV/m)	Margin (dB)	Factor (dB)	Dist (m)	Condition	Azimuth (°)	Height (m)	Comments	Raw (dBuV)	AF (dB)	CL (dB)	PA (dB)
AV	2.456058G	104.49	Inf	-Inf	31.17	3	Vertical	11	2.68	-	73.32	27.49	3.69	-
AV	2.483502G	53.56	54.00	-0.44	31.27	3	Vertical	11	2.68	-	22.29	27.56	3.71	-
PK	2.457652G	114.75	Inf	-Inf	31.18	3	Vertical	11	2.68	-	83.57	27.49	3.69	-
PK	2.484174G	68.29	74.00	-5.71	31.27	3	Vertical	11	2.68	-	37.01	27.56	3.71	-

802.11n HT20_Nss1,(MCS0)_2TX

2462MHz_TX

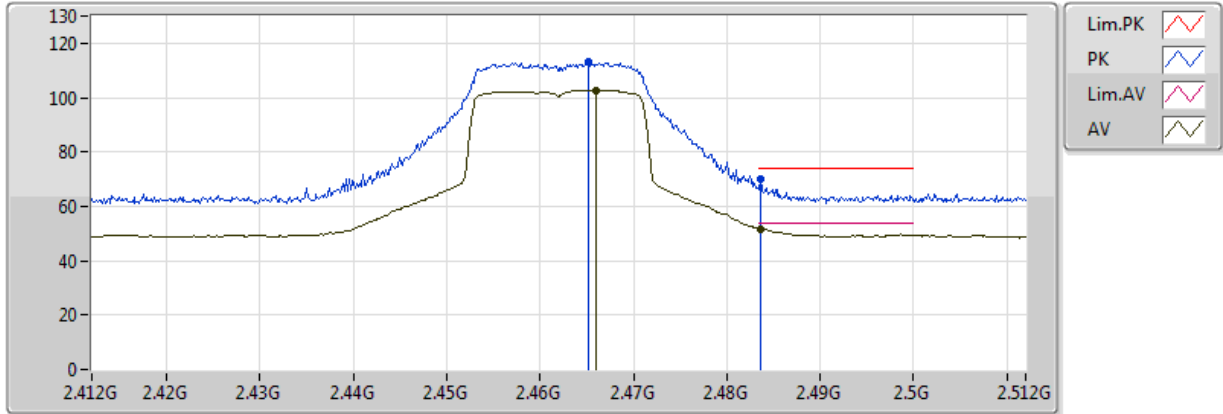

EUT = Y

Type	Freq (Hz)	Level (dBuV/m)	Limit (dBuV/m)	Margin (dB)	Factor (dB)	Dist (m)	Condition	Azimuth (°)	Height (m)	Comments	Raw (dBuV)	AF (dB)	CL (dB)	PA (dB)
AV	2.466058G	102.78	Inf	-Inf	31.21	3	Horizontal	2	1.50	-	71.57	27.51	3.70	-
AV	2.483594G	51.75	54.00	-2.25	31.27	3	Horizontal	2	1.50	-	20.48	27.56	3.71	-
PK	2.465188G	113.02	Inf	-Inf	31.20	3	Horizontal	2	1.50	-	81.81	27.51	3.70	-
PK	2.483594G	69.78	74.00	-4.22	31.27	3	Horizontal	2	1.50	-	38.51	27.56	3.71	-

802.11n HT20_Nss1,(MCS0)_2TX

2462MHz_TX

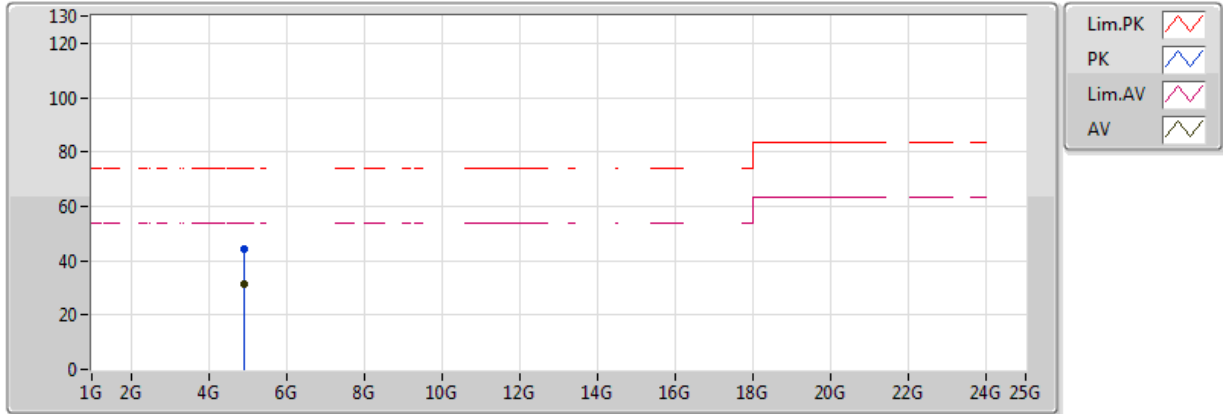

EUT = Y

Type	Freq (Hz)	Level (dBuV/m)	Limit (dBuV/m)	Margin (dB)	Factor (dB)	Dist (m)	Condition	Azimuth (°)	Height (m)	Comments	Raw (dBuV)	AF (dB)	CL (dB)	PA (dB)
AV	4.924G	31.14	54.00	-22.86	2.48	3	Vertical	91	1.10	-	28.66	31.46	5.52	34.50
PK	4.924G	44.38	74.00	-29.62	2.48	3	Vertical	91	1.10	-	41.90	31.46	5.52	34.50

802.11n HT20_Nss1,(MCS0)_2TX

2462MHz_TX

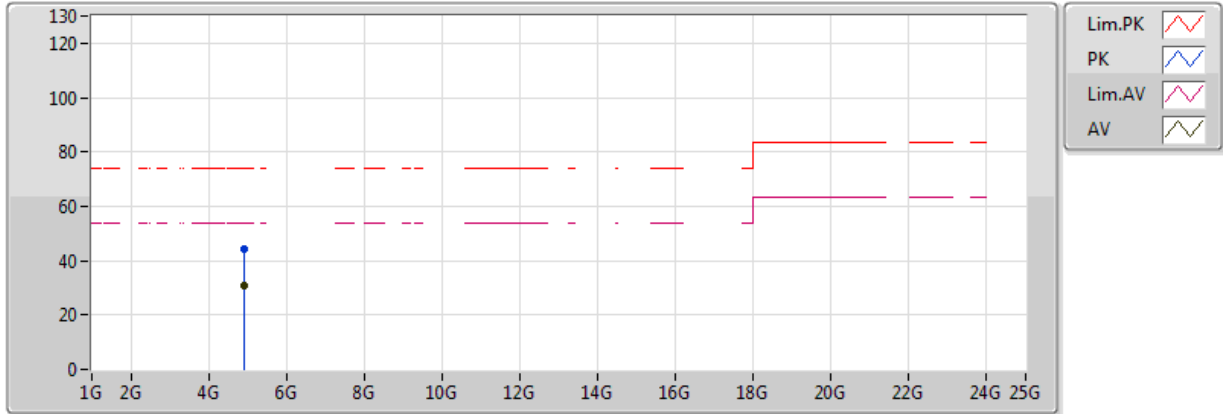

EUT = Y

Type	Freq (Hz)	Level (dBuV/m)	Limit (dBuV/m)	Margin (dB)	Factor (dB)	Dist (m)	Condition	Azimuth (°)	Height (m)	Comments	Raw (dBuV)	AF (dB)	CL (dB)	PA (dB)
AV	4.924G	30.90	54.00	-23.10	2.48	3	Horizontal	2	1.62	-	28.42	31.46	5.52	34.50
PK	4.924G	44.45	74.00	-29.55	2.48	3	Horizontal	2	1.62	-	41.97	31.46	5.52	34.50

802.11n HT40_Nss1,(MCS0)_2TX

2422MHz_TX

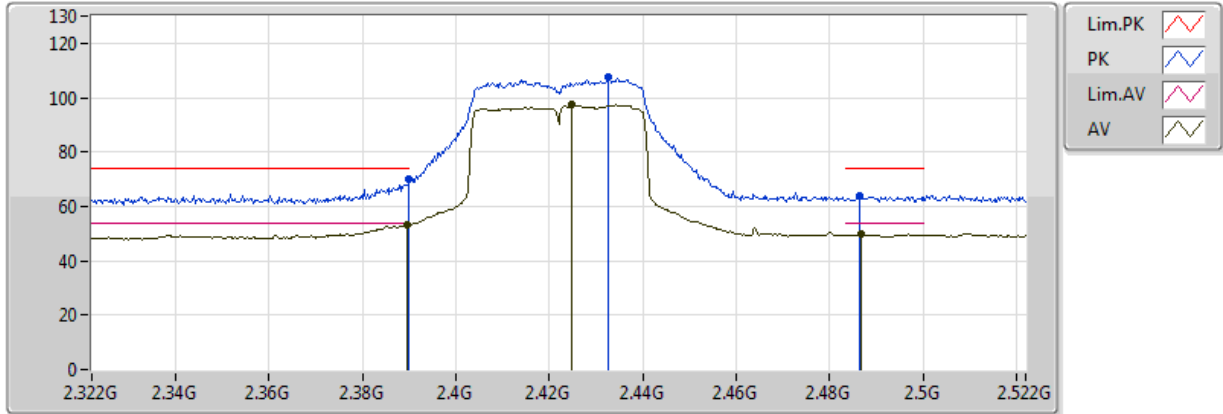

EUT = Y

Type	Freq (Hz)	Level (dBuV/m)	Limit (dBuV/m)	Margin (dB)	Factor (dB)	Dist (m)	Condition	Azimuth (°)	Height (m)	Comments	Raw (dBuV)	AF (dB)	CL (dB)	PA (dB)
AV	2.389536G	53.48	54.00	-0.52	30.93	3	Vertical	1	2.53	-	22.55	27.31	3.62	-
AV	2.424899G	97.24	Inf	-Inf	31.06	3	Vertical	1	2.53	-	66.18	27.40	3.65	-
AV	2.486638G	49.76	54.00	-4.24	31.28	3	Vertical	1	2.53	-	18.48	27.57	3.72	-
PK	2.389998G	70.08	74.00	-3.92	30.93	3	Vertical	1	2.53	-	39.14	27.31	3.62	-
PK	2.432725G	107.33	Inf	-Inf	31.09	3	Vertical	1	2.53	-	76.25	27.43	3.66	-
PK	2.486348G	63.91	74.00	-10.09	31.28	3	Vertical	1	2.53	-	32.63	27.56	3.72	-

802.11n HT40_Nss1,(MCS0)_2TX

2422MHz_TX

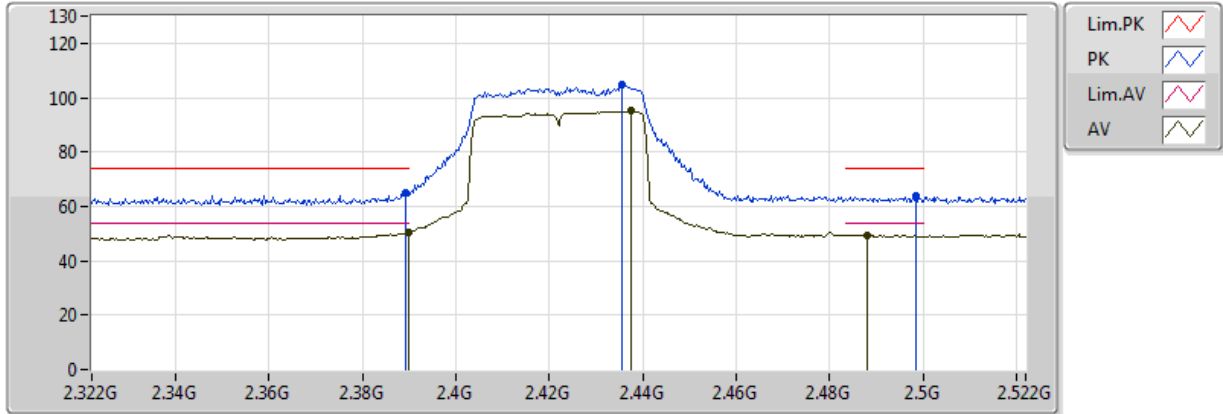

EUT = Y

Type	Freq (Hz)	Level (dBuV/m)	Limit (dBuV/m)	Margin (dB)	Factor (dB)	Dist (m)	Condition	Azimuth (°)	Height (m)	Comments	Raw (dBuV)	AF (dB)	CL (dB)	PA (dB)
AV	2.389998G	50.65	54.00	-3.35	30.93	3	Horizontal	12	1.15	-	19.72	27.31	3.62	-
AV	2.437362G	95.06	Inf	-Inf	31.10	3	Horizontal	12	1.15	-	63.96	27.44	3.67	-
AV	2.488087G	49.48	54.00	-4.52	31.29	3	Horizontal	12	1.15	-	18.19	27.57	3.72	-
PK	2.389246G	65.00	74.00	-9.00	30.93	3	Horizontal	12	1.15	-	34.07	27.31	3.62	-
PK	2.435623G	105.04	Inf	-Inf	31.10	3	Horizontal	12	1.15	-	73.94	27.43	3.67	-
PK	2.498522G	63.62	74.00	-10.38	31.32	3	Horizontal	12	1.15	-	32.30	27.60	3.73	-

802.11n HT40_Nss1,(MCS0)_2TX

2422MHz_TX

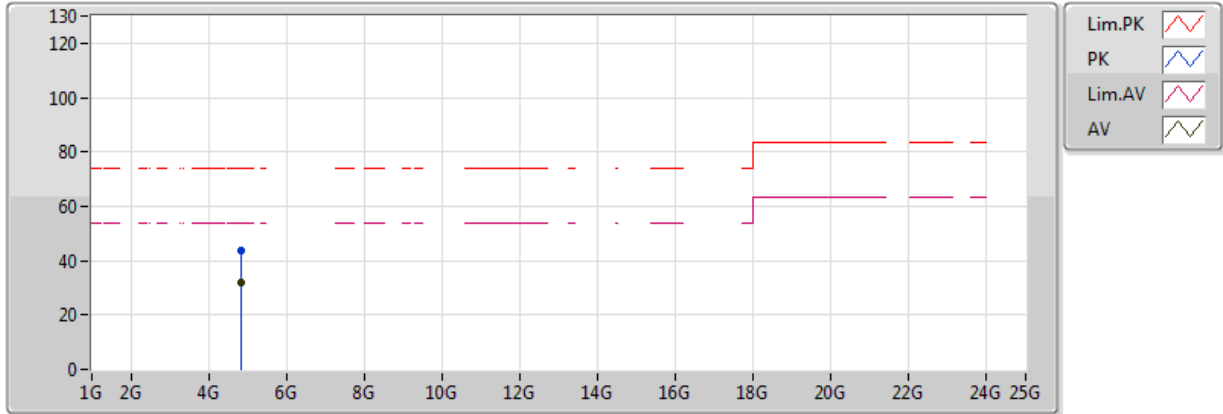

EUT = Y

Type	Freq (Hz)	Level (dBuV/m)	Limit (dBuV/m)	Margin (dB)	Factor (dB)	Dist (m)	Condition	Azimuth (°)	Height (m)	Comments	Raw (dBuV)	AF (dB)	CL (dB)	PA (dB)
AV	4.844G	31.77	54.00	-22.23	2.23	3	Vertical	325	1.41	-	29.54	31.32	5.43	34.52
PK	4.844G	43.88	74.00	-30.12	2.23	3	Vertical	325	1.41	-	41.65	31.32	5.43	34.52

802.11n HT40_Nss1,(MCS0)_2TX

2422MHz_TX

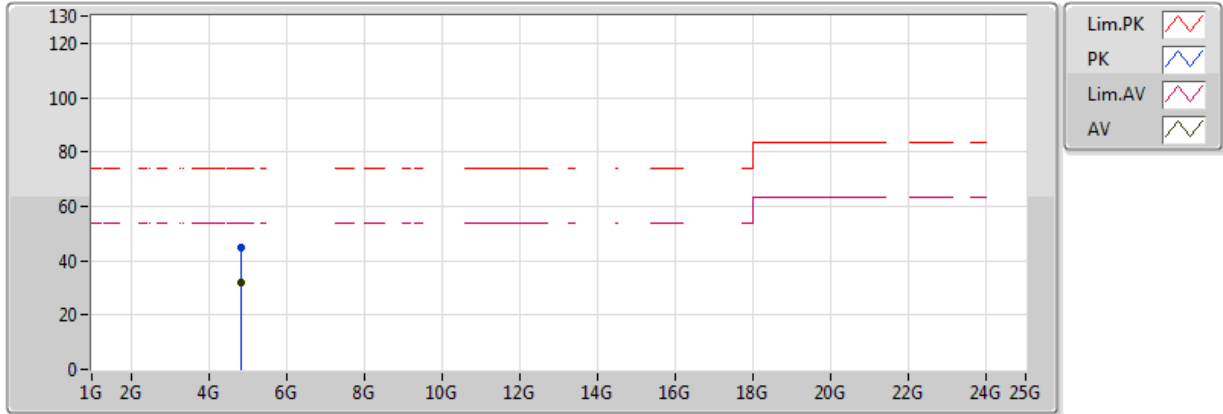

EUT = Y

Type	Freq (Hz)	Level (dBuV/m)	Limit (dBuV/m)	Margin (dB)	Factor (dB)	Dist (m)	Condition	Azimuth (°)	Height (m)	Comments	Raw (dBuV)	AF (dB)	CL (dB)	PA (dB)
AV	4.844G	31.66	54.00	-22.34	2.23	3	Horizontal	292	1.25	-	29.43	31.32	5.43	34.52
PK	4.844G	44.80	74.00	-29.20	2.23	3	Horizontal	292	1.25	-	42.57	31.32	5.43	34.52

802.11n HT40_Nss1,(MCS0)_2TX

2437MHz_TX

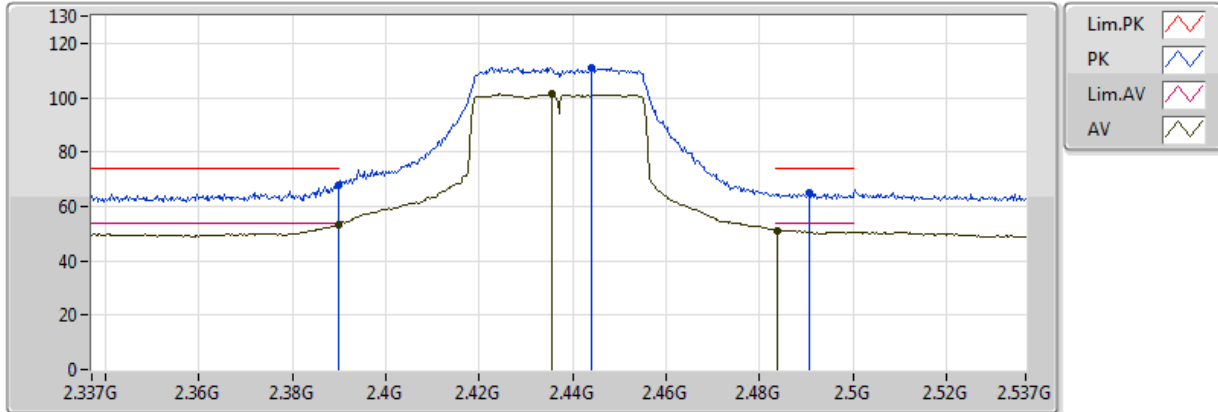

EUT = Y

Type	Freq (Hz)	Level (dBuV/m)	Limit (dBuV/m)	Margin (dB)	Factor (dB)	Dist (m)	Condition	Azimuth (°)	Height (m)	Comments	Raw (dBuV)	AF (dB)	CL (dB)	PA (dB)
AV	2.389998G	53.45	54.00	-0.55	30.93	3	Vertical	6	2.54	-	22.52	27.31	3.62	-
AV	2.435551G	101.26	Inf	-Inf	31.10	3	Vertical	6	2.54	-	70.16	27.43	3.67	-
AV	2.483667G	51.27	54.00	-2.73	31.27	3	Vertical	6	2.54	-	20.00	27.56	3.71	-
PK	2.389998G	67.65	74.00	-6.35	30.93	3	Vertical	6	2.54	-	36.72	27.31	3.62	-
PK	2.443957G	111.19	Inf	-Inf	31.13	3	Vertical	6	2.54	-	80.06	27.45	3.67	-
PK	2.490623G	65.08	74.00	-8.92	31.30	3	Vertical	6	2.54	-	33.79	27.58	3.72	-

**802.11n HT40_Nss1,(MCS0)_2TX
2437MHz_TX**

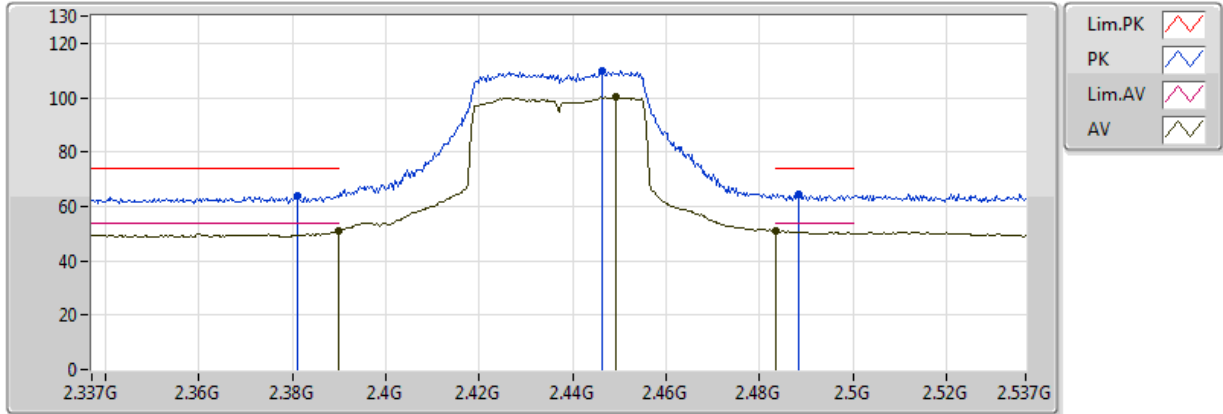

EUT = Y

Type	Freq (Hz)	Level (dBuV/m)	Limit (dBuV/m)	Margin (dB)	Factor (dB)	Dist (m)	Condition	Azimuth (°)	Height (m)	Comments	Raw (dBuV)	AF (dB)	CL (dB)	PA (dB)
AV	2.389754G	50.95	54.00	-3.05	30.93	3	Horizontal	357	1.45	-	20.01	27.31	3.62	-
AV	2.449174G	100.17	Inf	-Inf	31.15	3	Horizontal	357	1.45	-	69.03	27.47	3.68	-
AV	2.483502G	51.02	54.00	-2.98	31.27	3	Horizontal	357	1.45	-	19.75	27.56	3.71	-
PK	2.381058G	63.84	74.00	-10.16	30.90	3	Horizontal	357	1.45	-	32.94	27.29	3.61	-
PK	2.446275G	109.65	Inf	-Inf	31.14	3	Horizontal	357	1.45	-	78.52	27.46	3.68	-
PK	2.488304G	64.55	74.00	-9.45	31.29	3	Horizontal	357	1.45	-	33.27	27.57	3.72	-

802.11n HT40_Nss1,(MCS0)_2TX

2437MHz_TX

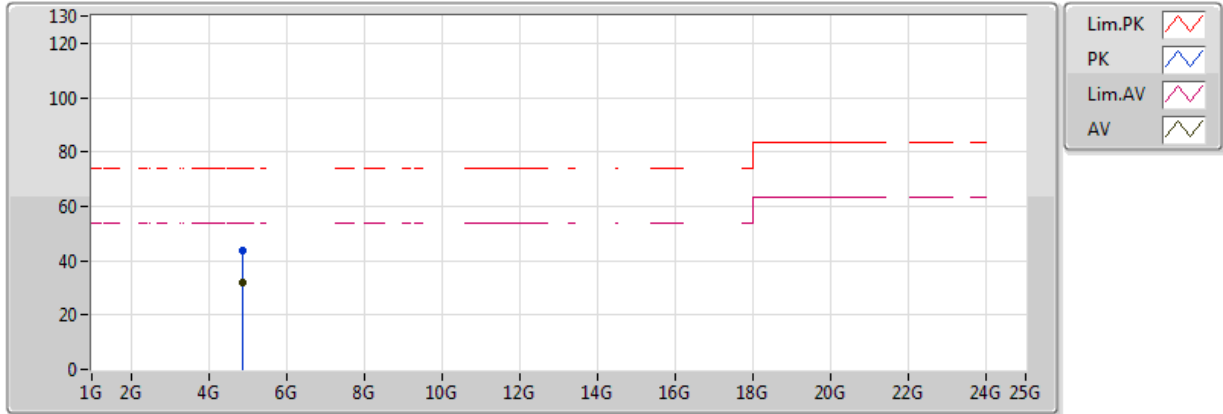

EUT = Y

Type	Freq (Hz)	Level (dBuV/m)	Limit (dBuV/m)	Margin (dB)	Factor (dB)	Dist (m)	Condition	Azimuth (°)	Height (m)	Comments	Raw (dBuV)	AF (dB)	CL (dB)	PA (dB)
AV	4.874G	32.16	54.00	-21.84	2.32	3	Vertical	174	1.92	-	29.84	31.37	5.46	34.52
PK	4.874G	43.76	74.00	-30.24	2.32	3	Vertical	174	1.92	-	41.44	31.37	5.46	34.52

**802.11n HT40_Nss1,(MCS0)_2TX
2437MHz_TX**

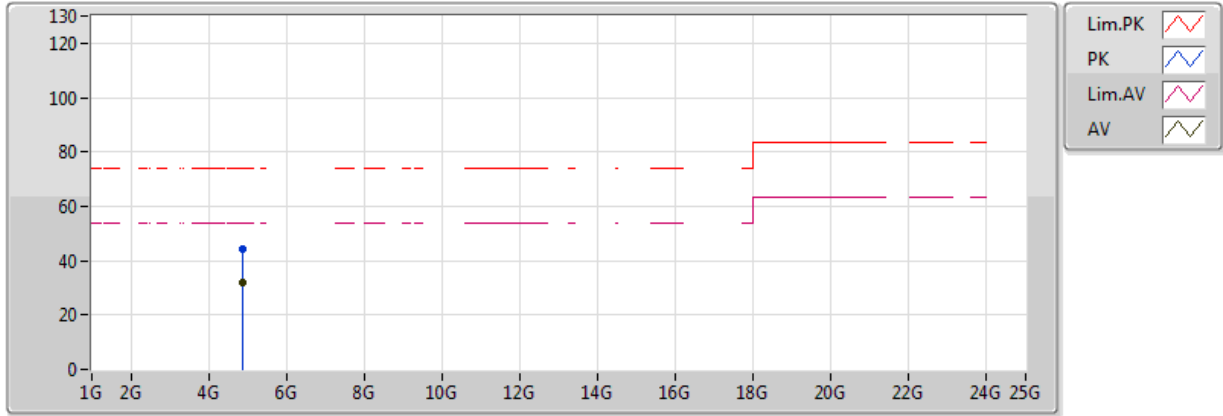

EUT = Y

Type	Freq (Hz)	Level (dBuV/m)	Limit (dBuV/m)	Margin (dB)	Factor (dB)	Dist (m)	Condition	Azimuth (°)	Height (m)	Comments	Raw (dBuV)	AF (dB)	CL (dB)	PA (dB)
AV	4.874G	31.99	54.00	-22.01	2.32	3	Horizontal	349	1.25	-	29.67	31.37	5.46	34.52
PK	4.874G	44.54	74.00	-29.46	2.32	3	Horizontal	349	1.25	-	42.22	31.37	5.46	34.52

**802.11n HT40_Nss1,(MCS0)_2TX
2452MHz_TX**

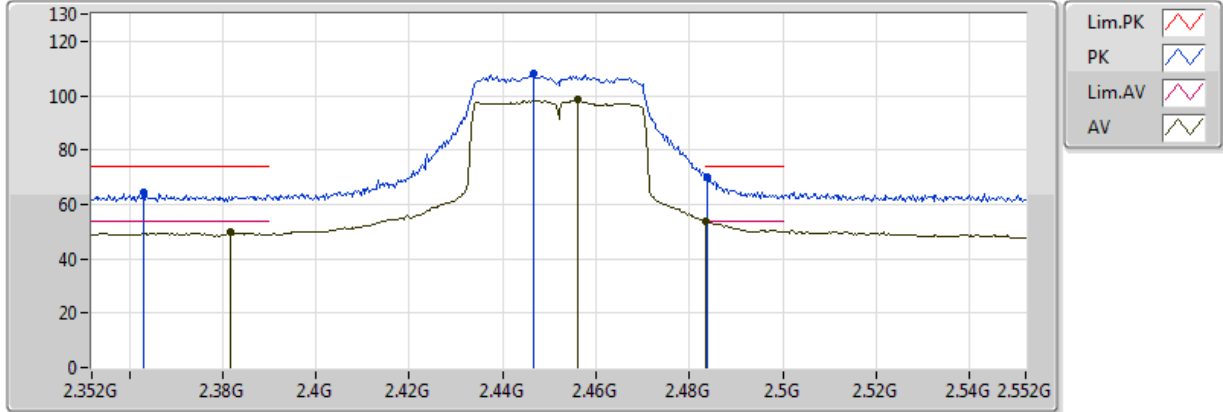

EUT = Y

Type	Freq (Hz)	Level (dBuV/m)	Limit (dBuV/m)	Margin (dB)	Factor (dB)	Dist (m)	Condition	Azimuth (°)	Height (m)	Comments	Raw (dBuV)	AF (dB)	CL (dB)	PA (dB)
AV	2.381565G	49.67	54.00	-4.33	30.91	3	Vertical	12	2.27	-	18.77	27.29	3.61	-
AV	2.456058G	98.40	Inf	-Inf	31.17	3	Vertical	12	2.27	-	67.23	27.49	3.69	-
AV	2.483594G	53.80	54.00	-0.20	31.27	3	Vertical	12	2.27	-	22.53	27.56	3.71	-
PK	2.363014G	64.30	74.00	-9.70	30.84	3	Vertical	12	2.27	-	33.46	27.24	3.60	-
PK	2.446493G	108.14	Inf	-Inf	31.14	3	Vertical	12	2.27	-	77.00	27.46	3.68	-
PK	2.483884G	70.09	74.00	-3.91	31.27	3	Vertical	12	2.27	-	38.82	27.56	3.71	-

802.11n HT40_Nss1,(MCS0)_2TX

2452MHz_TX

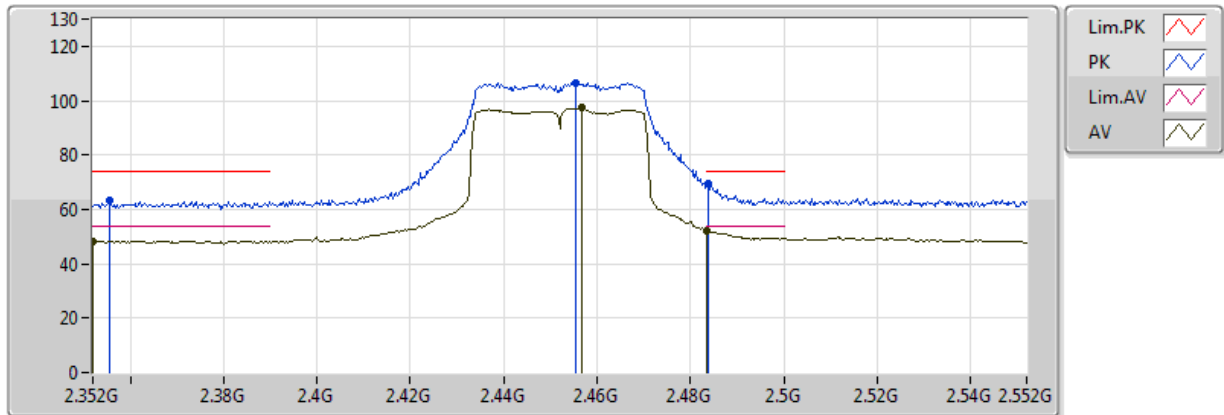

EUT = Y

Type	Freq (Hz)	Level (dBuV/m)	Limit (dBuV/m)	Margin (dB)	Factor (dB)	Dist (m)	Condition	Azimuth (°)	Height (m)	Comments	Raw (dBuV)	AF (dB)	CL (dB)	PA (dB)
AV	2.352G	48.37	54.00	-5.63	30.80	3	Horizontal	358	1.50	-	17.56	27.22	3.59	-
AV	2.456638G	97.41	Inf	-Inf	31.17	3	Horizontal	358	1.50	-	66.24	27.49	3.69	-
AV	2.483594G	52.17	54.00	-1.83	31.27	3	Horizontal	358	1.50	-	20.90	27.56	3.71	-
PK	2.355478G	63.25	74.00	-10.75	30.81	3	Horizontal	358	1.50	-	32.43	27.22	3.59	-
PK	2.455478G	106.56	Inf	-Inf	31.17	3	Horizontal	358	1.50	-	75.39	27.48	3.69	-
PK	2.483884G	69.48	74.00	-4.52	31.27	3	Horizontal	358	1.50	-	38.21	27.56	3.71	-

**802.11n HT40_Nss1,(MCS0)_2TX
2452MHz_TX**

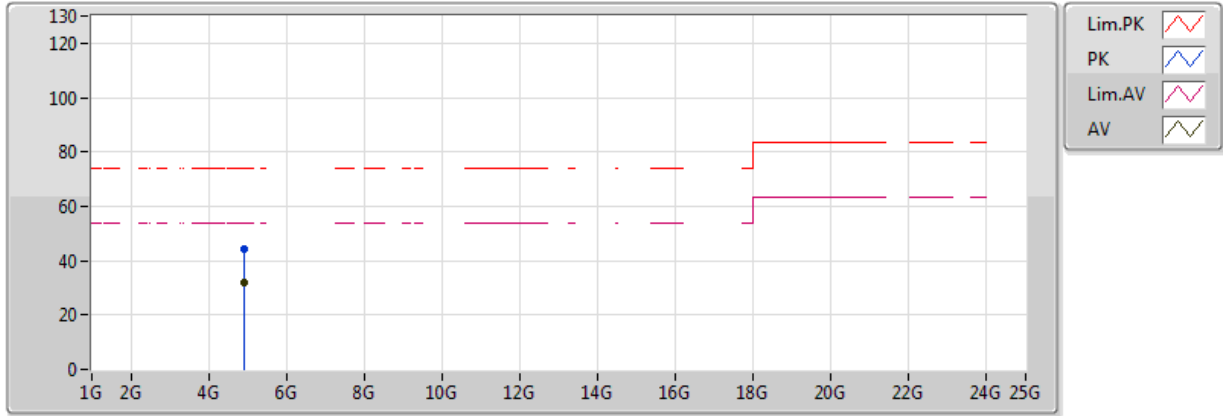

EUT = Y

Type	Freq (Hz)	Level (dBuV/m)	Limit (dBuV/m)	Margin (dB)	Factor (dB)	Dist (m)	Condition	Azimuth (°)	Height (m)	Comments	Raw (dBuV)	AF (dB)	CL (dB)	PA (dB)
AV	4.904G	32.18	54.00	-21.82	2.41	3	Vertical	86	1.04	-	29.77	31.43	5.49	34.51
PK	4.904G	44.23	74.00	-29.77	2.41	3	Vertical	86	1.04	-	41.82	31.43	5.49	34.51

**802.11n HT40_Nss1,(MCS0)_2TX
2452MHz_TX**

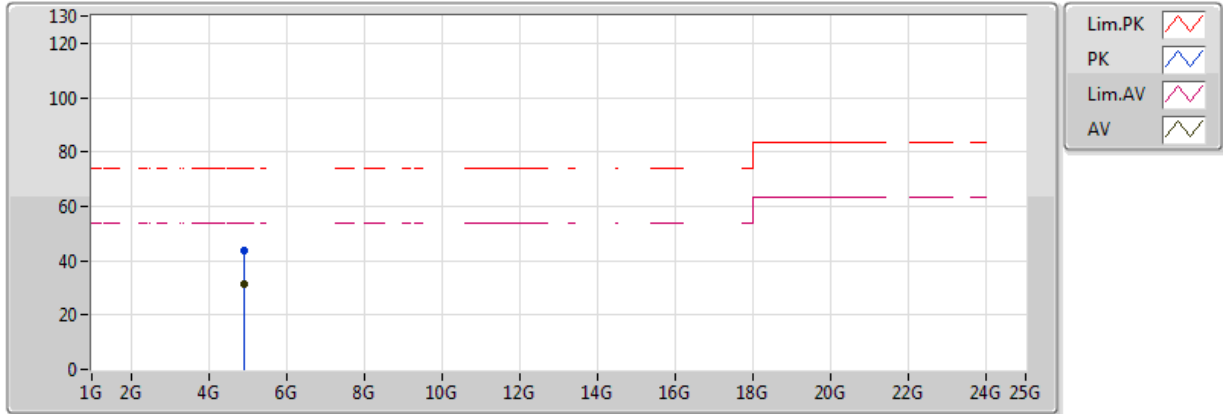

EUT = Y

Type	Freq (Hz)	Level (dBuV/m)	Limit (dBuV/m)	Margin (dB)	Factor (dB)	Dist (m)	Condition	Azimuth (°)	Height (m)	Comments	Raw (dBuV)	AF (dB)	CL (dB)	PA (dB)
AV	4.904G	31.55	54.00	-22.45	2.41	3	Horizontal	269	2.40	-	29.14	31.43	5.49	34.51
PK	4.904G	43.85	74.00	-30.15	2.41	3	Horizontal	269	2.40	-	41.44	31.43	5.49	34.51