



FCC Test Report

Equipment : cnPilot E600 Indoor
Brand Name : Cambium Networks
Model No. : cnPilot E600 Indoor
FCC ID : Z8H89FT0036
Standard : 47 CFR FCC Part 15.247
Frequency : 2400 MHz – 2483.5 MHz
Function : Point-to-multipoint; Point-to-point
Applicant / Manufacturer : Cambium Networks Inc.
3800 Golf Road, Suite 360 Rolling Meadows,
IL 60008, USA

The product sample received on Jun. 23, 2017 and completely tested on Jul. 14, 2017. We, SPORTON, would like to declare that the tested sample has been evaluated in accordance with the procedures given in ANSI C63.10-2013 and shown compliance with the applicable technical standards.

The test results in this report apply exclusively to the tested model / sample. Without written approval of SPORTON INTERNATIONAL INC., the test report shall not be reproduced except in full.

Phoenix Chen
SPORTON INTERNATIONAL INC.





Table of Contents

- 1 GENERAL DESCRIPTION5**
- 1.1 Information.....5
- 1.2 Testing Applied Standards6
- 1.3 Testing Location Information6
- 1.4 Measurement Uncertainty6
- 2 TEST CONFIGURATION OF EUT.....7**
- 2.1 Test Condition7
- 2.2 Test Channel Mode7
- 2.3 The Worst Case Measurement Configuration.....8
- 2.4 Accessories9
- 2.5 Support Equipment.....9
- 2.6 Test Setup Diagram10
- 3 TRANSMITTER TEST RESULT12**
- 3.1 AC Power-line Conducted Emissions12
- 3.2 DTS Bandwidth.....13
- 3.3 Maximum Conducted Output Power14
- 3.4 Power Spectral Density16
- 3.5 Emissions in Non-restricted Frequency Bands17
- 3.6 Emissions in Restricted Frequency Bands.....18
- 4 TEST EQUIPMENT AND CALIBRATION DATA22**

APPENDIX A. TEST RESULTS OF AC POWER-LINE CONDUCTED EMISSIONS

APPENDIX B. TEST RESULTS OF DTS BANDWIDTH

APPENDIX C. TEST RESULTS OF MAXIMUM CONDUCTED OUTPUT POWER

APPENDIX D. TEST RESULTS OF POWER SPECTRAL DENSITY

APPENDIX E. TEST RESULTS OF EMISSIONS IN NON-RESTRICTED FREQUENCY BANDS

APPENDIX F. TEST RESULTS OF EMISSIONS IN RESTRICTED FREQUENCY BANDS

APPENDIX G. TEST RESULTS OF RADIATED EMISSION CO-LOCATION

APPENDIX H. TEST PHOTOS

PHOTOGRAPHS OF EUT V01



Summary of Test Result

Conformance Test Specifications				
Report Clause	Ref. Std. Clause	Description	Limit	Result
1.1.2	15.203	Antenna Requirement	FCC 15.203	Complied
3.1	15.207	AC Power-line Conducted Emissions	FCC 15.207	Complied
3.2	15.247(a)	DTS Bandwidth	≥500kHz	Complied
3.3	15.247(b)	Maximum Conducted Output Power	Power [dBm]:30	Complied
3.4	15.247(e)	Power Spectral Density	PSD [dBm/3kHz]:8	Complied
3.5	15.247(d)	Emissions in Non-restricted Frequency Bands	Non-Restricted Bands: >30 dBc	Complied
3.6	15.247(d)	Emissions in Restricted Frequency Bands	Restricted Bands: FCC 15.209	Complied



1 General Description

1.1 Information

1.1.1 RF General Information

Frequency Range (MHz)	Bluetooth Mode	Ch. Frequency (MHz)	Channel Number
2400-2483.5	LE	2402-2480	0-39 [40]

Band	Mode	BWch (MHz)	Nant
2.4-2.4835GHz	BT-LE(1Mbps)	1.0	1TX

Note:

- ♦ Bluetooth LE uses a GFSK (1Mbps) modulation for DSSS.
- ♦ BWch is the nominal channel bandwidth.

1.1.2 Antenna Information

Ant.	Port	Brand	Model Name	Antenna Type	Connector	Gain (dBi)
1	1	-	-	PIFA Antenna	I-PEX	3.78

1.1.3 EUT Information

Operational Condition	
EUT Power Type	From AC Adapter
Type of EUT	
<input checked="" type="checkbox"/>	Stand-alone
<input type="checkbox"/>	Combined (EUT where the radio part is fully integrated within another device)
	Combined Equipment - Brand Name / Model No.: ...
<input type="checkbox"/>	Plug-in radio (EUT intended for a variety of host systems)
	Host System - Brand Name / Model No.: ...
<input type="checkbox"/>	Other:



1.1.4 Mode Test Duty Cycle

Mode	DC	DCF(dB)	T(s)	VBW(Hz) ≥ 1/T
BT-LE(1Mbps)	0.621	2.069	405u	3k

1.2 Testing Applied Standards

According to the specifications of the manufacturer, the EUT must comply with the requirements of the following standards:

- ♦ 47 CFR FCC Part 15
- ♦ ANSI C63.10-2013
- ♦ KDB 558074 D01 v04

1.3 Testing Location Information

Testing Location		
<input checked="" type="checkbox"/>	HWA YA	ADD : No. 52, Huaya 1st Rd., Guishan Dist., Taoyuan City, Taiwan (R.O.C.) TEL : 886-3-327-3456 FAX : 886-3-327-0973
Test site Designation No. TW1190 with FCC.		
<input type="checkbox"/>	JHUBEI	ADD : No.8, Ln. 724, Bo'ai St., Zhubei City, Hsinchu County, Taiwan (R.O.C.) TEL : 886-3-656-9065 FAX : 886-3-656-9085
Test site Designation No. TW0006 with FCC.		

Test Condition	Test Site No.	Test Engineer	Test Environment	Test Date
RF Conducted	TH01-HY	Gary	21.5°C / 61%	14/Jul/2017
Radiated	03CH02-HY	Andy	23.5°C / 56%	04/Jul/2017
AC Conduction	CO01-HY	Teddy	24°C / 58%	07/Jul/2017

1.4 Measurement Uncertainty

ISO/IEC 17025 requires that an estimate of the measurement uncertainties associated with the emissions test results be included in the report. The measurement uncertainties given below are based on a 95% confidence level (based on a coverage factor (k=2))

Test Items	Uncertainty	Remark
Conducted Emission (150kHz ~ 30MHz)	3.6 dB	Confidence levels of 95%
Radiated Emission (30MHz ~ 1,000MHz)	2.1 dB	Confidence levels of 95%
Radiated Emission (1GHz ~ 18GHz)	2.6 dB	Confidence levels of 95%
Radiated Emission (18GHz ~ 40GHz)	2.9 dB	Confidence levels of 95%
Conducted Emission	1.3 dB	Confidence levels of 95%



2 Test Configuration of EUT

2.1 Test Condition

Condition Item	Abbreviation/Remark	Remark
RF Conducted-DTS	Abbreviation	Remark
TnomVnom	Tnom	20°C
-	Vnom	120V

2.2 Test Channel Mode



Test Software Version	QDART-Connectivity1.0-00048
-----------------------	-----------------------------

Mode	Power Setting
BT-LE(1Mbps)	-
2402MHz	8
2440MHz	8
2480MHz	8

2.3 The Worst Case Measurement Configuration

The Worst Case Mode for Following Conformance Tests	
Tests Item	AC power-line conducted emissions Emissions in Non-restricted Frequency Bands
Condition	AC power-line conducted measurement for line and neutral
Operating Mode	Normal Link
1	WiFi 2.4G & 5G, BT ON, ETH1 : 1Gbps, ETH2 : 1Gbps, AC MODE

The Worst Case Mode for Following Conformance Tests	
Tests Item	DTS Bandwidth Maximum Conducted Output Power Power Spectral Density Emissions in Non-restricted Frequency Bands
Test Condition	Conducted measurement at transmit chains

The Worst Case Mode for Following Conformance Tests			
Tests Item	Emissions in Restricted Frequency Bands		
Test Condition	Radiated measurement If EUT consist of multiple antenna assembly (multiple antenna are used in EUT regardless of spatial multiplexing MIMO configuration), the radiated test should be performed with highest antenna gain of each antenna type.		
Operating Mode	CTX		
1	Adapter Mode		
Orthogonal Planes of EUT	X Plane	Y Plane	Z Plane
			
Worst Planes of EUT		V	

The Worst Case Mode for Following Conformance Tests	
Tests Item	Simultaneous Transmission Analysis
Test Condition	Radiated measurement
Operating Mode	Normal Link
1	(Y Plane),Bluetooth+WLAN 2.4GHz+ WLAN 5GHz
2	(Z Plane),Bluetooth+WLAN 2.4GHz+ WLAN 5GHz

Refer to Sporton Test Report No.: FA740634-01 for Co-location RF Exposure Evaluation and Appendix G for Radiated Emission Co-location.



2.4 Accessories

Accessories				
AC Adapter	Brand Name	CWT	Model Name	KPL-040F-VI
	Power Rating	I/P: <u>100</u> - <u>240V</u> ~ 50/60Hz, <u>1.7</u> A, O/P: <u>12</u> Vdc, <u>3.33</u> A 40W		
	DC Power Cord	<u>1.16</u> meter, non-shielded cable, with one ferrite core		

Reminder: Regarding to more detail and other information, please refer to user manual.

2.5 Support Equipment

Support Equipment – RF Conducted				
No.	Equipment	Brand Name	Model Name	FCC ID
1	Notebook	DELL	E5410	R33002 / DOC
2	Adapter for NB	DELL	HA65NM130	R35737 / DOC
3	Client	-	-	-
4	Notebook	DELL	E5410	R33002 / DOC
5	Adapter for NB	DELL	HA65NM130	R35737 / DOC
6	AC Source	GW	APS-9102	-

Note: Support equipment No.3 was provided by customer.

Support Equipment – Radiated Emission				
No.	Equipment	Brand Name	Model Name	FCC ID
1	Notebook	DELL	E5410	DOC
2	Notebook	DELL	E5530	DOC
3	Client	-	-	-
4	AC Adapter	DELL	LA65NS2-01	-

Note: Support equipment No.3 was provided by customer.

Support Equipment – AC Conduction				
No.	Equipment	Brand Name	Model Name	FCC ID
A	Notebook	P55G	P55G	DoC
B	Mouse	Microsoft	1113	DoC
C	Printer	EPSON	C61	N/A
Z	Notebook	DELL	Latitude E5430	DoC
Z	Notebook	DELL	Latitude E5540	DoC
Z	Notebook	DELL	Latitude E5520	DoC
Z	Notebook	DELL	Latitude E5430	DoC
Z	Notebook	DELL	D5500	DoC

2.6 Test Setup Diagram

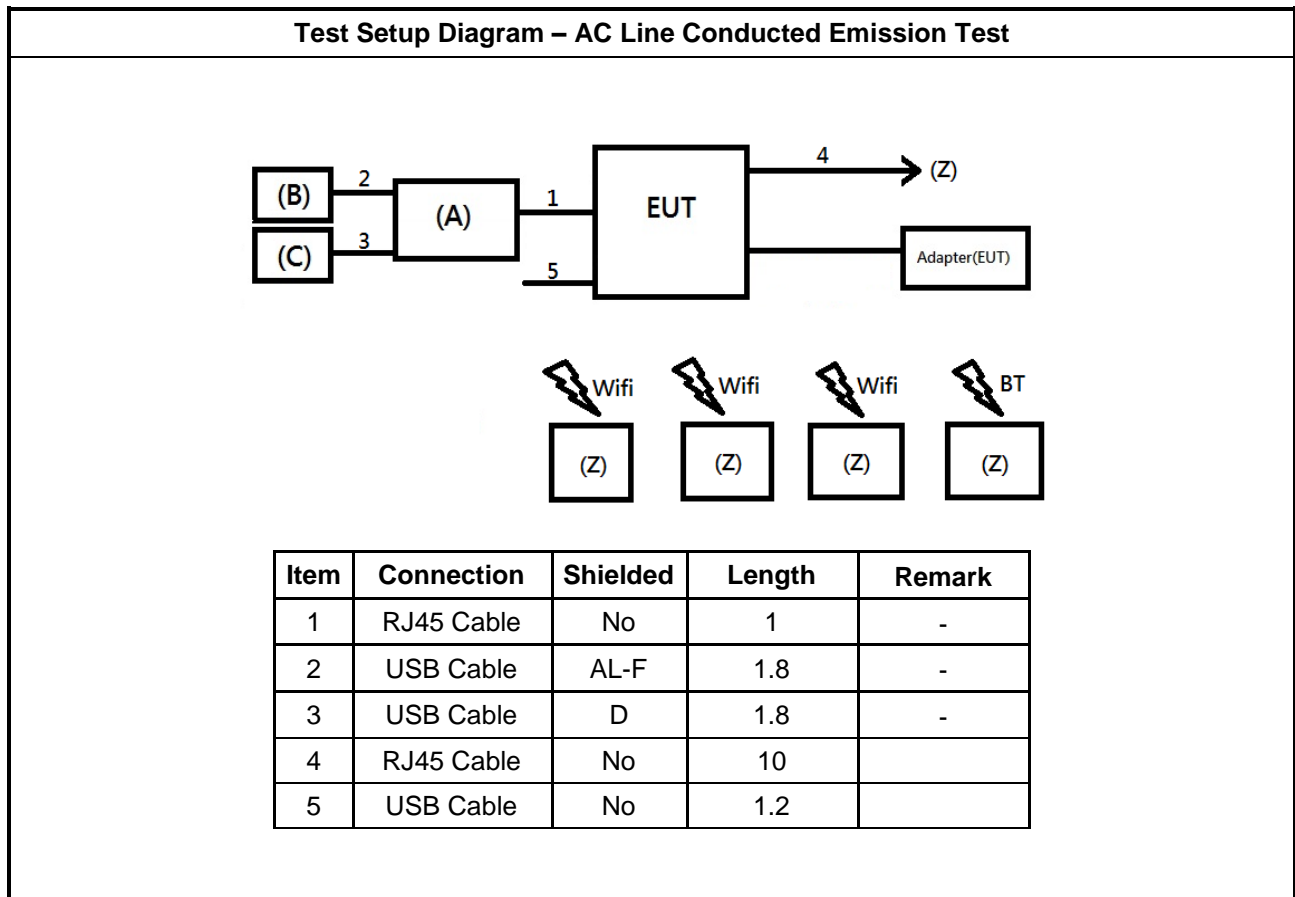

Test Setup Diagram - Radiated Test

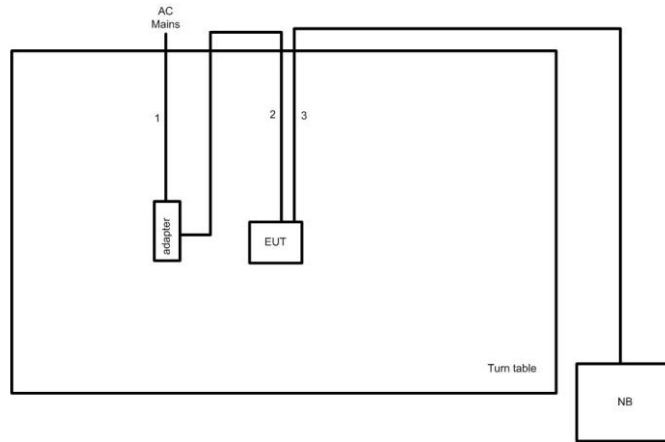

Item	Connection	Shielded	Length	Remark
1	AC Power line	No	2.3m	-
2	DC Power line	No	1.16m	-
3	RJ-45 cable	No	10m	-

3 Transmitter Test Result

3.1 AC Power-line Conducted Emissions

3.1.1 AC Power-line Conducted Emissions Limit

AC Power-line Conducted Emissions Limit		
Frequency Emission (MHz)	Quasi-Peak	Average
0.15-0.5	66 - 56 *	56 - 46 *
0.5-5	56	46
5-30	60	50

Note 1: * Decreases with the logarithm of the frequency.

3.1.2 Measuring Instruments

Refer a test equipment and calibration data table in this test report.

3.1.3 Test Procedures

Test Method
<ul style="list-style-type: none"> Refer as ANSI C63.10-2013, clause 6.2 foray power-line conducted emissions.

3.1.4 Test Setup

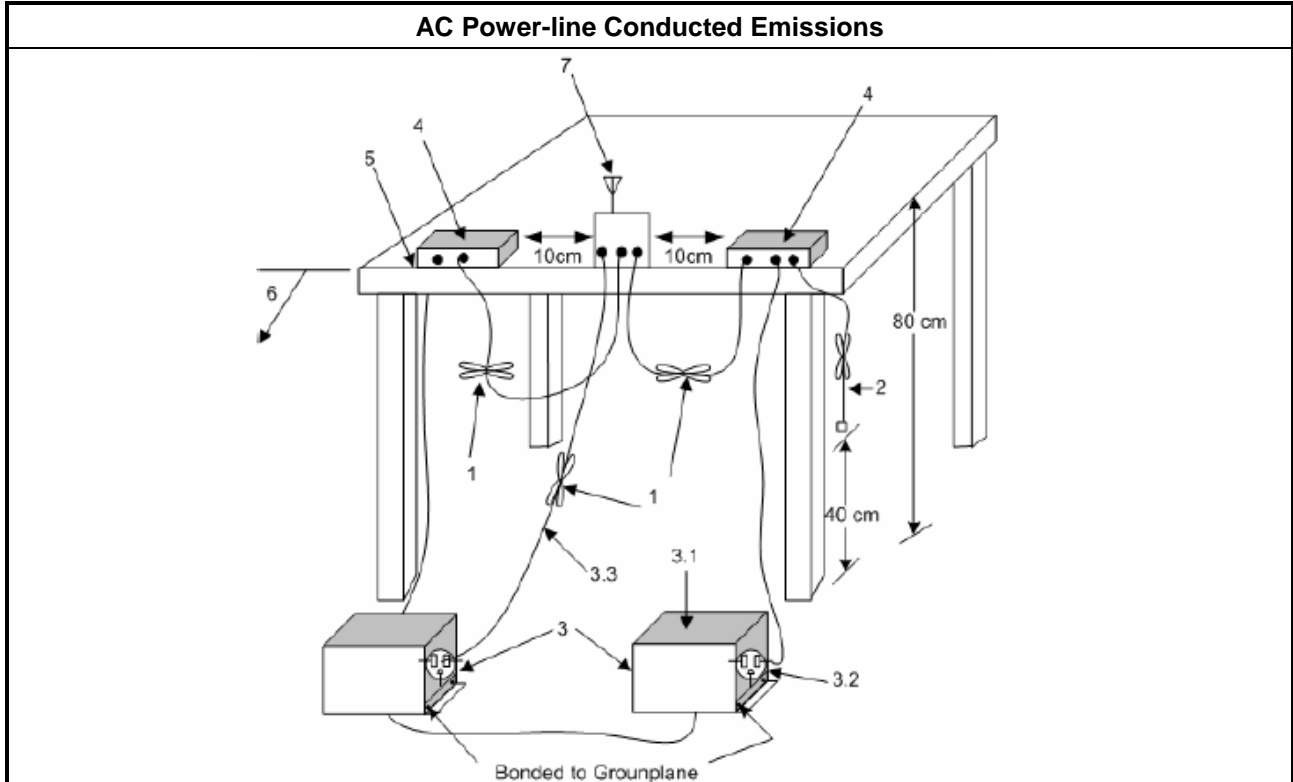

3.1.5 Test Result of AC Power-line Conducted Emissions

Refer as Appendix A

3.2 DTS Bandwidth

3.2.1 6dB Bandwidth Limit

6dB Bandwidth Limit
Systems using digital modulation techniques:
<ul style="list-style-type: none"> ▪ 6 dB bandwidth \geq 500 kHz.

3.2.2 Measuring Instruments

Refer a test equipment and calibration data table in this test report.

3.2.3 Test Procedures

Test Method
<ul style="list-style-type: none"> ▪ For the emission bandwidth shall be measured using one of the options below:
<input checked="" type="checkbox"/> Refer as KDB 558074, clause 8.1 Option 1 for 6 dB bandwidth measurement.
<input type="checkbox"/> Refer as KDB 558074, clause 8.2 Option 2 for 6 dB bandwidth measurement.
<input type="checkbox"/> Refer as ANSI C63.10, clause 6.9.3 for occupied bandwidth testing.

3.2.4 Test Setup

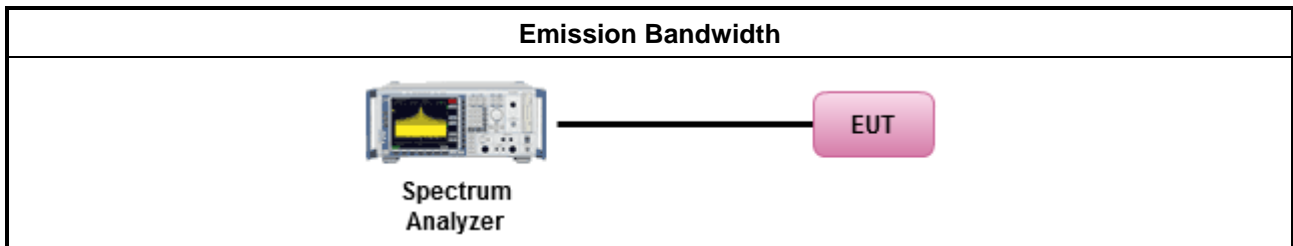

3.2.5 Test Result of Emission Bandwidth

Refer as Appendix B

3.3 Maximum Conducted Output Power

3.3.1 Maximum Conducted Output Power Limit

Maximum Conducted Output Power Limit	
	<ul style="list-style-type: none"> ▪ If $G_{TX} \leq 6$ dBi, then $P_{Out} \leq 30$ dBm (1 W)
	<ul style="list-style-type: none"> ▪ Point-to-multipoint systems (P2M): If $G_{TX} > 6$ dBi, then $P_{Out} = 30 - (G_{TX} - 6)$ dBm
	<ul style="list-style-type: none"> ▪ Point-to-point systems (P2P): If $G_{TX} > 6$ dBi, then $P_{Out} = 30 - (G_{TX} - 6)/3$ dBm
	<ul style="list-style-type: none"> ▪ Smart antenna system (SAS):
	<ul style="list-style-type: none"> - Single beam: If $G_{TX} > 6$ dBi, then $P_{Out} = 30 - (G_{TX} - 6)/3$ dBm
	<ul style="list-style-type: none"> - Overlap beam: If $G_{TX} > 6$ dBi, then $P_{Out} = 30 - (G_{TX} - 6)/3$ dBm
	<ul style="list-style-type: none"> - Aggregate power on all beams: If $G_{TX} > 6$ dBi, then $P_{Out} = 30 - (G_{TX} - 6)/3 + 8$ dB dBm
e.i.r.p. Power Limit:	
	<ul style="list-style-type: none"> ▪ 2400-2483.5 MHz Band
	<ul style="list-style-type: none"> ▪ Point-to-multipoint systems (P2M): $P_{eirp} \leq 36$ dBm (4 W)
	<ul style="list-style-type: none"> ▪ Point-to-point systems (P2P): $P_{eirp} \leq \text{MAX}(36, [P_{Out} + G_{TX}])$ dBm
	<ul style="list-style-type: none"> ▪ Smart antenna system (SAS)
	<ul style="list-style-type: none"> - Single beam: $P_{eirp} \leq \text{MAX}(36, P_{Out} + G_{TX})$ dBm
	<ul style="list-style-type: none"> - Overlap beam: $P_{eirp} \leq \text{MAX}(36, P_{Out} + G_{TX})$ dBm
	<ul style="list-style-type: none"> - Aggregate power on all beams: $P_{eirp} \leq \text{MAX}(36, [P_{Out} + G_{TX} + 8])$ dBm
<p>P_{Out} = maximum peak conducted output power or maximum conducted output power in dBm, G_{TX} = the maximum transmitting antenna directional gain in dBi.</p>	

3.3.2 Measuring Instruments

Refer a test equipment and calibration data table in this test report.

3.3.3 Test Procedures

Test Method	
<ul style="list-style-type: none"> ▪ Maximum Peak Conducted Output Power 	
<input type="checkbox"/>	Refer as KDB 558074, clause 9.1.1 Option 1 (RBW ≥ EBW method).
<input type="checkbox"/>	Refer as KDB 558074, clause 9.1.2 Option 2 (integrated band power method)
<input type="checkbox"/>	Refer as KDB 558074, clause 9.1.3 Option 3 (peak power meter for VBW ≥ DTS BW)
<ul style="list-style-type: none"> ▪ Maximum Average Conducted Output Power 	
Duty cycle ≥ 98%	
<input type="checkbox"/>	Refer as KDB 558074, clause 9.2.2.4 Method AVGSA-2 (spectral trace averaging).
Duty cycle < 98%	
<input type="checkbox"/>	Refer as KDB 558074, clause 9.2.2.5 Method AVGSA-2 Alt. (slow sweep speed)
RF power meter and average over on/off periods with duty factor or gated trigger	
<input checked="" type="checkbox"/>	Refer as KDB 558074, clause 9.2.3.1 Method AVGPM (using an RF average power meter).
<ul style="list-style-type: none"> ▪ For conducted measurement. 	
<ul style="list-style-type: none"> ▪ If the EUT supports multiple transmit chains using options given below: Refer as KDB 662911, In-band power measurements. Using the measure-and-sum approach, measured all transmit ports individually. Sum the power (in linear power units e.g., mW) of all ports for each individual sample and save them. 	
<ul style="list-style-type: none"> ▪ If multiple transmit chains, EIRP calculation could be following as methods: $P_{total} = P_1 + P_2 + \dots + P_n$ (calculated in linear unit [mW] and transfer to log unit [dBm]) $EIRP_{total} = P_{total} + DG$ 	

3.3.4 Test Setup

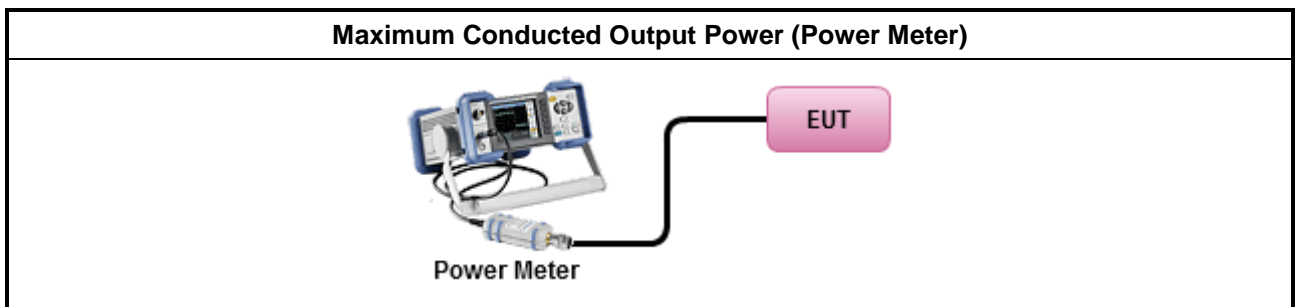

3.3.5 Test Result of Maximum Conducted Output Power

Refer as Appendix C

3.4 Power Spectral Density

3.4.1 Power Spectral Density Limit

Power Spectral Density Limit
<ul style="list-style-type: none"> Power Spectral Density (PSD) ≤ 8 dBm/3kHz

3.4.2 Measuring Instruments

Refer a test equipment and calibration data table in this test report.

3.4.3 Test Procedures

Test Method	
<ul style="list-style-type: none"> Peak power spectral density procedures that the same method as used to determine the conducted output power. If maximum peak conducted output power was measured to demonstrate compliance to the output power limit, then the peak PSD procedure below (Method PKPSD) shall be used. If maximum conducted output power was measured to demonstrate compliance to the output power limit, then one of the average PSD procedures shall be used, as applicable based on the following criteria (the peak PSD procedure is also an acceptable option). 	
<input checked="" type="checkbox"/> Refer as KDB 558074, clause 10.2 Method PKPSD (RBW=3-100kHz; Detector=peak).	
<ul style="list-style-type: none"> For conducted measurement. 	
<ul style="list-style-type: none"> If The EUT supports multiple transmit chains using options given below: 	
<input type="checkbox"/>	Measure and sum the spectra across the outputs. Refer as KDB 662911, In-band power spectral density (PSD). Sample all transmit ports simultaneously using a spectrum analyzer for each transmit port. Where the trace bin-by-bin of each transmit port summing can be performed. (i.e., in the first spectral bin of output 1 is summed with that in the first spectral bin of output 2 and that from the first spectral bin of output 3, and so on up to the NTX output to obtain the value for the first frequency bin of the summed spectrum.). Add up the amplitude (power) values for the different transmit chains and use this as the new data trace.

3.4.4 Test Setup

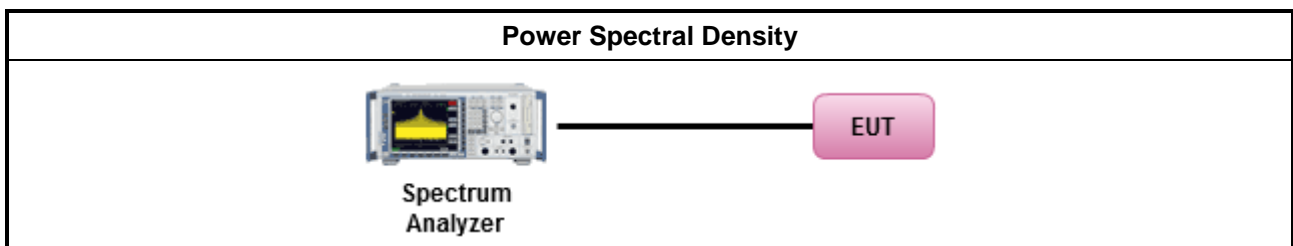

3.4.5 Test Result of Power Spectral Density

Refer as Appendix D

3.5 Emissions in Non-restricted Frequency Bands

3.5.1 Emissions in Non-restricted Frequency Bands Limit

Un-restricted Band Emissions Limit	
RF output power procedure	Limit (dB)
Peak output power procedure	20
Average output power procedure	30

Note 1: If the peak output power procedure is used to measure the fundamental emission power to demonstrate compliance to requirements, then the peak conducted output power measured within any 100 kHz outside the authorized frequency band shall be attenuated by at least 20 dB relative to the maximum measured in-band peak PSD level.

Note 2: If the average output power procedure is used to measure the fundamental emission power to demonstrate compliance to requirements, then the power in any 100 kHz outside of the authorized frequency band shall be attenuated by at least 30 dB relative to the maximum measured in-band average PSD level.

3.5.2 Measuring Instruments

Refer a test equipment and calibration data table in this test report.

3.5.3 Test Procedures

Test Method
<ul style="list-style-type: none"> Refer as KDB 558074, clause 11 for unwanted emissions into non-restricted bands.

3.5.4 Test Setup

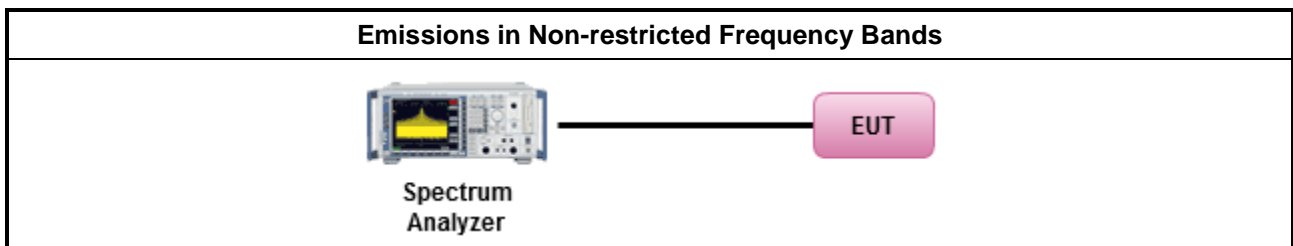

3.5.5 Test Result of Emissions in Non-restricted Frequency Bands

Refer as Appendix E



3.6 Emissions in Restricted Frequency Bands

3.6.1 Emissions in Restricted Frequency Bands Limit

Restricted Band Emissions Limit			
Frequency Range (MHz)	Field Strength (uV/m)	Field Strength (dBuV/m)	Measure Distance (m)
0.009~0.490	2400/F(kHz)	48.5 - 13.8	300
0.490~1.705	24000/F(kHz)	33.8 - 23	30
1.705~30.0	30	29	30
30~88	100	40	3
88~216	150	43.5	3
216~960	200	46	3
Above 960	500	54	3

Note 1: Test distance for frequencies at or above 30 MHz, measurements may be performed at a distance other than the limit distance provided they are not performed in the near field and the emissions to be measured can be detected by the measurement equipment. When performing measurements at a distance other than that specified, the results shall be extrapolated to the specified distance using an extrapolation factor of 20 dB/decade (inverse of linear distance for field-strength measurements, inverse of linear distance-squared for power-density measurements).

Note 2: Test distance for frequencies at below 30 MHz, measurements may be performed at a distance closer than the EUT limit distance; however, an attempt should be made to avoid making measurements in the near field. When performing measurements below 30 MHz at a closer distance than the limit distance, the results shall be extrapolated to the specified distance by either making measurements at a minimum of two or more distances on at least one radial to determine the proper extrapolation factor or by using the square of an inverse linear distance extrapolation factor (40 dB / decade). The test report shall specify the extrapolation method used to determine compliance of the EUT.

3.6.2 Measuring Instruments

Refer a test equipment and calibration data table in this test report.



3.6.3 Test Procedures

Test Method	
<ul style="list-style-type: none"> ▪ The average emission levels shall be measured in [duty cycle \geq 98 or duty factor]. 	
<ul style="list-style-type: none"> ▪ Refer as ANSI C63.10, clause 6.10.3 band-edge testing shall be performed at the lowest frequency channel and highest frequency channel within the allowed operating band. 	
<ul style="list-style-type: none"> ▪ For the transmitter unwanted emissions shall be measured using following options below: 	
<ul style="list-style-type: none"> ▪ Refer as KDB 558074, clause 12 for unwanted emissions into restricted bands. 	
	<ul style="list-style-type: none"> <input checked="" type="checkbox"/> Refer as KDB 558074, clause 12.2.5.3 (ANSI C63.10, clause 4.1.4.2.3), Reduced VBW\geq1/T.
	<ul style="list-style-type: none"> <input checked="" type="checkbox"/> Refer as KDB 558074, clause 12.2.4 measurement procedure peak limit.
<ul style="list-style-type: none"> ▪ For the transmitter band-edge emissions shall be measured using following options below: 	
<ul style="list-style-type: none"> ▪ Refer as KDB 558074 clause 13.1, When the performing peak or average radiated measurements, emissions within 2 MHz of the authorized band edge may be measured using the marker-delta method described below. 	
<ul style="list-style-type: none"> ▪ Refer as KDB 558074, clause 13.2 (ANSI C63.10, clause 6.10.6) for marker-delta method for band-edge measurements. 	
<ul style="list-style-type: none"> ▪ Refer as KDB 558074, clause 13.3 for narrower resolution bandwidth (100kHz) using the band power and summing the spectral levels (i.e., 1 MHz). 	
<ul style="list-style-type: none"> ▪ For conducted and cabinet radiation measurement, refer as KDB 558074, clause 12.2.2. 	
<ul style="list-style-type: none"> ▪ For conducted unwanted emissions into restricted bands (absolute emission limits). Devices with multiple transmit chains using options given below: (1) Measure and sum the spectra across the outputs or (2) Measure and add 10 log(N) dB 	
<ul style="list-style-type: none"> ▪ For KDB 662911 The methodology described here may overestimate array gain, thereby resulting in apparent failures to satisfy the out-of-band limits even if the device is actually compliant. In such cases, compliance may be demonstrated by performing radiated tests around the frequencies at which the apparent failures occurred. 	

3.6.4 Test Setup

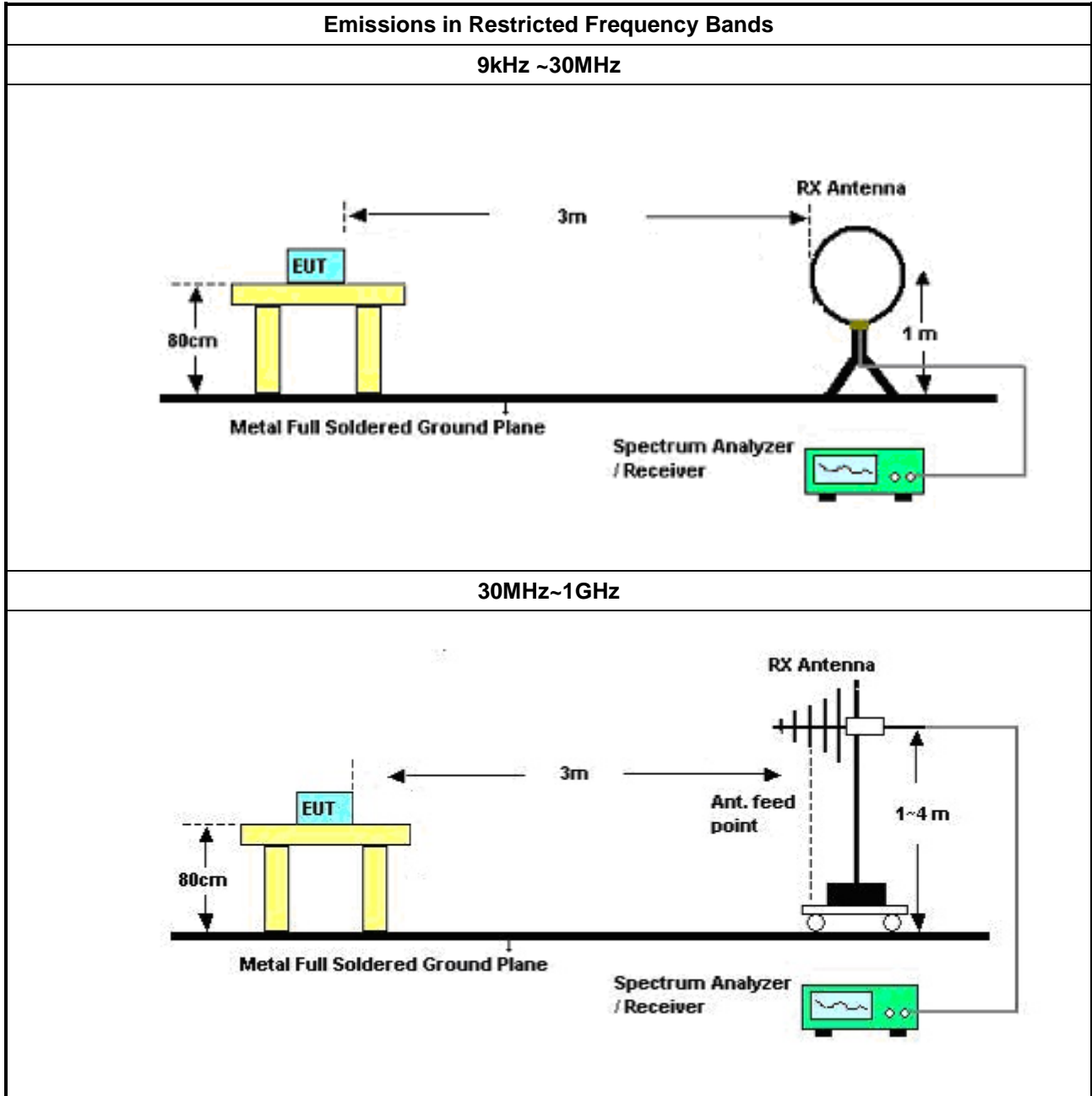

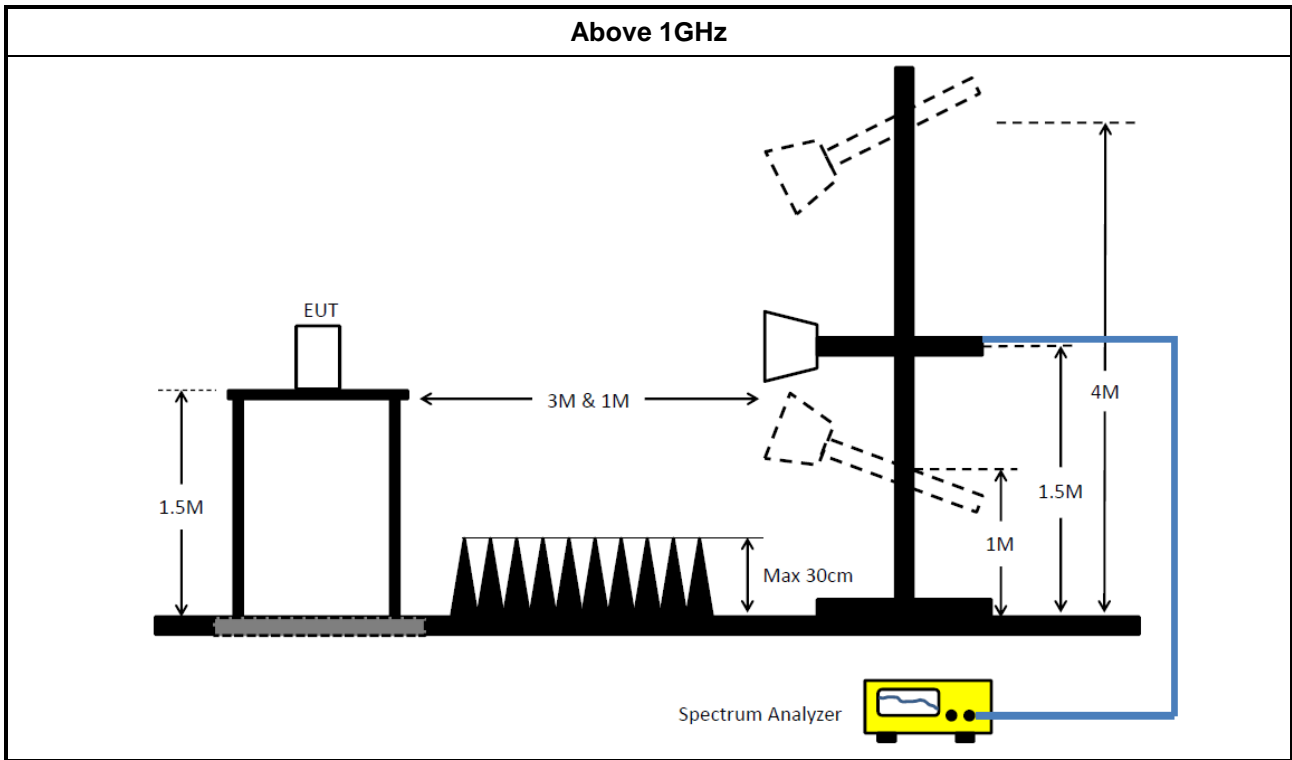

3.6.5 Test Result of Emissions in Restricted Frequency Bands (Below 30MHz)

The amplitude of spurious emissions which are attenuated by more than 20dB below the permissible value has no need to be reported. All amplitude of spurious emissions that are attenuated by more than 20 dB below the permissible value has no need to be reported.

3.6.6 Test Result of Emissions in Restricted Frequency Bands

Refer as Appendix F



4 Test Equipment and Calibration Data

Instrument for AC Conduction

Instrument	Manufacturer	Model No.	Serial No.	Spec.	Calibration Date	Calibration Due Date
EMC Receiver	R&S	ESR3	102052	9kHz ~ 3.6GHz	05/Apr/2017	04/Apr/2018
LISN	R&S	ENV 216	101274	9kHz ~ 30MHz	20/Apr/2017	19/Apr/2018
LISN (Support Unit)	MessTec	NNB-2/16Z	99079	9kHz ~ 30MHz	NCR	NCR
RF Cable-CON	HUBER+SUHN ER	RG213/U	07611832010001	9kHz ~ 30MHz	06/Mar/2017	05/Mar/2018
Impuls Begrenzer Pulse Limiter	R&S	ESH3-Z2	100920	9 kHz ~ 30 MHz	09/Nov/2016	08/Nov/2017
Impedance Stabilization Network	TESEQ	T800	23342	150kHz ~ 230MHz	02/Mar/2017	01/Mar/2018

NCR : Non-Calibration Require

Instrument for Radiated Test

Instrument	Manufacturer	Model No.	Serial No.	Spec.	Calibration Date	Calibration Due Date
Spectrum Analyzer	R&S	FSP40	100593	9KHz - 40GHz	26/Oct/2016	25/Oct/2017
3m Semi Anechoic	SIDT FRANKONIA	SAC-3M	03CH02-HY	30MHz-1GHz	21/Oct/2016	20/Oct/2017
3m Semi Anechoic	SIDT FRANKONIA	SAC-3M	03CH02-HY	1GHz ~ 18GHz	12/Dec/2016	11/Dec/2017
Amplifier	Agilent	8447D	2944A11149	100KHz-1.3GHz	29/Jun/2017	28/Jun/2018
Amplifier	Agilent	8449B	3008A02373	1GHz-26.5GHz	02/Sep/2016	01/Sep/2017
Horn Antenna	SCHWARZBECK	BBHA9120D	BBHA9120D 01531	1GHz-18GHz	25/Apr/2017	24/Apr/2018
Horn Antenna	SCHWARZBECK	BBHA9170	BBHA9170154	15GHz-40GHz	06/Feb/2017	05/Feb/2018
Bilog Antenna	SCHAFFNER	CBL6112B	2723	30MHz-1GHz	01/Oct/2016	30/Sep/2017
Microwave Preamplifier with 6dB Attenuator	EMC INSTRUMENTS	EMC184045B & PE7005-	1840917	18GHz-40GHz	24/Jun/2016	23/Aug/2017
Loop Antenna	TESEQ	HLA 6120	31244	9KHz-30MHz	02/Mar/2017	01/Mar/2018
RF Cable-high	SUHNER	SUCOFLEX104	MY34918/4	1GHz ~ 40GHz	26/Jan/2017	25/Jan/2018
RF Cable-R03m	Jye Bao	RG142	CB017	9kHz ~ 1GHz	26/Jan/2017	25/Jan/2018
Receiver	R&S	ESU-26	100422/026	20Hz ~ 26.5GHz	21/Sep/2016	20/Sep/2017



Instrument for Conducted Test

Instrument	Manufacturer	Model No.	Serial No.	Spec.	Calibration Date	Calibration Due Date
Spectrum Analyzer	R&S	FSV 40	101013	10Hz~40GHz	30/Dec/2016	29/Dec/2017
Power Sensor	Anritsu	MA2411B	1027452	300MHz ~ 40GHz	24/Feb/2017	23/Feb/2018
Power Meter	Anritsu	ML2495A	1124009	300MHz ~ 40GHz	24/Feb/2017	23/Feb/2018
Signal Generator	R&S	SMR40	100116	10MHz ~ 40GHz	21/Jul/2016	20/Jul/2017
RF Cable-0.2m	HUBER+SUHNER	SUCOFLEX_104	MY677/3	30MHz ~ 26.5GHz	02/Oct/2016	01/Oct/2017
RF Cable-0.2m	HUBER+SUHNER	SUCOFLEX_104	MY678/3	30MHz ~ 26.5GHz	02/Oct/2016	01/Oct/2017
RF Cable-0.5m	HUBER+SUHNER	SUCOFLEX_104	MY10717/4	30MHz ~ 26.5GHz	02/Oct/2016	01/Oct/2017



AC Power-line Conducted Emissions Result																																																																																																																																	
Operating Mode	1	Power Phase	Neutral																																																																																																																														
Operating Function	WiFi 2.4G & 5G, BT ON, ETH1 : 1Gbps, ETH2 : 1Gbps, AC MODE																																																																																																																																
<div style="text-align: right;">Date: 2017-07-07</div> <table border="1"> <thead> <tr> <th></th> <th>Freq</th> <th>Level</th> <th>Over Limit</th> <th>Limit Line</th> <th>Read Level</th> <th>LISN Factor</th> <th>Cable Loss</th> <th>Remark</th> </tr> <tr> <th></th> <th>MHz</th> <th>dBuV</th> <th>dB</th> <th>dBuV</th> <th>dBuV</th> <th>dB</th> <th>dB</th> <th></th> </tr> </thead> <tbody> <tr><td>1</td><td>0.16</td><td>21.26</td><td>-34.19</td><td>55.45</td><td>11.54</td><td>9.70</td><td>0.02</td><td>Average</td></tr> <tr><td>2</td><td>0.16</td><td>39.42</td><td>-26.03</td><td>65.45</td><td>29.70</td><td>9.70</td><td>0.02</td><td>QP</td></tr> <tr><td>3 MAX</td><td>0.55</td><td>29.01</td><td>-16.99</td><td>46.00</td><td>19.35</td><td>9.64</td><td>0.02</td><td>Average</td></tr> <tr><td>4</td><td>0.55</td><td>34.87</td><td>-21.13</td><td>56.00</td><td>25.21</td><td>9.64</td><td>0.02</td><td>QP</td></tr> <tr><td>5</td><td>0.94</td><td>28.24</td><td>-17.76</td><td>46.00</td><td>18.58</td><td>9.64</td><td>0.02</td><td>Average</td></tr> <tr><td>6</td><td>0.94</td><td>34.65</td><td>-21.35</td><td>56.00</td><td>24.99</td><td>9.64</td><td>0.02</td><td>QP</td></tr> <tr><td>7</td><td>1.85</td><td>21.37</td><td>-24.63</td><td>46.00</td><td>11.66</td><td>9.66</td><td>0.05</td><td>Average</td></tr> <tr><td>8</td><td>1.85</td><td>26.74</td><td>-29.26</td><td>56.00</td><td>17.03</td><td>9.66</td><td>0.05</td><td>QP</td></tr> <tr><td>9</td><td>10.61</td><td>22.76</td><td>-27.24</td><td>50.00</td><td>12.85</td><td>9.74</td><td>0.17</td><td>Average</td></tr> <tr><td>10</td><td>10.61</td><td>24.91</td><td>-35.09</td><td>60.00</td><td>15.00</td><td>9.74</td><td>0.17</td><td>QP</td></tr> <tr><td>11</td><td>24.78</td><td>20.79</td><td>-29.21</td><td>50.00</td><td>10.73</td><td>9.79</td><td>0.27</td><td>Average</td></tr> <tr><td>12</td><td>24.78</td><td>24.23</td><td>-35.77</td><td>60.00</td><td>14.17</td><td>9.79</td><td>0.27</td><td>QP</td></tr> </tbody> </table>					Freq	Level	Over Limit	Limit Line	Read Level	LISN Factor	Cable Loss	Remark		MHz	dBuV	dB	dBuV	dBuV	dB	dB		1	0.16	21.26	-34.19	55.45	11.54	9.70	0.02	Average	2	0.16	39.42	-26.03	65.45	29.70	9.70	0.02	QP	3 MAX	0.55	29.01	-16.99	46.00	19.35	9.64	0.02	Average	4	0.55	34.87	-21.13	56.00	25.21	9.64	0.02	QP	5	0.94	28.24	-17.76	46.00	18.58	9.64	0.02	Average	6	0.94	34.65	-21.35	56.00	24.99	9.64	0.02	QP	7	1.85	21.37	-24.63	46.00	11.66	9.66	0.05	Average	8	1.85	26.74	-29.26	56.00	17.03	9.66	0.05	QP	9	10.61	22.76	-27.24	50.00	12.85	9.74	0.17	Average	10	10.61	24.91	-35.09	60.00	15.00	9.74	0.17	QP	11	24.78	20.79	-29.21	50.00	10.73	9.79	0.27	Average	12	24.78	24.23	-35.77	60.00	14.17	9.79	0.27	QP
	Freq	Level	Over Limit	Limit Line	Read Level	LISN Factor	Cable Loss	Remark																																																																																																																									
	MHz	dBuV	dB	dBuV	dBuV	dB	dB																																																																																																																										
1	0.16	21.26	-34.19	55.45	11.54	9.70	0.02	Average																																																																																																																									
2	0.16	39.42	-26.03	65.45	29.70	9.70	0.02	QP																																																																																																																									
3 MAX	0.55	29.01	-16.99	46.00	19.35	9.64	0.02	Average																																																																																																																									
4	0.55	34.87	-21.13	56.00	25.21	9.64	0.02	QP																																																																																																																									
5	0.94	28.24	-17.76	46.00	18.58	9.64	0.02	Average																																																																																																																									
6	0.94	34.65	-21.35	56.00	24.99	9.64	0.02	QP																																																																																																																									
7	1.85	21.37	-24.63	46.00	11.66	9.66	0.05	Average																																																																																																																									
8	1.85	26.74	-29.26	56.00	17.03	9.66	0.05	QP																																																																																																																									
9	10.61	22.76	-27.24	50.00	12.85	9.74	0.17	Average																																																																																																																									
10	10.61	24.91	-35.09	60.00	15.00	9.74	0.17	QP																																																																																																																									
11	24.78	20.79	-29.21	50.00	10.73	9.79	0.27	Average																																																																																																																									
12	24.78	24.23	-35.77	60.00	14.17	9.79	0.27	QP																																																																																																																									
<p>Note 1: ">20dB" means emission levels that exceed the level of 20 dB below the applicable limit. Note 2: "N/F" means Nothing Found emissions (No emissions were detected.)</p>																																																																																																																																	



Summary

Mode	Max-N dB (Hz)	Max-OBW (Hz)	ITU-Code	Min-N dB (Hz)	Min-OBW (Hz)
BT-LE(1Mbps)	-	-	-	-	-
2.4-2.4835GHz	695k	1.027M	1M03F1D	686.25k	1.024M

Max-N dB = Maximum 6dB down bandwidth; Max-OBW = Maximum 99% occupied bandwidth;
Min-N dB = Minimum 6dB down bandwidth; Min-OBW = Minimum 99% occupied bandwidth;

Result

Mode	Result	Limit (Hz)	Port 1-N dB (Hz)	Port 1-OBW (Hz)
BT-LE(1Mbps)	-	-	-	-
2402MHz	Pass	500k	695k	1.026M
2440MHz	Pass	500k	686.25k	1.024M
2480MHz	Pass	500k	695k	1.027M

Port X-N dB = Port X 6dB down bandwidth; Port X-OBW = Port X 99% occupied bandwidth;

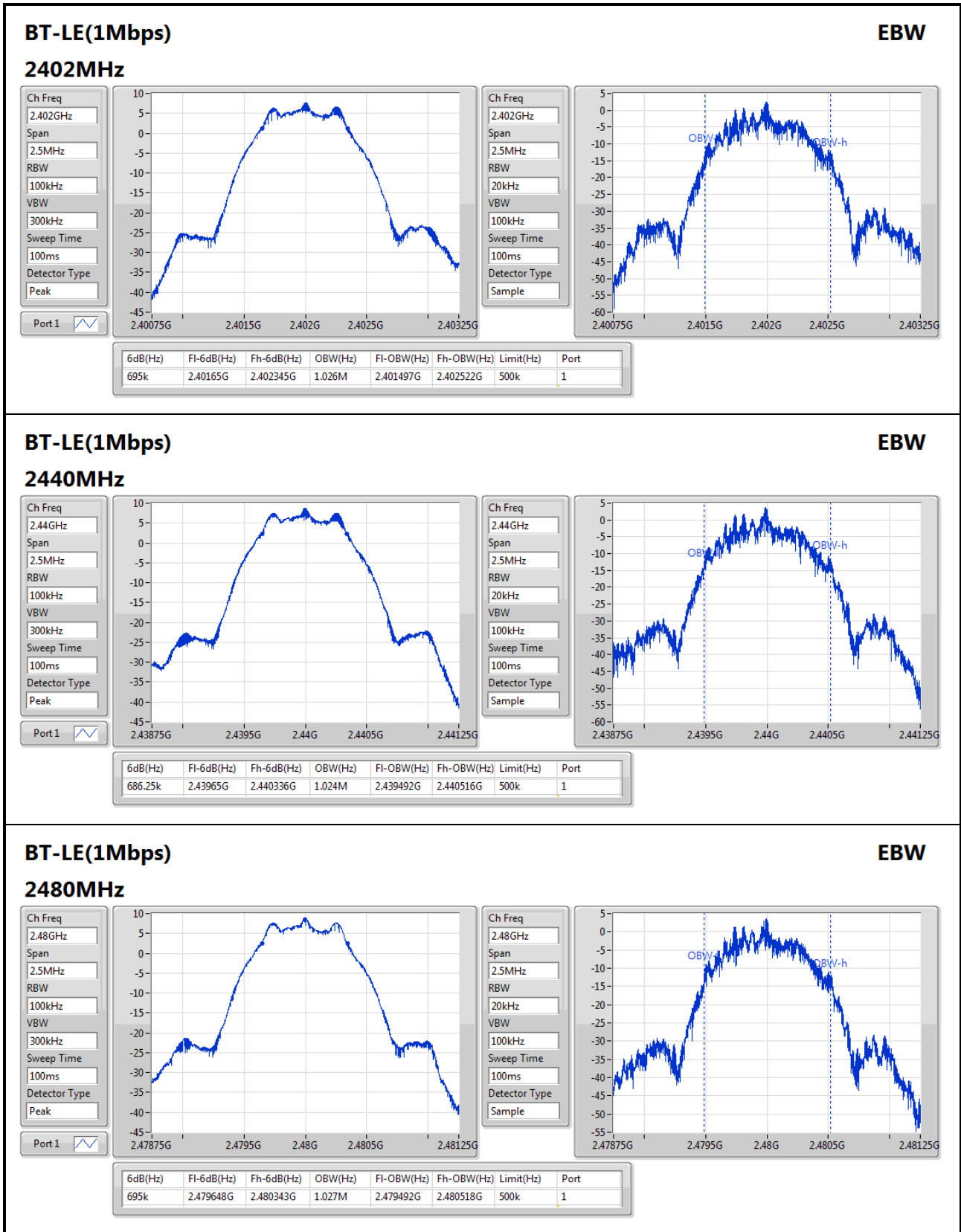



Summary

Mode	Power (dBm)	Power (W)
BT-LE(1Mbps)	-	-
2.4-2.4835GHz	8.62	0.00728

Result

Mode	Result	Gain (dBi)	Power (dBm)	Power Limit (dBm)
BT-LE(1Mbps)	-	-	-	-
2402MHz	Pass	3.78	6.15	30.00
2440MHz	Pass	3.78	8.26	30.00
2480MHz	Pass	3.78	8.62	30.00



Summary

Mode	PD (dBm/RBW)
BT-LE(1Mbps)	-
2.4-2.4835GHz	-7.62

RBW=3kHz.

Result

Mode	Result	Gain (dBi)	PD (dBm/RBW)	PD Limit (dBm/RBW)
BT-LE(1Mbps)	-	-	-	-
2402MHz	Pass	3.78	-10.59	8.00
2440MHz	Pass	3.78	-7.62	8.00
2480MHz	Pass	3.78	-7.77	8.00

RBW=3kHz.

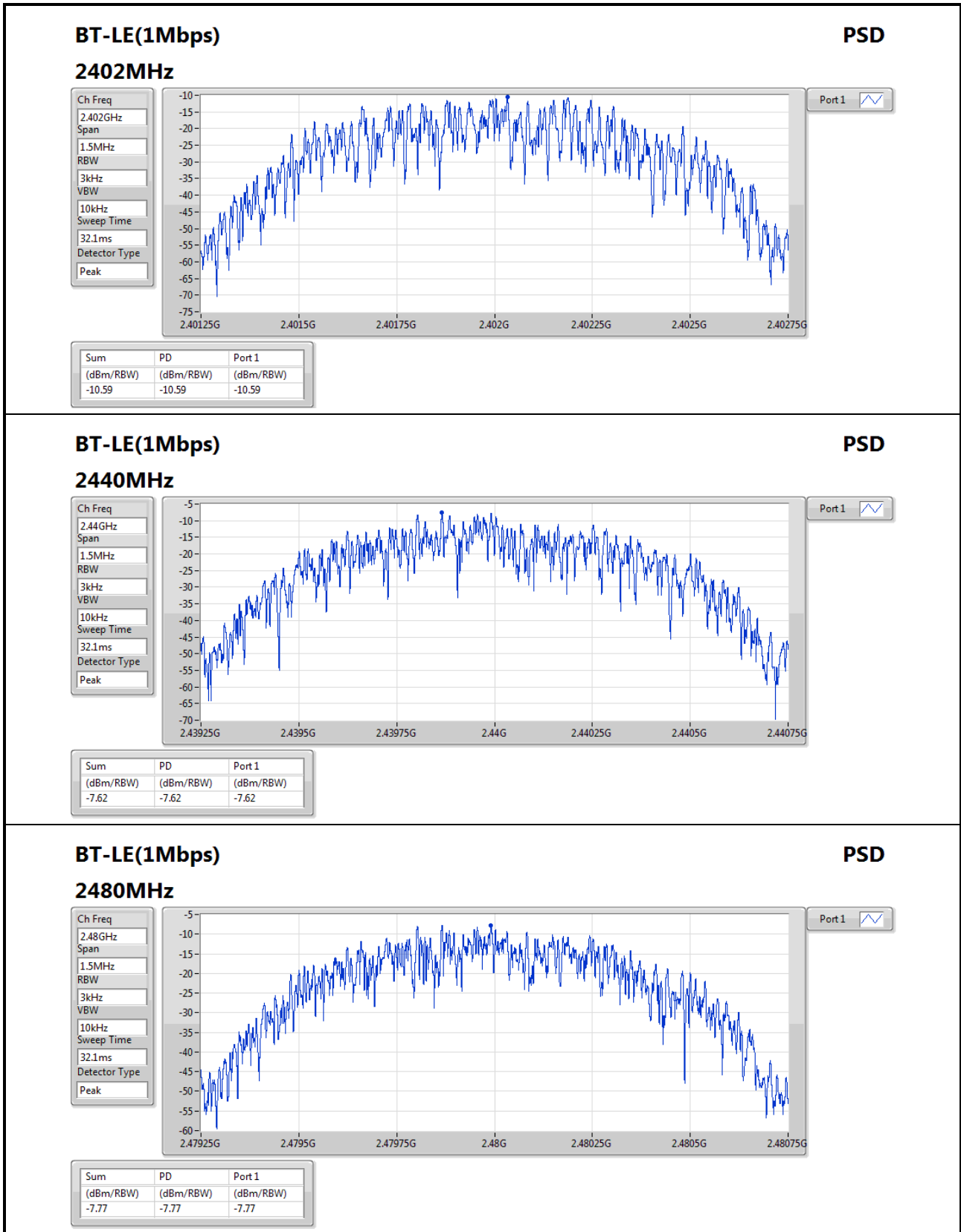



Summary

Mode	Result	Ref (Hz)	Ref (dBm)	Limit (dBm)	Freq (Hz)	Level (dBm)	Freq (Hz)	Level (dBm)	Freq (Hz)	Level (dBm)	Freq (Hz)	Level (dBm)	Port
BT-LE(1Mbps)	-	-	-	-	-	-	-	-	-	-	-	-	-
2.4-2.4835GHz	Pass	2.480327G	7.42	-22.58	1.846256G	-58.24	2.399992G	-43.88	2.48522G	-56.20	2.5052G	-48.03	1

Result

Mode	Result	Ref (Hz)	Ref (dBm)	Limit (dBm)	Freq (Hz)	Level (dBm)	Freq (Hz)	Level (dBm)	Freq (Hz)	Level (dBm)	Freq (Hz)	Level (dBm)	Port
BT-LE(1Mbps)	-	-	-	-	-	-	-	-	-	-	-	-	-
2402MHz	Pass	2.480327G	7.42	-22.58	1.846256G	-58.24	2.399992G	-43.88	2.48522G	-56.20	2.5052G	-48.03	1
2440MHz	Pass	2.480327G	7.42	-22.58	2.109104G	-57.42	2.398296G	-56.78	2.484404G	-56.46	2.541786G	-47.67	1
2480MHz	Pass	2.480327G	7.42	-22.58	665.808M	-57.77	2.399388G	-57.73	2.48396G	-50.14	2.581187G	-50.15	1

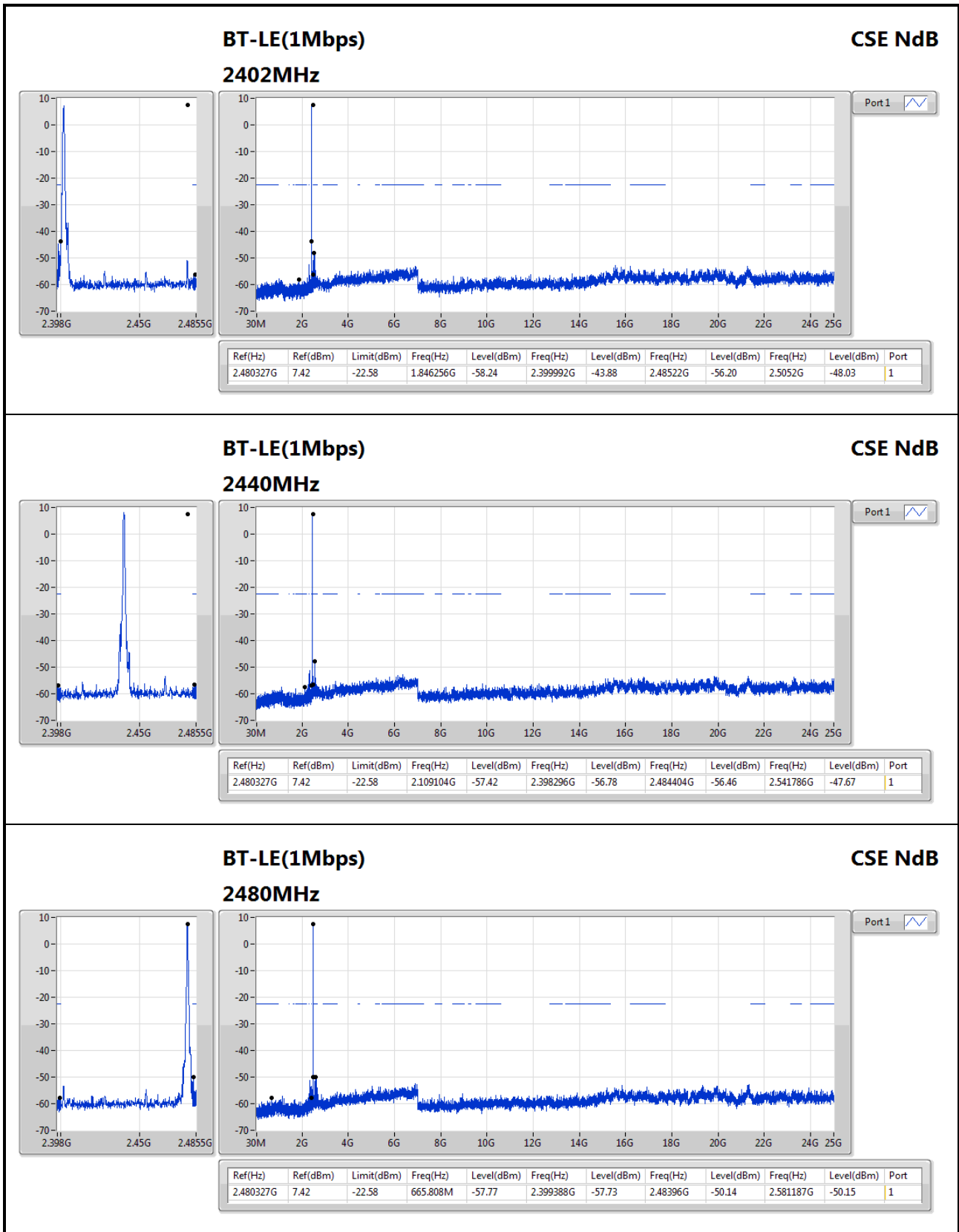



Summary

Mode	Result	Type	Freq (Hz)	Level (dBuV/m)	Limit (dBuV/m)	Margin (dB)	Factor (dB)	Dist (m)	Condition	Azimuth (°)	Height (m)	Comments
BT-LE(1Mbps)	-	-	-	-	-	-	-	-	-	-	-	-
2.4-2.4835GHz	Pass	PK	30M	35.93	40.00	-4.07	-4.25	3	Horizontal	360	1.00	-



Result

Mode	Result	Type	Freq (Hz)	Level (dBuV/m)	Limit (dBuV/m)	Margin (dB)	Factor (dB)	Dist (m)	Condition	Azimuth (°)	Height (m)	Comments
BT-LE(1Mbps)	-	-	-	-	-	-	-	-	-	-	-	-
2440MHz	Pass	PK	30M	35.93	40.00	-4.07	-4.25	3	Horizontal	360	1.00	-
2440MHz	Pass	PK	169.68M	32.67	43.50	-10.83	-10.76	3	Horizontal	360	1.00	-
2440MHz	Pass	PK	212.36M	31.48	43.50	-12.02	-11.01	3	Horizontal	360	1.00	-
2440MHz	Pass	PK	573.2M	32.74	46.00	-13.26	-1.05	3	Horizontal	360	1.00	-
2440MHz	Pass	PK	743.92M	32.64	46.00	-13.36	0.65	3	Horizontal	360	1.00	-
2440MHz	Pass	PK	978.66M	35.16	54.00	-18.84	3.61	3	Horizontal	360	1.00	-
2440MHz	Pass	PK	30M	34.91	40.00	-5.09	-4.25	3	Vertical	0	1.00	-
2440MHz	Pass	PK	53.28M	29.81	40.00	-10.19	-14.18	3	Vertical	0	1.00	-
2440MHz	Pass	PK	111.48M	29.00	43.50	-14.50	-9.31	3	Vertical	0	1.00	-
2440MHz	Pass	PK	604.24M	31.36	46.00	-14.64	-1.15	3	Vertical	0	1.00	-
2440MHz	Pass	PK	751.68M	33.02	46.00	-12.98	0.79	3	Vertical	0	1.00	-
2440MHz	Pass	PK	930.16M	34.25	46.00	-11.75	3.18	3	Vertical	0	1.00	-

BT-LE(1Mbps)

2440MHz_TX

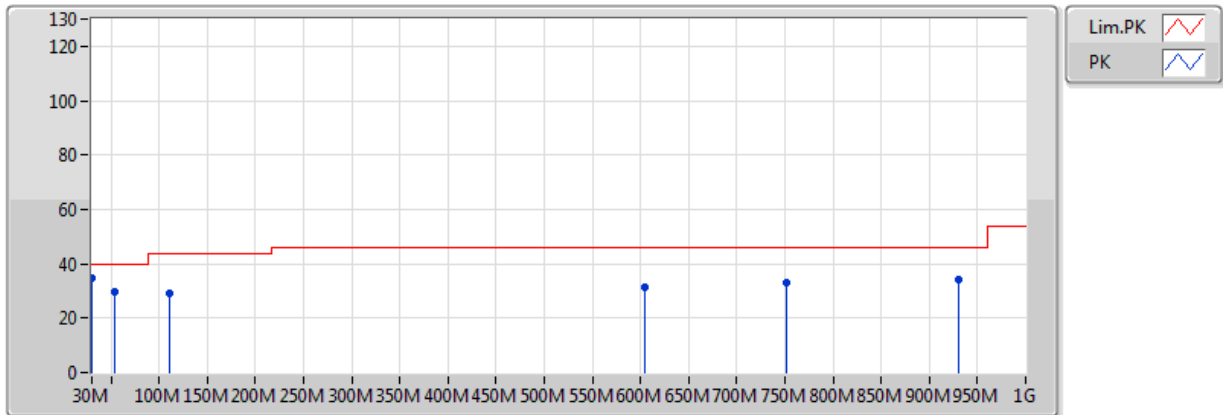

EUT = Y

Type	Freq (Hz)	Level (dBuV/m)	Limit (dBuV/m)	Margin (dB)	Factor (dB)	Dist (m)	Condition	Azimuth (°)	Height (m)	Comments	Raw (dBuV)	AF (dB)	CL (dB)	PA (dB)
PK	30M	34.91	40.00	-5.09	-4.25	3	Vertical	0	1.00	-	39.16	22.02	0.68	26.95
PK	53.28M	29.81	40.00	-10.19	-14.18	3	Vertical	0	1.00	-	43.99	12.58	1.03	27.79
PK	111.48M	29.00	43.50	-14.50	-9.31	3	Vertical	0	1.00	-	38.31	17.09	1.47	27.86
PK	604.24M	31.36	46.00	-14.64	-1.15	3	Vertical	0	1.00	-	32.51	23.70	3.67	28.52
PK	751.68M	33.02	46.00	-12.98	0.79	3	Vertical	0	1.00	-	32.23	24.75	4.18	28.14
PK	930.16M	34.25	46.00	-11.75	3.18	3	Vertical	0	1.00	-	31.07	25.65	4.95	27.42

BT-LE(1Mbps)

2440MHz_TX

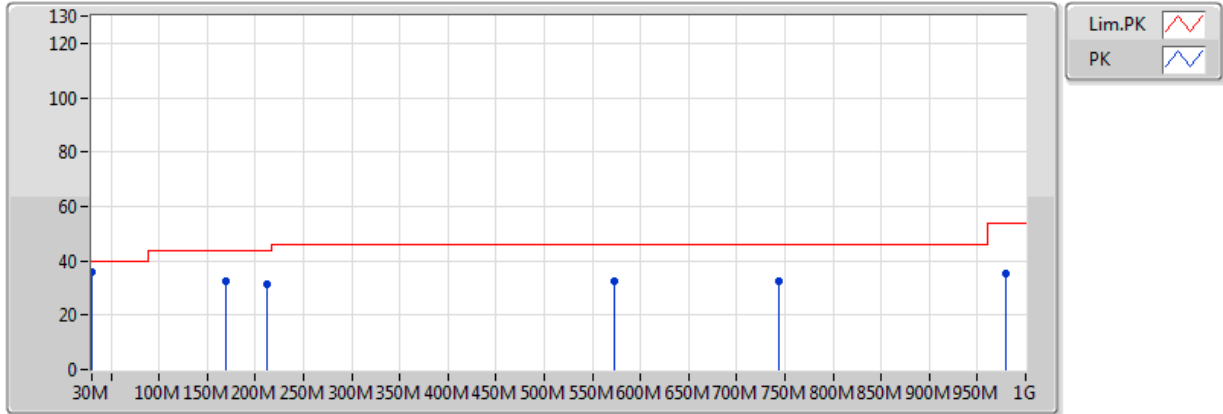

EUT = Y

Type	Freq (Hz)	Level (dBuV/m)	Limit (dBuV/m)	Margin (dB)	Factor (dB)	Dist (m)	Condition	Azimuth (°)	Height (m)	Comments	Raw (dBuV)	AF (dB)	CL (dB)	PA (dB)
PK	30M	35.93	40.00	-4.07	-4.25	3	Horizontal	360	1.00	-	40.18	22.02	0.68	26.95
PK	169.68M	32.67	43.50	-10.83	-10.76	3	Horizontal	360	1.00	-	43.43	14.83	1.92	27.51
PK	212.36M	31.48	43.50	-12.02	-11.01	3	Horizontal	360	1.00	-	42.49	14.12	2.23	27.36
PK	573.2M	32.74	46.00	-13.26	-1.05	3	Horizontal	360	1.00	-	33.79	23.75	3.63	28.43
PK	743.92M	32.64	46.00	-13.36	0.65	3	Horizontal	360	1.00	-	31.99	24.65	4.16	28.17
PK	978.66M	35.16	54.00	-18.84	3.61	3	Horizontal	360	1.00	-	31.55	25.92	4.90	27.21



Summary

Mode	Result	Type	Freq (Hz)	Level (dBuV/m)	Limit (dBuV/m)	Margin (dB)	Factor (dB)	Dist (m)	Condition	Azimuth (°)	Height (m)	Comments
BT-LE(1Mbps)	-	-	-	-	-	-	-	-	-	-	-	-
2.4-2.4835GHz	Pass	AV	2.483502G	52.12	54.00	-1.88	31.27	3	Horizontal	329	3.09	-



Result

Mode	Result	Type	Freq (Hz)	Level (dBUV/m)	Limit (dBUV/m)	Margin (dB)	Factor (dB)	Dist (m)	Condition	Azimuth (°)	Height (m)	Comments
BT-LE(1Mbps)	-	-	-	-	-	-	-	-	-	-	-	-
2402MHz	Pass	AV	2.3762G	44.34	54.00	-9.66	30.89	3	Horizontal	327	1.29	-
2402MHz	Pass	AV	2.402G	104.17	Inf	-Inf	30.98	3	Horizontal	327	1.29	-
2402MHz	Pass	AV	4.804G	35.75	54.00	-18.25	2.10	3	Horizontal	175	2.28	-
2402MHz	Pass	PK	2.3758G	55.04	74.00	-18.96	30.89	3	Horizontal	327	1.29	-
2402MHz	Pass	PK	2.4022G	105.68	Inf	-Inf	30.98	3	Horizontal	327	1.29	-
2402MHz	Pass	PK	4.804G	45.38	74.00	-28.62	2.10	3	Horizontal	175	2.28	-
2402MHz	Pass	AV	2.3846G	44.35	54.00	-9.65	30.92	3	Vertical	217	1.18	-
2402MHz	Pass	AV	2.402G	97.74	Inf	-Inf	30.98	3	Vertical	217	1.18	-
2402MHz	Pass	AV	4.804G	34.13	54.00	-19.87	2.10	3	Vertical	185	1.39	-
2402MHz	Pass	PK	2.3794G	55.13	74.00	-18.87	30.90	3	Vertical	217	1.18	-
2402MHz	Pass	PK	2.4022G	99.31	Inf	-Inf	30.98	3	Vertical	217	1.18	-
2402MHz	Pass	PK	4.804G	45.57	74.00	-28.43	2.10	3	Vertical	185	1.39	-
2440MHz	Pass	AV	2.3616G	44.51	54.00	-9.49	30.84	3	Horizontal	320	2.29	-
2440MHz	Pass	AV	2.44G	104.21	Inf	-Inf	31.11	3	Horizontal	320	2.29	-
2440MHz	Pass	AV	2.492G	45.47	54.00	-8.53	31.30	3	Horizontal	320	2.29	-
2440MHz	Pass	AV	4.88G	34.76	54.00	-19.24	2.34	3	Horizontal	162	1.50	-
2440MHz	Pass	PK	2.3884G	55.86	74.00	-18.14	30.93	3	Horizontal	320	2.29	-
2440MHz	Pass	PK	2.4396G	105.66	Inf	-Inf	31.11	3	Horizontal	320	2.29	-
2440MHz	Pass	PK	2.4952G	55.20	74.00	-18.80	31.31	3	Horizontal	320	2.29	-
2440MHz	Pass	PK	4.88G	45.15	74.00	-28.85	2.34	3	Horizontal	162	1.50	-
2440MHz	Pass	AV	2.3764G	44.09	54.00	-9.91	30.89	3	Vertical	21	3.66	-
2440MHz	Pass	AV	2.44G	99.41	Inf	-Inf	31.11	3	Vertical	21	3.66	-
2440MHz	Pass	AV	2.4948G	44.66	54.00	-9.34	31.31	3	Vertical	21	3.66	-
2440MHz	Pass	AV	4.88G	34.99	54.00	-19.01	2.34	3	Vertical	186	1.11	-
2440MHz	Pass	PK	2.374G	55.20	74.00	-18.80	30.88	3	Vertical	21	3.66	-
2440MHz	Pass	PK	2.4396G	100.87	Inf	-Inf	31.11	3	Vertical	21	3.66	-
2440MHz	Pass	PK	2.4948G	55.73	74.00	-18.27	31.31	3	Vertical	21	3.66	-
2440MHz	Pass	PK	4.88G	45.14	74.00	-28.86	2.34	3	Vertical	186	1.11	-
2480MHz	Pass	AV	2.48G	104.67	Inf	-Inf	31.26	3	Horizontal	329	3.09	-
2480MHz	Pass	AV	2.483502G	52.12	54.00	-1.88	31.27	3	Horizontal	329	3.09	-
2480MHz	Pass	AV	7.44G	46.01	54.00	-7.99	7.95	3	Horizontal	185	1.05	-
2480MHz	Pass	PK	2.4798G	106.11	Inf	-Inf	31.26	3	Horizontal	329	3.09	-
2480MHz	Pass	PK	2.483502G	59.72	74.00	-14.28	31.27	3	Horizontal	329	3.09	-
2480MHz	Pass	PK	7.44G	55.40	74.00	-18.60	7.95	3	Horizontal	185	1.05	-
2480MHz	Pass	AV	2.48G	99.90	Inf	-Inf	31.26	3	Vertical	29	1.76	-
2480MHz	Pass	AV	2.483502G	48.15	54.00	-5.85	31.27	3	Vertical	29	1.76	-
2480MHz	Pass	AV	4.96G	35.88	54.00	-18.12	2.59	3	Vertical	189	2.68	-
2480MHz	Pass	PK	2.4798G	101.43	Inf	-Inf	31.26	3	Vertical	29	1.76	-
2480MHz	Pass	PK	2.483502G	57.03	74.00	-16.97	31.27	3	Vertical	29	1.76	-
2480MHz	Pass	PK	4.96G	46.25	74.00	-27.75	2.59	3	Vertical	189	2.68	-

BT-LE(1Mbps)

2402MHz_TX

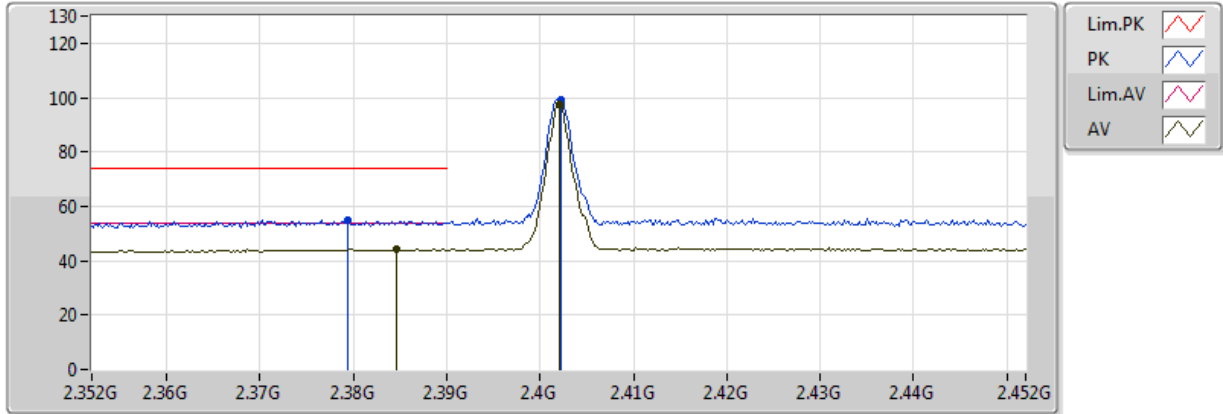

EUT = Y

Type	Freq (Hz)	Level (dBuV/m)	Limit (dBuV/m)	Margin (dB)	Factor (dB)	Dist (m)	Condition	Azimuth (°)	Height (m)	Comments	Raw (dBuV)	AF (dB)	CL (dB)	PA (dB)
AV	2.3846G	44.35	54.00	-9.65	30.92	3	Vertical	217	1.18	-	13.44	27.30	3.62	-
AV	2.402G	97.74	Inf	-Inf	30.98	3	Vertical	217	1.18	-	66.77	27.35	3.63	-
PK	2.3794G	55.13	74.00	-18.87	30.90	3	Vertical	217	1.18	-	24.24	27.29	3.61	-
PK	2.4022G	99.31	Inf	-Inf	30.98	3	Vertical	217	1.18	-	68.33	27.35	3.63	-

BT-LE(1Mbps)

2402MHz_TX

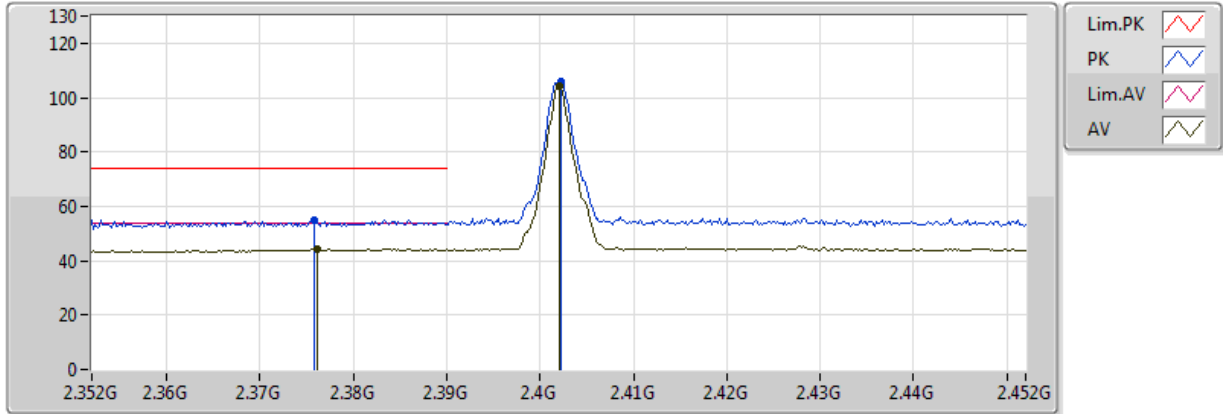

EUT = Y

Type	Freq (Hz)	Level (dBuV/m)	Limit (dBuV/m)	Margin (dB)	Factor (dB)	Dist (m)	Condition	Azimuth (°)	Height (m)	Comments	Raw (dBuV)	AF (dB)	CL (dB)	PA (dB)
AV	2.3762G	44.34	54.00	-9.66	30.89	3	Horizontal	327	1.29	-	13.46	27.28	3.61	-
AV	2.402G	104.17	Inf	-Inf	30.98	3	Horizontal	327	1.29	-	73.19	27.35	3.63	-
PK	2.3758G	55.04	74.00	-18.96	30.89	3	Horizontal	327	1.29	-	24.15	27.28	3.61	-
PK	2.4022G	105.68	Inf	-Inf	30.98	3	Horizontal	327	1.29	-	74.70	27.35	3.63	-

BT-LE(1Mbps)

2402MHz_TX

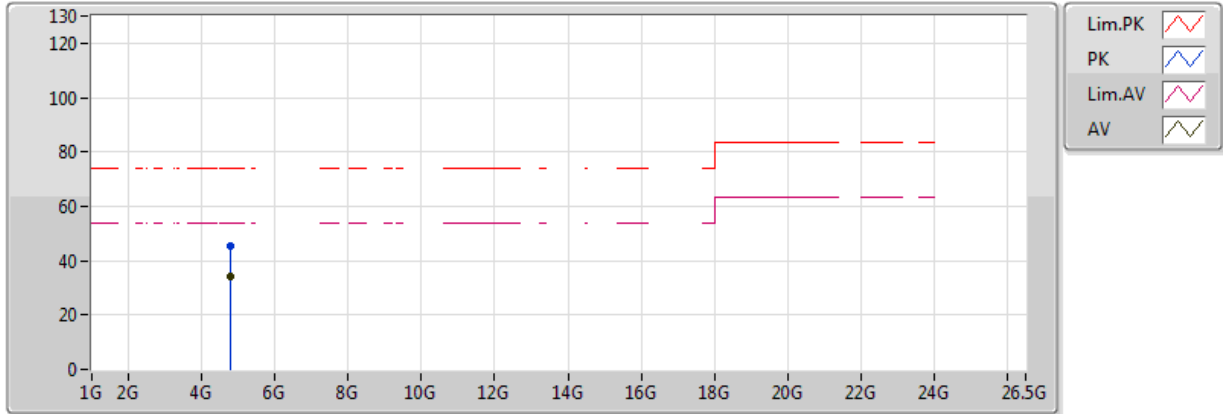

EUT = Y

Type	Freq (Hz)	Level (dBuV/m)	Limit (dBuV/m)	Margin (dB)	Factor (dB)	Dist (m)	Condition	Azimuth (°)	Height (m)	Comments	Raw (dBuV)	AF (dB)	CL (dB)	PA (dB)
AV	4.804G	34.13	54.00	-19.87	2.10	3	Vertical	185	1.39	-	32.03	31.25	5.38	34.53
PK	4.804G	45.57	74.00	-28.43	2.10	3	Vertical	185	1.39	-	43.47	31.25	5.38	34.53

BT-LE(1Mbps)

2402MHz_TX

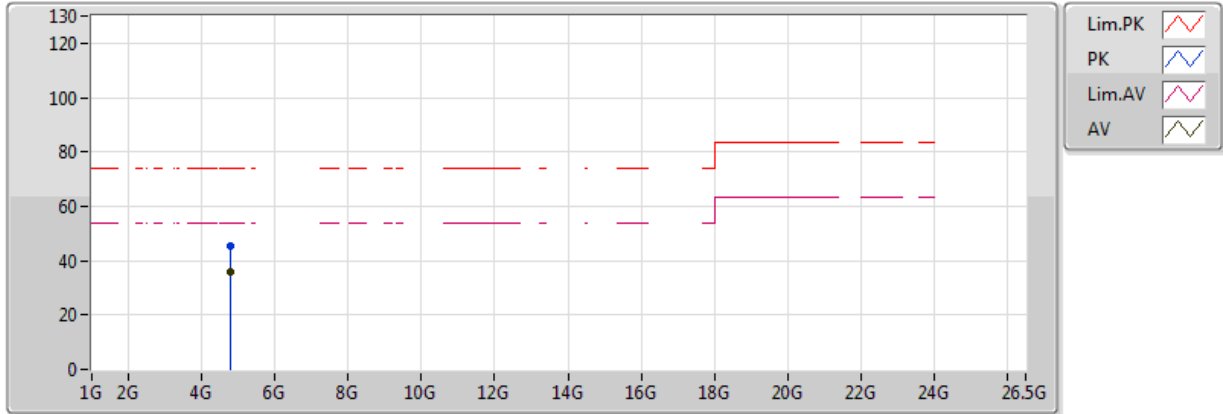

EUT = Y

Type	Freq (Hz)	Level (dBuV/m)	Limit (dBuV/m)	Margin (dB)	Factor (dB)	Dist (m)	Condition	Azimuth (°)	Height (m)	Comments	Raw (dBuV)	AF (dB)	CL (dB)	PA (dB)
AV	4.804G	35.75	54.00	-18.25	2.10	3	Horizontal	175	2.28	-	33.65	31.25	5.38	34.53
PK	4.804G	45.38	74.00	-28.62	2.10	3	Horizontal	175	2.28	-	43.28	31.25	5.38	34.53

BT-LE(1Mbps)

2440MHz_TX

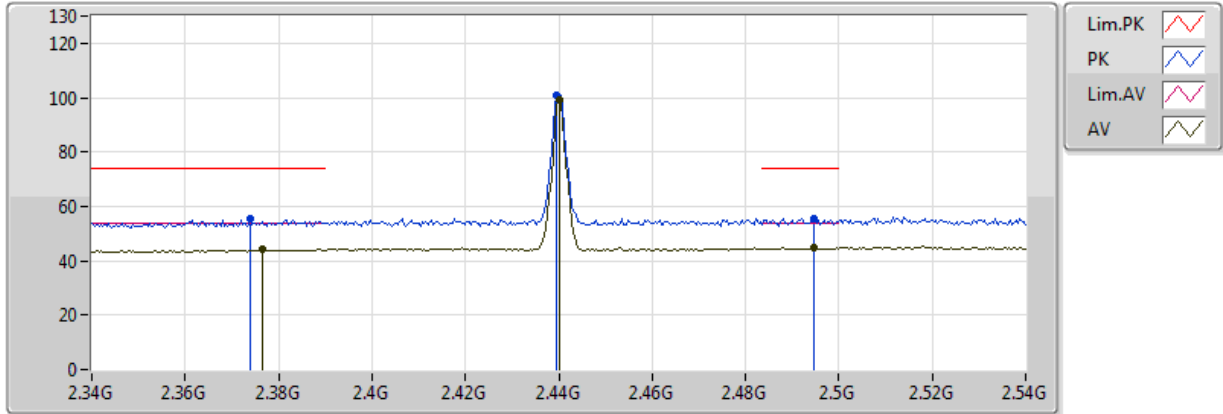

EUT = Y

Type	Freq (Hz)	Level (dBuV/m)	Limit (dBuV/m)	Margin (dB)	Factor (dB)	Dist (m)	Condition	Azimuth (°)	Height (m)	Comments	Raw (dBuV)	AF (dB)	CL (dB)	PA (dB)
AV	2.3764G	44.09	54.00	-9.91	30.89	3	Vertical	21	3.66	-	13.20	27.28	3.61	-
AV	2.44G	99.41	Inf	-Inf	31.11	3	Vertical	21	3.66	-	68.29	27.44	3.67	-
AV	2.4948G	44.66	54.00	-9.34	31.31	3	Vertical	21	3.66	-	13.35	27.59	3.72	-
PK	2.374G	55.20	74.00	-18.80	30.88	3	Vertical	21	3.66	-	24.32	27.27	3.61	-
PK	2.4396G	100.87	Inf	-Inf	31.11	3	Vertical	21	3.66	-	69.76	27.44	3.67	-
PK	2.4948G	55.73	74.00	-18.27	31.31	3	Vertical	21	3.66	-	24.42	27.59	3.72	-

BT-LE(1Mbps)

2440MHz_TX

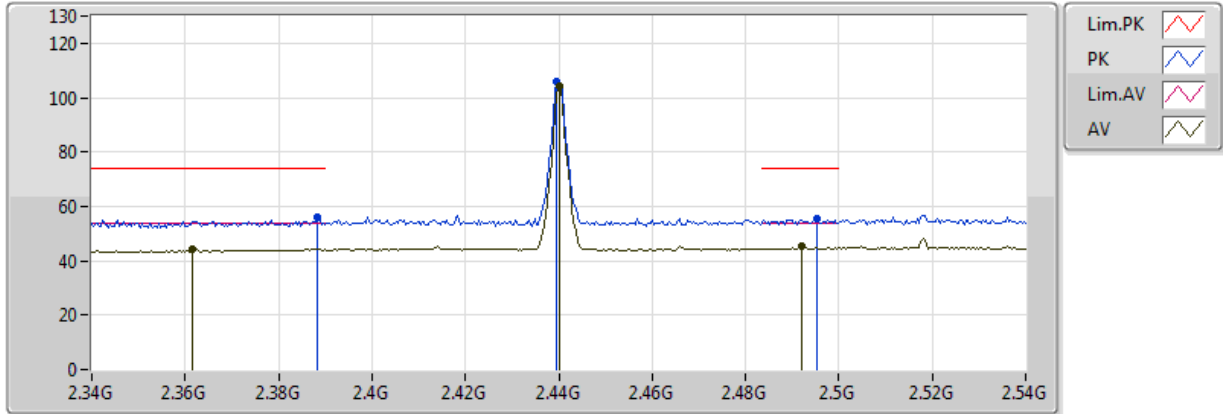

EUT = Y

Type	Freq (Hz)	Level (dBuV/m)	Limit (dBuV/m)	Margin (dB)	Factor (dB)	Dist (m)	Condition	Azimuth (°)	Height (m)	Comments	Raw (dBuV)	AF (dB)	CL (dB)	PA (dB)
AV	2.3616G	44.51	54.00	-9.49	30.84	3	Horizontal	320	2.29	-	13.67	27.24	3.60	-
AV	2.44G	104.21	Inf	-Inf	31.11	3	Horizontal	320	2.29	-	73.10	27.44	3.67	-
AV	2.492G	45.47	54.00	-8.53	31.30	3	Horizontal	320	2.29	-	14.17	27.58	3.72	-
PK	2.3884G	55.86	74.00	-18.14	30.93	3	Horizontal	320	2.29	-	24.93	27.31	3.62	-
PK	2.4396G	105.66	Inf	-Inf	31.11	3	Horizontal	320	2.29	-	74.55	27.44	3.67	-
PK	2.4952G	55.20	74.00	-18.80	31.31	3	Horizontal	320	2.29	-	23.88	27.59	3.73	-

BT-LE(1Mbps)

2440MHz_TX

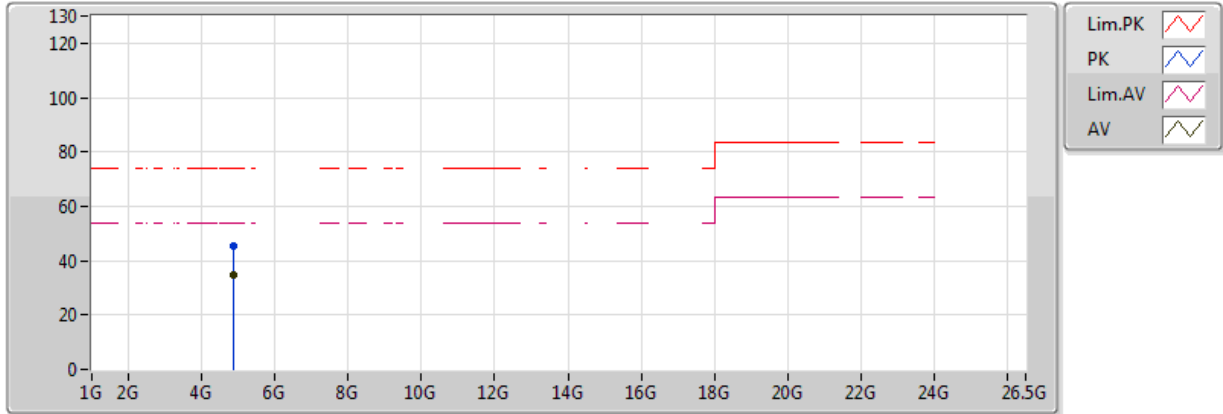

EUT = Y

Type	Freq (Hz)	Level (dBuV/m)	Limit (dBuV/m)	Margin (dB)	Factor (dB)	Dist (m)	Condition	Azimuth (°)	Height (m)	Comments	Raw (dBuV)	AF (dB)	CL (dB)	PA (dB)
AV	4.88G	34.99	54.00	-19.01	2.34	3	Vertical	186	1.11	-	32.65	31.38	5.47	34.51
PK	4.88G	45.14	74.00	-28.86	2.34	3	Vertical	186	1.11	-	42.80	31.38	5.47	34.51

BT-LE(1Mbps)

2440MHz_TX

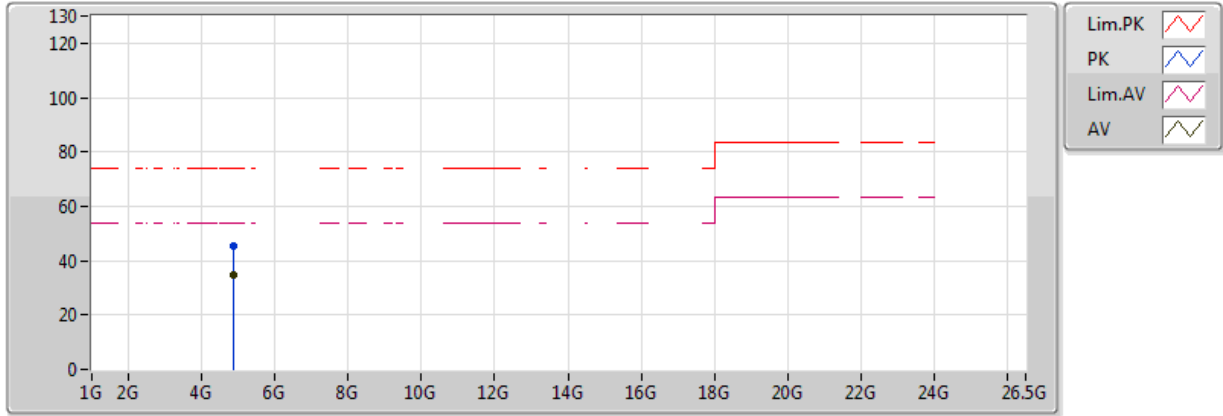

EUT = Y

Type	Freq (Hz)	Level (dBuV/m)	Limit (dBuV/m)	Margin (dB)	Factor (dB)	Dist (m)	Condition	Azimuth (°)	Height (m)	Comments	Raw (dBuV)	AF (dB)	CL (dB)	PA (dB)
AV	4.88G	34.76	54.00	-19.24	2.34	3	Horizontal	162	1.50	-	32.42	31.38	5.47	34.51
PK	4.88G	45.15	74.00	-28.85	2.34	3	Horizontal	162	1.50	-	42.81	31.38	5.47	34.51

BT-LE(1Mbps)

2480MHz_TX

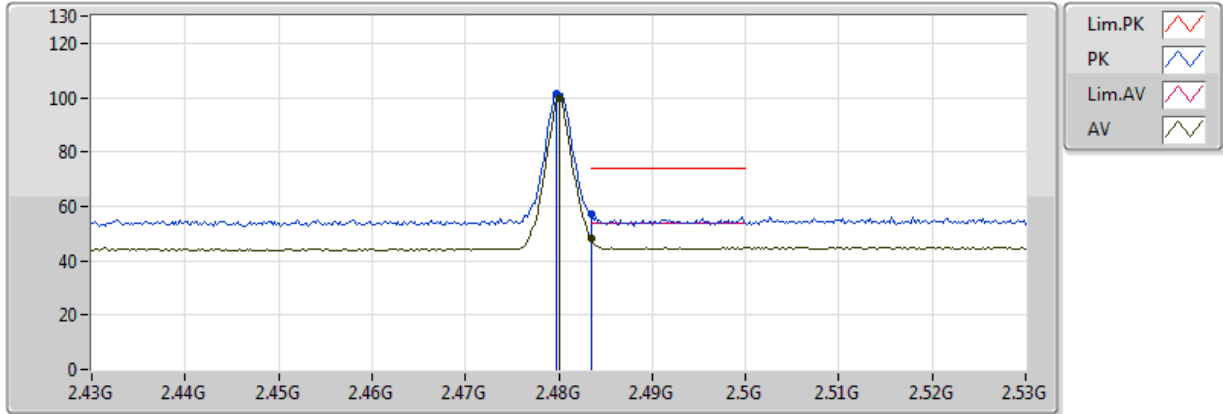

EUT = Y

Type	Freq (Hz)	Level (dBuV/m)	Limit (dBuV/m)	Margin (dB)	Factor (dB)	Dist (m)	Condition	Azimuth (°)	Height (m)	Comments	Raw (dBuV)	AF (dB)	CL (dB)	PA (dB)
AV	2.48G	99.90	Inf	-Inf	31.26	3	Vertical	29	1.76	-	68.64	27.55	3.71	-
AV	2.483502G	48.15	54.00	-5.85	31.27	3	Vertical	29	1.76	-	16.88	27.56	3.71	-
PK	2.4798G	101.43	Inf	-Inf	31.26	3	Vertical	29	1.76	-	70.17	27.55	3.71	-
PK	2.483502G	57.03	74.00	-16.97	31.27	3	Vertical	29	1.76	-	25.76	27.56	3.71	-

BT-LE(1Mbps)

2480MHz_TX

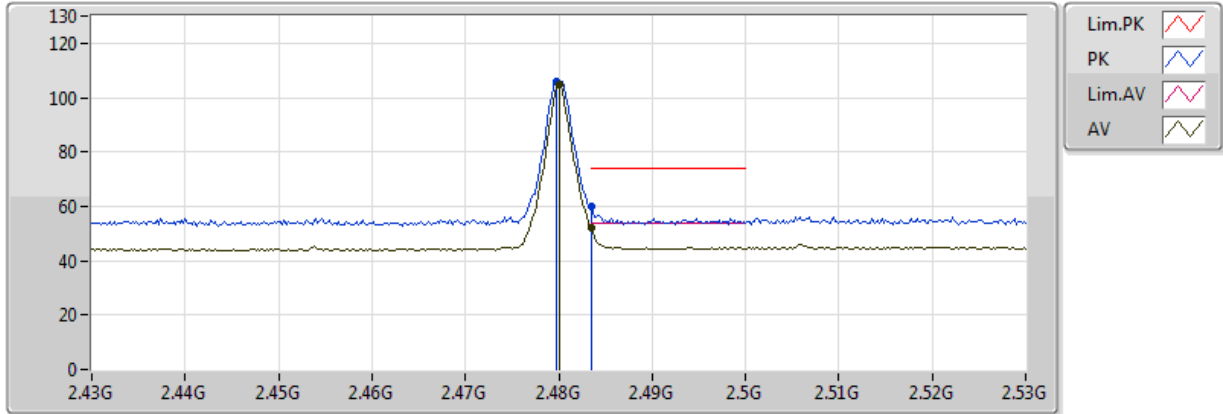

EUT = Y

Type	Freq (Hz)	Level (dBuV/m)	Limit (dBuV/m)	Margin (dB)	Factor (dB)	Dist (m)	Condition	Azimuth (°)	Height (m)	Comments	Raw (dBuV)	AF (dB)	CL (dB)	PA (dB)
AV	2.48G	104.67	Inf	-Inf	31.26	3	Horizontal	329	3.09	-	73.41	27.55	3.71	-
AV	2.483502G	52.12	54.00	-1.88	31.27	3	Horizontal	329	3.09	-	20.85	27.56	3.71	-
PK	2.4798G	106.11	Inf	-Inf	31.26	3	Horizontal	329	3.09	-	74.85	27.55	3.71	-
PK	2.483502G	59.72	74.00	-14.28	31.27	3	Horizontal	329	3.09	-	28.45	27.56	3.71	-

BT-LE(1Mbps)

2480MHz_TX

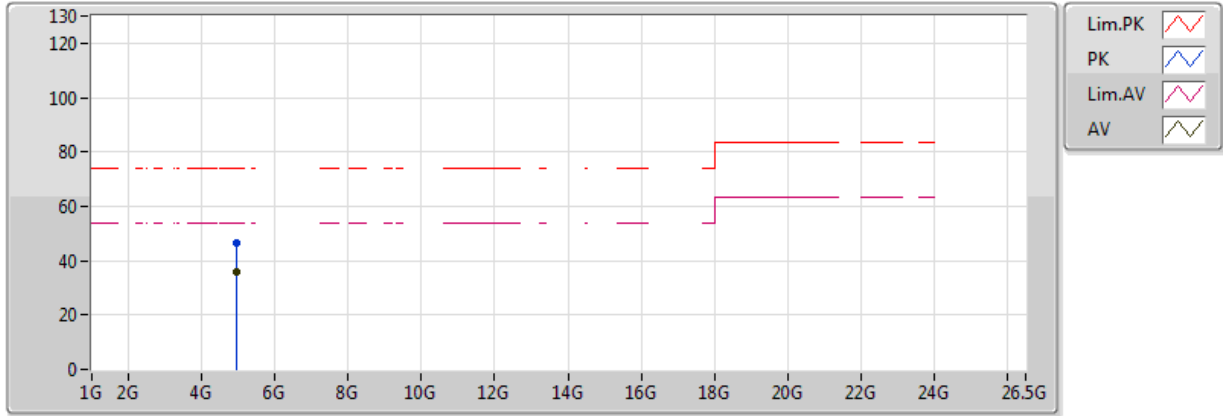

EUT = Y

Type	Freq (Hz)	Level (dBuV/m)	Limit (dBuV/m)	Margin (dB)	Factor (dB)	Dist (m)	Condition	Azimuth (°)	Height (m)	Comments	Raw (dBuV)	AF (dB)	CL (dB)	PA (dB)
AV	4.96G	35.88	54.00	-18.12	2.59	3	Vertical	189	2.68	-	33.29	31.53	5.56	34.49
PK	4.96G	46.25	74.00	-27.75	2.59	3	Vertical	189	2.68	-	43.66	31.53	5.56	34.49

BT-LE(1Mbps)

2480MHz_TX

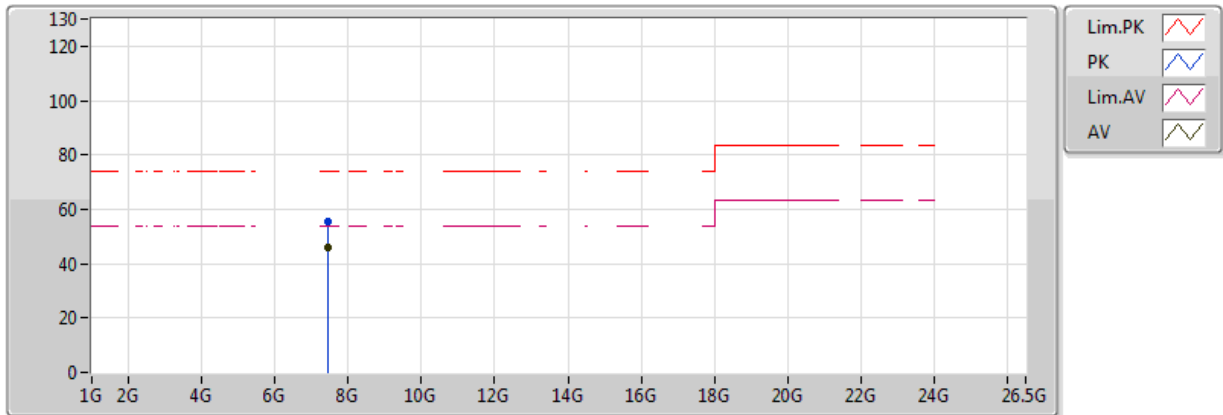

EUT = Y

Type	Freq (Hz)	Level (dBuV/m)	Limit (dBuV/m)	Margin (dB)	Factor (dB)	Dist (m)	Condition	Azimuth (°)	Height (m)	Comments	Raw (dBuV)	AF (dB)	CL (dB)	PA (dB)
AV	7.44G	46.01	54.00	-7.99	7.95	3	Horizontal	185	1.05	-	38.06	36.14	6.68	34.87
PK	7.44G	55.40	74.00	-18.60	7.95	3	Horizontal	185	1.05	-	47.45	36.14	6.68	34.87



Radiated Emission Co-Location (Below 1GHz)

Operating Mode	1	Polarization	V
-----------------------	---	---------------------	---

Operating Function	(Y Plane)WiFi 2.4G & 5G , BT ON , ETH1 : 1Gbps
---------------------------	--

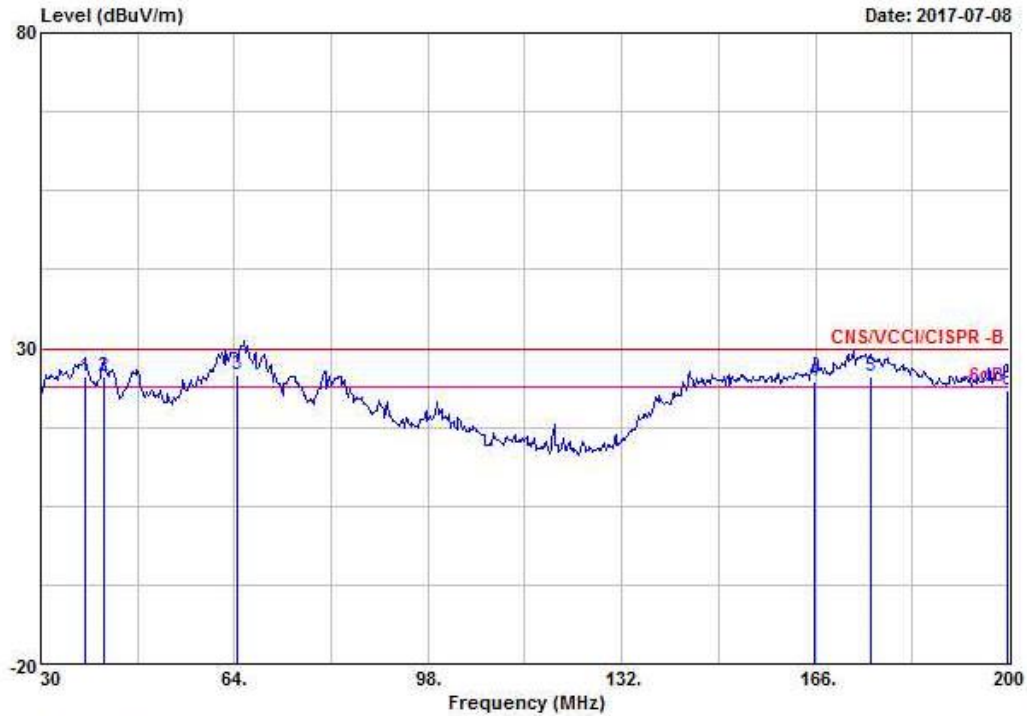

	Freq	Level	Over	Limit	Read	Preamp	CableAntenna		Remark	Ant	Table
	MHz	dBuV/m	Limit	Line	Level	Factor	Loss	Factor		Pos	Pos
			dB	dBuV/m	dBuV	dB	dB	dB/m		cm	deg
1 !	37.820	25.42	-4.58	30.00	40.37	28.26	1.77	11.54	QP	100	270
2 !	41.220	25.47	-4.53	30.00	40.87	28.26	1.85	11.01	QP	100	250
3 e	64.410	25.87	-4.13	30.00	42.40	28.20	2.33	9.34	QP	100	210
4 !	165.830	24.58	-5.42	30.00	36.14	27.78	3.77	12.45	QP	100	145
5 !	175.630	25.61	-4.39	30.00	36.46	27.74	3.86	13.03	QP	100	180
6	199.660	23.44	-6.56	30.00	32.11	27.62	4.29	14.66	QP	100	136

Note 1: ">20dB" means spurious emission levels that exceed the level of 20 dB below the applicable limit.
 Note 2: "N/F" means Nothing Found spurious emissions (No spurious emissions were detected.)
 Note 3: Measurement receive antenna polarization: H (Horizontal), V (Vertical)

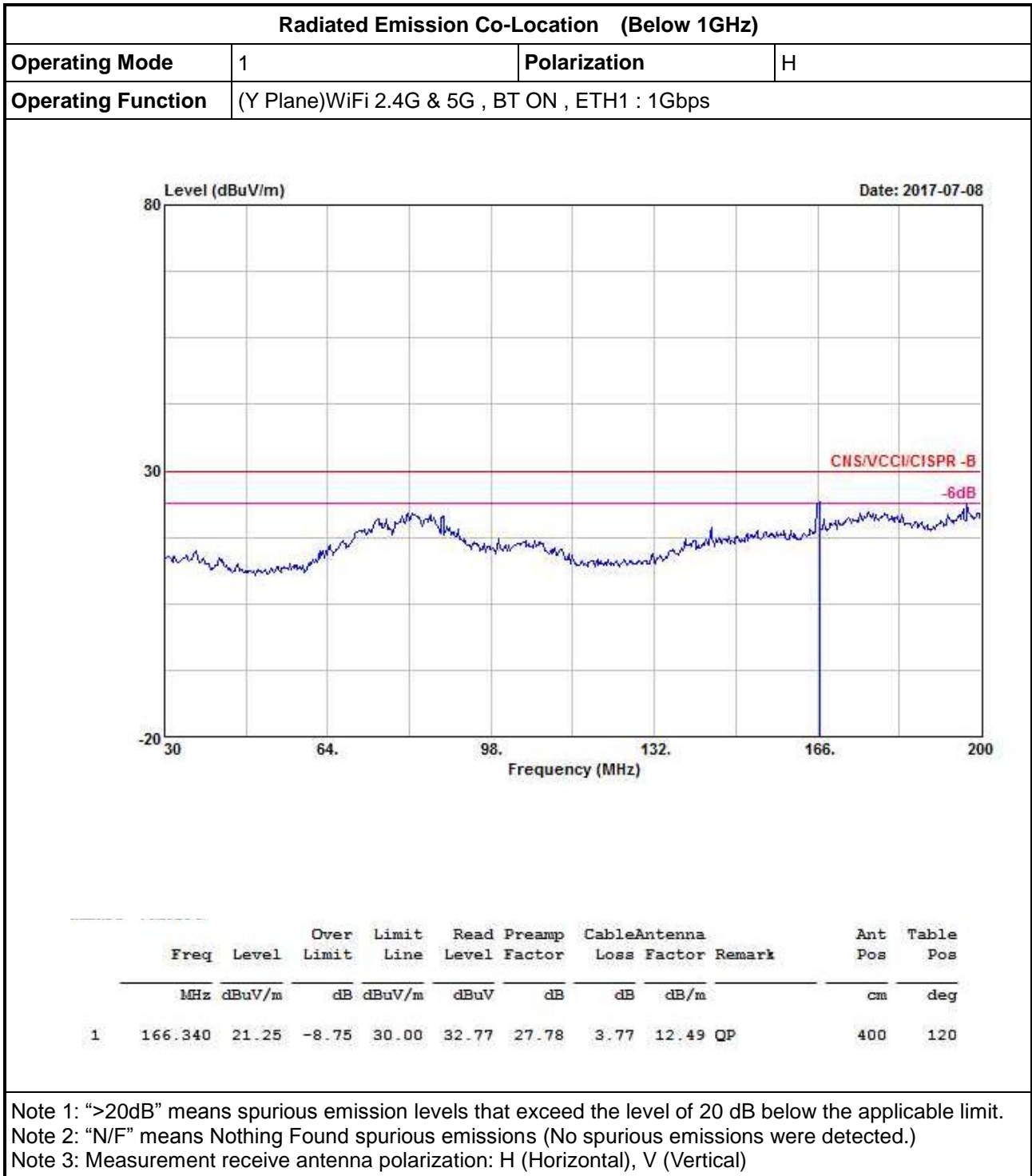

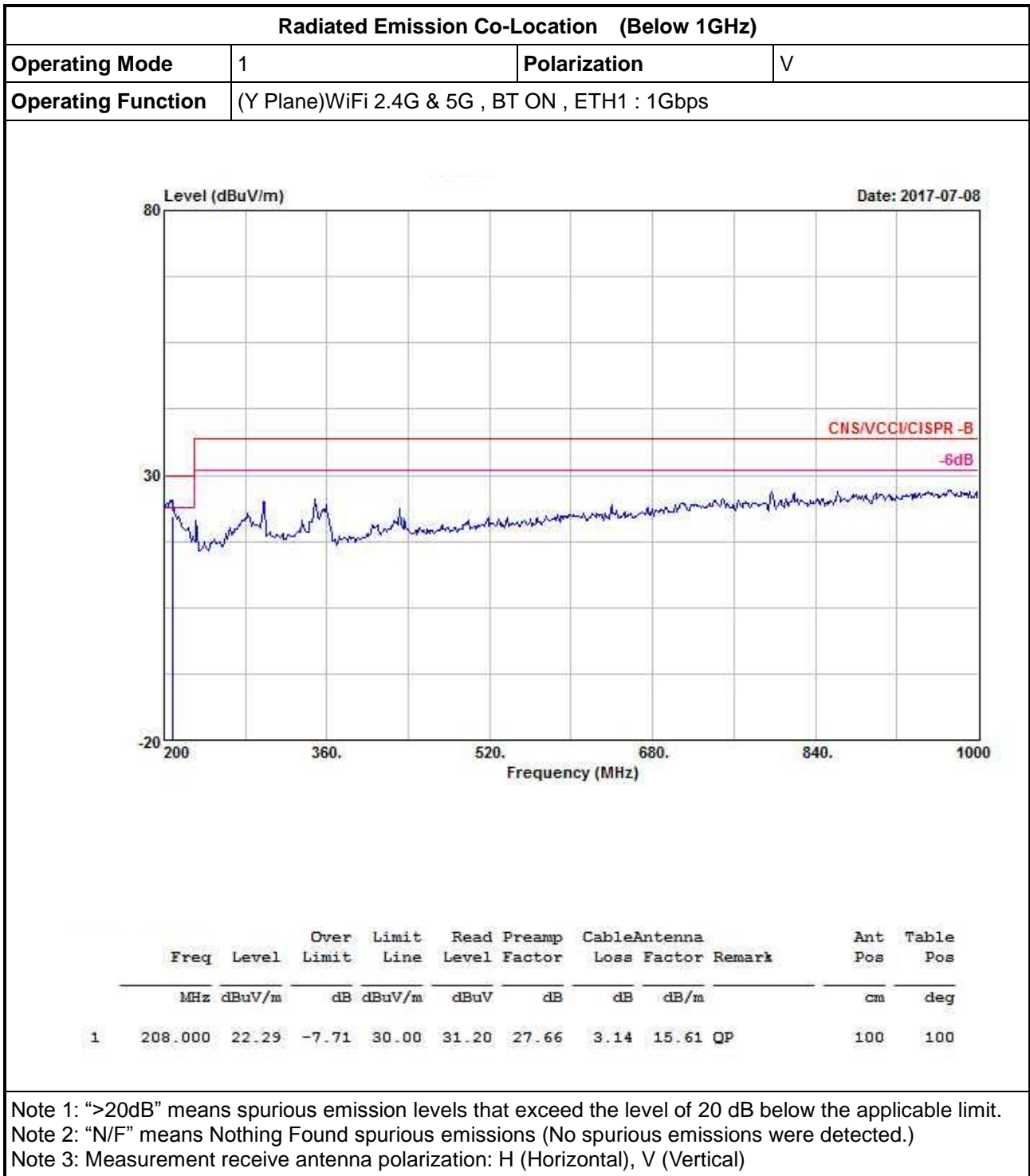

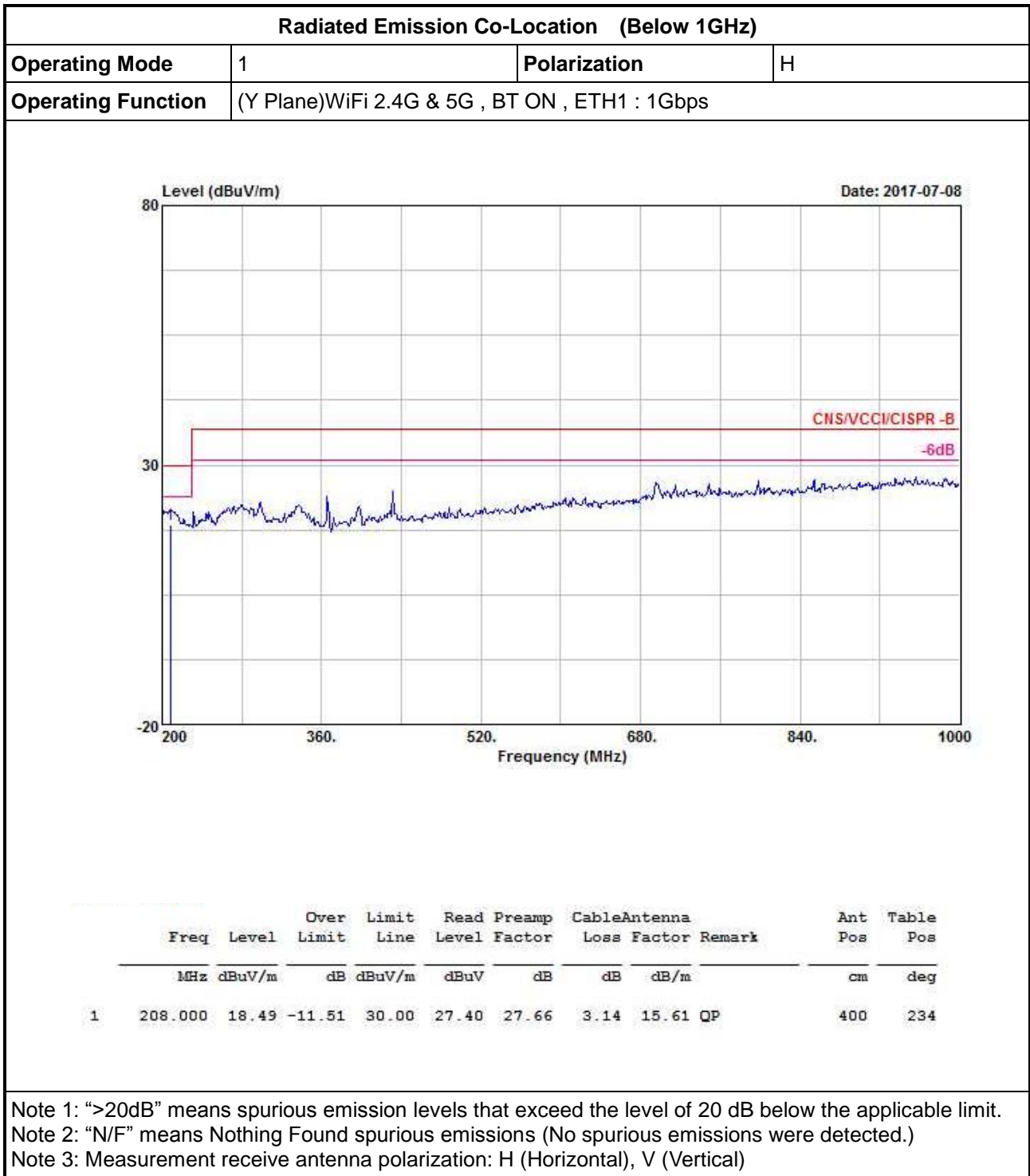



Summary

Mode	Result	Type	Freq (Hz)	Level (dBuV/m)	Limit (dBuV/m)	Margin (dB)	Factor (dB)	Dist (m)	Condition	Azimuth (°)	Height (m)	Comments
Mode 1.	Pass	AV	3.335G	28.70	54.00	-25.30	-1.20	3	Horizontal	360	1.00	-
Mode 2.	Pass	AV	3.425G	29.78	54.00	-24.22	-1.11	3	Horizontal	0	1.00	-



Result

Mode	Result	Type	Freq (Hz)	Level (dBuV/m)	Limit (dBuV/m)	Margin (dB)	Factor (dB)	Dist (m)	Condition	Azimuth (°)	Height (m)	Comments
Mode 1.	Pass	AV	3.335G	28.70	54.00	-25.30	-1.20	3	Horizontal	360	1.00	-
Mode 1.	Pass	PK	3.335G	42.80	74.00	-31.20	-1.20	3	Horizontal	360	1.00	-
Mode 1.	Pass	AV	2.852G	27.97	54.00	-26.03	-1.88	3	Vertical	0	1.00	-
Mode 1.	Pass	PK	2.852G	41.35	74.00	-32.65	-1.88	3	Vertical	0	1.00	-
Mode 2.	Pass	AV	3.425G	29.78	54.00	-24.22	-1.11	3	Horizontal	0	1.00	-
Mode 2.	Pass	PK	3.425G	43.56	74.00	-30.44	-1.11	3	Horizontal	0	1.00	-
Mode 2.	Pass	AV	2.728G	28.49	54.00	-25.51	-2.18	3	Vertical	360	1.00	-
Mode 2.	Pass	PK	2.728G	42.16	74.00	-31.84	-2.18	3	Vertical	360	1.00	-



Radiated-above 1GHz_Mode 1

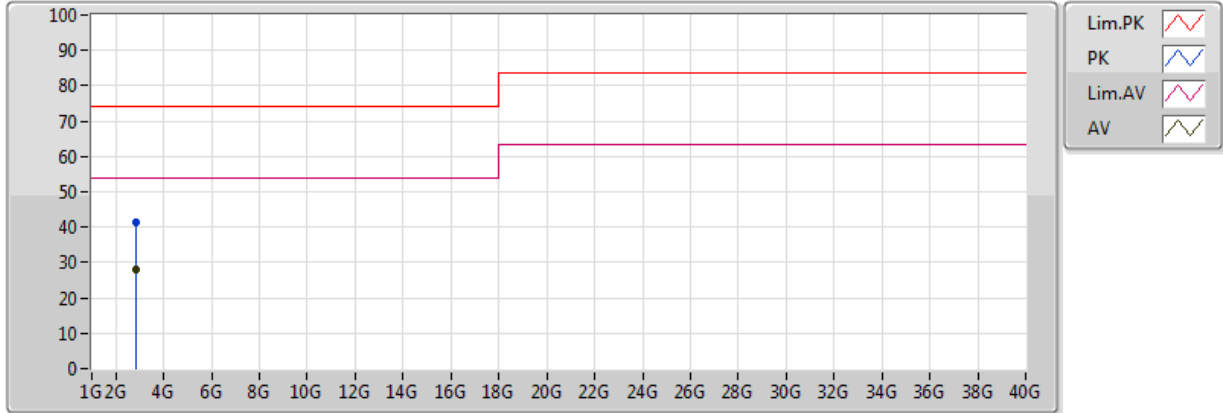

EUT = Y ; 2.4G+5G+BT

Type	Freq (Hz)	Level (dBuV/m)	Limit (dBuV/m)	Margin (dB)	Factor (dB)	Dist (m)	Condition	Azimuth (°)	Height (m)	Comments	Raw (dBuV)	AF (dB)	CL (dB)	PA (dB)
AV	2.852G	27.97	54.00	-26.03	-1.88	3	Vertical	0	1.00	-	29.85	28.13	4.64	34.66
PK	2.852G	41.35	74.00	-32.65	-1.88	3	Vertical	0	1.00	-	43.23	28.13	4.64	34.66

Radiated-above 1GHz_Mode 1

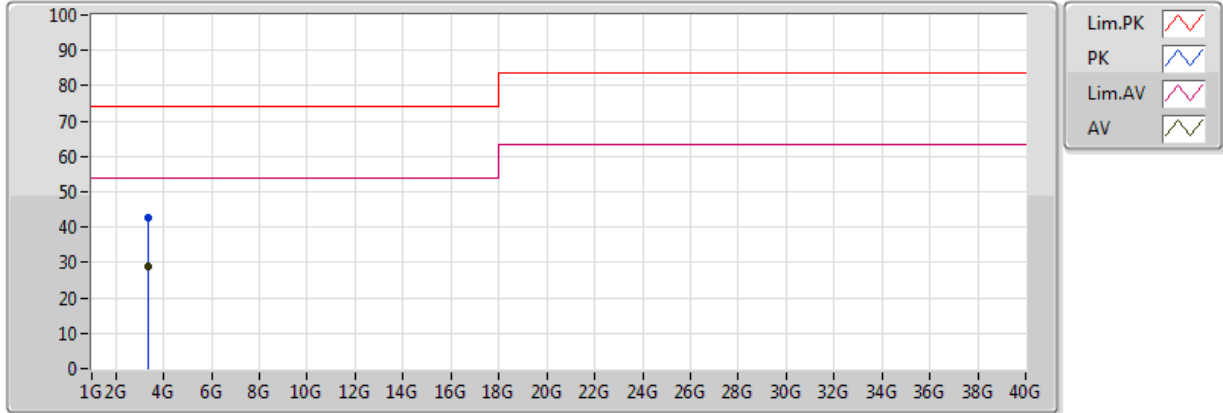

EUT = Y ; 2.4G+5G+BT

Type	Freq (Hz)	Level (dBuV/m)	Limit (dBuV/m)	Margin (dB)	Factor (dB)	Dist (m)	Condition	Azimuth (°)	Height (m)	Comments	Raw (dBuV)	AF (dB)	CL (dB)	PA (dB)
AV	3.335G	28.70	54.00	-25.30	-1.20	3	Horizontal	360	1.00	-	29.90	28.47	4.98	34.65
PK	3.335G	42.80	74.00	-31.20	-1.20	3	Horizontal	360	1.00	-	44.00	28.47	4.98	34.65

Radiated-above 1GHz_Mode 2

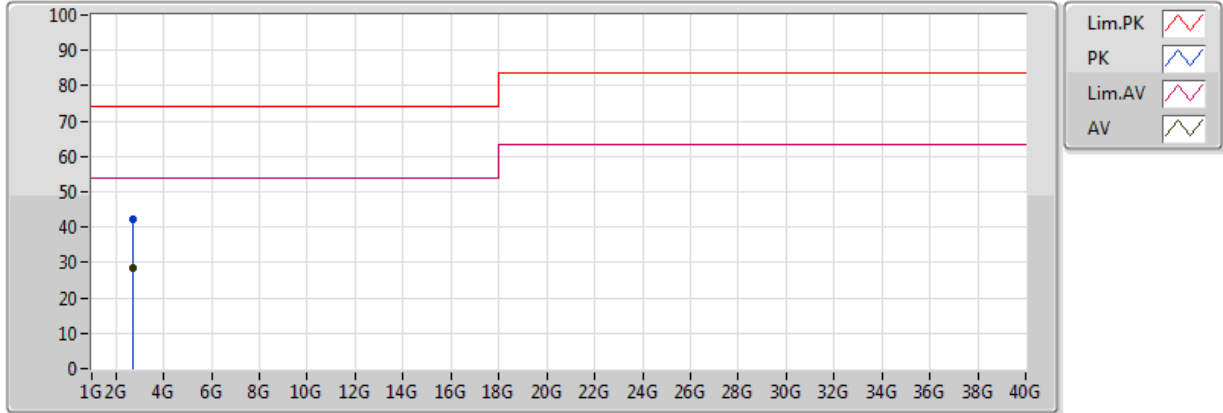

EUT = Z ; 2.4G+5G+BT

Type	Freq (Hz)	Level (dBuV/m)	Limit (dBuV/m)	Margin (dB)	Factor (dB)	Dist (m)	Condition	Azimuth (°)	Height (m)	Comments	Raw (dBuV)	AF (dB)	CL (dB)	PA (dB)
AV	2.728G	28.49	54.00	-25.51	-2.18	3	Vertical	360	1.00	-	30.67	27.91	4.54	34.63
PK	2.728G	42.16	74.00	-31.84	-2.18	3	Vertical	360	1.00	-	44.34	27.91	4.54	34.63

Radiated-above 1GHz_Mode 2

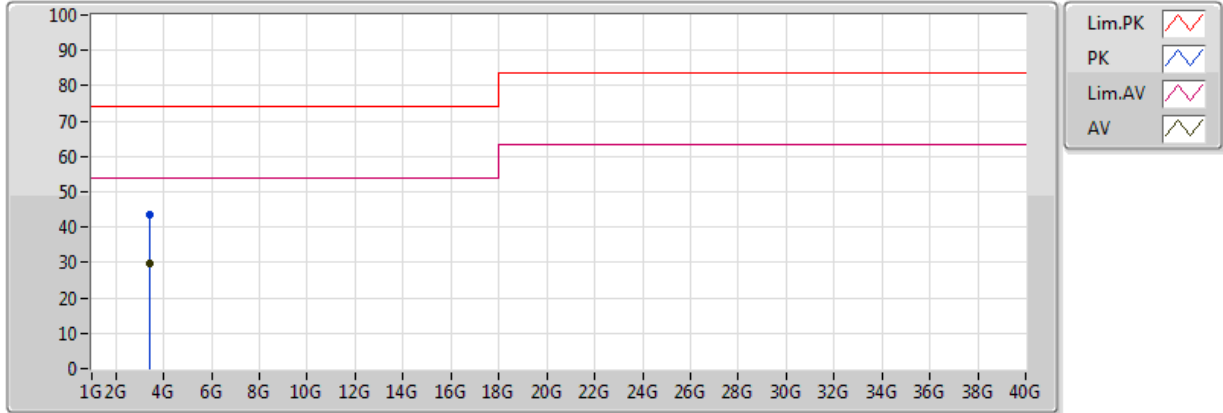

EUT = Z ; 2.4G+5G+BT

Type	Freq (Hz)	Level (dBuV/m)	Limit (dBuV/m)	Margin (dB)	Factor (dB)	Dist (m)	Condition	Azimuth (°)	Height (m)	Comments	Raw (dBuV)	AF (dB)	CL (dB)	PA (dB)
AV	3.425G	29.78	54.00	-24.22	-1.11	3	Horizontal	0	1.00	-	30.89	28.48	5.04	34.64
PK	3.425G	43.56	74.00	-30.44	-1.11	3	Horizontal	0	1.00	-	44.67	28.48	5.04	34.64