

FCC 47 CFR PART 15 SUBPART C

CERTIFICATION TEST REPORT

For

VoIP Wireless Router

MODEL No.: cnPilot R190W, cnPilot R190V

FCC ID: Z8H89FT0030

Trade Mark: N/A

REPORT NO.: ES170317014E

ISSUE DATE: April 16, 2017

Prepared for

Cambium Networks Inc.

3800 Golf Road #360, Rolling Meadows, IL 60008 USA

Prepared by

EMTEK (SHENZHEN) CO., LTD

Bldg 69, Majialong Industry Zone, Nanshan District,
Shenzhen, Guangdong, China

TEL: 86-755-26954280

FAX: 86-755-26954282

TABLE OF CONTENTS

1 TEST RESULT CERTIFICATION 3

2 EUT TECHNICAL DESCRIPTION 5

3 SUMMARY OF TEST RESULT 7

4 TEST METHODOLOGY 8

4.1 GENERAL DESCRIPTION OF APPLIED STANDARDS 8

4.2 MEASUREMENT EQUIPMENT USED 8

4.3 DESCRIPTION OF TEST MODES 9

5 FACILITIES AND ACCREDITATIONS 10

5.1 FACILITIES 10

5.2 LABORATORY ACCREDITATIONS AND LISTINGS 10

6 TEST SYSTEM UNCERTAINTY 11

7 SETUP OF EQUIPMENT UNDER TEST 12

7.1 RADIO FREQUENCY TEST SETUP 1 12

7.2 RADIO FREQUENCY TEST SETUP 2 12

7.3 CONDUCTED EMISSION TEST SETUP 14

7.4 BLOCK DIAGRAM CONFIGURATION OF TEST SYSTEM 15

7.5 SUPPORT EQUIPMENT 15

8 TEST REQUIREMENTS 16

8.1 DTS (6DB) BANDWIDTH 16

8.2 MAXIMUM PEAK CONDUCTED OUTPUT POWER 34

8.3 MAXIMUM POWER SPECTRAL DENSITY 37

8.4 UNWANTED EMISSIONS IN NON-RESTRICTED FREQUENCY BANDS 55

8.5 RADIATED SPURIOUS EMISSION 61

8.6 CONDUCTED EMISSIONS TEST 84

8.7 ANTENNA APPLICATION 89

1 TEST RESULT CERTIFICATION

Applicant:	Cambium Networks Inc. 3800 Golf Road #360, Rolling Meadows, IL 60008 USA
Manufacturer:	Cambium Networks Inc. 3800 Golf Road #360, Rolling Meadows, IL 60008 USA
Factory:	Flyingvoice Network Technology Co., Ltd. Room102, 1F East, Bldg 3#, Minqi Park, Pingshan, Xili, Nanshan District, Shenzhen, China
EUT Description:	VoIP Wireless Router
Model Number:	cnPilot R190W, cnPilot R190V
File Number:	ES170317014E
Date of Test:	March 20, 2017 to April 16, 2017

Measurement Procedure Used:

APPLICABLE STANDARDS	
STANDARD	TEST RESULT
FCC 47 CFR Part 2, Subpart J FCC 47 CFR Part 15, Subpart C	PASS

The above equipment was tested by EMTEK (SHENZHEN) CO., LTD. The test data, data evaluation, test procedures, and equipment configurations shown in this report were made in accordance with the procedures given in ANSI C63.10 (2013) and the energy emitted by the sample EUT tested as described in this report is in compliance with the requirements of FCC Rules Part 2 and Part 15.247

The test results of this report relate only to the tested sample identified in this report.

Date of Test : March 20, 2017 to April 16, 2017

Prepared by : 
Sevin Li/Editor

Reviewer : 
Joe Xia/Supervisor

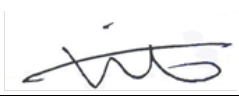
Approve & Authorized Signer : 
Lisa Wang/Manager

Modified History

Rev.	Summary	Date of Rev.	Report No.
V1.0	Original Report	/	ES170317014E

2 EUT TECHNICAL DESCRIPTION

Characteristics	Description
Device Type	Wifi 2.4G Device
Model Number:	cnPilot R190W, cnPilot R190V (Note: The two model are identical in circuitry and electrical, mechanical and physical construction; the differences are the color and model no. for trading purpose. We prepare cnPilot R190W for test, and the worst result recorded in the report.) Note: The shell color may be black or white, the white shell used the External antenna; the black shell used Iron antenna
IEEE 802.11 WLAN Mode Supported	<input checked="" type="checkbox"/> 802.11b(20MHz bandwidth) <input checked="" type="checkbox"/> 802.11g(20MHz bandwidth) <input checked="" type="checkbox"/> 802.11n(20MHz bandwidth) <input checked="" type="checkbox"/> 802.11n(40MHz bandwidth)
Data Rate	<input checked="" type="checkbox"/> 802.11 b:1,2,5.5,11Mbps <input checked="" type="checkbox"/> 802.11 g:6,9,12,18,24,36,48,54Mbps <input checked="" type="checkbox"/> 802.11n(HT20):MCS0-MCS15 <input checked="" type="checkbox"/> 802.11n(HT40):MCS0-MCS15
MIMO Mode	Support
Modulation	DSSS with DBPSK/DQPSK/CCK for 802.11b OFDM with BPSK/QPSK/16QAM/64QAM for 802.11g/n
Operating Frequency Range	<input checked="" type="checkbox"/> 2412-2462MHz for 802.11b/g <input checked="" type="checkbox"/> 2412-2462MHz for 802.11n(HT20) <input checked="" type="checkbox"/> 2422-2452MHz for 802.11n(HT40)
Number of Channels	<input checked="" type="checkbox"/> 11 channels for 802.11b/g <input checked="" type="checkbox"/> 11 channels for 802.11n(HT20) <input checked="" type="checkbox"/> 7 channels for 802.11n(HT40)
Transmit Power Max	16.71dBm for 802.11b 19.75dBm for 802.11g 22.07dBm for 802.11n(HT20) 20.34dBm for 802.11n(HT40)
Power supply	<input type="checkbox"/> DC supply:
	<input checked="" type="checkbox"/> Adapter1 supply: Model: S12B22-120A100-C4 INPUT: 100-240~50/60Hz, Max 0.6A OUTPUT: 12V/1A <input checked="" type="checkbox"/> Adapter2 supply: Model: NBS05B050100VU INPUT: 100-240~50/60Hz 0.2A OUTPUT: 5V/1A

Antenna Type

Black shell Antenna Type1: PiFa antenna	White Shell Antenna Type2: External Antenna
Antenna Gain: WIFI antenna A: 2.5dBi WIFI antenna B: 2.5dBi	Antenna Gain: WIFI antenna A: 4.4dBi WIFI antenna B: 4.4dBi
Smart system: <input checked="" type="checkbox"/> SISO for 802.11b/g/n <input checked="" type="checkbox"/> MIMO for 802.11n	Smart system: <input checked="" type="checkbox"/> SISO for 802.11b/g/n <input checked="" type="checkbox"/> MIMO for 802.11n
Array gain: ≈5.51dBi	Array gain: ≈7.41dBi

Note: for more details, please refer to the User's manual of the EUT.

3 SUMMARY OF TEST RESULT

FCC Part Clause	Test Parameter	Verdict	Remark
15.247(a)(2)	DTS (6dB) Bandwidth	PASS	
15.247(b)(3)	Maximum Peak Conducted Output Power	PASS	
15.247(e)	Maximum Power Spectral Density Level	PASS	
15.247(d)	Unwanted Emission Into Non-Restricted Frequency Bands	PASS	
15.247(d) 15.209	Unwanted Emission Into Restricted Frequency Bands (conducted)	PASS	
15.247(d) 15.209	Radiated Spurious Emission	PASS	
15.207	Conducted Emission Test	PASS	
15.203(b)	Antenna Application	PASS	
NOTE1: N/A (Not Applicable)			
NOTE2: According to FCC OET KDB 558074, the report use radiated measurements in the restricted frequency bands. In addition, the radiated test is also performed to ensure the emissions emanating from the device cabinet also comply with the applicable limits.			

RELATED SUBMITTAL(S) / GRANT(S):

This submittal(s) (test report) is intended for FCC ID: Z8H89FT0030 filing to comply with Section 15.247 of the FCC Part 15, Subpart C Rules.

The system is compliance with Subpart B is authorized under a DOC procedure

4 TEST METHODOLOGY

4.1 GENERAL DESCRIPTION OF APPLIED STANDARDS

According to its specifications, the EUT must comply with the requirements of the following standards:

FCC 47 CFR Part 2, Subpart J

FCC 47 CFR Part 15, Subpart C

FCC KDB 558074 D01 DTS Meas Guidance v04

FCC KDB 662911 D01 Multiple Transmitter Output v02r01

FCC KDB 662911 D02 MIMO With Cross Polarized Antenna V01

4.2 MEASUREMENT EQUIPMENT USED

4.2.1 Conducted Emission Test Equipment

EQUIPMENT TYPE	MFR	MODEL NUMBER	SERIAL NUMBER	LAST CAL.
Test Receiver	Rohde & Schwarz	ESCS30	828985/018	May 29, 2016
L.I.S.N.	Schwarzbeck	NNLK8129	8129203	May 28, 2016
50Ω Coaxial Switch	Anritsu	MP59B	M20531	May 29, 2016
Pulse Limiter	Rohde & Schwarz	ESH3-Z2	100006	May 28, 2016
Voltage Probe	Rohde & Schwarz	TK9416	N/A	May 28, 2016

4.2.2 Radiated Emission Test Equipment

EQUIPMENT TYPE	MFR	MODEL NUMBER	SERIAL NUMBER	LAST CAL.
EMI Test Receiver	Rohde & Schwarz	ESU	1302.6005.26	May 29, 2016
Pre-Amplifier	HP	8447D	2944A07999	May 28, 2016
Bilog Antenna	Schwarzbeck	VULB9163	142	May 28, 2016
Loop Antenna	ARA	PLA-1030/B	1029	May 28, 2016
Horn Antenna	Schwarzbeck	BBHA 9170	BBHA9170399	May 28, 2016
Horn Antenna	Schwarzbeck	BBHA 9120	D143	May 28, 2016
Cable	Schwarzbeck	AK9513	ACRX1	May 29, 2016
Cable	Rosenberger	N/A	FP2RX2	May 29, 2016
Cable	Schwarzbeck	AK9513	CRPX1	May 29, 2016
Cable	Schwarzbeck	AK9513	CRRX2	May 29, 2016

4.2.3 Radio Frequency Test Equipment

EQUIPMENT TYPE	MFR	MODEL NUMBER	SERIAL NUMBER	LAST CAL.
Spectrum Analyzer	Agilent	E4407B	88156318	May 28, 2016
Signal Analyzer	Agilent	N9010A	My53470879	May 28, 2016
Power meter	Anritsu	ML2495A	0824006	May 28, 2016
Power sensor	Anritsu	MA2411B	0738172	May 28, 2016

Remark: Each piece of equipment is scheduled for calibration once a year.

4.3 DESCRIPTION OF TEST MODES

The EUT has been tested under its typical operating condition.

The EUT configuration for testing is installed on RF field strength measurement to meet the Commissions requirement and operating in a manner which intends to maximize its emission characteristics in a continuous normal application.

The Transmitter was operated in the normal operating mode. The TX frequency was fixed which was for the purpose of the measurements.

Test of channel included the lowest and middle and highest frequency to perform the test, then record on this report.

Those data rates (802.11b: 1 Mbps; 802.11g: 6 Mbps; 802.11n (HT20): MCS0; 802.11n (HT20): MCS15; 802.11n (HT40): MCS0) ; 802.11n (HT40): MCS15) were used for all test.

Pre-defined engineering program for regulatory testing used to control the EUT for staying in continuous transmitting and receiving mode is programmed.

Frequency and Channel list for 802.11 b/g/n (HT20):

Channel	Frequency (MHz)	Channel	Frequency (MHz)	Channel	Frequency (MHz)
1	2412	5	2432	9	2452
2	2417	6	2437	10	2457
3	2422	7	2442	11	2462
4	2427	8	2447		

Frequency and Channel list for 802.11 n (HT40):

Channel	Frequency (MHz)	Channel	Frequency (MHz)	Channel	Frequency (MHz)
3	2422	5	2432	8	2447
4	2427	6	2437	9	2452
		7	2442		

Test Frequency and Channel for 802.11 b/g/n (HT20):

Lowest Frequency		Middle Frequency		Highest Frequency	
Channel	Frequency (MHz)	Channel	Frequency (MHz)	Channel	Frequency (MHz)
1	2412	6	2437	11	2462

Test Frequency and channel for 802.11n (HT40):

Lowest Frequency		Middle Frequency		Highest Frequency	
Channel	Frequency (MHz)	Channel	Frequency (MHz)	Channel	Frequency (MHz)
3	2422	6	2437	9	2452

5 FACILITIES AND ACCREDITATIONS

5.1 FACILITIES

All measurement facilities used to collect the measurement data are located at

Bldg 69, Majialong Industry Zone District, Nanshan District, Shenzhen, China

The sites are constructed in conformance with the requirements of ANSI C63.7, ANSI C63.10 and CISPR Publication 22.

5.2 LABORATORY ACCREDITATIONS AND LISTINGS

Site Description

EMC Lab. : Accredited by CNAS, 2016.10.24
The certificate is valid until 2022.10.28

The Laboratory has been assessed and proved to be in compliance with CNAS-CL01: 2006(identical to ISO/IEC17025: 2005)
The Certificate Registration Number is L229

: Accredited by TUV Rheinland Shenzhen, 2015.4
The Laboratory has been assessed according to the requirements ISO/IEC 17025.

: Accredited by FCC, July 13, 2016
The Certificate Registration Number is 406365.

: Accredited by Industry Canada, November 29, 2012
The Certificate Registration Number is 4480A.

Name of Firm : SHENZHEN EMTEK CO., LTD.

Site Location : Bldg 69, Majialong Industry Zone,
Nanshan District, Shenzhen, Guangdong, China

6 TEST SYSTEM UNCERTAINTY

The following measurement uncertainty levels have been estimated for tests performed on the apparatus:

Parameter	Uncertainty
Radio Frequency	$\pm 1 \times 10^{-5}$
Maximum Peak Output Power Test	$\pm 1.0\text{dB}$
Conducted Emissions Test	$\pm 2.0\text{dB}$
Radiated Emission Test	$\pm 2.0\text{dB}$
Power Density	$\pm 2.0\text{dB}$
Occupied Bandwidth Test	$\pm 1.0\text{dB}$
Band Edge Test	$\pm 3\text{dB}$
All emission, radiated	$\pm 3\text{dB}$
Antenna Port Emission	$\pm 3\text{dB}$
Temperature	$\pm 0.5^{\circ}\text{C}$
Humidity	$\pm 3\%$

Measurement Uncertainty for a level of Confidence of 95%

7 SETUP OF EQUIPMENT UNDER TEST

7.1 RADIO FREQUENCY TEST SETUP 1

The WLAN component's antenna ports(s) of the EUT are connected to the measurement instrument per an appropriate attenuator. The EUT is controlled by PC/software to emit the specified signals for the purpose of measurements.

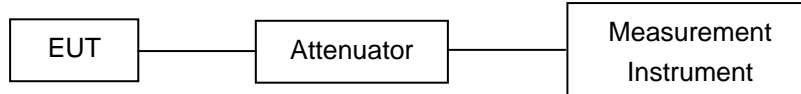

7.2 RADIO FREQUENCY TEST SETUP 2

The test site semi-anechoic chamber has met the requirement of NSA tolerance 4 dB according to the standards: ANSI C63.10. The test distance is 3m. The setup is according to the requirements in Section 13.1.4.1 of ANSI C63.10-2013 and CAN/CSA-CEI/IEC CISPR 22.

Below 30MHz:

The EUT is placed on a turntable 0.8 meters above the ground in the chamber, 3 meter away from the antenna (loop antenna). The Antenna should be positioned with its plane vertical at the specified distance from the EUT and rotated about its vertical axis for maximum response at each azimuth about the EUT. The center of the loop shall be 1 m above the ground. For certain applications, the loop antenna plane may also need to be positioned horizontally at the specified distance from the EUT.

Above 30MHz:

The EUT is placed on a turntable 0.8 meters above the ground in the chamber, 3 meter away from the antenna. The maximal emission value is acquired by adjusting the antenna height, polarisation and turntable azimuth. Normally, the height range of antenna is 1 m to 4 m, the azimuth range of turntable is 0° to 360°, and the receive antenna has two polarizations Vertical (V) and Horizontal (H).

Above 1GHz:

(Note: the FCC's permission to use 1.5m as an alternative per TCBC Conf call of Dec. 2, 2014.)

The EUT is placed on a turntable 1.5 meters above the ground in the chamber, 3 meter away from the antenna. The maximal emission value is acquired by adjusting the antenna height, polarisation and turntable azimuth. Normally, the height range of antenna is 1 m to 4 m, the azimuth range of turntable is 0° to 360°, and the receive antenna has two polarizations Vertical (V) and Horizontal (H).

(a) Radiated Emission Test Set-Up, Frequency Below 30MHz

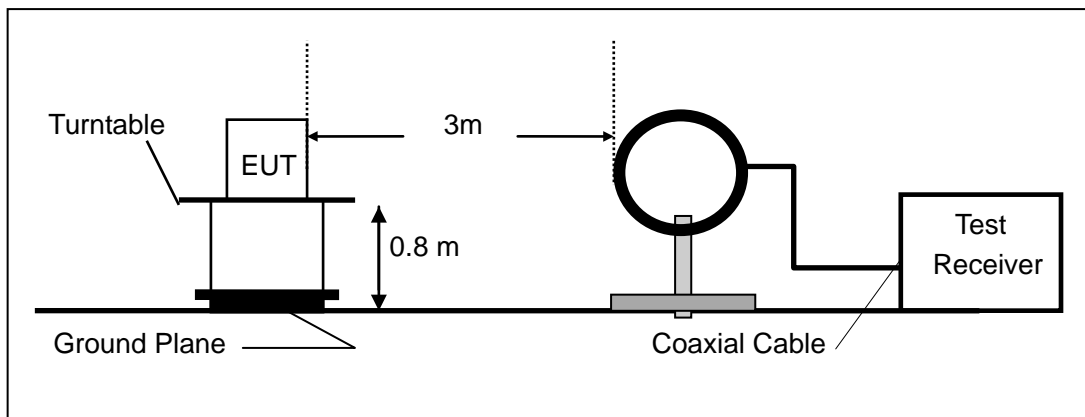

(b) Radiated Emission Test Set-Up, Frequency Below 1000MHz

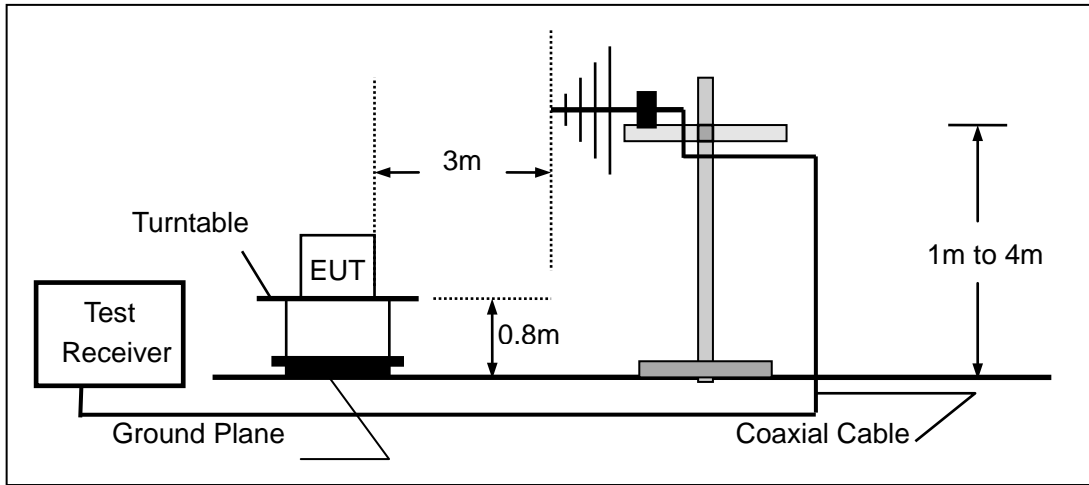

(c) Radiated Emission Test Set-Up, Frequency above 1000MHz

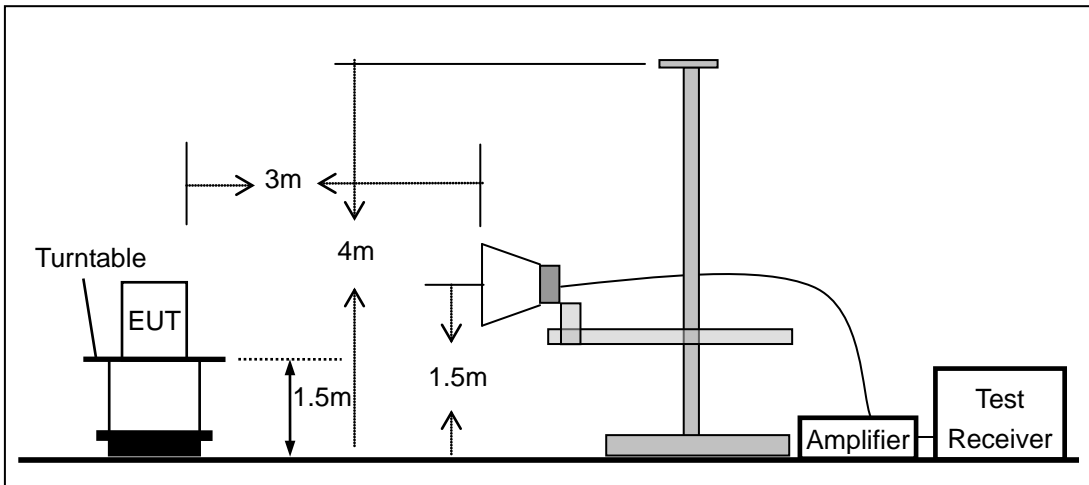

7.3 CONDUCTED EMISSION TEST SETUP

The mains cable of the EUT (maybe per AC/DC Adapter) must be connected to LISN. The LISN shall be placed 0.8 m from the boundary of EUT and bonded to a ground reference plane for LISN mounted on top of the ground reference plane. This distance is between the closest points of the LISN and the EUT. All other units of the EUT and associated equipment shall be at least 0.8m from the LISN.

Ground connections, where required for safety purposes, shall be connected to the reference ground point of the LISN and, where not otherwise provided or specified by the manufacturer, shall be of same length as the mains cable and run parallel to the mains connection at a separation distance of not more than 0.1 m.

According to the requirements in Section 13.1.4.1 of ANSI C63.10-2013 Conducted emissions from the EUT measured in the frequency range between 0.15 MHz and 30 MHz using CISPR Quasi-Peak and average detector mode.

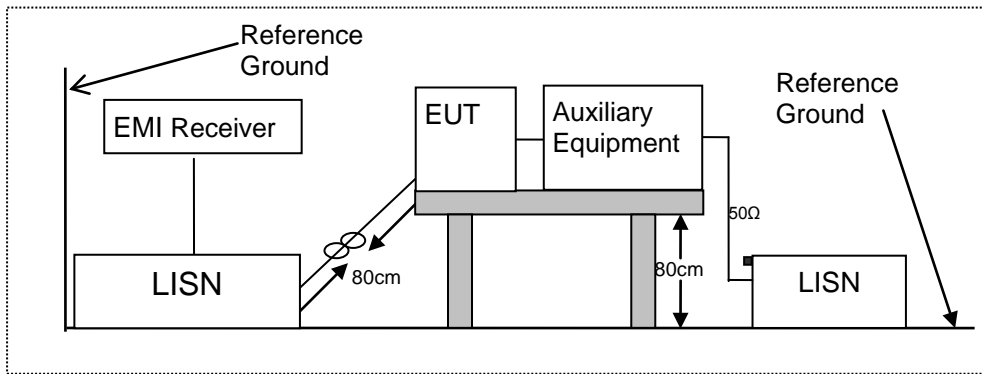

7.4 BLOCK DIAGRAM CONFIGURATION OF TEST SYSTEM

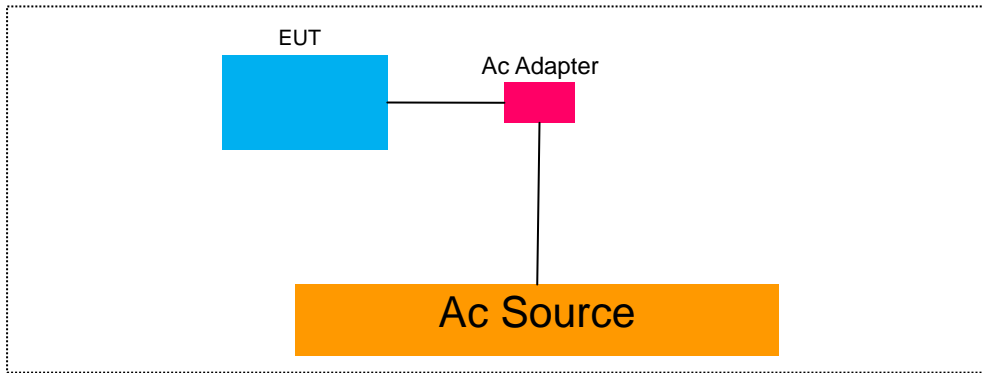

7.5 SUPPORT EQUIPMENT

Item	Equipment	Mfr/Brand	Model/Type No.	FCC ID	Series No.	Note
N/A	N/A	N/A	N/A	N/A	N/A	N/A

Notes:

1. All the equipment/cables were placed in the worst-case configuration to maximize the emission during the test.
2. Grounding was established in accordance with the manufacturer's requirements and conditions for the intended use.

8 TEST REQUIREMENTS

8.1 DTS (6DB) BANDWIDTH

8.1.1 Applicable Standard

According to FCC Part 15.247(a)(2) and KDB 558074 DTS 01 Meas. Guidance v03r05

8.1.2 Conformance Limit

The minimum -6 dB bandwidth shall be at least 500 kHz.

8.1.3 Test Configuration

Test according to clause 7.1 radio frequency test setup 1

8.1.4 Test Procedure

The EUT was operating in IEEE 802.11b/g/n mode and controlled its channel. Printed out the test result from the spectrum by hard copy function.

The RF output of EUT was connected to the spectrum analyzer by RF cable and attenuator. The path loss was compensated to the results for each measurement.

Set to the maximum power setting and enable the EUT transmit continuously

Set RBW = 100 kHz.

Set the video bandwidth (VBW) =300 kHz.

Set Span=2 times OBW

Set Detector = Peak.

Set Trace mode = max hold.

Set Sweep = auto couple.

Allow the trace to stabilize.

Measure the maximum width of the emission that is constrained by the frequencies associated with the two outermost amplitude points (upper and lower frequencies) that are attenuated by 6 dB relative to the maximum level measured in the fundamental emission.

Measure and record the results in the test report.

8.1.5 Test Results

All modes with adapter1 and adapter2 were tested; the worst case is adapter1 mode that was presented for this item.

Temperature :	28°C	Humidity :	65 %
Antenna:	A	Test By:	King Kong

Operation Mode	Channel Number	Channel Frequency (MHz)	Measurement Bandwidth (MHz)	Limit (kHz)	Verdict
☒802.11b	1	2412	9.117	500	PASS
	6	2437	9.591	500	PASS
	11	2462	10.01	500	PASS
☒802.11g	1	2412	15.12	500	PASS
	6	2437	15.12	500	PASS
	11	2462	15.09	500	PASS
☒802.11n (HT20)	1	2412	15.10	500	PASS
	6	2437	15.13	500	PASS
	11	2462	15.13	500	PASS
☒802.11n (HT40)	3	2422	35.11	500	PASS
	6	2437	35.11	500	PASS
	9	2452	35.15	500	PASS

Temperature :	28 °C	Humidity :	65 %
Antenna:	B	Test By:	King Kong

Operation Mode	Channel Number	Channel Frequency (MHz)	Measurement Bandwidth (MHz)	Limit (kHz)	Verdict
☒802.11b	1	2412	9.597	500	PASS
	6	2437	9.590	500	PASS
	11	2462	10.01	500	PASS
☒802.11g	1	2412	15.13	500	PASS
	6	2437	15.14	500	PASS
	11	2462	15.13	500	PASS
☒802.11n (HT20)	1	2412	15.14	500	PASS
	6	2437	15.71	500	PASS
	11	2462	15.14	500	PASS
☒802.11n (HT40)	3	2422	35.10	500	PASS
	6	2437	35.13	500	PASS
	9	2452	35.15	500	PASS

For Antenna A

Test Model

DTS (6dB) Bandwidth
802.11b
Channel 1: 2412MHz

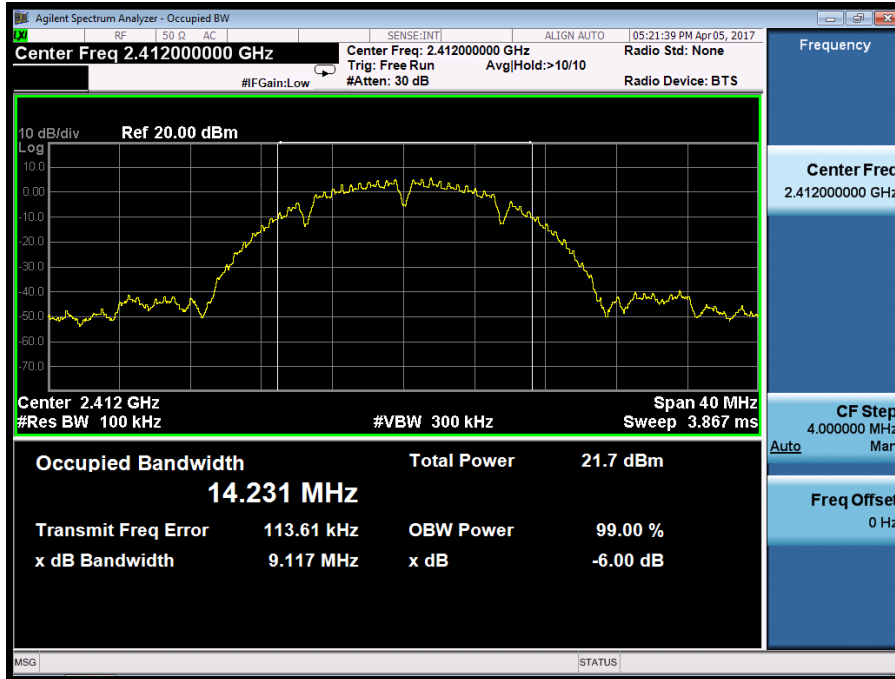

Test Model

DTS (6dB) Bandwidth
802.11b
Channel 6: 2437MHz

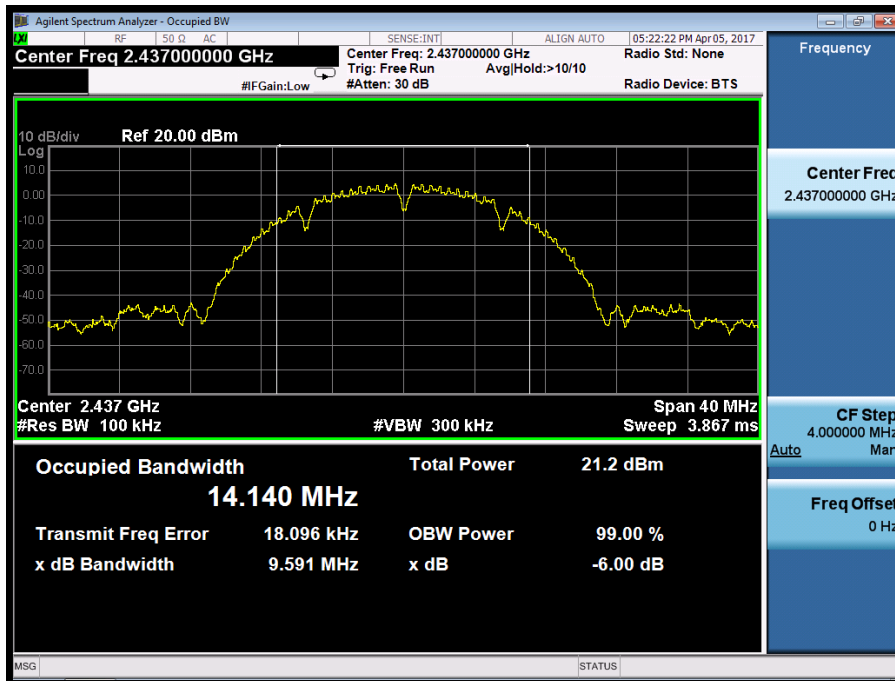

Test Model

DTS (6dB) Bandwidth
802.11b
Channel 11: 2462MHz

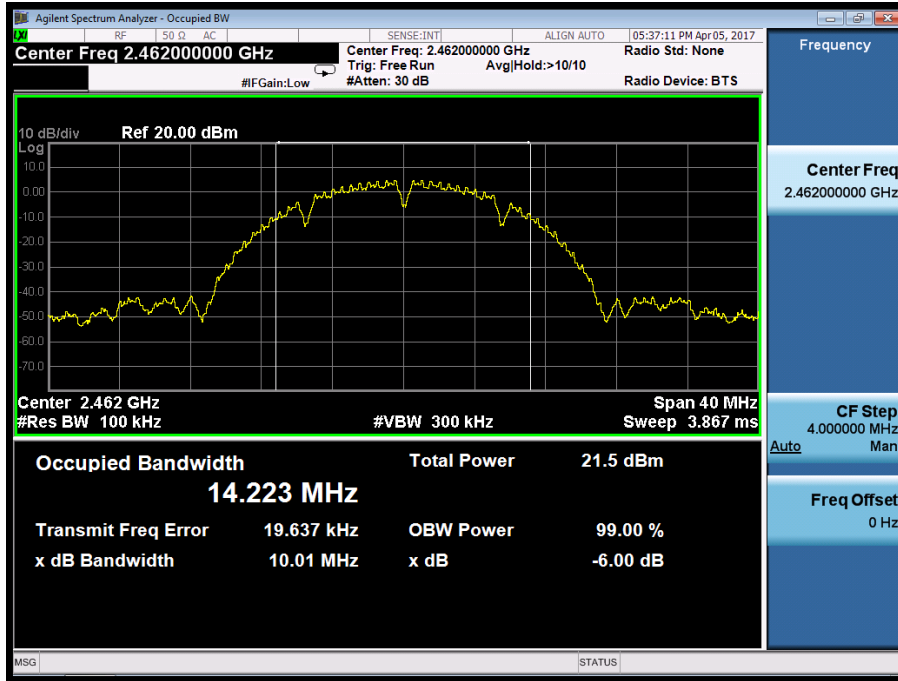

Test Model

DTS (6dB) Bandwidth
802.11g
Channel 1: 2412MHz



Test Model

DTS (6dB) Bandwidth
802.11g
Channel 6: 2437MHz

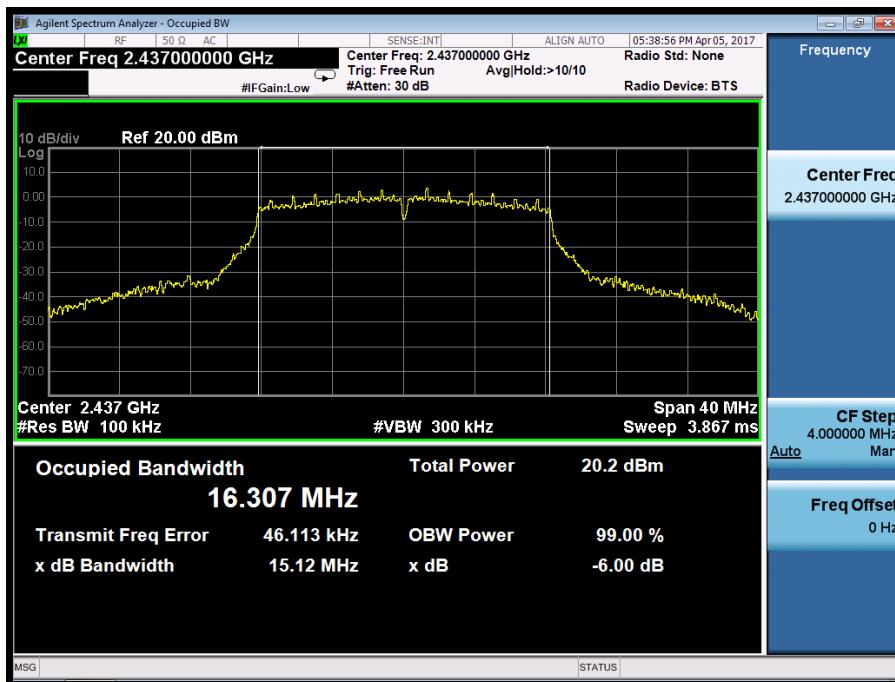

Test Model DTS (6dB) Bandwidth
 802.11g
 Channel 11: 2462MHz

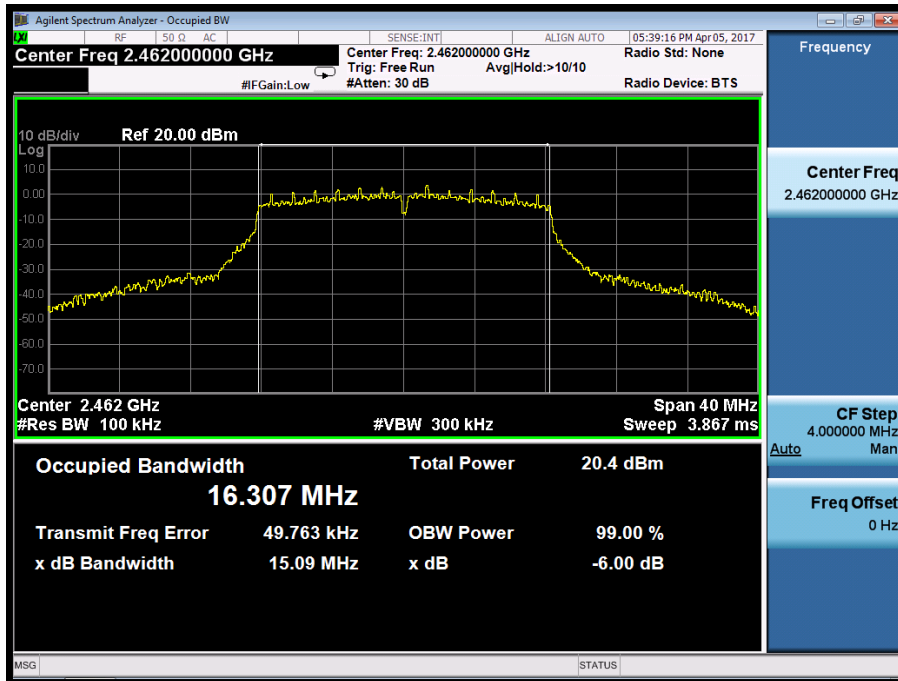

Test Model

DTS (6dB) Bandwidth
802.11n (HT20)
Channel 1: 2412MHz

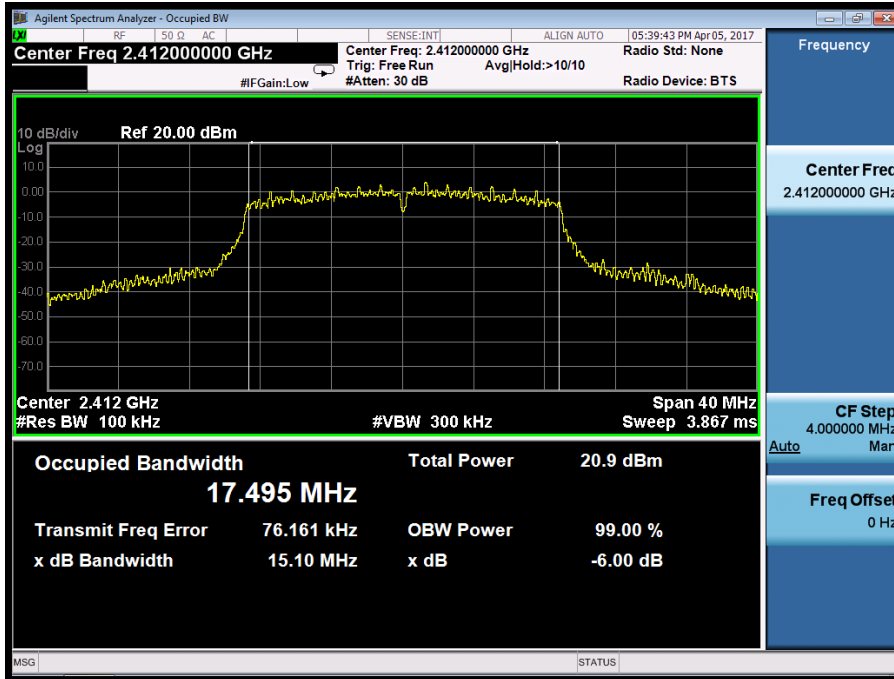

Test Model

DTS (6dB) Bandwidth
802.11n (HT20)
Channel 6: 2437MHz

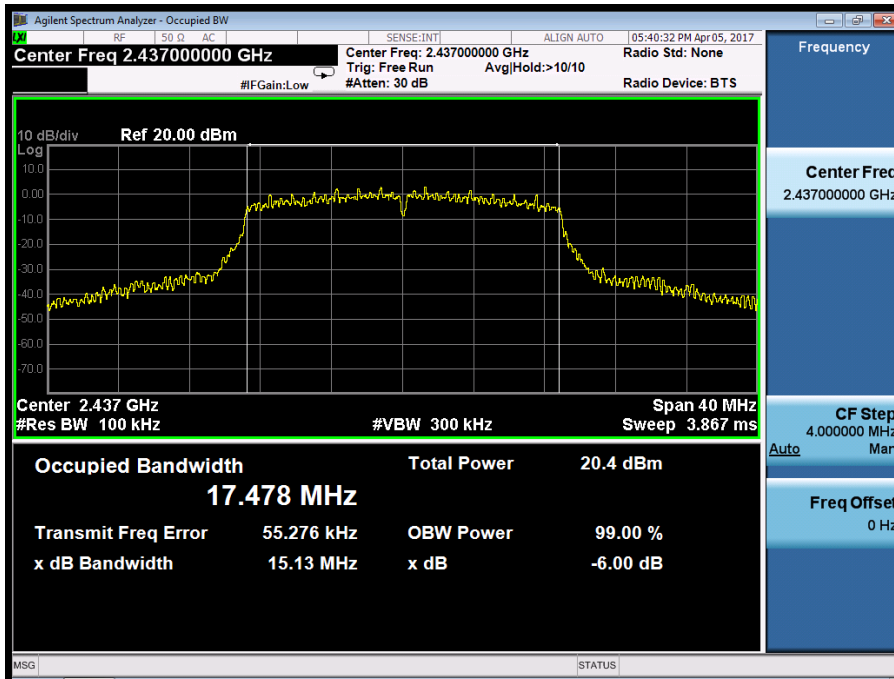

Test Model

DTS (6dB) Bandwidth
802.11n (HT20)
Channel 11: 2462MHz

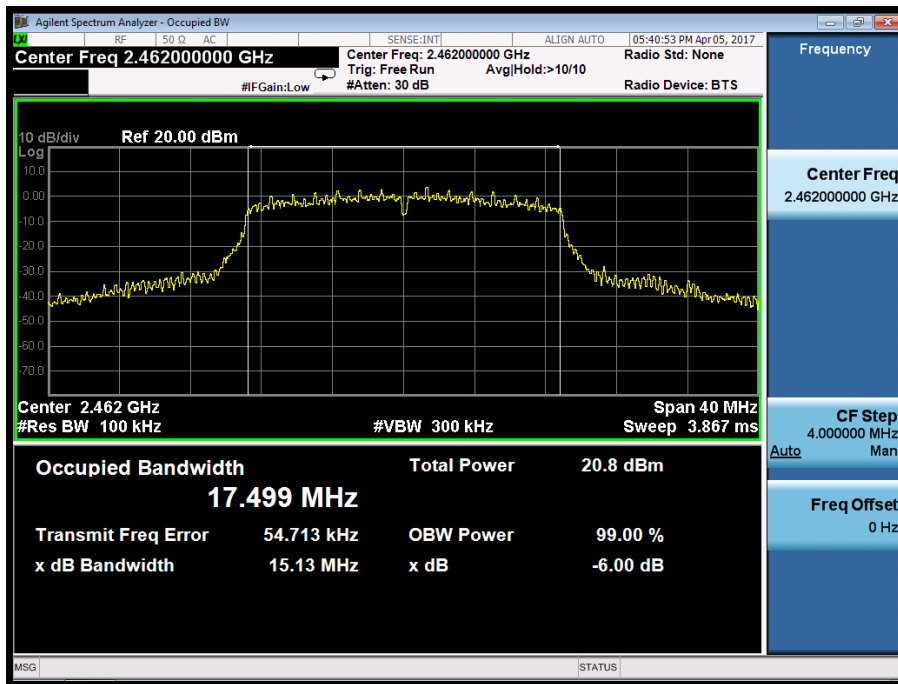

Test Model

DTS (6dB) Bandwidth
802.11n (HT40)
Channel 3: 2422MHz

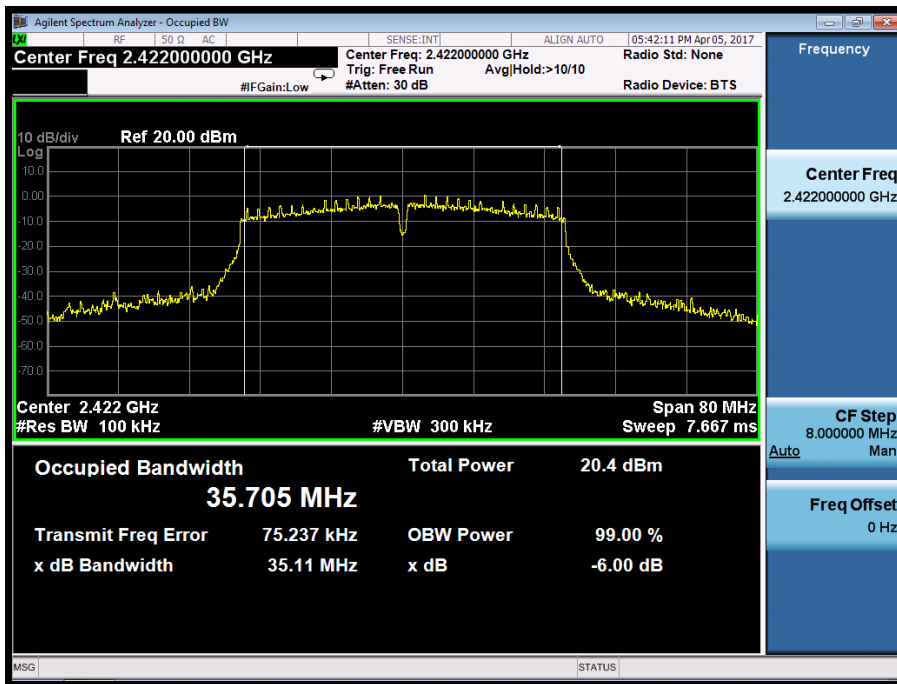

Test Model

DTS (6dB) Bandwidth
802.11n (HT40)
Channel 6: 2437MHz

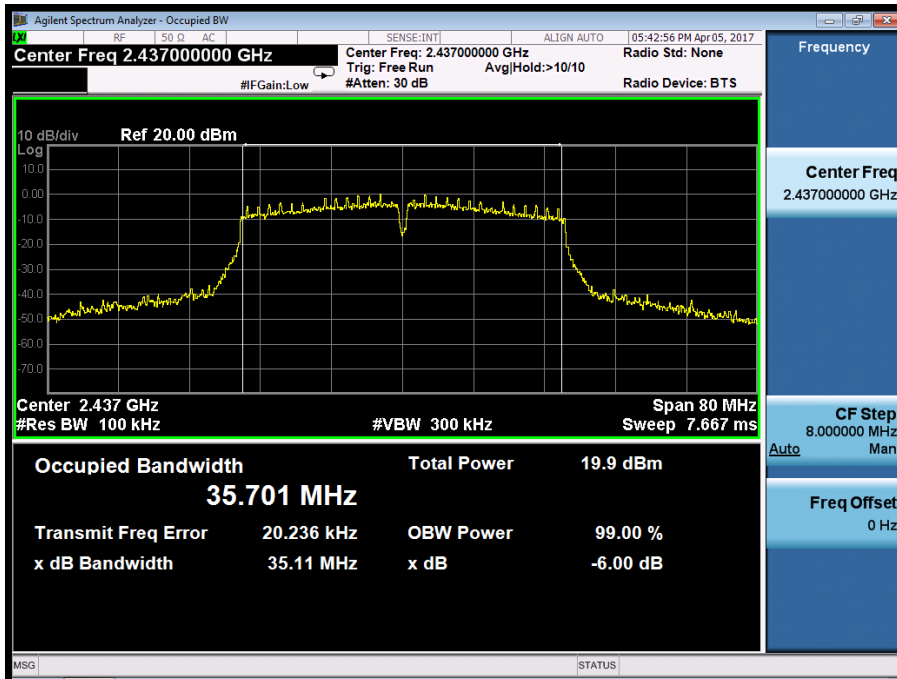

Test Model

DTS (6dB) Bandwidth
802.11n (HT40)
Channel 9: 2452MHz

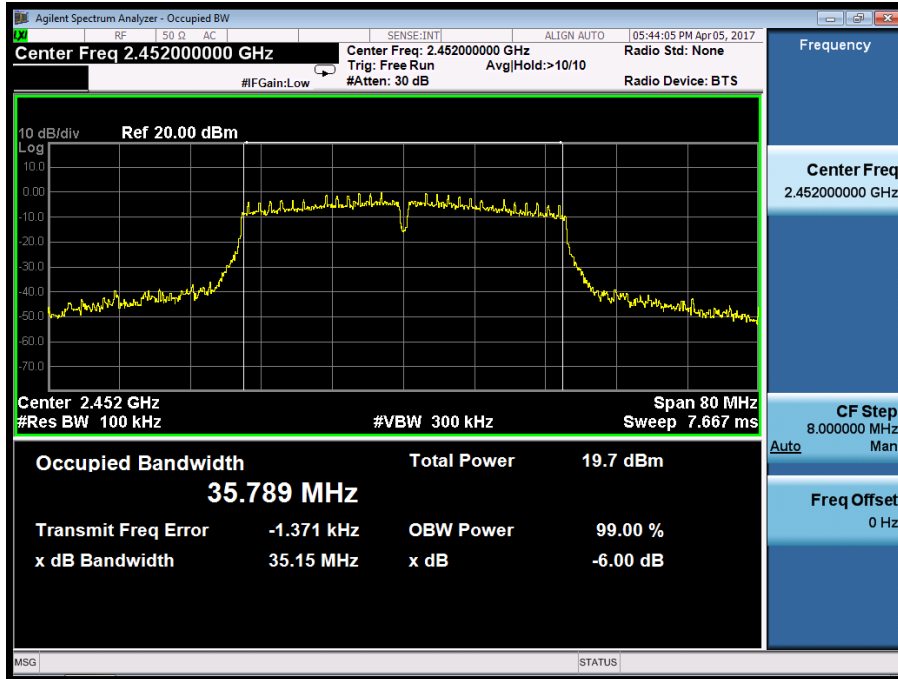

For Antenna B

Test Model

DTS (6dB) Bandwidth
802.11b
Channel 1: 2412MHz

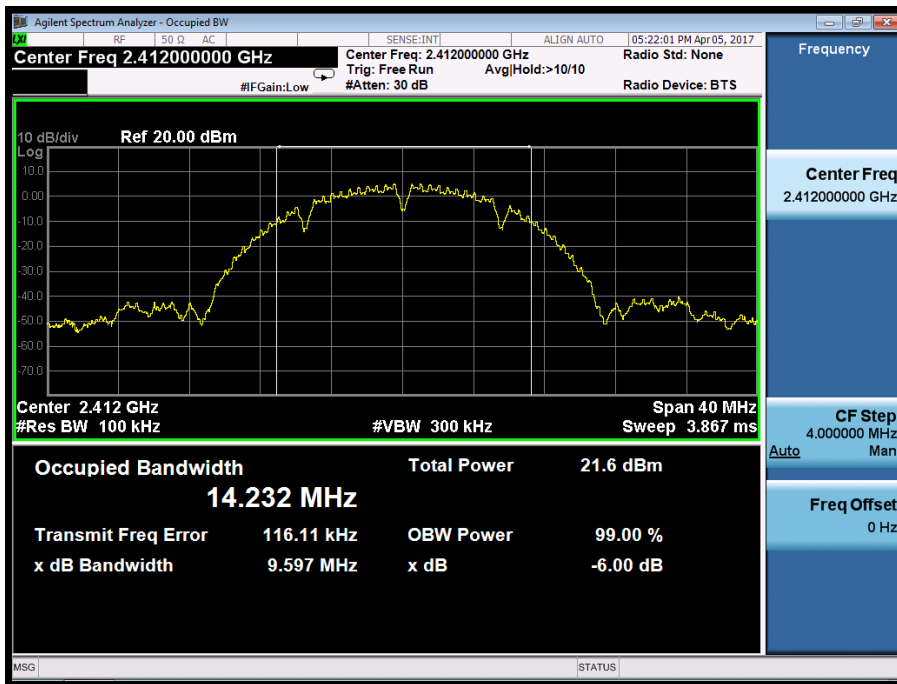

Test Model

DTS (6dB) Bandwidth
802.11b
Channel 6: 2437MHz

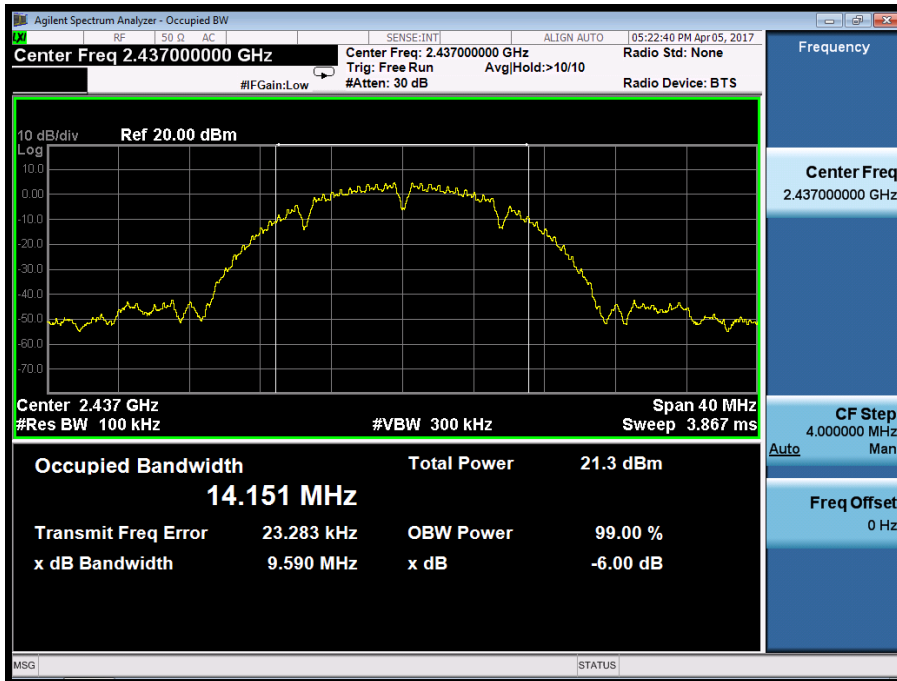

Test Model

DTS (6dB) Bandwidth
802.11b
Channel 11: 2462MHz

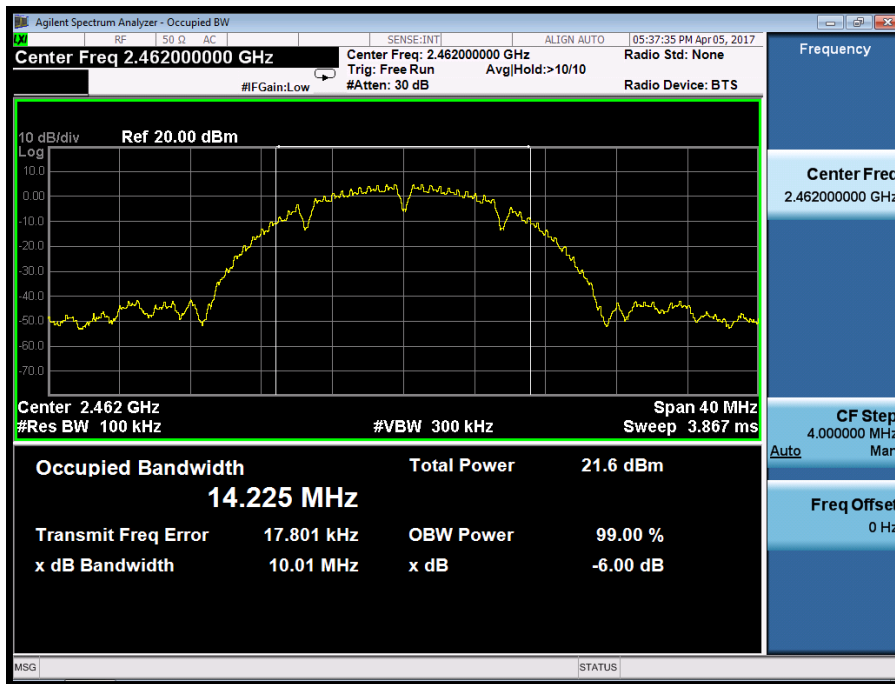

Test Model

DTS (6dB) Bandwidth
802.11g
Channel 1: 2412MHz

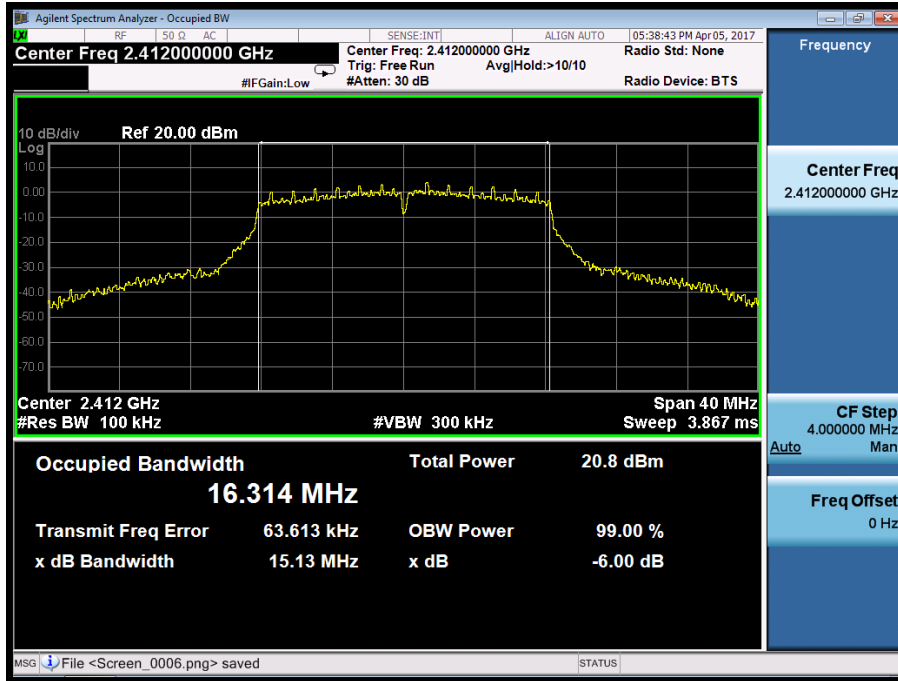

Test Model

DTS (6dB) Bandwidth
802.11g
Channel 6: 2437MHz

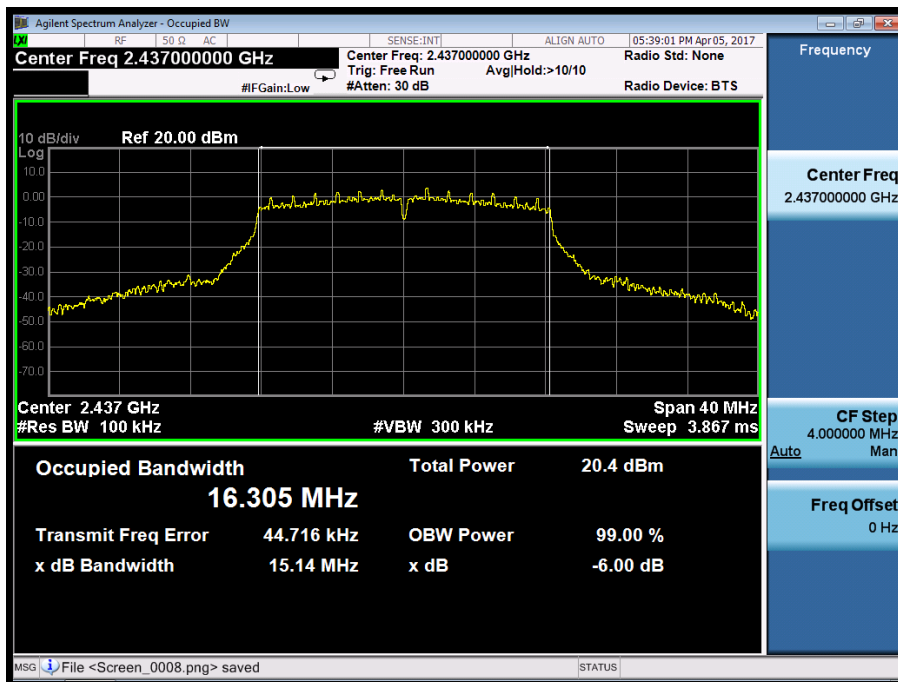

Test Model DTS (6dB) Bandwidth
 802.11g
 Channel 11: 2462MHz

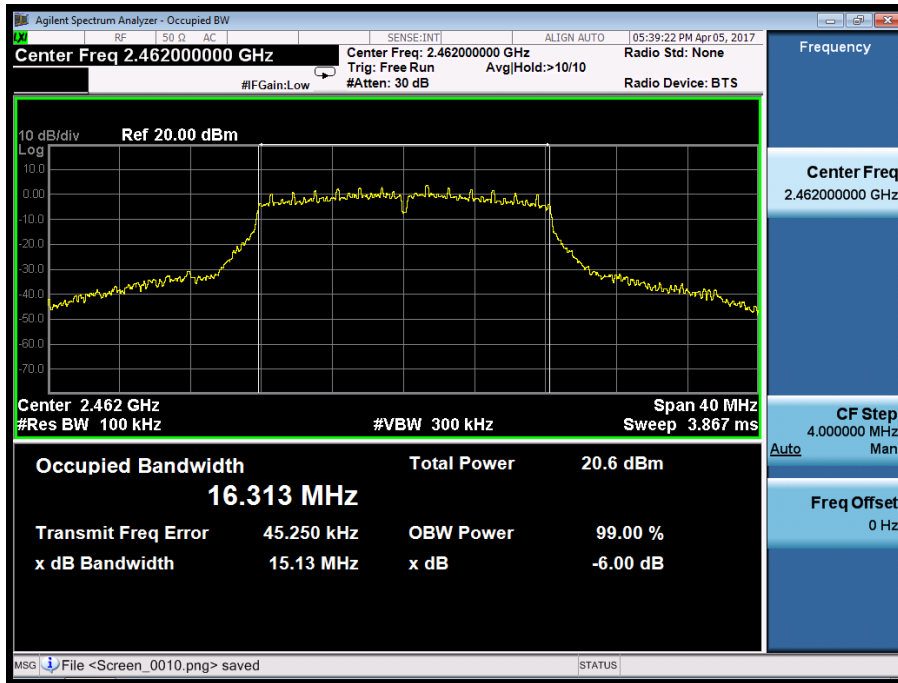

Test Model

DTS (6dB) Bandwidth
802.11n (HT20)
Channel 1: 2412MHz

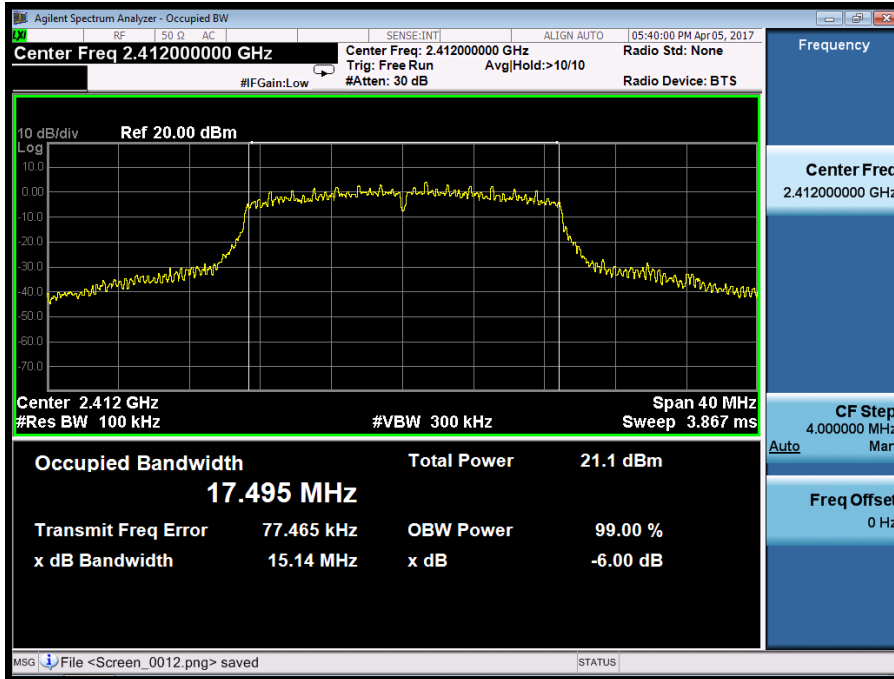

Test Model

DTS (6dB) Bandwidth
802.11n (HT20)
Channel 6: 2437MHz

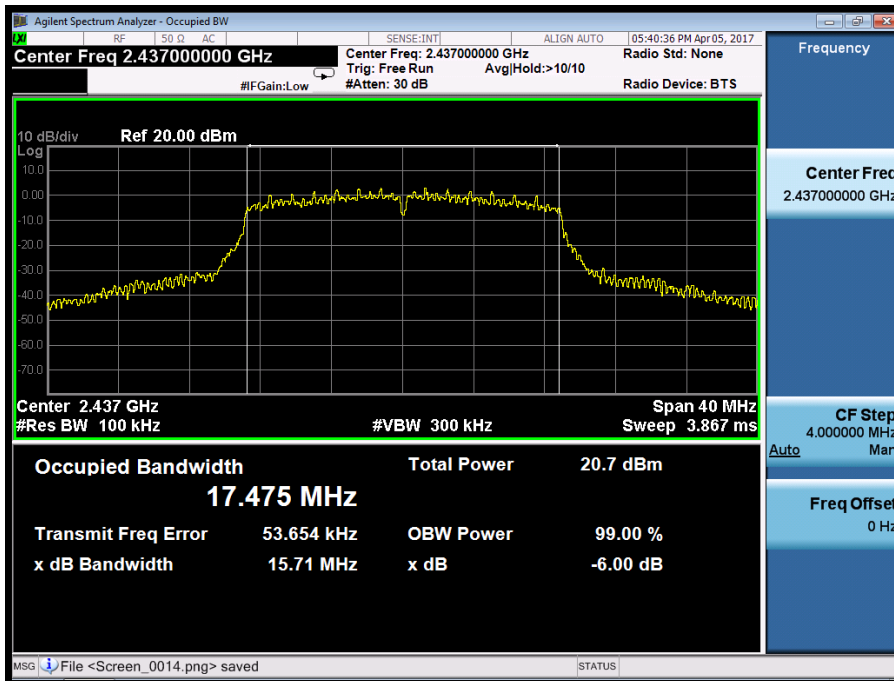

Test Model

DTS (6dB) Bandwidth
802.11n (HT20)
Channel 11: 2462MHz

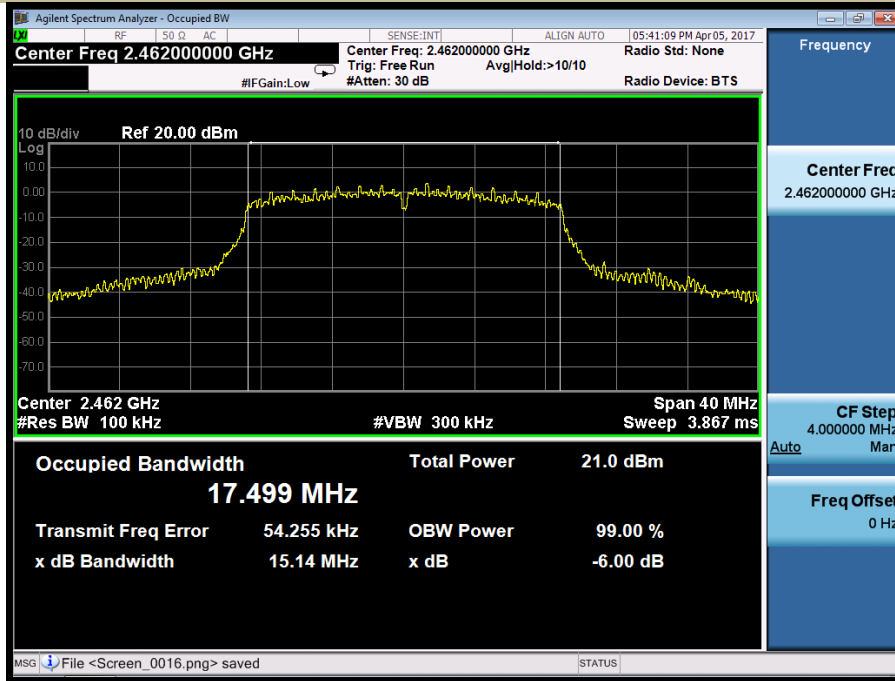

Test Model

DTS (6dB) Bandwidth
802.11n (HT40)
Channel 3: 2422MHz

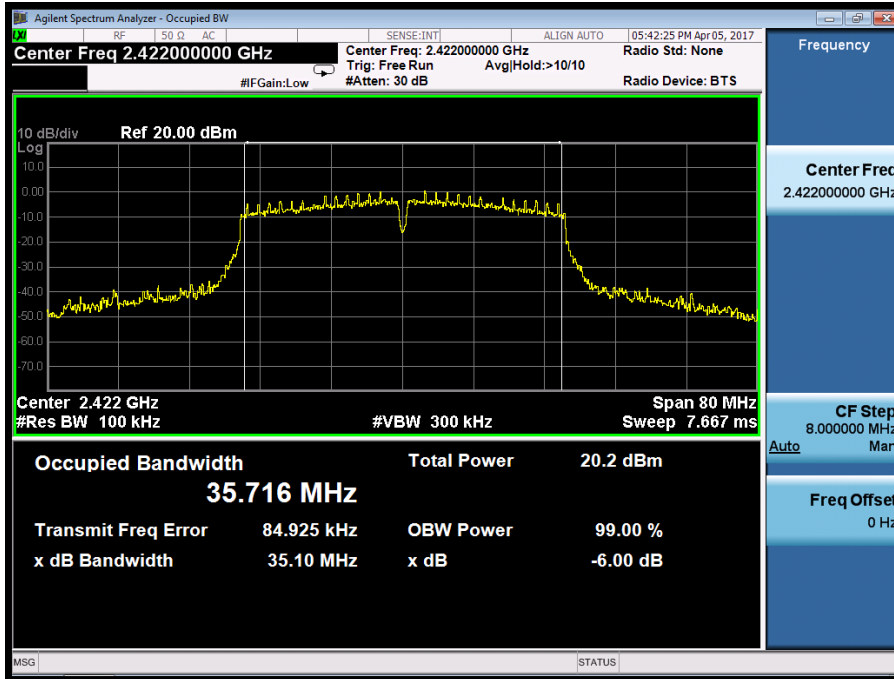

Test Model

DTS (6dB) Bandwidth
802.11n (HT40)
Channel 6: 2437MHz

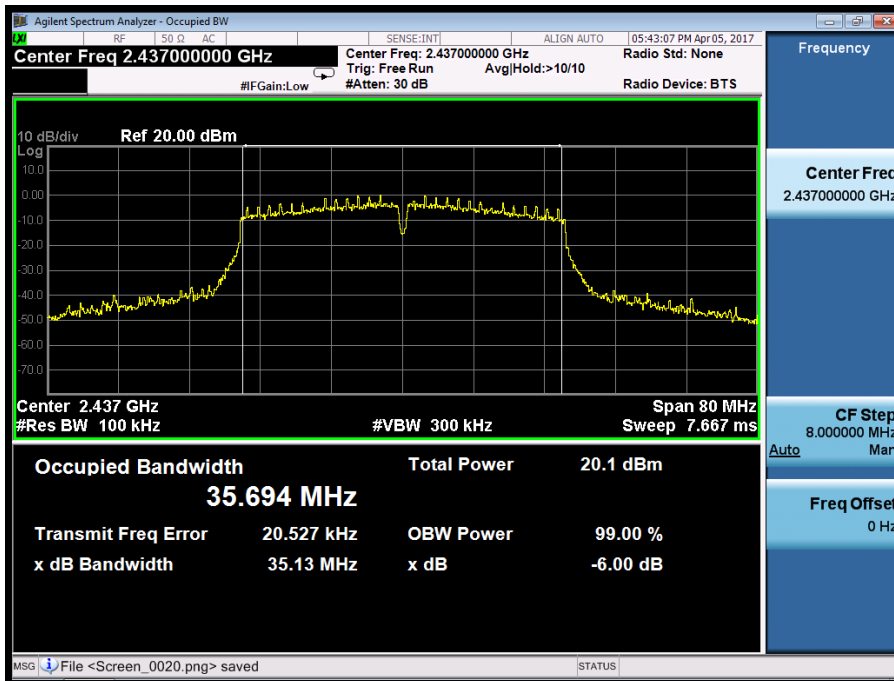

Test Model

DTS (6dB) Bandwidth
802.11n (HT40)
Channel 9: 2452MHz

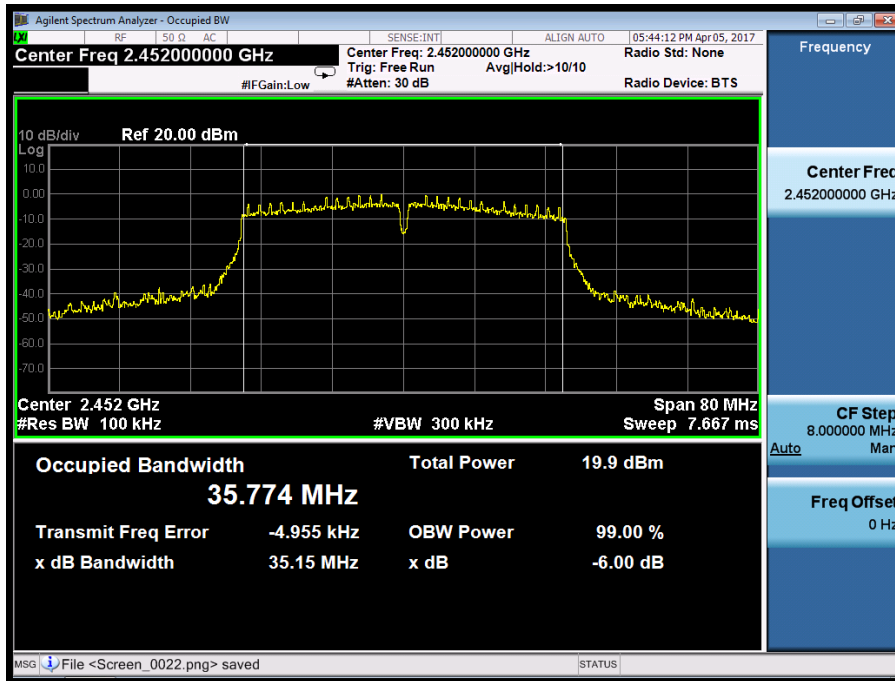

8.2 MAXIMUM PEAK CONDUCTED OUTPUT POWER

8.2.1 Applicable Standard

According to FCC Part 15.247(b)(3) and KDB 558074 DTS 01 Meas. Guidance v03r05

8.2.2 Conformance Limit

The maximum peak conducted output power of the intentional radiator for systems using digital modulation in the 2400 - 2483.5 MHz bands shall not exceed: 1 Watt (30dBm).

8.2.3 Test Configuration

Test according to clause 7.1 radio frequency test setup 1

8.2.4 Test Procedure

■ According to FCC Part15.247(b)(3)

The maximum peak conducted output power may be measured using a broadband peak RF power meter. The power meter shall have a video bandwidth that is greater than or equal to the DTS bandwidth and shall utilize a fast-responding diode detector.

The testing follows KDB 558074 and KDB662911 Measurement Guidelines.

The RF output of EUT was connected to the power meter by RF cable and attenuator. The path loss was compensated to the results for each measurement.

Set to the maximum output power setting and enable the EUT transmit continuously.

Measure the conducted output power with cable loss and record the results in the test report.

Measure and record the results in the report.

■ According to FCC Part 15.247(b)(4):

Conducted output power limit specified in paragraph (b) of this section is based on the use of antennas with directional gains that do not exceed 6 dBi. If transmitting antennas of directional gain greater than 6 dBi are used, the conducted output power from the intentional radiator shall be reduced below the stated values in paragraphs (b)(3) of this section, as appropriate, by the amount in dB that the directional gain of the antenna exceeds 6 dBi.

Note: If antenna Gain exceeds 6 dBi, then Output power Limit=30-(Gain - 6)

8.2.5 Test Results

All modes with adapter1 and adapter2 were tested; the worst case is adapter1 mode that was presented for this item.

Temperature :	28°C	Test Date :	April 05, 2017
Humidity :	65 %	Test By:	King Kong
Antenna:	A		

Operation Mode	Channel Number	Channel Frequency (MHz)	Measurement Level (dBm)	Limit for Antenna Style 1 (dBm)	Limit for Antenna Style 2 (dBm)	Verdict
☒802.11b	1	2412	15.84	30.00	28.59	PASS
	6	2437	15.78	30.00	28.59	PASS
	11	2462	15.65	30.00	28.59	PASS
☒802.11g	1	2412	18.58	30.00	28.59	PASS
	6	2437	18.56	30.00	28.59	PASS
	11	2462	18.30	30.00	28.59	PASS
☒802.11n (HT20)	1	2412	18.58	30.00	28.59	PASS
	6	2437	17.93	30.00	28.59	PASS
	11	2462	18.29	30.00	28.59	PASS
☒802.11n (HT40)	3	2422	16.23	30.00	28.59	PASS
	6	2437	16.75	30.00	28.59	PASS
	9	2452	16.40	30.00	28.59	PASS

Temperature :	28°C	Test Date :	April 05, 2017
Humidity :	65 %	Test By:	King Kong
Antenna:	B		

Operation Mode	Channel Number	Channel Frequency (MHz)	Measurement Level (dBm)	Limit for Antenna Style 1 (dBm)	Limit for Antenna Style 2 (dBm)	Verdict
☒802.11b	1	2412	15.81	30.00	28.59	PASS
	6	2437	15.62	30.00	28.59	PASS
	11	2462	15.38	30.00	28.59	PASS
☒802.11g	1	2412	18.50	30.00	28.59	PASS
	6	2437	18.51	30.00	28.59	PASS
	11	2462	18.28	30.00	28.59	PASS
☒802.11n (HT20)	1	2412	18.54	30.00	28.59	PASS
	6	2437	17.90	30.00	28.59	PASS
	11	2462	18.25	30.00	28.59	PASS
☒802.11n (HT40)	3	2422	16.21	30.00	28.59	PASS
	6	2437	16.72	30.00	28.59	PASS
	9	2452	16.39	30.00	28.59	PASS

Temperature :	28°C	Test Date :	April 05, 2017
Humidity :	65 %	Test By:	King Kong
Antenna:	A+B		

Operation Mode	Channel Number	Channel Frequency (MHz)	Measurement Level (dBm)	Limit for Antenna Style 1 (dBm)	Limit for Antenna Style 2 (dBm)	Verdict
☒802.11n (HT20)	1	2412	21.57	30.00	28.59	PASS
	6	2437	20.93	30.00	28.59	PASS
	11	2462	21.28	30.00	28.59	PASS
☒802.11n (HT40)	3	2422	19.23	30.00	28.59	PASS
	6	2437	19.75	30.00	28.59	PASS
	9	2452	19.41	30.00	28.59	PASS

Duty cycle

Antenna A

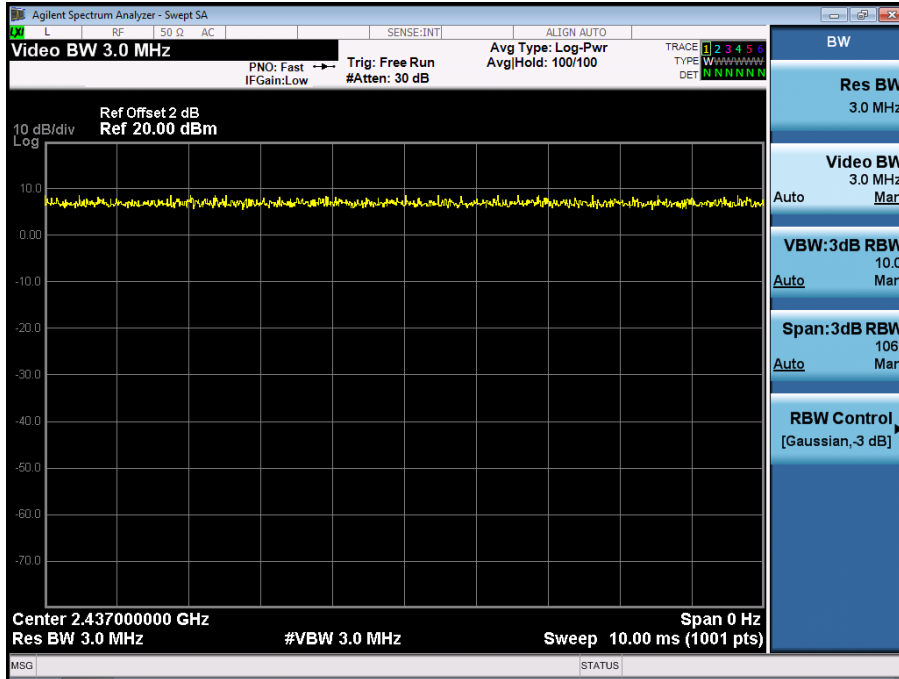

Antenna B

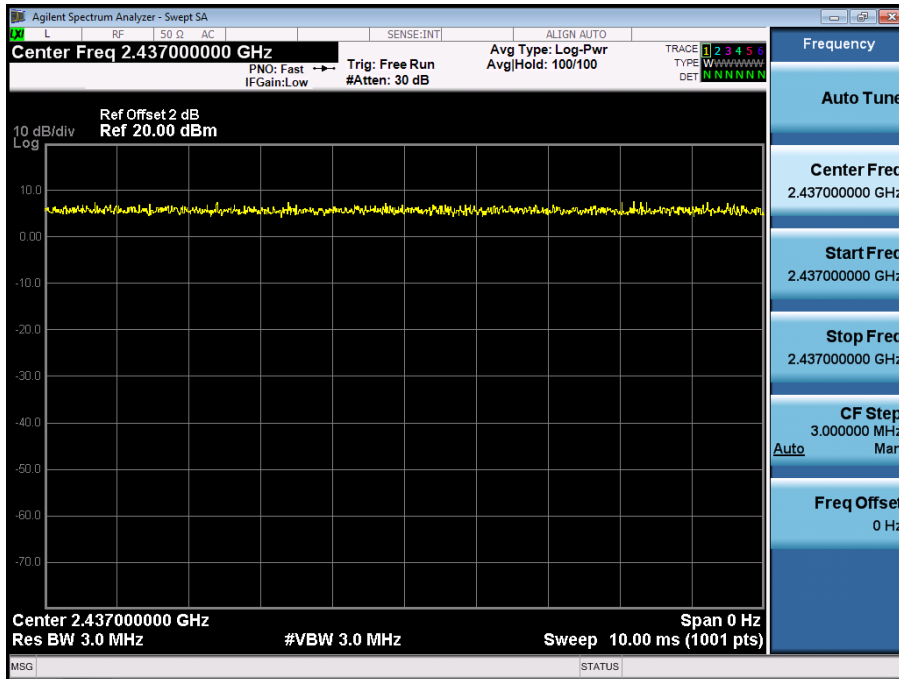

8.3 MAXIMUM POWER SPECTRAL DENSITY

8.3.1 Applicable Standard

According to FCC Part 15.247(e) and KDB 558074 DTS 01 Meas. Guidance v03r05

8.3.2 Conformance Limit

The transmitter power spectral density conducted from the transmitter to the antenna shall not be greater than 8 dBm in any 3 kHz band during any time interval of continuous transmission.

8.3.3 Test Configuration

Test according to clause 7.1 radio frequency test setup 1

8.3.4 Test Procedure

This procedure shall be used if maximum peak conducted output power was used to demonstrate compliance

The transmitter output (antenna port) was connected to the spectrum analyzer

Set analyzer center frequency to DTS channel center frequency.

Set the span to 1.5 times the DTS bandwidth.

Set the RBW to: 3 kHz

Set the VBW to: 10 kHz.

Set Detector = peak.

Set Sweep time = auto couple.

Set Trace mode = max hold.

Allow trace to fully stabilize.

Use the peak marker function to determine the maximum amplitude level within the RBW.

Note: If antenna Gain exceeds 6 dBi, then PSD Limit=8-(Gain - 6)

8.3.5 Test Results

All modes with adapter1 and adapter2 were tested; the worst case is adapter1 mode that was reported for this item.

Temperature :	28°C	Humidity :	65 %
Antenna:	A	Test By:	King Kong

Operation Mode	Channel Number	Channel Frequency (MHz)	Measurement Level (dBm/3kHz)	Limit for Ant. Style 1 (dBm/3kHz)	Limit Ant. Style 2 (dBm/3kHz)	Verdict
☒802.11b	1	2412	-10.980	≤8	≤6.59	PASS
	6	2437	-11.753	≤8	≤6.59	PASS
	11	2462	-11.091	≤8	≤6.59	PASS
☒802.11g	1	2412	-13.721	≤8	≤6.59	PASS
	6	2437	-13.339	≤8	≤6.59	PASS
	11	2462	-13.807	≤8	≤6.59	PASS
☒802.11n (HT20)	1	2412	-11.160	≤8	≤6.59	PASS
	6	2437	-12.434	≤8	≤6.59	PASS
	11	2462	-11.956	≤8	≤6.59	PASS
☒802.11n (HT40)	3	2422	-16.388	≤8	≤6.59	PASS
	6	2437	-16.214	≤8	≤6.59	PASS
	9	2452	-16.562	≤8	≤6.59	PASS

Temperature : 28°C	Antenna: B	Antenna: B
Antenna: B	Test By: King Kong	Test By: King Kong

Operation Mode	Channel Number	Channel Frequency (MHz)	Measurement Level (dBm/3kHz)	Limit for Ant. Style 1 (dBm/3kHz)	Limit Ant. Style 2 (dBm/3kHz)	Verdict
☒802.11b	1	2412	-11.770	≤8	≤6.59	PASS
	6	2437	-10.069	≤8	≤6.59	PASS
	11	2462	-11.010	≤8	≤6.59	PASS
☒802.11g	1	2412	-13.720	≤8	≤6.59	PASS
	6	2437	-13.039	≤8	≤6.59	PASS
	11	2462	-14.068	≤8	≤6.59	PASS
☒802.11n (HT20)	1	2412	-13.182	≤8	≤6.59	PASS
	6	2437	-13.118	≤8	≤6.59	PASS
	11	2462	-10.789	≤8	≤6.59	PASS
☒802.11n (HT40)	3	2422	-16.019	≤8	≤6.59	PASS
	6	2437	-15.996	≤8	≤6.59	PASS
	9	2452	-16.120	≤8	≤6.59	PASS

Temperature : 28°C	Humidity : 65 %	Humidity : 65 %
Antenna: A+B	Test By: King Kong	Test By: King Kong

Operation Mode	Channel Number	Channel Frequency (MHz)	Measurement Level (dBm/3kHz)	Limit for Ant. Style 1 (dBm/3kHz)	Limit Ant. Style 2 (dBm/3kHz)	Verdict
☒802.11n (HT20)	1	2412	-9.044	≤8	≤6.59	PASS
	6	2437	-9.752	≤8	≤6.59	PASS
	11	2462	-8.323	≤8	≤6.59	PASS
☒802.11n (HT40)	3	2422	-13.189	≤8	≤6.59	PASS
	6	2437	-13.093	≤8	≤6.59	PASS
	9	2452	-13.325	≤8	≤6.59	PASS

For Antenna A

Test Model Power Spectral Density
802.11b
Channel 1: 2412MHz



Test Model Power Spectral Density
802.11b
Channel 6: 2437MHz



Test Model

Power Spectral Density
802.11b
Channel 11: 2462MHz



Test Model

Power Spectral Density
802.11g
Channel 1: 2412MHz

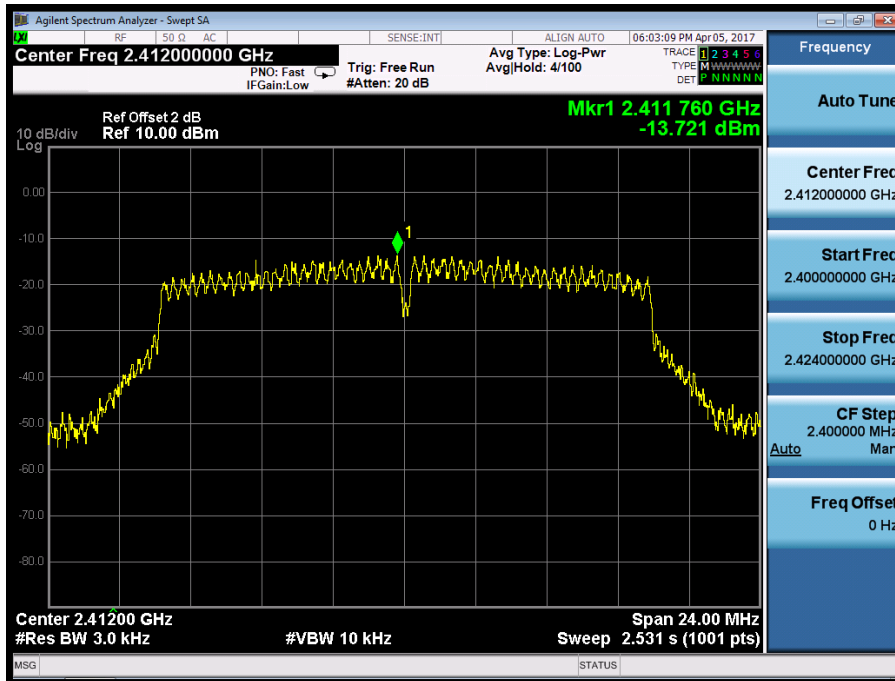

Test Model

Power Spectral Density
802.11g
Channel 6: 2437MHz

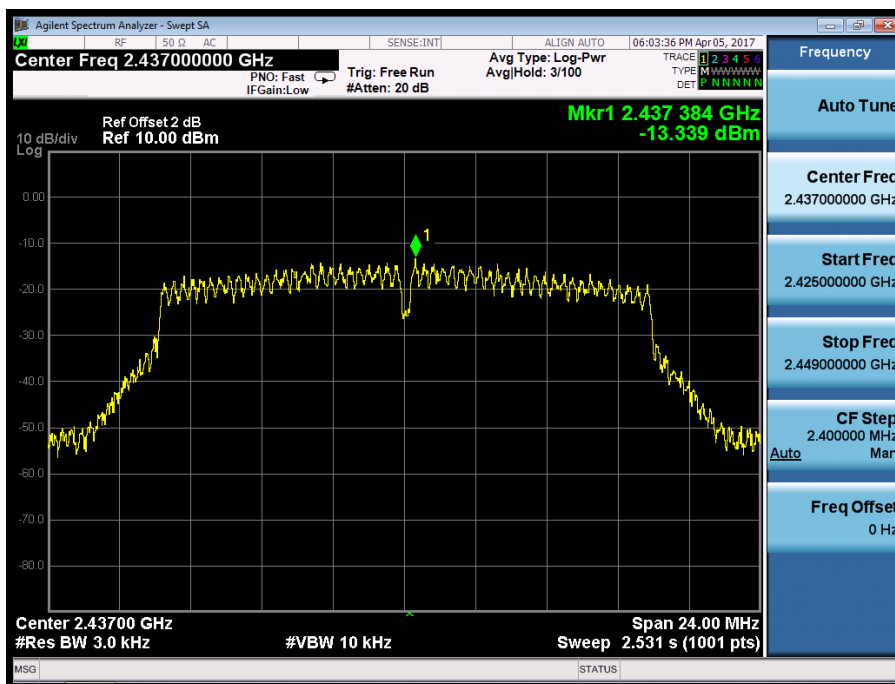

Test Model Power Spectral Density
802.11g
Channel 11: 2462MHz

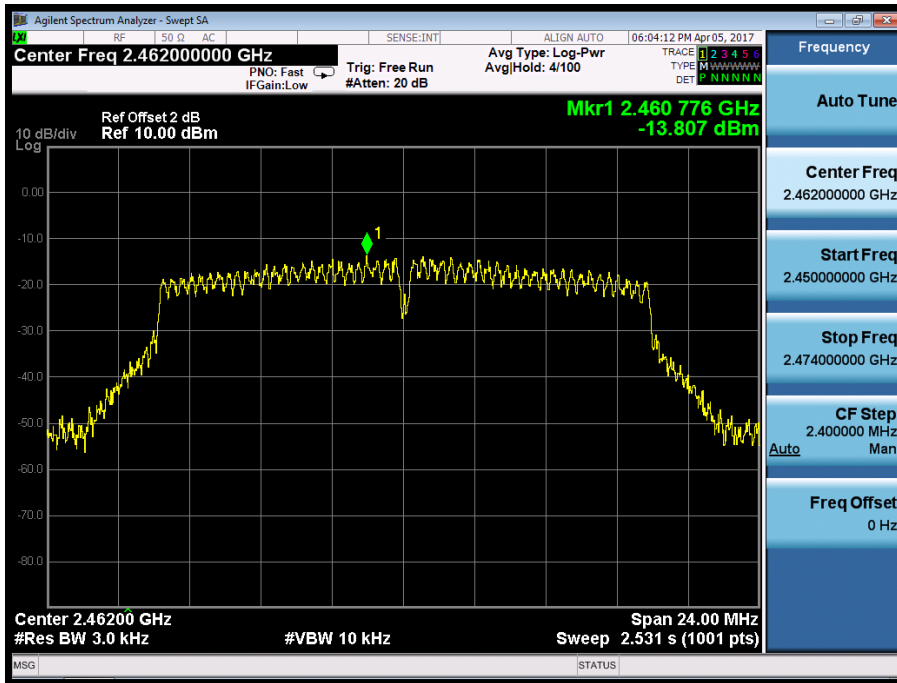

Test Model

Power Spectral Density
802.11n (HT20)
Channel 1: 2412MHz

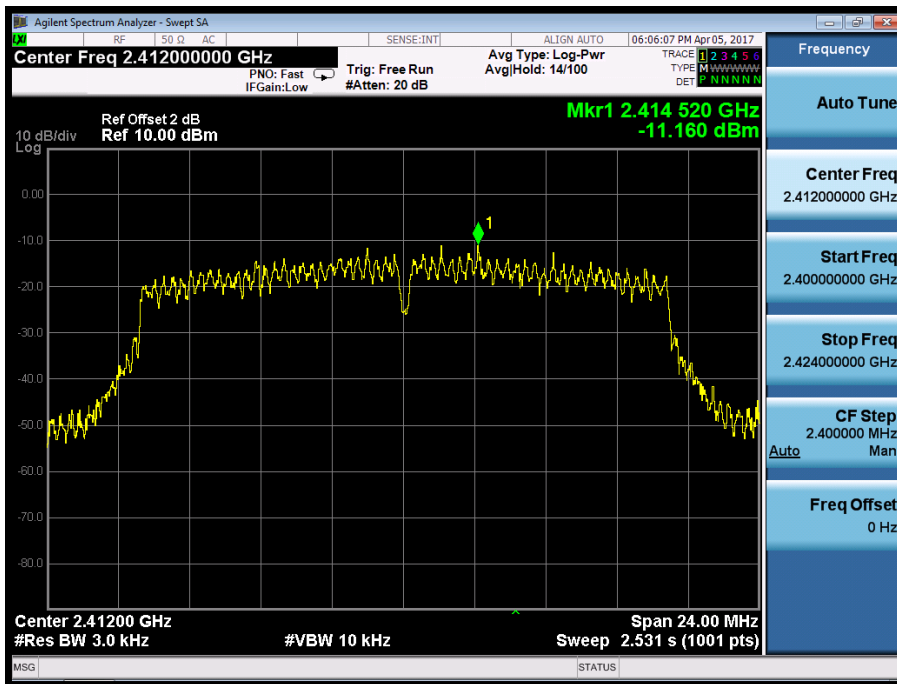

Test Model

Power Spectral Density
802.11n (HT20)
Channel 6: 2437MHz

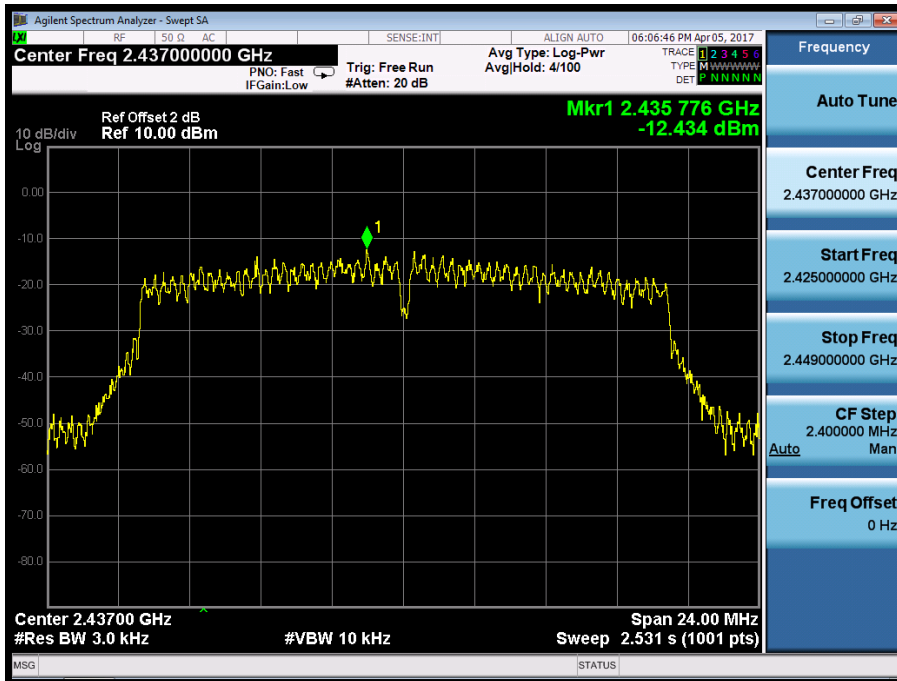

Test Model

Power Spectral Density
802.11n (HT20)
Channel 11: 2462MHz

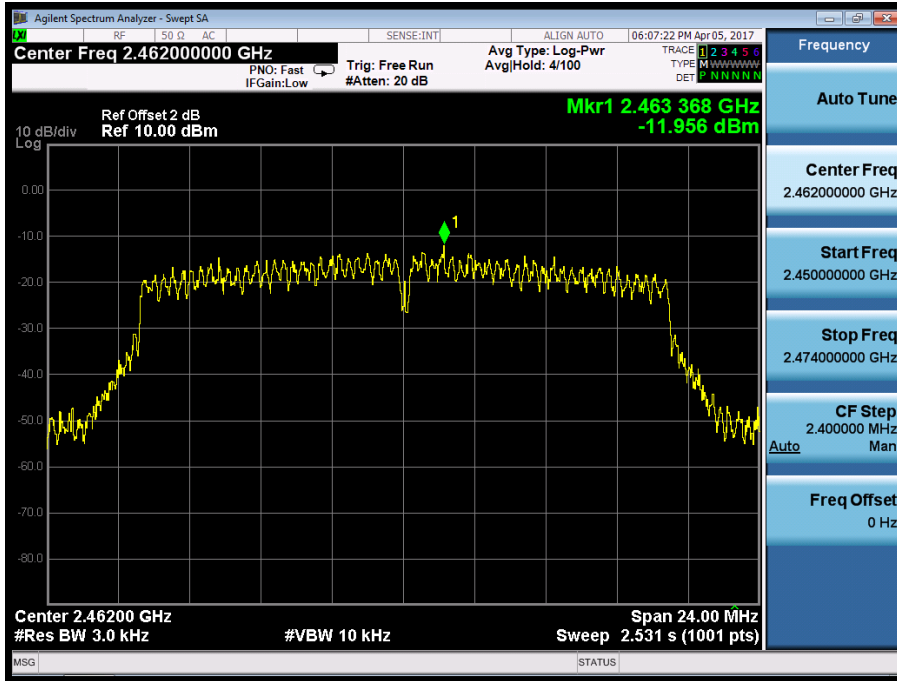

Test Model

Power Spectral Density
802.11n (HT40)
Channel 1: 2422MHz

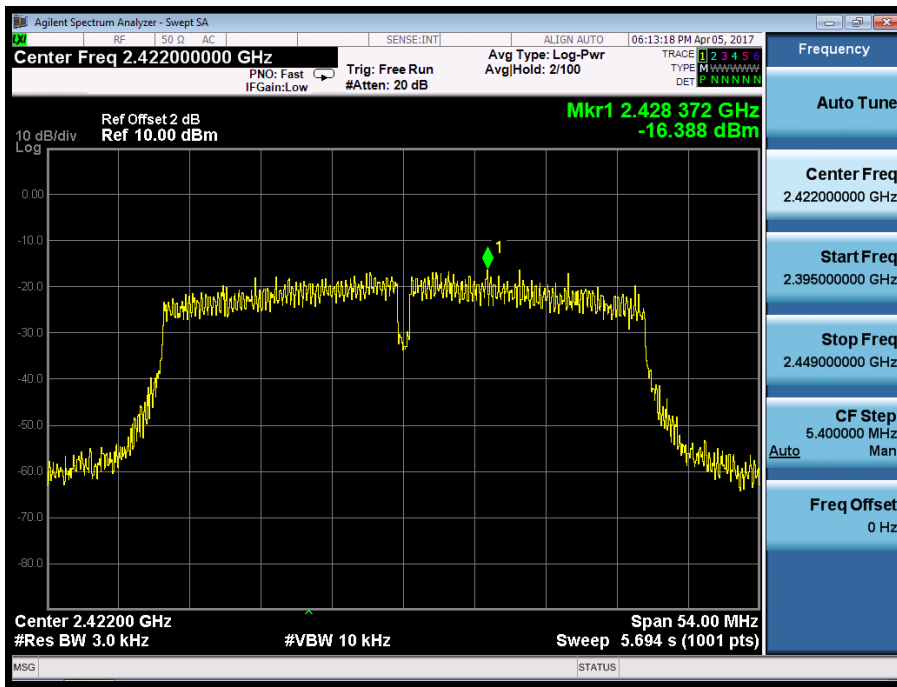

Test Model

Power Spectral Density
802.11n (HT40)
Channel 6: 2437MHz

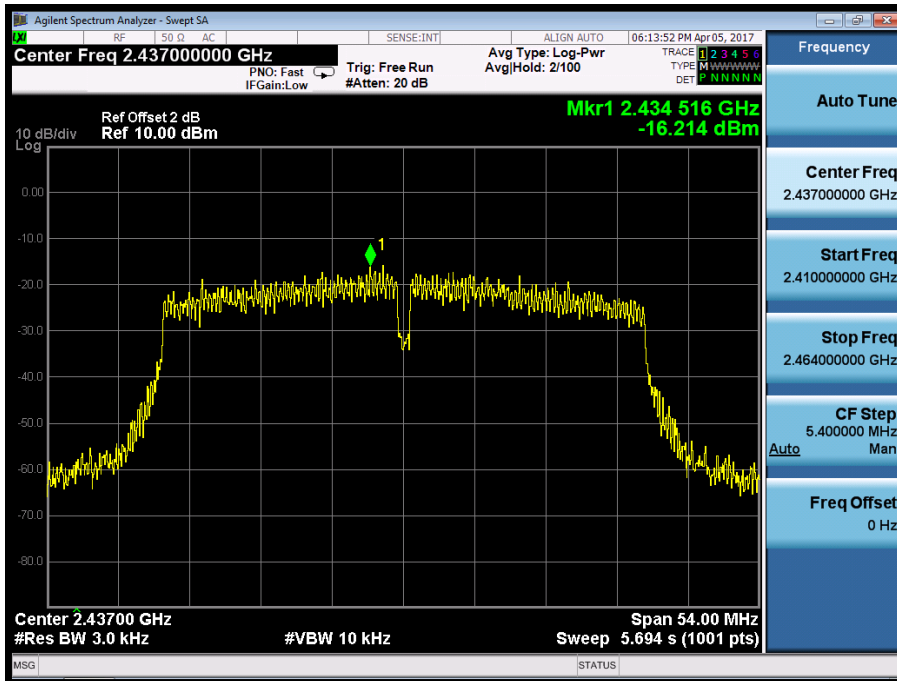

Test Model

Power Spectral Density
802.11n (HT40)
Channel 11: 2452MHz

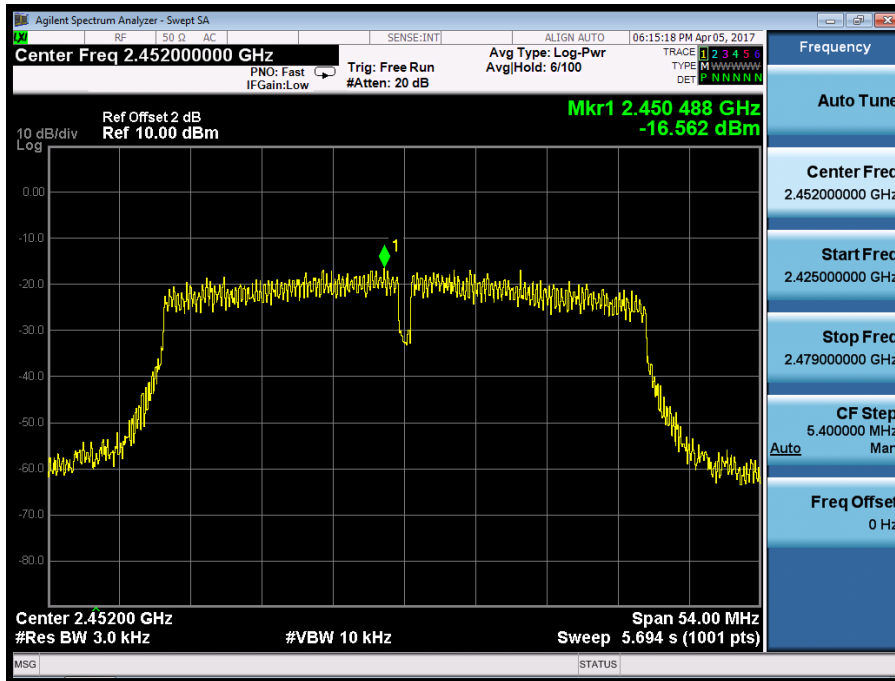

For Antenna B

Test Model

Power Spectral Density
802.11b
Channel 1: 2412MHz

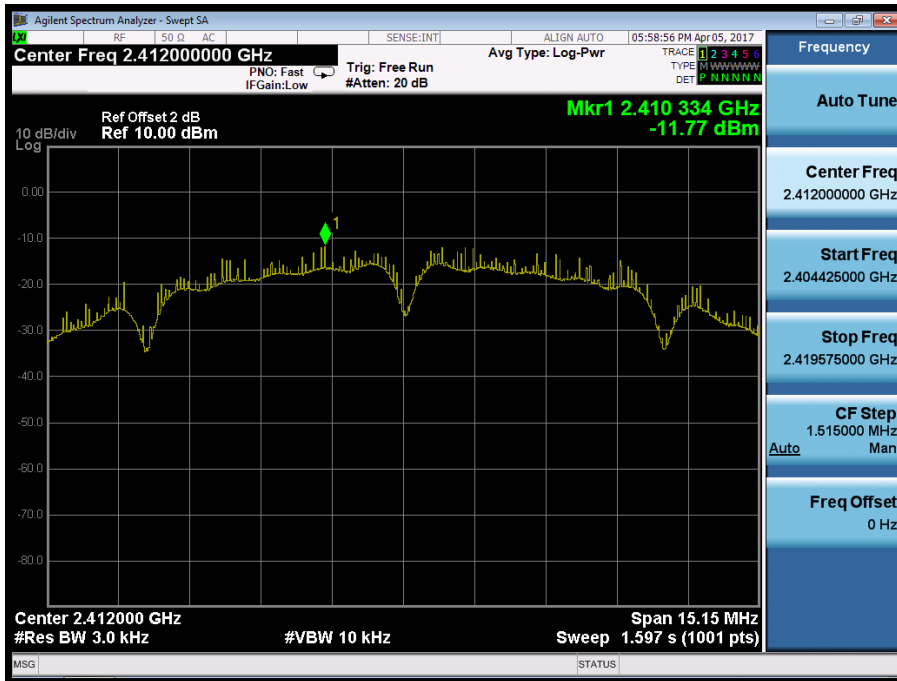

Test Model

Power Spectral Density
802.11b
Channel 6: 2437MHz



Test Model

Power Spectral Density
802.11b
Channel 11: 2462MHz

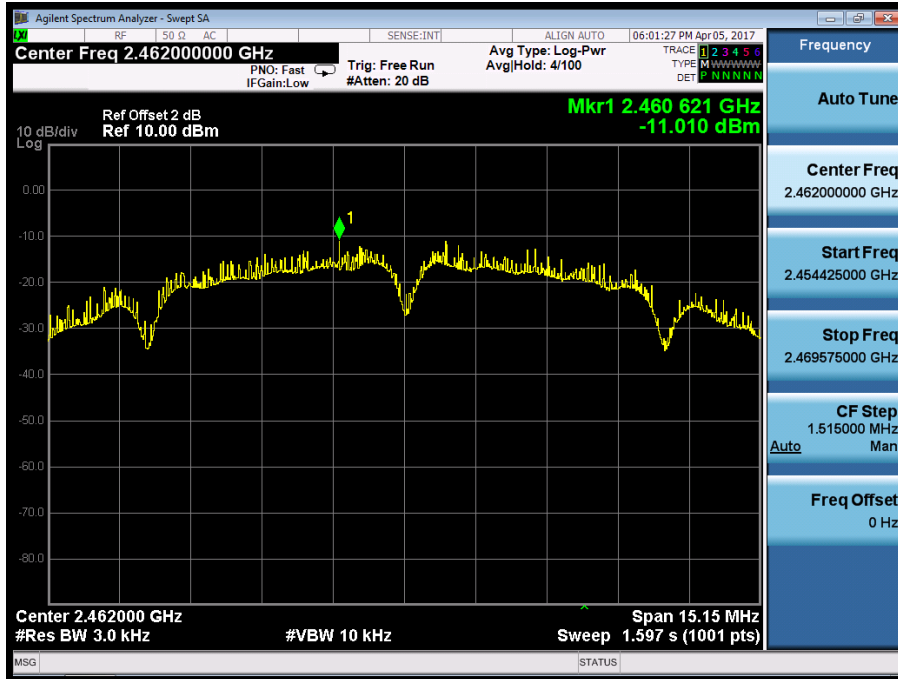

Test Model Power Spectral Density
802.11g
Channel 1: 2412MHz

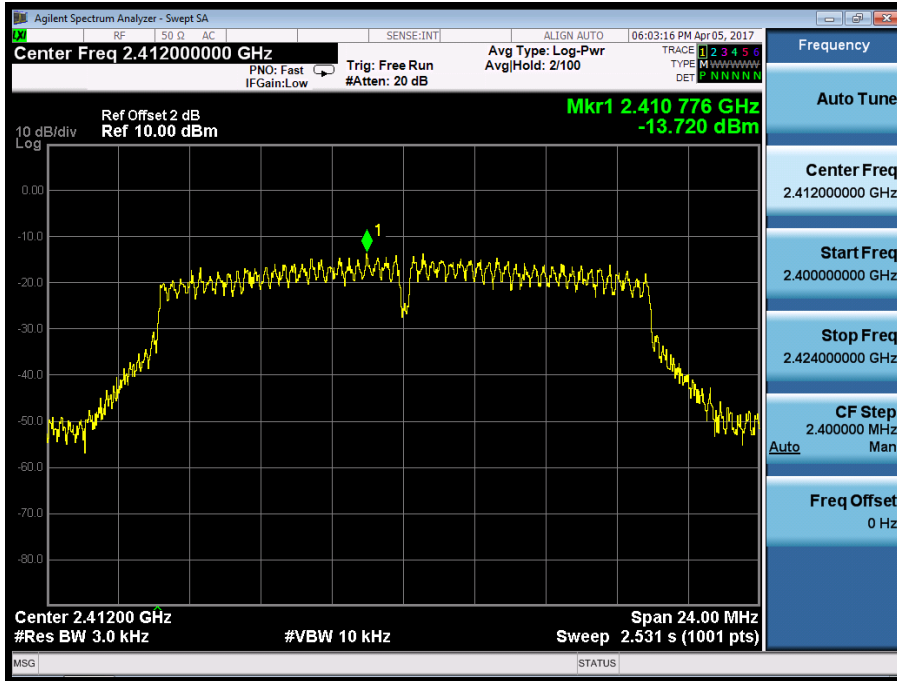

Test Model Power Spectral Density
802.11g
Channel 6: 2437MHz

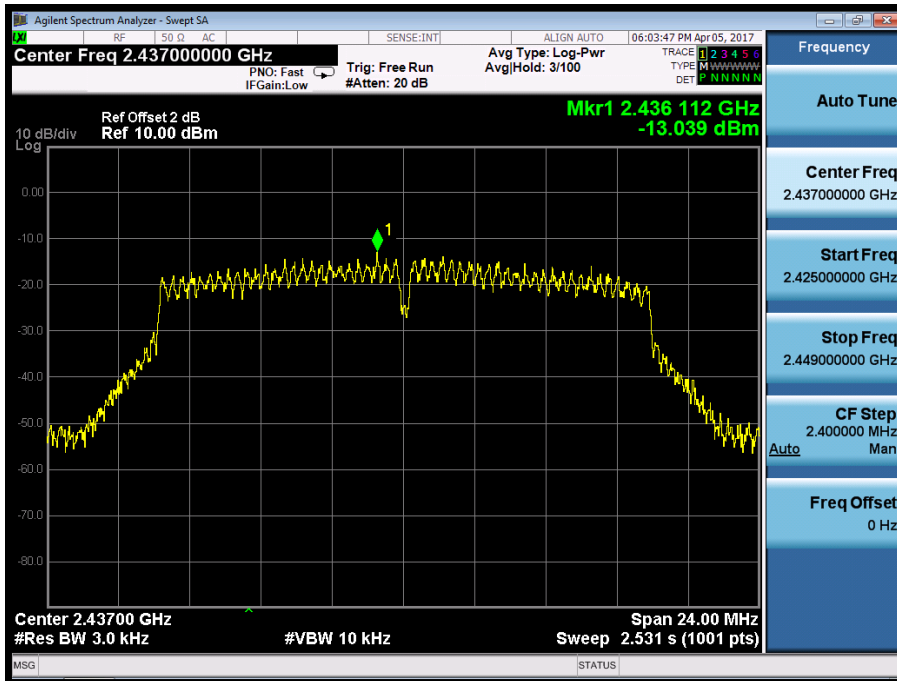

Test Model Power Spectral Density
802.11g
Channel 11: 2462MHz

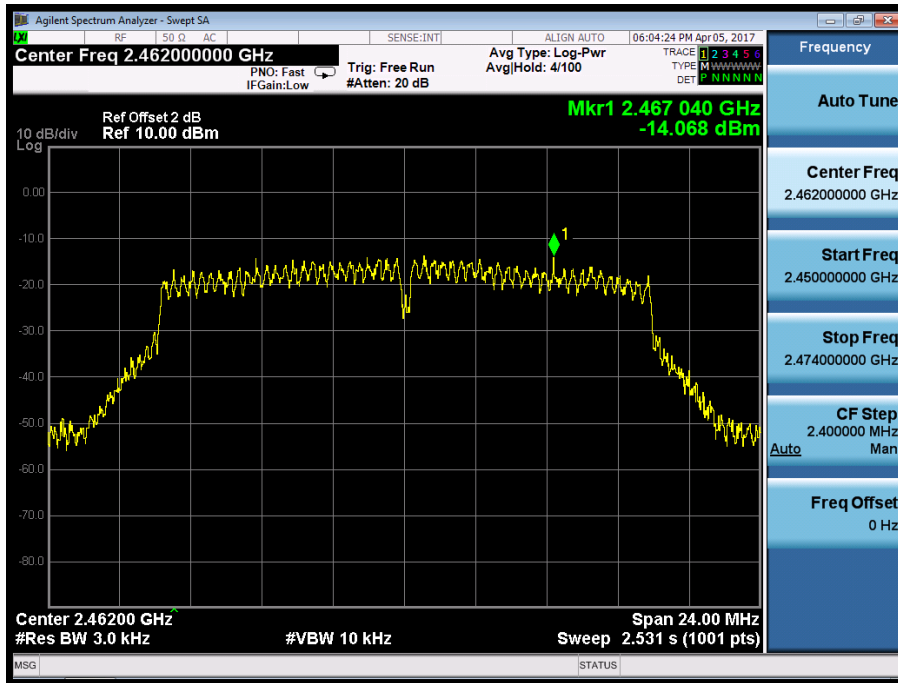

Test Model Power Spectral Density
802.11n (HT20)
Channel 1: 2412MHz

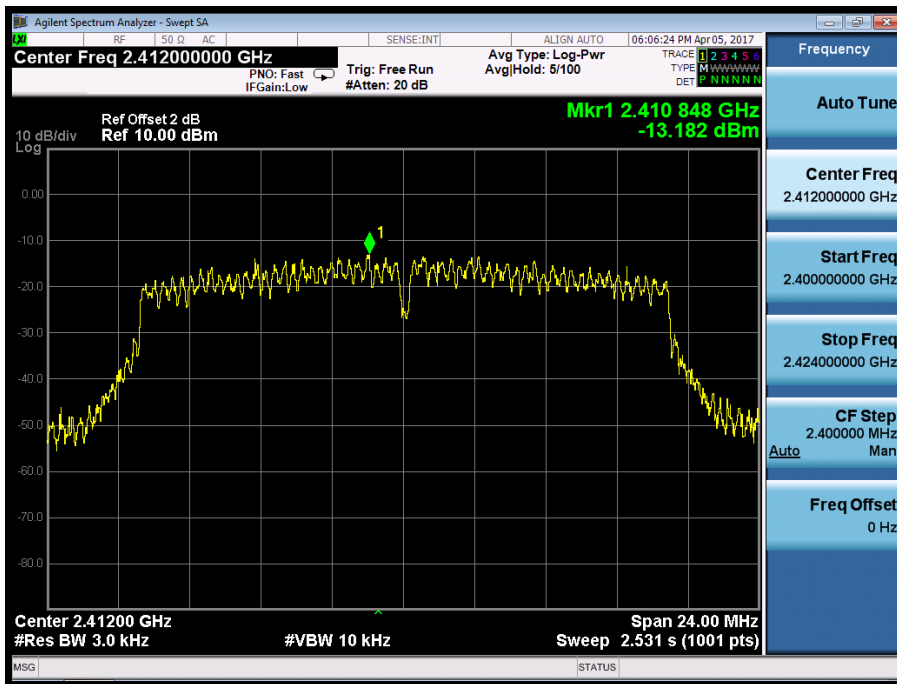

Test Model Power Spectral Density
802.11n (HT20)
Channel 6: 2437MHz

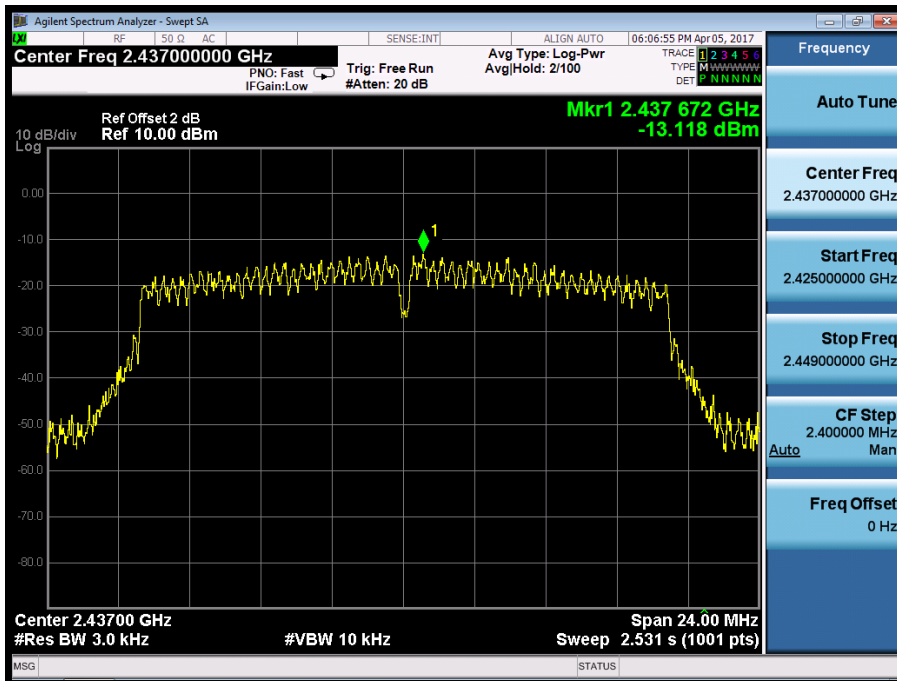

Test Model

Power Spectral Density
802.11n (HT20)
Channel 11: 2462MHz

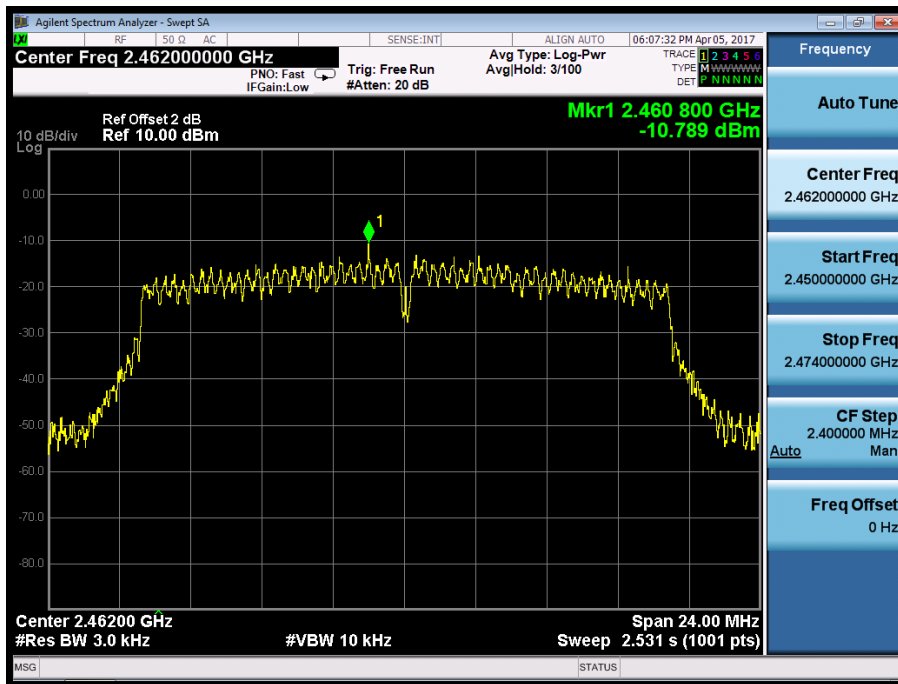

Test Model Power Spectral Density
802.11n (HT40)
Channel 1: 2422MHz

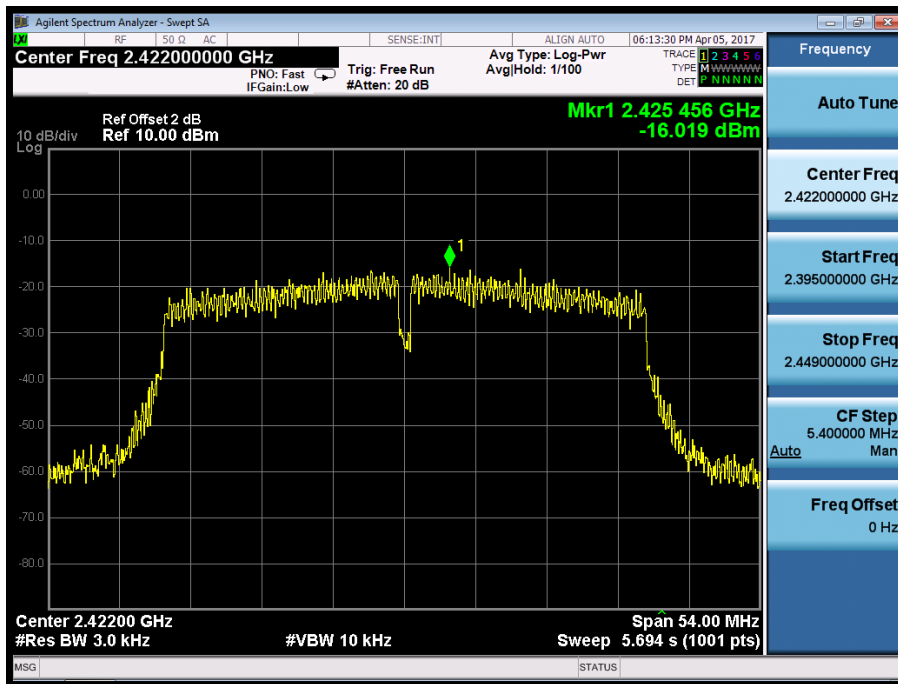

Test Model Power Spectral Density
802.11n (HT40)
Channel 6: 2437MHz

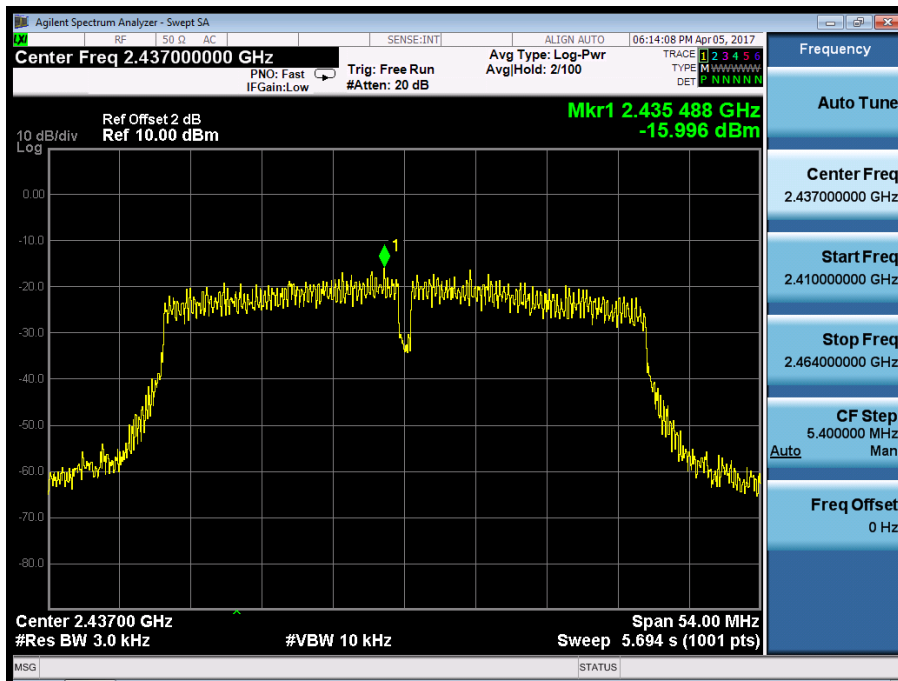

Test Model

Power Spectral Density
802.11n (HT40)
Channel 11: 2452MHz

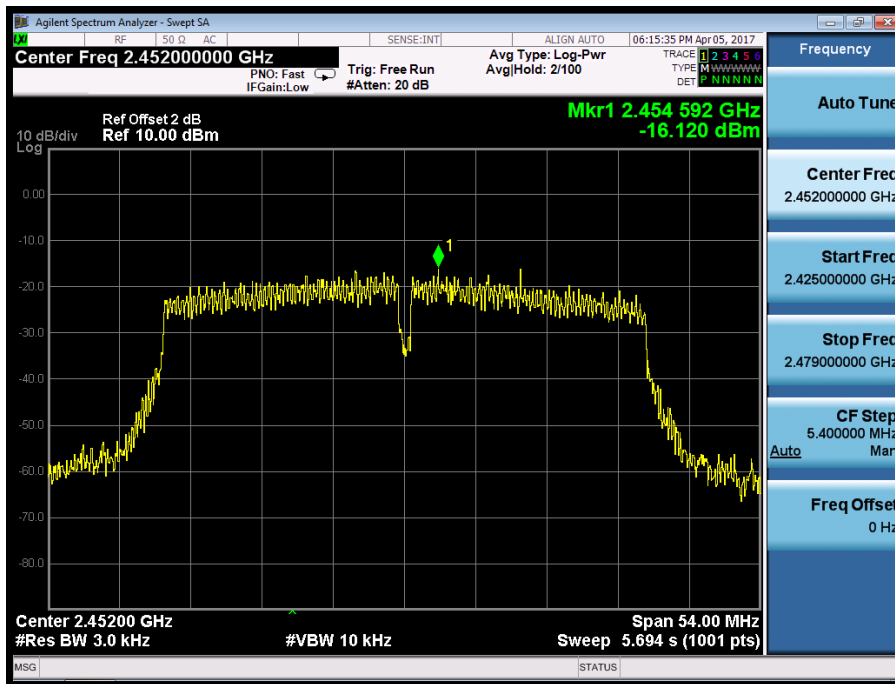

8.4 UNWANTED EMISSIONS IN NON-RESTRICTED FREQUENCY BANDS

8.4.1 Applicable Standard

According to FCC Part 15.247(d) and KDB 558074 DTS 01 Meas. Guidance v03r05

8.4.2 Conformance Limit

According to FCC Part 15.247(d):

In any 100 kHz bandwidth outside the frequency band in which the spread spectrum or digitally modulated intentional radiator is operating, the radio frequency power that is produced by the intentional radiator shall be at least 20 dB below that in the 100 kHz bandwidth within the band that contains the highest level of the desired power, based on either an RF conducted or a radiated measurement, provided the transmitter demonstrates compliance with the peak conducted power limits. If the transmitter complies with the conducted power limits based on the use of RMS averaging over a time interval, as permitted under paragraph (b)(3) of this section, the attenuation required under this paragraph shall be 30 dB instead of 20 dB.

8.4.3 Test Configuration

Test according to clause 7.1 radio frequency test setup 1

8.4.4 Test Procedure

The transmitter output (antenna port) was connected to the spectrum analyzer

■ Reference level measurement

Establish a reference level by using the following procedure:

Set instrument center frequency to DTS channel center frequency.

Set the span to ≥ 1.5 times the DTS bandwidth.

Set the RBW = 100 kHz.

Set the VBW $\geq 3 \times$ RBW.

Set Detector = peak.

Set Sweep time = auto couple.

Set Trace mode = max hold.

Allow trace to fully stabilize.

Use the peak marker function to determine the maximum PSD level.

Note that the channel found to contain the maximum PSD level can be used to establish the reference level.

■ Emission level measurement

Set the center frequency and span to encompass frequency range to be measured.

Set the RBW = 100 kHz.

Set the VBW = 300 kHz.

Set Detector = peak

Sweep time = auto couple.

Trace mode = max hold.

Allow trace to fully stabilize.

Use the peak marker function to determine the maximum amplitude level.

Ensure that the amplitude of all unwanted emissions outside of the authorized frequency band (excluding restricted frequency bands) are attenuated by at least the minimum requirements. Report the three highest emissions relative to the limit.

8.4.5 Test Results

All modes 2.4G 802.11b/g/n with adapter1 and adapter2 have been tested, and the worst result 802.11b with adapter1 for Ant A recorded was report as below:

Test Model PSD(Power Spectral Density) RBW=100kHz
 802.11b 802.11g 802.11n(HT20) 802.11n(HT40)
 Channel 1: 2412MHz Channel 3: 2422MHz

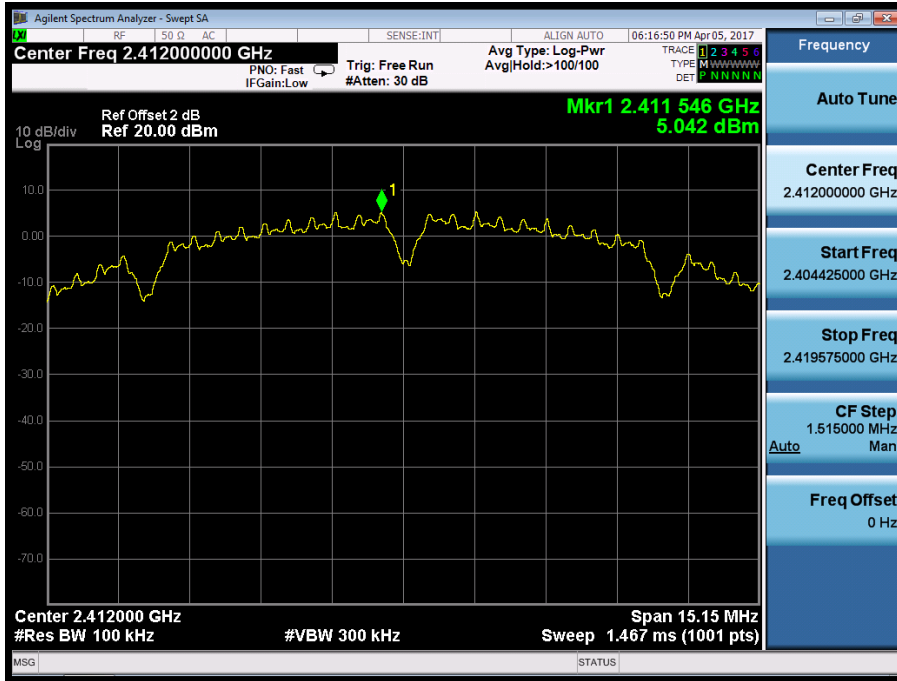

Test Model Unwanted Emissions in non-restricted frequency bands
 802.11b 802.11g 802.11n(HT20) 802.11n(HT40)
 Channel 1: 2412MHz Channel 3: 2422MHz



Test Model	Band edge	<input checked="" type="checkbox"/> 802.11b	<input type="checkbox"/> 802.11g	<input type="checkbox"/> 802.11n(HT20)	<input type="checkbox"/> 802.11n(HT40)
		<input checked="" type="checkbox"/> Channel 1: 2412MHz		<input type="checkbox"/> Channel 3: 2422MHz	



Test Model PSD(Power Spectral Density) RBW=100kHz
802.11b 802.11g 802.11n(HT20) 802.11n(HT40)
 Channel 6: 2437MHz

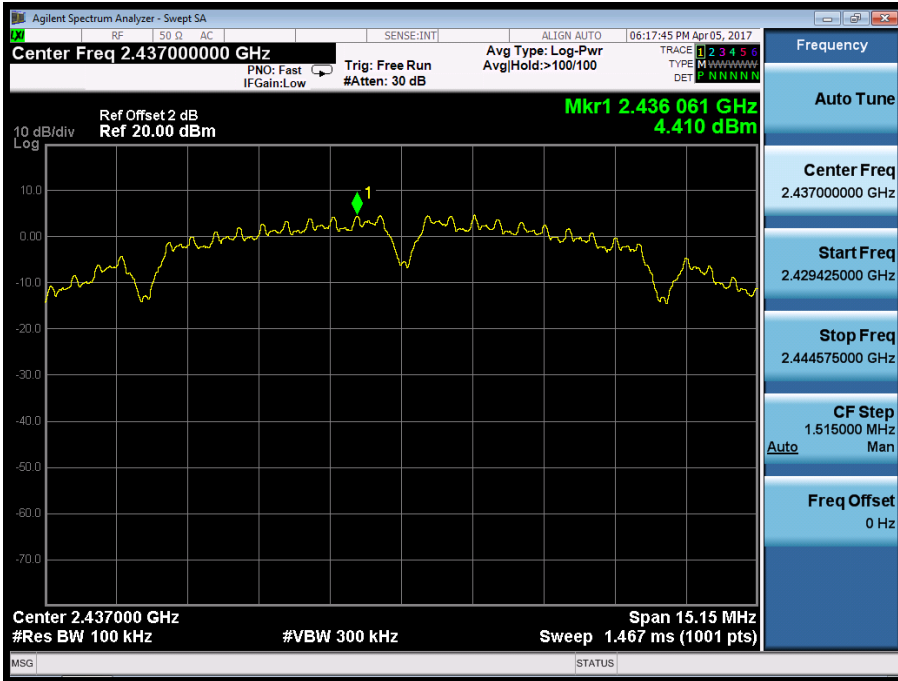

Test Model Unwanted Emissions In Non-Restricted Frequency Bands
802.11b 802.11g 802.11n(HT20) 802.11n(HT40)
 Channel 6: 2437MHz



Test Model PSD(Power Spectral Density) RBW=100kHz
802.11b 802.11g 802.11n(HT20) 802.11n(HT40)
Channel 11: 2462MHz Channel 9: 2452MHz



Test Model Unwanted Emissions In Non-Restricted Frequency Bands
802.11b 802.11g 802.11n(HT20) 802.11n(HT40)
Channel 11: 2462MHz Channel 9: 2452MHz



Test Model	Band edge	<input checked="" type="checkbox"/> 802.11b	<input type="checkbox"/> 802.11g	<input type="checkbox"/> 802.11n(HT20)	<input type="checkbox"/> 802.11n(HT40)
		<input checked="" type="checkbox"/> Channel 11: 2462MHz		<input type="checkbox"/> Channel 9: 2452MHz	

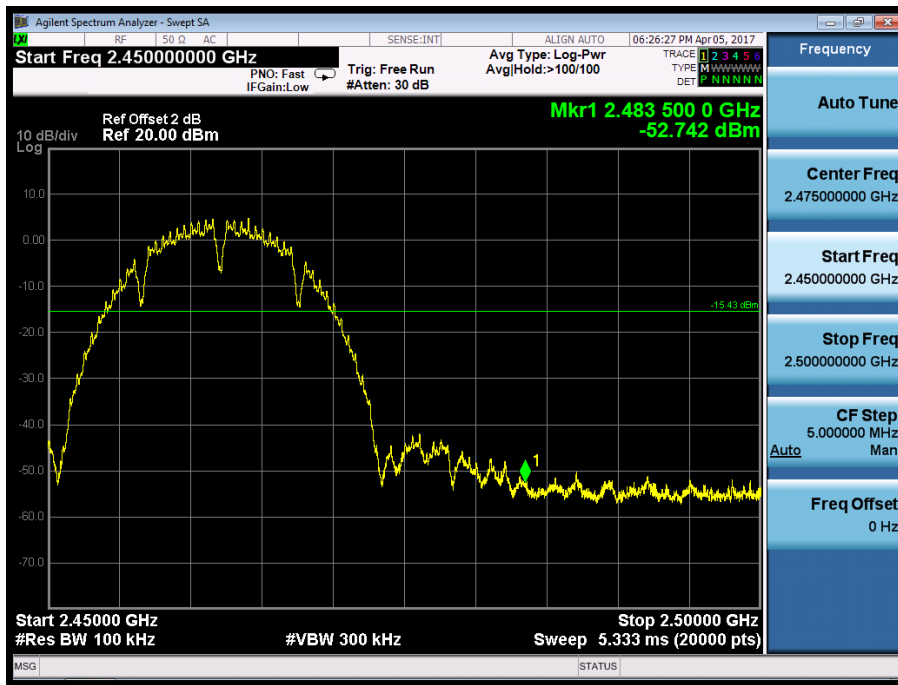

8.5 RADIATED SPURIOUS EMISSION

8.5.1 Applicable Standard

According to FCC Part 15.247(d) and 15.209 and KDB 558074 DTS 01 Meas. Guidance v03r05

8.5.2 Conformance Limit

According to FCC Part 15.247(d): radiated emissions which fall in the restricted bands, as defined in §15.205(a), must also comply with the radiated emission limits specified in §15.209(a) (see §15.205(c)).

According to FCC Part 15.205, Restricted bands

MHz	MHz	MHz	GHz
0.090-0.110	16.42-16.423	399.9-410	4.5-5.15
10.495-0.505	16.69475-16.69525	608-614	5.35-5.46
2.1735-2.1905	16.80425-16.80475	960-1240	7.25-7.75
4.125-4.128	25.5-25.67	1300-1427	8.025-8.5
4.17725-4.17775	37.5-38.25	1435-1626.5	9.0-9.2
4.20725-4.20775	73-74.6	1645.5-1646.5	9.3-9.5
6.215-6.218	74.8-75.2	1660-1710	10.6-12.7
6.26775-6.26825	123-138	2200-2300	14.47-14.5
8.291-8.294	149.9-150.05	2310-2390	15.35-16.2
8.362-8.366	156.52475-156.52525	2483.5-2500	17.7-21.4
8.37625-8.38675	156.7-156.9	2690-2900	22.01-23.12
8.41425-8.41475	162.0125-167.17	3260-3267	23.6-24.0
12.29-12.293	167.72-173.2	3332-3339	31.2-31.8
12.51975-12.52025	240-285	3345.8-3358	36.43-36.5
12.57675-12.57725	322-335.4	3600-4400	(2)
13.36-13.41			

According to FCC Part 15.205, the level of any transmitter spurious emission in Restricted bands shall not exceed the level of the emission specified in the following table

Restricted Frequency(MHz)	Field Strength ($\mu\text{V}/\text{m}$)	Field Strength ($\text{dB}\mu\text{V}/\text{m}$)	Measurement Distance
0.009-0.490	2400/F(KHz)	20 log (uV/m)	300
0.490-1.705	2400/F(KHz)	20 log (uV/m)	30
1.705-30	30	29.5	30
30-88	100	40	3
88-216	150	43.5	3
216-960	200	46	3
Above 960	500	54	3

Remark :1. Emission level in $\text{dB}\mu\text{V}/\text{m}=20 \log (\text{uV}/\text{m})$

2. Measurement was performed at an antenna to the closed point of EUT distance of meters.

3. Distance extrapolation factor $=40 \log (\text{Specific distance}/ \text{test distance})(\text{dB})$;

Limit line=Specific limits($\text{dB}\mu\text{V}$) + distance extrapolation factor.

for the frequency ranges below 30 MHz, a narrower RBW is used for these ranges but the measured value should add a RBW correction factor (RBWCF) where $\text{RBWCF} [\text{dB}]=10 \cdot \lg (100 [\text{kHz}]/\text{narrower RBW} [\text{kHz}])$. , the narrower RBW is 1 kHz and RBWCF is 20 dB for the frequency 9 kHz to 150 kHz, and the narrower RBW is 10 kHz and RBWCF is 10 dB for the frequency 150 kHz to 30 MHz.

8.5.3 Test Configuration

Test according to clause 7.2 radio frequency test setup 2

8.5.4 Test Procedure

This test is required for any spurious emission that falls in a Restricted Band, as defined in Section 15.205. It must be performed with the highest gain of each type of antenna proposed for use with the EUT. Use the following spectrum analyzer settings:

For Above 1GHz:

The EUT was placed on a turn table which is 1.5m above ground plane.

Maximum procedure was performed on the highest emissions to ensure EUT compliance.

Span = wide enough to fully capture the emission being measured

RBW = 1 MHz

VBW \geq RBW

Sweep = auto

Detector function = peak

Trace = max hold

For Below 1GHz:

The EUT was placed on a turn table which is 0.8m above ground plane.

Maximum procedure was performed on the highest emissions to ensure EUT compliance.

Span = wide enough to fully capture the emission being measured

RBW = 100 kHz for

VBW \geq RBW

Sweep = auto

Detector function = peak

Trace = max hold

For Below 30MHz:

The EUT was placed on a turn table which is 0.8m above ground plane.

Maximum procedure was performed on the highest emissions to ensure EUT compliance.

Span = wide enough to fully capture the emission being measured

RBW = 9kHz

VBW \geq RBW

Sweep = auto

Detector function = peak

Trace = max hold

For Below 150KHz:

The EUT was placed on a turn table which is 0.8m above ground plane.

Maximum procedure was performed on the highest emissions to ensure EUT compliance.

Span = wide enough to fully capture the emission being measured

RBW = 200Hz

VBW \geq RBW

Sweep = auto

Detector function = peak

Trace = max hold

Follow the guidelines in ANSI C63.10-2013 with respect to maximizing the emission by rotating the EUT, measuring the emission while the EUT is situated in three orthogonal planes (if appropriate), adjusting the measurement antenna height and polarization, etc. A pre-amp and a high pass filter are required for this test, in order to provide the measuring system with sufficient sensitivity. Allow the trace to stabilize. The peak reading of the emission, after being corrected by the antenna factor, cable loss, pre-amp gain, etc., is the peak field strength, which must comply with the limit specified in Section 15.35(b). Submit this data.

Now set the VBW to 10 Hz, while maintaining all of the other instrument settings. This peak level, once corrected, must comply with the limit specified in Section 15.209. If the dwell time per channel of the hopping signal is less than 100 ms, then the reading obtained with the 10 Hz VBW may be further adjusted by a "duty cycle correction factor", derived from $20\log(\text{dwell time}/100 \text{ ms})$, in an effort to demonstrate compliance with the 15.209 limit. Submit this data.

Repeat above procedures until all frequency measured was complete.

8.5.5 Test Results

■ Spurious Emission below 30MHz (9KHz to 30MHz)

Temperature:	24°C	Test Date:	April 05, 2017
Humidity:	53 %	Test By:	King Kong
Test mode:	TX Mode		

Freq. (MHz)	Ant.Pol. H/V	Emission Level(dBuV/m)		Limit 3m(dBuV/m)		Over(dB)	
		PK	AV	PK	AV	PK	AV
--	--	--	--	--	--	--	--

Note: the amplitude of spurious emission that is attenuated by more than 20dB below the permissible limit has no need to be reported.

Distance extrapolation factor = $40\log(\text{Specific distance/ test distance})$ (dB);

Limit line=Specific limits(dBuV) + distance extrapolation factor

■ **For Antenna style 1**

Spurious Emission Above 1GHz (1GHz to 25GHz)

All modes 2.4G 802.11b/g/n with adapter1 and adapter2 have been tested, and the worst result 802.11b with adapter1 recorded was report as below:

Temperature :	28°C	Test Date :	April 05, 2017
Humidity :	65 %	Test By:	King Kong
Test mode:	802.11b	Frequency:	Channel 1: 2412MHz

Freq. (MHz)	Ant.Pol. H/V	Emission Level(dBuV/m)		Limit 3m(dBuV/m)		Over(dB)	
		PK	AV	PK	AV	PK	AV
4824.84	V	49.95	43.57	74.00	54.00	-24.05	-10.43
7236.70	V	46.70	41.90	74.00	54.00	-27.30	-12.10
9583.31	V	54.54	42.65	74.00	54.00	-19.46	-11.35
--	--	--	--	--	--	--	--
--	--	--	--	--	--	--	--
--	--	--	--	--	--	--	--
4824.11	H	48.34	43.63	74.00	54.00	-25.66	-10.37
7237.40	H	46.94	41.22	74.00	54.00	-27.06	-12.78
9917.91	H	54.82	43.59	74.00	54.00	-19.18	-10.41

Temperature :	28°C	Test Date :	April 05, 2017
Humidity :	65 %	Test By:	King Kong
Test mode:	802.11b	Frequency:	Channel 6: 2437MHz

Freq. (MHz)	Ant.Pol. H/V	Emission Level(dBuV/m)		Limit 3m(dBuV/m)		Over(dB)	
		PK	AV	PK	AV	PK	AV
4875.38	V	50.91	43.77	74.00	54.00	-23.09	-10.23
7311.57	V	45.71	41.72	74.00	54.00	-28.29	-12.28
10075.27	V	53.99	42.15	74.00	54.00	-20.01	-11.85
--	--	--	--	--	--	--	--
--	--	--	--	--	--	--	--
--	--	--	--	--	--	--	--
4875.24	H	48.11	44.60	74.00	54.00	-25.89	-9.40
7312.02	H	47.46	41.55	74.00	54.00	-26.54	-12.45
10011.78	H	53.95	42.90	74.00	54.00	-20.05	-11.10

Temperature :	28°C	Test Date :	April 05, 2017
Humidity :	65 %	Test By:	King Kong
Test mode:	802.11b	Frequency:	Channel 11: 2462MHz

Freq. (MHz)	Ant.Pol. H/V	Emission Level(dBuV/m)		Limit 3m(dBuV/m)		Over(dB)	
		PK	AV	PK	AV	PK	AV
4925.14	V	51.62	43.55	74.00	54.00	-22.38	-10.45
7387.32	V	44.86	41.17	74.00	54.00	-29.14	-12.83
9536.15	V	53.87	41.70	74.00	54.00	-20.13	-12.30
--	--	--	--	--	--	--	--
--	--	--	--	--	--	--	--
--	--	--	--	--	--	--	--
4925.65	H	47.96	45.26	74.00	54.00	-26.04	-8.74
7386.13	H	47.36	42.27	74.00	54.00	-26.64	-11.73
9364.27	H	54.22	42.14	74.00	54.00	-19.78	-11.86

- Note:**
- (1) All Readings are Peak Value (VBW=3MHz) and Peak Value (VBW=10Hz).
 - (2) Emission Level= Reading Level+Probe Factor +Cable Loss.
 - (3) Data of measurement within this frequency range shown "--" in the table above means the reading of emissions are attenuated more than 20dB below the permissible limits or the field strength is too small to be measured.

■ Spurious Emission in Restricted Band 2310-2390MHz and 2483.5-2500MHz
 All modes 2.4G 802.11b/g/n with adapter1 and adapter2 have been tested, and the worst result 802.11nHT40 MIMO with adapter1 recorded was report as below:

Temperature :	28°C	Test Date :	April 05, 2017
Humidity :	65 %	Test By:	King Kong
Test mode:	802.11nHT40	Frequency:	Channel 3: 2422MHz

Frequency (MHz)	Polarity	PK(dBuV/m) (VBW=3MHz)	Limit 3m (dBuV/m)	AV(dBuV/m) (VBW=10Hz)	Limit 3m (dBuV/m)
2386.96	H	66.31	74.00	45.98	54.00
2387.04	V	64.01	74.00	46.02	54.00

Temperature :	28°C	Test Date :	April 05, 2017
Humidity :	65 %	Test By:	King Kong
Test mode:	802.11nHT40	Frequency:	Channel 9: 2452MHz

Frequency (MHz)	Polarity	PK(dBuV/m) (VBW=3MHz)	Limit 3m (dBuV/m)	AV(dBuV/m) (VBW=10Hz)	Limit 3m (dBuV/m)
2484.07	H	64.06	74.00	45.36	54.00
2483.93	V	64.91	74.00	45.03	54.00

- Note:** (1) All Readings are Peak Value (VBW=3MHz) and Peak Value (VBW=10Hz).
 (2) Emission Level= Reading Level+Probe Factor +Cable Loss.
 (3) Data of measurement within this frequency range shown “ -- ” in the table above means the reading of emissions are attenuated more than 20dB below the permissible limits or the field strength is too small to be measured.

Spurious Emission in Restricted Band 2310-2390MHz
 Test Model 802.11b 802.11g 802.11n(HT20) 802.11n(HT40)
Channel 1: 2412MHz Channel 3: 2422MHz Polarity: H
 VBW=3MHz Test By: King Kong

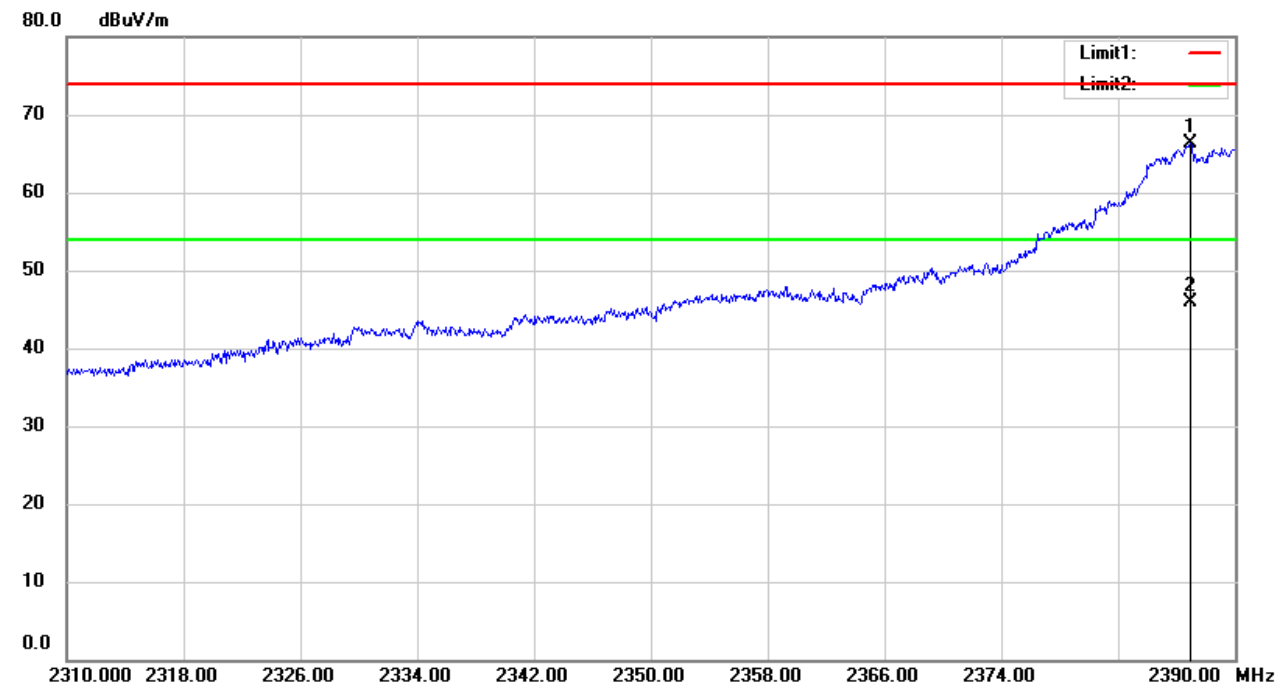

Spurious Emission in Restricted Band 2310-2390MHz
 Test Model 802.11b 802.11g 802.11n(HT20) 802.11n(HT40)
Channel 1: 2412MHz Channel 3: 2422MHz Polarity: V
 VBW=3MHz Test By: King Kong

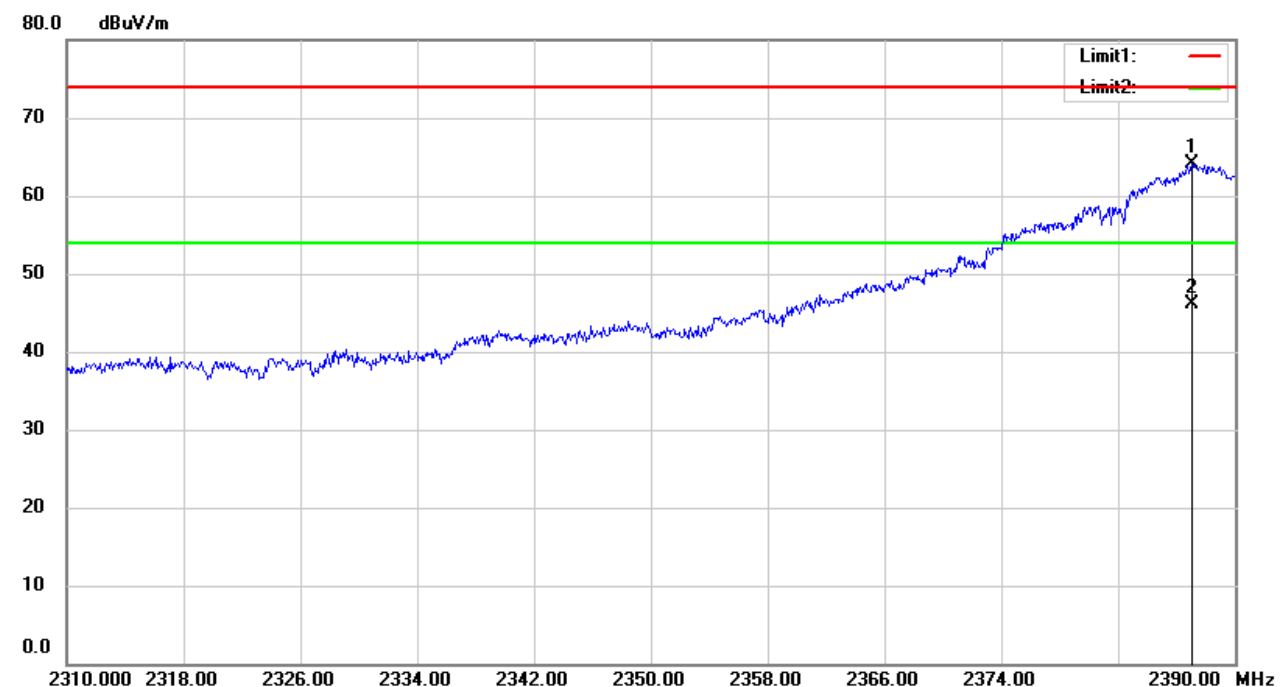

Spurious Emission in Restricted Band 2483.5-2500MHz
 Test Model 802.11b 802.11g 802.11n(HT20) 802.11n(HT40)
 Channel 11: 2462MHz Channel 9: 2452MHz Polarity: H
 VBW=3MHz Test By: King Kong

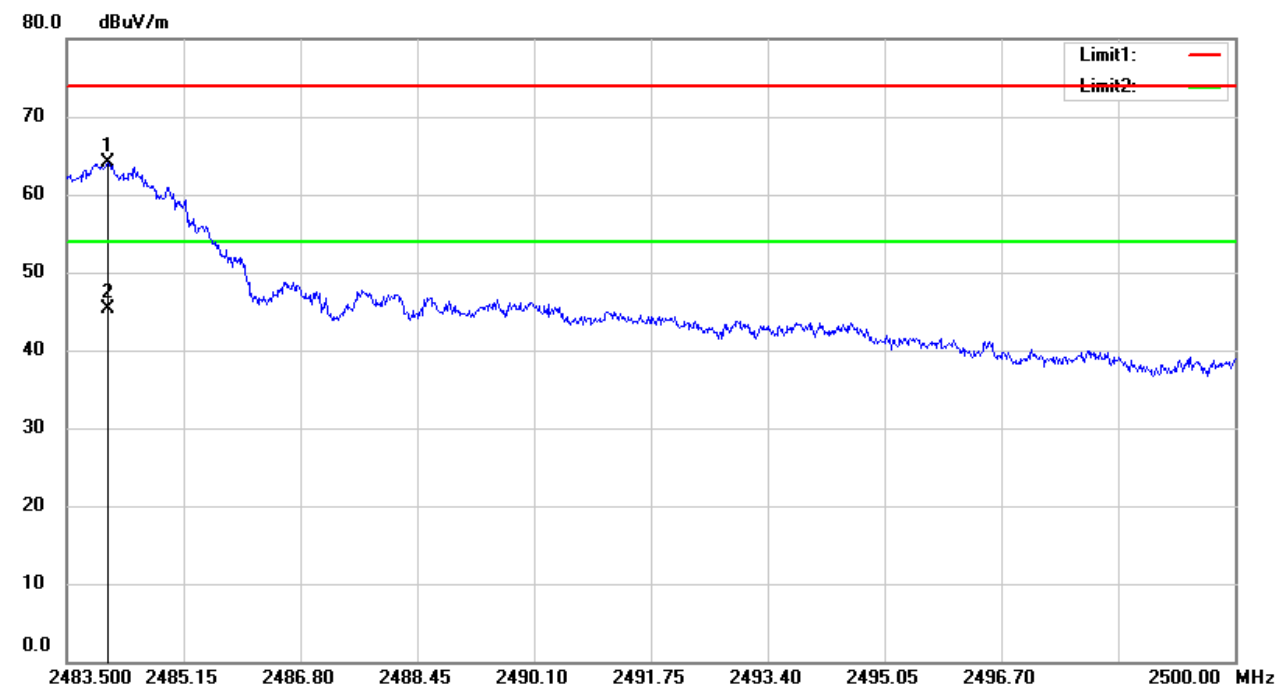

Spurious Emission in Restricted Band 2483.5-2500MHz
 Test Model 802.11b 802.11g 802.11n(HT20) 802.11n(HT40)
 Channel 11: 2462MHz Channel 9: 2452MHz Polarity: V
 VBW=3MHz Test By: King Kong

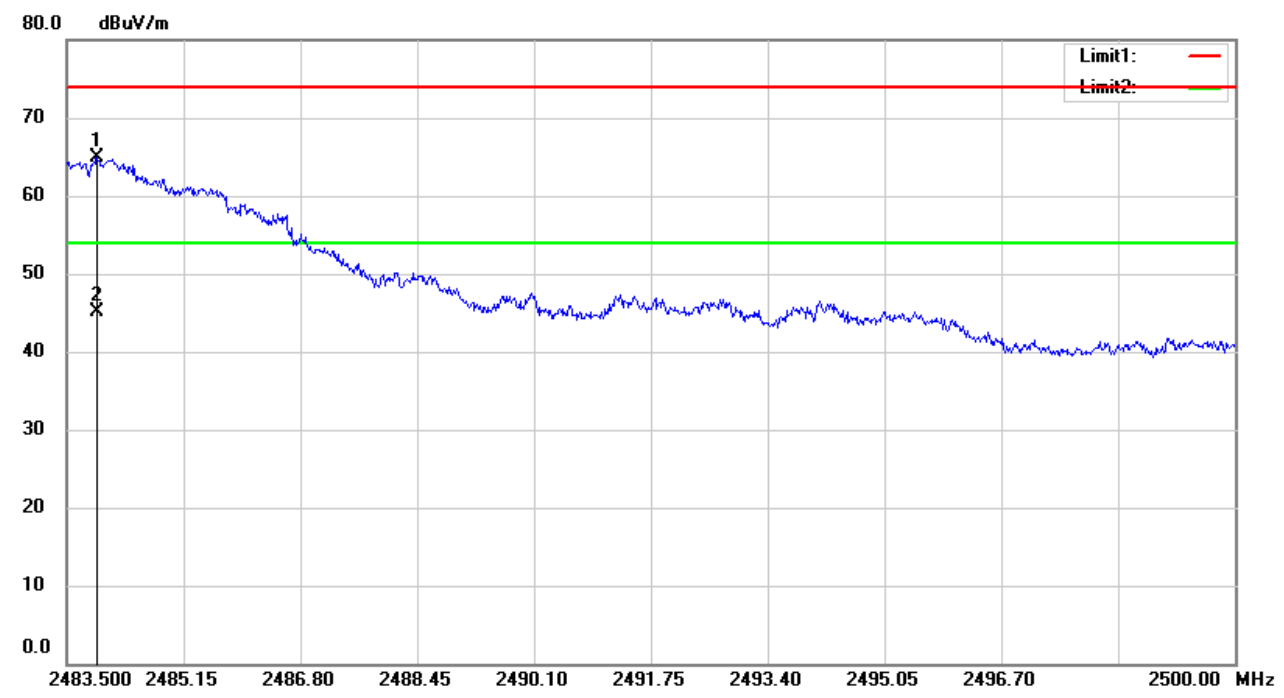

■ **For Antenna style 2**

Spurious Emission Above 1GHz (1GHz to 25GHz)

All modes 2.4G 802.11b/g/n with adapter1 and adapter2 have been tested, and the worst result 802.11b with adapter1 recorded was report as below:

Temperature :	28°C	Test Date :	March 20, 2017
Humidity :	65 %	Test By:	King Kong
Test mode:	802.11b	Frequency:	Channel 1: 2412MHz

Freq. (MHz)	Ant.Pol. H/V	Emission Level(dBuV/m)		Limit 3m(dBuV/m)		Over(dB)	
		PK	AV	PK	AV	PK	AV
4824.95	V	50.78	43.41	74.00	54.00	-23.22	-10.59
7237.98	V	47.37	41.72	74.00	54.00	-26.63	-12.28
9311.55	V	54.47	42.25	74.00	54.00	-19.53	-11.75
--	--	--	--	--	--	--	--
--	--	--	--	--	--	--	--
--	--	--	--	--	--	--	--
4824.32	H	49.87	43.28	74.00	54.00	-24.13	-10.72
7236.47	H	46.00	41.36	74.00	54.00	-28.00	-12.64
9290.89	H	54.56	43.45	74.00	54.00	-19.44	-10.55

Temperature :	28°C	Test Date :	March 20, 2017
Humidity :	65 %	Test By:	King Kong
Test mode:	802.11b	Frequency:	Channel 6: 2437MHz

Freq. (MHz)	Ant.Pol. H/V	Emission Level(dBuV/m)		Limit 3m(dBuV/m)		Over(dB)	
		PK	AV	PK	AV	PK	AV
4874.02	V	49.81	44.13	74.00	54.00	-24.19	-9.87
7312.75	V	48.19	41.85	74.00	54.00	-25.81	-12.15
9556.37	V	54.85	41.83	74.00	54.00	-19.15	-12.17
--	--	--	--	--	--	--	--
--	--	--	--	--	--	--	--
--	--	--	--	--	--	--	--
4875.87	H	49.97	42.43	74.00	54.00	-24.03	-11.57
7312.5	H	45.97	41.58	74.00	54.00	-28.03	-12.42
9991.18	H	53.6	43.9	74.00	54.00	-20.40	-10.10

Temperature :	28°C	Test Date :	March 20, 2017
Humidity :	65 %	Test By:	King Kong
Test mode:	802.11b	Frequency:	Channel 11: 2462MHz

Freq. (MHz)	Ant.Pol. H/V	Emission Level(dBuV/m)		Limit 3m(dBuV/m)		Over(dB)	
		PK	AV	PK	AV	PK	AV
4925.36	V	49.71	44.37	74.00	54.00	-24.29	-9.63
7387.21	V	49.03	41.95	74.00	54.00	-24.97	-12.05
9800.72	V	55.8	41.67	74.00	54.00	-18.20	-12.33
--	--	--	--	--	--	--	--
--	--	--	--	--	--	--	--
--	--	--	--	--	--	--	--
4924.01	H	49.05	42.23	74.00	54.00	-24.95	-11.77
7387.23	H	45.12	42.04	74.00	54.00	-28.88	-11.96
9292.82	H	53.02	44.16	74.00	54.00	-20.98	-9.84

- Note:**
- (1) All Readings are Peak Value (VBW=3MHz) and Average Value (VBW=10Hz).
 - (2) Emission Level= Reading Level+Probe Factor +Cable Loss.
 - (3) Data of measurement within this frequency range shown "--" in the table above means the reading of emissions are attenuated more than 20dB below the permissible limits or the field strength is too small to be measured

■ Spurious Emission in Restricted Band 2310-2390MHz and 2483.5-2500MHz
 All modes 2.4G 802.11b/g/n with adapter1 and adapter2 have been tested, and the worst result 802.11nHT40 MIMO with adapter1 recorded was report as below:

Temperature :	28°C	Test Date :	March 20, 2017
Humidity :	65 %	Test By:	King Kong
Test mode:	802.11nHT40	Frequency:	Channel 3: 2422MHz

Frequency (MHz)	Polarity	PK(dBuV/m) (VBW=3MHz)	Limit 3m (dBuV/m)	AV(dBuV/m) (VBW=10Hz)	Limit 3m (dBuV/m)
2389.12	H	64.76	74.00	48.33	54.00
2389.28	V	64.57	74.00	47.62	54.00

Temperature :	28°C	Test Date :	March 20, 2017
Humidity :	65 %	Test By:	King Kong
Test mode:	802.11nHT40	Frequency:	Channel 9: 2452MHz

Frequency (MHz)	Polarity	PK(dBuV/m) (VBW=3MHz)	Limit 3m (dBuV/m)	AV(dBuV/m) (VBW=10Hz)	Limit 3m (dBuV/m)
2484.01	H	64.86	74.00	48.66	54.00
2483.61	V	63.44	74.00	46.69	54.00

- Note:** (1) All Readings are Peak Value (VBW=3MHz) and Average Value (VBW=10Hz).
 (2) Emission Level= Reading Level + Probe Factor +Cable Loss.
 (3) Data of measurement within this frequency range shown “ -- ” in the table above means the reading of emissions are attenuated more than 20dB below the permissible limits or the field strength is too small to be measured.

Spurious Emission in Restricted Band 2310-2390MHz

Test Model 802.11b 802.11g 802.11n(HT20) 802.11n(HT40)

Channel 1: 2412MHz Channel 3: 2422MHz Polarity: H

VBW=3MHz Test By: King Kong

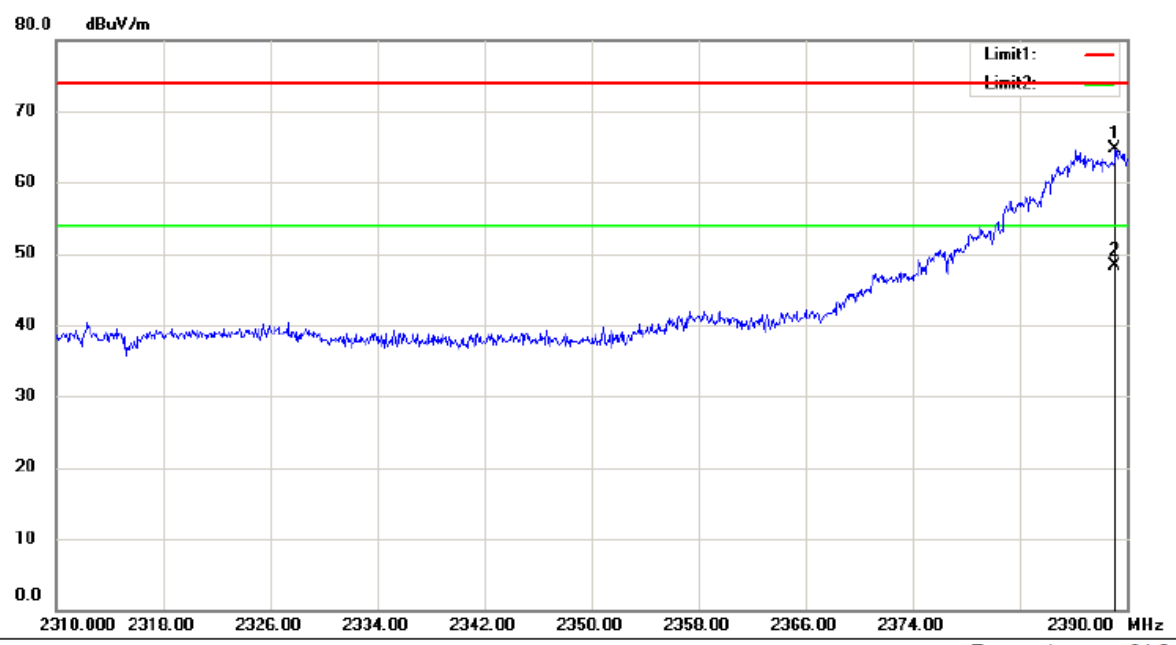

Site 3m Chamber #2 Polarization: **Horizontal** Temperature: 24 C

Limit: (RE)FCC PART 15 CLASS B Power: AC 120V/60Hz Humidity: 53 %

Spurious Emission in Restricted Band 2310-2390MHz

Test Model 802.11b 802.11g 802.11n(HT20) 802.11n(HT40)

Channel 1: 2412MHz Channel 3: 2422MHz Polarity: V

VBW=3MHz Test By: King Kong

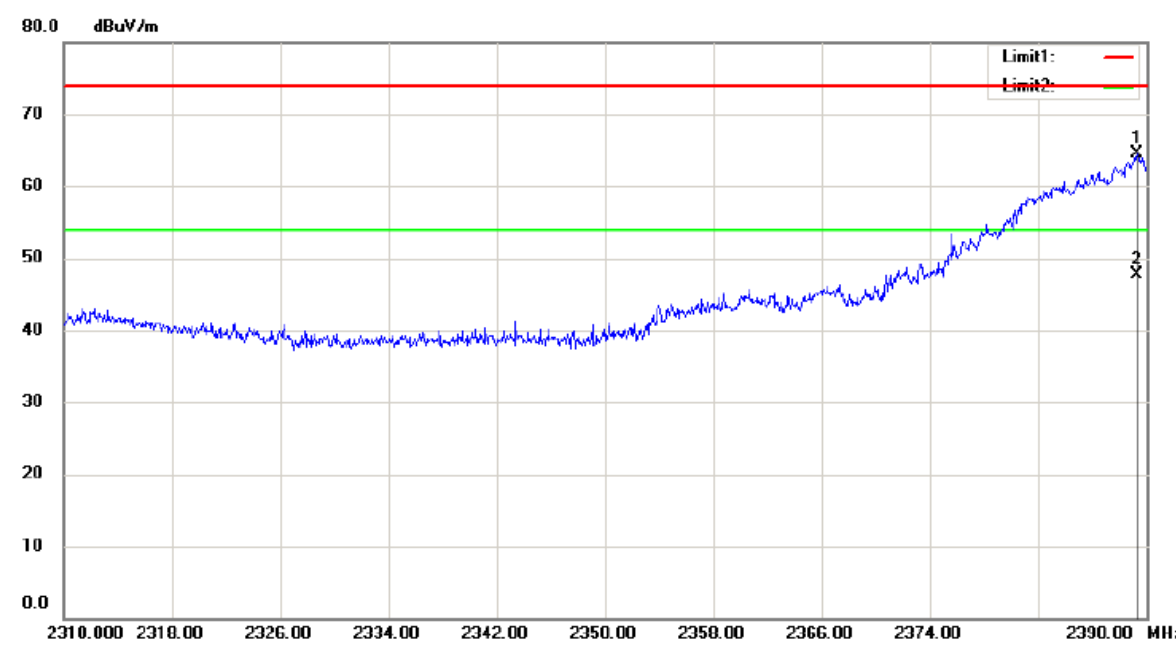

Site 3m Chamber #2 Polarization: **Vertical** Temperature: 24 C

Limit: (RE)FCC PART 15 CLASS B Power: AC 120V/60Hz Humidity: 53 %

Spurious Emission in Restricted Band 2483.5-2500MHz
 Test Model 802.11b 802.11g 802.11n(HT20) 802.11n(HT40)
Channel 11: 2462MHz Channel 9: 2452MHz Polarity: H
 VBW=3MHz Test By: King Kong

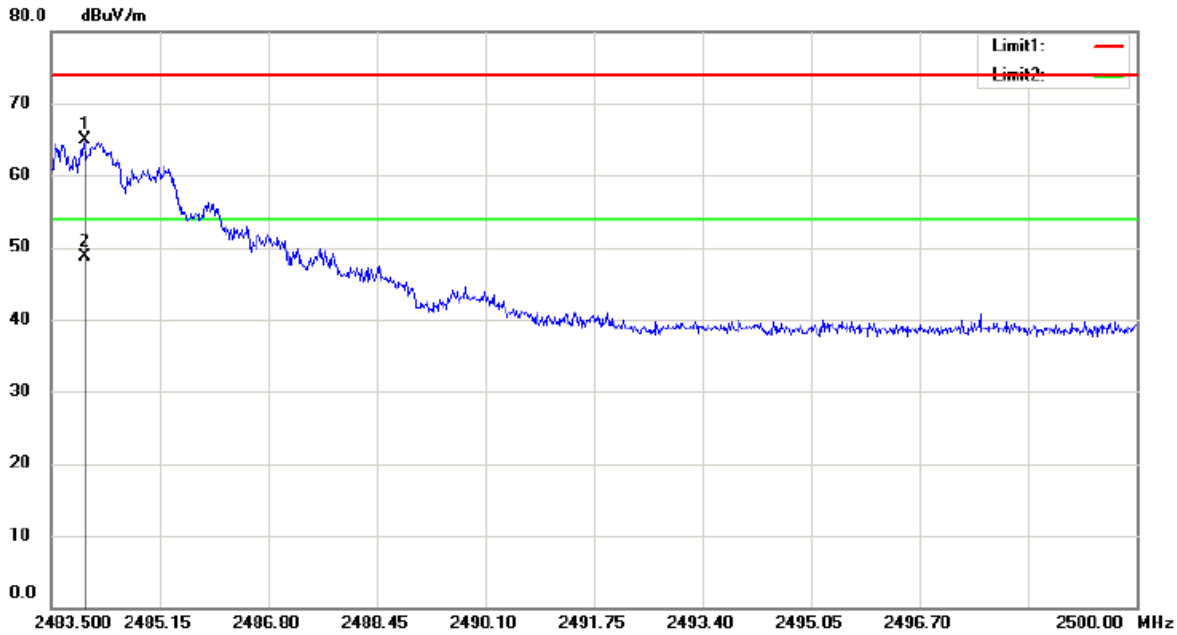

Site 3m Chamber #2 Polarization: **Horizontal** Temperature: 24 C
 Limit: (RE)FCC PART 15 CLASS B Power: AC 120V/60Hz Humidity: 53 %

Spurious Emission in Restricted Band 2483.5-2500MHz
 Test Model 802.11b 802.11g 802.11n(HT20) 802.11n(HT40)
Channel 11: 2462MHz Channel 9: 2452MHz Polarity: V
 VBW=3MHz Test By: King Kong

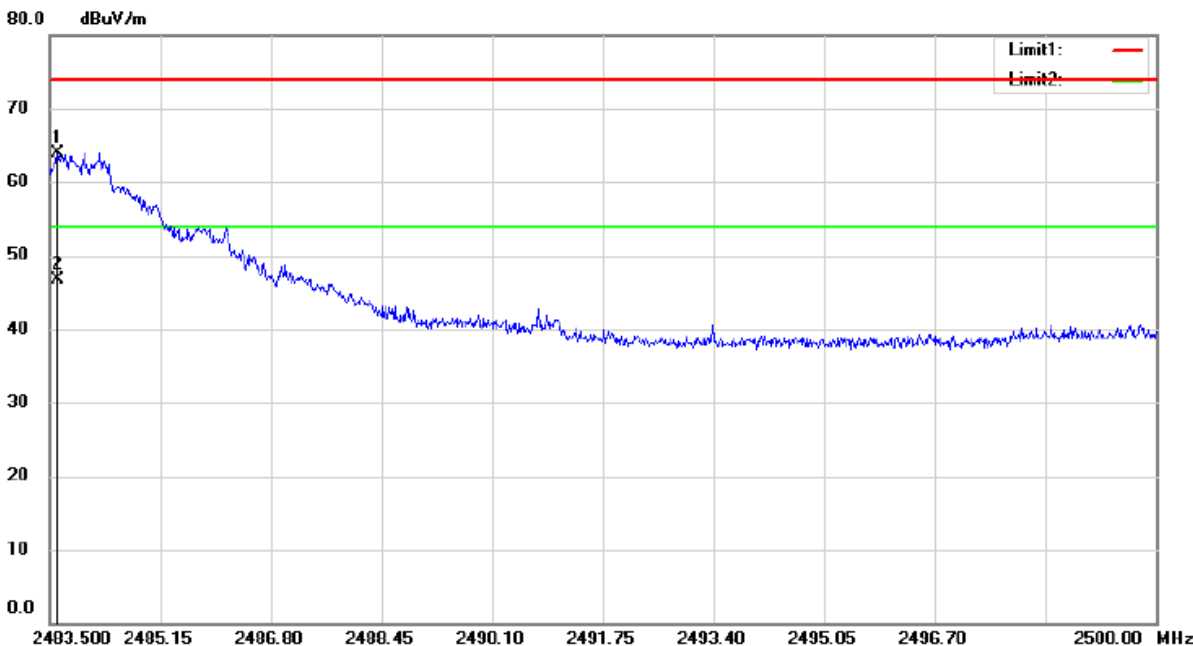

Site 3m Chamber #2 Polarization: **Vertical** Temperature: 24 C
 Limit: (RE)FCC PART 15 CLASS B Power: AC 120V/60Hz Humidity: 53 %

■ Spurious Emission below 1GHz (30MHz to 1GHz)

All modes 2.4G 802.11b/g/n have been tested, and the worst result 802.11b recorded was report as below:

For adapter1

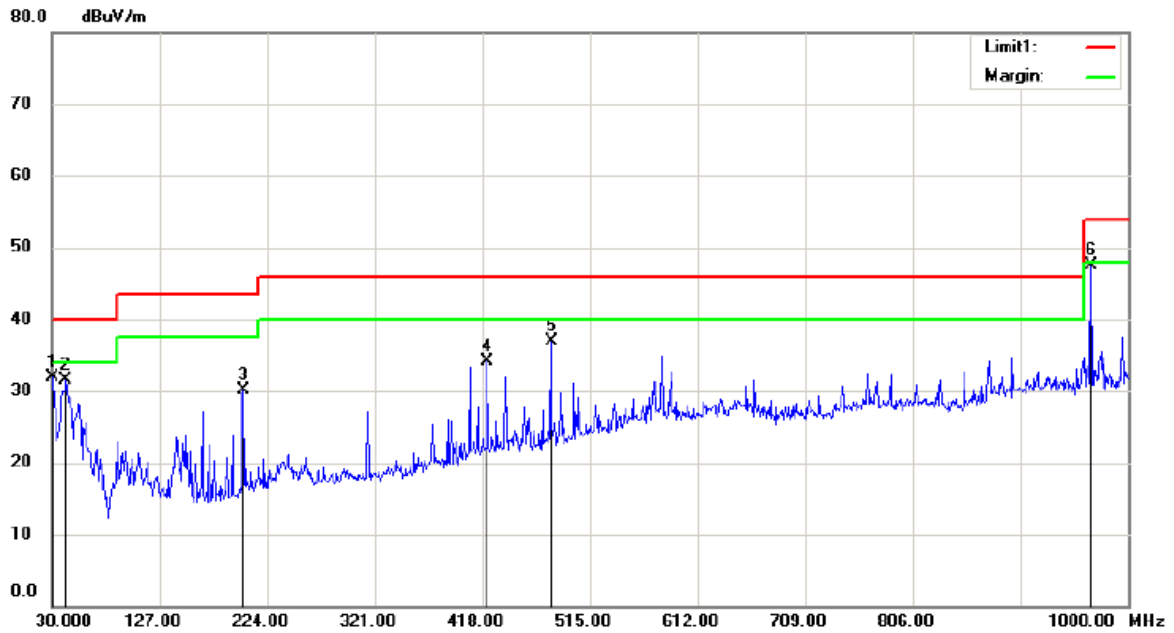

Site 3m Chamber #1 Polarization: *Vertical* Temperature: 22 C
 Limit: (RE)FCC PART 15 CLASS B Power: AC 120V/60Hz Humidity: 50 %
 Mode:802.11B Low channel
 Note:

No.	Mk.	Freq. MHz	Reading Level dBuV	Correct Factor dB	Measure- ment dBuV/m	Limit dBuV/m	Over dB	Detector	Antenna Height cm	Table Degree	Comment
1		30.9700	44.64	-12.76	31.88	40.00	-8.12	QP			
2		42.6100	43.05	-11.57	31.48	40.00	-8.52	QP			
3		202.6600	42.54	-12.41	30.13	43.50	-13.37	QP			
4		422.8500	41.89	-7.81	34.08	46.00	-11.92	QP			
5		480.0800	43.58	-6.76	36.82	46.00	-9.18	QP			
6	*	967.0200	46.13	1.29	47.42	54.00	-6.58	QP			

*:Maximum data x:Over limit !:over margin

Operator: KK

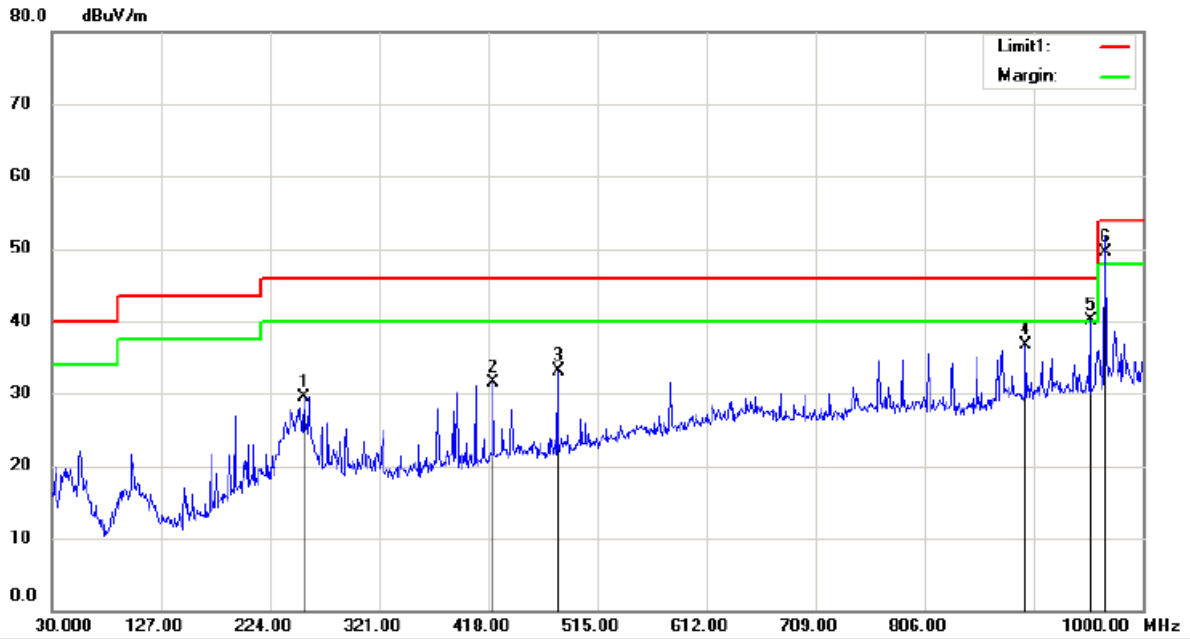

Site: 3m Chamber #1 Polarization: *Horizontal* Temperature: 22 C
 Limit: (RE)FCC PART 15 CLASS B Power: AC 120V/60Hz Humidity: 50 %
 Mode: 802.11B Low channel
 Note:

No.	Mk.	Freq. MHz	Reading Level dBuV	Correct Factor dB	Measure- ment dBuV/m	Limit dBuV/m	Over dB	Antenna Height cm	Table Degree	Comment
1		254.0700	40.35	-10.80	29.55	46.00	-16.45	QP		
2		422.8500	39.25	-7.81	31.44	46.00	-14.56	QP		
3		480.0800	39.93	-6.76	33.17	46.00	-12.83	QP		
4		896.2100	35.63	1.04	36.67	46.00	-9.33	QP		
5	!	953.4400	38.77	1.28	40.05	46.00	-5.95	QP		
6	*	967.0200	48.31	1.29	49.60	54.00	-4.40	QP		

*:Maximum data x:Over limit !:over margin

Operator: KK

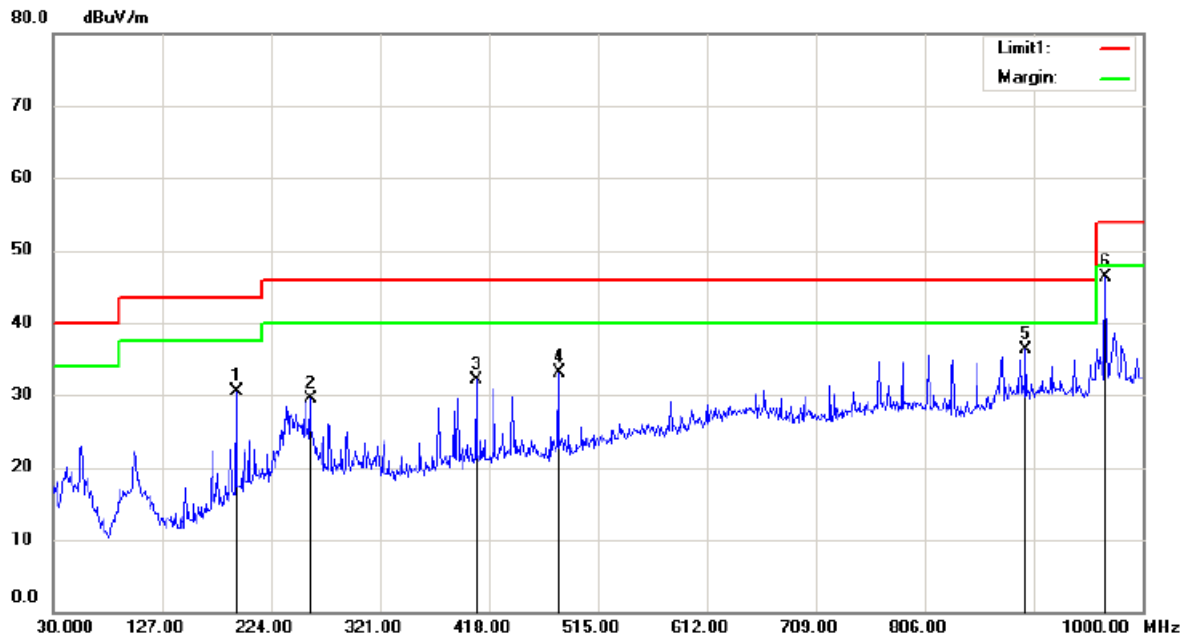

Site 3m Chamber #1

Polarization: **Horizontal**

Temperature: 22 C

Limit: (RE)FCC PART 15 CLASS B

Power: AC 120V/60Hz

Humidity: 50 %

Mode:802.11b Mid channel

Note:

No.	Mk.	Freq. MHz	Reading Level dBuV	Correct Factor dB	Measure- ment dBuV/m	Limit dBuV/m	Over dB	Antenna Height cm	Table Degree	Detector	Comment
1		192.9600	43.28	-12.73	30.55	43.50	-12.95			QP	
2		258.9200	39.86	-10.34	29.52	46.00	-16.48			QP	
3		406.3600	40.32	-8.30	32.02	46.00	-13.98			QP	
4		480.0800	39.87	-6.76	33.11	46.00	-12.89			QP	
5		896.2100	35.22	1.04	36.26	46.00	-9.74			QP	
6	*	967.0200	45.05	1.29	46.34	54.00	-7.66			QP	

*:Maximum data x:Over limit !:over margin

Operator: KK

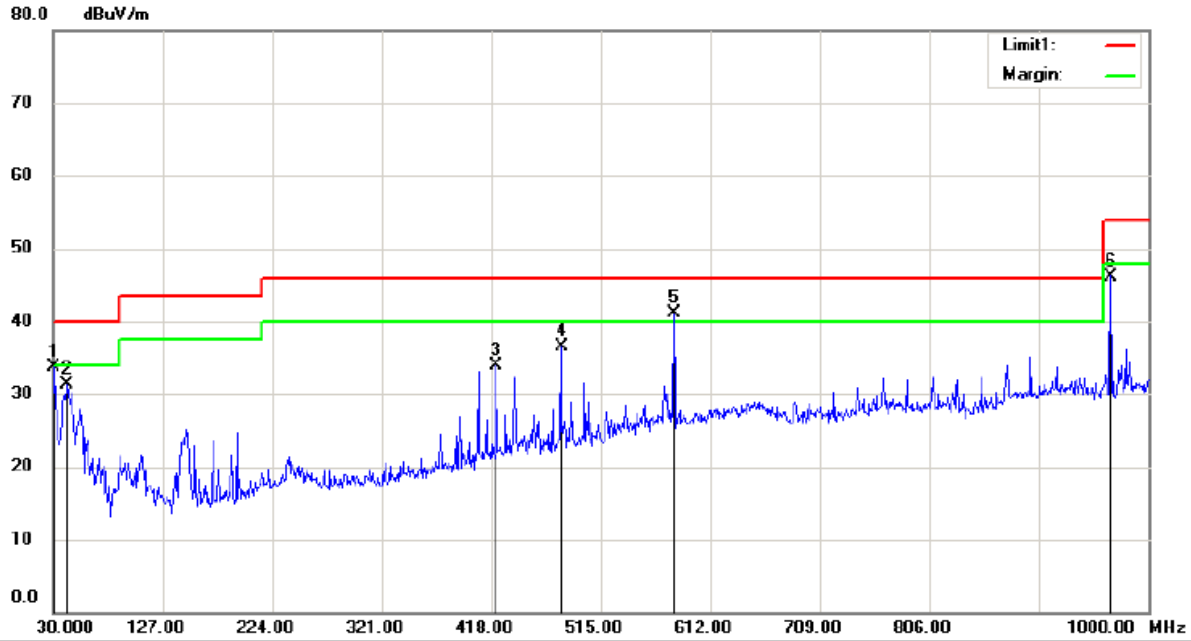

Site: 3m Chamber #1 Polarization: **Vertical** Temperature: 22 C

Limit: (RE)FCC PART 15 CLASS B
Mode: 802.11b Mid channel

Power: AC 120V/60Hz

Humidity: 50 %

Note:

No.	Mk.	Freq. MHz	Reading Level dBuV	Correct Factor dB	Measure- ment dBuV/m	Limit dBuV/m	Over dB	Antenna Height cm	Table Degree degree	Detector	Comment
1		30.9700	46.43	-12.76	33.67	40.00	-6.33			QP	
2		42.6100	42.79	-11.57	31.22	40.00	-8.78			QP	
3		422.8500	41.79	-7.81	33.98	46.00	-12.02			QP	
4		480.0800	43.25	-6.76	36.49	46.00	-9.51			QP	
5	*	579.9900	44.98	-3.89	41.09	46.00	-4.91			QP	
6		967.0200	44.91	1.29	46.20	54.00	-7.80			QP	

*:Maximum data x:Over limit !:over margin

Operator: KK

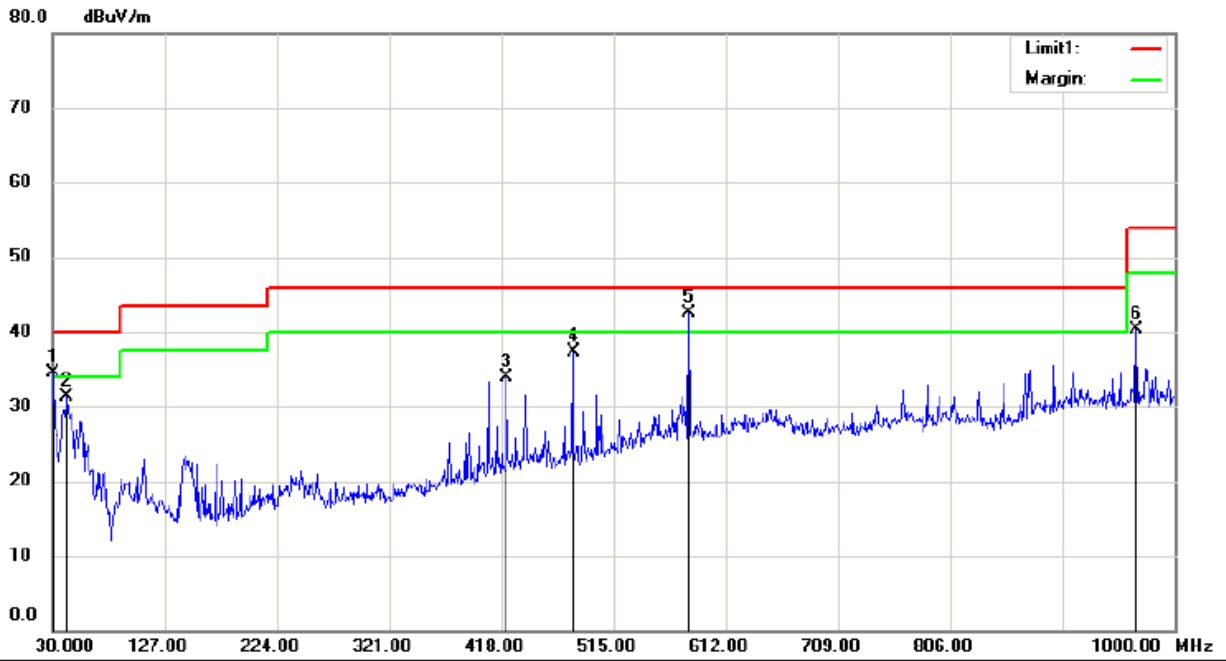

Site 3m Chamber #1

Polarization: **Vertical**

Temperature: 22 C

Limit: (RE)FCC PART 15 CLASS B

Power: AC 120V/60Hz

Humidity: 50 %

Mode: 802.11b High channel

Note:

No.	Mk.	Freq. MHz	Reading Level dBuV	Correct Factor dB	Measure- ment dBuV/m	Limit dBuV/m	Over dB	Detector	Antenna Height cm	Table Degree	Comment
1	!	30.9700	47.24	-12.76	34.48	40.00	-5.52	QP			
2		42.6100	42.79	-11.57	31.22	40.00	-8.78	QP			
3		422.8500	41.75	-7.81	33.94	46.00	-12.06	QP			
4		480.0800	44.02	-6.76	37.26	46.00	-8.74	QP			
5	*	579.9900	46.37	-3.89	42.48	46.00	-3.52	QP			
6		967.0200	39.08	1.29	40.37	54.00	-13.63	QP			

*:Maximum data x:Over limit !:over margin

Operator: KK

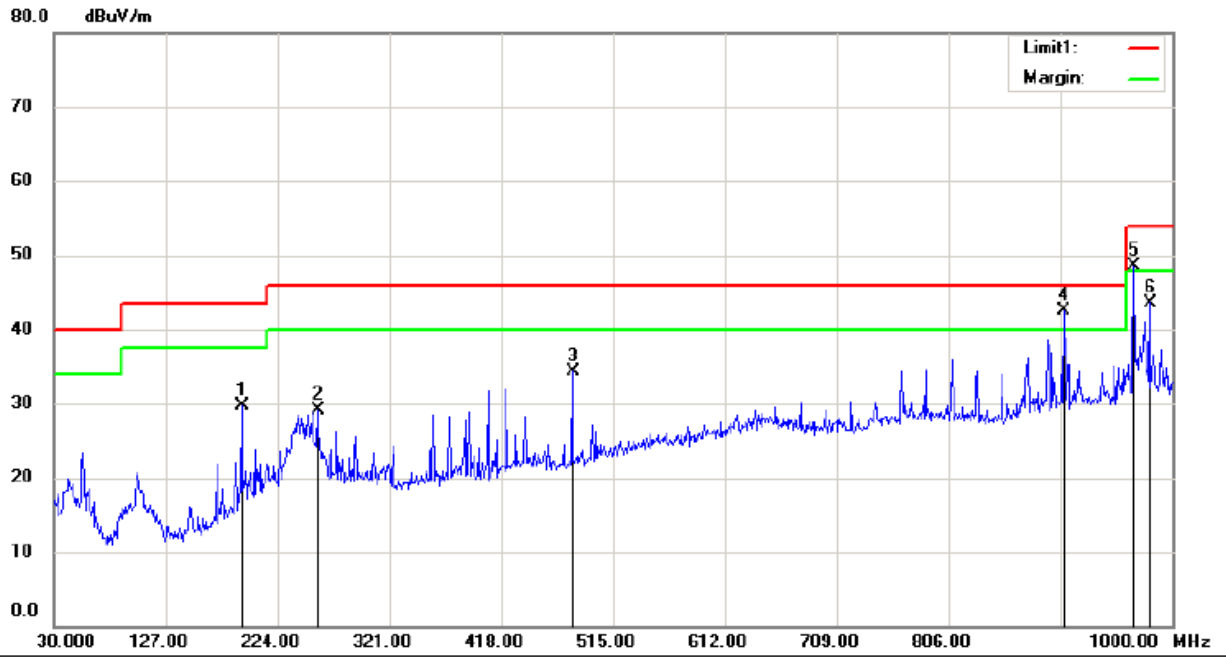

Site 3m Chamber #1 Polarization: **Horizontal** Temperature: 22 C
 Limit: (RE)FCC PART 15 CLASS B Power: AC 120V/60Hz Humidity: 50 %
 Mode:802.11b High channel
 Note:

No.	Mk.	Freq. MHz	Reading Level dBuV	Correct Factor dB	Measure- ment dBuV/m	Limit dBuV/m	Over dB	Detector	Antenna Height cm	Table Degree	Comment
1		192.9600	42.50	-12.73	29.77	43.50	-13.73	QP			
2		258.9200	39.53	-10.34	29.19	46.00	-16.81	QP			
3		480.0800	41.03	-6.76	34.27	46.00	-11.73	QP			
4	*	905.9100	41.05	1.50	42.55	46.00	-3.45	QP			
5	!	967.0200	47.24	1.29	48.53	54.00	-5.47	QP			
6		980.6000	42.16	1.44	43.60	54.00	-10.40	QP			

*:Maximum data x:Over limit !:over margin

Operator: KK

For adapter2

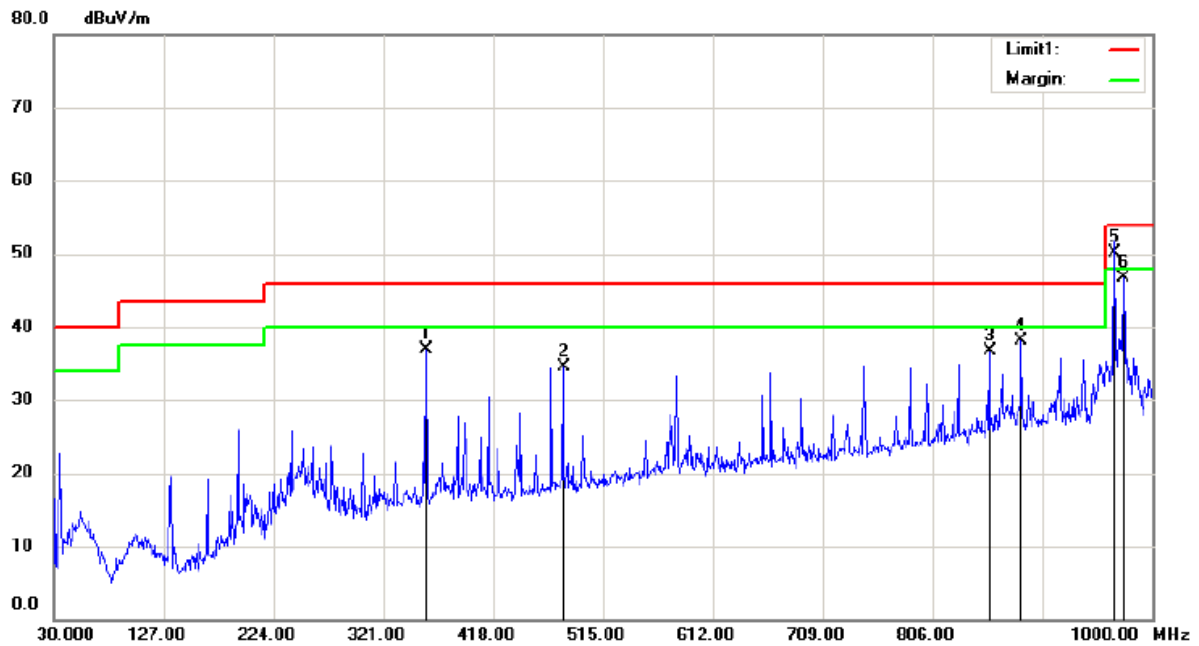

Site 3m Chamber #2 Polarization: *Horizontal* Temperature: 22 C
 Limit: (RE)FCC PART 15 CLASS B Power: AC 120V/60Hz Humidity: 55 %
 Mode:802.11b Low channel
 Note:

No.	Mk.	Freq.	Reading Level	Correct Factor	Measurement	Limit	Over	Antenna Height	Table Degree	
		MHz	dBuV	dB	dBuV/m	dBuV/m	dB	cm	degree	Comment
1		358.8300	46.12	-9.19	36.93	46.00	-9.07			QP
2		480.0800	41.69	-7.22	34.47	46.00	-11.53			QP
3		856.4400	37.20	-0.40	36.80	46.00	-9.20			QP
4		884.5700	38.10	-0.05	38.05	46.00	-7.95			QP
5	*	967.0200	49.32	0.88	50.20	54.00	-3.80			QP
6		974.7800	45.69	0.97	46.66	54.00	-7.34			QP

*:Maximum data x:Over limit !:over margin

Operator: CSL

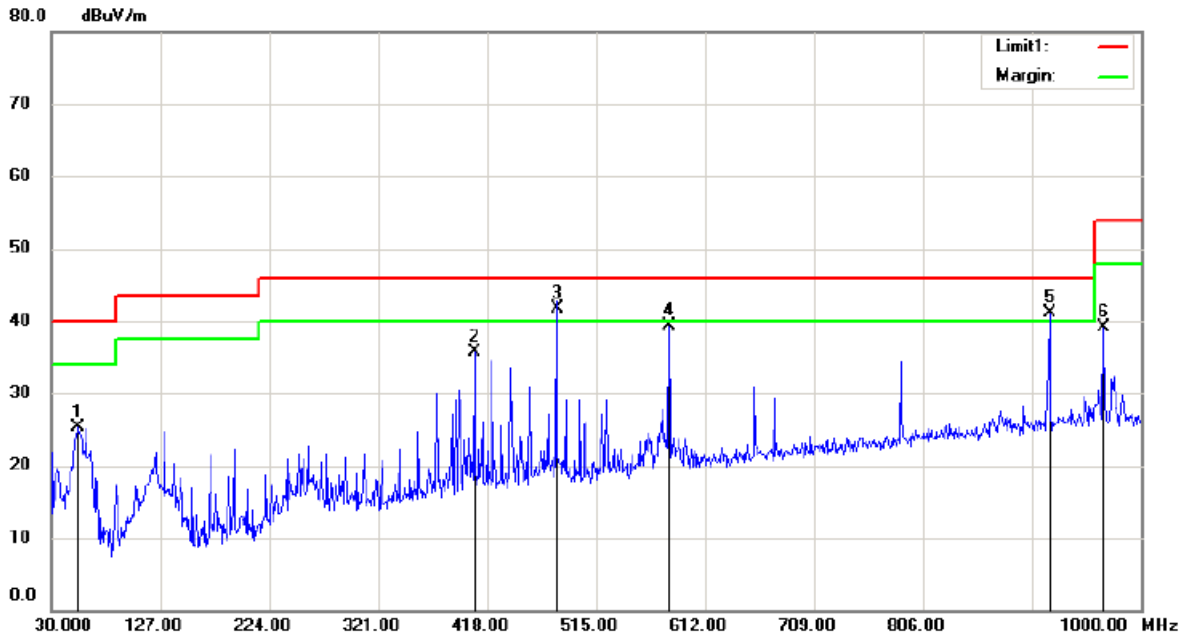

Site 3m Chamber #2 Polarization: *Vertical* Temperature: 22 C
 Limit: (RE)FCC PART 15 CLASS B Power: AC 120V/60Hz Humidity: 55 %
 Mode:802.11b Low channel
 Note:

No.	Mk.	Freq.	Reading Level	Correct Factor	Measurement	Limit	Over	Antenna Height	Table Degree	
		MHz	dBuV	dB	dBuV/m	dBuV/m	dB	cm	degree	Comment
1		54.2500	39.16	-13.78	25.38	40.00	-14.62	QP		
2		406.3600	44.00	-8.38	35.62	46.00	-10.38	QP		
3	*	480.0800	48.92	-7.22	41.70	46.00	-4.30	QP		
4		579.9900	44.14	-4.90	39.24	46.00	-6.76	QP		
5	!	918.5200	40.80	0.35	41.15	46.00	-4.85	QP		
6		967.0200	38.29	0.88	39.17	54.00	-14.83	QP		

*:Maximum data x:Over limit !:over margin

Operator: CSL

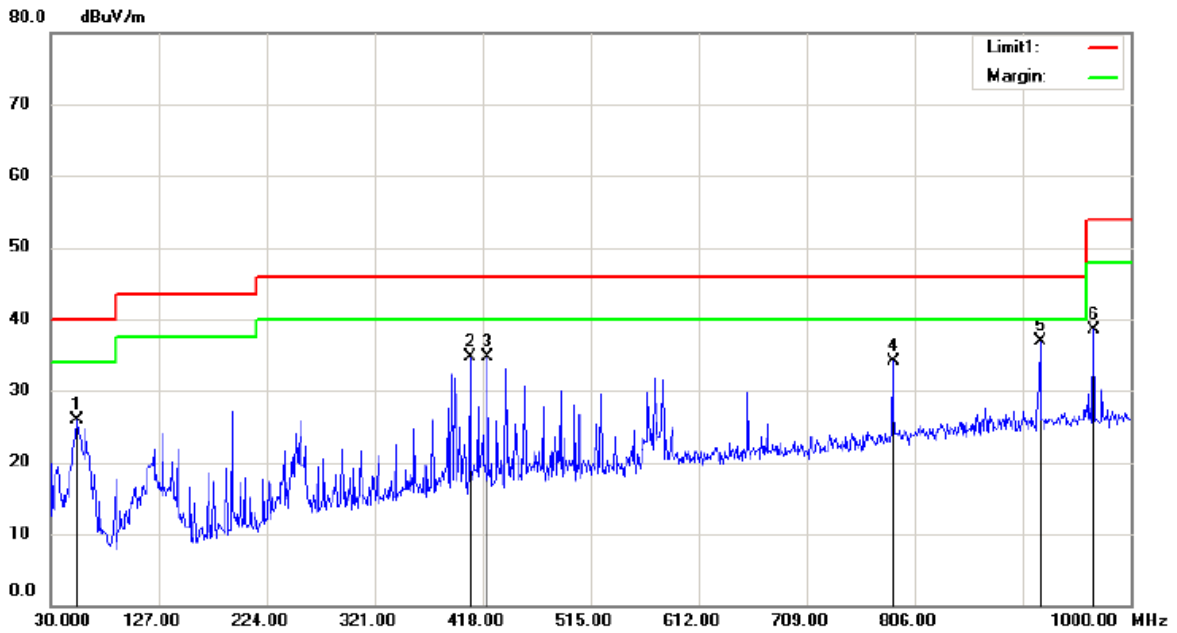

Site: 3m Chamber #2 Polarization: **Vertical** Temperature: 22 C
 Limit: (RE)FCC PART 15 CLASS B Power: AC 120V/60Hz Humidity: 55 %
 Mode: 802.11b Mid channel
 Note:

No.	Mk.	Freq. MHz	Reading Level dBuV	Correct Factor dB	Measure- ment dBuV/m	Limit dBuV/m	Over dB	Antenna Height cm	Table Degree degree	Comment
1		54.2500	39.65	-13.78	25.87	40.00	-14.13	QP		
2		406.3600	43.03	-8.38	34.65	46.00	-11.35	QP		
3		422.8500	42.93	-8.22	34.71	46.00	-11.29	QP		
4		786.6000	35.35	-1.32	34.03	46.00	-11.97	QP		
5	*	918.5200	36.53	0.35	36.88	46.00	-9.12	QP		
6		967.0200	37.65	0.88	38.53	54.00	-15.47	QP		

*:Maximum data x:Over limit !:over margin

Operator: CSL

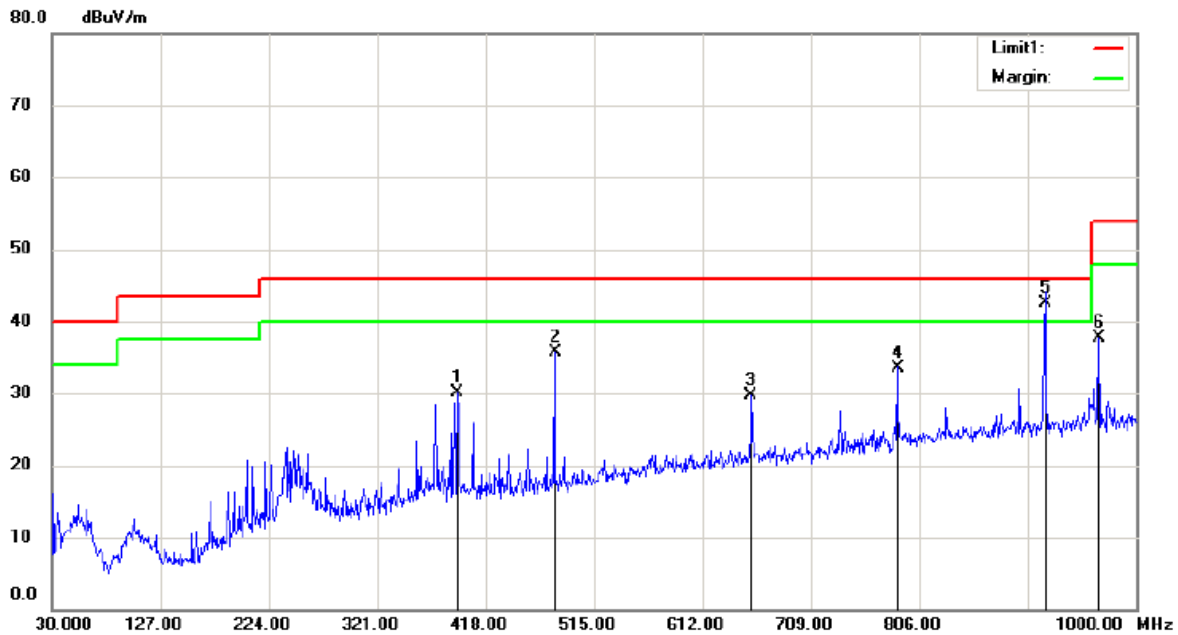

Site 3m Chamber #2

Polarization: **Horizontal**

Temperature: 22 C

Limit: (RE)FCC PART 15 CLASS B

Power: AC 120V/60Hz

Humidity: 55 %

Mode: T802.11b Mid channel

Note:

No.	Mk.	Freq. MHz	Reading Level dBuV	Correct Factor dB	Measure- ment dBuV/m	Limit dBuV/m	Over dB	Detector	Antenna Height cm	Table Degree degree	Comment
1		392.7800	38.66	-8.59	30.07	46.00	-15.93	QP			
2		480.0800	42.88	-7.22	35.66	46.00	-10.34	QP			
3		655.6500	33.32	-3.59	29.73	46.00	-16.27	QP			
4		786.6000	34.92	-1.32	33.60	46.00	-12.40	QP			
5	*	918.5200	42.15	0.35	42.50	46.00	-3.50	QP			
6		967.0200	36.78	0.88	37.66	54.00	-16.34	QP			

*:Maximum data x:Over limit !:over margin

Operator: CSL

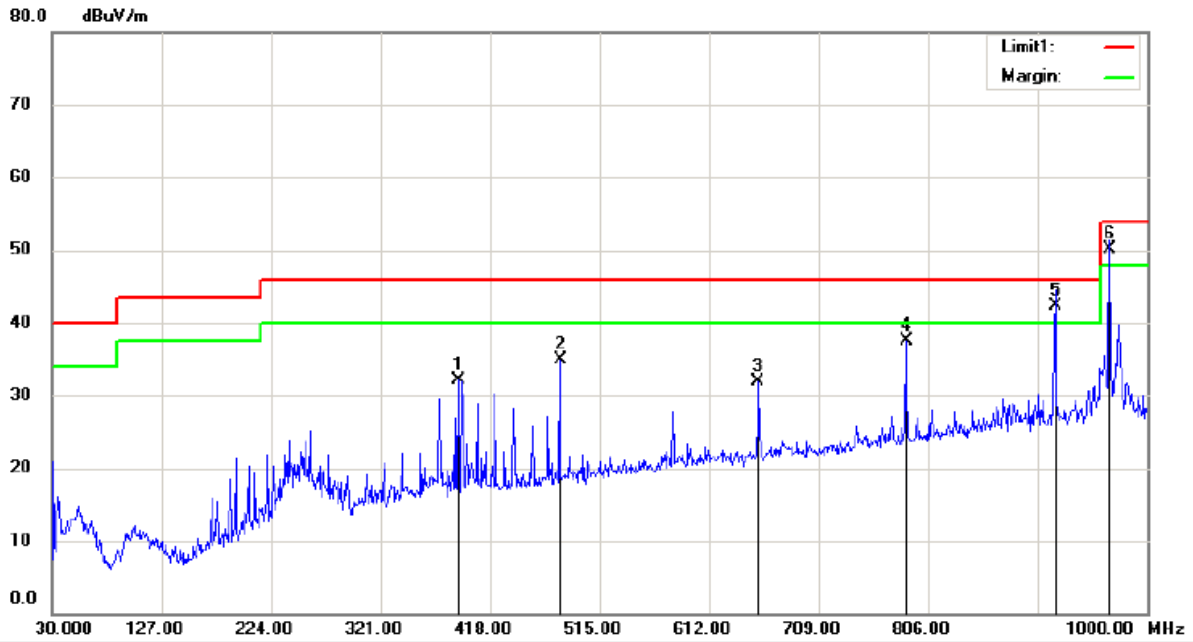

Site 3m Chamber #2 Polarization: **Horizontal** Temperature: 22 C
 Limit: (RE)FCC PART 15 CLASS B Power: AC 120V/60Hz Humidity: 55 %
 Mode:802.11b High channel
 Note:

No.	Mk.	Freq.	Reading Level	Correct Factor	Measurement	Limit	Over	Antenna Height	Table Degree	
		MHz	dBuV	dB	dBuV/m	dBuV/m	dB	cm	degree	Comment
1		389.8700	40.75	-8.63	32.12	46.00	-13.88			QP
2		480.0800	42.22	-7.22	35.00	46.00	-11.00			QP
3		655.6500	35.58	-3.59	31.99	46.00	-14.01			QP
4		786.6000	38.87	-1.32	37.55	46.00	-8.45			QP
5	*	918.5200	42.05	0.35	42.40	46.00	-3.60			QP
6	!	967.0200	49.32	0.88	50.20	54.00	-3.80			QP

*:Maximum data x:Over limit !:over margin

Operator: CSL

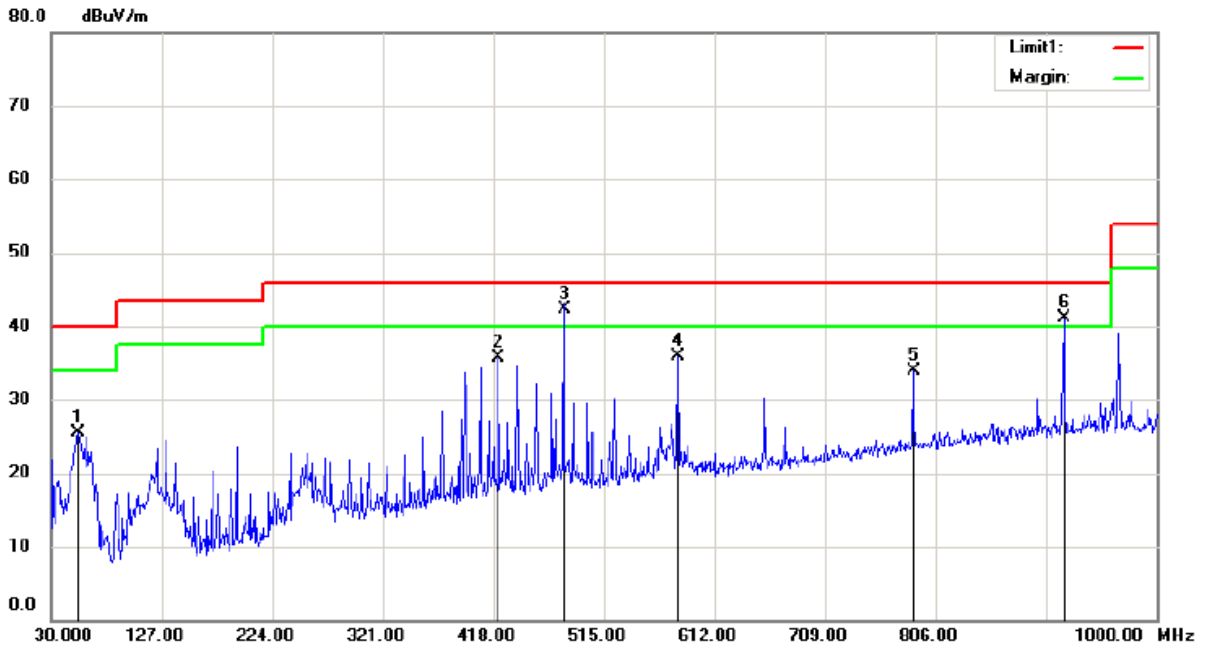

Site 3m Chamber #2 Polarization: **Vertical** Temperature: 22 C
 Limit: (RE)FCC PART 15 CLASS B Power: AC 120V/60Hz Humidity: 55 %
 Mode:802.11b High channel
 Note:

No.	Mk.	Freq.	Reading Level	Correct Factor	Measurement	Limit	Over	Antenna Height	Table Degree	
		MHz	dBuV	dB	dBuV/m	dBuV/m	dB	cm	degree	Comment
1		53.2800	39.08	-13.57	25.51	40.00	-14.49	QP		
2		422.8500	43.83	-8.22	35.61	46.00	-10.39	QP		
3	*	480.0800	49.52	-7.22	42.30	46.00	-3.70	QP		
4		579.9900	40.77	-4.90	35.87	46.00	-10.13	QP		
5		786.6000	35.24	-1.32	33.92	46.00	-12.08	QP		
6	!	918.5200	40.81	0.35	41.16	46.00	-4.84	QP		

*:Maximum data x:Over limit !:over margin

Operator: CSL

8.6 CONDUCTED EMISSIONS TEST

8.6.1 Applicable Standard

According to FCC Part 15.207(a)

8.6.2 Conformance Limit

Conducted Emission Limit		
Frequency(MHz)	Quasi-peak	Average
0.15-0.5	66-56	56-46
0.5-5.0	56	46
5.0-30.0	60	50

Note: 1. The lower limit shall apply at the transition frequencies
 2. The limit decreases in line with the logarithm of the frequency in the range of 0.15 to 0.50MHz.

8.6.3 Test Configuration

Test according to clause 7.3 conducted emission test setup

8.6.4 Test Procedure

The EUT was placed on a table which is 0.8m above ground plane.
 Maximum procedure was performed on the highest emissions to ensure EUT compliance.
 Repeat above procedures until all frequency measured were complete.

8.6.5 Test Results

Pass

We test the EUT at 120V and 240V all modes 2.4G 802.11b/g/n with adapter1 and adapter2, and show the worst result as bellow.

For adapter1

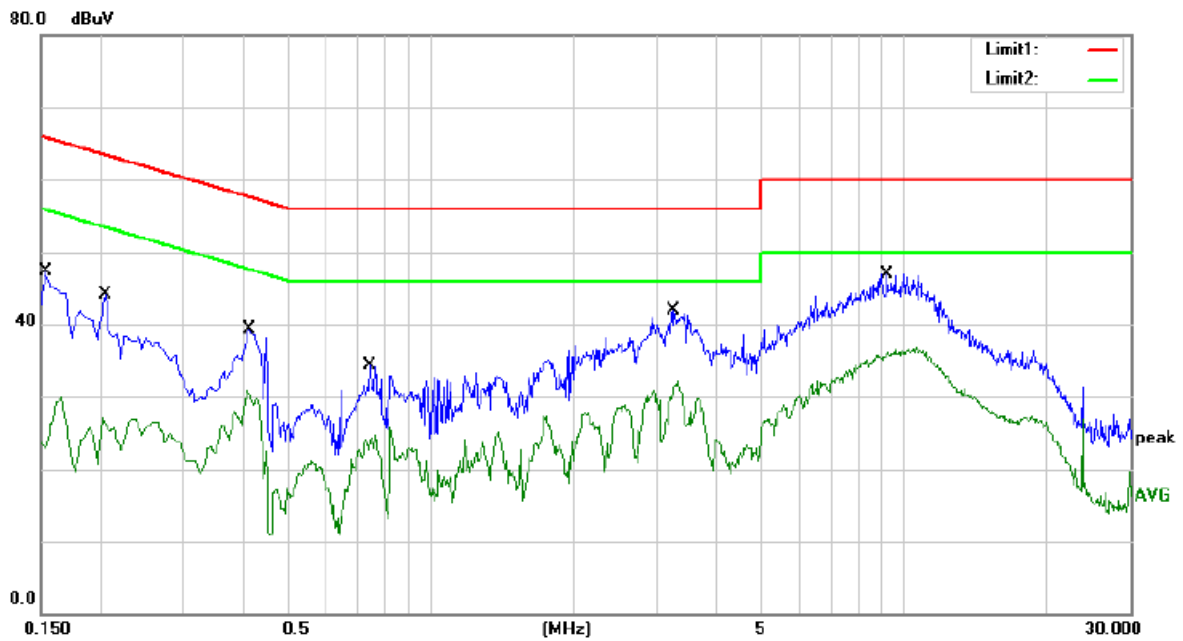

Site Conduction #2

Phase: **N**

Temperature: 21

Limit: (CE)FCC PART 15 class B_QP

Power: AC 120V/60Hz

Humidity: 53 %

Mode: 802.11b Low Channel

Note:

No.	Mk.	Freq. MHz	Reading Level dBuV	Correct Factor dB	Measure- ment dBuV	Limit dBuV	Over dB	Detector	Comment
1		0.1540	37.70	9.62	47.32	65.78	-18.46	QP	
2		0.1540	20.22	9.62	29.84	55.78	-25.94	AVG	
3		0.2060	34.41	9.63	44.04	63.37	-19.33	QP	
4		0.2060	17.43	9.63	27.06	53.37	-26.31	AVG	
5		0.4140	29.70	9.69	39.39	57.57	-18.18	QP	
6		0.4140	21.21	9.69	30.90	47.57	-16.67	AVG	
7		0.7460	24.50	9.78	34.28	56.00	-21.72	QP	
8		0.7460	15.96	9.78	25.74	46.00	-20.26	AVG	
9		3.2660	31.99	9.86	41.85	56.00	-14.15	QP	
10		3.2660	22.15	9.86	32.01	46.00	-13.99	AVG	
11	*	9.2100	36.51	10.48	46.99	60.00	-13.01	QP	
12		9.2100	26.40	10.48	36.88	50.00	-13.12	AVG	

*:Maximum data x:Over limit !:over margin Comment: Factor build in receiver. Operator: ZHL

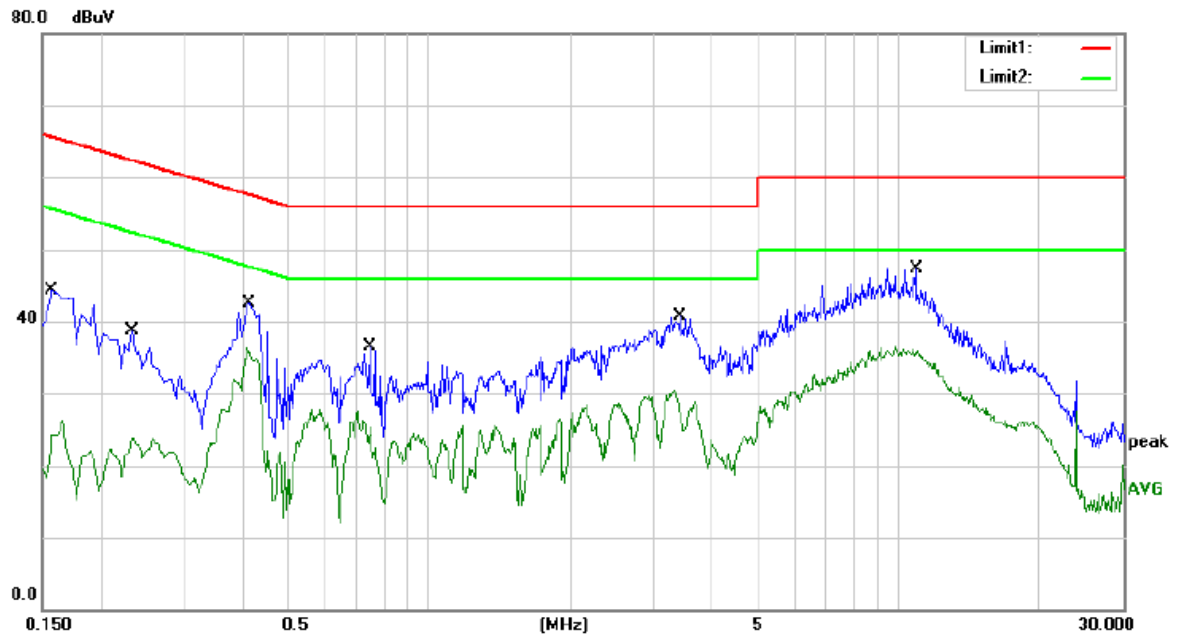

Site Conduction #2

Phase: **L1**

Temperature: 21

Limit: (CE)FCC PART 15 class B_QP

Power: AC 120V/60Hz

Humidity: 53 %

Mode: 802.11b Low Channel

Note:

No.	Mk.	Freq. MHz	Reading Level dBuV	Correct Factor dB	Measure- ment dBuV	Limit dBuV	Over dB	Detector	Comment
1		0.1580	34.72	9.62	44.34	65.57	-21.23	QP	
2		0.1580	16.72	9.62	26.34	55.57	-29.23	AVG	
3		0.2340	29.05	9.64	38.69	62.31	-23.62	QP	
4		0.2340	14.35	9.64	23.99	52.31	-28.32	AVG	
5		0.4140	32.88	9.69	42.57	57.57	-15.00	QP	
6	*	0.4140	26.65	9.69	36.34	47.57	-11.23	AVG	
7		0.7500	26.66	9.78	36.44	56.00	-19.56	QP	
8		0.7500	17.79	9.78	27.57	46.00	-18.43	AVG	
9		3.4260	30.78	9.86	40.64	56.00	-15.36	QP	
10		3.4260	20.63	9.86	30.49	46.00	-15.51	AVG	
11		10.8580	36.60	10.68	47.28	60.00	-12.72	QP	
12		10.8580	25.90	10.68	36.58	50.00	-13.42	AVG	

*:Maximum data x:Over limit !:over margin Comment: Factor build in receiver. Operator: ZHL

For adapter2

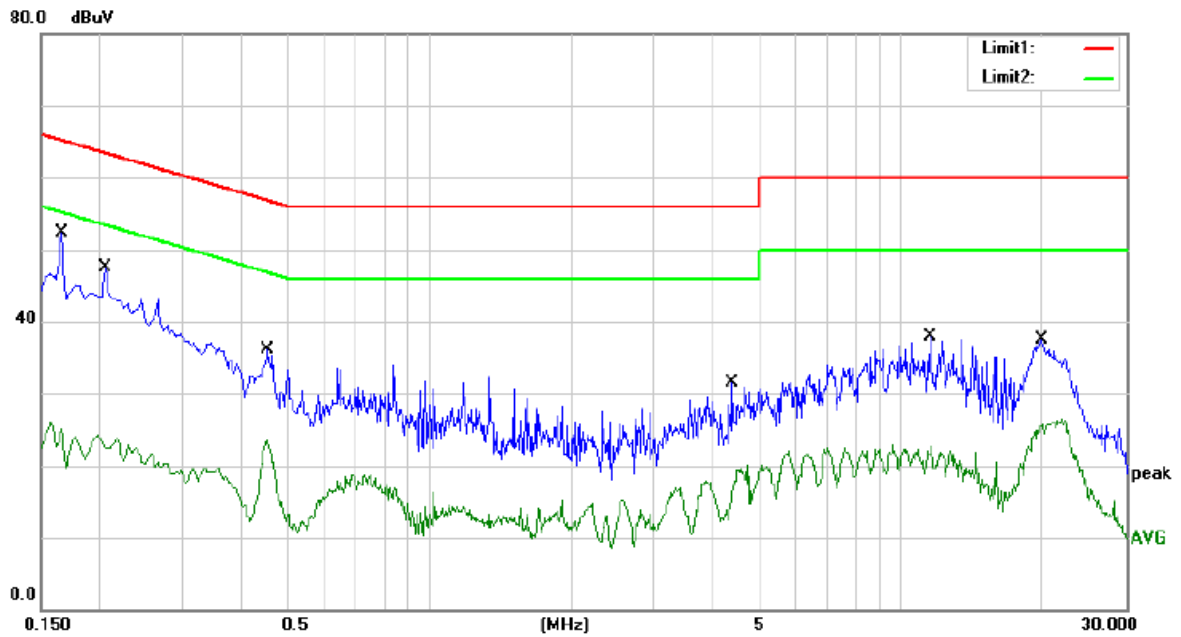

Site Conduction #2 Phase: **N** Temperature: 21
 Limit: (CE)EN55022 class B_QP Power: AC 230V/50Hz Humidity: 53 %
 Mode: 802.11b Low Channel
 Note:

No.	Mk.	Freq. MHz	Reading Level dBuV	Correct Factor dB	Measure- ment dBuV	Limit dBuV	Over dB	Detector	Comment
1	*	0.1660	42.68	9.62	52.30	65.16	-12.86	QP	
2		0.1660	16.48	9.62	26.10	55.16	-29.06	AVG	
3		0.2060	37.80	9.63	47.43	63.37	-15.94	QP	
4		0.2060	14.69	9.63	24.32	53.37	-29.05	AVG	
5		0.4540	26.42	9.70	36.12	56.80	-20.68	QP	
6		0.4540	13.84	9.70	23.54	46.80	-23.26	AVG	
7		4.4060	21.65	9.87	31.52	56.00	-24.48	QP	
8		4.4060	10.21	9.87	20.08	46.00	-25.92	AVG	
9		11.5460	27.21	10.67	37.88	60.00	-22.12	QP	
10		11.5460	12.02	10.67	22.69	50.00	-27.31	AVG	
11		19.8900	27.16	10.40	37.56	60.00	-22.44	QP	
12		19.8900	15.74	10.40	26.14	50.00	-23.86	AVG	

*:Maximum data x:Over limit !:over margin Comment: Factor build in receiver. Operator: ZHL

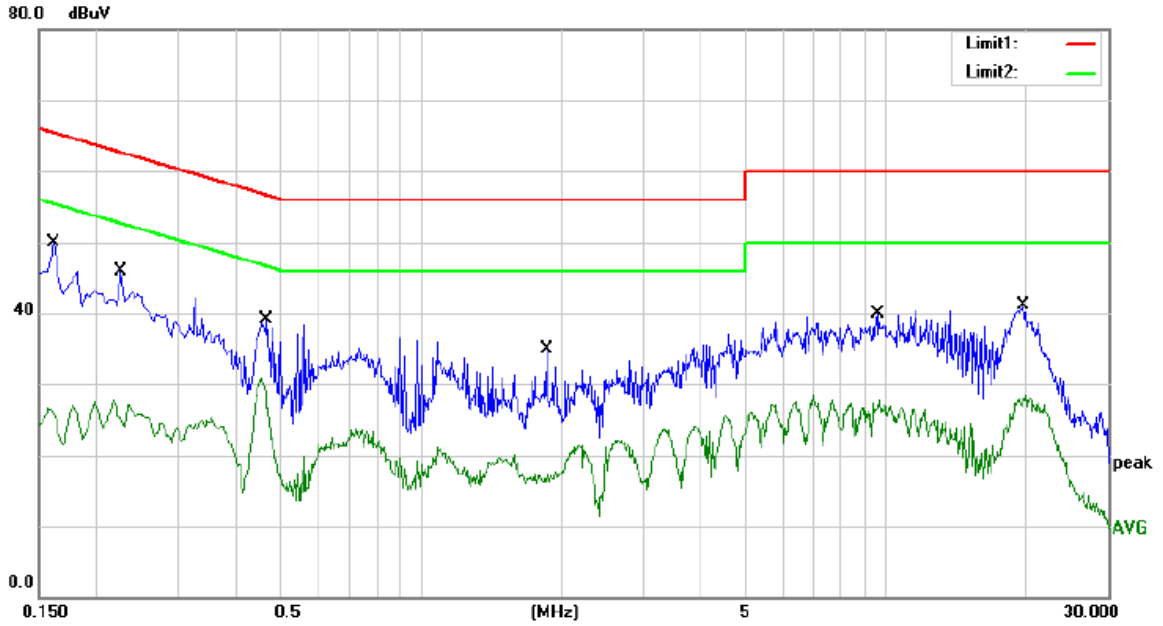

Site Conduction #2

Phase: **L1**

Temperature: 21

Limit: (CE)EN55022 class B_QP

Power: AC 230V/50Hz

Humidity: 53 %

Mode: 802.11b Low Channel

Note:

No.	Mk.	Freq. MHz	Reading Level dBuV	Correct Factor dB	Measure- ment dBuV	Limit dBuV	Over dB	Detector	Comment
1	*	0.1620	40.30	9.62	49.92	65.36	-15.44	QP	
2		0.1620	17.56	9.62	27.18	55.36	-28.18	AVG	
3		0.2260	36.23	9.64	45.87	62.60	-16.73	QP	
4		0.2260	17.96	9.64	27.60	52.60	-25.00	AVG	
5		0.4660	29.38	9.70	39.08	56.58	-17.50	QP	
6		0.4660	21.12	9.70	30.82	46.58	-15.76	AVG	
7		1.8620	24.98	9.85	34.83	56.00	-21.17	QP	
8		1.8620	11.54	9.85	21.39	46.00	-24.61	AVG	
9		9.6300	29.21	10.60	39.81	60.00	-20.19	QP	
10		9.6300	17.01	10.60	27.61	50.00	-22.39	AVG	
11		19.7620	30.72	10.41	41.13	60.00	-18.87	QP	
12		19.7620	18.09	10.41	28.50	50.00	-21.50	AVG	

*:Maximum data x:Over limit !:over margin Comment: Factor build in receiver. Operator: ZHL

8.7 ANTENNA APPLICATION

8.7.1 Antenna Requirement

Standard	Requirement
FCC CRF Part 15.203	An intentional radiator shall be designed to ensure that no antenna other than that furnished by the responsible party shall be used with the device. The use of a permanently attached antenna or of an antenna that uses a unique coupling to the intentional radiator shall be considered sufficient to comply with the provisions of this section. The manufacturer may design the unit so that a broken antenna can be replaced by the user, but the use of a standard antenna jack or electrical connector is prohibited. This requirement does not apply to carrier current devices or to devices operated under the provisions of §15.211, §15.213, §15.217, §15.219, or §15.221. Further, this requirement does not apply to intentional radiators that must be professionally installed, such as perimeter protection systems and some field disturbance sensors, or to other intentional radiators which, in accordance with §15.31(d), must be measured at the installation site. However, the installer shall be responsible for ensuring that the proper antenna is employed so that the limits in this part are not exceeded.

For intentional device, according to FCC 47 CFR Section 15.203, an intentional radiator shall be designed to ensure that no antenna other than that furnished by the responsible party shall be used with the device. And according to FCC 47 CFR Section 15.247 (b), if transmitting antennas of directional gain greater than 6dBi are used, the power shall be reduced by the amount in dB that the directional gain of the antenna exceeds 6dBi.

8.7.2 Result

PASS.

For Antenna Style 1

Two PiFa Antenna for wifi 2.4G, the gain is 2.5 dBi;

- Antenna use a permanently attached antenna which is not replaceable.
- Not using a standard antenna jack or electrical connector for antenna replacement
- The antenna has to be professionally installed (please provide method of installation)

which in accordance to section 15.203, please refer to the internal photos

For Antenna Style 2

Two External Antennas for wifi 2.4G, the gain is 4.4 dBi;

- Note:
- Antenna use an external permanently attached antenna which is not replaceable.
 - Not using a standard antenna jack or electrical connector for antenna replacement
 - The antenna has to be professionally installed (please provide method of installation)

which in accordance to section 15.203, please refer to the internal photos.