



FCC RADIO TEST REPORT

FCC ID : Z8H89FT0016
Equipment : ePMP 5GHz Force 300-16 SM Radio,cnVision Client MINI 16 dBi
Brand Name : Cambium Networks
Model Name : ePMP 5GHz Force 300-16 SM Radio,cnVision Client MINI 16 dBi
Model Number : C050910P011A
Applicant : Cambium Networks Inc.
3800 Golf Road, Suite 360 Rolling Meadows, IL 60008, USA
Manufacturer : Cambium Networks, Ltd.
Ashburton, TQ13 7UP, UK
Standard : 47 CFR FCC Part 90 Subpart Y

The product was received on Dec. 25, 2019, and testing was started from Dec. 26, 2019 and completed on Jan. 06, 2020. We, SPORTON INTERNATIONAL INC. EMC & Wireless Communications Laboratory, would like to declare that the tested sample has been evaluated in accordance with the procedures given in ANSI/TIA-603-D-2010, 47 CFR FCC Part 90 Subpart Y, ANSI C63.26-2015 and shown compliance with the applicable technical standards.

The report must not be used by the client to claim product certification, approval, or endorsement by TAF or any agency of government.

The test results in this variant report apply exclusively to the tested model / sample. Without written approval of SPORTON INTERNATIONAL INC. EMC & Wireless Communications Laboratory, the test report shall not be reproduced except in full.

Approved by: Sam Chen

SPORTON INTERNATIONAL INC. EMC & Wireless Communications Laboratory
No. 52, Huaya 1st Rd., Guishan Dist., Taoyuan City, Taiwan (R.O.C.)



TABLE OF CONTENTS

History of this test report.....4

Summary of Test Result.....5

1 General Description6

1.1 Product Information6

1.2 Applicable Standards9

1.3 Testing Information.....9

1.4 Measurement Uncertainty9

2 Test Configuration10

2.1 Test Channel Mode10

2.2 Worst Case Modulation Configuration10

2.3 EUT Operation during Test11

2.4 Accessories11

2.5 Support Equipment.....11

2.6 Test Setup Diagram12

3 Test Result13

3.1 Maximum Conducted Output Power and Peak Power Spectral Density Measurement13

3.2 Peak Excursion Measurement16

3.3 Occupied Bandwidth and Emission Mask Measurement.....17

3.4 Transmitter Conducted Unwanted Emissions Measurement.....19

3.5 Transmitter Radiated Unwanted Emissions Measurement.....20

3.6 Frequency Stability Measurement.....22

4 Test Equipment and Calibration Data23

Appendix A. Maximum Conducted Output Power / Peak Power Spectral Density

Appendix B. Peak Excursion

Appendix C. Occupied Bandwidth / Emission Mask

Appendix D. Transmitter Conducted Unwanted Emissions

Appendix E. Transmitter Radiated Unwanted Emissions

Appendix F. Frequency Stability



Appendix G. Test Photos

Photographs of EUT v01



Summary of Test Result

Report Clause	Ref Std. Clause	Test Items	Result (PASS/FAIL)	Remark
3.1	2.1046/90.1215(a)	Maximum Conducted Output Power / Peak Power Spectral Density	PASS	-
3.2	90.1215	Peak Excursion	PASS	-
3.3	2.1049/90.210(m)	Occupied Bandwidth / Emission Mask	PASS	-
3.4	2.1051/90.210(m)	Transmitter Conducted Unwanted Emissions	PASS	-
3.5	2.1053/90.210(m)	Transmitter Radiated Unwanted Emissions	PASS	-
3.6	2.1055/90.213(a)	Frequency Stability	PASS	-

Declaration of Conformity:

The test results with all measurement uncertainty excluded are presented in accordance with the regulation limits or requirements declared by manufacturers.

Comments and Explanations:

The declared of product specification for EUT presented in the report are provided by the manufacturer, and the manufacturer takes all the responsibilities for the accuracy of product specification.

Reviewed by: **Sam Chen**

Report Producer: **Vicky Huang**



1 General Description

1.1 Product Information

1.1.1 Specification Information

RF General Information			
Frequency Range (MHz)	Modulaton	Ch. Frequency (MHz)	Channel Bandwidth (MHz)
4940-4990	QPSK	4950-4980	20

Band	Mode	Modulation	BWch (MHz)	Nant
4.9G	11j	QPSK	20	2

Channel Bandwidth	Carrier Frequency (MHz)
20 MHz	4950
	4980



1.1.2 Antenna Information

Ant.	Port	Brand	Model Name	Antenna Type	Connector	Gain (dBi)	
						2.4GHz	5GHz
1	1	Cambium	ePMP force 300-16	Printed Antenna	I-PEX	6	-
2	1	Cambium	ePMP force 300-16	Printed Antenna	custom	-	16
	2	Cambium	ePMP force 300-16	Printed Antenna	custom	-	16
3	1	Cambium	ePMP force 300-16	integral antenna	custom	-	2
	2	Cambium	ePMP force 300-16	integral antenna	custom	-	2

Note: The above information was declared by manufacturer.

Note: The EUT has three antennas.

For 2.4GHz function (1TX/1RX):

Only Port 1 can be used as transmitting/receiving antenna.

For 5GHz function (2TX/2RX):

5GHz can equip Ant.2 or Ant.3. Both Ant.2 and Ant.3 has been tested and recorded in the test report.

Port 1 and Port 2 can be used as transmitting/receiving antenna.

Port 1 and Port 2 could transmit/receive simultaneously.

For 4.9GHz function (2TX/2RX):

4.9GHz can equip Ant.2 or Ant.3. Only the higher gain antenna "Ant. 2" was tested and recorded in the report.

Port 1 and Port 2 can be used as transmitting/receiving antenna.

Port 1 and Port 2 could transmit/receive simultaneously.

1.1.3 Mode Test Duty Cycle

Mode	DC	DCF (dB)
4.94-4.99GHz_802.11j_20MHz_Nss1_2TX	0.984	0.07

Note:

- ♦ DC is Duty Cycle.
- ♦ DCF is Duty Cycle Factor.



1.1.4 EUT Operational Condition

EUT Power Type	From PoE		
Test Software Version	QSPR v5.0-00086		
Device Type	<input type="checkbox"/> Low power device	<input checked="" type="checkbox"/> High power device	

Note: The above information was declared by manufacturer.

1.1.5 Table for Multiple Listing

The difference for each equipment names/model names is shown as below:

Equipment Name	Model Name	Model Number	Description
ePMP 5GHz Force 300-16 SM Radio	ePMP 5GHz Force 300-16 SM Radio	C050910P011A	The difference served as marketing strategy.
cnVision Client MINI 16 dBi	cnVision Client MINI 16 dBi	C050910P011A	

Note 1: The above information was declared by manufacturer.

Note 2: From the above models, model: ePMP 5GHz Force 300-16 SM Radio was selected as representative model for the test and its data was recorded in this report.

1.1.6 Table for Class III Change

This product is an extension of original one reported under Sporton project number: 7O2407-06

Below is the table for the change of the product with respect to the original one.

Modifications	Performance Checking
1. Adding 4.9G function for Ant. 2 and Ant. 3 "model name: ePMP force 300-16, gain:16dBi and model name: ePMP force 300-16, gain: 2dBi ", and supports 20 MHz bandwidth only.	All test items.
2. Change the equipment name/model name to "ePMP 5GHz Force 300-16 SM Radio" from "5GHz Force 300-16". 3. Add a new equipment name/model name "cnVision Client MINI 16 dBi". 4. Adding model number "C050910P011A". 5. Changing the Manufacturer and Manufacturer address to "Manufacturer: Cambium Networks, Ltd. / Manufacturer address: Ashburton, TQ13 7UP, UK" from "Manufacturer: Cambium Networks Inc. / Manufacturer address: 3800 Golf Road, Suite 360 Rolling Meadows, IL 60008, USA".	It does not need to test.



1.2 Applicable Standards

According to the specifications of the manufacturer, the EUT must comply with the requirements of the following standards:

- ♦ 47 CFR FCC Part 90 Subpart Y
- ♦ ANSI/TIA-603-D-2010
- ♦ FCC KDB 552295 D01v03
- ♦ FCC KDB 662911 D01 v02r01
- ♦ FCC KDB 412172 D01 v01r01
- ♦ FCC KDB 971168 D01 v03r01

1.3 Testing Information

Testing Location		
<input type="checkbox"/>	HWA YA	ADD : No. 52, Huaya 1st Rd., Guishan Dist., Taoyuan City, Taiwan (R.O.C.) TEL : 886-3-327-3456 FAX : 886-3-327-0973
<input checked="" type="checkbox"/>	JHUBEI	ADD : No.8, Lane 724, Bo-ai St., Jhubei City, HsinChu County 302, Taiwan, R.O.C. TEL : 886-3-656-9065 FAX : 886-3-656-9085

Test Condition	Test Site No.	Test Engineer	Test Environment	Test Date
RF Conducted	TH02-CB	Ekko Hsieh	24~25°C / 61~64%	Dec. 26, 2019~Jan. 06, 2020
Radiated	03CH01-CB	Gino Huang	24~25.6°C / 60~65%	Dec. 30, 2019~ Dec. 31, 2019

Test site Designation No. TW0006 with FCC

Test site registered number IC 4086D with Industry Canada.

1.4 Measurement Uncertainty

Test Items	Uncertainty	Remark
Radiated Emission (30MHz ~ 1,000MHz)	4.3 dB	Confidence levels of 95%
Radiated Emission (1GHz ~ 18GHz)	4.3 dB	Confidence levels of 95%
Radiated Emission (18GHz ~ 40GHz)	5.1 dB	Confidence levels of 95%
Conducted Emission	2.4 dB	Confidence levels of 95%



2 Test Configuration

2.1 Test Channel Mode

Mode	Power Setting
4.94-4.99GHz_802.11j_20MHz_Nss1_2TX	-
4950MHz	18
4980MHz	18

2.2 Worst Case Modulation Configuration

The Worst Case Mode for Following Conformance Tests	
Tests Item	Maximum Conducted Output Power / Peak Power Spectral Density Peak Excursion Occupied Bandwidth / Emission Mask Transmitter Conducted Unwanted Emissions Frequency Tolerance
Test Condition	Conducted measurement at transmit chains

The Worst Case Mode for Following Conformance Tests	
Tests Item	Transmitter Radiated Unwanted Emissions
Test Condition	Radiated measurement If EUT consist of multiple antenna assembly (multiple antenna are used in EUT regardless of spatial multiplexing MIMO configuration), the radiated test should be performed with highest antenna gain of each antenna type.
Operating Mode < 1GHz	CTX (Cabinet)
Operating Mode > 1GHz	CTX (Cabinet)

Note1: The EUT can only be used in Y axis positon.

Note2: For Transmitter Radiated Unwanted Emissions test, only the highest power carrier frequency "20MHz / 4980MHz" was tested and recorded in the report.

Note3: The EUT was powered by PoE, and the PoE was for measurement only, would not be marketed.

Equipment	Brand Name	Model Name	FCC ID
PoE	PHIHONG	PSA15M-300(AP)	N/A



2.3 EUT Operation during Test

During the test, "QSPR v5.0-00086" under WIN 7 was executed the test program to control the EUT continuously transmit RF signal.

2.4 Accessories

N/A

2.5 Support Equipment

Support Equipment				
No.	Equipment	Brand Name	Model Name	FCC ID
A	NB	DELL	E4300	N/A
B	PoE	PHIHONG	PSA15M-300(AP)	N/A



2.6 Test Setup Diagram

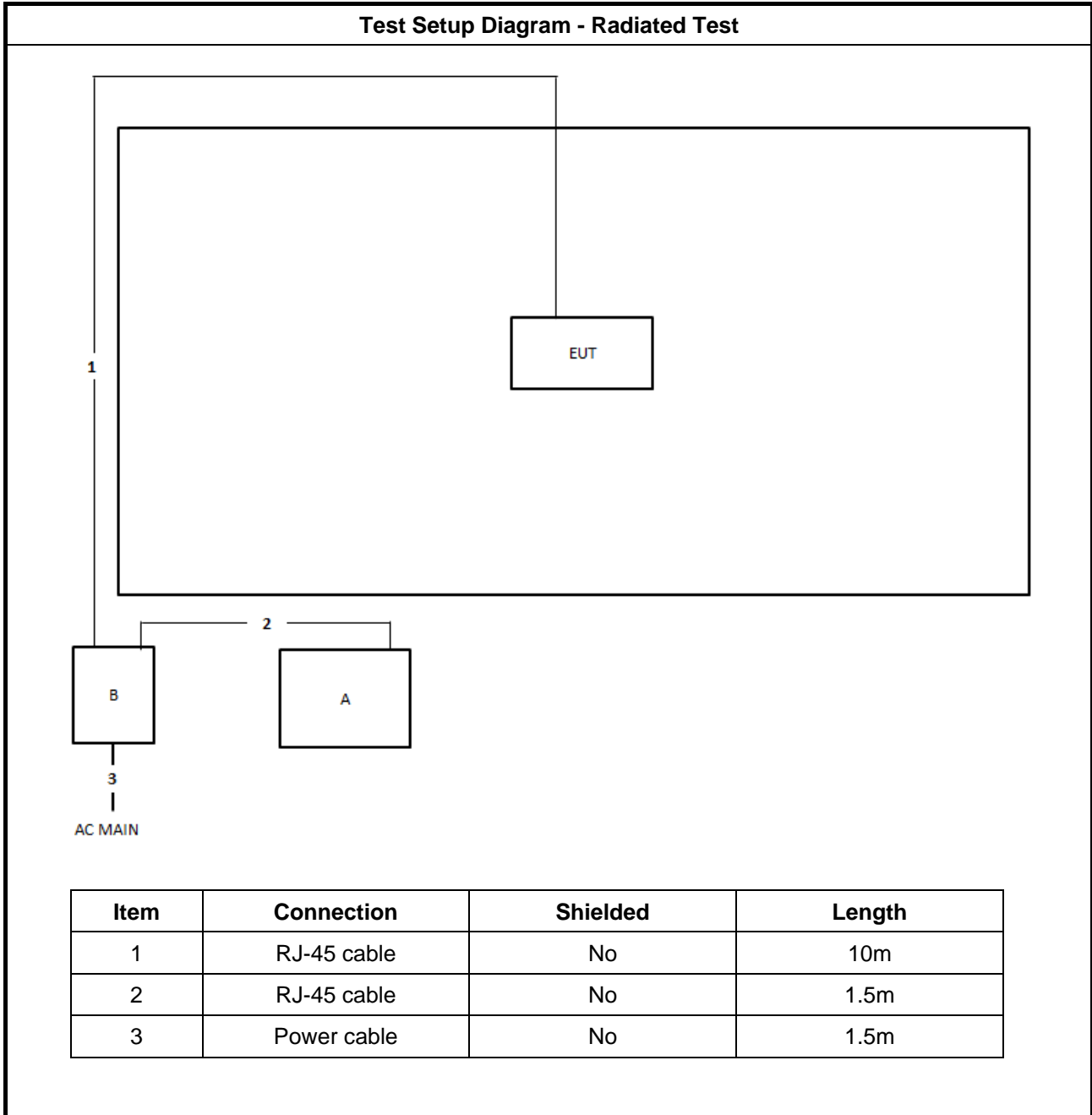



3 Test Result

3.1 Maximum Conducted Output Power and Peak Power Spectral Density Measurement

3.1.1 Limit of Maximum Conducted Output Power and Peak Power Spectral Density

Maximum Conducted Output Power Limit:

The transmitting power of stations operating in the 4940-4990 MHz band must not exceed the maximum limits in this table.

Channel Bandwidth (MHz)	Low Power Device Peak Transmitter Power (dBm)	High Power Device Peak Transmitter Power (dBm)
1	7.0	20.0
5	14.0	27.0
10	17.0	30.0
15	18.8	31.8
20	20.0	33.0

Peak Power Spectral Density Limit:

1. High power devices are also limited to a peak power spectral density of 21 dBm per one MHz. High power devices using channel bandwidths other than those listed above are permitted; however, they are limited to peak power spectral density of 21 dBm/MHz. If transmitting antennas of directional gain greater than 9 dBi are used, both the maximum conducted output power and the peak power spectral density should be reduced by the amount in decibels that the directional gain of the antenna exceeds 9 dBi. However, high power point-to-point and point-to-multipoint operations (both fixed and temporary-fixed rapid deployment) may employ transmitting antennas with directional gain up to 26 dBi without any corresponding reduction in the maximum conducted output power or spectral density. Corresponding reduction in the maximum conducted output power and peak power spectral density should be the amount in decibels that the directional gain of the antenna exceeds 26 dBi.
2. Low power devices are also limited to a peak power spectral density of 8 dBm per one MHz. Low power devices using channel bandwidths other than those listed above are permitted; however, they are limited to a peak power spectral density of 8 dBm/MHz. If transmitting antennas of directional gain greater than 9 dBi are used, both the maximum conducted output power and the peak power spectral density should be reduced by the amount in decibels that the directional gain of the antenna exceeds 9 dBi.



Maximum Conducted Output Power Definition:

The maximum conducted output power is measured as a conducted emission over any interval of continuous transmission using instrumentation calibrated in terms of an RMS-equivalent voltage. If the device cannot be connected directly, alternative techniques acceptable to the Commission may be used. The measurement results shall be properly adjusted for any instrument limitations, such as detector response times, limited resolution bandwidth capability when compared to the emission bandwidth, sensitivity, etc., so as to obtain a true maximum conducted output power measurement conforming to the definitions in this paragraph for the emission in question.

3.1.2 Measuring Instruments and Setting

Power Meter Parameter	Setting
Bandwidth	50MHz bandwidth is greater than the EUT emission bandwidth
Detector	Average

Spectrum Parameters	Setting
Detector	Peak
Center Frequency	Low / middle / high channels
RBW / VBW	1MHz / 3MHz

3.1.3 Test Procedures for Maximum Conducted Output Power

Using a wideband gated RF power meter provided that the gate parameters are adjusted such that the power is measured only when the EUT is transmitting at its maximum power control level. Since this measurement is made only during the ON time of the transmitter, no duty cycle correction is required.

3.1.4 Test Procedures for Peak Power Density

1. The EUT transmitter output was connected through an appropriate 50 ohm attenuator to a spectrum analyzer. Resolution bandwidth was set to 1MHz and video bandwidth was set to a value greater than the resolution bandwidth. Instrument limited resolution bandwidth less than channel emission bandwidth; so as to obtain a true peak measurement shall be calculated by total channel power within channel bandwidth.
2. Peak search was used to find peak power spectral density within channel bandwidth and the spectrum analyzer integrated measurement plot was taken.

3.1.5 Test Setup

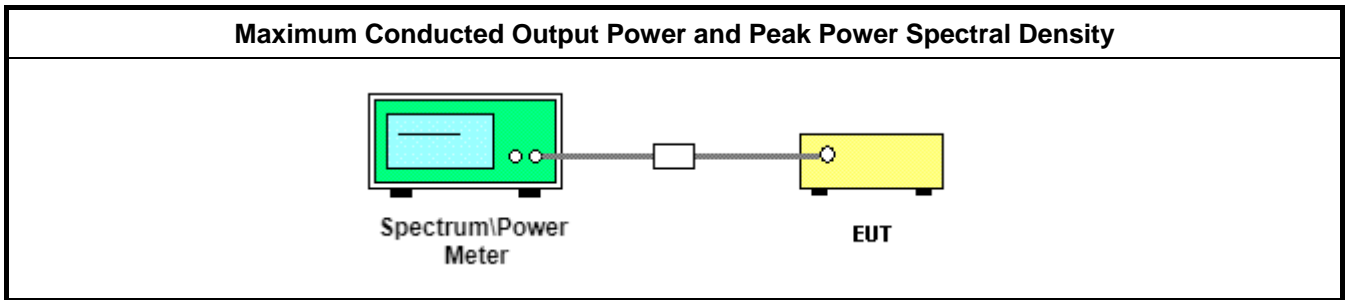

3.1.6 Test Deviation

There is no deviation with the original standard.

3.1.7 Test Result of Maximum Conducted Output Power

Refer as Appendix A

3.1.8 Test Result of Peak Power Spectral Density (PSD)

Refer as Appendix A

3.2 Peak Excursion Measurement

3.2.1 Limit of Peak Excursion

13 dB

3.2.2 Measuring Instruments

Refer a *test* equipment and calibration data table in this test report.

3.2.3 Test Procedures

Testing a single output port is sufficient to demonstrate compliance with the peak excursion.

3.2.4 Test Setup

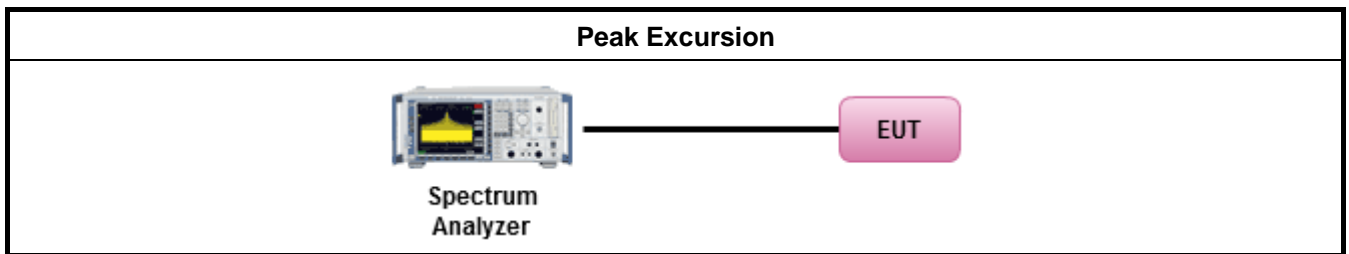

3.2.5 Test Deviation

There is no deviation with the original standard.

3.2.6 Test Result of Peak Excursion

Refer as Appendix B



3.3 Occupied Bandwidth and Emission Mask Measurement

3.3.1 Limit of Occupied Bandwidth and Emission Mask

Emission Mask M: For high power transmitters (greater than 20 dBm) operating in the 4940-4990 MHz frequency band, the power spectral density of the emissions must be attenuated below the output power of the transmitter as follows:

- (1) On any frequency removed from the assigned frequency between 0–45% of the authorized bandwidth (BW): 0 dB
- (2) On any frequency removed from the assigned frequency between 45–50% of the authorized bandwidth: $568 \log (\% \text{ of } (BW)/45)$ dB.
- (3) On any frequency removed from the assigned frequency between 50–55% of the authorized bandwidth: $26 + 145 \log (\% \text{ of } (BW)/50)$ dB.
- (4) On any frequency removed from the assigned frequency between 55–100% of the authorized bandwidth: $32 + 31 \log (\% \text{ of } (BW)/55)$ dB attenuation.
- (5) On any frequency removed from the assigned frequency between 100–150% of the authorized bandwidth: $40 + 57 \log (\% \text{ of } (BW)/100)$ dB attenuation.
- (6) On any frequency removed from the assigned frequency above 150% of the authorized bandwidth: 50 or $55 + 10 \log (P)$ dB, whichever is the lesser attenuation. (P in watts)

The zero dB reference is measured relative to the highest average power of the fundamental emission measured across the designated channel bandwidth using a resolution bandwidth of at least 1% of the occupied bandwidth of the fundamental emission and a video bandwidth of 30 kHz. The power spectral density is the power measured within the resolution bandwidth of the measurement device divided by the resolution bandwidth of the measurement device. Emission levels are also based on the use of measurement instrumentation employing a resolution bandwidth of at least one percent of the occupied bandwidth.

3.3.2 Measuring Instruments and Setting

Please refer to section 4 in this report. The following table is the setting of the spectrum.

Spectrum Parameter	Setting
Attenuation	Auto
Span Frequency	Encompass the entire emissions bandwidth of the signal
RBW	at least 1% of the occupied bandwidth
VBW	BW=3 x RBW, Mask=30kHz
Detector	Peak
Trace	Max Hold

3.3.3 Test Procedures

1. The EUT transmitter was connected to a spectrum analyzer through an appropriate 50 ohm attenuator. Used measurement function of spectrum to measure the 99% occupied bandwidth.
2. The reference level for the mask was set using the highest average power of the fundamental emission measured across the channel bandwidth using a RBW of at least 1% of the occupied bandwidth of the fundamental emission and a VBW of 30 kHz.

3.3.4 Test Setup

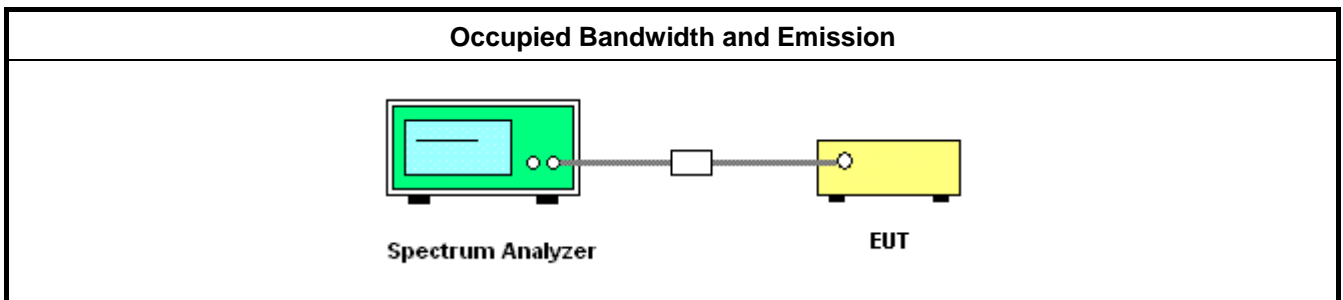

3.3.5 Test Deviation

There is no deviation with the original standard.

3.3.6 Test Result of 99% Occupied Bandwidth (OBW)

Refer as Appendix C

3.3.7 Test Result of Emission Mask

Refer as Appendix C

3.4 Transmitter Conducted Unwanted Emissions Measurement

3.4.1 Limit of Transmitter Conducted Unwanted Emission

On any frequency removed from the assigned frequency above 150% of the authorized bandwidth: 50 or 55+ 10 log (P) dB, whichever is the lesser attenuation. (P=Average transmit power in watt)

3.4.2 Measuring Instruments and Setting

Spectrum Parameter	Setting
Detector	RMS (Average)
Frequency Range	9kHz – 40GHz

3.4.3 Test Procedures

1. The EUT transmitter was connected to a spectrum analyzer through an appropriate 50 ohm attenuator. The spectrum analyzer resolution bandwidth was set to 1 MHz, and the video bandwidth was set to 1 MHz.
2. Find spurious emissions under 50 or 55+ 10 log (P) dB limit, whichever is the lesser attenuation and the spectrum analyzer integrated measurement plot was taken.

3.4.4 Test Setup Layout

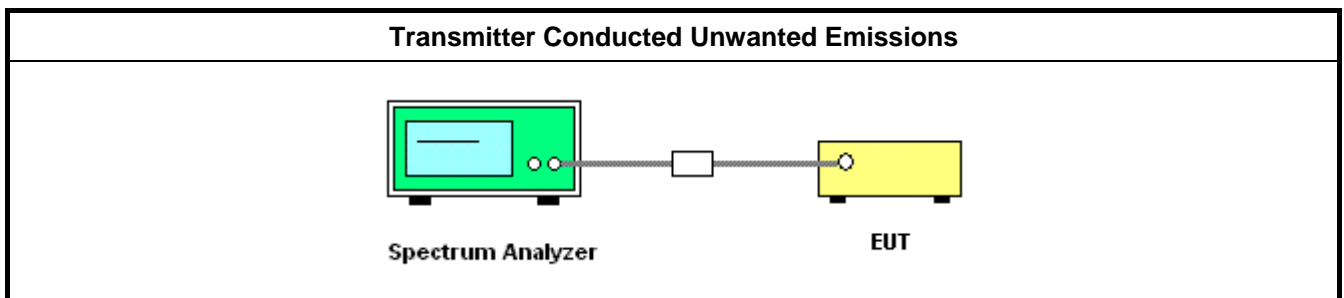

3.4.5 Test Deviation

There is no deviation with the original standard.

3.4.6 Test Result of Transmitter Conducted Unwanted Emissions

Refer as Appendix D



3.5 Transmitter Radiated Unwanted Emissions Measurement

3.5.1 Limit of Transmitter Radiated Unwanted Emissions

On any frequency removed from the assigned frequency above 150% of the authorized bandwidth: 50 or 55+ 10 log (P) dB, whichever is the lesser attenuation. (P=Average transmit power in watt)

3.5.2 Measuring Instruments and Setting

Please refer to section 4 in this report. The following table is the setting of the Spectrum Analyzer.

Spectrum Parameter	Setting
Detector	RMS (Average)
Frequency Range	30MHz – 40GHz
RBW / VBW	1 MHz / 3MHz

3.5.3 Test Procedures

1. The EUT was placed on the top of the turntable in anechoic chamber.
2. A spectrum analyzer was used RBW of 1 MHz and VBW of 3 MHz for the final measurements utilizing an RMS detector at the frequencies with spurious emissions amplitudes.
3. For each suspected emissions, the antenna tower was scan (from 1 M to 4 M) and then the turntable was rotated (from 0 degree to 360 degrees) to find spurious emissions reading.
4. Spurious emissions field strength level equal to spurious emissions reading on spectrum analyzer+ Corrected Reading (Antenna Factor + Cable Loss - Preamp Factor).
5. Final radiated spurious emissions may be converted from spurious emissions field strength level - 95.2 dB

3.5.4 Test Setup

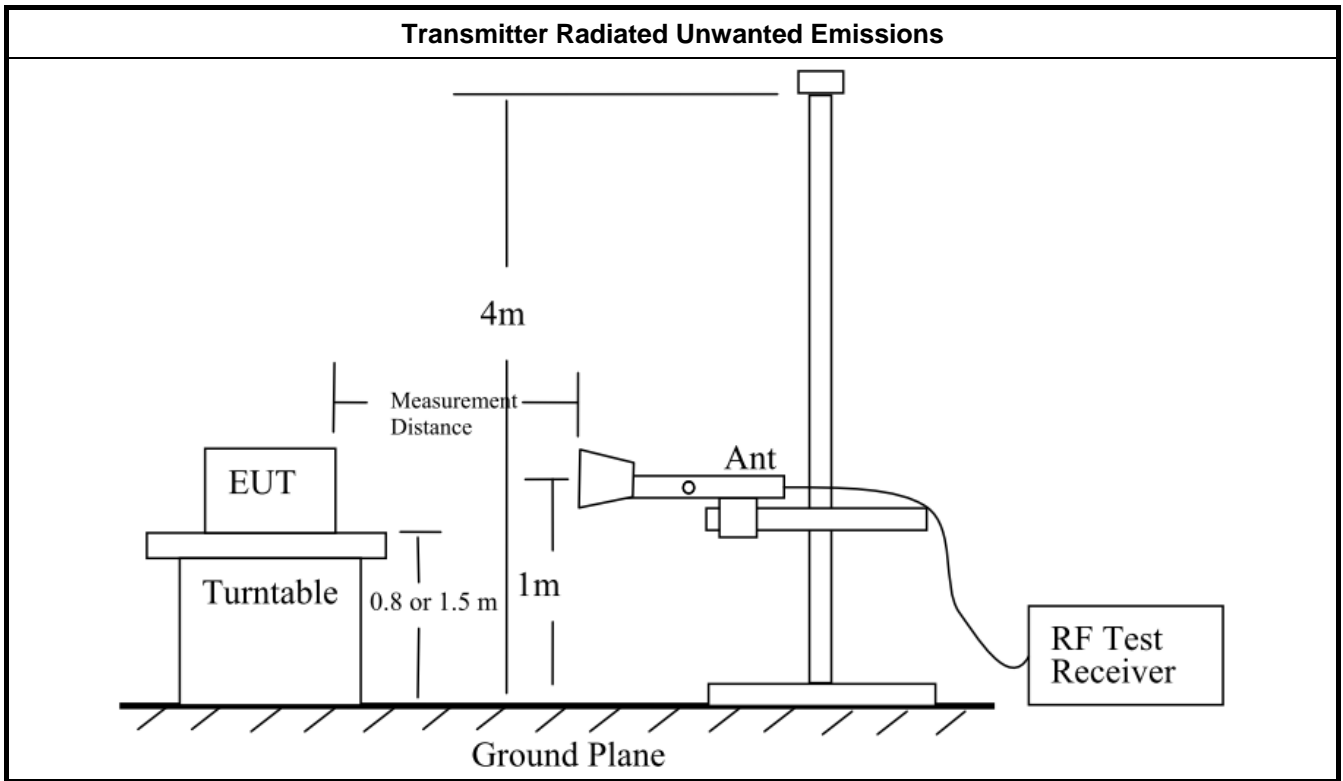

3.5.5 Test Deviation

There is no deviation with the original standard.

3.5.6 Results of Transmitter Radiated Unwanted Emissions

Refer as Appendix E

3.6 Frequency Stability Measurement

3.6.1 Limit of Frequency Stability

The frequency stability shall be sufficient to ensure that the fundamental emissions stay within the authorized frequency band. For equipment authorization purposes, this is a reporting requirement only.

3.6.2 Measuring Instruments and Setting

Please refer to section 4 in this report. The following table is the setting of the spectrum analyzer.

Spectrum Parameter	Setting
Detector	Peak
RBW / VBW	10 kHz / 30kHz

3.6.3 Test Procedures

1. The transmitter output (antenna port) was connected to the spectrum analyzer.
2. EUT have transmitted absence of modulation signal and fixed channel.
3. Set the spectrum analyzer span to view the entire absence of modulation emissions bandwidth.
4. Set RBW = 10 kHz, VBW = 10 kHz with frequency counter function.
5. f_c is declaring of carrier channel frequency. Then the frequency error formula is $(f_c - f) / f_c \times 10^6$ ppm.
6. The test extreme voltage is to change the primary supply voltage from 85 to 115 percent of the nominal value and extreme temperature rule is -30°C~60°C.

3.6.4 Test Setup

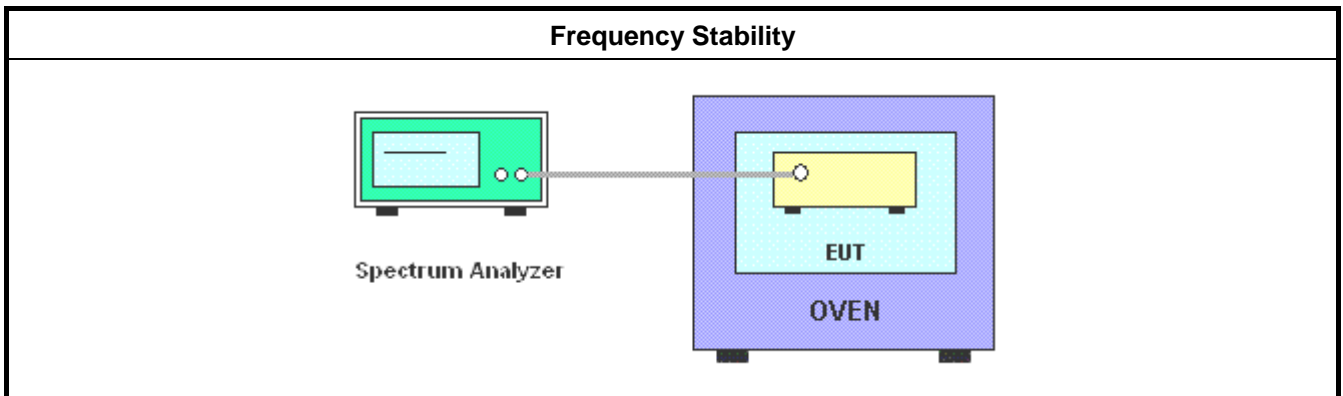

3.6.5 Test Deviation

There is no deviation with the original standard.

3.6.6 Test Result of Frequency Stability

Refer as Appendix F



4 Test Equipment and Calibration Data

Instrument	Manufacturer	Model No.	Serial No.	Characteristics	Calibration Date	Calibration Due Date	Remark
Bilog Antenna with 6dB Attenuator	Schaffner & EMC	CBL6112 & N-6-06	2888 & AT-N0611	30MHz ~ 1GHz	Oct. 12, 2019	Oct. 11, 2020	Radiation (03CH01-CB)
Horn Antenna	ETS-LINDGR EN	3115	00075790	750MHz ~ 18GHz	Nov. 04, 2019	Nov. 03, 2020	Radiation (03CH01-CB)
Horn Antenna	Schwarzbeck	BBHA 9170	BBHA9170252	15GHz ~ 40GHz	Jun. 27, 2019	Jun. 26, 2020	Radiation (03CH01-CB)
Pre-Amplifier	EMCI	EMC330N	980332	20MHz ~ 3GHz	May 01, 2019	Apr. 30, 2020	Radiation (03CH01-CB)
Pre-Amplifier	Agilent	8449B	3008A02310	1GHz ~ 26.5GHz	Jan. 08, 2019	Jan. 07, 2020	Radiation (03CH01-CB)
Pre-Amplifier	MITEQ	TTA1840-35-HG	1864479	18GHz ~ 40GHz	Jul. 03, 2019	Jul. 02, 2020	Radiation (03CH01-CB)
Spectrum Analyzer	R&S	FSP40	100056	9kHz ~ 40GHz	Jan. 31, 2019	Jan. 30, 2020	Radiation (03CH01-CB)
EMI Test Receiver	R&S	ESCS	826547/017	9kHz ~ 2.75GHz	May 15, 2019	May 14, 2020	Radiation (03CH01-CB)
RF Cable-low	Woken	RG402	Low Cable-16+17	30 MHz ~ 1 GHz	Oct. 07, 2019	Oct. 06, 2020	Radiation (03CH01-CB)
RF Cable-high	Woken	RG402	High Cable-16	1 GHz ~ 18 GHz	Oct. 07, 2019	Oct. 06, 2020	Radiation (03CH01-CB)
RF Cable-high	Woken	RG402	High Cable-16+17	1 GHz ~ 18 GHz	Oct. 07, 2019	Oct. 06, 2020	Radiation (03CH01-CB)
RF Cable-high	Woken	RG402	High Cable-40G#1	18GHz ~ 40 GHz	Jul. 24, 2019	Jul. 23, 2020	Radiation (03CH01-CB)
RF Cable-high	Woken	RG402	High Cable-40G#2	18GHz ~ 40 GHz	Jul. 24, 2019	Jul. 23, 2020	Radiation (03CH01-CB)
Spectrum analyzer	R&S	FSV40	101027	9kHz~40GHz	Jul. 02, 2019	Jul. 01, 2020	Conducted (TH02-CB)
Temp. and Humidity Chamber	Ten Billion	TTH-C2SP	TBN-1010206	-20~150 degree	Mar. 04. 2019	Mar. 03. 2020	Conducted (TH02-CB)
Power Sensor	Anritsu	MA2411B	1126203	300MHz~40GHz	Sep. 11, 2019	Sep. 10, 2020	Conducted (TH02-CB)
Power Meter	Anritsu	ML2495A	1210004	300MHz~40GHz	Sep. 11, 2019	Sep. 10, 2020	Conducted (TH02-CB)
RF Cable-high	Woken	RG402	High Cable-01	1 GHz – 26.5 GHz	Oct. 07, 2019	Oct. 06, 2020	Conducted (TH02-CB)
RF Cable-high	Woken	RG402	High Cable-02	1 GHz – 26.5 GHz	Oct. 07, 2019	Oct. 06, 2020	Conducted (TH02-CB)
RF Cable-high	Woken	RG402	High Cable-3	1 GHz – 26.5 GHz	Oct. 07, 2019	Oct. 06, 2020	Conducted (TH02-CB)
RF Cable-high	Woken	RG402	High Cable-04	1 GHz – 26.5 GHz	Oct. 07, 2019	Oct. 06, 2020	Conducted (TH02-CB)



RF Cable-high	Woken	RG402	High Cable-05	1 GHz – 26.5 GHz	Oct. 07, 2019	Oct. 06, 2020	Conducted (TH02-CB)
---------------	-------	-------	---------------	------------------	---------------	---------------	------------------------

Note: Calibration Interval of instruments listed above is one year.



Summary

Mode	Power (dBm)	Power (W)
4.94-4.99GHz	-	-
802.11j_20MHz_Nss1_2TX	20.05	0.101



Result

Mode	Result	DG (dBi)	Port 1 (dBm)	Port 2 (dBm)	Power (dBm)	Power Lim. (dBm)
4.94-4.99GHz_802.11j_20MHz_Nss1_2TX	-	-	-	-	-	-
4950MHz	Pass	16.00	16.98	17.07	20.04	33.00
4980MHz	Pass	16.00	17.07	17.01	20.05	33.00

DG = Directional Gain; **Port n** = Port n output power



Summary

Mode	PD (dBm/MHz)
4.94-4.99GHz	-
802.11j_20MHz_Nss1_2TX	7.11

Result

Mode	Result	DG (dBi)	Port 1 (dBm/MHz)	Port 2 (dBm/MHz)	PD (dBm/MHz)	PD Limit (dBm/MHz)
4.94-4.99GHz_802.11j_20MHz_Nss1_2TX	-	-	-	-	-	-
4950MHz	Pass	16.00	4.32	4.27	6.93	21.00
4980MHz	Pass	16.00	4.44	4.27	7.11	21.00

DG = Directional Gain;

PD = trace bin-by-bin of each transmits port summing can be performed maximum power density; **Port X** = Port Xpower density;

4.94-4.99GHz_802.11j_20MHz_Nss1_2TX
4950MHz

PSD

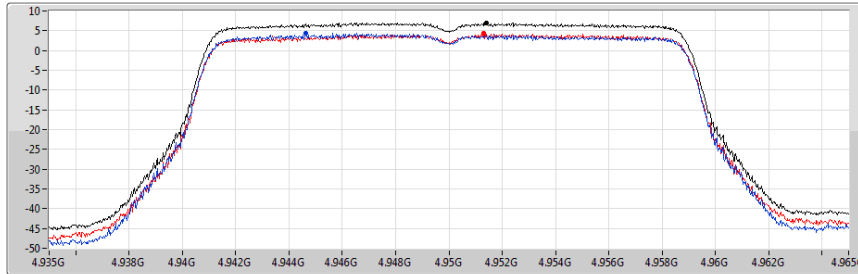

26/12/2019

- Sum 
- Port 1 
- Port 2 

PD (dBm/MHz)	CF (Hz)	Span (Hz)	RBW (Hz)	VBW (Hz)	Sweep (s)	Detector	Port
4.32	4.95G	30M	1M	3M	1m	RMS	1
4.27	4.95G	30M	1M	3M	1m	RMS	2
Sum PD (dBm/MHz)							
6.93							

4.94-4.99GHz_802.11j_20MHz_Nss1_2TX
4980MHz

PSD

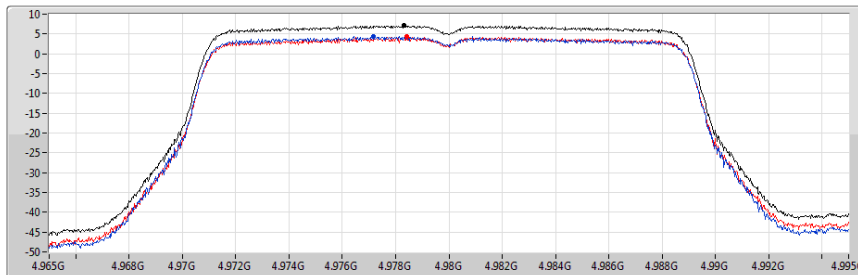

26/12/2019

- Sum 
- Port 1 
- Port 2 

PD (dBm/MHz)	CF (Hz)	Span (Hz)	RBW (Hz)	VBW (Hz)	Sweep (s)	Detector	Port
4.44	4.98G	30M	1M	3M	1m	RMS	1
4.27	4.98G	30M	1M	3M	1m	RMS	2
Sum PD (dBm/MHz)							
7.11							



Summary

Mode	Result	Freq (MHz)	Limit (dB)	0.1%	Port
4.94-4.99GHz	-	-	-	-	-
802.11j_20MHz_Nss1_2TX	Pass	4980	13.00	7.66	1



Result

Mode	Result	Freq (MHz)	Limit (dB)	0.1%	Port
4.94-4.99GHz_802.11j_20MHz_Nss1_2TX	-	-	-	-	-
4950MHz	Pass	4950	13.00	7.47	1
4980MHz	Pass	4980	13.00	7.66	1

4.94-4.99GHz_802.11j_20MHz_Nss1_2TX
4950MHz

PAR

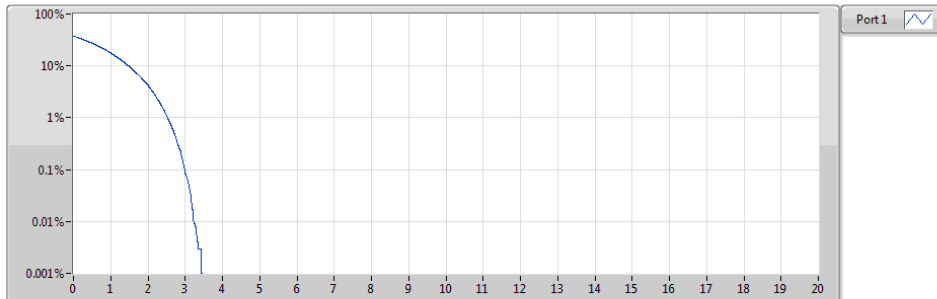

Freq (MHz)	MBW(Hz)	0.1%	Margin(dB)	Limit(dB)	Port
4950	20M	7.47	-5.53	13.00	1

4.94-4.99GHz_802.11j_20MHz_Nss1_2TX
4980MHz

PAR

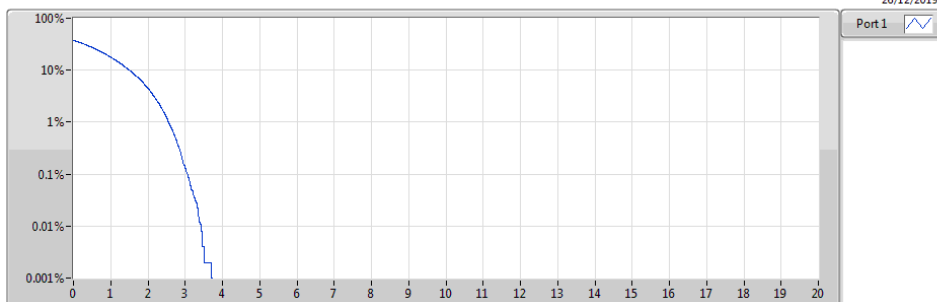

Freq (MHz)	MBW(Hz)	0.1%	Margin(dB)	Limit(dB)	Port
4980	20M	7.66	-5.34	13.00	1



Summary

Mode	Max-NdB (Hz)	Max-OBW (Hz)	ITU-Code	Min-NdB (Hz)	Min-OBW (Hz)
4.94-4.99GHz	-	-	-	-	-
802.11j_20MHz_Nss1_2TX	20.175M	17.573M	17M6D1D	19.95M	17.554M

Max-N dB = Maximum 26dB down bandwidth; **Max-OBW** = Maximum 99% occupied bandwidth;
Min-N dB = Minimum 26dB down bandwidth; **Min-OBW** = Minimum 99% occupied bandwidth;

Result

Mode	Result	Limit (Hz)	Port 1-NdB (Hz)	Port 1-OBW (Hz)	Port 2-NdB (Hz)	Port 2-OBW (Hz)
4.94-4.99GHz_802.11j_20MHz_Nss1_2TX	-	-	-	-	-	-
4950MHz	Pass	Inf	20.175M	17.569M	20.05M	17.573M
4980MHz	Pass	Inf	19.95M	17.557M	20M	17.554M

Port X-N dB = Port X 26dB down bandwidth; **Port X-OBW** = Port X 99% occupied bandwidth;

4.94-4.99GHz_802.11j_20MHz_Nss1_2TX

EBW

4950MHz

26/12/2019

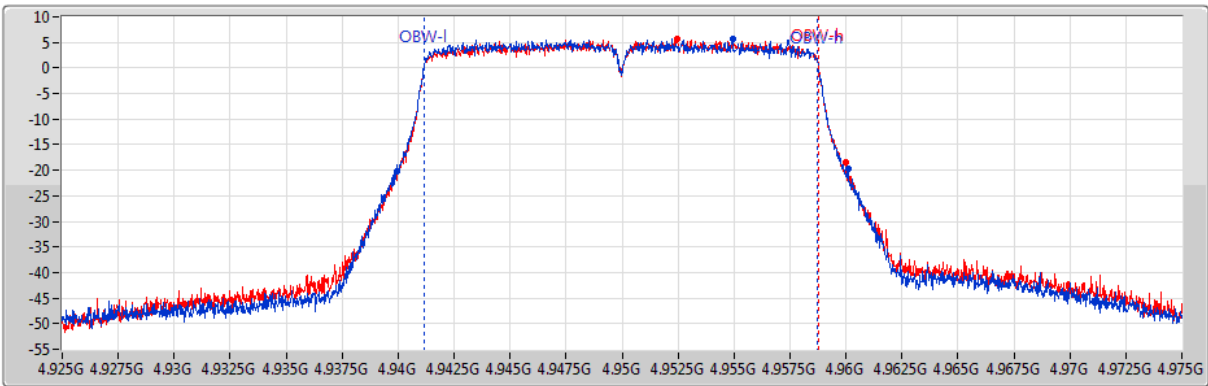

Port 1

Port 2

26dB(Hz)	Fl-26dB(Hz)	Fh-26dB(Hz)	OBW(Hz)	Fl-OBW(Hz)	Fh-OBW(Hz)	Port	CF(Hz)	Span(Hz)	RBW(Hz)	VBW(Hz)
20.175M	4.939925G	4.9601G	17.569M	4.941177G	4.958746G	1	4.95G	50M	200k	1M
20.05M	4.93995G	4.96G	17.573M	4.941182G	4.958754G	2	4.95G	50M	200k	1M

4.94-4.99GHz_802.11j_20MHz_Nss1_2TX

EBW

4980MHz

26/12/2019

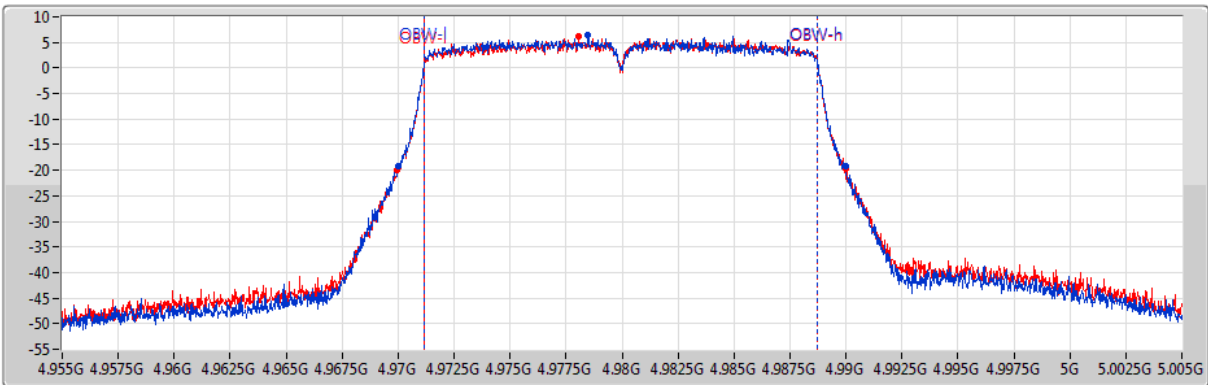

Port 1

Port 2

26dB(Hz)	Fl-26dB(Hz)	Fh-26dB(Hz)	OBW(Hz)	Fl-OBW(Hz)	Fh-OBW(Hz)	Port	CF(Hz)	Span(Hz)	RBW(Hz)	VBW(Hz)
19.95M	4.970025G	4.989975G	17.557M	4.971179G	4.988735G	1	4.98G	50M	200k	1M
20M	4.969975G	4.989975G	17.554M	4.971183G	4.988737G	2	4.98G	50M	200k	1M

4.94-4.99GHz 802.11j_20MHz_Nss1_2TX
4950MHz

Mask

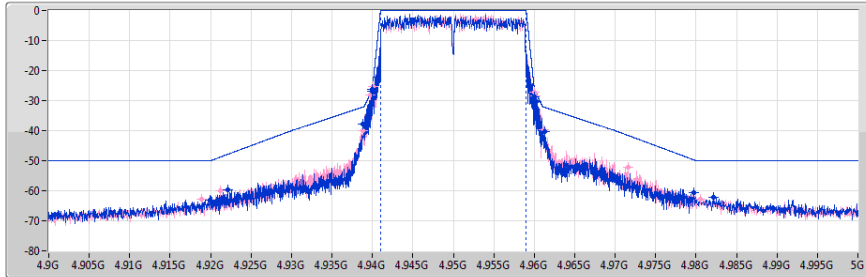

26/12/2019

Port 1
Port 2

F-Start(Hz)	F-Stop(Hz)	RBW(Hz)	VBW(Hz)	Detector	Freq(Hz)	Level(dBm)	Limit(dBm)	Margin(dB)	Port	Remark	Ref.Limit(dB)
4.9G	4.92G	200k	30k	RMS	4.91996G	-63.06	-50.00	-13.06	1	-	-
4.92G	4.93G	200k	30k	RMS	4.92212G	-59.73	-47.88	-11.85	1	-	-
4.93G	4.939G	200k	30k	RMS	4.93887G	-37.93	-32.11	-5.82	1	-	-
4.939G	4.94G	200k	30k	RMS	4.94G	-26.73	-26.02	-0.71	1	-	-
4.94G	4.941G	200k	30k	RMS	4.94002G	-26.31	-25.58	-0.73	1	-	-
4.941G	4.959G	200k	30k	RMS	4.95G	15.19	Inf	-Inf	1	Ref.CP 18M	-
4.959G	4.96G	200k	30k	RMS	4.95998G	-28.79	-25.43	-3.36	1	-	-
4.96G	4.961G	200k	30k	RMS	4.96028G	-30.39	-27.67	-2.72	1	-	-
4.961G	4.97G	200k	30k	RMS	4.96129G	-40.46	-32.26	-8.20	1	-	-
4.97G	4.98G	200k	30k	RMS	4.97974G	-60.74	-49.74	-11.00	1	-	-
4.98G	5G	200k	30k	RMS	4.98212G	-62.29	-50.00	-12.29	1	-	-
4.9G	4.92G	200k	30k	RMS	4.91888G	-62.84	-50.00	-12.84	2	-	-
4.92G	4.93G	200k	30k	RMS	4.92124G	-60.01	-48.76	-11.25	2	-	-
4.93G	4.939G	200k	30k	RMS	4.93877G	-40.03	-32.21	-7.82	2	-	-
4.939G	4.94G	200k	30k	RMS	4.93977G	-28.27	-27.40	-0.87	2	-	-
4.94G	4.941G	200k	30k	RMS	4.94004G	-25.18	-24.91	-0.27	2	-	-
4.941G	4.959G	200k	30k	RMS	4.95G	15.30	Inf	-Inf	2	Ref.CP 18M	-
4.959G	4.96G	200k	30k	RMS	4.95997G	-27.14	-25.22	-1.92	2	-	-
4.96G	4.961G	200k	30k	RMS	4.96018G	-28.47	-27.08	-1.39	2	-	-
4.961G	4.97G	200k	30k	RMS	4.9612G	-39.56	-32.18	-7.38	2	-	-
4.97G	4.98G	200k	30k	RMS	4.97158G	-52.18	-41.58	-10.60	2	-	-
4.98G	5G	200k	30k	RMS	4.98056G	-62.85	-50.00	-12.85	2	-	-

4.94-4.99GHz 802.11j_20MHz_Nss1_2TX
4980MHz

Mask

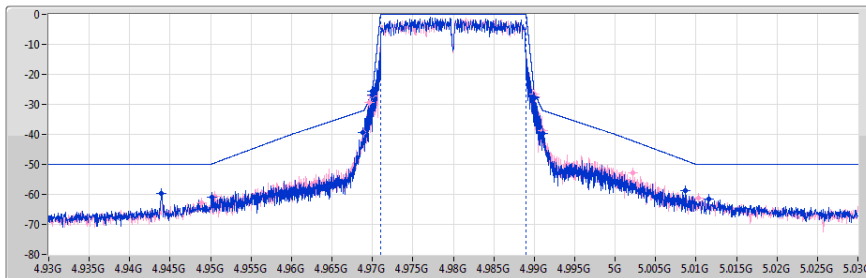

26/12/2019

Port 1
Port 2

F-Start(Hz)	F-Stop(Hz)	RBW(Hz)	VBW(Hz)	Detector	Freq(Hz)	Level(dBm)	Limit(dBm)	Margin(dB)	Port	Remark	Ref.Limit(dB)
4.93G	4.95G	200k	30k	RMS	4.94396G	-59.62	-50.00	-9.62	1	-	-
4.95G	4.96G	200k	30k	RMS	4.95018G	-61.08	-49.82	-11.26	1	-	-
4.96G	4.969G	200k	30k	RMS	4.96878G	-39.38	-32.19	-7.19	1	-	-
4.969G	4.97G	200k	30k	RMS	4.96995G	-26.96	-26.31	-0.65	1	-	-
4.97G	4.971G	200k	30k	RMS	4.97003G	-25.77	-25.27	-0.50	1	-	-
4.971G	4.989G	200k	30k	RMS	4.98G	15.44	Inf	-Inf	1	Ref.CP 18M	-
4.989G	4.99G	200k	30k	RMS	4.98992G	-27.41	-23.97	-3.44	1	-	-
4.99G	4.991G	200k	30k	RMS	4.99002G	-27.78	-26.13	-1.65	1	-	-
4.991G	5G	200k	30k	RMS	4.99102G	-39.59	-32.02	-7.57	1	-	-
5G	5.01G	200k	30k	RMS	5.00868G	-58.78	-48.68	-10.10	1	-	-
5.01G	5.03G	200k	30k	RMS	5.01152G	-61.65	-50.00	-11.65	1	-	-
4.93G	4.95G	200k	30k	RMS	4.94888G	-62.70	-50.00	-12.70	2	-	-
4.95G	4.96G	200k	30k	RMS	4.95052G	-60.64	-49.48	-11.16	2	-	-
4.96G	4.969G	200k	30k	RMS	4.96895G	-39.37	-32.05	-7.32	2	-	-
4.969G	4.97G	200k	30k	RMS	4.96962G	-29.41	-28.28	-1.13	2	-	-
4.97G	4.971G	200k	30k	RMS	4.97G	-27.12	-25.90	-1.22	2	-	-
4.971G	4.989G	200k	30k	RMS	4.98G	15.35	Inf	-Inf	2	Ref.CP 18M	-
4.989G	4.99G	200k	30k	RMS	4.98998G	-26.42	-25.58	-0.84	2	-	-
4.99G	4.991G	200k	30k	RMS	4.99011G	-27.58	-26.66	-0.92	2	-	-
4.991G	5G	200k	30k	RMS	4.99102G	-38.61	-32.02	-6.59	2	-	-
5G	5.01G	200k	30k	RMS	5.0022G	-52.89	-42.20	-10.69	2	-	-
5.01G	5.03G	200k	30k	RMS	5.01032G	-61.12	-50.00	-11.12	2	-	-



Summary

Mode	Result	F-Start (Hz)	F-Stop (Hz)	RBW (Hz)	VBW (Hz)	Detector	Freq (Hz)	Level (dBm)	Limit (dBm)	Margin (dB)	Remark	Ref.Limit (dB)
4.94-4.99GHz	-	-	-	-	-	-	-	-	-	-	-	-
802.11j_20MHz_Nss1_2TX	Pass	4.991G	13.618G	1M	3M	RMS	6.59886G	-55.57	-29.96	-25.61	-	-

Result

Mode	Result	F-Start (Hz)	F-Stop (Hz)	RBW (Hz)	VBW (Hz)	Detector	Freq (Hz)	Level (dBm)	Limit (dBm)	Margin (dB)	Remark	Ref.Limit (dB)
4.94-4.99GHz_802.11j_20MHz_Nss1_2TX	-	-	-	-	-	-	-	-	-	-	-	-
4950MHz	Pass	9k	150k	200	1k	RMS	121.483k	-73.47	-29.96	-43.51	-	-
4950MHz	Pass	150k	30M	10k	30k	RMS	150k	-67.58	-29.96	-37.62	-	-
4950MHz	Pass	30M	1.5G	1M	3M	RMS	1.18469G	-63.16	-29.96	-33.20	-	-
4950MHz	Pass	1.5G	4.909G	1M	3M	RMS	4.909G	-58.27	-29.96	-28.31	-	-
4950MHz	Pass	4.909G	4.91G	200k	620k	RMS	4.9095G	-58.71	-29.96	-28.75	MBW 1M	-
4950MHz	Pass	4.99G	4.991G	200k	620k	RMS	4.9905G	-57.42	-29.96	-27.46	MBW 1M	-
4950MHz	Pass	4.991G	13.618G	1M	3M	RMS	6.59886G	-55.57	-29.96	-25.61	-	-
4950MHz	Pass	13.618G	40G	1M	3M	RMS	38.57867G	-66.78	-29.96	-36.82	-	-
4980MHz	Pass	9k	150k	200	1k	RMS	121.624k	-73.33	-29.95	-43.38	-	-
4980MHz	Pass	150k	30M	10k	30k	RMS	150k	-68.50	-29.95	-38.55	-	-
4980MHz	Pass	30M	1.5G	1M	3M	RMS	1.25157G	-63.09	-29.95	-33.14	-	-
4980MHz	Pass	1.5G	4.939G	1M	3M	RMS	4.93857G	-57.67	-29.95	-27.72	-	-
4980MHz	Pass	4.939G	4.94G	200k	620k	RMS	4.9395G	-58.25	-29.95	-28.30	MBW 1M	-
4980MHz	Pass	5.02G	5.021G	200k	620k	RMS	5.0205G	-56.63	-29.95	-26.68	MBW 1M	-
4980MHz	Pass	5.021G	13.618G	1M	3M	RMS	5.02422G	-56.26	-29.95	-26.31	-	-
4980MHz	Pass	13.618G	40G	1M	3M	RMS	38.60505G	-66.84	-29.95	-36.89	-	-

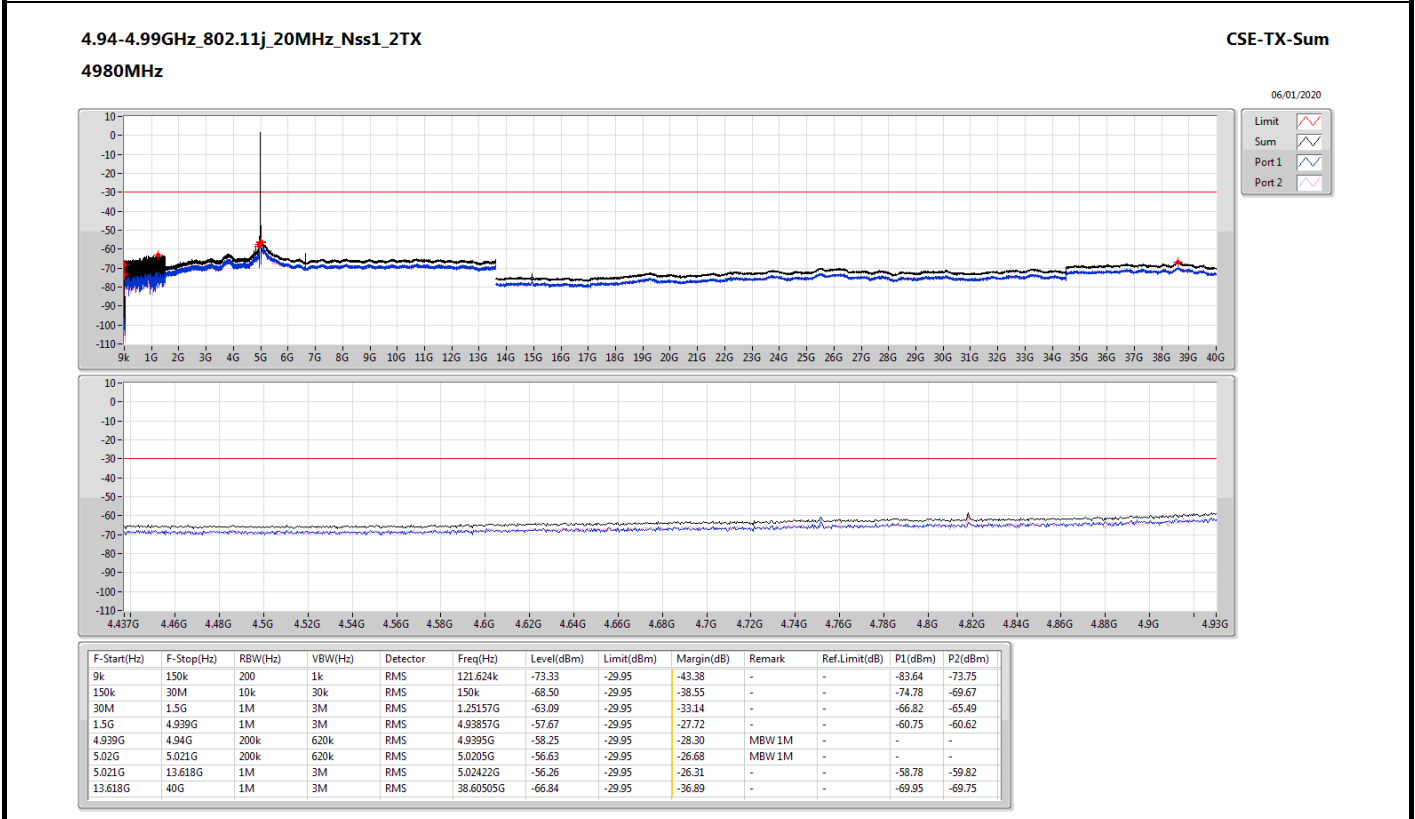
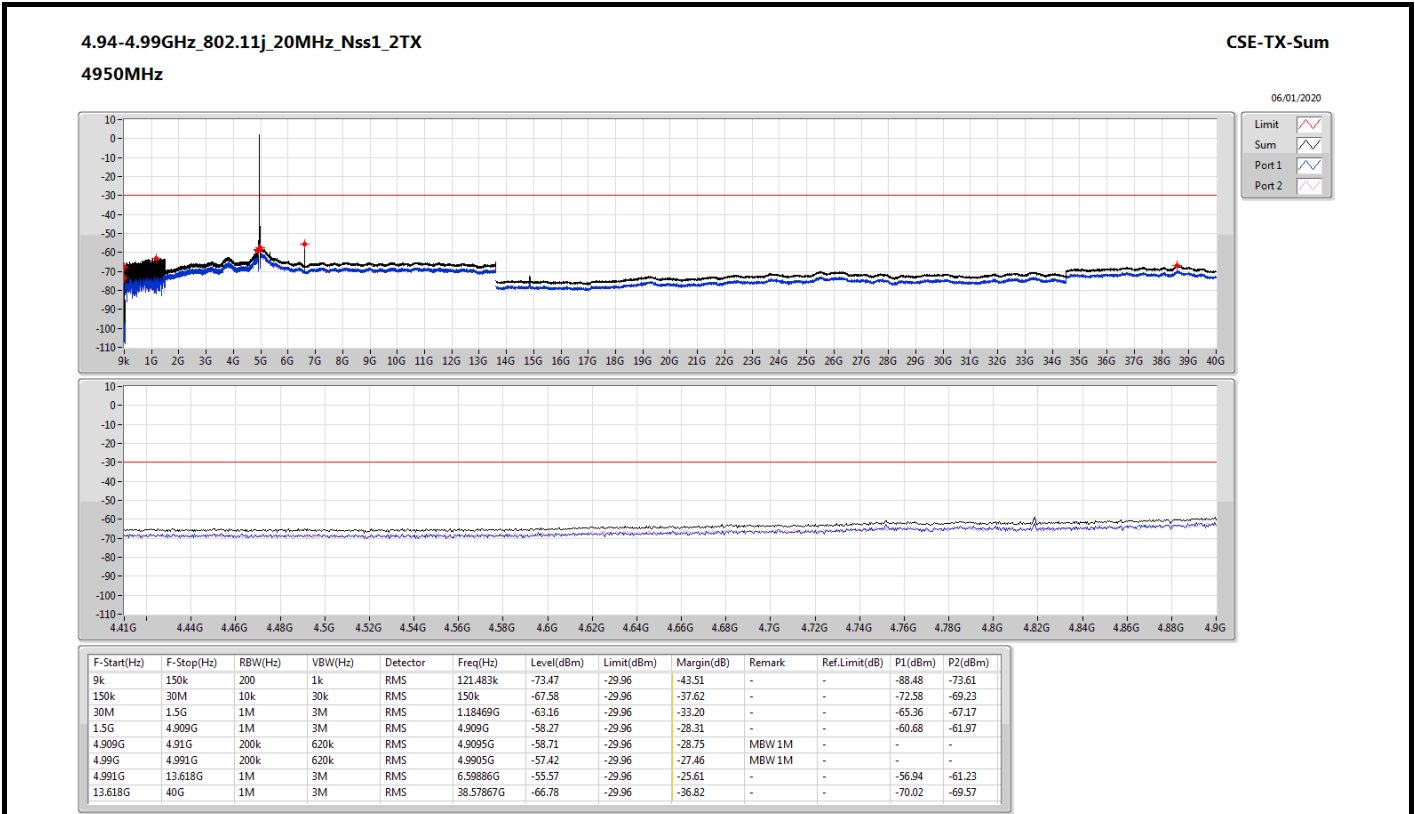



RSE below 1GHz Result

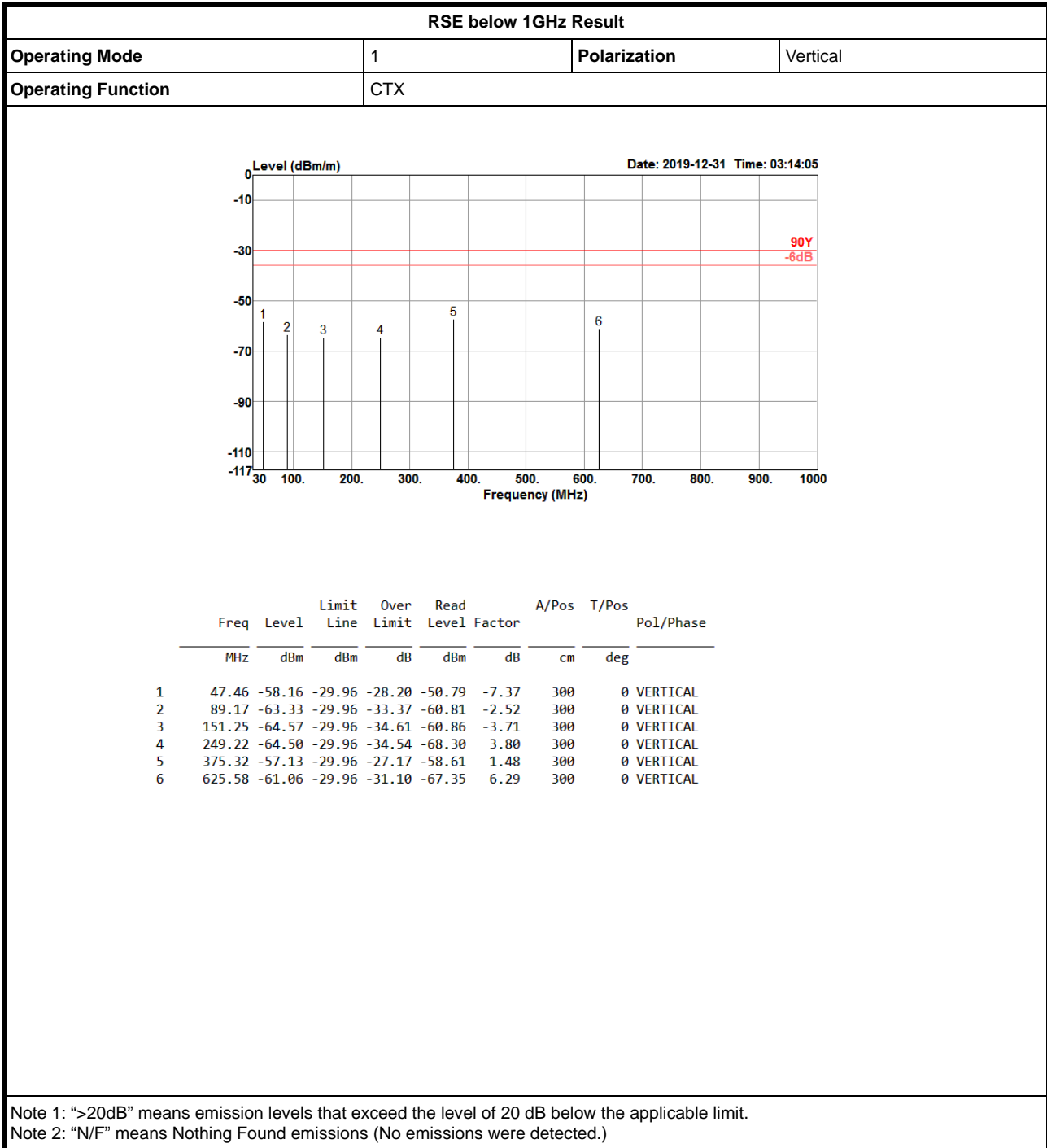



RSE below 1GHz Result

RSE below 1GHz Result																																																																											
Operating Mode	1	Polarization	Horizontal																																																																								
Operating Function	CTX																																																																										
<div style="display: flex; justify-content: space-between;"> Level (dBm/m) Date: 2019-12-31 Time: 03:18:57 </div> <p style="text-align: center;">Frequency (MHz)</p>																																																																											
<table border="1" style="width: 100%; border-collapse: collapse; margin-top: 20px;"> <thead> <tr> <th></th> <th>Freq</th> <th>Level</th> <th>Limit</th> <th>Over</th> <th>Read</th> <th>A/Pos</th> <th>T/Pos</th> <th>Pol/Phase</th> </tr> <tr> <th></th> <th>MHz</th> <th>dBm</th> <th>dBm</th> <th>dB</th> <th>dBm</th> <th>dB</th> <th>cm</th> <th>deg</th> </tr> </thead> <tbody> <tr> <td>1</td> <td>89.17</td> <td>-61.14</td> <td>-29.96</td> <td>-31.18</td> <td>-58.86</td> <td>-2.28</td> <td>300</td> <td>0 HORIZONTAL</td> </tr> <tr> <td>2</td> <td>249.22</td> <td>-73.69</td> <td>-29.96</td> <td>-43.73</td> <td>-68.30</td> <td>-5.39</td> <td>300</td> <td>0 HORIZONTAL</td> </tr> <tr> <td>3</td> <td>375.32</td> <td>-52.31</td> <td>-29.96</td> <td>-22.35</td> <td>-54.74</td> <td>2.43</td> <td>300</td> <td>0 HORIZONTAL</td> </tr> <tr> <td>4</td> <td>499.48</td> <td>-63.08</td> <td>-29.96</td> <td>-33.12</td> <td>-70.97</td> <td>7.89</td> <td>300</td> <td>0 HORIZONTAL</td> </tr> <tr> <td>5</td> <td>625.58</td> <td>-61.27</td> <td>-29.96</td> <td>-31.31</td> <td>-62.74</td> <td>1.47</td> <td>300</td> <td>0 HORIZONTAL</td> </tr> <tr> <td>6</td> <td>875.84</td> <td>-64.36</td> <td>-29.96</td> <td>-34.40</td> <td>-73.06</td> <td>8.70</td> <td>300</td> <td>0 HORIZONTAL</td> </tr> </tbody> </table>					Freq	Level	Limit	Over	Read	A/Pos	T/Pos	Pol/Phase		MHz	dBm	dBm	dB	dBm	dB	cm	deg	1	89.17	-61.14	-29.96	-31.18	-58.86	-2.28	300	0 HORIZONTAL	2	249.22	-73.69	-29.96	-43.73	-68.30	-5.39	300	0 HORIZONTAL	3	375.32	-52.31	-29.96	-22.35	-54.74	2.43	300	0 HORIZONTAL	4	499.48	-63.08	-29.96	-33.12	-70.97	7.89	300	0 HORIZONTAL	5	625.58	-61.27	-29.96	-31.31	-62.74	1.47	300	0 HORIZONTAL	6	875.84	-64.36	-29.96	-34.40	-73.06	8.70	300	0 HORIZONTAL
	Freq	Level	Limit	Over	Read	A/Pos	T/Pos	Pol/Phase																																																																			
	MHz	dBm	dBm	dB	dBm	dB	cm	deg																																																																			
1	89.17	-61.14	-29.96	-31.18	-58.86	-2.28	300	0 HORIZONTAL																																																																			
2	249.22	-73.69	-29.96	-43.73	-68.30	-5.39	300	0 HORIZONTAL																																																																			
3	375.32	-52.31	-29.96	-22.35	-54.74	2.43	300	0 HORIZONTAL																																																																			
4	499.48	-63.08	-29.96	-33.12	-70.97	7.89	300	0 HORIZONTAL																																																																			
5	625.58	-61.27	-29.96	-31.31	-62.74	1.47	300	0 HORIZONTAL																																																																			
6	875.84	-64.36	-29.96	-34.40	-73.06	8.70	300	0 HORIZONTAL																																																																			
<p>Note 1: ">20dB" means emission levels that exceed the level of 20 dB below the applicable limit. Note 2: "N/F" means Nothing Found emissions (No emissions were detected.)</p>																																																																											



Configurations	20MHz / 4980MHz / Port 1 + Port 2
-----------------------	-----------------------------------

Horizontal

	Freq	Level	Limit Line	Over Limit	Read Level	Factor	A/Pos	T/Pos	Pol/Phase
	MHz	dBm	dBm	dB	dBm	dB	cm	deg	
1	2423.95	-60.76	-29.96	-30.80	-67.65	6.89	201	320	HORIZONTAL
2	5769.23	-43.46	-29.96	-13.50	-63.96	20.50	214	214	HORIZONTAL
3	9923.08	-50.95	-29.96	-20.99	-72.68	21.73	243	158	HORIZONTAL
4	10302.88	-50.40	-29.96	-20.44	-72.74	22.34	196	175	HORIZONTAL
5	15735.58	-43.08	-29.96	-13.12	-72.75	29.67	143	254	HORIZONTAL
6	16153.85	-41.29	-29.96	-11.33	-72.07	30.78	162	265	HORIZONTAL

Vertical

	Freq	Level	Limit Line	Over Limit	Read Level	Factor	A/Pos	T/Pos	Pol/Phase
	MHz	dBm	dBm	dB	dBm	dB	cm	deg	
1	2423.08	-53.83	-29.96	-23.87	-65.55	11.72	158	57	VERTICAL
2	5769.23	-42.49	-29.96	-12.53	-64.96	22.47	187	168	VERTICAL
3	9987.18	-47.24	-29.96	-17.28	-72.51	25.27	196	298	VERTICAL
4	10524.04	-45.09	-29.96	-15.13	-71.95	26.86	156	211	VERTICAL
5	15750.00	-44.56	-29.96	-14.60	-72.53	27.97	188	188	VERTICAL
6	16147.44	-43.38	-29.96	-13.42	-71.67	28.29	122	311	VERTICAL

Note:

The measured Level is calculated using:

Factor: Transmit Antenna Gain + Signal Generator Level - SA reading - Transmit Cable Loss.

Level= Read Level + Factor.



Summary

Mode	Result	Ch (Hz)	Center (Hz)	Fl (Hz)	Fh (Hz)	ppm	Limit (Fl,Fh)	Port	Remark
4.94-4.99GHz	-	-	-	-	-	-	-	-	-
802.11j_20MHz_Nss1_2TX	Pass	4.95G	4.949951G	4.949632G	4.95027G	-9.842	4.94G,4.99G	1	-



Result

Mode	Result	Ch (Hz)	Center (Hz)	Fl (Hz)	Fh (Hz)	ppm	Limit (Fl,Fh)	Port	Remark
4.94-4.99GHz_802.11j_20MHz_Nss1_2TX	-	-	-	-	-	-	-	-	-
4950MHz_-30°C	Pass	4.95G	4.949952G	4.949633G	4.950271G	-9.78	4.94G,4.99G	1	-
4950MHz_-10°C	Pass	4.95G	4.949953G	4.949634G	4.950272G	-9.472	4.94G,4.99G	1	-
4950MHz_0°C	Pass	4.95G	4.949953G	4.949634G	4.950272G	-9.445	4.94G,4.99G	1	-
4950MHz_10°C	Pass	4.95G	4.949954G	4.949635G	4.950273G	-9.28	4.94G,4.99G	1	-
4950MHz_20°C	Pass	4.95G	4.949952G	4.949633G	4.950271G	-9.676	4.94G,4.99G	1	-
4950MHz_30°C	Pass	4.95G	4.949953G	4.949634G	4.950272G	-9.485	4.94G,4.99G	1	-
4950MHz_40°C	Pass	4.95G	4.949954G	4.949635G	4.950273G	-9.33	4.94G,4.99G	1	-
4950MHz_50°C	Pass	4.95G	4.949953G	4.949634G	4.950272G	-9.534	4.94G,4.99G	1	-
4950MHz_60°C	Pass	4.95G	4.949951G	4.949632G	4.95027G	-9.842	4.94G,4.99G	1	-
4950MHz_126.5V	Pass	4.95G	4.949953G	4.949634G	4.950272G	-9.549	4.94G,4.99G	1	-
4950MHz_110V	Pass	4.95G	4.949954G	4.949635G	4.950273G	-9.278	4.94G,4.99G	1	-
4950MHz_93.5V	Pass	4.95G	4.949952G	4.949634G	4.950271G	-9.607	4.94G,4.99G	1	-
4980MHz_-30°C	Pass	4.98G	4.979955G	4.979636G	4.980274G	-9.051	4.94G,4.99G	1	-
4980MHz_-10°C	Pass	4.98G	4.979953G	4.979634G	4.980272G	-9.48	4.94G,4.99G	1	-
4980MHz_0°C	Pass	4.98G	4.979953G	4.979634G	4.980272G	-9.455	4.94G,4.99G	1	-
4980MHz_10°C	Pass	4.98G	4.979955G	4.979636G	4.980274G	-9.003	4.94G,4.99G	1	-
4980MHz_20°C	Pass	4.98G	4.979953G	4.979634G	4.980272G	-9.433	4.94G,4.99G	1	-
4980MHz_30°C	Pass	4.98G	4.979952G	4.979633G	4.98027G	-9.732	4.94G,4.99G	1	-
4980MHz_40°C	Pass	4.98G	4.979953G	4.979634G	4.980273G	-9.367	4.94G,4.99G	1	-
4980MHz_50°C	Pass	4.98G	4.979953G	4.979634G	4.980272G	-9.518	4.94G,4.99G	1	-
4980MHz_60°C	Pass	4.98G	4.979952G	4.979633G	4.980271G	-9.567	4.94G,4.99G	1	-
4980MHz_126.5V	Pass	4.98G	4.979953G	4.979634G	4.980272G	-9.425	4.94G,4.99G	1	-
4980MHz_110V	Pass	4.98G	4.979954G	4.979635G	4.980273G	-9.3	4.94G,4.99G	1	-
4980MHz_93.5V	Pass	4.98G	4.979953G	4.979634G	4.980272G	-9.478	4.94G,4.99G	1	-