

SAR Test Report

Product Name : UltraSky MIMO 11abgn USB Dongle/CPE
Model No. : M27, M27C5, M27C5-16
FCC ID : Z8FMIMO11ABGN

Applicant : AirLink iLife Inc.
Address : 3F-1 Room B , No.97, Sec 4, Chung Hsin Rd., San
Chung City, Taipei Hsien 241, Taiwan

Date of Receipt : Apr. 15, 2014
Test Date : May. 05, 2014
Issued Date : May. 07, 2014
Report No. : 1440359R-HP-US-P03V01
Report Version : V1.0



The test results relate only to the samples tested.

The test report shall not be reproduced except in full without the written approval of Quietek Corporation.

Test Report Certification

Issued Date: May. 07, 2014

Report No: 1440359R-HP-US-P03V01



Product Name : UltraSky MIMO 11abgn USB Dongle/CPE

Applicant : AirLink iLife Inc.

Address : 3F-1 Room B , No.97, Sec 4, Chung Hsin Rd., San Chung City, Taipei Hsien 241,Taiwan

Manufacturer : AirLink WiFi Networking Corp.

Address : 3F-1 Room B , No.97, Sec 4, Chung Hsin Rd., San Chung City, Taipei Hsien 241,Taiwan

FCC ID : Z8FMIMO11ABGN

Model No. : M27, M27C5, M27C5-16

EUT Voltage : 5V

Test Result : Max. SAR Measurement (1g)
802.11b (2.4GHz): 0.066 W/kg;
802.11a (5.2GHz): 0.349 W/kg;
802.11a (5.8GHz): 0.182 W/kg;
Simultaneous transmtion: 0.401 W/kg;

Performed Location : Suzhou EMC Laboratory
No.99 Hongye Rd., Suzhou Industrial Park Loufeng Hi-Tech Development Zone., Suzhou, China
TEL: +86-512-6251-5088 / FAX: +86-512-6251-5098
FCC Registration Number: 800392

Documented By : Alice Ni

Reviewed By : Dream Cao

Approved By : Jeff Chen

Laboratory Information

We, **Quietek Corporation**, are an independent EMC and safety consultancy that was established the whole facility in our laboratories. The test facility has been accredited/accepted(audited or listed) by the following related bodies in compliance with ISO 17025, EN 45001 and specified testing scope:

Taiwan R.O.C.	:	BSMI, NCC, TAF
Germany	:	TUV Rheinland
Norway	:	Nemko, DNV
USA	:	FCC
Japan	:	VCCI
China	:	CNAS

The related certificate for our laboratories about the test site and management system can be downloaded from Quietek Corporation's Web Site :<http://www.quietek.com/tw/ctg/cts/accreditations.htm>

The address and introduction of Quietek Corporation's laboratories can be founded in our Web site :
<http://www.quietek.com/>

If you have any comments, Please don't hesitate to contact us. Our contact information is as below:

HsinChu Testing Laboratory :

No.75-2, 3rd Lin, Wangye Keng, Yonghxing Tsuen, Qionglin Shiang, Hsinchu County 307, Taiwan, R.O.C.
TEL:+886-3-592-8858 / FAX:+886-3-592-8859 E-Mail : service@quietek.com

LinKou Testing Laboratory :

No.5-22, Ruishukeng, Linkou Dist., New Taipei City 24451, Taiwan, R.O.C.
TEL : 886-2-8601-3788 / FAX : 886-2-8601-3789 E-Mail : service@quietek.com

Suzhou Testing Laboratory :

No.99 Hongye Rd., Suzhou Industrial Park Loufeng Hi-Tech Development Zone., SuZhou, China
TEL : +86-512-6251-5088 / FAX : 86-512-6251-5098 E-Mail : service@quietek.com

TABLE OF CONTENTS

Description	Page
1. General Information	6
1.1. EUT Description	6
1.2. Test Environment.....	8
1.3. Simultaneous Transmission Configurations.....	9
1.4. Power Reduction for SAR.....	9
1.5. Guidance Documents	9
2. SAR Measurement System	10
2.1. DASY5 System Description.....	10
2.1.1. Applications	11
2.1.2. Area Scans	11
2.1.3. Zoom Scan (Cube Scan Averaging)	11
2.1.4. Uncertainty of Inter-/Extrapolation and Averaging	11
2.2. DASY5 E-Field Probe.....	12
2.2.1. Isotropic E-Field Probe Specification	12
2.3. Boundary Detection Unit and Probe Mounting Device	13
2.4. DATA Acquisition Electronics (DAE) and Measurement Server	13
2.5. Robot.....	14
2.6. Light Beam Unit.....	14
2.7. Device Holder.....	15
2.8. SAM Twin Phantom.....	15
3. Tissue Simulating Liquid	16
3.1. The composition of the tissue simulating liquid	16
3.2. Tissue Calibration Result.....	17
3.3. Tissue Dielectric Parameters for Head and Body Phantoms	18
4. SAR Measurement Procedure	19
4.1. SAR System Validation.....	19
4.1.1. Validation Dipoles	19
4.1.2. Validation Result	19
4.2. SAR Measurement Procedure.....	21
5. SAR Exposure Limits	22
6. Test Equipment List.....	23

7. Measurement Uncertainty	24
8. Conducted Power Measurement	26
9. Test Procedures	29
9.1. SAR Test Results Summary	29
9.2. Test position and configuration	34
9.3. Simultaneous Transmission Procedures	35
Appendix A. SAR System Validation Data	36
Appendix B. SAR measurement Data	39
Appendix C. Test Setup Photographs & EUT Photographs	80
Appendix D. Probe Calibration Data	88
Appendix E. Dipole Calibration Data	99
Appendix F. DAE Calibration Data	120

1. General Information

1.1. EUT Description

Product Name	UltraSky MIMO 11abgn USB Dongle/CPE
Model No.	M27, M27C5, M27C5-16
EUT Voltage	5V
Frequency Range	For 2.4GHz Band 802.11b/g/n(20MHz): 2412~2462MHz 802.11n(40MHz): 2422~2452MHz For 5.0GHz Band 802.11a/n(20MHz): 5180~5240MHz, 5745~5825MHz 802.11n(40MHz): 5190~5230MHz, 5755~5795MHz
Channel Number	For 2.4GHz Band 802.11b/g/n(20MHz): 11 802.11n(40MHz): 7 For 5.0GHz Band 802.11a /n(20MHz): 9 802.11n(40MHz): 4
Type of Modulation	802.11b: DSSS 802.11a/g/n: OFDM
Data Rate	802.11a/g: 6/9/12/18/24/36/48/54 Mbps 802.11b: 1/2/5.5/11 Mbps 802.11n: up to 300 Mbps
Channel Control	Auto
Antenna Delivery	2*Tx + 2*Rx
Antenna Type	Printed Antenna Reverse SMA connector dipole Antenna
Peak Antenna Gain	0dBi for Printed Antenna 5dBi for Reverse SMA connector dipole Antenna

For 2.4GHz Band

802.11b/g/n(20MHz) Working Frequency of Each Channel:							
Channel	Frequency	Channel	Frequency	Channel	Frequency	Channel	Frequency
01	2412 MHz	02	2417 MHz	03	2422 MHz	04	2427 MHz
05	2432 MHz	06	2437 MHz	07	2442 MHz	08	2447 MHz
09	2452 MHz	10	2457 MHz	11	2462 MHz	N/A	N/A

802.11n(40MHz) Working Frequency of Each Channel:							
Channel	Frequency	Channel	Frequency	Channel	Frequency	Channel	Frequency
03	2422 MHz	04	2427 MHz	05	2432 MHz	06	2437 MHz
07	2442 MHz	08	2447 MHz	09	2452 MHz	N/A	N/A

For 5.0GHz Band

802.11a/n(20MHz) Working Frequency of Each Channel:							
Channel	Frequency	Channel	Frequency	Channel	Frequency	Channel	Frequency
36	5180 MHz	40	5200 MHz	44	5220 MHz	48	5240 MHz
149	5745 MHz	153	5765 MHz	157	5785 MHz	161	5805 MHz
165	5825 MHz	N/A	N/A	N/A	N/A	N/A	N/A

802.11n(40MHz) Working Frequency of Each Channel:							
Channel	Frequency	Channel	Frequency	Channel	Frequency	Channel	Frequency
38	5190 MHz	46	5230 MHz	151	5755 MHz	159	5795 MHz

The test mode of the test dongle can support.

Test Mode	Ant0	Ant1	Ant0+1
802.11b	√	√	×
802.11g	√	√	×
802.11a	√	√	√
802.11n(20MHz)	√	√	√
802.11n(40MHz)	√	√	√

1.2. Test Environment

Ambient conditions in the laboratory:

Items	Required	Actual
Temperature (°C)	18-25	21.5± 2
Humidity (%RH)	30-70	52

1.3. Simultaneous Transmission Configurations

Antenna 0 and Antenna 1 can transmit simultaneously.

1.4. Power Reduction for SAR

There is no power reduction used for any band/mode implemented in this device for SAR purposes.

1.5. Guidance Documents

- 1) FCC KDB Publication 447498 D01v05r02 (General SAR Guidance)
- 2) FCC KDB Publication 447498 D02v02 (SAR Measurement Procedures for USB Dongle Transmitters)
- 3) FCC KDB Publication 865664 D01v01r03(SAR measurement 100 MHz to 6 GHz)
- 4) FCC KDB Publication 248227 D01v01r02 (SAR Considerations for 802.11 Devices)

2. SAR Measurement System

2.1. DASY5 System Description

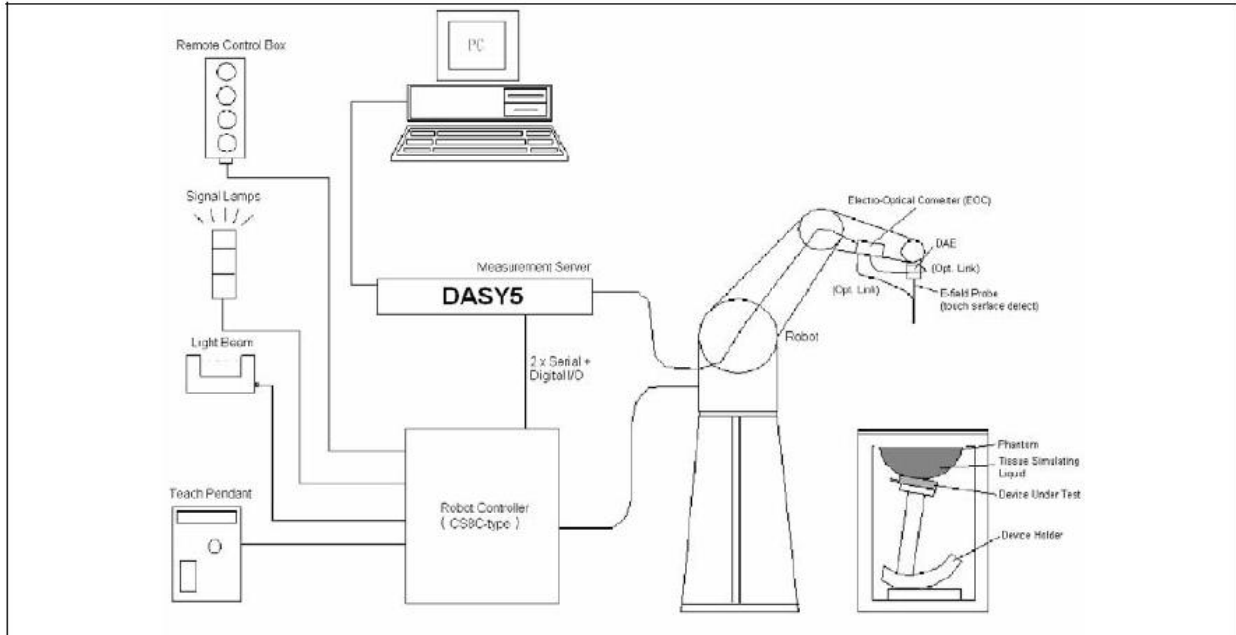

The DASY5 system for performing compliance tests consists of the following items:

- A standard high precision 6-axis robot with controller, teach pendant and software. An arm extension for accommodating the data acquisition electronics (DAE).
- A data acquisition electronics (DAE) which performs the signal amplification, signal multiplexing, AD-conversion, offset measurements, mechanical surface detection, collision detection, etc. The unit is battery powered with standard or rechargeable batteries. The signal is optically transmitted to the EOC.
- The Electro-optical converter (EOC) performs the conversion from optical to electrical signals for the digital communication to the DAE. To use optical surface detection, a special version of the EOC is required. The EOC signal is transmitted to the measurement server.
- The Light Beam used is for probe alignment. This improves the (absolute) accuracy of the probe positioning.
- A computer running WinXP and the DASY5 software.
- Remote control and teach pendant as well as additional circuitry for robot safety such as warning lamps, etc.
- The phantom, the device holder and other accessories according to the targeted measurement.

2.1.1. Applications

Predefined procedures and evaluations for automated compliance testing with all worldwide standards, e.g., IEEE 1528, OET 65, IEC 62209-1, IEC 62209-2, EN 50360, EN 50383 and others.

2.1.2. Area Scans

Area scans are defined prior to the measurement process being executed with a user defined variable spacing between each measurement point (integral) allowing low uncertainty measurements to be conducted. Scans defined for FCC applications utilize a 10mm² step integral, with 1mm interpolation used to locate the peak SAR area used for zoom scan assessments.

When an Area Scan has measured all reachable points, it computes the field maxima found in the scanned area, within a range of the global maximum. The range (in dB) is specified in the standards for compliance testing. For example, a 2 dB range is required in IEEE 1528-2003, EN 50361 and IEC 62209 standards, whereby 3 dB is a requirement when compliance is assessed in accordance with the ARIB standard (Japan).

2.1.3. Zoom Scan (Cube Scan Averaging)

Zoom Scans are used to assess the peak spatial SAR values within a cubic averaging volume containing 1 g and 10 g of simulated tissue. A density of 1000 kg/m³ is used to represent the head and body tissue density and not the phantom liquid density, in order to be consistent with the definition of the liquid dielectric properties, i.e. the side length of the 1 g cube is 10mm, with the side length of the 10 g cube 21,5mm.

The zoom scan integer steps can be user defined so as to reduce uncertainty, but normal practice for typical test applications utilize a physical step of 7x7x7 (5mmx5mmx5mm) providing a volume of 30mm in the X & Y axis, and 30mm in the Z axis.

2.1.4. Uncertainty of Inter-/Extrapolation and Averaging

In order to evaluate the uncertainty of the interpolation, extrapolation and averaged SAR calculation algorithms of the Postprocessor, DASYS5 allows the generation of measurement grids which are artificially predefined by analytically based test functions. Therefore, the grids of area scans and zoom scans can be filled with uncertainty test data, according to the SAR benchmark functions of IEEE 1528. The three analytical functions shown in equations as below are used to describe the possible range of the expected SAR distributions for the tested handsets. The field gradients are covered by the spatially flat distribution f1, the spatially steep distribution f3 and f2 accounts for H-field cancellation on the phantom/tissue surface.

$$f_1(x, y, z) = Ae^{-\frac{z}{2a}} \cos^2 \left(\frac{\pi \sqrt{x'^2 + y'^2}}{2 \cdot 5a} \right)$$

$$f_2(x, y, z) = Ae^{-\frac{z}{a}} \frac{a^2}{a^2 + x'^2} \left(3 - e^{-\frac{2z}{a}} \right) \cos^2 \left(\frac{\pi y'}{2 \cdot 3a} \right)$$

$$f_3(x, y, z) = A \frac{a^2}{\frac{a^2}{4} + x'^2 + y'^2} \left(e^{-\frac{2z}{a}} + \frac{a^2}{2(a + 2z)^2} \right)$$

2.2. DASY5 E-Field Probe

The SAR measurement is conducted with the dosimetric probe manufactured by SPEAG. The probe is specially designed and calibrated for use in liquid with high permittivity. The dosimetric probe has special calibration in liquid at different frequency. SPEAG conducts the probe calibration in compliance with international and national standards (e.g. IEEE 1528, EN 62209-1, IEC 62209, etc.) under ISO 17025. The calibration data are in Appendix D.

2.2.1. Isotropic E-Field Probe Specification

Model	EX3DV4	
Construction	Symmetrical design with triangular core Built-in shielding against static charges PEEK enclosure material (resistant to organic solvents, e.g., DGBE)	
Frequency	10 MHz to 6 GHz Linearity: ± 0.2 dB (30 MHz to 6 GHz)	
Directivity	± 0.3 dB in HSL (rotation around probe axis) ± 0.5 dB in tissue material (rotation normal to probe axis)	
Dynamic Range	10 µW/g to 100 mW/g Linearity: ± 0.2 dB (noise: typically < 1 µW/g)	
Dimensions	Overall length: 330 mm (Tip: 20 mm) Tip diameter: 2.5 mm (Body: 12 mm) Typical distance from probe tip to dipole centers: 1 mm	
Application	High precision dosimetric measurements in any exposure scenario (e.g., very strong gradient fields). Only probe which enables compliance testing for frequencies up to 6 GHz with precision of better 30%.	

2.3. Boundary Detection Unit and Probe Mounting Device

The DASY probes use a precise connector and an additional holder for the probe, consisting of a plastic tube and a flexible silicon ring to center the probe. The connector at the DAE is flexibly mounted and held in the default position with magnets and springs. Two switching systems in the connector mount detect frontal and lateral probe collisions and trigger the necessary software response.

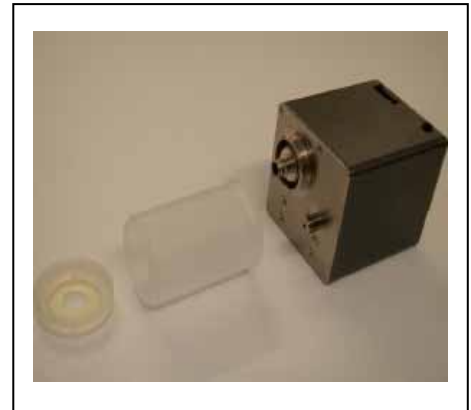

2.4. DATA Acquisition Electronics (DAE) and Measurement Server

The data acquisition electronics (DAE) consists of a highly sensitive electrometer-grade preamplifier with auto-zeroing, a channel and gain-switching multiplexer, a fast 16 bit AD-converter and a command decoder and control logic unit.

Transmission to the measurement server is accomplished through an optical downlink for data and status information as well as an optical uplink for commands and the clock.

The input impedance of the DAE4 is 200M Ohm; the inputs are symmetrical and floating. Common mode rejection is above 80dB.



The DASY5 measurement server is based on a PC/104 CPU board with a 400MHz intel ULV Celeron, 128MB chipdisk and 128MB RAM. The necessary circuits for communication with the DAE electronics box, as well as the 16 bit AD converter system for optical detection and digital I/O interface are contained on the DASY5 I/O board, which is directly connected to the PC/104 bus of the CPU board.



2.5. Robot

The DASY5 system uses the high precision robots TX90 XL type out of the newer series from Stäubli SA (France). For the 6-axis controller DASY5 system, the CS8C robot controller version from Stäubli is used.

The XL robot series have many features that are important for our application:

- High precision (repeatability 0.02 mm)
- High reliability (industrial design)
- Jerk-free straight movements
- Low ELF interference (the closed metallic construction shields against motor control fields)
- 6-axis controller



2.6. Light Beam Unit

The light beam switch allows automatic "tooling" of the probe. During the process, the actual position of the probe tip with respect to the robot arm is measured, as well as the probe length and the horizontal probe offset. The software then corrects all movements, such that the robot coordinates are valid for the probe tip.

The repeatability of this process is better than 0.1 mm. If a position has been taught with an aligned probe, the same position will be reached with another aligned probe within 0.1 mm, even if the other probe has different dimensions. During probe rotations, the probe tip will keep its actual position.



2.7. Device Holder

The DASY5 device holder is designed to cope with different positions given in the standard. It has two scales for the device rotation (with respect to the body axis) and the device inclination (with respect to the line between the ear reference points). The rotation center for both scales is the ear reference point (EPR).

Thus the device needs no repositioning when changing the angles.

The DASY5 device holder has been made out of low-loss POM material having the following dielectric parameters: relative permittivity $\epsilon_r = 3$ and loss tangent $\delta = 0.02$. The amount of dielectric material has been reduced in the closest vicinity of the device, since measurements have suggested that the influence of the clamp on the test results could thus be lowered.



2.8. SAM Twin Phantom

The SAM twin phantom is a fiberglass shell phantom with 2mm shell thickness (except the ear region where shell thickness increases to 6mm). It has three measurement areas:

- Left head
- Right head
- Flat phantom



The bottom plate contains three pair of bolts for locking the device holder. The device holder positions are adjusted to the standard measurement positions in the three sections. A white cover is provided to tap the phantom during off-periods to prevent water evaporation and changes in the liquid parameters. On the phantom tip, three reference markers are provided to identify the phantom position with respect to the robot.

3. Tissue Simulating Liquid

3.1. The composition of the tissue simulating liquid

INGREDIENT (% Weight)	2450MHz Body	5200MHz Body	5800MHz Body
Water	73.2	75.68	75.68
Salt	0.04	0.43	0.43
Sugar	0.00	0.00	0.00
HEC	0.00	0.00	0.00
Preventol	0.00	0.00	0.00
DGBE	26.7	4.42	4.42
Triton X-100	0.00	19.47	19.47

3.2. Tissue Calibration Result

The dielectric parameters of the liquids were verified prior to the SAR evaluation using DASY5 Dielectric Probe Kit and Agilent Vector Network Analyzer E5071C

For FCC:

Body Tissue Simulant Measurement				
Frequency [MHz]	Description	Dielectric Parameters		Tissue Temp. [°C]
		ϵ_r	σ [s/m]	
2450MHz	Reference result ± 5% window	52.7 50.07 to 55.34	1.95 1.85 to 2.05	N/A
	05-05-2014	52.25	1.99	21.0
5200MHz	Reference result ± 5% window	49.0 46.55 to 51.45	5.30 5.04 to 5.57	N/A
	05-05-2014	48.94	5.15	21.0
5800MHz	Reference result ± 5% window	48.2 45.79 to 50.61	6.00 5.70 to 6.30	N/A
	05-05-2014	47.29	6.04	21.0

3.3. Tissue Dielectric Parameters for Head and Body Phantoms

The head tissue dielectric parameters recommended by the IEEE SCC-34/SC-2 in P1528 have been incorporated in the following table. These head parameters are derived from planar layer models simulating the highest expected SAR for the dielectric properties and tissue thickness variations in a human head. Other head and body tissue parameters that have not been specified in P1528 are derived from the tissue dielectric parameters computed from the 4-Cole-Cole equations described in Reference [12] and extrapolated according to the head parameters specified in P1528.

Target Frequency (MHz)	Head		Body	
	ϵ_r	σ (S/m)	ϵ_r	σ (S/m)
150	52.3	0.76	61.9	0.80
300	45.3	0.87	58.2	0.92
450	43.5	0.87	56.7	0.94
835	41.5	0.90	55.2	0.97
900	41.5	0.97	55.0	1.05
915	41.5	0.98	55.0	1.06
1450	40.5	1.20	54.0	1.30
1610	40.3	1.29	53.8	1.40
1800 – 2000	40.0	1.40	53.3	1.52
2450	39.2	1.80	52.7	1.95
3000	38.5	2.40	52.0	2.73
5800	35.3	5.27	48.2	6.00

(ϵ_r = relative permittivity, σ = conductivity and $\rho = 1000 \text{ kg/m}^3$)

4. SAR Measurement Procedure

4.1. SAR System Validation

4.1.1. Validation Dipoles

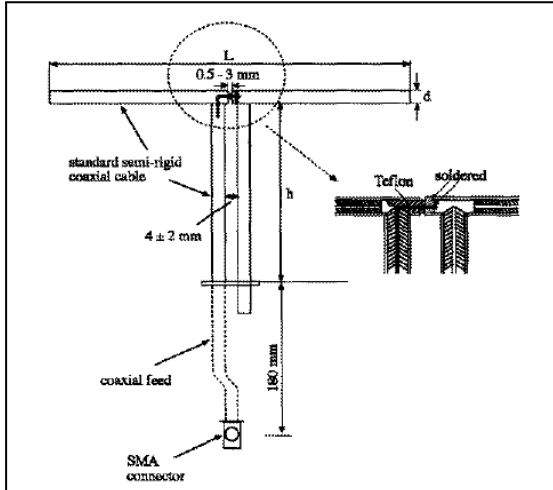

The dipoles used is based on the IEEE-1528 standard, and is complied with mechanical and electrical specifications in line with the requirements of both IEEE and FCC Supplement C. the table below provides details for the mechanical and electrical specifications for the dipoles.

Frequency	L (mm)	h (mm)	d (mm)
2450MHz	53.5	30.4	3.6
5800MHz	20.6	14.2	3.6

4.1.2. Validation Result

System Performance Check at 2450MHz				
Validation Dipole: D2450V2, SN: 839				
Frequency [MHz]	Description	SAR [w/kg] 1g	SAR [w/kg] 10g	Tissue Temp. [°C]
2450 MHz	Reference result ± 10% window	48.7 43.83 to 53.57	22.8 20.52 to 25.08	N/A
	05-05-2014	48.4	22.24	21.0
Note: All SAR values are normalized to 1W forward power.				

System Performance Check at 5200MHz				
Validation Dipole: D5GHzV2, SN: 1078				
Frequency [MHz]	Description	SAR [w/kg] 1g	SAR [w/kg] 10g	Tissue Temp. [°C]
5200 MHz	Reference result ± 10% window	73.1 65.79 to 80.41	20.5 18.45 to 22.55	N/A
	05-05-2014	76.7	21.6	21.0
Note: All SAR values are normalized to 1W forward power.				

System Performance Check at 5800MHz				
Validation Kit: D5GHzV2, SN: 1078				
Frequency [MHz]	Description	SAR [w/kg] 1g	SAR [w/kg] 10g	Tissue Temp. [°C]
5800 MHz	Reference result ± 10% window	73.5 66.15 to 80.85	20.3 18.27 to 22.33	N/A
	05-05-2014	75.1	20.7	21.0
Note: All SAR values are normalized to 1W forward power.				

4.2. SAR Measurement Procedure

The DAS5 calculates SAR using the following equation,

$$SAR = \frac{\sigma |E|^2}{\rho}$$

σ : represents the simulated tissue conductivity

ρ : represents the tissue density

The EUT is set to transmit at the required power in line with product specification, at each frequency relating to the LOW, MID, and HIGH channel settings.

Pre-scans are made on the device to establish the location for the transmitting antenna, using a large area scan in either air or tissue simulation fluid.

The EUT is placed against the Universal Phantom where the maximum area scan dimensions are larger than the physical size of the resonating antenna. When the scan size is not large enough to cover the peak SAR distribution, it is modified by either extending the area scan size in both the X and Y directions, or the device is shifted within the predefined area.

The area scan is then run to establish the peak SAR location (interpolated resolution set at 1mm^2) which is then used to orient the center of the zoom scan. The zoom scan is then executed and the 1g and 10g averages are derived from the zoom scan volume (interpolated resolution set at 1mm^3).

5. SAR Exposure Limits

SAR assessments have been made in line with the requirements of IEEE-1528, FCC Supplement C, and comply with ANSI/IEEE C95.1-1992 “Uncontrolled Environments” limits. These limits apply to a location which is deemed as “Uncontrolled Environment” which can be described as a situation where the general public may be exposed to an RF source with no prior knowledge or control over their exposure.

Limits for General Population/Uncontrolled Exposure (W/kg)

Type Exposure	Uncontrolled Environment Limit
Spatial Peak SAR (1g cube tissue for brain or body)	1.60 W/kg
Spatial Average SAR (whole body)	0.08 W/kg
Spatial Peak SAR (10g for hands, feet, ankles and wrist)	4.00 W/kg

6. Test Equipment List

Instrument	Manufacturer	Model No.	Serial No.	Cali. Due Date
Stäubli Robot TX60L	Stäubli	TX60L	F10/5C90A1/A/01	N/A
Controller	Stäubli	SP1	S-0034	N/A
Dipole Validation Kits	Speag	D2450V2	839	2016.02.24
Dipole Validation Kits	Speag	D5GHzV2	1078	2016.03.03
SAM Twin Phantom	Speag	SAM	TP-1561/1562	N/A
Device Holder	Speag	SD 000 H01 HA	N/A	N/A
Data Acquisition Electronic	Speag	DAE4	1220	2015.01.22
E-Field Probe	Speag	EX3DV4	3710	2015.03.04
SAR Software	Speag	DASY5	V5.2 Build 162	N/A
Power Amplifier	Mini-Circuit	ZHL-42	D051404-28	N/A
Directional Coupler	Agilent	778D	20160	N/A
Universal Radio Communication Tester	R&S	CMU 200	117088	2015.03.28
Vector Network	Agilent	E5071C	MY48367267	2015.03.28
Signal Generator	Agilent	E4438C	MY49070163	2015.03.28
Power Meter	Anritsu	ML2495A	0905006	2014.11.01
Wide Bandwidth Sensor	Anritsu	MA2411B	0846014	2014.11.01

7. Measurement Uncertainty

DASY5 Uncertainty								
Measurement uncertainty for 300 MHz to 3 GHz averaged over 1 gram / 10 gram.								
Error Description	Uncert. value	Prob. Dist.	Div.	(ci) 1g	(ci) 10g	Std. Unc. (1g)	Std. Unc. (10g)	(vi) V _{eff}
Measurement System								
Probe Calibration	±6.0%	N	1	1	1	±6.0%	±6.0%	∞
Axial Isotropy	±4.7%	R	√3	0.7	0.7	±1.9%	±1.9%	∞
Hemispherical Isotropy	±9.6%	R	√3	0.7	0.7	±3.9%	±3.9%	∞
Boundary Effects	±1.0%	R	√3	1	1	±0.6%	±0.6%	∞
Linearity	±4.7%	R	√3	1	1	±2.7%	±2.7%	∞
System Detection Limits	±1.0%	R	√3	1	1	±0.6%	±0.6%	∞
Readout Electronics	±0.3%	N	1	1	1	±0.3%	±0.3%	∞
Response Time	±0.8%	R	√3	1	1	±0.5%	±0.5%	∞
Integration Time	±2.6%	R	√3	1	1	±1.5%	±1.5%	∞
RF Ambient Noise	±3.0%	R	√3	1	1	±1.7%	±1.7%	∞
RF Ambient Reflections	±3.0%	R	√3	1	1	±1.7%	±1.7%	∞
Probe Positioner	±0.4%	R	√3	1	1	±0.2%	±0.2%	∞
Probe Positioning	±2.9%	R	√3	1	1	±1.7%	±1.7%	∞
Max. SAR Eval.	±1.0%	R	√3	1	1	±0.6%	±0.6%	∞
Test Sample Related								
Device Positioning	±2.9%	N	1	1	1	±2.9%	±2.9%	145
Device Holder	±3.6%	N	1	1	1	±3.6%	±3.6%	5
Power Drift	±5.0%	R	√3	1	1	±2.9%	±2.9%	∞
Phantom and Setup								
Phantom Uncertainty	±4.0%	R	√3	1	1	±2.3%	±2.3%	∞
Liquid Conductivity (target)	±5.0%	R	√3	0.64	0.43	±1.8%	±1.2%	∞
Liquid Conductivity (meas.)	±2.5%	N	1	0.64	0.43	±1.6%	±1.1%	∞
Liquid Permittivity (target)	±5.0%	R	√3	0.6	0.49	±1.7%	±1.4%	∞
Liquid Permittivity (meas.)	±2.5%	N	1	0.6	0.49	±1.5%	±1.2%	∞
Combined Std. Uncertainty						±11.0%	±10.8%	387
Expanded STD Uncertainty						±22.0%	±21.5%	

DASY5 Uncertainty								
Measurement uncertainty for 3 GHz to 6 GHz averaged over 1 gram / 10 gram.								
Error Description	Uncert. value	Prob. Dist.	Div.	(ci) 1g	(ci) 10g	Std. Unc. (1g)	Std. Unc. (10g)	(vi) V _{eff}
Measurement System								
Probe Calibration	±6.55%	N	1	1	1	±6.55%	±6.55%	∞
Axial Isotropy	±4.7%	R	√3	0.7	0.7	±1.9%	±1.9%	∞
Hemispherical Isotropy	±9.6%	R	√3	0.7	0.7	±3.9%	±3.9%	∞
Boundary Effects	±2.0%	R	√3	1	1	±1.2%	±1.2%	∞
Linearity	±4.7%	R	√3	1	1	±2.7%	±2.7%	∞
System Detection Limits	±1.0%	R	√3	1	1	±0.6%	±0.6%	∞
Readout Electronics	±0.3%	N	1	1	1	±0.3%	±0.3%	∞
Response Time	±0.8%	R	√3	1	1	±0.5%	±0.5%	∞
Integration Time	±2.6%	R	√3	1	1	±1.5%	±1.5%	∞
RF Ambient Noise	±3.0%	R	√3	1	1	±1.7%	±1.7%	∞
RF Ambient Reflections	±3.0%	R	√3	1	1	±1.7%	±1.7%	∞
Probe Positioner	±0.8%	R	√3	1	1	±0.5%	±0.5%	∞
Probe Positioning	±9.9%	R	√3	1	1	±5.7%	±5.7%	∞
Max. SAR Eval.	±4.0%	R	√3	1	1	±2.3%	±2.3%	∞
Test Sample Related								
Device Positioning	±2.9%	N	1	1	1	±2.9%	±2.9%	145
Device Holder	±3.6%	N	1	1	1	±3.6%	±3.6%	5
Power Drift	±5.0%	R	√3	1	1	±2.9%	±2.9%	∞
Phantom and Setup								
Phantom Uncertainty	±4.0%	R	√3	1	1	±2.3%	±2.3%	∞
Liquid Conductivity (target)	±5.0%	R	√3	0.64	0.43	±1.8%	±1.2%	∞
Liquid Conductivity (meas.)	±2.5%	N	1	0.64	0.43	±1.6%	±1.1%	∞
Liquid Permittivity (target)	±5.0%	R	√3	0.6	0.49	±1.7%	±1.4%	∞
Liquid Permittivity (meas.)	±2.5%	N	1	0.6	0.49	±1.5%	±1.2%	∞
Combined Std. Uncertainty						±12.8%	±12.6%	330
Expanded STD Uncertainty						±25.6%	±25.2%	

8. Conducted Power Measurement

PCB Antenna 0

Test Mode	Frequency (MHz)	Avg. Burst Power (dBm)	Max. Power (dBm)	Scaling Factor
802.11b	2412	15.97	16.0	1.007
	2437	15.68	16.0	1.076
	2462	15.54	16.0	1.112
802.11g	2412	12.82	13.0	1.042
	2437	12.79	13.0	1.050
	2462	12.48	13.0	1.127
802.11n(20MHz)	2412	12.23	12.5	1.064
	2437	12.16	12.5	1.081
	2462	12.42	12.5	1.019
802.11n(40MHz)	2422	11.28	11.5	1.052
	2437	11.17	11.5	1.079
	2452	11.09	11.5	1.099
802.11a	5180	12.06	12.1	1.009
	5200	11.95	12.1	1.035
	5220	11.80	12.1	1.072
	5240	11.82	12.1	1.067
	5745	11.93	12.0	1.016
	5765	11.91	12.0	1.021
	5785	11.58	12.0	1.102
	5805	11.39	12.0	1.151
	5825	11.43	12.0	1.140
802.11n(20MHz)	5180	12.79	13.0	1.050
	5200	12.68	13.0	1.076
	5220	12.53	13.0	1.114
	5240	12.43	13.0	1.140
	5745	11.93	12.0	1.016
	5765	11.87	12.0	1.030
	5785	11.84	12.0	1.038
	5805	11.76	12.0	1.057
	5825	11.79	12.0	1.050
802.11n(40MHz)	5190	11.63	11.7	1.016
	5230	11.38	11.7	1.076
	5755	7.43	7.5	1.016
	5795	7.26	7.5	1.057

1Tx Chain 1

Test Mode	Frequency (MHz)	Avg. Burst Power (dBm)	Max. Power (dBm)	Scaling Factor
802.11b	2412	16.17	16.2	1.007
	2437	16.04	16.2	1.038
	2462	16.11	16.2	1.021
802.11g	2412	12.45	12.5	1.012
	2437	12.36	12.5	1.033
	2462	12.29	12.5	1.050
802.11n(20MHz)	2412	10.74	11.0	1.062
	2437	10.62	11.0	1.091
	2462	10.13	11.0	1.222
802.11n(40MHz)	2422	11.68	11.7	1.005
	2437	11.54	11.7	1.038
	2452	11.39	11.7	1.074
802.11a	5180	8.42	8.8	1.091
	5200	8.36	8.8	1.107
	5220	8.55	8.8	1.059
	5240	8.71	8.8	1.021
	5745	12.73	12.8	1.016
	5765	12.66	12.8	1.033
	5785	12.42	12.8	1.091
	5805	12.37	12.8	1.104
	5825	12.39	12.8	1.099
802.11n(20MHz)	5180	9.12	9.6	1.117
	5200	9.04	9.6	1.138
	5220	9.06	9.6	1.132
	5240	9.08	9.6	1.127
	5745	9.52	9.6	1.019
	5765	9.49	9.6	1.026
	5785	9.47	9.6	1.030
	5805	9.31	9.6	1.069
	5825	9.36	9.6	1.057
802.11n(40MHz)	5190	7.52	7.6	1.019
	5230	7.17	7.6	1.104
	5755	8.37	8.5	1.030
	5795	8.21	8.5	1.069

Note : According to KDB 248227 D01v01r02

- 1, SAR is not required for 802.11g/n channels when the maximum average output power is less than 1/4 dB higher than that measured on the corresponding 802.11b channels.
- 2, When the maximum average output channel in each frequency band is not included in the "default test channels", the maximum channel should be tested instead of an adjacent "default test channel".

9. Test Procedures

9.1. SAR Test Results Summary

SAR MEASUREMENT									
Ambient Temperature (°C) : 21.5 ± 2					Relative Humidity (%) : 52				
Liquid Temperature (°C) : 21.0 ± 2					Depth of Liquid (cm):>15				
Product: UltraSky MIMO 11abgn USB Dongle/CPE									
Test Mode: 802.11b- PCB Antenna 0									
Test Position Head	Antenna Position	Frequency		Frame Power (dBm)	Power Drift (<±0.2)	SAR 1g (W/kg)	Scaling Factor	Scaled SAR 1g (W/kg)	Limit (W/kg)
		Channel	MHz						
Horizontal Up	Fixed	01	2412	15.97	-0.13	0.025	1.007	0.025	1.6
Horizontal Down	Fixed	01	2412	15.97	0.03	0.050	1.007	0.050	1.6
Vertical Front	Fixed	01	2412	15.97	-0.02	0.061	1.007	0.061	1.6
Vertical Back	Fixed	01	2412	15.97	-0.03	0.015	1.007	0.015	1.6
Tip	Fixed	01	2412	15.97	-0.15	0.015	1.007	0.015	1.6
Test Mode: 802.11n(20MHz)- PCB Antenna 0									
Vertical Front	Fixed	01	2412	12.42	0.14	0.022	1.019	0.022	1.6
Test Mode: 802.11n(40MHz)- PCB Antenna 0									
Vertical Front	Fixed	01	2412	11.28	-0.06	0.059	1.052	0.062	1.6
Test Mode: 802.11b- Reverse SMA connector dipole Antenna 1									
Horizontal Up with Antenna 0°	Fixed	01	2412	16.17	-0.15	0.015	1.007	0.015	1.6
Horizontal Down with Antenna 0°	Fixed	01	2412	16.17	-0.08	0.013	1.007	0.013	1.6

Horizontal Up with Antenna 90°	Fixed	01	2412	16.17	0.05	0.016	1.007	0.016	1.6
Test Mode: 802.11n(20MHz)- Reverse SMA connector dipole Antenna 1									
Horizontal Up with Antenna 90°	Fixed	01	2412	10.74	-0.10	0.010	1.062	0.011	1.6
Test Mode: 802.11n(40MHz)- Reverse SMA connector dipole Antenna 1									
Horizontal Up with Antenna 90°	Fixed	01	2412	11.68	-0.02	0.012	1.005	0.012	1.6
Note: when the 1-g SAR is ≤ 0.8 W/kg, testing for low and high channel is optional, refer to KDB 447498.									

SAR MEASUREMENT									
Ambient Temperature (°C) : 21.5 ± 2					Relative Humidity (%): 52				
Liquid Temperature (°C) : 21.0 ± 2					Depth of Liquid (cm):>15				
Product: UltraSky MIMO 11abgn USB Dongle/CPE									
Test Mode: 802.11a- PCB Antenna 0									
Test Position Body (10mm gap)	Antenna Position	Frequency		Frame Power (dBm)	Power Drift (<±0.2)	SAR 1g (W/kg)	Scaling Factor	Scaled SAR 1g (W/kg)	Limit (W/kg)
		Channel	MHz						
Horizontal Up	Fixed	36	5180	12.06	0.08	0.254	1.009	0.256	1.6
Horizontal Down	Fixed	36	5180	12.06	-0.05	0.342	1.009	0.345	1.6
Vertical Front	Fixed	36	5180	12.06	-0.20	0.346	1.009	0.349	1.6
Vertical Back	Fixed	36	5180	12.06	0.17	0.052	1.009	0.052	1.6
Tip	Fixed	36	5180	12.06	-0.15	0.129	1.009	0.130	1.6
Vertical Front	Fixed	48	5240	11.82	-0.10	0.302	1.067	0.322	1.6
Vertical Front	Fixed	149	5745	11.93	-0.12	0.179	1.016	0.182	1.6
Vertical Front	Fixed	157	5785	11.58	0.14	0.142	1.102	0.156	1.6
Vertical Front	Fixed	165	5825	11.43	-0.01	0.108	1.140	0.123	1.6
Test Mode: 802.11n(20MHz)- PCB Antenna 0									
Vertical Front	Fixed	36	5180	12.79	-0.19	0.273	1.050	0.287	1.6
Vertical Front	Fixed	149	5745	11.93	0.20	0.158	1.016	0.161	1.6
Test Mode: 802.11n(40MHz)- PCB Antenna 0									
Vertical Front	Fixed	38	5190	11.63	-0.17	0.193	1.016	0.196	1.6
Vertical Front	Fixed	151	5755	7.43	0.11	0.087	1.016	0.088	1.6
Note: when the 1-g SAR is ≤ 0.8 W/kg, testing for low and high channel is optional, refer to KDB 447498.									

SAR MEASUREMENT									
Ambient Temperature (°C) : 21.5 ± 2					Relative Humidity (%): 52				
Liquid Temperature (°C) : 21.0 ± 2					Depth of Liquid (cm):>15				
Product: UltraSky MIMO 11abgn USB Dongle/CPE									
Test Mode: 802.11a- Reverse SMA connector dipole Antenna 1									
Test Position Head	Antenna Position	Frequency		Frame Power (dBm)	Power Drift (<±0.2)	SAR 1g (W/kg)	Scaling Factor	Scaled SAR 1g (W/kg)	Limit (W/kg)
		Channel	MHz						
Horizontal Up with Antenna 0°	Fixed	36	5180	8.42	0.19	0.041	1.091	0.045	1.6
Horizontal Down with Antenna 0°	Fixed	36	5180	8.42	0.13	0.041	1.091	0.045	1.6
Horizontal Up with Antenna 90°	Fixed	36	5180	8.42	-0.07	0.048	1.091	0.052	1.6
Horizontal Up with Antenna 90°	Fixed	48	5240	8.71	-0.19	0.033	1.021	0.034	1.6
Horizontal Up with Antenna 90°	Fixed	149	5745	12.73	0.05	0.049	1.016	0.050	1.6
Horizontal Up with Antenna 90°	Fixed	157	5785	12.42	-0.04	0.050	1.091	0.055	1.6
Horizontal Up with Antenna 90°	Fixed	165	5825	12.39	0.15	0.040	1.099	0.044	1.6
Test Mode: 802.11n(20MHz)- Reverse SMA connector dipole Antenna 1									
Horizontal Up with Antenna 90°	Fixed	36	5180	9.12	-0.16	0.035	1.117	0.039	1.6
Horizontal Up with Antenna 90°	Fixed	149	5745	9.52	0.18	0.0409	1.019	0.042	1.6
Test Mode: 802.11n(40MHz)- Reverse SMA connector dipole Antenna 1									

Horizontal Up with Antenna 90°	Fixed	38	5190	7.52	-0.02	0.0123	1.019	0.013	1.6
Horizontal Up with Antenna 90°	Fixed	151	5755	8.37	0.19	0.041	1.030	0.042	1.6
Note: when the 1-g SAR is ≤ 0.8 W/kg, testing for low and high channel is optional, refer to KDB 447498.									

9.2. Test position and configuration

1. Batteries are fully charged at the beginning of the SAR measurements.
2. Liquid tissue depth was at least 15.0 cm for all frequencies.
3. The manufacturer has confirmed that the device(s) tested have the same physical, mechanical and thermal characteristics and are within operational tolerances expected for production units.
4. SAR results were scaled to the maximum allowed power to demonstrate compliance per FCC KDB Publication 447498 D01v05r02.
5. There are two antennas on the dongle, specially it has an external antenna. So firstly start with the external not attached and test the dongle according to the procedures found in FCC KDB Publication 447498 D02 , body SAR was performed with the device to phantom separation distance of 5mm. All USB orientations (A: Horizontal-Up, B: Horizontal-Down, C: Vertical-Front, D: Vertical-Back, and E: Tip) were evaluated with 15cm USB cable for extension. And Then attach the external antenna and test the dongle in the following configurations. Test the Horizontal up and Horizontal Down positions of the dongle with the antenna in straight mode (no bend or angle). Then additionally test the Horizontal Up position with the dipole antenna at 90 degrees, perpendicular to the phantom (antenna pointing down and away from the phantom) and SAR testing conditions for this dongle will be satisfied. Please check the SAR test photos.

WLAN Notes:

1. Justification for reduced test configurations for Wi-Fi channels per KDB Publication 248227 D01v01r02 and April 2010 FCC/TCB Meeting Notes for 2.4 GHz Wi-Fi: Highest average RF output power channel for the lowest data rate was selected for SAR evaluation in 802.11b. Other IEEE 802.11 modes (including 802.11g/n) were not investigated since the average output powers over all channels and data rates were not more than 0.25 dB higher than the tested channel in the lowest data rate of IEEE 802.11b mode.
2. When the maximum extrapolated peak SAR of the zoom scan for the maximum output channel is <1.6 W/kg and the reported 1g averaged SAR is <0.8 W/kg, SAR testing on other default channels is not required.

9.3. Simultaneous Transmission Procedures

The dongle has an external antenna, and simultaneous transmission can be difficult to access. So conservatively, we did the standalone SAR with the two antennas separately and add the highest SAR to evaluate the simultaneous SAR.

9.3.1. Simultaneous Transmission Analysis

WIFI 802.11n(20MHz) Antennas Simultaneous Transmission Scenario

Configuration	Mode	PCB Antenna SAR (W/kg)	Dipole Antenna SAR (W/kg)	Σ SAR (W/kg)
Body-Worn	2.4G	0.022	0.011	0.033
Body-Worn	5.2G	0.287	0.039	0.326
Body-Worn	5.8G	0.161	0.042	0.203

WIFI 802.11n(40MHz) Antennas Simultaneous Transmission Scenario

Configuration	Mode	PCB Antenna SAR (W/kg)	Dipole Antenna SAR (W/kg)	Σ SAR (W/kg)
Body-Worn	2.4G	0.062	0.012	0.074
Body-Worn	5.2G	0.196	0.013	0.209
Body-Worn	5.8G	0.088	0.042	0.130

WIFI 802.11a Antennas Simultaneous Transmission Scenario

Configuration	Mode	PCB Antenna SAR (W/kg)	Dipole Antenna SAR (W/kg)	Σ SAR (W/kg)
Body-Worn	5.2G	0.349	0.052	0.401
Body-Worn	5.8G	0.182	0.055	0.237

Appendix A. SAR System Validation Data

Date/Time: 05-05-2014

Test Laboratory: QuieTek Lab

System Check Body 2450MHz

DUT: Dipole 2450 MHz D2450V2; Type: D2450V2

Communication System: CW; Communication System Band: Exported from older format (data unavailable - please correct).; Duty Cycle: 1:1; Frequency: 2450 MHz; Medium parameters used: $f = 2450$ MHz; $\sigma = 1.97$ mho/m; $\epsilon_r = 52.67$; $\rho = 1000$ kg/m³; Phantom section: Flat Section; Input Power=250mW

Ambient temperature (°C): 21.5, Liquid temperature (°C): 21.0

DASY5 Configuration:

- Probe: EX3DV4 - SN3710; ConvF(6.88, 6.88, 6.88); Calibrated: 04/03/2014;
- Sensor-Surface: 4mm (Mechanical Surface Detection)
- Electronics: DAE4 Sn1220; Calibrated: 22/01/2014
- Phantom: SAM1; Type: SAM; Serial: TP1561
- Measurement SW: DASY52, Version 52.8 (1); SEMCAD X Version 14.6.5 (6469)

Configuration/System Check Body 2450MHz/Area Scan (7x11x1): Measurement grid: dx=10mm, dy=10mm

Maximum value of SAR (measured) = 13.3 mW/g

Configuration/System Check Body 2450MHz/Zoom Scan (7x7x7)/Cube 0: Measurement grid: dx=5mm, dy=5mm, dz=5mm, Reference Value = 81.579 V/m; Power Drift = 0.17 dB

Peak SAR (extrapolated) = 25.093 mW/g

SAR(1 g) = 12.1 mW/g; SAR(10 g) = 5.56 mW/g Maximum value of SAR (measured) = 13.9 mW/g

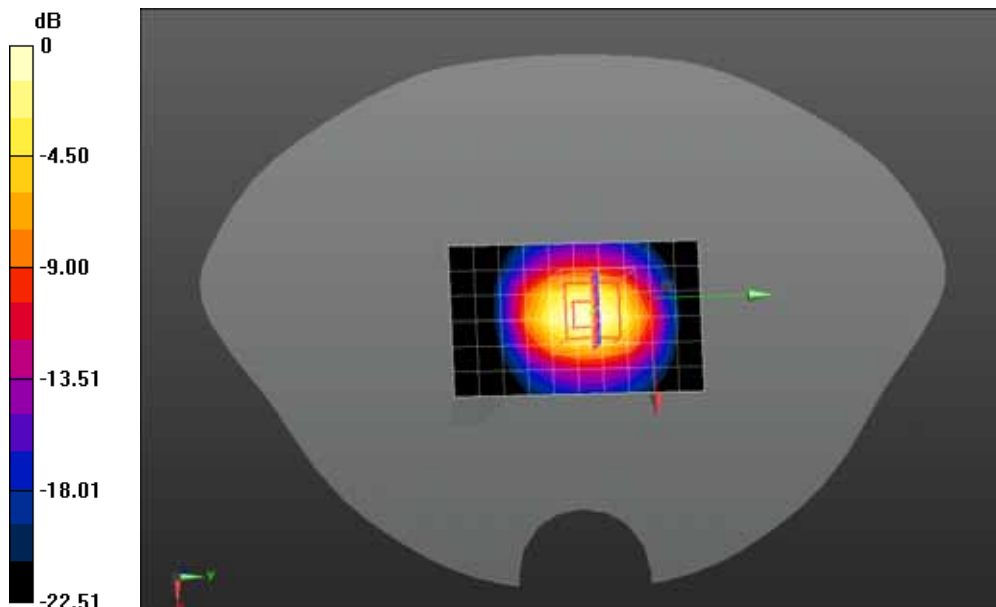

0 dB = 13.9 mW/g = 22.86 dB mW/g

Date/Time: 05-05-2014

Test Laboratory: QuieTek Lab

System Check Body 5200MHz

DUT: Dipole D5GHzV2; Type: D5GHzV2

Communication System: CW; Communication System Band: 5GHz; Duty Cycle: 1:1; Frequency: 5200 MHz;

Medium parameters used: $f = 5200$ MHz; $\sigma = 5.15$ mho/m; $\epsilon_r = 48.94$; $\rho = 1000$ kg/m³ ; Phantom section:

Flat Section ; Input Power=100mW

Ambient temperature (°C): 21.5, Liquid temperature (°C): 21.0

DASY5 Configuration:

- Probe: EX3DV4 - SN3710; ConvF(4.22, 4.22, 4.22); Calibrated: 04/03/2014;
- Sensor-Surface: 2mm (Mechanical Surface Detection)
- Electronics: DAE4 Sn1220; Calibrated: 22/01/2014
- Phantom: SAM2; Type: SAM; Serial: TP1562
- Measurement SW: DASY52, Version 52.8 (1); SEMCAD X Version 14.6.5 (6469)

Configuration/System Check Body 5200MHz/Area Scan (5x8x1): Measurement grid: dx=10mm, dy=10mm

Maximum value of SAR (measured) = 14.0 mW/g

Configuration/System Check Body 5200MHz/Zoom Scan (8x8x10)/Cube 0: Measurement grid: dx=4mm, dy=4mm, dz=2.5mm, Reference Value = 41.965 V/m; Power Drift = 0.08 dB

Peak SAR (extrapolated) = 28.902 mW/g

SAR(1 g) = 7.67 mW/g; SAR(10 g) = 2.16 mW/g Maximum value of SAR (measured) = 15.2 mW/g

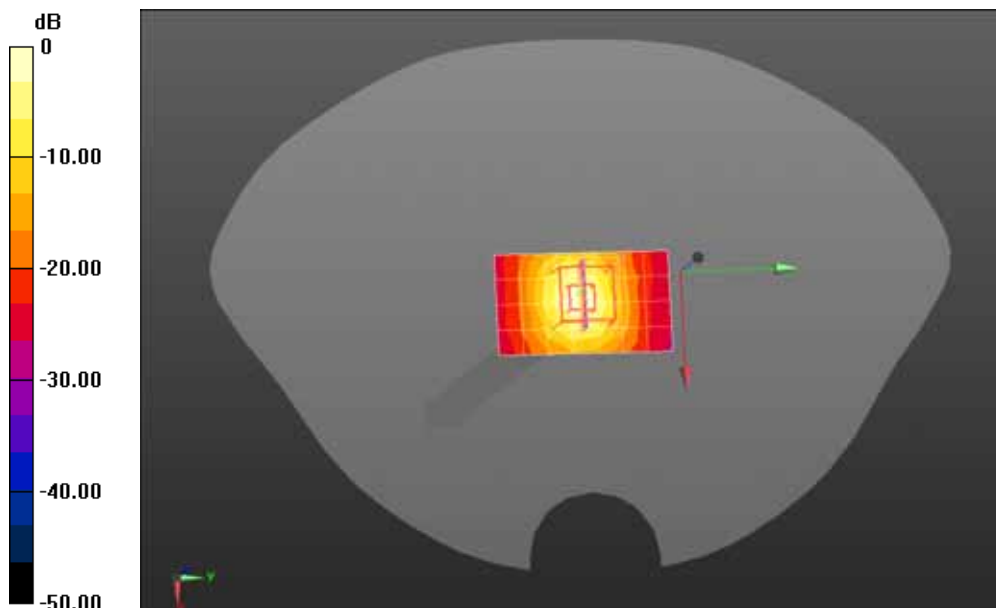

0 dB = 15.2 mW/g = 23.64 dB mW/g

Date/Time: 05-05-2014

Test Laboratory: QuieTek Lab

System Check Body 5800MHz

DUT: Dipole D5GHzV2; Type: D5GHzV2

Communication System: CW; Communication System Band: 5GHz; Duty Cycle: 1:1; Frequency: 5800 MHz;

Medium parameters used: $f = 5800 \text{ MHz}$; $\sigma = 6.04 \text{ mho/m}$; $\epsilon_r = 47.29$; $\rho = 1000 \text{ kg/m}^3$; Phantom section:

Flat Section ; Input Power=100mW

Ambient temperature ($^{\circ}\text{C}$): 21.5, Liquid temperature ($^{\circ}\text{C}$): 21.0

DASY5 Configuration:

- Probe: EX3DV4 - SN3710; ConvF(3.91, 3.91, 3.91); Calibrated: 04/03/2014;
- Sensor-Surface: 2mm (Mechanical Surface Detection)
- Electronics: DAE4 Sn1220; Calibrated: 22/01/2014
- Phantom: SAM2; Type: SAM; Serial: TP1562
- Measurement SW: DASY52, Version 52.8 (1); SEMCAD X Version 14.6.5 (6469)

Configuration/System Check Body 5800MHz/Area Scan (5x8x1): Measurement grid: dx=10mm, dy=10mm

Maximum value of SAR (measured) = 13.2 mW/g

Configuration/System Check Body 5800MHz/Zoom Scan (8x8x10)/Cube 0: Measurement grid: dx=4mm, dy=4mm, dz=2.5mm, Reference Value = 38.530 V/m; Power Drift = 0.04 dB

Peak SAR (extrapolated) = 31.046 mW/g

SAR(1 g) = 7.51 mW/g; SAR(10 g) = 2.07 mW/g Maximum value of SAR (measured) = 15.1 mW/g

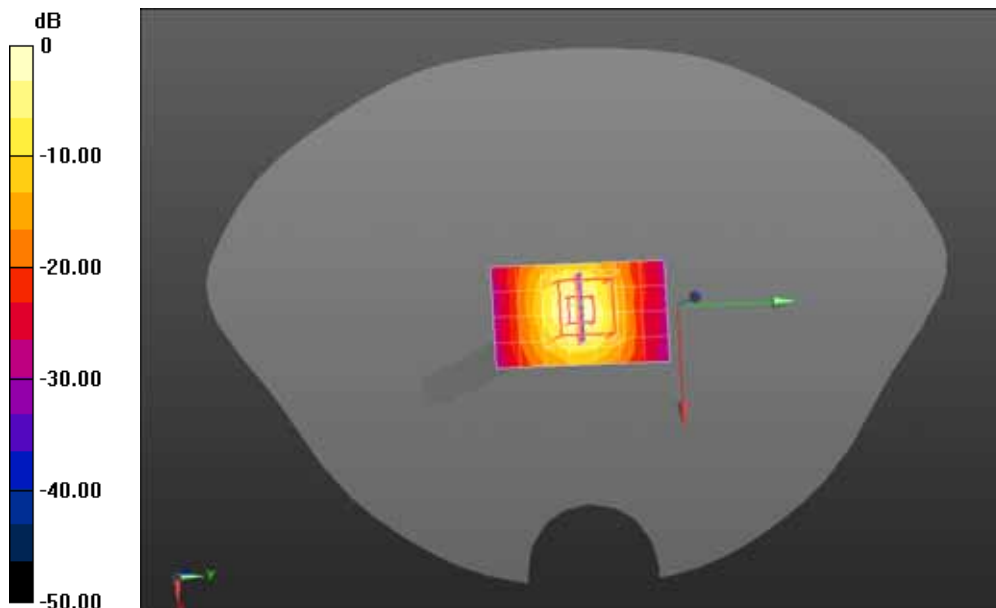

0 dB = 15.1 mW/g = 23.58 dB mW/g

Appendix B. SAR measurement Data

Date/Time: 05-05-2014

Test Laboratory: QuieTek Lab

802.11b 2412MHz-Horizontal Up (PCB Antenna)

DUT: UltraSky MIMO 11abgn USB Dongle/CPE; Type: M27, M27C5, M27C5-16

Communication System: UID 0, Wi-Fi (0); Communication System Band: 802.11b; Duty Cycle: 1:1.0;

Frequency: 2412 MHz; Medium parameters used: $f = 2412$ MHz; $\sigma = 1.95$ S/m; $\epsilon_r = 52.18$; $\rho = 1000$ kg/m³ ;

Phantom section: Flat Section

Ambient temperature (°C): 21.5, Liquid temperature (°C): 21.0

DASY5 Configuration:

- Probe: EX3DV4 - SN3710; ConvF(6.88, 6.88, 6.88); Calibrated: 04/03/2014;
- Sensor-Surface: 4mm (Mechanical Surface Detection)
- Electronics: DAE4 Sn1220; Calibrated: 22/01/2014
- Phantom: SAM2; Type: SAM; Serial: TP1562
- Measurement SW: DASY52, Version 52.8 (7); SEMCAD X Version 14.6.10 (7164)

Configuration/802.11b 2412MHz-Horizontal Up/Area Scan (7x10x1): Measurement grid: dx=10mm, dy=10mm, Maximum value of SAR (measured) = 0.0289 W/kg

Configuration/802.11b 2412MHz-Horizontal Up/Zoom Scan (5x5x7)/Cube 0: Measurement grid: dx=8mm, dy=8mm, dz=5mm, Reference Value = 3.289 V/m; Power Drift = -0.13 dB

Peak SAR (extrapolated) = 0.0410 W/kg

SAR(1 g) = 0.025 W/kg; SAR(10 g) = 0.017 W/kg Maximum value of SAR (measured) = 0.0267 W/kg

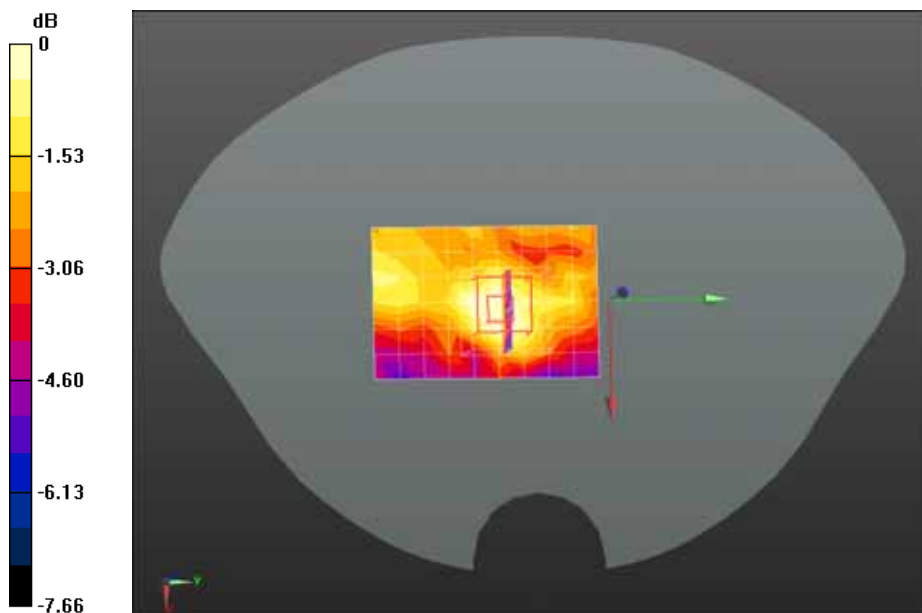

0 dB = 0.0267 W/kg = -15.73 dBW/kg

Date/Time: 05-05-2014

Test Laboratory: QuieTek Lab

802.11b 2412MHz-Horizontal Down (PCB Antenna)

DUT: UltraSky MIMO 11abgn USB Dongle/CPE; Type: M27, M27C5, M27C5-16

Communication System: UID 0, Wi-Fi (0); Communication System Band: 802.11b; Duty Cycle: 1:1.0;

Frequency: 2412 MHz; Medium parameters used: $f = 2412$ MHz; $\sigma = 1.95$ S/m; $\epsilon_r = 52.18$; $\rho = 1000$ kg/m³ ;

Phantom section: Flat Section

Ambient temperature (°C): 21.5, Liquid temperature (°C): 21.0

DASY5 Configuration:

- Probe: EX3DV4 - SN3710; ConvF(6.88, 6.88, 6.88); Calibrated: 04/03/2014;
- Sensor-Surface: 4mm (Mechanical Surface Detection)
- Electronics: DAE4 Sn1220; Calibrated: 22/01/2014
- Phantom: SAM2; Type: SAM; Serial: TP1562
- Measurement SW: DASY52, Version 52.8 (7); SEMCAD X Version 14.6.10 (7164)

Configuration/802.11b 2412MHz-Horizontal Down/Area Scan (7x10x1): Measurement grid: dx=10mm, dy=10mm

Maximum value of SAR (measured) = 0.0540 W/kg

Configuration/802.11b 2412MHz-Horizontal Down/Zoom Scan (5x5x7)/Cube 0: Measurement grid: dx=8mm, dy=8mm, dz=5mm, Reference Value = 3.644 V/m; Power Drift = 0.03 dB

Peak SAR (extrapolated) = 0.110 W/kg

SAR(1 g) = 0.050 W/kg; SAR(10 g) = 0.026 W/kg Maximum value of SAR (measured) = 0.0551 W/kg

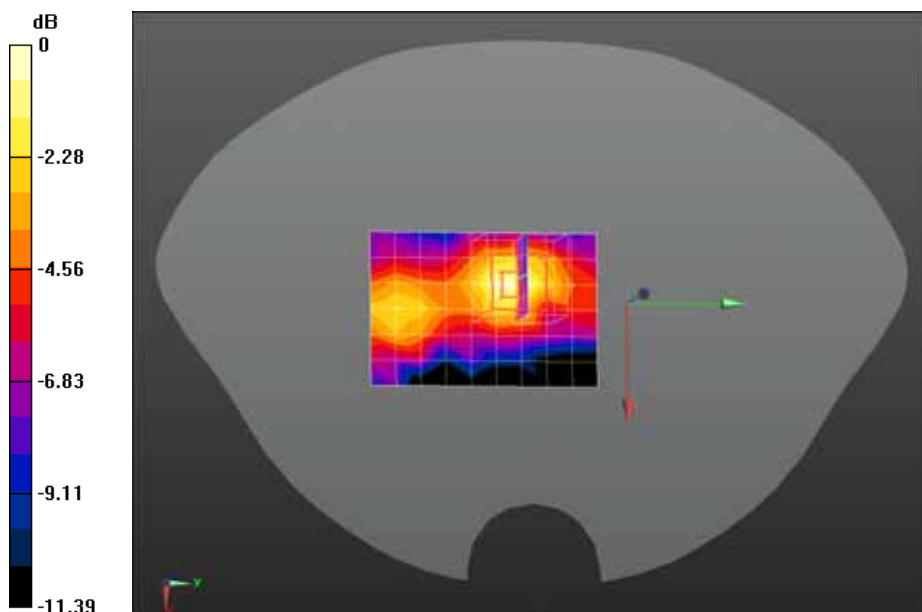

0 dB = 0.0551 W/kg = -12.59 dBW/kg

Date/Time: 05-05-2014

Test Laboratory: QuieTek Lab

802.11b 2412MHz-Vertical Front (PCB Antenna)

DUT: UltraSky MIMO 11abgn USB Dongle/CPE; Type: M27, M27C5, M27C5-16

Communication System: UID 0, Wi-Fi (0); Communication System Band: 802.11b; Duty Cycle: 1:1.0;

Frequency: 2412 MHz; Medium parameters used: $f = 2412$ MHz; $\sigma = 1.95$ S/m; $\epsilon_r = 52.18$; $\rho = 1000$ kg/m³ ;

Phantom section: Flat Section

Ambient temperature (°C): 21.5, Liquid temperature (°C): 21.0

DASY5 Configuration:

- Probe: EX3DV4 - SN3710; ConvF(6.88, 6.88, 6.88); Calibrated: 04/03/2014;
- Sensor-Surface: 4mm (Mechanical Surface Detection)
- Electronics: DAE4 Sn1220; Calibrated: 22/01/2014
- Phantom: SAM2; Type: SAM; Serial: TP1562
- Measurement SW: DASY52, Version 52.8 (7); SEMCAD X Version 14.6.10 (7164)

Configuration/802.11b 2412MHz-Vertical Front/Area Scan (7x10x1): Measurement grid: dx=10mm, dy=10mm

Maximum value of SAR (measured) = 0.0661 W/kg

Configuration/802.11b 2412MHz-Vertical Front/Zoom Scan (5x5x7)/Cube 0: Measurement grid:

dx=8mm, dy=8mm, dz=5mm, Reference Value = 4.702 V/m; Power Drift = -0.02 dB

Peak SAR (extrapolated) = 0.127 W/kg

SAR(1 g) = 0.061 W/kg; SAR(10 g) = 0.031 W/kg Maximum value of SAR (measured) = 0.0674 W/kg

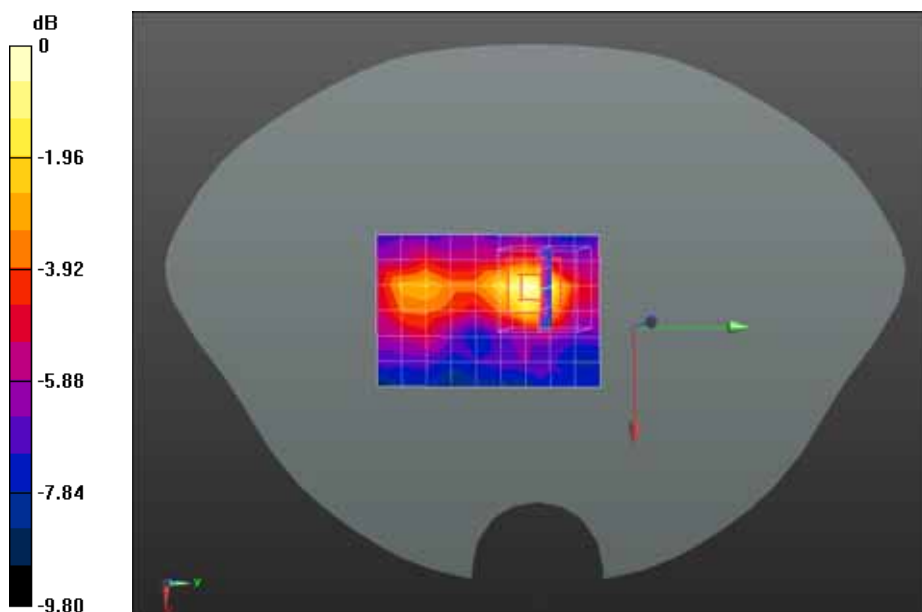

0 dB = 0.0674 W/kg = -11.71 dBW/kg

Z-Axis Plot

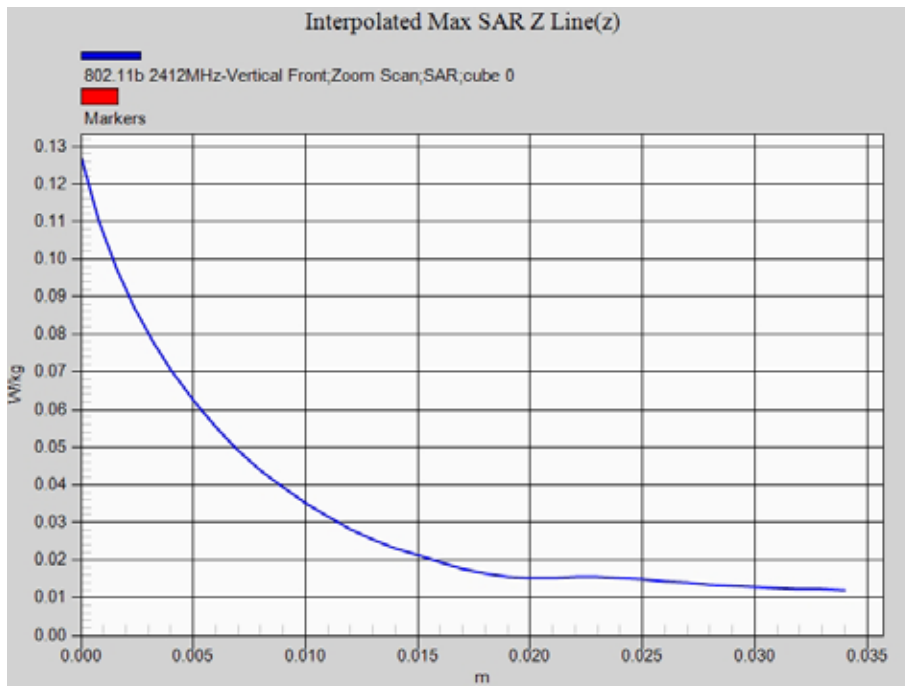

Date/Time: 05-05-2014

Test Laboratory: QuieTek Lab

802.11b 2412MHz-Vertical Back (PCB Antenna)

DUT: UltraSky MIMO 11abgn USB Dongle/CPE; Type: M27, M27C5, M27C5-16

Communication System: UID 0, Wi-Fi (0); Communication System Band: 802.11b; Duty Cycle: 1:1.0;

Frequency: 2412 MHz; Medium parameters used: $f = 2412 \text{ MHz}$; $\sigma = 1.95 \text{ S/m}$; $\epsilon_r = 52.18$; $\rho = 1000 \text{ kg/m}^3$;

Phantom section: Flat Section

Ambient temperature (°C): 21.5, Liquid temperature (°C): 21.0

DASY5 Configuration:

- Probe: EX3DV4 - SN3710; ConvF(6.88, 6.88, 6.88); Calibrated: 04/03/2014;
- Sensor-Surface: 4mm (Mechanical Surface Detection)
- Electronics: DAE4 Sn1220; Calibrated: 22/01/2014
- Phantom: SAM2; Type: SAM; Serial: TP1562
- Measurement SW: DASY52, Version 52.8 (7); SEMCAD X Version 14.6.10 (7164)

Configuration/802.11b 2412MHz-Vertical Back/Area Scan (7x10x1): Measurement grid: dx=10mm, dy=10mm

Maximum value of SAR (measured) = 0.0128 W/kg

Configuration/802.11b 2412MHz-Vertical Back/Zoom Scan (5x5x7)/Cube 0: Measurement grid:

dx=8mm, dy=8mm, dz=5mm, Reference Value = 2.301 V/m; Power Drift = -0.03 dB

Peak SAR (extrapolated) = 0.0240 W/kg

SAR(1 g) = 0.015 W/kg; SAR(10 g) = 0.011 W/kg Maximum value of SAR (measured) = 0.0172 W/kg

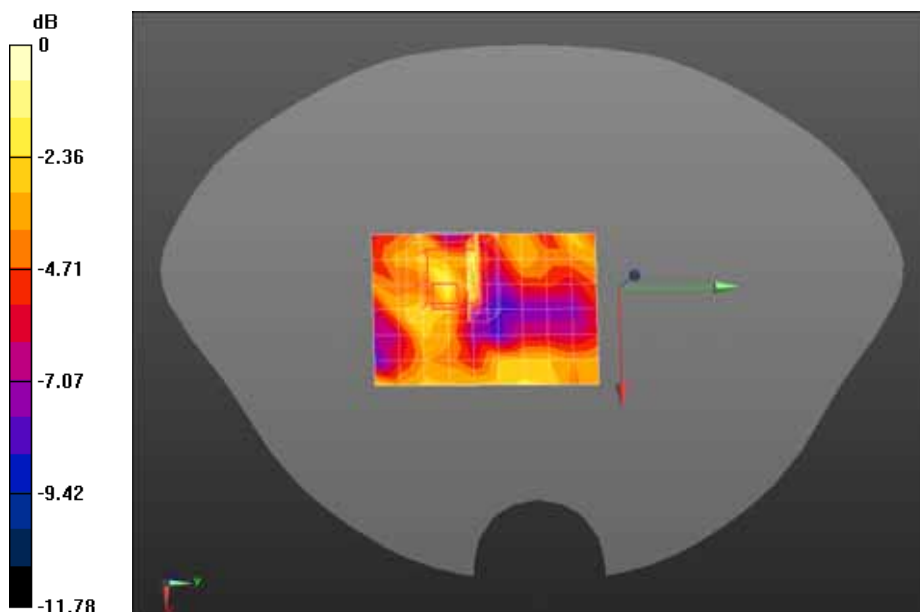

0 dB = 0.0172 W/kg = -17.64 dBW/kg

Date/Time: 05-05-2014

Test Laboratory: QuieTek Lab

802.11b 2412MHz-Tip (PCB Antenna)

DUT: UltraSky MIMO 11abgn USB Dongle/CPE; Type: M27, M27C5, M27C5-16

Communication System: UID 0, Wi-Fi (0); Communication System Band: 802.11b; Duty Cycle: 1:1.0;

Frequency: 2412 MHz; Medium parameters used: $f = 2412$ MHz; $\sigma = 1.95$ S/m; $\epsilon_r = 52.18$; $\rho = 1000$ kg/m³ ;

Phantom section: Flat Section

Ambient temperature (°C): 21.5, Liquid temperature (°C): 21.0

DASY5 Configuration:

- Probe: EX3DV4 - SN3710; ConvF(6.88, 6.88, 6.88); Calibrated: 04/03/2014;
- Sensor-Surface: 4mm (Mechanical Surface Detection)
- Electronics: DAE4 Sn1220; Calibrated: 22/01/2014
- Phantom: SAM2; Type: SAM; Serial: TP1562
- Measurement SW: DASY52, Version 52.8 (7); SEMCAD X Version 14.6.10 (7164)

Configuration/802.11b 2412MHz-Tip/Area Scan (7x10x1): Measurement grid: dx=10mm, dy=10mm

Maximum value of SAR (measured) = 0.0148 W/kg

Configuration/802.11b 2412MHz-Tip/Zoom Scan (5x5x7)/Cube 0: Measurement grid: dx=8mm, dy=8mm, dz=5mm, Reference Value = 3.267 V/m; Power Drift = -0.15 dB

Peak SAR (extrapolated) = 0.0240 W/kg

SAR(1 g) = 0.015 W/kg; SAR(10 g) = 0.00957 W/kg Maximum value of SAR (measured) = 0.0174 W/kg

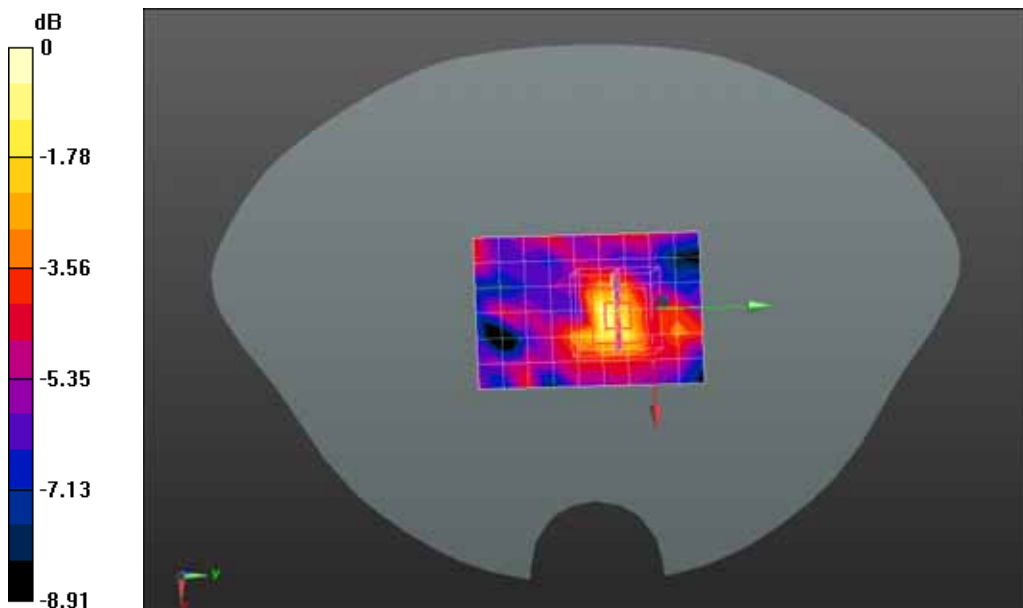

0 dB = 0.0174 W/kg = -17.59 dBW/kg

Date/Time: 05-05-2014

Test Laboratory: QuieTek Lab

802.11n(20) 2462MHz-Vertical Front (PCB Antenna)

DUT: USB Dongle; Type: M27

Communication System: UID 0, Wi-Fi (0); Communication System Band: 802.11n(20MHz); Duty Cycle: 1:1.0; Frequency: 2462 MHz; Medium parameters used: $f = 2462$ MHz; $\sigma = 2.03$ S/m; $\epsilon_r = 52.02$; $\rho = 1000$ kg/m³ ; Phantom section: Flat Section

Ambient temperature (°C): 21.5, Liquid temperature (°C): 21.0

DASY5 Configuration:

- Probe: EX3DV4 - SN3710; ConvF(6.88, 6.88, 6.88); Calibrated: 04/03/2014;
- Sensor-Surface: 4mm (Mechanical Surface Detection)
- Electronics: DAE4 Sn1220; Calibrated: 22/01/2014
- Phantom: SAM2; Type: SAM; Serial: TP1562
- Measurement SW: DASY52, Version 52.8 (7); SEMCAD X Version 14.6.10 (7164)

Configuration/802.11n(20) 2462MHz-Vertical Front/Area Scan (7x10x1): Measurement grid: dx=10mm, dy=10mm

Maximum value of SAR (measured) = 0.0245 W/kg

Configuration/802.11n(20) 2462MHz-Vertical Front/Zoom Scan (5x5x7)/Cube 0: Measurement grid: dx=8mm, dy=8mm, dz=5mm, Reference Value = 2.799 V/m; Power Drift = 0.14 dB

Peak SAR (extrapolated) = 0.0260 W/kg

SAR(1 g) = 0.022 W/kg; SAR(10 g) = 0.015 W/kg Maximum value of SAR (measured) = 0.0231 W/kg

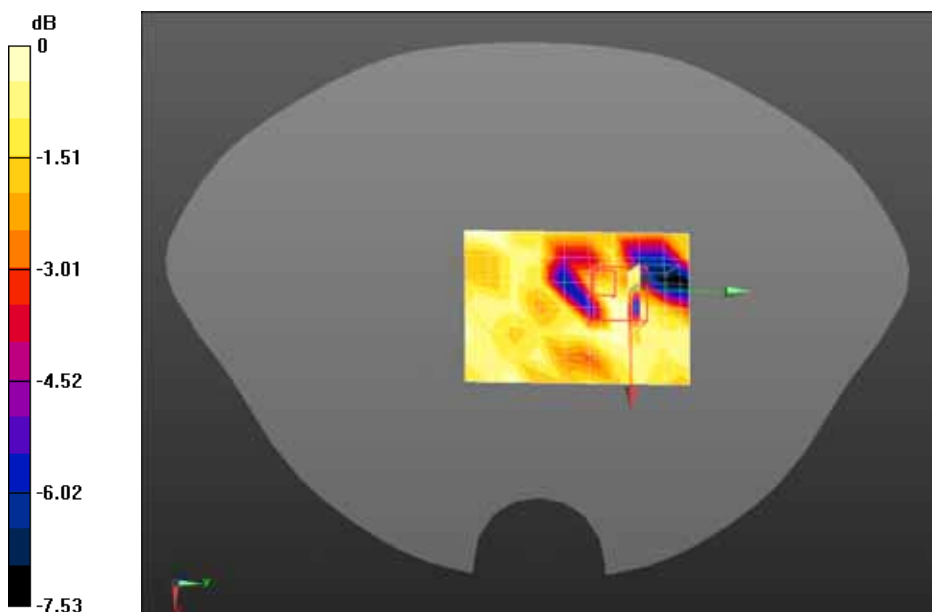

0 dB = 0.0231 W/kg = -16.36 dBW/kg

Date/Time: 05-05-2014

Test Laboratory: QuieTek Lab

802.11n(40)2422MHz-Vertical Front (PCB Antenna)

DUT: USB Dongle; Type: M27

Communication System: UID 0, Wi-Fi (0); Communication System Band: 802.11n(40MHz); Duty Cycle: 1:1.0; Frequency: 2422 MHz; Medium parameters used (interpolated): $f = 2422$ MHz; $\sigma = 1.97$ S/m; $\epsilon_r = 52.15$; $\rho = 1000$ kg/m³ ; Phantom section: Flat Section

Ambient temperature (°C): 21.5, Liquid temperature (°C): 21.0

DASY5 Configuration:

- Probe: EX3DV4 - SN3710; ConvF(6.88, 6.88, 6.88); Calibrated: 04/03/2014;
- Sensor-Surface: 4mm (Mechanical Surface Detection)
- Electronics: DAE4 Sn1220; Calibrated: 22/01/2014
- Phantom: SAM2; Type: SAM; Serial: TP1562
- Measurement SW: DASY52, Version 52.8 (7); SEMCAD X Version 14.6.10 (7164)

Configuration/802.11n(40) 2422MHz-Vertical Front/Area Scan (7x10x1): Measurement grid: dx=10mm, dy=10mm

Maximum value of SAR (measured) = 0.0646 W/kg

Configuration/802.11n(40) 2422MHz-Vertical Front/Zoom Scan (5x5x7)/Cube 0: Measurement grid: dx=8mm, dy=8mm, dz=5mm, Reference Value = 5.182 V/m; Power Drift = -0.06 dB

Peak SAR (extrapolated) = 0.0950 W/kg

SAR(1 g) = 0.059 W/kg; SAR(10 g) = 0.036 W/kg Maximum value of SAR (measured) = 0.0670 W/kg

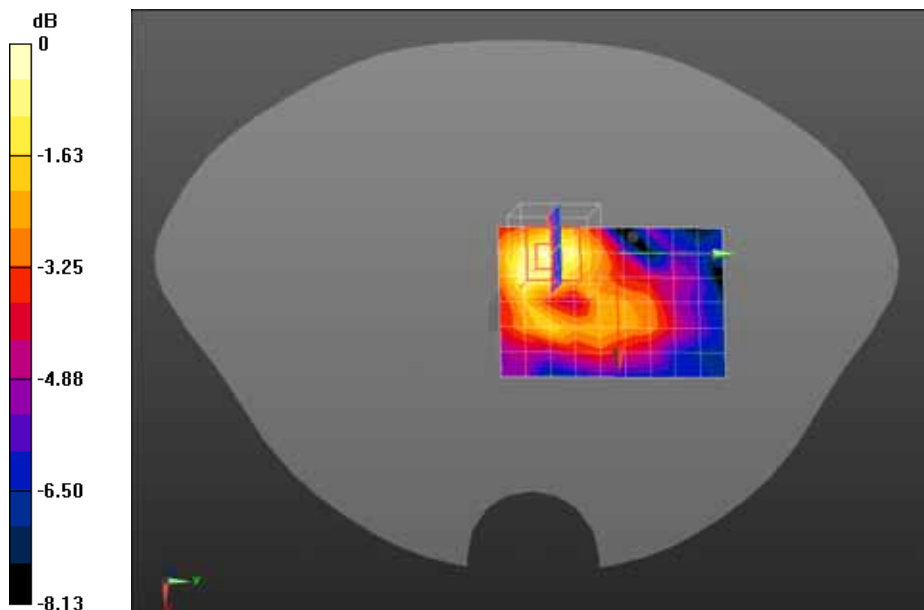

0 dB = 0.0670 W/kg = -11.74 dBW/kg

Date/Time: 05-05-2014

Test Laboratory: QuieTek Lab

802.11b 2412MHz-Horizontal Up (Dipole Antenna at 0°)

DUT: UltraSky MIMO 11abgn USB Dongle/CPE; Type: M27, M27C5, M27C5-16

Communication System: UID 0, Wi-Fi (0); Communication System Band: 802.11b; Duty Cycle: 1:1.0;

Frequency: 2412 MHz; Medium parameters used: $f = 2412$ MHz; $\sigma = 1.95$ S/m; $\epsilon_r = 52.18$; $\rho = 1000$ kg/m³ ;

Phantom section: Flat Section

Ambient temperature (°C): 21.5, Liquid temperature (°C): 21.0

DASY5 Configuration:

- Probe: EX3DV4 - SN3710; ConvF(6.88, 6.88, 6.88); Calibrated: 04/03/2014;
- Sensor-Surface: 4mm (Mechanical Surface Detection)
- Electronics: DAE4 Sn1220; Calibrated: 22/01/2014
- Phantom: SAM2; Type: SAM; Serial: TP1562
- Measurement SW: DASY52, Version 52.8 (7); SEMCAD X Version 14.6.10 (7164)

Configuration/802.11b 2412MHz-Horizontal Up/Area Scan (7x11x1): Measurement grid: dx=10mm, dy=10mm

Maximum value of SAR (measured) = 0.0158 W/kg

Configuration/802.11b 2412MHz-Horizontal Up/Zoom Scan (5x5x7)/Cube 0: Measurement grid: dx=8mm, dy=8mm, dz=5mm, Reference Value = 2.763 V/m; Power Drift = -0.15 dB

Peak SAR (extrapolated) = 0.0250 W/kg

SAR(1 g) = 0.015 W/kg; SAR(10 g) = 0.014 W/kg Maximum value of SAR (measured) = 0.0192 W/kg

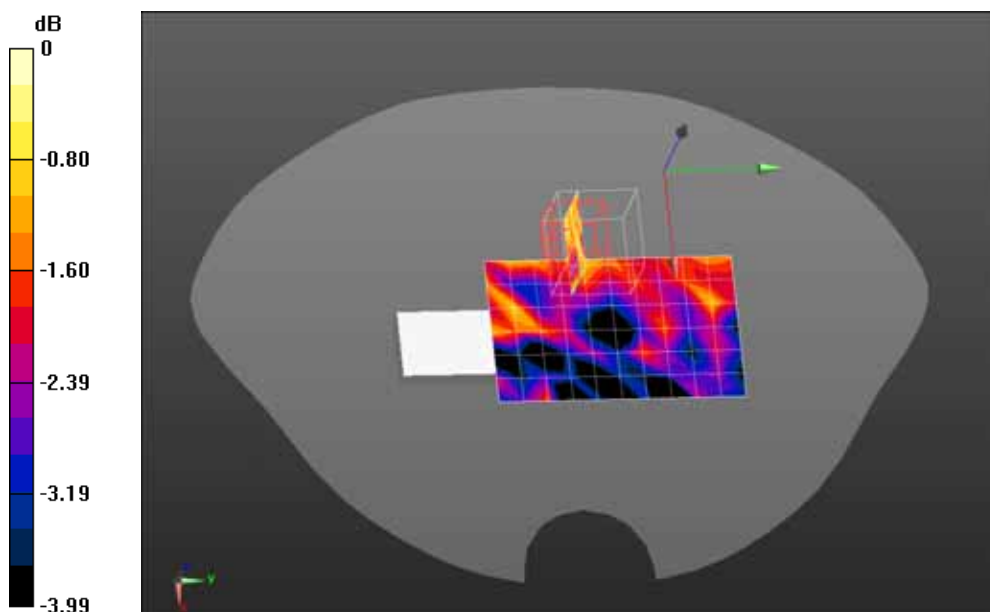

0 dB = 0.0192 W/kg = -17.17 dBW/kg

Date/Time: 05-05-2014

Test Laboratory: QuieTek Lab

802.11b 2412MHz-Horizontal Down (Dipole Antenna at 0°)

DUT: UltraSky MIMO 11abgn USB Dongle/CPE; Type: M27, M27C5, M27C5-16

Communication System: UID 0, Wi-Fi (0); Communication System Band: 802.11b; Duty Cycle: 1:1.0;

Frequency: 2412 MHz; Medium parameters used: $f = 2412$ MHz; $\sigma = 1.95$ S/m; $\epsilon_r = 52.18$; $\rho = 1000$ kg/m³ ;

Phantom section: Flat Section

Ambient temperature (°C): 21.5, Liquid temperature (°C): 21.0

DASY5 Configuration:

- Probe: EX3DV4 - SN3710; ConvF(6.88, 6.88, 6.88); Calibrated: 04/03/2014;
- Sensor-Surface: 4mm (Mechanical Surface Detection)
- Electronics: DAE4 Sn1220; Calibrated: 22/01/2014
- Phantom: SAM2; Type: SAM; Serial: TP1562
- Measurement SW: DASY52, Version 52.8 (7); SEMCAD X Version 14.6.10 (7164)

Configuration/802.11b 2412MHz-Horizontal Down/Area Scan (7x11x1): Measurement grid: dx=10mm, dy=10mm

Maximum value of SAR (measured) = 0.0181 W/kg

Configuration/802.11b 2412MHz-Horizontal Down/Zoom Scan (5x5x7)/Cube 0: Measurement grid: dx=8mm, dy=8mm, dz=5mm, Reference Value = 2.500 V/m; Power Drift = -0.08 dB

Peak SAR (extrapolated) = 0.0350 W/kg

SAR(1 g) = 0.013 W/kg; SAR(10 g) = 0.011 W/kg Maximum value of SAR (measured) = 0.0162 W/kg

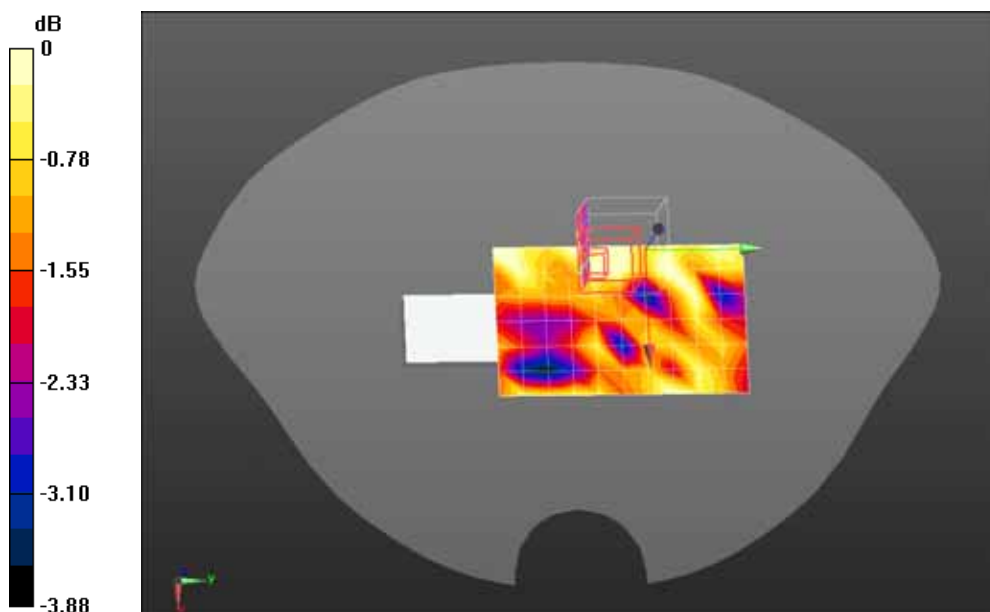

0 dB = 0.0162 W/kg = -17.90 dBW/kg

Date/Time: 05-05-2014

Test Laboratory: QuieTek Lab

802.11b 2412MHz-Horizontal Up (Dipole Antenna at 90°)

DUT: UltraSky MIMO 11abgn USB Dongle/CPE; Type: M27, M27C5, M27C5-16

Communication System: UID 0, Wi-Fi (0); Communication System Band: 802.11b; Duty Cycle: 1:1.0;

Frequency: 2412 MHz; Medium parameters used: $f = 2412 \text{ MHz}$; $\sigma = 1.95 \text{ S/m}$; $\epsilon_r = 52.18$; $\rho = 1000 \text{ kg/m}^3$;

Phantom section: Flat Section

Ambient temperature (°C): 21.5, Liquid temperature (°C): 21.0

DASY5 Configuration:

- Probe: EX3DV4 - SN3710; ConvF(6.88, 6.88, 6.88); Calibrated: 04/03/2014;
- Sensor-Surface: 4mm (Mechanical Surface Detection)
- Electronics: DAE4 Sn1220; Calibrated: 22/01/2014
- Phantom: SAM2; Type: SAM; Serial: TP1562
- Measurement SW: DASY52, Version 52.8 (7); SEMCAD X Version 14.6.10 (7164)

Configuration/802.11b 2412MHz-Horizontal Up/Area Scan (7x11x1): Measurement grid: dx=10mm, dy=10mm

Maximum value of SAR (measured) = 0.0181 W/kg

Configuration/802.11b 2412MHz-Horizontal Up/Zoom Scan (5x5x7)/Cube 0: Measurement grid:

dx=8mm, dy=8mm, dz=5mm, Reference Value = 2.215 V/m; Power Drift = 0.05 dB

Peak SAR (extrapolated) = 0.0280 W/kg

SAR(1 g) = 0.016 W/kg; SAR(10 g) = 0.012 W/kg Maximum value of SAR (measured) = 0.0170 W/kg

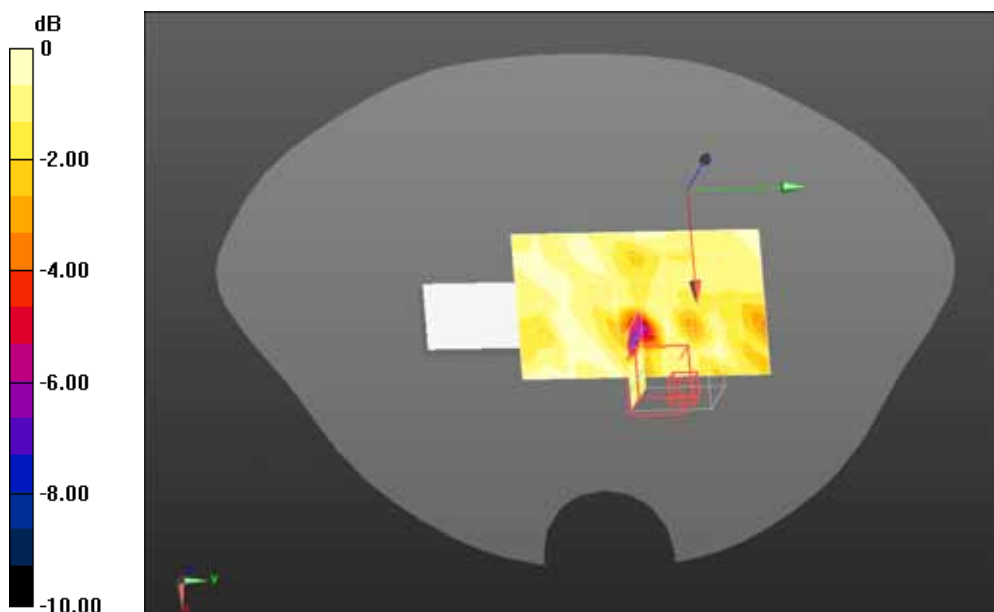

0 dB = 0.0170 W/kg = -17.70 dBW/kg

Z-Axis Plot

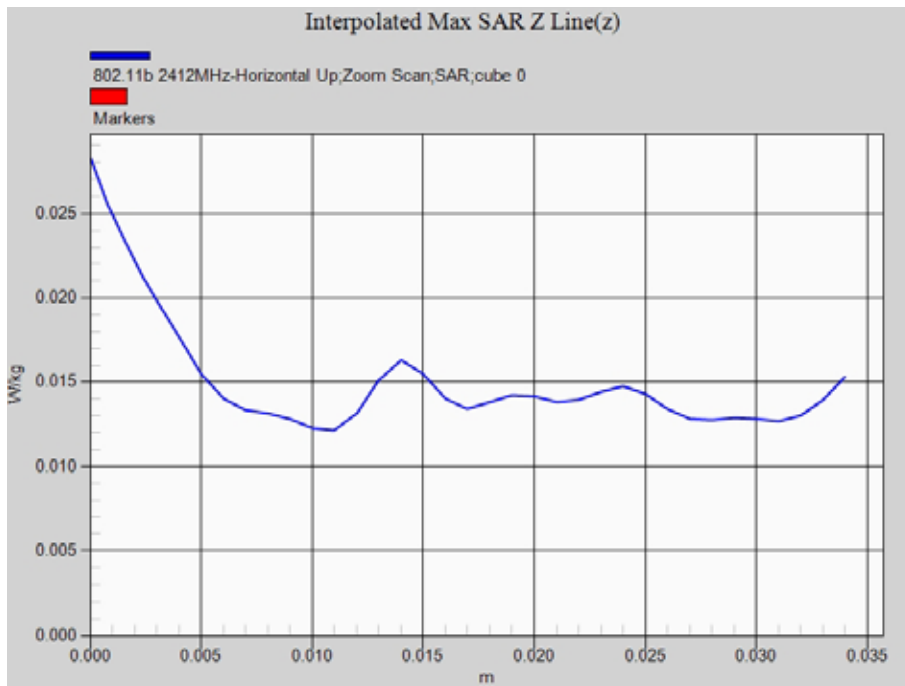

Date/Time: 05-05-2014

Test Laboratory: QuieTek Lab

802.11n(20) 2412MHz-Horizontal Up-90 (Dipole Antenna at 90°)

DUT: USB Dongle; Type: M27

Communication System: UID 0, Wi-Fi (0); Communication System Band: 802.11n(20MHz); Duty Cycle: 1:1.0; Frequency: 2412 MHz; Medium parameters used: $f = 2412$ MHz; $\sigma = 1.95$ S/m; $\epsilon_r = 52.18$; $\rho = 1000$ kg/m³; Phantom section: Flat Section

Ambient temperature (°C): 21.5, Liquid temperature (°C): 21.0

DASY5 Configuration:

- Probe: EX3DV4 - SN3710; ConvF(6.88, 6.88, 6.88); Calibrated: 04/03/2014;
- Sensor-Surface: 4mm (Mechanical Surface Detection)
- Electronics: DAE4 Sn1220; Calibrated: 22/01/2014
- Phantom: SAM2; Type: SAM; Serial: TP1562
- Measurement SW: DASY52, Version 52.8 (7); SEMCAD X Version 14.6.10 (7164)

Configuration/802.11n(20) 2412MHz-Horizontal UP-90/Area Scan (11x11x1): Measurement grid:

dx=10mm, dy=10mm

Maximum value of SAR (measured) = 0.0149 W/kg

Configuration/802.11n(20) 2412MHz-Horizontal UP-90/Zoom Scan (5x5x7)/Cube 0: Measurement grid:

dx=8mm, dy=8mm, dz=5mm, Reference Value = 2.214 V/m; Power Drift = -0.10 dB

Peak SAR (extrapolated) = 0.0150 W/kg

SAR(1 g) = 0.010 W/kg; SAR(10 g) = 0.00907 W/kg Maximum value of SAR (measured) = 0.0126 W/kg

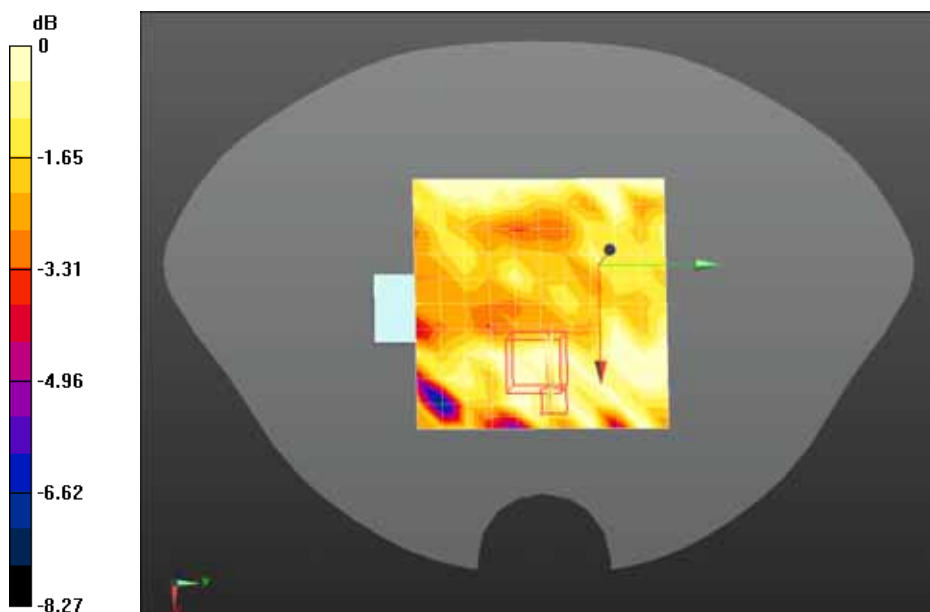

0 dB = 0.0126 W/kg = -19.00 dBW/kg

Date/Time: 05-05-2014

Test Laboratory: QuieTek Lab

802.11n(40) 2422MHz-Horizontal Up-90 (Dipole Antenna at 90°)

DUT: USB Dongle; Type: M27

Communication System: UID 0, Wi-Fi (0); Communication System Band: 802.11n(40MHz); Duty Cycle: 1:1.0; Frequency: 2422 MHz; Medium parameters used (interpolated): $f = 2422 \text{ MHz}$; $\sigma = 1.97 \text{ S/m}$; $\epsilon_r = 52.15$; $\rho = 1000 \text{ kg/m}^3$; Phantom section: Flat Section

Ambient temperature (°C): 21.5, Liquid temperature (°C): 21.0

DASY5 Configuration:

- Probe: EX3DV4 - SN3710; ConvF(6.88, 6.88, 6.88); Calibrated: 04/03/2014;
- Sensor-Surface: 4mm (Mechanical Surface Detection)
- Electronics: DAE4 Sn1220; Calibrated: 22/01/2014
- Phantom: SAM2; Type: SAM; Serial: TP1562
- Measurement SW: DASY52, Version 52.8 (7); SEMCAD X Version 14.6.10 (7164)

Configuration/802.11n(40) 2422MHz-Horizontal Up-90/Area Scan (7x11x1): Measurement grid:

$dx=10\text{mm}$, $dy=10\text{mm}$

Maximum value of SAR (measured) = 0.0138 W/kg

Configuration/802.11n(40) 2422MHz-Horizontal Up-90/Zoom Scan (5x5x7)/Cube 0: Measurement grid:

$dx=8\text{mm}$, $dy=8\text{mm}$, $dz=5\text{mm}$, Reference Value = 2.334 V/m; Power Drift = -0.02 dB

Peak SAR (extrapolated) = 0.0220 W/kg

SAR(1 g) = 0.012 W/kg; SAR(10 g) = 0.00984 W/kg Maximum value of SAR (measured) = 0.0134 W/kg

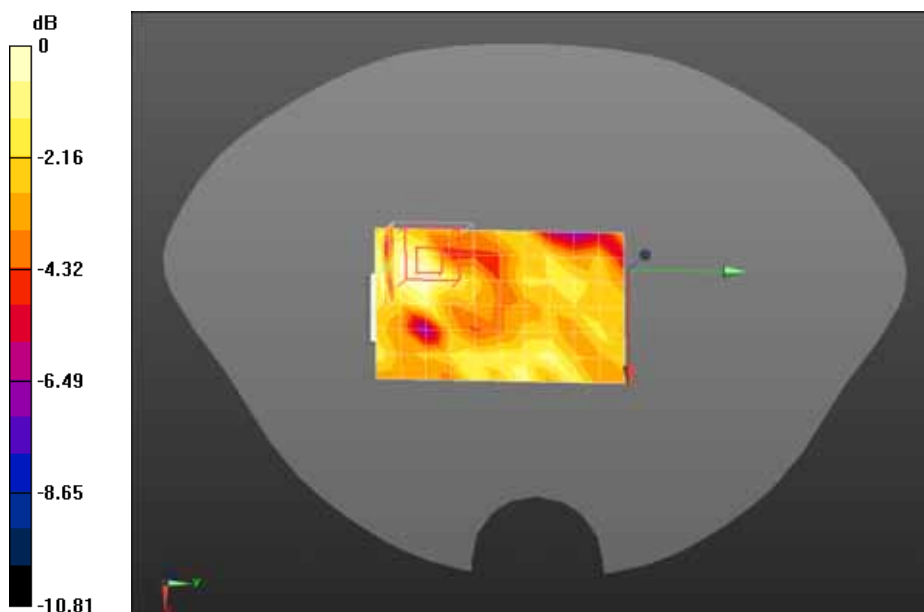

0 dB = 0.0134 W/kg = -18.73 dBW/kg

Date/Time: 05-05-2014

Test Laboratory: QuieTek Lab

802.11a 5180MHz-Horizontal Up (PCB Antenna)

DUT: UltraSky MIMO 11abgn USB Dongle/CPE; Type: M27, M27C5, M27C5-16

Communication System: UID 0, CW; Communication System Band: 5GHz(5000.0-6000.0MHz); Duty Cycle: 1:1.0; Frequency: 5180 MHz; Medium parameters used: $f = 5180$ MHz; $\sigma = 5.28$ S/m; $\epsilon_r = 48.71$; $\rho = 1000$ kg/m³ ; Phantom section: Flat Section

Ambient temperature (°C): 21.5, Liquid temperature (°C): 21.0

DASY5 Configuration:

- Probe: EX3DV4 - SN3710; ConvF(4.22, 4.22, 4.22); Calibrated: 04/03/2014;
- Sensor-Surface: 2mm (Mechanical Surface Detection)
- Electronics: DAE4 Sn1220; Calibrated: 22/01/2014
- Phantom: SAM1; Type: SAM; Serial: TP1561
- Measurement SW: DASY52, Version 52.8 (7); SEMCAD X Version 14.6.10 (7164)

Configuration/802.11a 5180MHz-Horizontal Up/Area Scan (7x10x1): Measurement grid: dx=10mm, dy=10mm

Maximum value of SAR (measured) = 0.369 W/kg

Configuration/802.11a 5180MHz-Horizontal Up/Zoom Scan (7x7x5)/Cube 0: Measurement grid:

dx=4mm, dy=4mm, dz=2.5mm, Reference Value = 6.528 V/m; Power Drift = 0.08 dB

Peak SAR (extrapolated) = 0.789 W/kg

SAR(1 g) = 0.254 W/kg; SAR(10 g) = 0.103 W/kg Maximum value of SAR (measured) = 0.452 W/kg

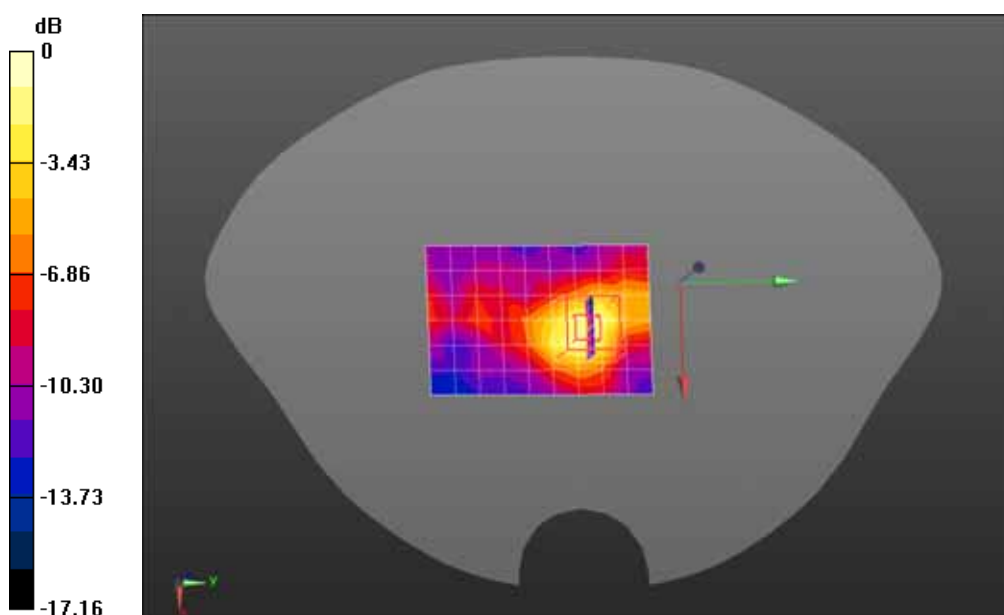

0 dB = 0.452 W/kg = -3.45 dBW/kg

Date/Time: 05-05-2014

Test Laboratory: QuieTek Lab

802.11a 5180MHz-Horizontal Down (PCB Antenna)

DUT: UltraSky MIMO 11abgn USB Dongle/CPE; Type: M27, M27C5, M27C5-16

Communication System: UID 0, CW; Communication System Band: 5GHz(5000.0-6000.0MHz); Duty Cycle: 1:1.0; Frequency: 5180 MHz; Medium parameters used: $f = 5180$ MHz; $\sigma = 5.28$ S/m; $\epsilon_r = 48.71$; $\rho = 1000$ kg/m³ ; Phantom section: Flat Section

Ambient temperature (°C): 21.5, Liquid temperature (°C): 21.0

DASY5 Configuration:

- Probe: EX3DV4 - SN3710; ConvF(4.22, 4.22, 4.22); Calibrated: 04/03/2014;
- Sensor-Surface: 2mm (Mechanical Surface Detection)
- Electronics: DAE4 Sn1220; Calibrated: 22/01/2014
- Phantom: SAM1; Type: SAM; Serial: TP1561
- Measurement SW: DASY52, Version 52.8 (7); SEMCAD X Version 14.6.10 (7164)

Configuration/802.11a 5180MHz-Horizontal Down/Area Scan (7x11x1): Measurement grid: dx=10mm, dy=10mm

Maximum value of SAR (measured) = 0.644 W/kg

Configuration/802.11a 5180MHz-Horizontal Down/Zoom Scan (7x7x5)/Cube 0: Measurement grid: dx=4mm, dy=4mm, dz=2.5mm, Reference Value = 6.289 V/m; Power Drift = -0.05 dB

Peak SAR (extrapolated) = 1.17 W/kg

SAR(1 g) = 0.342 W/kg; SAR(10 g) = 0.129 W/kg Maximum value of SAR (measured) = 0.632 W/kg

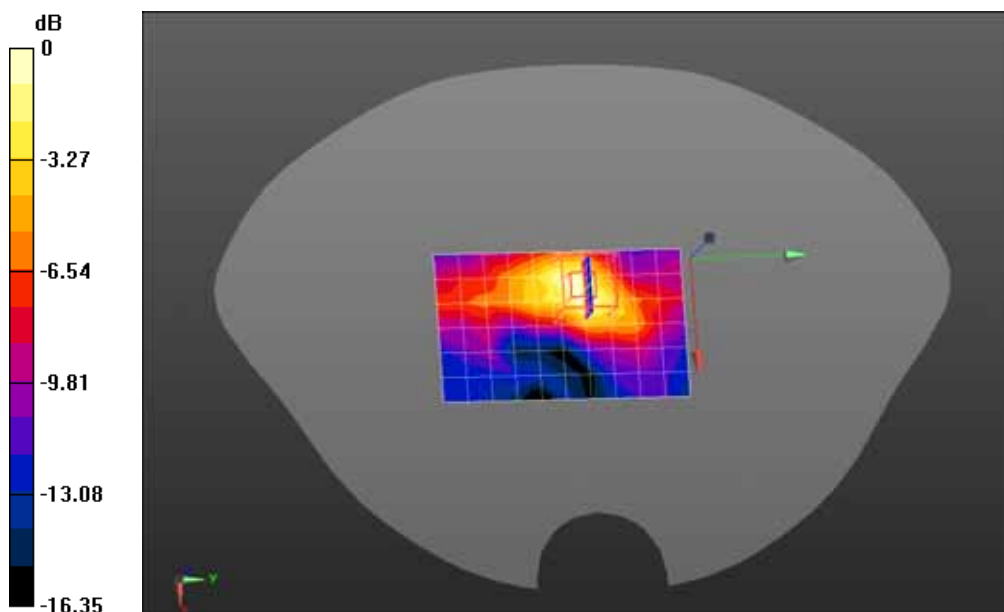

0 dB = 0.632 W/kg = -1.99 dBW/kg

Date/Time: 05-05-2014

Test Laboratory: QuieTek Lab

802.11a 5180MHz-Vertical Front (PCB Antenna)

DUT: UltraSky MIMO 11abgn USB Dongle/CPE; Type: M27, M27C5, M27C5-16

Communication System: UID 0, CW; Communication System Band: 5GHz(5000.0-6000.0MHz); Duty Cycle: 1:1.0; Frequency: 5180 MHz; Medium parameters used: $f = 5180$ MHz; $\sigma = 5.28$ S/m; $\epsilon_r = 48.71$; $\rho = 1000$ kg/m³ ; Phantom section: Flat Section

Ambient temperature (°C): 21.5, Liquid temperature (°C): 21.0

DASY5 Configuration:

- Probe: EX3DV4 - SN3710; ConvF(4.22, 4.22, 4.22); Calibrated: 04/03/2014;
- Sensor-Surface: 2mm (Mechanical Surface Detection)
- Electronics: DAE4 Sn1220; Calibrated: 22/01/2014
- Phantom: SAM1; Type: SAM; Serial: TP1561
- Measurement SW: DASY52, Version 52.8 (7); SEMCAD X Version 14.6.10 (7164)

Configuration/802.11a 5180MHz-Vertical Front/Area Scan (7x10x1): Measurement grid: dx=10mm, dy=10mm

Maximum value of SAR (measured) = 0.631 W/kg

Configuration/802.11a 5180MHz-Vertical Front/Zoom Scan (7x7x5)/Cube 0: Measurement grid: dx=4mm, dy=4mm, dz=2.5mm, Reference Value = 8.204 V/m; Power Drift = -0.20 dB

Peak SAR (extrapolated) = 1.03 W/kg

SAR(1 g) = 0.346 W/kg; SAR(10 g) = 0.140 W/kg Maximum value of SAR (measured) = 0.624 W/kg

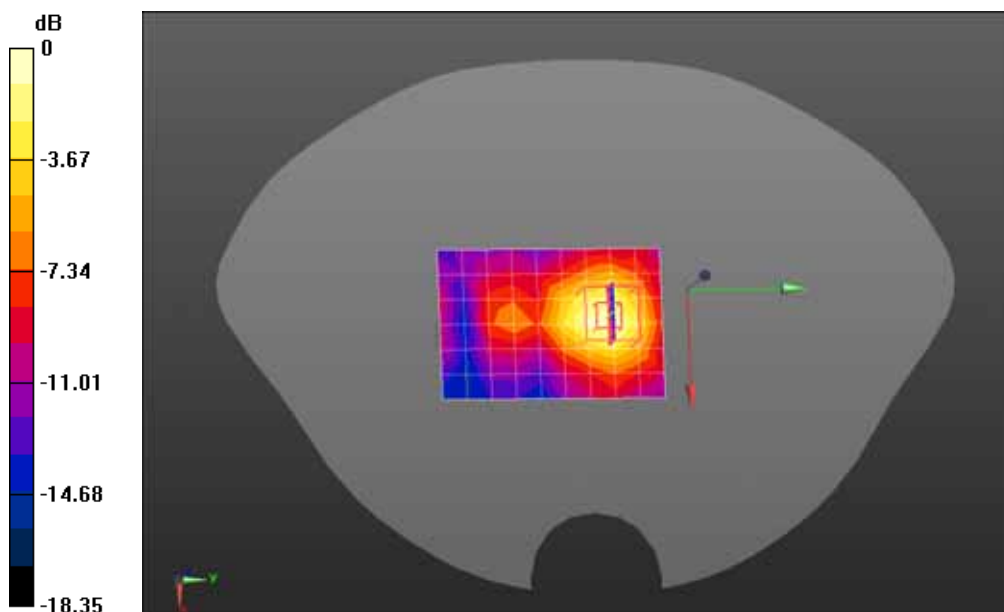

0 dB = 0.624 W/kg = -2.05 dBW/kg

Z-Axis Plot

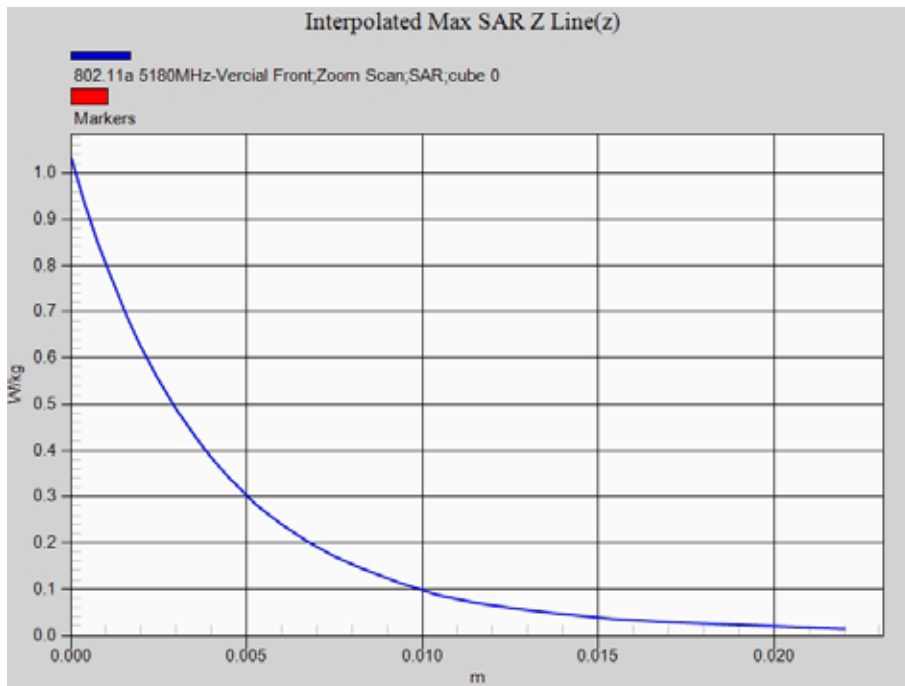

Date/Time: 05-05-2014

Test Laboratory: QuieTek Lab

802.11a 5180MHz-Vertical Back (PCB Antenna)

DUT: UltraSky MIMO 11abgn USB Dongle/CPE; Type: M27, M27C5, M27C5-16

Communication System: UID 0, CW; Communication System Band: 5GHz(5000.0-6000.0MHz); Duty Cycle: 1:1.0; Frequency: 5180 MHz; Medium parameters used: $f = 5180$ MHz; $\sigma = 5.28$ S/m; $\epsilon_r = 48.71$; $\rho = 1000$ kg/m³ ; Phantom section: Flat Section

Ambient temperature (°C): 21.5, Liquid temperature (°C): 21.0

DASY5 Configuration:

- Probe: EX3DV4 - SN3710; ConvF(4.22, 4.22, 4.22); Calibrated: 04/03/2014;
- Sensor-Surface: 2mm (Mechanical Surface Detection)
- Electronics: DAE4 Sn1220; Calibrated: 22/01/2014
- Phantom: SAM1; Type: SAM; Serial: TP1561
- Measurement SW: DASY52, Version 52.8 (7); SEMCAD X Version 14.6.10 (7164)

Configuration/802.11a 5180MHz-Vertical Back/Area Scan (7x10x1): Measurement grid: dx=10mm, dy=10mm

Maximum value of SAR (measured) = 0.0678 W/kg

Configuration/802.11a 5180MHz-Vertical Back/Zoom Scan (7x7x5)/Cube 0: Measurement grid: dx=4mm, dy=4mm, dz=2.5mm, Reference Value = 2.995 V/m; Power Drift = 0.17 dB

Peak SAR (extrapolated) = 0.129 W/kg

SAR(1 g) = 0.052 W/kg; SAR(10 g) = 0.042 W/kg Maximum value of SAR (measured) = 0.0761 W/kg

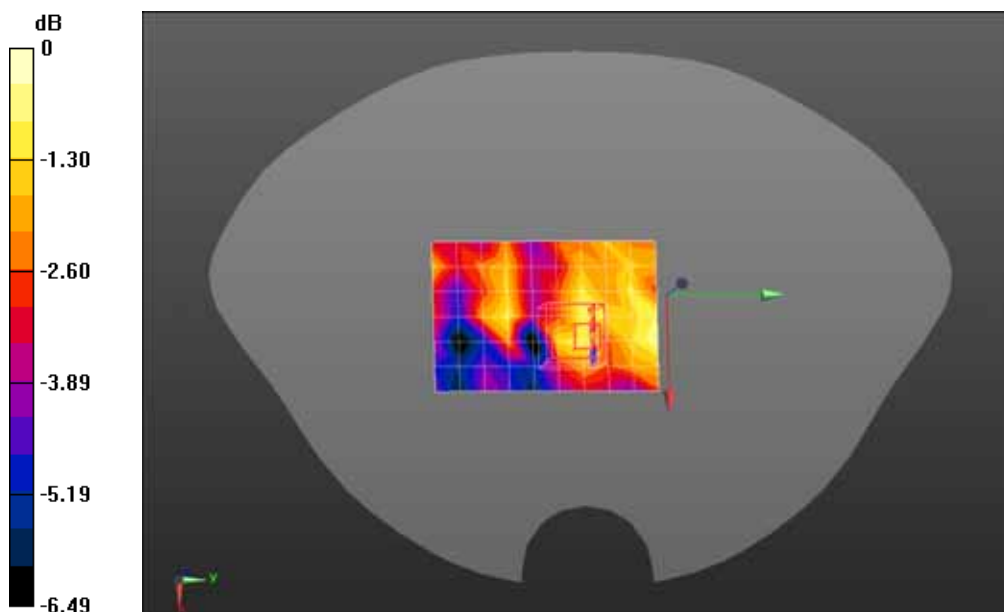

0 dB = 0.0761 W/kg = -11.19 dBW/kg

Date/Time: 05-05-2014

Test Laboratory: QuieTek Lab

802.11a 5180MHz-Tip (PCB Antenna)

DUT: UltraSky MIMO 11abgn USB Dongle/CPE; Type: M27, M27C5, M27C5-16

Communication System: UID 0, CW; Communication System Band: 5GHz(5000.0-6000.0MHz); Duty Cycle: 1:1.0; Frequency: 5180 MHz; Medium parameters used: $f = 5180$ MHz; $\sigma = 5.28$ S/m; $\epsilon_r = 48.71$; $\rho = 1000$ kg/m³ ; Phantom section: Flat Section

Ambient temperature (°C): 21.5, Liquid temperature (°C): 21.0

DASY5 Configuration:

- Probe: EX3DV4 - SN3710; ConvF(4.22, 4.22, 4.22); Calibrated: 04/03/2014;
- Sensor-Surface: 2mm (Mechanical Surface Detection)
- Electronics: DAE4 Sn1220; Calibrated: 22/01/2014
- Phantom: SAM1; Type: SAM; Serial: TP1561
- Measurement SW: DASY52, Version 52.8 (7); SEMCAD X Version 14.6.10 (7164)

Configuration/802.11a 5180MHz-Tip/Area Scan (7x9x1): Measurement grid: dx=10mm, dy=10mm

Maximum value of SAR (measured) = 0.331 W/kg

Configuration/802.11a 5180MHz-Tip/Zoom Scan (7x7x5)/Cube 0: Measurement grid: dx=4mm, dy=4mm, dz=2.5mm, Reference Value = 6.929 V/m; Power Drift = -0.15 dB

Peak SAR (extrapolated) = 0.427 W/kg

SAR(1 g) = 0.129 W/kg; SAR(10 g) = 0.046 W/kg Maximum value of SAR (measured) = 0.256 W/kg

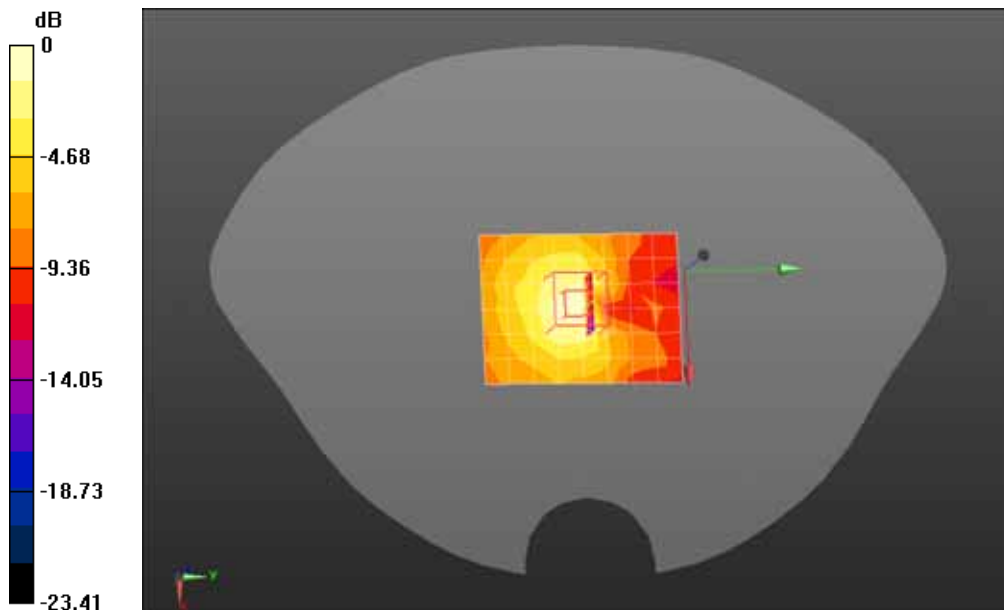

0 dB = 0.256 W/kg = -5.92 dBW/kg

Z-Axis Plot

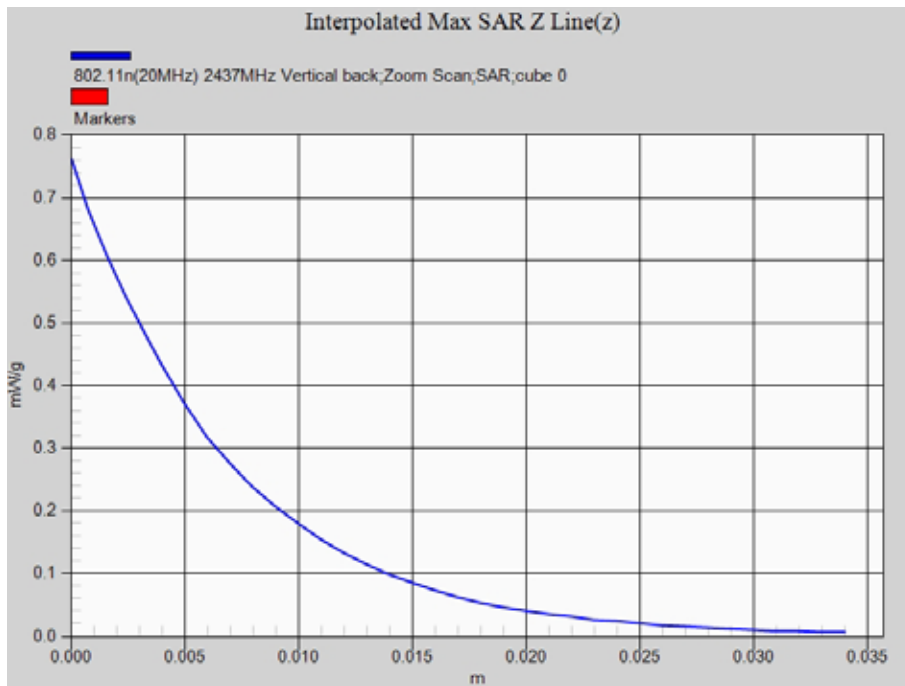

Date/Time: 05-05-2014

Test Laboratory: QuieTek Lab

802.11a 5240MHz-Vertical Front (PCB Antenna)

DUT: UltraSky MIMO 11abgn USB Dongle/CPE; Type: M27, M27C5, M27C5-16

Communication System: UID 0, CW (0); Communication System Band: 5GHz(5000.0-6000.0MHz); Duty Cycle: 1:1.0; Frequency: 5240 MHz; Medium parameters used: $f = 5240$ MHz; $\sigma = 5.39$ S/m; $\epsilon_r = 48.55$; $\rho = 1000$ kg/m³ ; Phantom section: Flat Section

Ambient temperature (°C): 21.5, Liquid temperature (°C): 21.0

DASY5 Configuration:

- Probe: EX3DV4 - SN3710; ConvF(4.22, 4.22, 4.22); Calibrated: 04/03/2014;
- Sensor-Surface: 2mm (Mechanical Surface Detection)
- Electronics: DAE4 Sn1220; Calibrated: 22/01/2014
- Phantom: SAM1; Type: SAM; Serial: TP1561
- Measurement SW: DASY52, Version 52.8 (7); SEMCAD X Version 14.6.10 (7164)

Configuration/802.11a 5240MHz-Vertical Front/Area Scan (7x10x1): Measurement grid: dx=10mm, dy=10mm

Maximum value of SAR (measured) = 0.555 W/kg

Configuration/802.11a 5240MHz-Vertical Front/Zoom Scan (7x7x5)/Cube 0: Measurement grid: dx=4mm, dy=4mm, dz=2.5mm, Reference Value = 7.071 V/m; Power Drift = -0.10 dB

Peak SAR (extrapolated) = 0.926 W/kg

SAR(1 g) = 0.302 W/kg; SAR(10 g) = 0.130 W/kg Maximum value of SAR (measured) = 0.543 W/kg

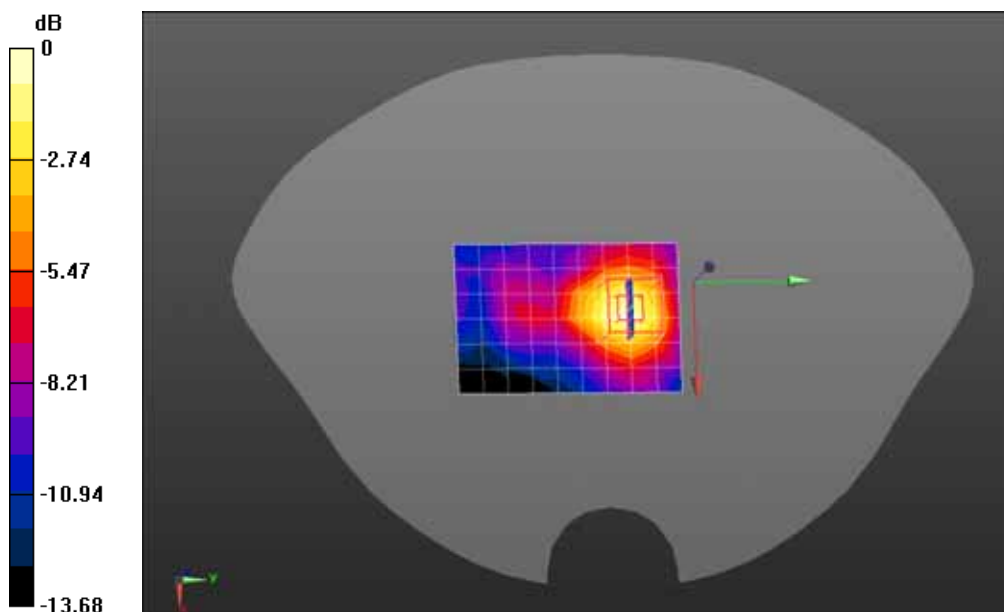

0 dB = 0.543 W/kg = -2.65 dBW/kg

Date/Time: 05-05-2014

Test Laboratory: QuieTek Lab

802.11a 5745MHz-Vertical Front (PCB Antenna)

DUT: UltraSky MIMO 11abgn USB Dongle/CPE; Type: M27, M27C5, M27C5-16

Communication System: UID 0, CW (0); Communication System Band: 5GHz(5000.0-6000.0MHz); Duty Cycle: 1:1.0; Frequency: 5745 MHz; Medium parameters used: $f = 5745$ MHz; $\sigma = 5.95$ S/m; $\epsilon_r = 47.44$; $\rho = 1000$ kg/m³ ; Phantom section: Flat Section

Ambient temperature (°C): 21.5, Liquid temperature (°C): 21.0

DASY5 Configuration:

- Probe: EX3DV4 - SN3710; ConvF(4, 4, 4); Calibrated: 04/03/2014;
- Sensor-Surface: 2mm (Mechanical Surface Detection)
- Electronics: DAE4 Sn1220; Calibrated: 22/01/2014
- Phantom: SAM1; Type: SAM; Serial: TP1561
- Measurement SW: DASY52, Version 52.8 (7); SEMCAD X Version 14.6.10 (7164)

Configuration/802.11a 57450MHz-Vercial Front/Area Scan (7x10x1): Measurement grid: dx=10mm, dy=10mm

Maximum value of SAR (measured) = 0.293 W/kg

Configuration/802.11a 57450MHz-Vercial Front/Zoom Scan (7x7x5)/Cube 0: Measurement grid:

dx=4mm, dy=4mm, dz=2.5mm, Reference Value = 5.675 V/m; Power Drift = -0.12 dB

Peak SAR (extrapolated) = 0.625 W/kg

SAR(1 g) = 0.179 W/kg; SAR(10 g) = 0.091 W/kg Maximum value of SAR (measured) = 0.307 W/kg

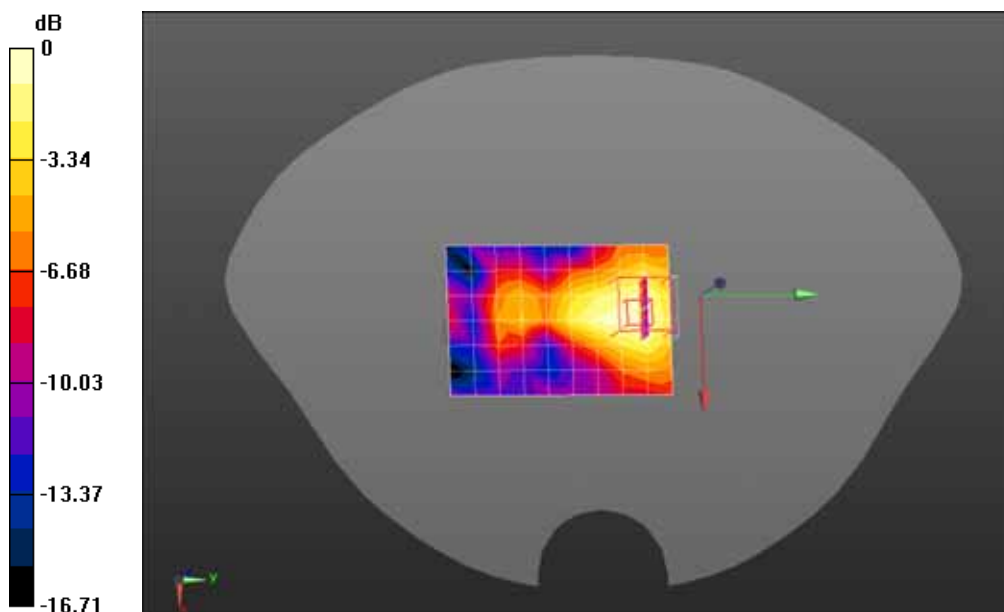

0 dB = 0.307 W/kg = -5.13 dBW/kg

Date/Time: 05-05-2014

Test Laboratory: QuieTek Lab

802.11a 5785MHz-Vertical Front (PCB Antenna)

DUT: UltraSky MIMO 11abgn USB Dongle/CPE; Type: M27, M27C5, M27C5-16

Communication System: UID 0, CW (0); Communication System Band: 5GHz(5000.0-6000.0MHz); Duty Cycle: 1:1.0; Frequency: 5785 MHz; Medium parameters used: $f = 5785$ MHz; $\sigma = 6.01$ S/m; $\epsilon_r = 47.34$; $\rho = 1000$ kg/m³ ; Phantom section: Flat Section

Ambient temperature (°C): 21.5, Liquid temperature (°C): 21.0

DASY5 Configuration:

- Probe: EX3DV4 - SN3710; ConvF(4, 4, 4); Calibrated: 04/03/2014;
- Sensor-Surface: 2mm (Mechanical Surface Detection)
- Electronics: DAE4 Sn1220; Calibrated: 22/01/2014
- Phantom: SAM1; Type: SAM; Serial: TP1561
- Measurement SW: DASY52, Version 52.8 (7); SEMCAD X Version 14.6.10 (7164)

Configuration/802.11a 5785MHz-Vertical Front/Area Scan (7x10x1): Measurement grid: dx=10mm, dy=10mm

Maximum value of SAR (measured) = 0.214 W/kg

Configuration/802.11a 5785MHz-Vertical Front/Zoom Scan (7x7x5)/Cube 0: Measurement grid: dx=4mm, dy=4mm, dz=2.5mm, Reference Value = 4.469 V/m; Power Drift = 0.14 dB

Peak SAR (extrapolated) = 0.545 W/kg

SAR(1 g) = 0.142 W/kg; SAR(10 g) = 0.073 W/kg Maximum value of SAR (measured) = 0.247 W/kg

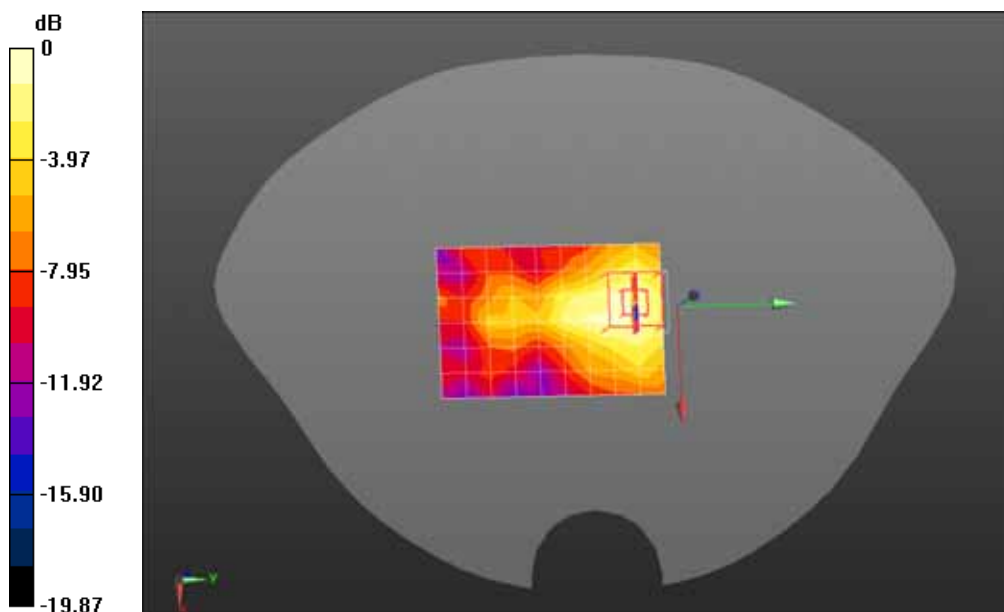

0 dB = 0.247 W/kg = -6.07 dBW/kg

Date/Time: 05-05-2014

Test Laboratory: QuieTek Lab

802.11a 5825MHz-Vertical Front (PCB Antenna)

DUT: UltraSky MIMO 11abgn USB Dongle/CPE; Type: M27, M27C5, M27C5-16

Communication System: UID 0, CW (0); Communication System Band: 5GHz(5000.0-6000.0MHz); Duty Cycle: 1:1.0; Frequency: 5825 MHz; Medium parameters used: $f = 5825$ MHz; $\sigma = 6.08$ S/m; $\epsilon_r = 47.23$; $\rho = 1000$ kg/m³ ; Phantom section: Flat Section

Ambient temperature (°C): 21.5, Liquid temperature (°C): 21.0

DASY5 Configuration:

- Probe: EX3DV4 - SN3710; ConvF(4, 4, 4); Calibrated: 04/03/2014;
- Sensor-Surface: 2mm (Mechanical Surface Detection)
- Electronics: DAE4 Sn1220; Calibrated: 22/01/2014
- Phantom: SAM1; Type: SAM; Serial: TP1561
- Measurement SW: DASY52, Version 52.8 (7); SEMCAD X Version 14.6.10 (7164)

Configuration/802.11a 5825MHz-Vertical Front/Area Scan (7x10x1): Measurement grid: dx=10mm, dy=10mm

Maximum value of SAR (measured) = 0.187 W/kg

Configuration/802.11a 5825MHz-Vertical Front/Zoom Scan (7x7x5)/Cube 0: Measurement grid: dx=4mm, dy=4mm, dz=2.5mm, Reference Value = 4.314 V/m; Power Drift = -0.01 dB

Peak SAR (extrapolated) = 0.610 W/kg

SAR(1 g) = 0.108 W/kg; SAR(10 g) = 0.064 W/kg Maximum value of SAR (measured) = 0.172 W/kg

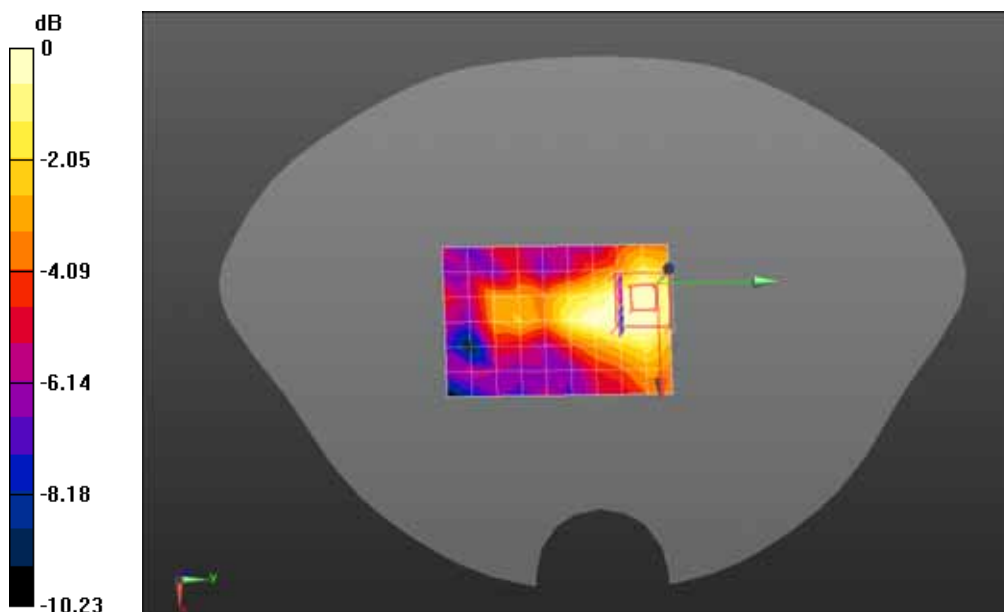

0 dB = 0.172 W/kg = -7.64 dBW/kg

Date/Time: 05-05-2014

Test Laboratory: QuieTek Lab

802.11n(20) 5180MHz-Vertical Front (PCB Antenna)

DUT: UltraSky MIMO 11abgn USB Dongle/CPE; Type: M27, M27C5, M27C5-16

Communication System: UID 0, CW (0); Communication System Band: 5GHz(5000.0-6000.0MHz); Duty Cycle: 1:1.0; Frequency: 5180 MHz; Medium parameters used: $f = 5180$ MHz; $\sigma = 5.28$ S/m; $\epsilon_r = 48.71$; $\rho = 1000$ kg/m³ ; Phantom section: Flat Section

Ambient temperature (°C): 21.5, Liquid temperature (°C): 21.0

DASY5 Configuration:

- Probe: EX3DV4 - SN3710; ConvF(4.22, 4.22, 4.22); Calibrated: 04/03/2014;
- Sensor-Surface: 2mm (Mechanical Surface Detection)
- Electronics: DAE4 Sn1220; Calibrated: 22/01/2014
- Phantom: SAM1; Type: SAM; Serial: TP1561
- Measurement SW: DASY52, Version 52.8 (7); SEMCAD X Version 14.6.10 (7164)

Configuration/802.11n(20) 5180MHz-Vertical Front/Area Scan (7x10x1): Measurement grid: dx=10mm, dy=10mm

Maximum value of SAR (measured) = 0.465 W/kg

Configuration/802.11n(20) 5180MHz-Vertical Front/Zoom Scan (7x7x5)/Cube 0: Measurement grid: dx=4mm, dy=4mm, dz=2.5mm, Reference Value = 7.814 V/m; Power Drift = -0.19 dB

Peak SAR (extrapolated) = 0.881 W/kg

SAR(1 g) = 0.273 W/kg; SAR(10 g) = 0.108 W/kg Maximum value of SAR (measured) = 0.508 W/kg

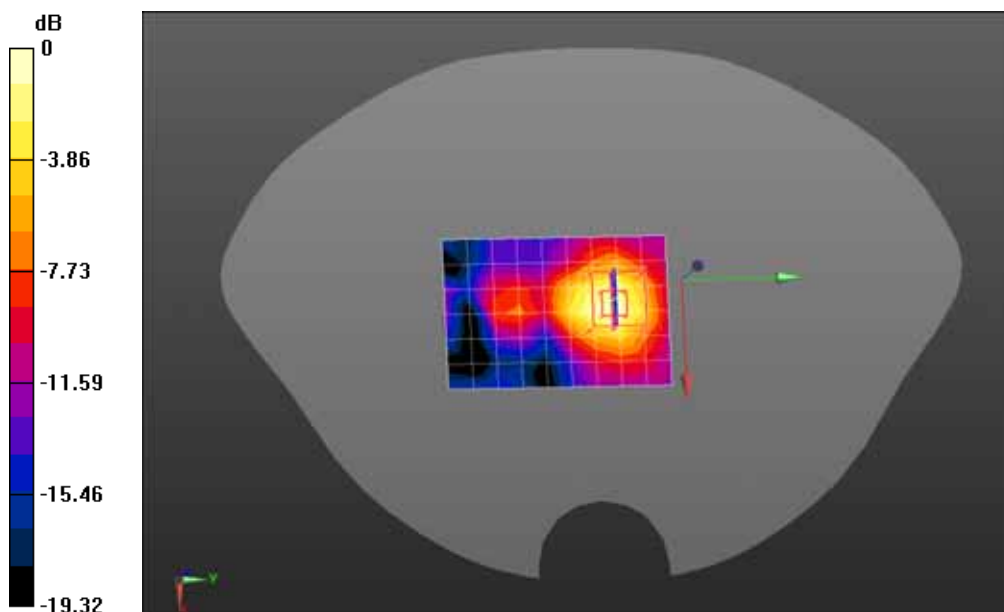

0 dB = 0.508 W/kg = -2.94 dBW/kg

Date/Time: 05-05-2014

Test Laboratory: QuieTek Lab

802.11n(20) 5745MHz-Vertical Front (PCB Antenna)

DUT: UltraSky MIMO 11abgn USB Dongle/CPE; Type: M27, M27C5, M27C5-16

Communication System: UID 0, CW (0); Communication System Band: 5GHz(5000.0-6000.0MHz); Duty Cycle: 1:1.0; Frequency: 5745 MHz; Medium parameters used: $f = 5745 \text{ MHz}$; $\sigma = 5.95 \text{ S/m}$; $\epsilon_r = 47.44$; $\rho = 1000 \text{ kg/m}^3$; Phantom section: Flat Section

Ambient temperature (°C): 21.5, Liquid temperature (°C): 21.0

DASY5 Configuration:

- Probe: EX3DV4 - SN3710; ConvF(4, 4, 4); Calibrated: 04/03/2014;
- Sensor-Surface: 2mm (Mechanical Surface Detection)
- Electronics: DAE4 Sn1220; Calibrated: 22/01/2014
- Phantom: SAM1; Type: SAM; Serial: TP1561
- Measurement SW: DASY52, Version 52.8 (7); SEMCAD X Version 14.6.10 (7164)

Configuration/802.11n(20) 5745MHz-Vertical Front/Area Scan (7x10x1): Measurement grid: dx=10mm, dy=10mm

Maximum value of SAR (measured) = 0.208 W/kg

Configuration/802.11n(20) 5745MHz-Vertical Front/Zoom Scan (7x7x5)/Cube 0: Measurement grid: dx=4mm, dy=4mm, dz=2.5mm, Reference Value = 3.980 V/m; Power Drift = 0.20 dB

Peak SAR (extrapolated) = 0.522 W/kg

SAR(1 g) = 0.158 W/kg; SAR(10 g) = 0.083 W/kg Maximum value of SAR (measured) = 0.260 W/kg

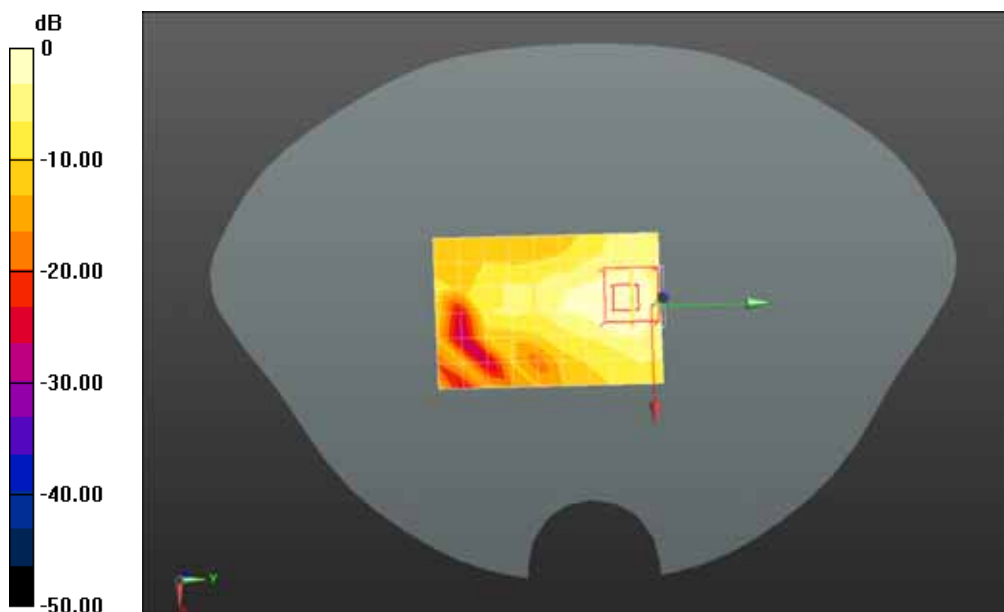

0 dB = 0.260 W/kg = -5.85 dBW/kg

Date/Time: 05-05-2014

Test Laboratory: QuieTek Lab

802.11n(40) 5190MHz-Vertical Front (PCB Antenna)

DUT: UltraSky MIMO 11abgn USB Dongle/CPE; Type: M27, M27C5, M27C5-16

Communication System: UID 0, CW (0); Communication System Band: 5GHz(5000.0-6000.0MHz); Duty Cycle: 1:1.0; Frequency: 5190 MHz; Medium parameters used: $f = 5190$ MHz; $\sigma = 5.13$ S/m; $\epsilon_r = 49.98$; $\rho = 1000$ kg/m³ ; Phantom section: Flat Section

Ambient temperature (°C): 21.5, Liquid temperature (°C): 21.0

DASY5 Configuration:

- Probe: EX3DV4 - SN3710; ConvF(4.22, 4.22, 4.22); Calibrated: 04/03/2014;
- Sensor-Surface: 2mm (Mechanical Surface Detection)
- Electronics: DAE4 Sn1220; Calibrated: 22/01/2014
- Phantom: SAM1; Type: SAM; Serial: TP1561
- Measurement SW: DASY52, Version 52.8 (7); SEMCAD X Version 14.6.10 (7164)

Configuration/802.11n(40) 5190MHz-Vertical Front/Area Scan (7x10x1): Measurement grid: dx=10mm, dy=10mm

Maximum value of SAR (measured) = 0.419 W/kg

Configuration/802.11n(40) 5190MHz-Vertical Front/Zoom Scan (7x7x5)/Cube 0: Measurement grid: dx=4mm, dy=4mm, dz=2.5mm, Reference Value = 8.900 V/m; Power Drift = -0.17 dB

Peak SAR (extrapolated) = 0.611 W/kg

SAR(1 g) = 0.193 W/kg; SAR(10 g) = 0.088 W/kg Maximum value of SAR (measured) = 0.334 W/kg

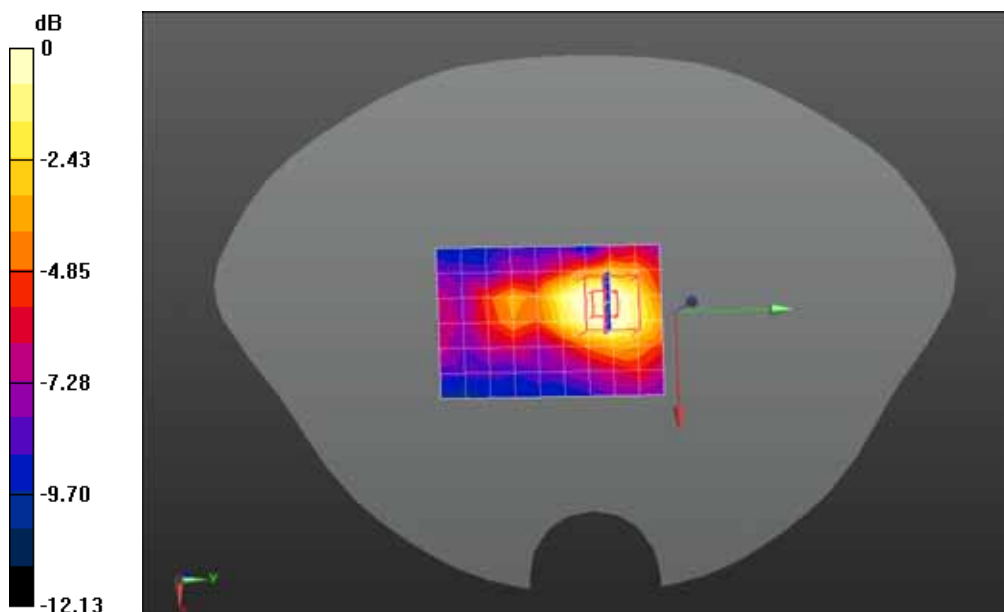

0 dB = 0.334 W/kg = -4.76 dBW/kg

Date/Time: 05-05-2014

Test Laboratory: QuieTek Lab

802.11n(40) 5755MHz-Vertical Front (PCB Antenna)

DUT: UltraSky MIMO 11abgn USB Dongle/CPE; Type: M27, M27C5, M27C5-16

Communication System: UID 0, CW (0); Communication System Band: 5GHz(5000.0-6000.0MHz); Duty Cycle: 1:1.0; Frequency: 5755 MHz; Medium parameters used: $f = 5755$ MHz; $\sigma = 5.97$ S/m; $\epsilon_r = 47.41$; $\rho = 1000$ kg/m³ ; Phantom section: Flat Section

Ambient temperature (°C): 21.5, Liquid temperature (°C): 21.0

DASY5 Configuration:

- Probe: EX3DV4 - SN3710; ConvF(4, 4, 4); Calibrated: 04/03/2014;
- Sensor-Surface: 2mm (Mechanical Surface Detection)
- Electronics: DAE4 Sn1220; Calibrated: 22/01/2014
- Phantom: SAM1; Type: SAM; Serial: TP1561
- Measurement SW: DASY52, Version 52.8 (7); SEMCAD X Version 14.6.10 (7164)

Configuration/802.11n(40) 5755MHz-Vertical Front/Area Scan (7x10x1): Measurement grid: dx=10mm, dy=10mm

Maximum value of SAR (measured) = 0.155 W/kg

Configuration/802.11n(40) 5755MHz-Vertical Front/Zoom Scan (7x7x5)/Cube 0: Measurement grid: dx=4mm, dy=4mm, dz=2.5mm, Reference Value = 3.448 V/m; Power Drift = 0.11 dB

Peak SAR (extrapolated) = 0.366 W/kg

SAR(1 g) = 0.087 W/kg; SAR(10 g) = 0.038 W/kg Maximum value of SAR (measured) = 0.160 W/kg

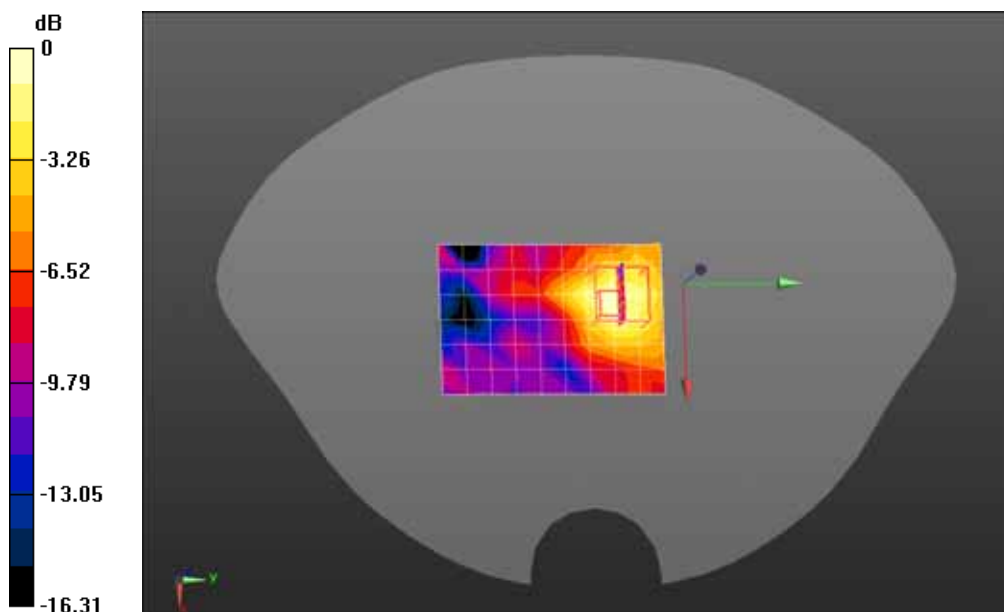

0 dB = 0.160 W/kg = -7.96 dBW/kg

Date/Time: 05-05-2014

Test Laboratory: QuieTek Lab

802.11a 5180MHz-Horizontal Up (Dipole Antenna at 0°)

DUT: UltraSky MIMO 11abgn USB Dongle/CPE; Type: M27, M27C5, M27C5-16

Communication System: UID 0, CW; Communication System Band: 5GHz(5000.0-6000.0MHz); Duty Cycle: 1:1.0; Frequency: 5180 MHz; Medium parameters used: $f = 5180$ MHz; $\sigma = 5.28$ S/m; $\epsilon_r = 48.71$; $\rho = 1000$ kg/m³; Phantom section: Flat Section

Ambient temperature (°C): 21.5, Liquid temperature (°C): 21.0

DASY5 Configuration:

- Probe: EX3DV4 - SN3710; ConvF(4.22, 4.22, 4.22); Calibrated: 04/03/2014;
- Sensor-Surface: 2mm (Mechanical Surface Detection)
- Electronics: DAE4 Sn1220; Calibrated: 22/01/2014
- Phantom: SAM1; Type: SAM; Serial: TP1561
- Measurement SW: DASY52, Version 52.8 (7); SEMCAD X Version 14.6.10 (7164)

Configuration/802.11a 5180MHz-Horizontal Up+0/Area Scan (7x9x1): Measurement grid: dx=10mm, dy=10mm

Maximum value of SAR (measured) = 0.0458 W/kg

Configuration/802.11a 5180MHz-Horizontal Up+0/Zoom Scan (7x7x5)/Cube 0: Measurement grid: dx=4mm, dy=4mm, dz=2.5mm, Reference Value = 2.532 V/m; Power Drift = 0.19 dB

Peak SAR (extrapolated) = 0.0610 W/kg

SAR(1 g) = 0.041 W/kg; SAR(10 g) = 0.032 W/kg Maximum value of SAR (measured) = 0.0611 W/kg

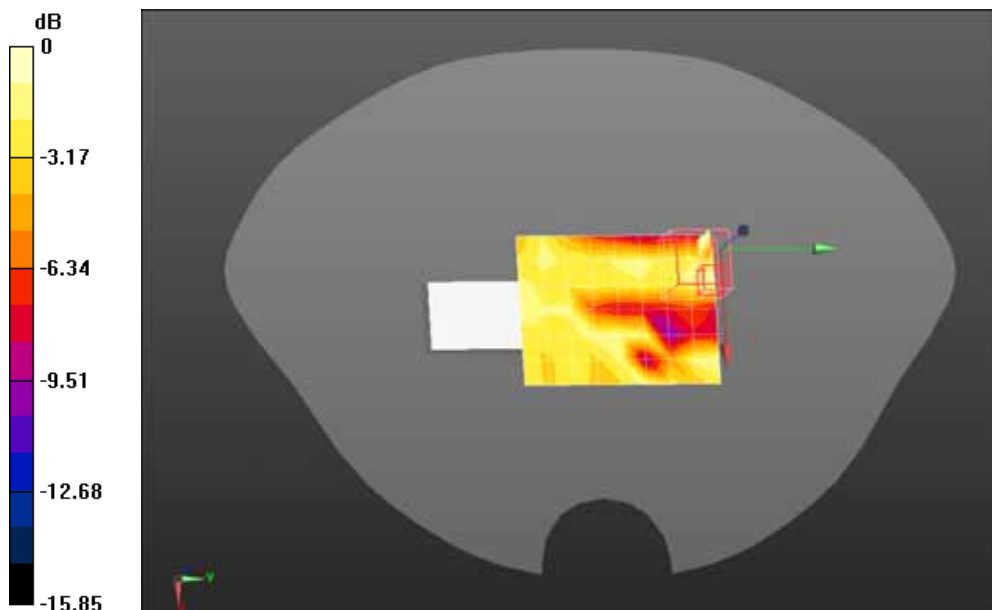

0 dB = 0.0611 W/kg = -12.14 dBW/kg

Date/Time: 05-05-2014

Test Laboratory: QuieTek Lab

802.11a 5180MHz-Horizontal Down (Dipole Antenna at 0°)

DUT: UltraSky MIMO 11abgn USB Dongle/CPE; Type: M27, M27C5, M27C5-16

Communication System: UID 0, CW; Communication System Band: 5GHz(5000.0-6000.0MHz); Duty Cycle: 1:1.0; Frequency: 5180 MHz; Medium parameters used: $f = 5180$ MHz; $\sigma = 5.28$ S/m; $\epsilon_r = 48.71$; $\rho = 1000$ kg/m³ ; Phantom section: Flat Section

Ambient temperature (°C): 21.5, Liquid temperature (°C): 21.0

DASY5 Configuration:

- Probe: EX3DV4 - SN3710; ConvF(4.22, 4.22, 4.22); Calibrated: 04/03/2014;
- Sensor-Surface: 2mm (Mechanical Surface Detection)
- Electronics: DAE4 Sn1220; Calibrated: 22/01/2014
- Phantom: SAM1; Type: SAM; Serial: TP1561
- Measurement SW: DASY52, Version 52.8 (7); SEMCAD X Version 14.6.10 (7164)

Configuration/802.11a 5180MHz-Horizontal Down+90/Area Scan (7x10x1): Measurement grid:

dx=10mm, dy=10mm

Maximum value of SAR (measured) = 0.0571 W/kg

Configuration/802.11a 5180MHz-Horizontal Down+90/Zoom Scan (7x7x5)/Cube 0: Measurement grid:

dx=4mm, dy=4mm, dz=2.5mm, Reference Value = 2.619 V/m; Power Drift = 0.13 dB

Peak SAR (extrapolated) = 0.0590 W/kg

SAR(1 g) = 0.041 W/kg; SAR(10 g) = 0.036 W/kg Maximum value of SAR (measured) = 0.0584 W/kg

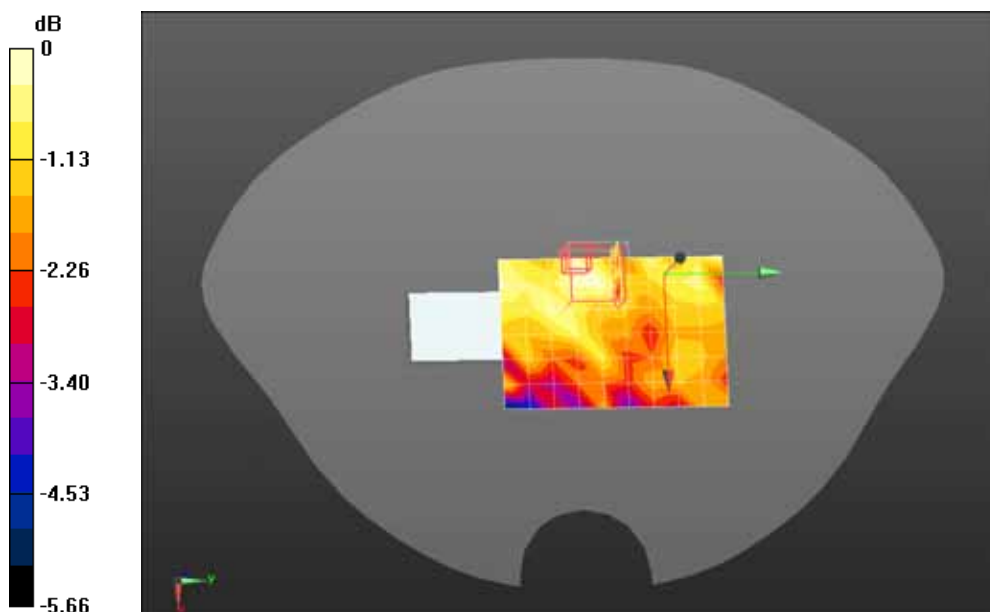

0 dB = 0.0584 W/kg = -12.34 dBW/kg

Date/Time: 05-05-2014

Test Laboratory: QuieTek Lab

802.11a 5180MHz-Horizontal Up (Dipole Antenna at 90°)

DUT: UltraSky MIMO 11abgn USB Dongle/CPE; Type: M27, M27C5, M27C5-16

Communication System: UID 0, CW; Communication System Band: 5GHz(5000.0-6000.0MHz); Duty Cycle: 1:1.0; Frequency: 5180 MHz; Medium parameters used: $f = 5180$ MHz; $\sigma = 5.28$ S/m; $\epsilon_r = 48.71$; $\rho = 1000$ kg/m³ ; Phantom section: Flat Section

Ambient temperature (°C): 21.5, Liquid temperature (°C): 21.0

DASY5 Configuration:

- Probe: EX3DV4 - SN3710; ConvF(4.22, 4.22, 4.22); Calibrated: 04/03/2014;
- Sensor-Surface: 2mm (Mechanical Surface Detection)
- Electronics: DAE4 Sn1220; Calibrated: 22/01/2014
- Phantom: SAM1; Type: SAM; Serial: TP1561
- Measurement SW: DASY52, Version 52.8 (7); SEMCAD X Version 14.6.10 (7164)

Configuration/802.11a 5180MHz-Horizontal Up+90/Area Scan (7x9x1): Measurement grid: dx=10mm, dy=10mm

Maximum value of SAR (measured) = 0.0397 W/kg

Configuration/802.11a 5180MHz-Horizontal Up+90/Zoom Scan (7x7x5)/Cube 0: Measurement grid: dx=4mm, dy=4mm, dz=2.5mm, Reference Value = 2.770 V/m; Power Drift = -0.07 dB

Peak SAR (extrapolated) = 0.0680 W/kg

SAR(1 g) = 0.048 W/kg; SAR(10 g) = 0.042 W/kg Maximum value of SAR (measured) = 0.0611 W/kg

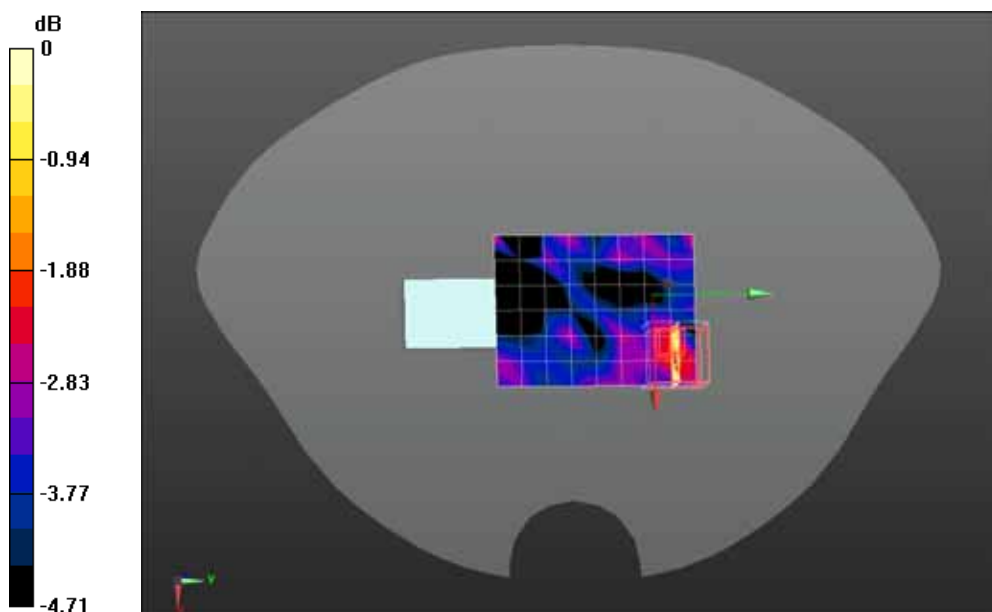

0 dB = 0.0611 W/kg = -12.14 dBW/kg

Date/Time: 05-05-2014

Test Laboratory: QuieTek Lab

802.11a 5240MHz-Horizontal Up (Dipole Antenna at 90°)

DUT: UltraSky MIMO 11abgn USB Dongle/CPE; Type: M27, M27C5, M27C5-16

Communication System: UID 0, CW (0); Communication System Band: 5GHz(5000.0-6000.0MHz); Duty Cycle: 1:1.0; Frequency: 5240 MHz; Medium parameters used: $f = 5240$ MHz; $\sigma = 5.39$ S/m; $\epsilon_r = 48.55$; $\rho = 1000$ kg/m³ ; Phantom section: Flat Section

Ambient temperature (°C): 21.5, Liquid temperature (°C): 21.0

DASY5 Configuration:

- Probe: EX3DV4 - SN3710; ConvF(4.22, 4.22, 4.22); Calibrated: 04/03/2014;
- Sensor-Surface: 2mm (Mechanical Surface Detection)
- Electronics: DAE4 Sn1220; Calibrated: 22/01/2014
- Phantom: SAM1; Type: SAM; Serial: TP1561
- Measurement SW: DASY52, Version 52.8 (7); SEMCAD X Version 14.6.10 (7164)

Configuration/802.11a 5240MHz-Horizontal Up+90/Area Scan (7x10x1): Measurement grid: dx=10mm, dy=10mm

Maximum value of SAR (measured) = 0.0468 W/kg

Configuration/802.11a 5240MHz-Horizontal Up+90/Zoom Scan (7x7x5)/Cube 0: Measurement grid: dx=4mm, dy=4mm, dz=2.5mm, Reference Value = 2.601 V/m; Power Drift = -0.19 dB

Peak SAR (extrapolated) = 0.0820 W/kg

SAR(1 g) = 0.033 W/kg; SAR(10 g) = 0.023 W/kg Maximum value of SAR (measured) = 0.0475 W/kg

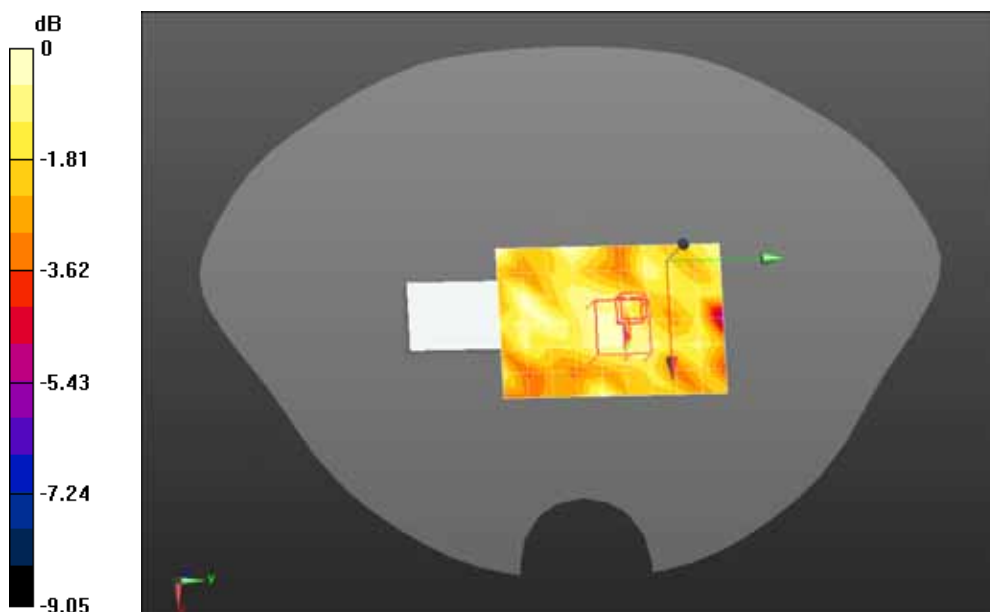

0 dB = 0.0475 W/kg = -13.23 dBW/kg

Date/Time: 05-05-2014

Test Laboratory: QuieTek Lab

802.11a 5745MHz-Horizontal Up (Dipole Antenna at 90°)

DUT: UltraSky MIMO 11abgn USB Dongle/CPE; Type: M27, M27C5, M27C5-16

Communication System: UID 0, CW (0); Communication System Band: 5GHz(5000.0-6000.0MHz); Duty Cycle: 1:1.0; Frequency: 5745 MHz; Medium parameters used: $f = 5745$ MHz; $\sigma = 5.95$ S/m; $\epsilon_r = 47.44$; $\rho = 1000$ kg/m³ ; Phantom section: Flat Section

Ambient temperature (°C): 21.5, Liquid temperature (°C): 21.0

DASY5 Configuration:

- Probe: EX3DV4 - SN3710; ConvF(4, 4, 4); Calibrated: 04/03/2014;
- Sensor-Surface: 2mm (Mechanical Surface Detection)
- Electronics: DAE4 Sn1220; Calibrated: 22/01/2014
- Phantom: SAM1; Type: SAM; Serial: TP1561
- Measurement SW: DASY52, Version 52.8 (7); SEMCAD X Version 14.6.10 (7164)

Configuration/802.11a 5240MHz-Horizontal Up+90/Area Scan (7x10x1): Measurement grid: dx=10mm, dy=10mm

Maximum value of SAR (measured) = 0.0625 W/kg

Configuration/802.11a 5240MHz-Horizontal Up+90/Zoom Scan (7x7x5)/Cube 0: Measurement grid: dx=4mm, dy=4mm, dz=2.5mm, Reference Value = 2.770 V/m; Power Drift = 0.05 dB

Peak SAR (extrapolated) = 0.0660 W/kg

SAR(1 g) = 0.049 W/kg; SAR(10 g) = 0.041 W/kg Maximum value of SAR (measured) = 0.0665 W/kg

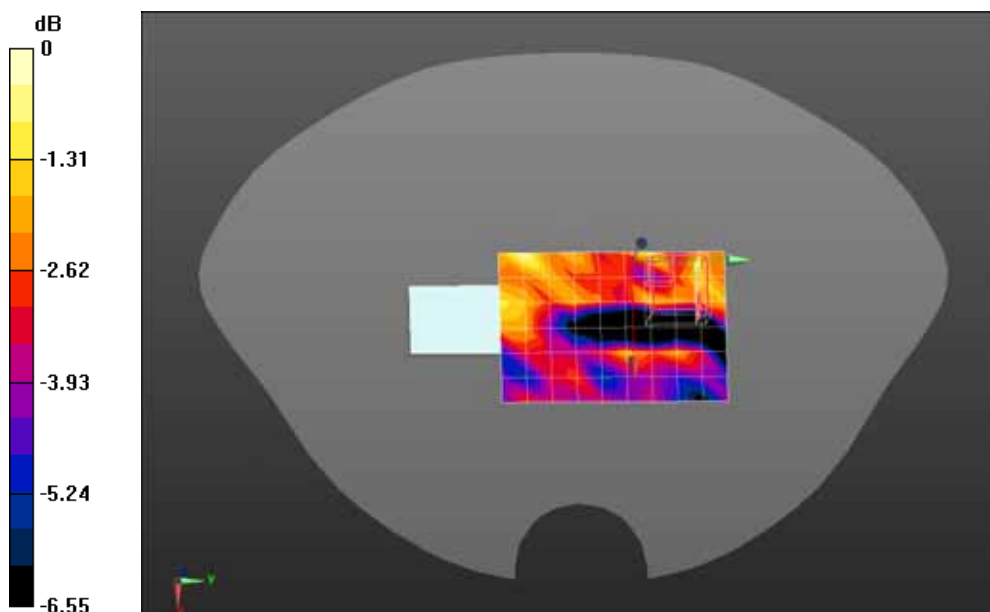

0 dB = 0.0665 W/kg = -11.77 dBW/kg

Date/Time: 05-05-2014

Test Laboratory: QuieTek Lab

802.11a 5785MHz-Horizontal Up (Dipole Antenna at 90°)

DUT: UltraSky MIMO 11abgn USB Dongle/CPE; Type: M27, M27C5, M27C5-16

Communication System: UID 0, CW (0); Communication System Band: 5GHz(5000.0-6000.0MHz); Duty Cycle: 1:1.0; Frequency: 5785 MHz; Medium parameters used: $f = 5785 \text{ MHz}$; $\sigma = 6.01 \text{ S/m}$; $\epsilon_r = 47.34$; $\rho = 1000 \text{ kg/m}^3$; Phantom section: Flat Section

Ambient temperature (°C): 21.5, Liquid temperature (°C): 21.0

DASY5 Configuration:

- Probe: EX3DV4 - SN3710; ConvF(4, 4, 4); Calibrated: 04/03/2014;
- Sensor-Surface: 2mm (Mechanical Surface Detection)
- Electronics: DAE4 Sn1220; Calibrated: 22/01/2014
- Phantom: SAM1; Type: SAM; Serial: TP1561
- Measurement SW: DASY52, Version 52.8 (7); SEMCAD X Version 14.6.10 (7164)

Configuration/802.11a 5785MHz-Horizontal Up+90/Area Scan (7x10x1): Measurement grid: $dx=10\text{mm}$, $dy=10\text{mm}$

Maximum value of SAR (measured) = 0.0696 W/kg

Configuration/802.11a 5785MHz-Horizontal Up+90/Zoom Scan (7x7x5)/Cube 0: Measurement grid: $dx=4\text{mm}$, $dy=4\text{mm}$, $dz=2.5\text{mm}$, Reference Value = 2.678 V/m; Power Drift = -0.04 dB

Peak SAR (extrapolated) = 0.0750 W/kg

SAR(1 g) = 0.050 W/kg; SAR(10 g) = 0.043 W/kg Maximum value of SAR (measured) = 0.0677 W/kg

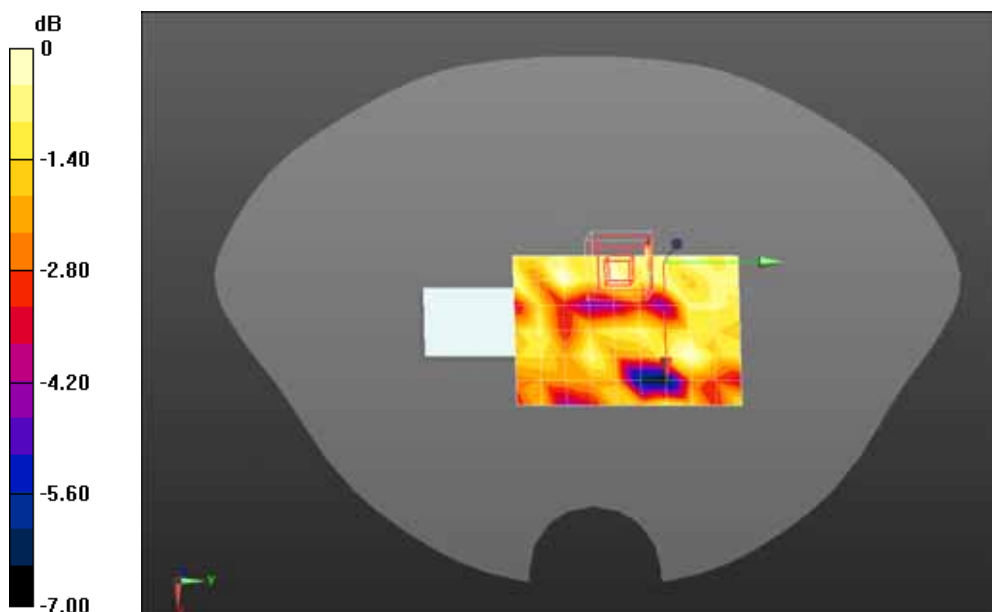

0 dB = 0.0677 W/kg = -11.69 dBW/kg

Z-Axis Plot

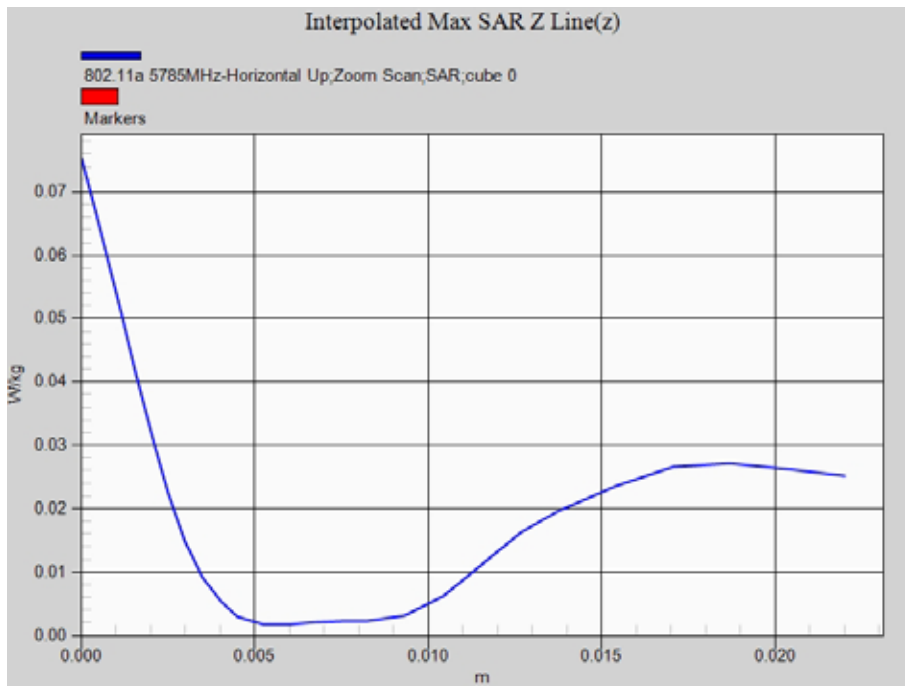

Date/Time: 05-05-2014

Test Laboratory: QuieTek Lab

802.11a 5825MHz-Horizontal Up (Dipole Antenna at 90°)

DUT: UltraSky MIMO 11abgn USB Dongle/CPE; Type: M27, M27C5, M27C5-16

Communication System: UID 0, CW (0); Communication System Band: 5GHz(5000.0-6000.0MHz); Duty Cycle: 1:1.0; Frequency: 5825 MHz; Medium parameters used: $f = 5825 \text{ MHz}$; $\sigma = 6.08 \text{ S/m}$; $\epsilon_r = 47.23$; $\rho = 1000 \text{ kg/m}^3$; Phantom section: Flat Section

Ambient temperature (°C): 21.5, Liquid temperature (°C): 21.0

DASY5 Configuration:

- Probe: EX3DV4 - SN3710; ConvF(4, 4, 4); Calibrated: 04/03/2014;
- Sensor-Surface: 2mm (Mechanical Surface Detection)
- Electronics: DAE4 Sn1220; Calibrated: 22/01/2014
- Phantom: SAM1; Type: SAM; Serial: TP1561
- Measurement SW: DASY52, Version 52.8 (7); SEMCAD X Version 14.6.10 (7164)

Configuration/802.11a 5825MHz-Horizontal Up+90/Area Scan (7x10x1): Measurement grid: $dx=10\text{mm}$, $dy=10\text{mm}$

Maximum value of SAR (measured) = 0.0562 W/kg

Configuration/802.11a 5825MHz-Horizontal Up+90/Zoom Scan (7x7x5)/Cube 0: Measurement grid: $dx=4\text{mm}$, $dy=4\text{mm}$, $dz=2.5\text{mm}$, Reference Value = 1.063 V/m; Power Drift = 0.15 dB

Peak SAR (extrapolated) = 0.0520 W/kg

SAR(1 g) = 0.040 W/kg; SAR(10 g) = 0.033 W/kg Maximum value of SAR (measured) = 0.0523 W/kg

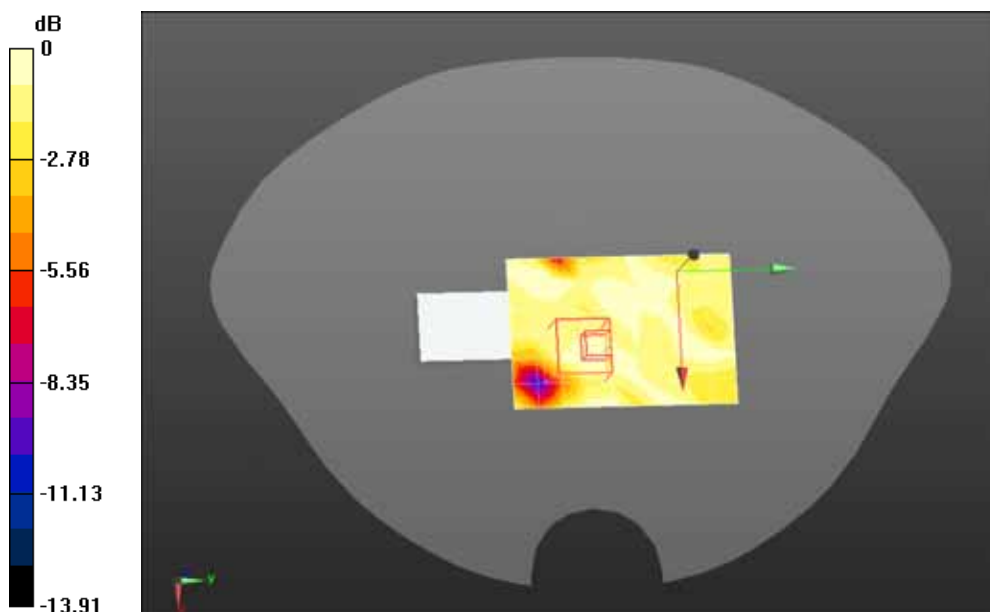

0 dB = 0.0523 W/kg = -12.81 dBW/kg

Date/Time: 05-05-2014

Test Laboratory: QuieTek Lab

802.11n(20MHz) 5180MHz-Horizontal Up (Dipole Antenna at 90°)

DUT: UltraSky MIMO 11abgn USB Dongle/CPE; Type: M27, M27C5, M27C5-16

Communication System: UID 0, CW; Communication System Band: 5GHz(5000.0-6000.0MHz); Duty Cycle: 1:1.0; Frequency: 5180 MHz; Medium parameters used: $f = 5180$ MHz; $\sigma = 5.28$ S/m; $\epsilon_r = 48.71$; $\rho = 1000$ kg/m³ ; Phantom section: Flat Section

Ambient temperature (°C): 21.5, Liquid temperature (°C): 21.0

DASY5 Configuration:

- Probe: EX3DV4 - SN3710; ConvF(6.88, 6.88, 6.88); Calibrated: 04/03/2014;
- Sensor-Surface: 4mm (Mechanical Surface Detection)
- Electronics: DAE4 Sn1220; Calibrated: 22/01/2014
- Phantom: SAM2; Type: SAM; Serial: TP1562
- Measurement SW: DASY52, Version 52.8 (7); SEMCAD X Version 14.6.10 (7164)

Configuration/802.11n(20) 5180MHz-Horizontal Up/Area Scan (7x11x1): Measurement grid: dx=10mm, dy=10mm

Maximum value of SAR (measured) = 0.0439 W/kg

Configuration/802.11n(20) 5180MHz-Horizontal Up/Zoom Scan (5x5x7)/Cube 0: Measurement grid: dx=8mm, dy=8mm, dz=5mm, Reference Value = 4.434 V/m; Power Drift = -0.16 dB

Peak SAR (extrapolated) = 0.0710 W/kg

SAR(1 g) = 0.035 W/kg; SAR(10 g) = 0.018 W/kg Maximum value of SAR (measured) = 0.0410 W/kg

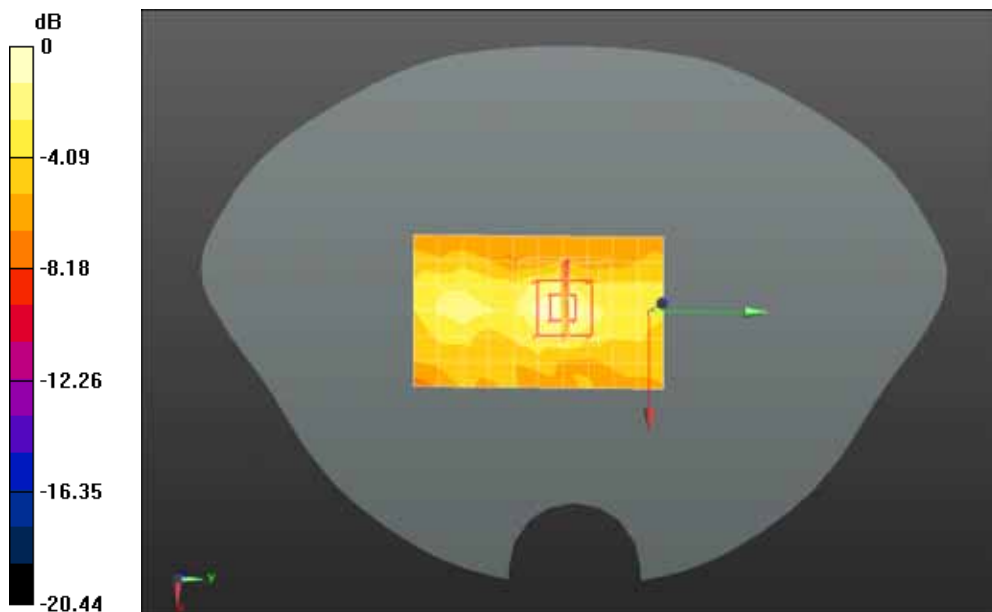

0 dB = 0.0410 W/kg = -13.87 dBW/kg

Date/Time: 05-05-2014

Test Laboratory: QuieTek Lab

802.11n(20MHz) 5745MHz-Horizontal Up (Dipole Antenna at 90°)

DUT: UltraSky MIMO 11abgn USB Dongle/CPE; Type: M27, M27C5, M27C5-16

Communication System: UID 0, CW (0); Communication System Band: 5GHz(5000.0-6000.0MHz); Duty Cycle: 1:1.0; Frequency: 5745 MHz; Medium parameters used: $f = 5745$ MHz; $\sigma = 5.95$ S/m; $\epsilon_r = 47.44$; $\rho = 1000$ kg/m³ ; Phantom section: Flat Section

Ambient temperature (°C): 21.5, Liquid temperature (°C): 21.0

DASY5 Configuration:

- Probe: EX3DV4 - SN3710; ConvF(6.88, 6.88, 6.88); Calibrated: 04/03/2014;
- Sensor-Surface: 4mm (Mechanical Surface Detection)
- Electronics: DAE4 Sn1220; Calibrated: 22/01/2014
- Phantom: SAM2; Type: SAM; Serial: TP1562
- Measurement SW: DASY52, Version 52.8 (7); SEMCAD X Version 14.6.10 (7164)

Configuration/802.11n(20) 5745MHz-Horizontal Up/Area Scan (7x10x1): Measurement grid: dx=10mm, dy=10mm

Maximum value of SAR (measured) = 0.0454 W/kg

Configuration/802.11n(20) 5745MHz-Horizontal Up/Zoom Scan (5x5x7)/Cube 0: Measurement grid: dx=8mm, dy=8mm, dz=5mm, Reference Value = 3.201 V/m; Power Drift = 0.18 dB

Peak SAR (extrapolated) = 0.0760 W/kg

SAR(1 g) = 0.041 W/kg; SAR(10 g) = 0.024 W/kg Maximum value of SAR (measured) = 0.0451 W/kg

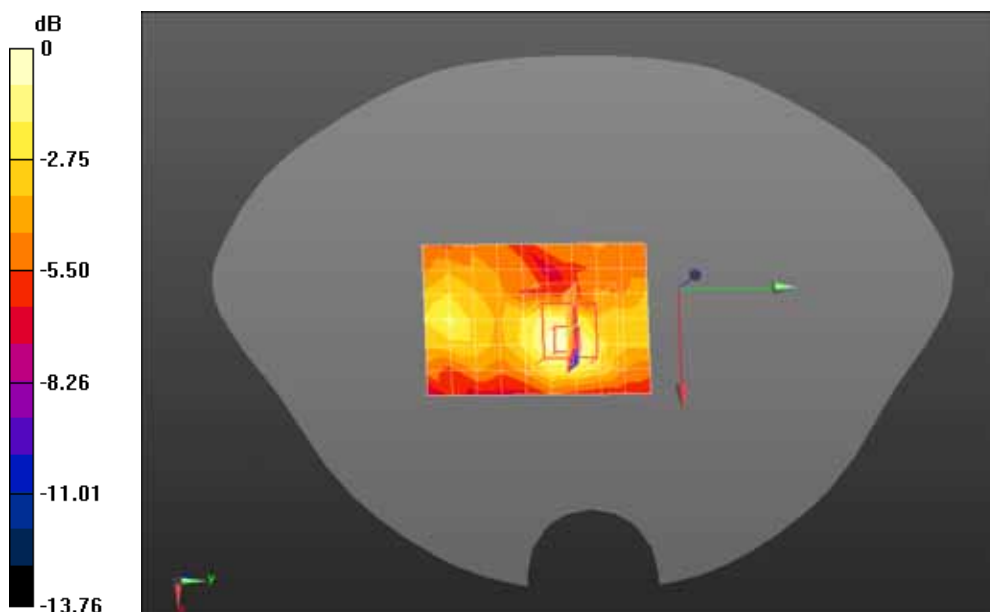

0 dB = 0.0451 W/kg = -13.46 dBW/kg

Date/Time: 05-05-2014

Test Laboratory: QuieTek Lab

802.11n(40MHz) 5190MHz-Horizontal Up (Dipole Antenna at 90°)

DUT: UltraSky MIMO 11abgn USB Dongle/CPE; Type: M27, M27C5, M27C5-16

Communication System: UID 0, CW (0); Communication System Band: 5GHz(5000.0-6000.0MHz); Duty Cycle: 1:1.0; Frequency: 5190 MHz; Medium parameters used: $f = 5190$ MHz; $\sigma = 5.13$ S/m; $\epsilon_r = 49.98$; $\rho = 1000$ kg/m³ ; Phantom section: Flat Section

Ambient temperature (°C): 21.5, Liquid temperature (°C): 21.0

DASY5 Configuration:

- Probe: EX3DV4 - SN3710; ConvF(6.88, 6.88, 6.88); Calibrated: 04/03/2014;
- Sensor-Surface: 4mm (Mechanical Surface Detection)
- Electronics: DAE4 Sn1220; Calibrated: 22/01/2014
- Phantom: SAM2; Type: SAM; Serial: TP1562
- Measurement SW: DASY52, Version 52.8 (7); SEMCAD X Version 14.6.10 (7164)

Configuration/802.11n(40) 5190MHz-Horizontal Up/Area Scan (7x11x1): Measurement grid: dx=10mm, dy=10mm

Maximum value of SAR (measured) = 0.0137 W/kg

Configuration/802.11n(40) 5190MHz-Horizontal Up/Zoom Scan (5x5x7)/Cube 0: Measurement grid: dx=8mm, dy=8mm, dz=5mm, Reference Value = 2.330 V/m; Power Drift = -0.02 dB

Peak SAR (extrapolated) = 0.0220 W/kg

SAR(1 g) = 0.012 W/kg; SAR(10 g) = 0.00973 W/kg Maximum value of SAR (measured) = 0.0133 W/kg

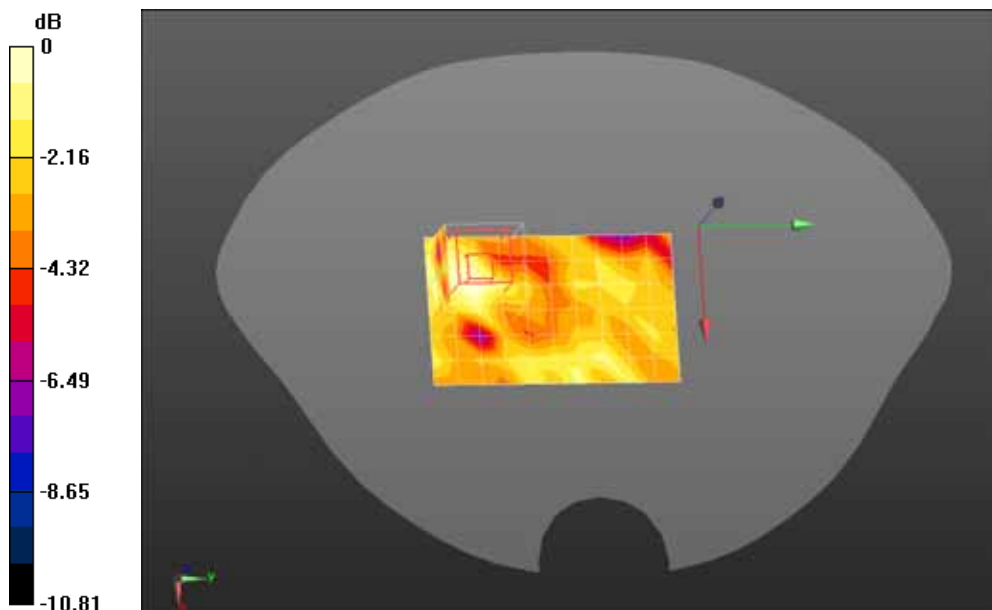

0 dB = 0.0133 W/kg = -18.76 dBW/kg

Date/Time: 05-05-2014

Test Laboratory: QuieTek Lab

802.11n(40MHz) 5755MHz-Horizontal Up (Dipole Antenna at 90°)

DUT: UltraSky MIMO 11abgn USB Dongle/CPE; Type: M27, M27C5, M27C5-16

Communication System: UID 0, CW (0); Communication System Band: 5GHz(5000.0-6000.0MHz); Duty Cycle: 1:1.0; Frequency: 5755 MHz; Medium parameters used: $f = 5755 \text{ MHz}$; $\sigma = 5.97 \text{ S/m}$; $\epsilon_r = 47.41$; $\rho = 1000 \text{ kg/m}^3$; Phantom section: Flat Section

Ambient temperature (°C): 21.5, Liquid temperature (°C): 21.0

DASY5 Configuration:

- Probe: EX3DV4 - SN3710; ConvF(4.22, 4.22, 4.22); Calibrated: 04/03/2014;
- Sensor-Surface: 2mm (Mechanical Surface Detection)
- Electronics: DAE4 Sn1220; Calibrated: 22/01/2014
- Phantom: SAM1; Type: SAM; Serial: TP1561
- Measurement SW: DASY52, Version 52.8 (7); SEMCAD X Version 14.6.10 (7164)

Configuration/802.11a 5755MHz-Horizontal Up/Area Scan (7x9x1): Measurement grid: dx=10mm, dy=10mm

Maximum value of SAR (measured) = 0.0458 W/kg

Configuration/802.11a 5755MHz-Horizontal Up/Zoom Scan (7x7x5)/Cube 0: Measurement grid:

dx=4mm, dy=4mm, dz=2.5mm, Reference Value = 2.532 V/m; Power Drift = 0.19 dB

Peak SAR (extrapolated) = 0.0610 W/kg

SAR(1 g) = 0.041 W/kg; SAR(10 g) = 0.032 W/kg Maximum value of SAR (measured) = 0.0611 W/kg

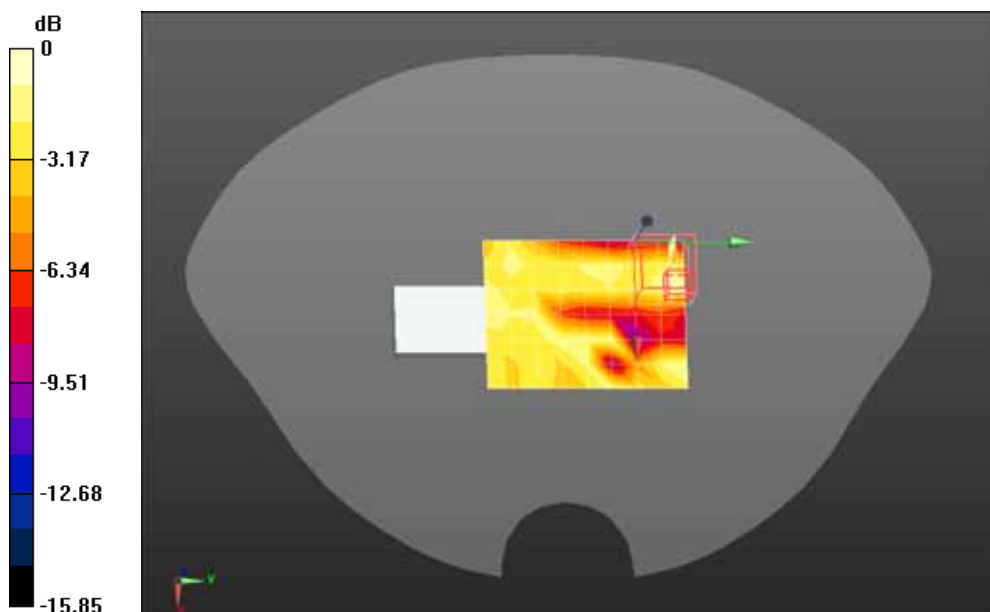

0 dB = 0.0611 W/kg = -12.14 dBW/kg

Appendix C. Test Setup Photographs & EUT Photographs

SAR Test Setup Photographs



PCB Antenna (Horizontal Up)

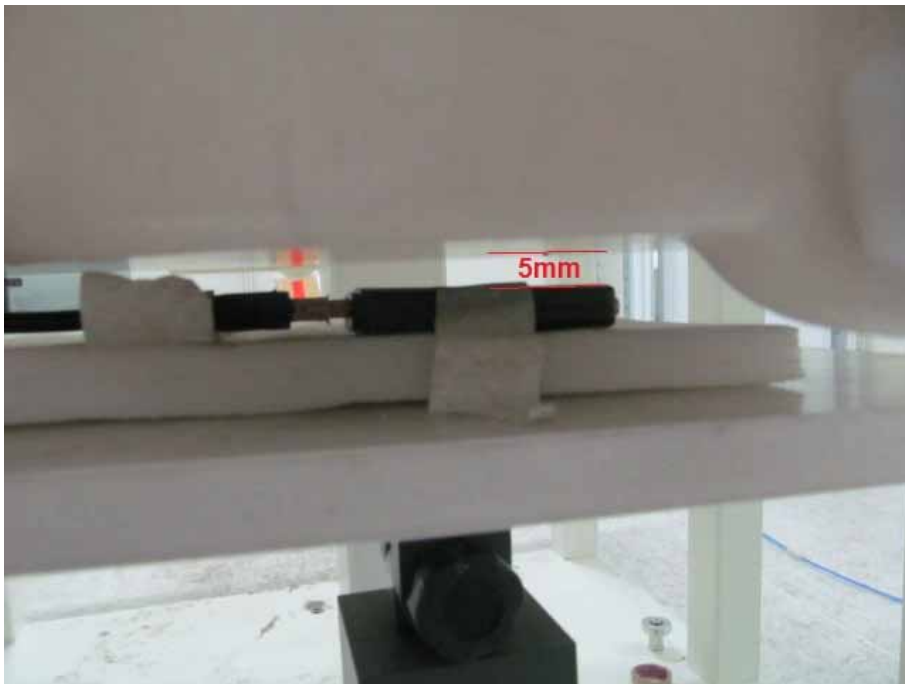

PCB Antenna (Horizontal Down)

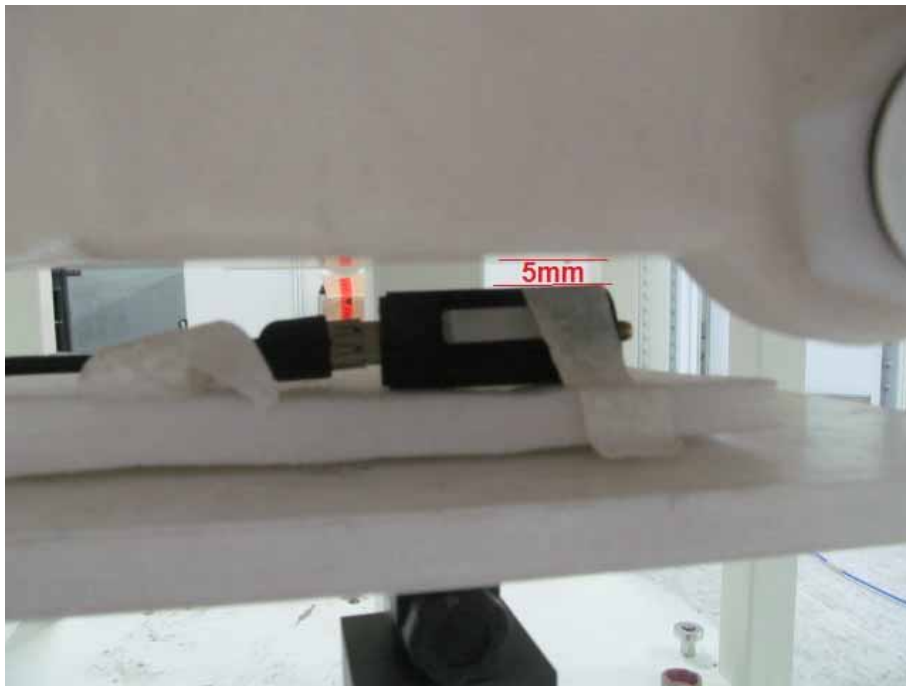

PCB Antenna (Vertical Front)

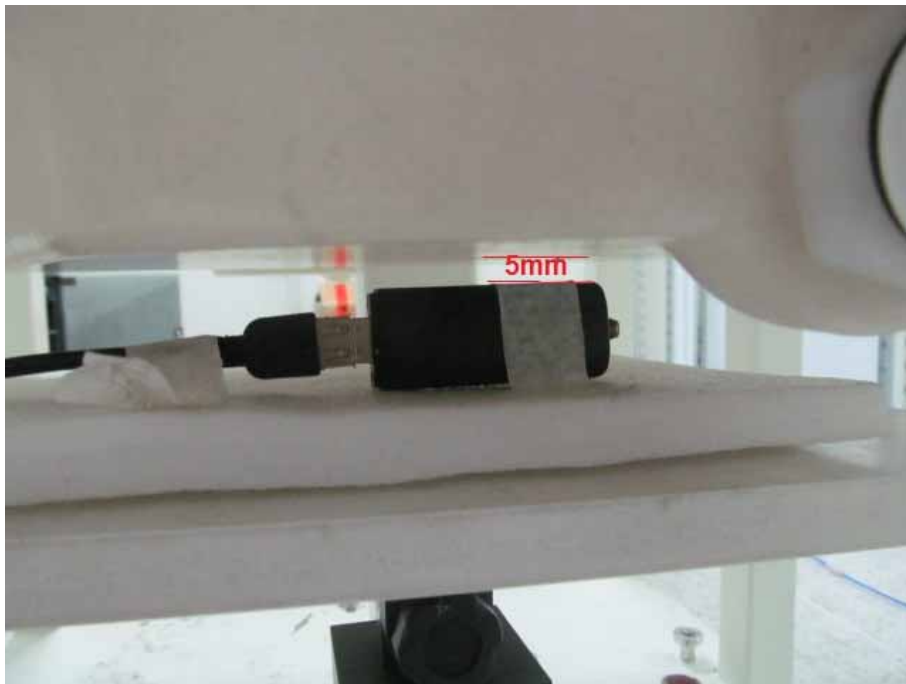

PCB Antenna (Vertical Back)



PCB Antenna (Tip)



Dipole Antenna (Horizontal Up-0°)



Dipole Antenna (Horizontal Down-0°)



Dipole Antenna (Horizontal Down-90°)

Depth of the liquid in the phantom – Zoom in

Note: The position used in the measurements were according to IEEE 1528 - 2003

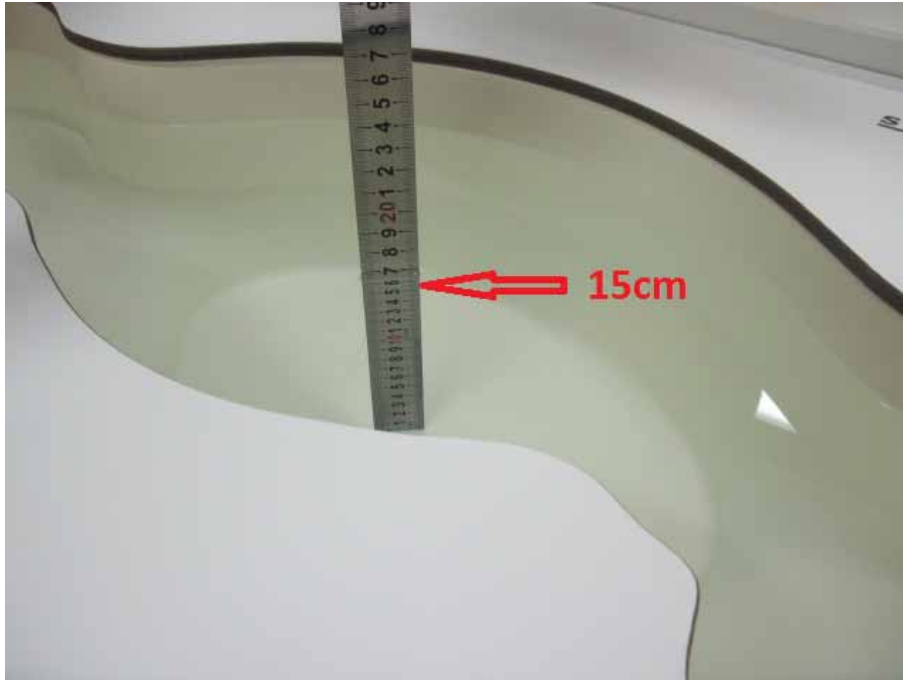

External photos

(1) EUT Photo



(2) EUT Photo



(3) EUT Photo



(4) EUT Photo



(5) EUT Photo

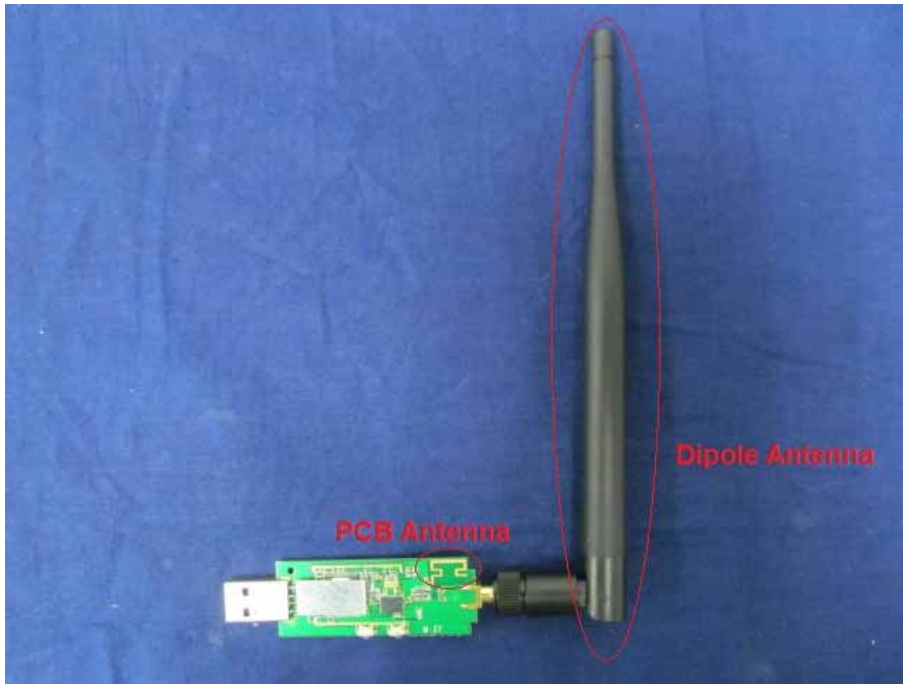

Appendix D. Probe Calibration Data

**Calibration Laboratory of
Schmid & Partner
Engineering AG**
Zeughausstrasse 43, 8004 Zurich, Switzerland



S Schweizerischer Kalibrierdienst
C Service suisse d'étalonnage
S Servizio svizzero di taratura
Swiss Calibration Service

Accredited by the Swiss Accreditation Service (SAS)
The Swiss Accreditation Service is one of the signatories to the EA
Multilateral Agreement for the recognition of calibration certificates

Accreditation No.: **SCS 108**

Client **Quietek (Auden)**

Certificate No: **EX3-3710_Mar14**

CALIBRATION CERTIFICATE

Object	EX3DV4 - SN:3710
Calibration procedure(s)	QA CAL-01.v9, QA CAL-12.v9, QA CAL-14.v4, QA CAL-23.v5, QA CAL-25.v6 Calibration procedure for dosimetric E-field probes
Calibration date:	March 4, 2014
<p>This calibration certificate documents the traceability to national standards, which realize the physical units of measurements (SI). The measurements and the uncertainties with confidence probability are given on the following pages and are part of the certificate.</p> <p>All calibrations have been conducted in the closed laboratory facility: environment temperature (22 ± 3)°C and humidity < 70%.</p> <p>Calibration Equipment used (M&TE critical for calibration)</p>	

Primary Standards	ID	Cal Date (Certificate No.)	Scheduled Calibration
Power meter E4419B	GB41293874	04-Apr-13 (No. 217-01733)	Apr-14
Power sensor E4412A	MY41498087	04-Apr-13 (No. 217-01733)	Apr-14
Reference 3 dB Attenuator	SN: S5054 (3c)	04-Apr-13 (No. 217-01737)	Apr-14
Reference 20 dB Attenuator	SN: S5277 (20x)	04-Apr-13 (No. 217-01735)	Apr-14
Reference 30 dB Attenuator	SN: S5129 (30b)	04-Apr-13 (No. 217-01738)	Apr-14
Reference Probe ES3DV2	SN: 3013	30-Dec-13 (No. ES3-3013_Dec13)	Dec-14
DAE4	SN: 660	13-Dec-13 (No. DAE4-660_Dec13)	Dec-14
Secondary Standards	ID	Check Date (in house)	Scheduled Check
RF generator HP 8648C	US3642U01700	4-Aug-99 (in house check Apr-13)	In house check: Apr-16
Network Analyzer HP 8753E	US37390585	18-Oct-01 (in house check Oct-13)	In house check: Oct-14

Calibrated by:	Name Jeton Kastrati	Function Laboratory Technician	Signature
Approved by:	Name Katja Pokovic	Function Technical Manager	Signature
			Issued: March 4, 2014
This calibration certificate shall not be reproduced except in full without written approval of the laboratory.			

**Calibration Laboratory of
Schmid & Partner
Engineering AG**
Zeughausstrasse 43, 8004 Zurich, Switzerland



S Schweizerischer Kalibrierdienst
S Service suisse d'étalonnage
S Servizio svizzero di taratura
S Swiss Calibration Service

Accredited by the Swiss Accreditation Service (SAS)
The Swiss Accreditation Service is one of the signatories to the EA
Multilateral Agreement for the recognition of calibration certificates

Accreditation No.: **SCS 108**

Glossary:

TSL	tissue simulating liquid
NORM _{x,y,z}	sensitivity in free space
ConvF	sensitivity in TSL / NORM _{x,y,z}
DCP	diode compression point
CF	crest factor (1/duty_cycle) of the RF signal
A, B, C, D	modulation dependent linearization parameters
Polarization φ	φ rotation around probe axis
Polarization ϑ	ϑ rotation around an axis that is in the plane normal to probe axis (at measurement center), i.e., $\vartheta = 0$ is normal to probe axis
Connector Angle	information used in DASY system to align probe sensor X to the robot coordinate system

Calibration is Performed According to the Following Standards:

- a) IEEE Std 1528-2013, "IEEE Recommended Practice for Determining the Peak Spatial-Averaged Specific Absorption Rate (SAR) in the Human Head from Wireless Communications Devices: Measurement Techniques", June 2013
- b) IEC 62209-1, "Procedure to measure the Specific Absorption Rate (SAR) for hand-held devices used in close proximity to the ear (frequency range of 300 MHz to 3 GHz)", February 2005

Methods Applied and Interpretation of Parameters:

- **NORM_{x,y,z}**: Assessed for E-field polarization $\vartheta = 0$ ($f \leq 900$ MHz in TEM-cell; $f > 1800$ MHz: R22 waveguide). NORM_{x,y,z} are only intermediate values, i.e., the uncertainties of NORM_{x,y,z} does not affect the E²-field uncertainty inside TSL (see below ConvF).
- **NORM(f)_{x,y,z}** = NORM_{x,y,z} * frequency_response (see Frequency Response Chart). This linearization is implemented in DASY4 software versions later than 4.2. The uncertainty of the frequency response is included in the stated uncertainty of ConvF.
- **DCP_{x,y,z}**: DCP are numerical linearization parameters assessed based on the data of power sweep with CW signal (no uncertainty required). DCP does not depend on frequency nor media.
- **PAR**: PAR is the Peak to Average Ratio that is not calibrated but determined based on the signal characteristics
- **A_{x,y,z}; B_{x,y,z}; C_{x,y,z}; D_{x,y,z}; VR_{x,y,z}**: A, B, C, D are numerical linearization parameters assessed based on the data of power sweep for specific modulation signal. The parameters do not depend on frequency nor media. VR is the maximum calibration range expressed in RMS voltage across the diode.
- **ConvF and Boundary Effect Parameters**: Assessed in flat phantom using E-field (or Temperature Transfer Standard for $f \leq 800$ MHz) and inside waveguide using analytical field distributions based on power measurements for $f > 800$ MHz. The same setups are used for assessment of the parameters applied for boundary compensation (alpha, depth) of which typical uncertainty values are given. These parameters are used in DASY4 software to improve probe accuracy close to the boundary. The sensitivity in TSL corresponds to NORM_{x,y,z} * ConvF whereby the uncertainty corresponds to that given for ConvF. A frequency dependent ConvF is used in DASY version 4.4 and higher which allows extending the validity from ± 50 MHz to ± 100 MHz.
- **Spherical isotropy (3D deviation from isotropy)**: in a field of low gradients realized using a flat phantom exposed by a patch antenna.
- **Sensor Offset**: The sensor offset corresponds to the offset of virtual measurement center from the probe tip (on probe axis). No tolerance required.
- **Connector Angle**: The angle is assessed using the information gained by determining the NORM_x (no uncertainty required).

EX3DV4 – SN:3710

March 4, 2014

Probe EX3DV4

SN:3710

Manufactured: July 21, 2009
Calibrated: March 4, 2014

Calibrated for DASY/EASY Systems
(Note: non-compatible with DASY2 system!)

EX3DV4- SN:3710

March 4, 2014

DASY/EASY - Parameters of Probe: EX3DV4 - SN:3710

Basic Calibration Parameters

	Sensor X	Sensor Y	Sensor Z	Unc (k=2)
Norm ($\mu\text{V}/(\text{V}/\text{m})^2$) ^A	0.51	0.56	0.44	± 10.1 %
DCP (mV) ^B	100.3	97.6	101.3	

Modulation Calibration Parameters

UID	Communication System Name		A dB	B dB $\sqrt{\mu\text{V}}$	C	D dB	VR mV	Unc ^E (k=2)
0	CW	X	0.0	0.0	1.0	0.00	137.9	±3.5 %
		Y	0.0	0.0	1.0		136.7	
		Z	0.0	0.0	1.0		139.8	

The reported uncertainty of measurement is stated as the standard uncertainty of measurement multiplied by the coverage factor k=2, which for a normal distribution corresponds to a coverage probability of approximately 95%.

^A The uncertainties of NormX,Y,Z do not affect the E²-field uncertainty inside TSL (see Pages 5 and 6).

^B Numerical linearization parameter: uncertainty not required.

^E Uncertainty is determined using the max. deviation from linear response applying rectangular distribution and is expressed for the square of the field value.

EX3DV4- SN:3710

March 4, 2014

DASY/EASY - Parameters of Probe: EX3DV4 - SN:3710

Calibration Parameter Determined in Head Tissue Simulating Media

f (MHz) ^C	Relative Permittivity ^F	Conductivity (S/m) ^F	ConvF X	ConvF Y	ConvF Z	Alpha ^G	Depth ^G (mm)	Unct. (k=2)
450	43.5	0.87	10.42	10.42	10.42	0.17	2.22	± 13.3 %
750	41.9	0.89	9.76	9.76	9.76	0.62	0.69	± 12.0 %
835	41.5	0.90	9.56	9.56	9.56	0.57	0.69	± 12.0 %
900	41.5	0.97	9.42	9.42	9.42	0.53	0.72	± 12.0 %
1810	40.0	1.40	7.74	7.74	7.74	0.41	0.94	± 12.0 %
1900	40.0	1.40	7.72	7.72	7.72	0.49	0.85	± 12.0 %
2450	39.2	1.80	7.04	7.04	7.04	0.39	1.03	± 12.0 %
2600	39.0	1.96	6.87	6.87	6.87	0.60	0.80	± 12.0 %
3500	37.9	2.91	6.82	6.82	6.82	0.55	0.88	± 13.1 %
5200	36.0	4.66	4.91	4.91	4.91	0.40	1.80	± 13.1 %
5500	35.6	4.96	4.63	4.63	4.63	0.40	1.80	± 13.1 %
5800	35.3	5.27	4.43	4.43	4.43	0.40	1.80	± 13.1 %

^C Frequency validity of ± 100 MHz only applies for DASY v4.4 and higher (see Page 2), else it is restricted to ± 50 MHz. The uncertainty is the RSS of the ConvF uncertainty at calibration frequency and the uncertainty for the indicated frequency band.

^F At frequencies below 3 GHz, the validity of tissue parameters (ϵ and σ) can be relaxed to ± 10% if liquid compensation formula is applied to measured SAR values. At frequencies above 3 GHz, the validity of tissue parameters (ϵ and σ) is restricted to ± 5%. The uncertainty is the RSS of the ConvF uncertainty for indicated target tissue parameters.

^G Alpha/Depth are determined during calibration. SPEAG warrants that the remaining deviation due to the boundary effect after compensation is always less than ± 1% for frequencies below 3 GHz and below ± 2% for frequencies between 3-6 GHz at any distance larger than half the probe tip diameter from the boundary.

EX3DV4- SN:3710

March 4, 2014

DASY/EASY - Parameters of Probe: EX3DV4 - SN:3710

Calibration Parameter Determined in Body Tissue Simulating Media

f (MHz) ^C	Relative Permittivity ^F	Conductivity (S/m) ^F	ConvF X	ConvF Y	ConvF Z	Alpha ^G	Depth (mm) ^G	Unct. (k=2)
450	56.7	0.94	10.53	10.53	10.53	0.10	1.00	± 13.3 %
750	55.5	0.96	9.28	9.28	9.28	0.39	0.93	± 12.0 %
835	55.2	0.97	9.22	9.22	9.22	0.65	0.72	± 12.0 %
900	55.0	1.05	9.04	9.04	9.04	0.75	0.67	± 12.0 %
1810	53.3	1.52	7.36	7.36	7.36	0.80	0.62	± 12.0 %
1900	53.3	1.52	7.25	7.25	7.25	0.55	0.76	± 12.0 %
2450	52.7	1.95	6.88	6.88	6.88	0.80	0.58	± 12.0 %
2600	52.5	2.16	6.67	6.67	6.67	0.80	0.50	± 12.0 %
3500	51.3	3.31	6.29	6.29	6.29	0.44	1.02	± 13.1 %
5200	49.0	5.30	4.22	4.22	4.22	0.50	1.90	± 13.1 %
5500	48.6	5.65	3.91	3.91	3.91	0.50	1.90	± 13.1 %
5800	48.2	6.00	4.00	4.00	4.00	0.50	1.90	± 13.1 %

^C Frequency validity of ± 100 MHz only applies for DASY v4.4 and higher (see Page 2), else it is restricted to ± 50 MHz. The uncertainty is the RSS of the ConvF uncertainty at calibration frequency and the uncertainty for the indicated frequency band.

^F At frequencies below 3 GHz, the validity of tissue parameters (ϵ and σ) can be relaxed to ± 10% if liquid compensation formula is applied to measured SAR values. At frequencies above 3 GHz, the validity of tissue parameters (ϵ and σ) is restricted to ± 5%. The uncertainty is the RSS of the ConvF uncertainty for indicated target tissue parameters.

^G Alpha/Depth are determined during calibration. SPEAG warrants that the remaining deviation due to the boundary effect after compensation is always less than ± 1% for frequencies below 3 GHz and below ± 2% for frequencies between 3-6 GHz at any distance larger than half the probe tip diameter from the boundary.

EX3DV4-SN:3710

March 4, 2014

Frequency Response of E-Field (TEM-Cell: ifi1110 EXX, Waveguide: R22)

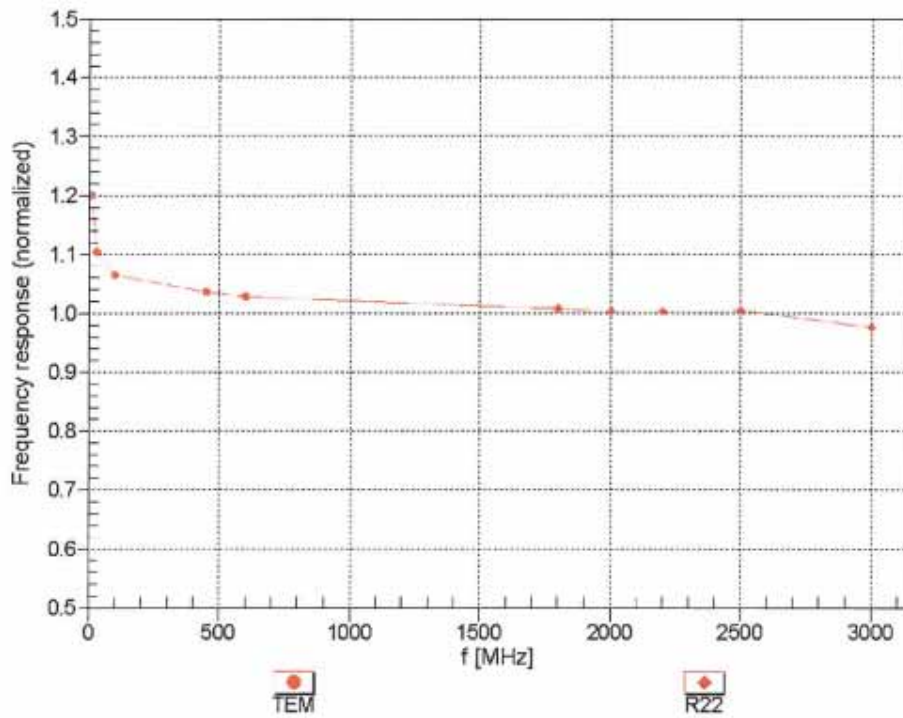

Uncertainty of Frequency Response of E-field: $\pm 6.3\%$ (k=2)

EX3DV4- SN:3710

March 4, 2014

Receiving Pattern (ϕ), $\theta = 0^\circ$

f=600 MHz,TEM

f=1800 MHz,R22

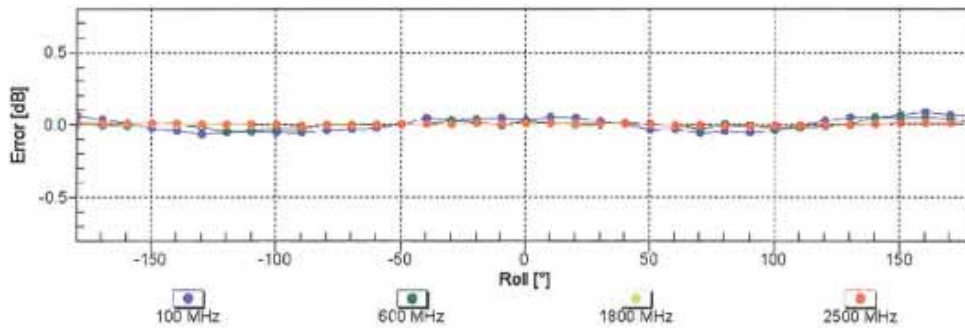
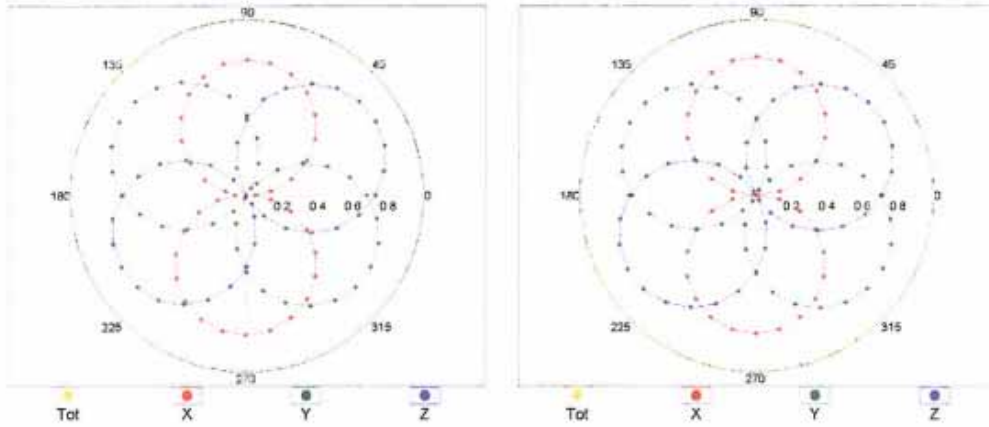

Uncertainty of Axial Isotropy Assessment: $\pm 0.5\%$ (k=2)

EX3DV4- SN:3710

March 4, 2014

Dynamic Range $f(SAR_{head})$
 (TEM cell , $f_{eval}=1900$ MHz)

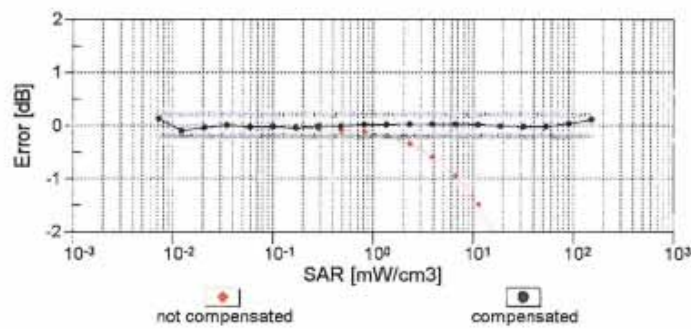
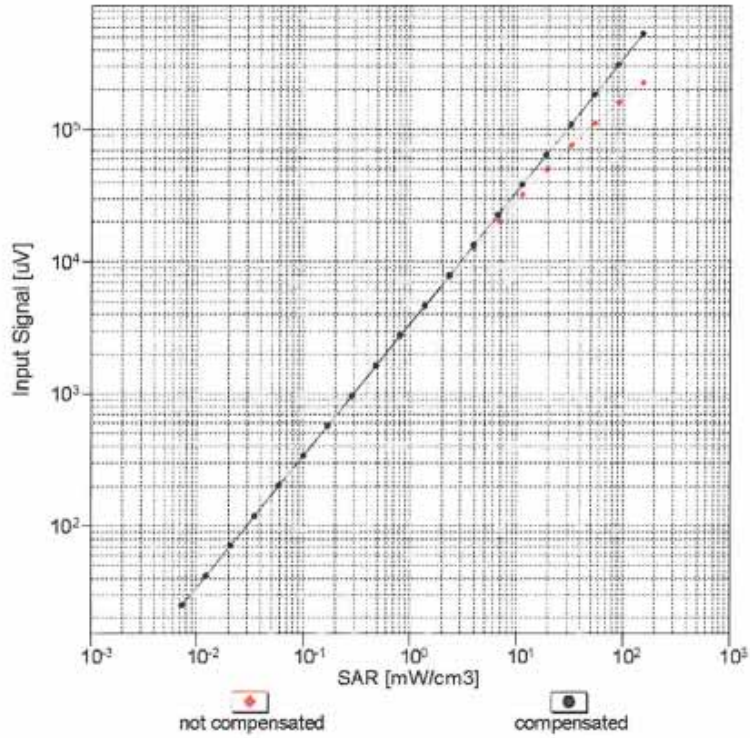

Uncertainty of Linearity Assessment: $\pm 0.6\%$ ($k=2$)

EX3DV4- SN:3710

March 4, 2014

Conversion Factor Assessment

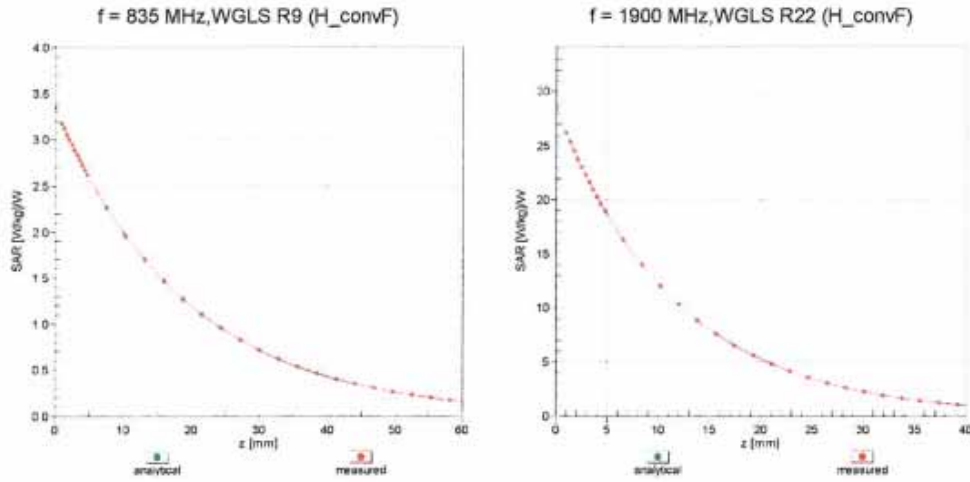

Deviation from Isotropy in Liquid

Error (ϕ, θ), $f = 900$ MHz

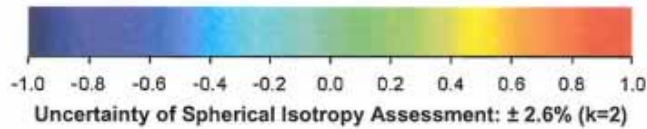
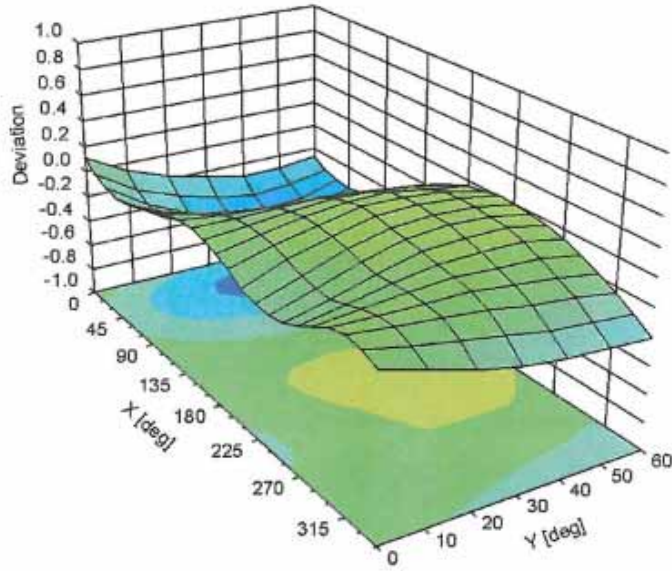

EX3DV4- SN:3710

March 4, 2014

DASY/EASY - Parameters of Probe: EX3DV4 - SN:3710

Other Probe Parameters

Sensor Arrangement	Triangular
Connector Angle (°)	-19.6
Mechanical Surface Detection Mode	enabled
Optical Surface Detection Mode	disabled
Probe Overall Length	337 mm
Probe Body Diameter	10 mm
Tip Length	9 mm
Tip Diameter	2.5 mm
Probe Tip to Sensor X Calibration Point	1 mm
Probe Tip to Sensor Y Calibration Point	1 mm
Probe Tip to Sensor Z Calibration Point	1 mm
Recommended Measurement Distance from Surface	2 mm

Appendix E. Dipole Calibration Data

**Calibration Laboratory of
Schmid & Partner
Engineering AG**
Zeughausstrasse 43, 8004 Zurich, Switzerland



S Schweizerischer Kalibrierdienst
C Service suisse d'étalonnage
S Servizio svizzero di taratura
S Swiss Calibration Service

Accredited by the Swiss Accreditation Service (SAS)
The Swiss Accreditation Service is one of the signatories to the EA
Multilateral Agreement for the recognition of calibration certificates

Accreditation No.: **SCS 108**

Client **Quietek-CN (Auden)**

Certificate No: **D2450V2-839_Feb14**

CALIBRATION CERTIFICATE

Object **D2450V2 - SN: 839**

Calibration procedure(s) **QA CAL-05.v9
Calibration procedure for dipole validation kits above 700 MHz**

Calibration date: **February 24, 2014**

This calibration certificate documents the traceability to national standards, which realize the physical units of measurements (SI).
The measurements and the uncertainties with confidence probability are given on the following pages and are part of the certificate.

All calibrations have been conducted in the closed laboratory facility: environment temperature (22 ± 3)°C and humidity < 70%.

Calibration Equipment used (M&TE critical for calibration)

Primary Standards	ID #	Cal Date (Certificate No.)	Scheduled Calibration
Power meter EPM-442A	GB37480704	09-Oct-13 (No. 217-01827)	Oct-14
Power sensor HP 8481A	US37292783	09-Oct-13 (No. 217-01827)	Oct-14
Power sensor HP 8481A	MY41092317	09-Oct-13 (No. 217-01828)	Oct-14
Reference 20 dB Attenuator	SN: 5058 (20k)	04-Apr-13 (No. 217-01736)	Apr-14
Type-N mismatch combination	SN: 5047.3 / 06327	04-Apr-13 (No. 217-01739)	Apr-14
Reference Probe ES3DV3	SN: 3205	30-Dec-13 (No. ES3-3205_Dec13)	Dec-14
DAE4	SN: 601	25-Apr-13 (No. DAE4-601_Apr13)	Apr-14
Secondary Standards	ID #	Check Date (in house)	Scheduled Check
RF generator R&S SMT-06	100005	04-Aug-99 (in house check Oct-13)	In house check: Oct-16
Network Analyzer HP 8753E	US37390585 S4206	18-Oct-01 (in house check Oct-13)	In house check: Oct-14

Calibrated by: **Name: Israe El-Naouq, Function: Laboratory Technician, Signature: [Handwritten Signature]**

Approved by: **Name: Katja Pokovic, Function: Technical Manager, Signature: [Handwritten Signature]**

Issued: February 24, 2014

This calibration certificate shall not be reproduced except in full without written approval of the laboratory.

Calibration Laboratory of
 Schmid & Partner
 Engineering AG
 Zeughausstrasse 43, 8004 Zurich, Switzerland



S Schweizerischer Kalibrierdienst
C Service suisse d'étalonnage
S Servizio svizzero di taratura
S Swiss Calibration Service

Accredited by the Swiss Accreditation Service (SAS)
 The Swiss Accreditation Service is one of the signatories to the EA
 Multilateral Agreement for the recognition of calibration certificates

Accreditation No.: **SCS 108**

Glossary:

TSL tissue simulating liquid
 ConvF sensitivity in TSL / NORM x,y,z
 N/A not applicable or not measured

Calibration is Performed According to the Following Standards:

- a) IEEE Std 1528-2013, "IEEE Recommended Practice for Determining the Peak Spatial-Averaged Specific Absorption Rate (SAR) in the Human Head from Wireless Communications Devices: Measurement Techniques", June 2013
- b) IEC 62209-1, "Procedure to measure the Specific Absorption Rate (SAR) for hand-held devices used in close proximity to the ear (frequency range of 300 MHz to 3 GHz)", February 2005
- c) KDB 865664, "SAR Measurement Requirements for 100 MHz to 6 GHz"

Additional Documentation:

- d) DASY4/5 System Handbook

Methods Applied and Interpretation of Parameters:

- *Measurement Conditions:* Further details are available from the Validation Report at the end of the certificate. All figures stated in the certificate are valid at the frequency indicated.
- *Antenna Parameters with TSL:* The dipole is mounted with the spacer to position its feed point exactly below the center marking of the flat phantom section, with the arms oriented parallel to the body axis.
- *Feed Point Impedance and Return Loss:* These parameters are measured with the dipole positioned under the liquid filled phantom. The impedance stated is transformed from the measurement at the SMA connector to the feed point. The Return Loss ensures low reflected power. No uncertainty required.
- *Electrical Delay:* One-way delay between the SMA connector and the antenna feed point. No uncertainty required.
- *SAR measured:* SAR measured at the stated antenna input power.
- *SAR normalized:* SAR as measured, normalized to an input power of 1 W at the antenna connector.
- *SAR for nominal TSL parameters:* The measured TSL parameters are used to calculate the nominal SAR result.

The reported uncertainty of measurement is stated as the standard uncertainty of measurement multiplied by the coverage factor k=2, which for a normal distribution corresponds to a coverage probability of approximately 95%.

Measurement Conditions

DASY system configuration, as far as not given on page 1.

DASY Version	DASY5	V52.8.7
Extrapolation	Advanced Extrapolation	
Phantom	Modular Flat Phantom	
Distance Dipole Center - TSL	10 mm	with Spacer
Zoom Scan Resolution	dx, dy, dz = 5 mm	
Frequency	2450 MHz ± 1 MHz	

Head TSL parameters

The following parameters and calculations were applied.

	Temperature	Permittivity	Conductivity
Nominal Head TSL parameters	22.0 °C	39.2	1.80 mho/m
Measured Head TSL parameters	(22.0 ± 0.2) °C	38.1 ± 6 %	1.86 mho/m ± 6 %
Head TSL temperature change during test	< 0.5 °C	----	----

SAR result with Head TSL

SAR averaged over 1 cm ³ (1 g) of Head TSL	Condition	
SAR measured	250 mW input power	13.3 W/kg
SAR for nominal Head TSL parameters	normalized to 1W	52.0 W/kg ± 17.0 % (k=2)

SAR averaged over 10 cm ³ (10 g) of Head TSL	condition	
SAR measured	250 mW input power	6.15 W/kg
SAR for nominal Head TSL parameters	normalized to 1W	24.3 W/kg ± 16.5 % (k=2)

Body TSL parameters

The following parameters and calculations were applied.

	Temperature	Permittivity	Conductivity
Nominal Body TSL parameters	22.0 °C	52.7	1.95 mho/m
Measured Body TSL parameters	(22.0 ± 0.2) °C	50.7 ± 6 %	2.02 mho/m ± 6 %
Body TSL temperature change during test	< 0.5 °C	----	----

SAR result with Body TSL

SAR averaged over 1 cm ³ (1 g) of Body TSL	Condition	
SAR measured	250 mW input power	12.8 W/kg
SAR for nominal Body TSL parameters	normalized to 1W	49.9 W/kg ± 17.0 % (k=2)

SAR averaged over 10 cm ³ (10 g) of Body TSL	condition	
SAR measured	250 mW input power	5.86 W/kg
SAR for nominal Body TSL parameters	normalized to 1W	23.1 W/kg ± 16.5 % (k=2)

Appendix

Antenna Parameters with Head TSL

Impedance, transformed to feed point	54.5 Ω + 2.4 j Ω
Return Loss	- 26.2 dB

Antenna Parameters with Body TSL

Impedance, transformed to feed point	50.6 Ω + 4.3 j Ω
Return Loss	- 27.4 dB

General Antenna Parameters and Design

Electrical Delay (one direction)	1.159 ns
----------------------------------	----------

After long term use with 100W radiated power, only a slight warming of the dipole near the feedpoint can be measured.

The dipole is made of standard semirigid coaxial cable. The center conductor of the feeding line is directly connected to the second arm of the dipole. The antenna is therefore short-circuited for DC-signals. On some of the dipoles, small end caps are added to the dipole arms in order to improve matching when loaded according to the position as explained in the "Measurement Conditions" paragraph. The SAR data are not affected by this change. The overall dipole length is still according to the Standard.

No excessive force must be applied to the dipole arms, because they might bend or the soldered connections near the feedpoint may be damaged.

Additional EUT Data

Manufactured by	SPEAG
Manufactured on	July 20, 2009

DASY5 Validation Report for Head TSL

Date: 24.02.2014

Test Laboratory: SPEAG, Zurich, Switzerland

DUT: Dipole 2450 MHz; Type: D2450V2; Serial: D2450V2 - SN: 839

Communication System: UID 0 - CW; Frequency: 2450 MHz

Medium parameters used: $f = 2450$ MHz; $\sigma = 1.86$ S/m; $\epsilon_r = 38.1$; $\rho = 1000$ kg/m³

Phantom section: Flat Section

Measurement Standard: DASY5 (IEEE/IEC/ANSI C63.19-2007)

DASY52 Configuration:

- Probe: ES3DV3 - SN3205; ConvF(4.53, 4.53, 4.53); Calibrated: 30.12.2013;
- Sensor-Surface: 3mm (Mechanical Surface Detection)
- Electronics: DAE4 Sn601; Calibrated: 25.04.2013
- Phantom: Flat Phantom 5.0 (front); Type: QD000P50AA; Serial: 1001
- DASY52 52.8.7(1137); SEMCAD X 14.6.10(7164)

Dipole Calibration for Head Tissue/Pin=250 mW, d=10mm/Zoom Scan (7x7x7)/Cube 0:

Measurement grid: dx=5mm, dy=5mm, dz=5mm

Reference Value = 99.591 V/m; Power Drift = 0.05 dB

Peak SAR (extrapolated) = 27.9 W/kg

SAR(1 g) = 13.3 W/kg; SAR(10 g) = 6.15 W/kg

Maximum value of SAR (measured) = 17.0 W/kg

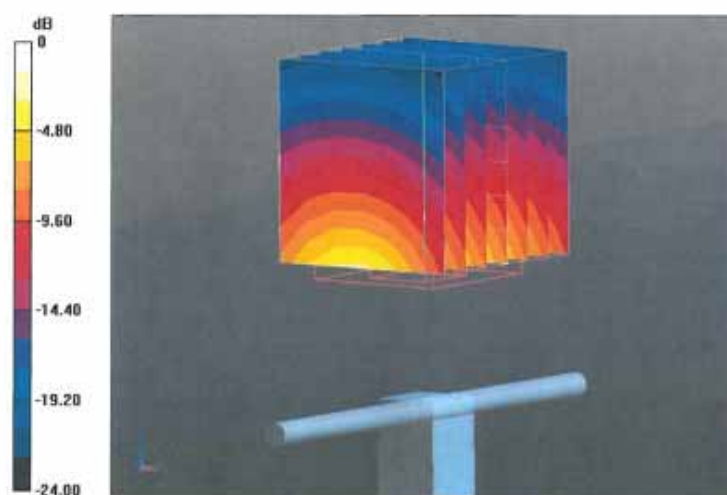

0 dB = 17.0 W/kg = 12.30 dBW/kg

Impedance Measurement Plot for Head TSL

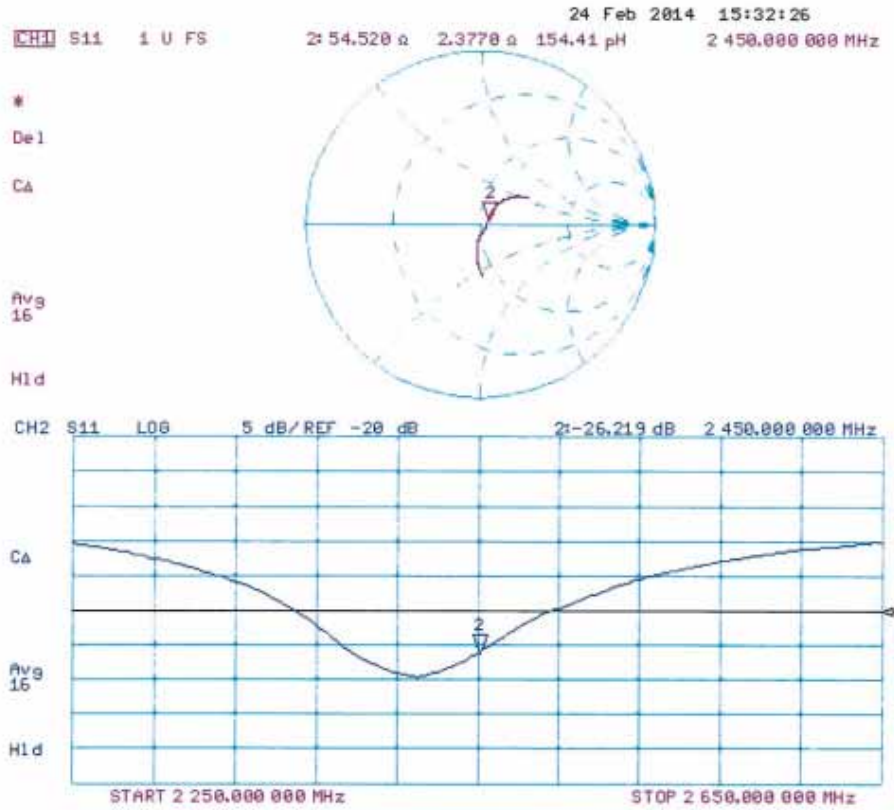

DASY5 Validation Report for Body TSL

Date: 24.02.2014

Test Laboratory: SPEAG, Zurich, Switzerland

DUT: Dipole 2450 MHz; Type: D2450V2; Serial: D2450V2 - SN: 839

Communication System: UID 0 - CW; Frequency: 2450 MHz

Medium parameters used: $f = 2450$ MHz; $\sigma = 2.02$ S/m; $\epsilon_r = 50.7$; $\rho = 1000$ kg/m³

Phantom section: Flat Section

Measurement Standard: DASY5 (IEEE/IEC/ANSI C63.19-2007)

DASY52 Configuration:

- Probe: ES3DV3 - SN3205; ConvF(4.35, 4.35, 4.35); Calibrated: 30.12.2013;
- Sensor-Surface: 3mm (Mechanical Surface Detection)
- Electronics: DAE4 Sn601; Calibrated: 25.04.2013
- Phantom: Flat Phantom 5.0 (back); Type: QD000P50AA; Serial: 1002
- DASY52 52.8.7(1137); SEMCAD X 14.6.10(7164)

Dipole Calibration for Body Tissue/Pin=250 mW, d=10mm/Zoom Scan (7x7x7)/Cube 0:

Measurement grid: dx=5mm, dy=5mm, dz=5mm

Reference Value = 94.267 V/m; Power Drift = -0.01 dB

Peak SAR (extrapolated) = 27.1 W/kg

SAR(1 g) = 12.8 W/kg; SAR(10 g) = 5.86 W/kg

Maximum value of SAR (measured) = 17.0 W/kg

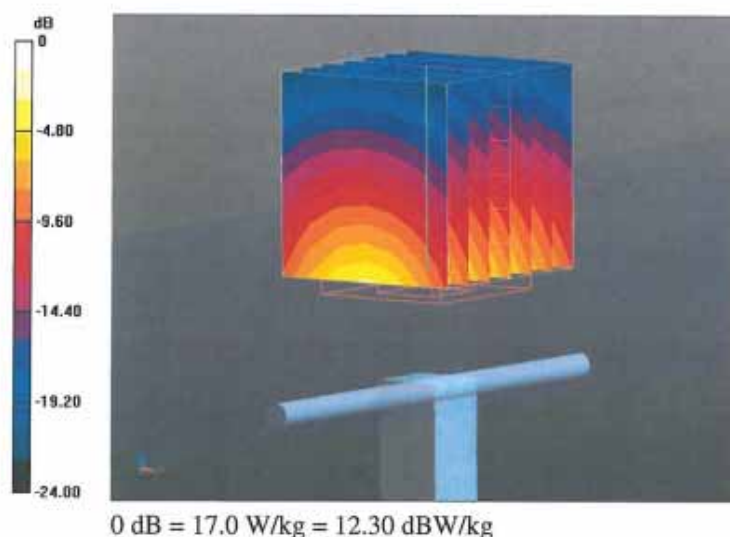

Impedance Measurement Plot for Body TSL

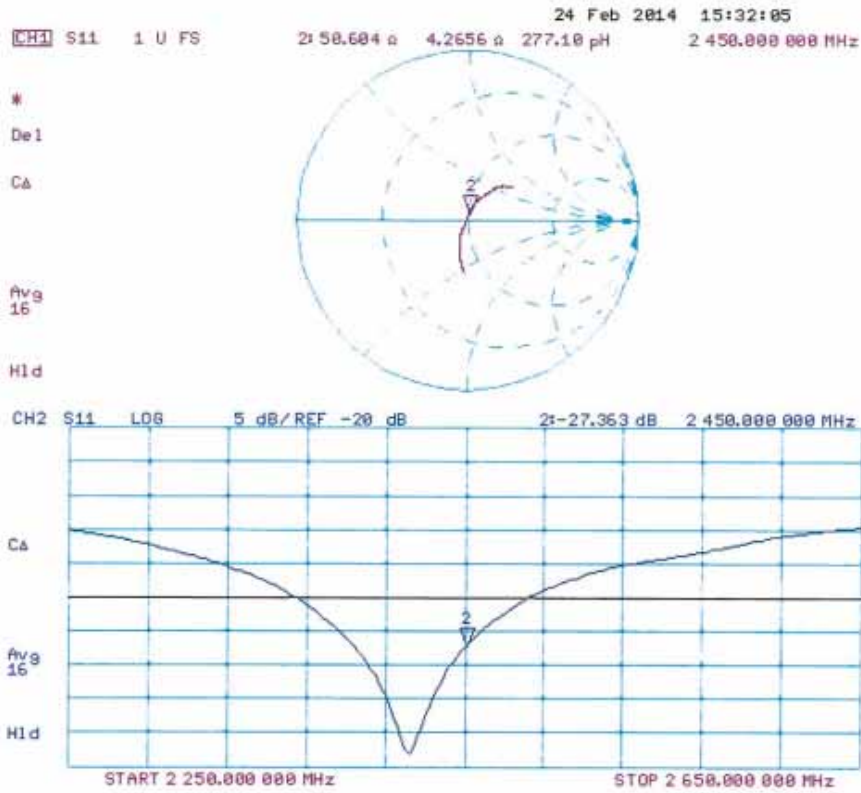

**Calibration Laboratory of
Schmid & Partner
Engineering AG**
Zeughausstrasse 43, 8004 Zurich, Switzerland



S Schweizerischer Kalibrierdienst
C Service suisse d'étalonnage
S Servizio svizzero di taratura
S Swiss Calibration Service

Accredited by the Swiss Accreditation Service (SAS)
The Swiss Accreditation Service is one of the signatories to the EA
Multilateral Agreement for the recognition of calibration certificates

Accreditation No.: **SCS 108**

Client **Quietek-CN (Auden)**

Certificate No: **D5GHzV2-1078_Mar14**

CALIBRATION CERTIFICATE

Object: **D5GHzV2 - SN: 1078**

Calibration procedure(s): **QA CAL-22.v2
Calibration procedure for dipole validation kits between 3-6 GHz**

Calibration date: **March 03, 2014**

This calibration certificate documents the traceability to national standards, which realize the physical units of measurements (SI).
The measurements and the uncertainties with confidence probability are given on the following pages and are part of the certificate.

All calibrations have been conducted in the closed laboratory facility: environment temperature (22 ± 3)°C and humidity < 70%.

Calibration Equipment used (M&TE critical for calibration)

Primary Standards	ID #	Cal Date (Certificate No.)	Scheduled Calibration
Power meter EPM-442A	GB37480704	09-Oct-13 (No. 217-01827)	Oct-14
Power sensor HP 84B1A	US37292783	09-Oct-13 (No. 217-01827)	Oct-14
Power sensor HP 84B1A	MY41092317	09-Oct-13 (No. 217-01828)	Oct-14
Reference 20 dB Attenuator	SN: 5058 (20k)	04-Apr-13 (No. 217-01736)	Apr-14
Type-N mismatch combination	SN: 5047.3 / 06327	04-Apr-13 (No. 217-01739)	Apr-14
Reference Probe EX3DV4	SN: 3503	30-Dec-13 (No. EX3-3503_Dec13)	Dec-14
DAE4	SN: 601	25-Apr-13 (No. DAE4-601_Apr13)	Apr-14
Secondary Standards	ID #	Check Date (in house)	Scheduled Check
RF generator R&S SMT-06	100005	04-Aug-99 (in house check Oct-13)	In house check: Oct-16
Network Analyzer HP 8753E	US37390585 S4206	18-Oct-01 (in house check Oct-13)	In house check: Oct-14

	Name	Function	Signature
Calibrated by:	Jeton Kastrati	Laboratory Technician	
Approved by:	Katja Pokovic	Technical Manager	

Issued: March 3, 2014

This calibration certificate shall not be reproduced except in full without written approval of the laboratory.

**Calibration Laboratory of
Schmid & Partner
Engineering AG**
Zeughausstrasse 43, 8004 Zurich, Switzerland



S Schweizerischer Kalibrierdienst
C Service suisse d'étalonnage
S Servizio svizzero di taratura
S Swiss Calibration Service

Accredited by the Swiss Accreditation Service (SAS)
The Swiss Accreditation Service is one of the signatories to the EA
Multilateral Agreement for the recognition of calibration certificates

Accreditation No.: **SCS 108**

Glossary:

TSL	tissue simulating liquid
ConvF	sensitivity in TSL / NORM x,y,z
N/A	not applicable or not measured

Calibration is Performed According to the Following Standards:

- a) IEC 62209-2, "Evaluation of Human Exposure to Radio Frequency Fields from Handheld and Body-Mounted Wireless Communication Devices in the Frequency Range of 30 MHz to 6 GHz: Human models, Instrumentation, and Procedures"; Part 2: "Procedure to determine the Specific Absorption Rate (SAR) for including accessories and multiple transmitters", March 2010
- b) KDB 865664, "SAR Measurement Requirements for 100 MHz to 6 GHz"
- c) IEEE Std 1528-2013, "IEEE Recommended Practice for Determining the Peak Spatial-Averaged Specific Absorption Rate (SAR) in the Human Head from Wireless Communications Devices: Measurement Techniques", June 2013

Additional Documentation:

- d) DASY4/5 System Handbook

Methods Applied and Interpretation of Parameters:

- *Measurement Conditions:* Further details are available from the Validation Report at the end of the certificate. All figures stated in the certificate are valid at the frequency indicated.
- *Antenna Parameters with TSL:* The dipole is mounted with the spacer to position its feed point exactly below the center marking of the flat phantom section, with the arms oriented parallel to the body axis.
- *Feed Point Impedance and Return Loss:* These parameters are measured with the dipole positioned under the liquid filled phantom. The impedance stated is transformed from the measurement at the SMA connector to the feed point. The Return Loss ensures low reflected power. No uncertainty required.
- *Electrical Delay:* One-way delay between the SMA connector and the antenna feed point. No uncertainty required.
- *SAR measured:* SAR measured at the stated antenna input power.
- *SAR normalized:* SAR as measured, normalized to an input power of 1 W at the antenna connector.
- *SAR for nominal TSL parameters:* The measured TSL parameters are used to calculate the nominal SAR result.

The reported uncertainty of measurement is stated as the standard uncertainty of measurement multiplied by the coverage factor $k=2$, which for a normal distribution corresponds to a coverage probability of approximately 95%.

Measurement Conditions

DASY system configuration, as far as not given on page 1.

DASY Version	DASY5	V52.8.7
Extrapolation	Advanced Extrapolation	
Phantom	Modular Flat Phantom V5.0	
Distance Dipole Center - TSL	10 mm	with Spacer
Zoom Scan Resolution	dx, dy = 4.0 mm, dz = 1.4 mm	Graded Ratio = 1.4 (Z direction)
Frequency	5200 MHz ± 1 MHz 5500 MHz ± 1 MHz 5800 MHz ± 1 MHz	

Head TSL parameters at 5200 MHz

The following parameters and calculations were applied.

	Temperature	Permittivity	Conductivity
Nominal Head TSL parameters	22.0 °C	36.0	4.66 mho/m
Measured Head TSL parameters	(22.0 ± 0.2) °C	37.1 ± 6 %	4.52 mho/m ± 6 %
Head TSL temperature change during test	< 0.5 °C	----	----

SAR result with Head TSL at 5200 MHz

SAR averaged over 1 cm ³ (1 g) of Head TSL	Condition	
SAR measured	100 mW input power	7.80 W/kg
SAR for nominal Head TSL parameters	normalized to 1W	78.4 W/kg ± 19.9 % (k=2)

SAR averaged over 10 cm ³ (10 g) of Head TSL	condition	
SAR measured	100 mW input power	2.23 W/kg
SAR for nominal Head TSL parameters	normalized to 1W	22.4 W/kg ± 19.5 % (k=2)

Head TSL parameters at 5500 MHz

The following parameters and calculations were applied.

	Temperature	Permittivity	Conductivity
Nominal Head TSL parameters	22.0 °C	35.6	4.96 mho/m
Measured Head TSL parameters	(22.0 ± 0.2) °C	36.7 ± 6 %	4.84 mho/m ± 6 %
Head TSL temperature change during test	< 0.5 °C	----	----

SAR result with Head TSL at 5500 MHz

SAR averaged over 1 cm ³ (1 g) of Head TSL	Condition	
SAR measured	100 mW input power	8.59 W/kg
SAR for nominal Head TSL parameters	normalized to 1W	86.3 W / kg ± 19.9 % (k=2)

SAR averaged over 10 cm ³ (10 g) of Head TSL	condition	
SAR measured	100 mW input power	2.43 W/kg
SAR for nominal Head TSL parameters	normalized to 1W	24.5 W/kg ± 19.5 % (k=2)

Head TSL parameters at 5800 MHz

The following parameters and calculations were applied.

	Temperature	Permittivity	Conductivity
Nominal Head TSL parameters	22.0 °C	35.3	5.27 mho/m
Measured Head TSL parameters	(22.0 ± 0.2) °C	36.3 ± 6 %	5.16 mho/m ± 6 %
Head TSL temperature change during test	< 0.5 °C	----	----

SAR result with Head TSL at 5800 MHz

SAR averaged over 1 cm ³ (1 g) of Head TSL	Condition	
SAR measured	100 mW input power	8.03 W/kg
SAR for nominal Head TSL parameters	normalized to 1W	80.7 W/kg ± 19.9 % (k=2)

SAR averaged over 10 cm ³ (10 g) of Head TSL	condition	
SAR measured	100 mW input power	2.27 W/kg
SAR for nominal Head TSL parameters	normalized to 1W	22.8 W/kg ± 19.5 % (k=2)

Body TSL parameters at 5200 MHz

The following parameters and calculations were applied.

	Temperature	Permittivity	Conductivity
Nominal Body TSL parameters	22.0 °C	49.0	5.30 mho/m
Measured Body TSL parameters	(22.0 ± 0.2) °C	47.8 ± 6 %	5.40 mho/m ± 6 %
Body TSL temperature change during test	< 0.5 °C	----	----

SAR result with Body TSL at 5200 MHz

SAR averaged over 1 cm ³ (1 g) of Body TSL	Condition	
SAR measured	100 mW input power	7.64 W/kg
SAR for nominal Body TSL parameters	normalized to 1W	76.0 W/kg ± 19.9 % (k=2)

SAR averaged over 10 cm ³ (10 g) of Body TSL	condition	
SAR measured	100 mW input power	2.13 W/kg
SAR for nominal Body TSL parameters	normalized to 1W	21.2 W/kg ± 19.5 % (k=2)

Body TSL parameters at 5500 MHz

The following parameters and calculations were applied.

	Temperature	Permittivity	Conductivity
Nominal Body TSL parameters	22.0 °C	48.6	5.65 mho/m
Measured Body TSL parameters	(22.0 ± 0.2) °C	47.3 ± 6 %	5.80 mho/m ± 6 %
Body TSL temperature change during test	< 0.5 °C	----	----

SAR result with Body TSL at 5500 MHz

SAR averaged over 1 cm ³ (1 g) of Body TSL	Condition	
SAR measured	100 mW input power	8.08 W/kg
SAR for nominal Body TSL parameters	normalized to 1W	80.4 W/kg ± 19.9 % (k=2)

SAR averaged over 10 cm ³ (10 g) of Body TSL	condition	
SAR measured	100 mW input power	2.24 W/kg
SAR for nominal Body TSL parameters	normalized to 1W	22.3 W/kg ± 19.5 % (k=2)

Body TSL parameters at 5800 MHz

The following parameters and calculations were applied.

	Temperature	Permittivity	Conductivity
Nominal Body TSL parameters	22.0 °C	48.2	6.00 mho/m
Measured Body TSL parameters	(22.0 ± 0.2) °C	46.8 ± 6 %	6.21 mho/m ± 6 %
Body TSL temperature change during test	< 0.5 °C	----	----

SAR result with Body TSL at 5800 MHz

SAR averaged over 1 cm ³ (1 g) of Body TSL	Condition	
SAR measured	100 mW input power	7.69 W/kg
SAR for nominal Body TSL parameters	normalized to 1W	76.6 W/kg ± 19.9 % (k=2)

SAR averaged over 10 cm ³ (10 g) of Body TSL	condition	
SAR measured	100 mW input power	2.12 W/kg
SAR for nominal Body TSL parameters	normalized to 1W	21.1 W/kg ± 19.5 % (k=2)

Appendix

Antenna Parameters with Head TSL at 5200 MHz

Impedance, transformed to feed point	52.3 Ω - 10.4 j Ω
Return Loss	- 19.7 dB

Antenna Parameters with Head TSL at 5500 MHz

Impedance, transformed to feed point	50.6 Ω - 6.3 j Ω
Return Loss	- 24.1 dB

Antenna Parameters with Head TSL at 5800 MHz

Impedance, transformed to feed point	54.1 Ω - 2.7 j Ω
Return Loss	- 26.5 dB

Antenna Parameters with Body TSL at 5200 MHz

Impedance, transformed to feed point	52.0 Ω - 9.0 j Ω
Return Loss	- 20.9 dB

Antenna Parameters with Body TSL at 5500 MHz

Impedance, transformed to feed point	51.5 Ω - 5.3 j Ω
Return Loss	- 25.3 dB

Antenna Parameters with Body TSL at 5800 MHz

Impedance, transformed to feed point	53.9 Ω - 1.5 j Ω
Return Loss	- 27.8 dB

General Antenna Parameters and Design

Electrical Delay (one direction)	1.198 ns
----------------------------------	----------

After long term use with 100W radiated power, only a slight warming of the dipole near the feedpoint can be measured.

The dipole is made of standard semirigid coaxial cable. The center conductor of the feeding line is directly connected to the second arm of the dipole. The antenna is therefore short-circuited for DC-signals. On some of the dipoles, small end caps are added to the dipole arms in order to improve matching when loaded according to the position as explained in the "Measurement Conditions" paragraph. The SAR data are not affected by this change. The overall dipole length is still according to the Standard.

No excessive force must be applied to the dipole arms, because they might bend or the soldered connections near the feedpoint may be damaged.

Additional EUT Data

Manufactured by	SPEAG
Manufactured on	September 26, 2008

DASY5 Validation Report for Head TSL

Date: 28.02.2014

Test Laboratory: SPEAG, Zurich, Switzerland

DUT: Dipole 5GHz; Type: D5GHzV2; Serial: D5GHzV2 - SN: 1078

Communication System: UID 0 - CW; Frequency: 5200 MHz, Frequency: 5500 MHz, Frequency: 5800 MHz
 Medium parameters used: $f = 5200$ MHz; $\sigma = 4.52$ S/m; $\epsilon_r = 37.1$; $\rho = 1000$ kg/m³, Medium parameters used: $f = 5500$ MHz; $\sigma = 4.84$ S/m; $\epsilon_r = 36.7$; $\rho = 1000$ kg/m³, Medium parameters used: $f = 5800$ MHz; $\sigma = 5.16$ S/m; $\epsilon_r = 36.3$; $\rho = 1000$ kg/m³

Phantom section: Flat Section

Measurement Standard: DASY5 (IEEE/IEC/ANSI C63.19-2007)

DASY52 Configuration:

- Probe: EX3DV4 - SN3503; ConvF(5.52, 5.52, 5.52); Calibrated: 30.12.2013, ConvF(5.01, 5.01, 5.01); Calibrated: 30.12.2013, ConvF(4.91, 4.91, 4.91); Calibrated: 30.12.2013;
- Sensor-Surface: 1.4mm (Mechanical Surface Detection)
- Electronics: DAE4 Sn601; Calibrated: 25.04.2013
- Phantom: Flat Phantom 5.0 (front); Type: QD000P50AA; Serial: 1001
- DASY52 52.8.7(1137); SEMCAD X 14.6.10(7164)

Dipole Calibration for Head Tissue/Pin=100mW, dist=10mm, f=5200 MHz/Zoom Scan,

dist=1.4mm (8x8x7)/Cube 0: Measurement grid: dx=4mm, dy=4mm, dz=1.4mm

Reference Value = 63.986 V/m; Power Drift = 0.04 dB

Peak SAR (extrapolated) = 28.8 W/kg

SAR(1 g) = 7.8 W/kg; SAR(10 g) = 2.23 W/kg

Maximum value of SAR (measured) = 18.0 W/kg

Dipole Calibration for Head Tissue/Pin=100mW, dist=10mm, f=5500 MHz/Zoom Scan,

dist=1.4mm (8x8x7)/Cube 0: Measurement grid: dx=4mm, dy=4mm, dz=1.4mm

Reference Value = 65.169 V/m; Power Drift = 0.05 dB

Peak SAR (extrapolated) = 34.6 W/kg

SAR(1 g) = 8.59 W/kg; SAR(10 g) = 2.43 W/kg

Maximum value of SAR (measured) = 20.6 W/kg

Dipole Calibration for Head Tissue/Pin=100mW, dist=10mm, f=5800 MHz/Zoom Scan,

dist=1.4mm (8x8x7)/Cube 0: Measurement grid: dx=4mm, dy=4mm, dz=1.4mm

Reference Value = 61.474 V/m; Power Drift = 0.02 dB

Peak SAR (extrapolated) = 34.2 W/kg

SAR(1 g) = 8.03 W/kg; SAR(10 g) = 2.27 W/kg

Maximum value of SAR (measured) = 19.7 W/kg

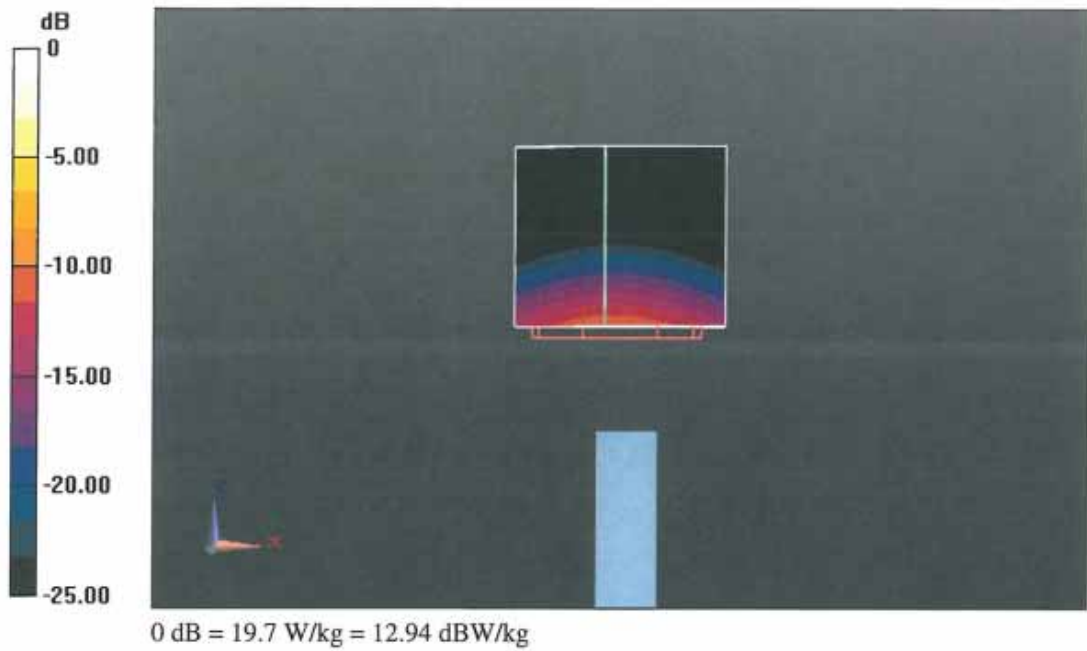

Impedance Measurement Plot for Head TSL

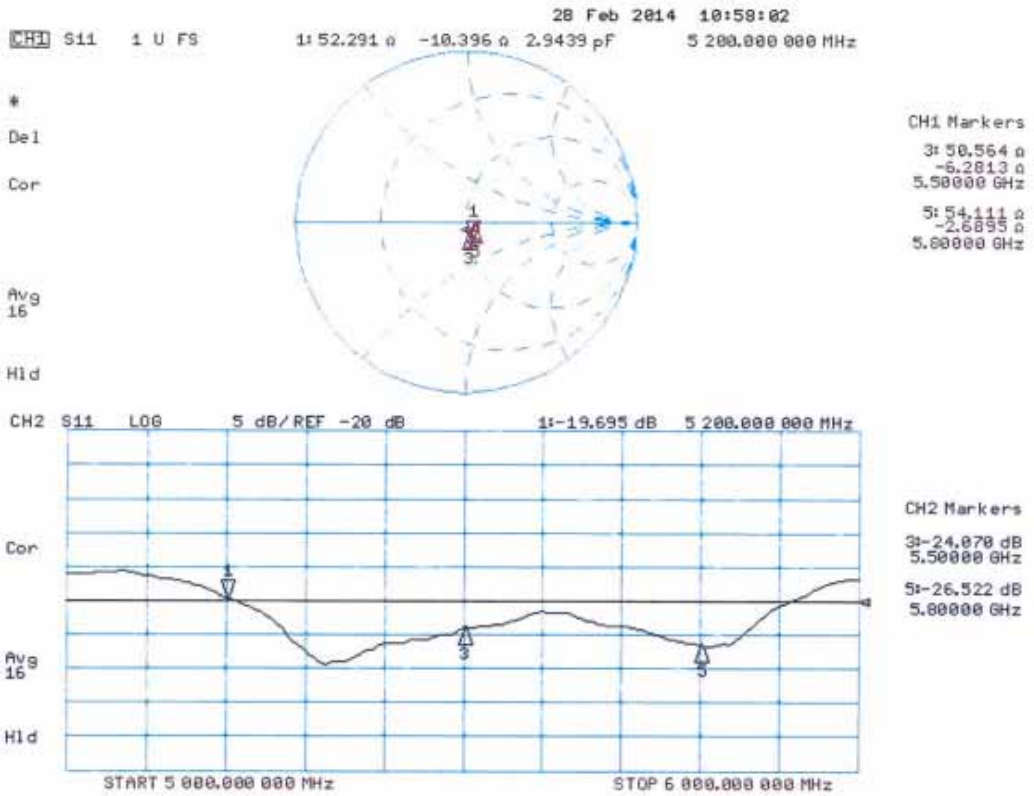

DASY5 Validation Report for Body TSL

Date: 03.03.2014

Test Laboratory: SPEAG, Zurich, Switzerland

DUT: Dipole 5GHz; Type: D5GHzV2; Serial: D5GHzV2 - SN: 1078

Communication System: UID 0 - CW; Frequency: 5200 MHz, Frequency: 5500 MHz, Frequency: 5800 MHz
 Medium parameters used: $f = 5200$ MHz; $\sigma = 5.4$ S/m; $\epsilon_r = 47.8$; $\rho = 1000$ kg/m³, Medium parameters used:
 $f = 5500$ MHz; $\sigma = 5.8$ S/m; $\epsilon_r = 47.3$; $\rho = 1000$ kg/m³, Medium parameters used: $f = 5800$ MHz; $\sigma = 6.21$
 S/m; $\epsilon_r = 46.8$; $\rho = 1000$ kg/m³
 Phantom section: Flat Section
 Measurement Standard: DASY5 (IEEE/IEC/ANSI C63.19-2007)

DASY52 Configuration:

- Probe: EX3DV4 - SN3503; ConvF(5.01, 5.01, 5.01); Calibrated: 30.12.2013, ConvF(4.52, 4.52, 4.52); Calibrated: 30.12.2013, ConvF(4.47, 4.47, 4.47); Calibrated: 30.12.2013;
- Sensor-Surface: 1.4mm (Mechanical Surface Detection)
- Electronics: DAE4 Sn601; Calibrated: 25.04.2013
- Phantom: Flat Phantom 5.0 (back); Type: QD000P50AA; Serial: 1002
- DASY52 52.8.7(1137); SEMCAD X 14.6.10(7164)

Dipole Calibration for Body Tissue/Pin=100mW, dist=10mm, f=5200 MHz/Zoom Scan, dist=1.4mm (8x8x7)/Cube 0: Measurement grid: dx=4mm, dy=4mm, dz=1.4mm

Reference Value = 59.230 V/m; Power Drift = -0.01 dB
 Peak SAR (extrapolated) = 30.8 W/kg
SAR(1 g) = 7.64 W/kg; SAR(10 g) = 2.13 W/kg
 Maximum value of SAR (measured) = 18.3 W/kg

Dipole Calibration for Body Tissue/Pin=100mW, dist=10mm, f=5500 MHz/Zoom Scan, dist=1.4mm (8x8x7)/Cube 0: Measurement grid: dx=4mm, dy=4mm, dz=1.4mm

Reference Value = 58.820 V/m; Power Drift = -0.00 dB
 Peak SAR (extrapolated) = 35.7 W/kg
SAR(1 g) = 8.08 W/kg; SAR(10 g) = 2.24 W/kg
 Maximum value of SAR (measured) = 20.0 W/kg

Dipole Calibration for Body Tissue/Pin=100mW, dist=10mm, f=5800 MHz/Zoom Scan, dist=1.4mm (8x8x7)/Cube 0: Measurement grid: dx=4mm, dy=4mm, dz=1.4mm

Reference Value = 55.732 V/m; Power Drift = 0.01 dB
 Peak SAR (extrapolated) = 36.8 W/kg
SAR(1 g) = 7.69 W/kg; SAR(10 g) = 2.12 W/kg
 Maximum value of SAR (measured) = 19.6 W/kg

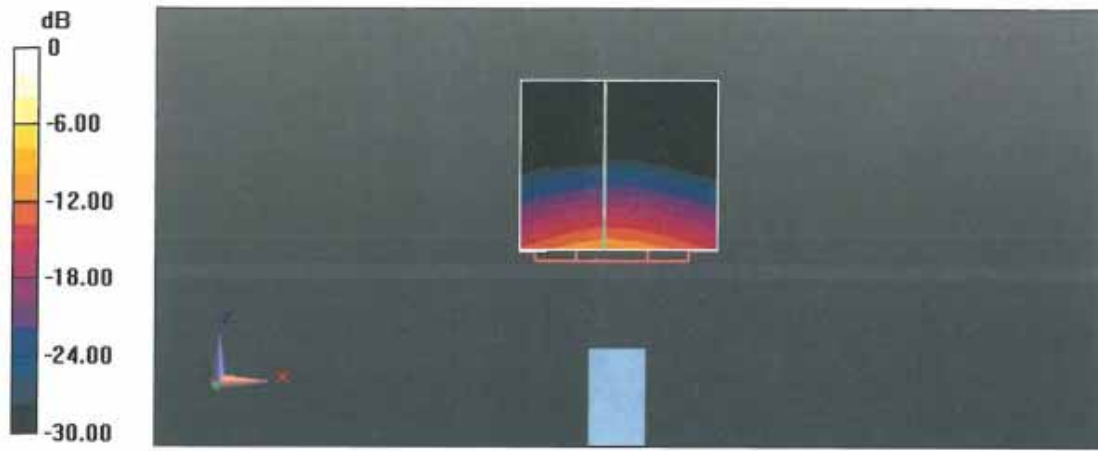

Impedance Measurement Plot for Body TSL

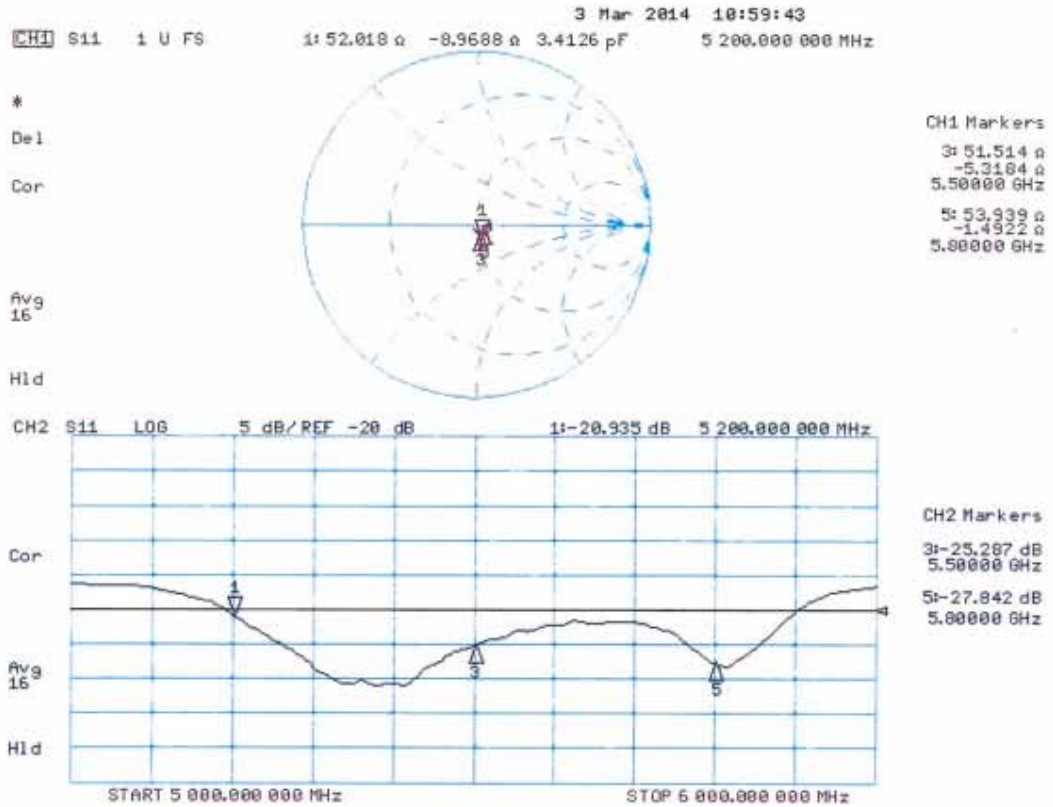

Appendix F. DAE Calibration Data

**Calibration Laboratory of
Schmid & Partner
Engineering AG**
Zeughausstrasse 43, 8004 Zurich, Switzerland



S Schweizerischer Kalibrierdienst
C Service suisse d'étalonnage
S Servizio svizzero di taratura
S Swiss Calibration Service

Accredited by the Swiss Accreditation Service (SAS)
The Swiss Accreditation Service is one of the signatories to the EA
Multilateral Agreement for the recognition of calibration certificates

Accreditation No.: **SCS 108**

Client **Quietek-CN (Auden)**

Certificate No: **DAE4-1220_Jan14**

CALIBRATION CERTIFICATE

Object **DAE4 - SD 000 D04 BM - SN: 1220**

Calibration procedure(s) **QA CAL-06.v26
Calibration procedure for the data acquisition electronics (DAE)**

Calibration date: **January 22, 2014**

This calibration certificate documents the traceability to national standards, which realize the physical units of measurements (SI).
The measurements and the uncertainties with confidence probability are given on the following pages and are part of the certificate.

All calibrations have been conducted in the closed laboratory facility: environment temperature (22 ± 3)°C and humidity < 70%.

Calibration Equipment used (M&TE critical for calibration)

Primary Standards	ID #	Cal Date (Certificate No.)	Scheduled Calibration
Keithley Multimeter Type 2001	SN: 0810278	01-Oct-13 (No:13976)	Oct-14
Secondary Standards	ID #	Check Date (in house)	Scheduled Check
Auto DAE Calibration Unit	SE UWS 053 AA 1001	07-Jan-14 (in house check)	In house check: Jan-15
Calibrator Box V2.1	SE UMS 006 AA 1002	07-Jan-14 (in house check)	In house check: Jan-15

	Name	Function	Signature
Calibrated by:	R.Mayoraz	Technician	<i>R. Mayoraz</i>
Approved by:	Fin Bomholt	Deputy Technical Manager	<i>F. Bomholt</i>

Issued: January 22, 2014

This calibration certificate shall not be reproduced except in full without written approval of the laboratory.

**Calibration Laboratory of
Schmid & Partner
Engineering AG**
Zeughausstrasse 43, 8004 Zurich, Switzerland



S Schweizerischer Kalibrierdienst
C Service suisse d'étalonnage
S Servizio svizzero di taratura
S Swiss Calibration Service

Accredited by the Swiss Accreditation Service (SAS)
The Swiss Accreditation Service is one of the signatories to the EA
Multilateral Agreement for the recognition of calibration certificates

Accreditation No.: **SCS 108**

Glossary

DAE data acquisition electronics
Connector angle information used in DASY system to align probe sensor X to the robot coordinate system.

Methods Applied and Interpretation of Parameters

- *DC Voltage Measurement:* Calibration Factor assessed for use in DASY system by comparison with a calibrated instrument traceable to national standards. The figure given corresponds to the full scale range of the voltmeter in the respective range.
- *Connector angle:* The angle of the connector is assessed measuring the angle mechanically by a tool inserted. Uncertainty is not required.
- The following parameters as documented in the Appendix contain technical information as a result from the performance test and require no uncertainty.
 - *DC Voltage Measurement Linearity:* Verification of the Linearity at +10% and -10% of the nominal calibration voltage. Influence of offset voltage is included in this measurement.
 - *Common mode sensitivity:* Influence of a positive or negative common mode voltage on the differential measurement.
 - *Channel separation:* Influence of a voltage on the neighbor channels not subject to an input voltage.
 - *AD Converter Values with inputs shorted:* Values on the internal AD converter corresponding to zero input voltage
 - *Input Offset Measurement:* Output voltage and statistical results over a large number of zero voltage measurements.
 - *Input Offset Current:* Typical value for information; Maximum channel input offset current, not considering the input resistance.
 - *Input resistance:* Typical value for information: DAE input resistance at the connector, during internal auto-zeroing and during measurement.
 - *Low Battery Alarm Voltage:* Typical value for information. Below this voltage, a battery alarm signal is generated.
 - *Power consumption:* Typical value for information. Supply currents in various operating modes.

DC Voltage Measurement

A/D - Converter Resolution nominal

High Range: 1LSB = 6.1μV , full range = -100...+300 mV

Low Range: 1LSB = 61nV , full range = -1.....+3mV

DASY measurement parameters: Auto Zero Time: 3 sec; Measuring time: 3 sec

Calibration Factors	X	Y	Z
High Range	405.217 ± 0.02% (k=2)	404.944 ± 0.02% (k=2)	404.170 ± 0.02% (k=2)
Low Range	3.97747 ± 1.50% (k=2)	3.99640 ± 1.50% (k=2)	3.98639 ± 1.50% (k=2)

Connector Angle

Connector Angle to be used in DASY system	176.5 ° ± 1 °
---	---------------

Appendix

1. DC Voltage Linearity

High Range		Reading (μ V)	Difference (μ V)	Error (%)
Channel X	+ Input	199996.00	0.76	0.00
Channel X	+ Input	20002.66	1.98	0.01
Channel X	- Input	-19998.07	2.88	-0.01
Channel Y	+ Input	199996.91	1.60	0.00
Channel Y	+ Input	20001.20	0.56	0.00
Channel Y	- Input	-20001.74	-0.74	0.00
Channel Z	+ Input	199994.91	-0.44	-0.00
Channel Z	+ Input	20000.27	-0.23	-0.00
Channel Z	- Input	-20001.65	-0.63	0.00

Low Range		Reading (μ V)	Difference (μ V)	Error (%)
Channel X	+ Input	2001.09	0.27	0.01
Channel X	+ Input	202.00	0.81	0.40
Channel X	- Input	-197.89	0.69	-0.35
Channel Y	+ Input	2000.99	0.22	0.01
Channel Y	+ Input	200.07	-1.02	-0.50
Channel Y	- Input	-201.19	-2.34	1.18
Channel Z	+ Input	2000.92	0.16	0.01
Channel Z	+ Input	200.20	-0.82	-0.41
Channel Z	- Input	-199.32	-0.45	0.23

2. Common mode sensitivity

DASY measurement parameters: Auto Zero Time: 3 sec; Measuring time: 3 sec

	Common mode Input Voltage (mV)	High Range Average Reading (μ V)	Low Range Average Reading (μ V)
Channel X	200	10.55	8.63
	- 200	-6.76	-8.77
Channel Y	200	-9.89	-10.34
	- 200	7.59	7.71
Channel Z	200	12.72	12.38
	- 200	-13.94	-14.25

3. Channel separation

DASY measurement parameters: Auto Zero Time: 3 sec; Measuring time: 3 sec

	Input Voltage (mV)	Channel X (μ V)	Channel Y (μ V)	Channel Z (μ V)
Channel X	200	-	1.02	-3.16
Channel Y	200	8.35	-	2.35
Channel Z	200	10.56	5.06	-

4. AD-Converter Values with inputs shorted

DASY measurement parameters: Auto Zero Time: 3 sec; Measuring time: 3 sec

	High Range (LSB)	Low Range (LSB)
Channel X	15888	15493
Channel Y	16012	15900
Channel Z	15706	16099

5. Input Offset Measurement

DASY measurement parameters: Auto Zero Time: 3 sec; Measuring time: 3 sec

Input 10MΩ

	Average (μV)	min. Offset (μV)	max. Offset (μV)	Std. Deviation (μV)
Channel X	1.13	-0.62	2.79	0.50
Channel Y	-0.89	-2.63	0.76	0.48
Channel Z	-0.60	-2.36	0.94	0.50

6. Input Offset Current

Nominal Input circuitry offset current on all channels: <25fA

7. Input Resistance (Typical values for information)

	Zeroing (kOhm)	Measuring (MOhm)
Channel X	200	200
Channel Y	200	200
Channel Z	200	200

8. Low Battery Alarm Voltage (Typical values for information)

Typical values	Alarm Level (VDC)
Supply (+ Vcc)	+7.9
Supply (- Vcc)	-7.6

9. Power Consumption (Typical values for information)

Typical values	Switched off (mA)	Stand by (mA)	Transmitting (mA)
Supply (+ Vcc)	+0.01	+6	+14
Supply (- Vcc)	-0.01	-8	-9