



TEST REPORT

For

Applicant : BRAVEN LC

**Address : 6001 Oak Canyon, Irvine, California, United States,
92618**

Product Name : TUMI Headphone

Model Name : TUAHP

Brand Name : TUMI

FCC Number : FCC ID: Z7R-TUAHP

Report No. : MTE/CEC/S16122583

Date of Issue : Dec.14, 2016

Issued by : Most Technology Service Co., Limited.

**Address : No.5, 2nd Langshan Road, North District, Hi-tech Industrial
Park, Nanshan, Shenzhen, Guangdong, China**

Tel : 86-755-8602 6850

Fax : 86-755-26013350

The report consists 57 pages in total. It may be duplicated completely for legal use with the approval of the applicant. It should not be reproduced except in full, without the written approval of our laboratory. The client should not use it to claim product endorsement by MOST. The test results in the report only apply to the tested sample. The test report shall be invalid without all the signatures of testing engineers, reviewer and approver.

TABLE OF CONTENTS

1. PRODUCT INFORMATION	4
2. GENERAL INFORMATION	5
2.1 Product Information.....	5
2.2 Objective	5
2.3 Test Standards and Results.....	6
2.4 Environmental Conditions.....	6
2.5 Supporting System Details	6
3. TEST METHODOLOGY.....	7
3.1 TEST FACILITY	7
3.2 GENERAL TEST PROCEDURES	7
4. SETUP OF EQUIPMENT UNDER TEST	8
4.1 SETUP CONFIGURATION OF EUT.....	8
4.2 TEST EQUIPMENT LIST	8
5. 47 CFR Part 15 C Requirements	9
5.1 ANTENNA REQUIREMENT	9
5.1.1 Applicable Standard.....	9
5.1.2 Evaluation Criteria.....	9
5.1.3 Result: Compliance.	9
5.2 AC Power Line Conducted Emission.....	10
5.2.1 Requirement	10
5.2.2 Block Diagram of Test Setup	10
5.2.3 Test procedure	10
5.2.4 Test Result	10
5.3 Radiated Emission	13
5.3.1 Requirement	13
5.3.2 Test Configuration	13
5.3.3 Test Procedure:	14
5.3.4 Test Result	15
5.4 Conducted Peak Output Power.....	22
5.4.1 Requirement	22
5.4.2 Block Diagram of Test Setup	22
5.4.3 Test Procedure	22
5.4.4 Test Result	22
5.5 20dB Emission Bandwidth	26
5.5.1 Test Requirement.....	26
5.5.2 Test Procedure	26
5.5.3 Test Result	26
5.6 Carrier Frequency Separation	30
5.6.1 Test Requirement	30
5.6.2 Test Procedure	30
5.6.3 Test Result	30
5.7 Number of Hopping Channel	34
5.7.1 Test Requirement.....	34
5.7.2 Test Procedure	34
5.7.3 Test Result	34
5.8 Dwell Time	36
5.8.1 Test Requirement.....	36

5.8.2 Test Procedure	36
5.8.3 Test Result	36
5.9 Band Edge and Conducted Spurious Emissions	40
5.9.1 Test Requirement	40
5.9.2 Test Procedure	40
5.9.3 Test Result	40
5.10 Restricted Frequency Bands.....	45
5.10.1 Test Requirement	45
5.10.2 Test Configuration	45
5.10.3 Test Procedure:	45
5.10.4 Test Result	45

2. GENERAL INFORMATION

2.1 Product Information

Product	TUMI Headphone
Brand Name	TUMI
Model Number	TUAHP
Series Model Name:	N/A
Series Model Difference description:	N/A
Power Supply	1.DC 5 V by USB Port 2.DC 3.7 V by Battery
Frequency Range	2402MHz -2480MHz
Modulation Type:	GFSK, $\pi/4$ -DQPSK, 8DPSK
Modulation Technique	FHSS
Channel Number	79
Antenna Type	Internal PCB Antenna, Antenna Gain :2.30dBi
Temperature Range	0°C ~ +40°C

NOTE:

1. For a more detailed features description about the EUT, please refer to User's Manual.

2.2 Objective

The objective of the report is to perform tests according to FCC Part 15 Subpart C for the EUT FCC ID Certification:

No.	Identity	Document Title
1	47 CFR Part 15	Radio Frequency Devices
2	DA00-705	Filing and Measurement Guidelines for Frequency Hopping Spread Spectrum Systems.

2.3 Test Standards and Results

No.	Section	Test Items	Result	Date of Test
1	FCC 15.203	Antenna Requirement	PASS	2016-12-08
2	FCC15.207 (a)	AC Power Line Conducted Emission	PASS	2016-12-07
3	FCC15.209, 15.247(d)	Radiated Emission	PASS	2016-12-08
4	FCC 15.247 (b)(1)	Conducted Peak Output Power	PASS	2016-12-09
5	FCC 15.247 (a)(1)	20dB Emission Bandwidth	PASS	2016-12-09
6	FCC 15.247 (a)(1)	Carrier Frequency Separation	PASS	2016-12-09
7	FCC 15.247 (a)(1)(iii)	Number of Hopping Channel	PASS	2016-12-09
8	FCC 15.247 (a)(1) (iii)	Dwell Time	PASS	2016-12-09
9	FCC15.247(d)	Band Edge and Conducted Spurious Emissions	PASS	2016-12-09
10	FCC15.247(d)	Restricted Frequency Bands	PASS	2016-12-08
Remark: N/A means not applicable				

Note: 1. The test result judgment is decided by the limit of measurement standard
 2. The information of measurement uncertainty is available upon the customer's request.

2.4 Environmental Conditions

During the measurement the environmental conditions were within the listed ranges:

- Temperature: 15-35°C
- Humidity: 30-60 %
- Atmospheric pressure: 86-106 kPa

2.5 Supporting System Details

Kind of equipment	Manufacturer	Model	Serial No.	Power Supply
Adapter	N/A	JK050250-S04EU	---	Input: AC100-240V~ 50/60Hz Output: DC 5.0V,2.5A

3. TEST METHODOLOGY

3.1 TEST FACILITY

Test Site:	Most Technology Service Co., Limited
Location:	No.5, 2nd Langshan Road, North District, Hi-tech Industrial Park, Nanshan, Shenzhen, Guangdong, China
Description:	There is one 3m semi-anechoic an area test sites and two line conducted labs for final test. The Open Area Test Sites and the Line Conducted labs are constructed and calibrated to meet the FCC requirements in documents ANSI C63.10:2013 and CISPR 16 requirements. The FCC Registration Number is 490827 . The IC Registration Number is 7103A-1 .
Site Filing:	The site description is on file with the Federal Communications Commission, 7435 Oakland Mills Road, Columbia, MD 21046.
Instrument	All measuring equipment is in accord with ANSI C63.10:2013 and CISPR 16
Tolerance:	requirements that meet industry regulatory agency and accreditation agency requirement.
Ground Plane:	Two conductive reference ground planes were used during the Line Conducted Emission, one in vertical and the other in horizontal. The dimensions of these ground planes are as below. The vertical ground plane was placed distancing 40 cm to the rear of the wooden test table on where the EUT and the support equipment were placed during test. The horizontal ground plane projected 50 cm beyond the footprint of the EUT system and distanced 80 cm to the wooden test table. For Radiated Emission Test, one horizontal conductive ground plane extended at least 1m beyond the periphery of the EUT and the largest measuring antenna, and covered the entire area between the EUT and the antenna.

3.2 GENERAL TEST PROCEDURES

Radiated Emissions

The EUT is placed on a turn table, which is 1.5 m above ground plane. The turntable shall rotate 360 degrees to determine the position of maximum emission level. EUT is set 3m away from the receiving antenna, which varied from 1m to 4m to find out the highest emission. And also, each emission was to be maximized by changing the polarization of receiving antenna both horizontal and vertical. In order to find out the maximum emissions, exploratory radiated emission measurements were made according to the requirements in Section 6.5 of ANSI C63.10:2013.

Conducted Emissions

The EUT is placed on the turntable, which is 0.8 m above ground plane. According to the requirements in Section 6.2 of ANSI C63.10:2013, Conducted emissions from the EUT measured in the frequency range between 0.15 MHz and 30MHz using CISPR Quasi-peak and average detector modes.

4. SETUP OF EQUIPMENT UNDER TEST

4.1 SETUP CONFIGURATION OF EUT

See test photographs attached in Appendix 1 for the actual connections between EUT and support equipment.

4.2 TEST EQUIPMENT LIST

Instrumentation: The following list contains equipment used at Most for testing. The equipment conforms to the CISPR 16-1 / ANSI C63.2 Specifications for Electromagnetic Interference and Field Strength Instrumentation from 10 kHz to 1.0 GHz or above.

No.	Equipment	Manufacturer	Model No.	S/N	Calibration date	Calibration Interval
1	Test Receiver	Rohde & Schwarz	ESCI	100492	2016/03/10	1 Year
2	Spectrum Analyzer	Agilent	E7405A	US44210471	2016/03/14	1 Year
3	L.I.S.N.	Rohde & Schwarz	ENV216	100093	2016/03/10	1 Year
4	Coaxial Switch	Anritsu Corp	MP59B	6200283933	2016/03/07	1 Year
5	Terminator	Hubersuhner	50Ω	No.1	2016/03/07	1 Year
6	RF Cable	SchwarzBeck	N/A	No.1	2016/03/07	1 Year
7	Test Receiver	Rohde & Schwarz	ESPI	101202	2016/03/10	1 Year
8	Bilog Antenna	Sunol	JB3	A121206	2016/03/14	1 Year
9	Horn Antenna	SCHWARZBECK	BBHA9120D	756	2016/03/14	1 Year
10	Horn Antenna	Penn Engineering	9034	8376	2016/03/14	1 Year
11	Cable	Resenberger	N/A	NO.1	2016/03/07	1 Year
12	Cable	SchwarzBeck	N/A	NO.2	2016/03/07	1 Year
13	Cable	SchwarzBeck	N/A	NO.3	2016/03/07	1 Year
14	Single Phase Power Line Filter	DuoJi	FNF 202B30	N/A	2016/03/07	1 Year
15	Test Receiver	Rohde & Schwarz	ESCI	100492	2016/03/10	1 Year
16	Loop antenna	ARA	PLA-1030/B	1039	2016/03/14	1 Year

NOTE: Equipments listed above have been calibrated and are in the period of validation.

5. 47 CFR Part 15 C Requirements

5.1 ANTENNA REQUIREMENT

5.1.1 Applicable Standard

According to FCC § 15.203 , An intentional radiator shall be designed to ensure that no antenna other than that furnished by the responsible party shall be used with the device. The use of a permanently attached antenna or of an antenna that uses a unique coupling to the intentional radiator shall be considered sufficient to comply with the provisions of this section. The manufacturer may design the unit so that a broken antenna can be replaced by the user, but the use of a standard antenna jack or electrical connector is prohibited. This requirement does not apply to carrier current devices or to devices operated under the provisions of §15.211, §15.213, §15.217, §15.219, or §15.221. Further, this requirement does not apply to intentional radiators that must be professionally installed, such as perimeter protection systems and some field disturbance sensors, or to other intentional radiators which, in accordance with §15.31(d), must be measured at the installation site. However, the installer shall be responsible for ensuring that the proper antenna is employed so that the limits in this part are not exceeded.

5.1.2 Evaluation Criteria

(a) Antenna must be permanently attached to the unit.

(b) Antenna must use a unique type of connector to attach to the EUT.

Unit must be professionally installed, Installer shall be responsible for verifying that the correct antenna is employed with the unit.

5.1.3 Result: Compliance.

The EUT has one integral antenna arrangement, which was permanently attached and the antenna gain is 2.30 dBi, fulfill the requirement of this section.

5.2 AC Power Line Conducted Emission

5.2.1 Requirement

A radio apparatus that is designed to be connected to the public utility (AC) power line shall ensure that the radio frequency voltage, which is conducted back onto the AC power line on any frequency or frequencies within the and 150 kHz-30 MHz, shall not exceed the limits in the following table:

Frequency	Maximum RF Line Voltage	
	Q.P.(dBuV)	Average(dBuV)
150kHz-500kHz	66-56	56-46
500kHz-5MHz	56	46
5MHz-30MHz	60	50

****Note:** 1. the lower limit shall apply at the band edges.
2. The limit decreases linearly with the logarithm of the frequency in the range 0.15 MHz to 0.50 MHz

5.2.2 Block Diagram of Test Setup

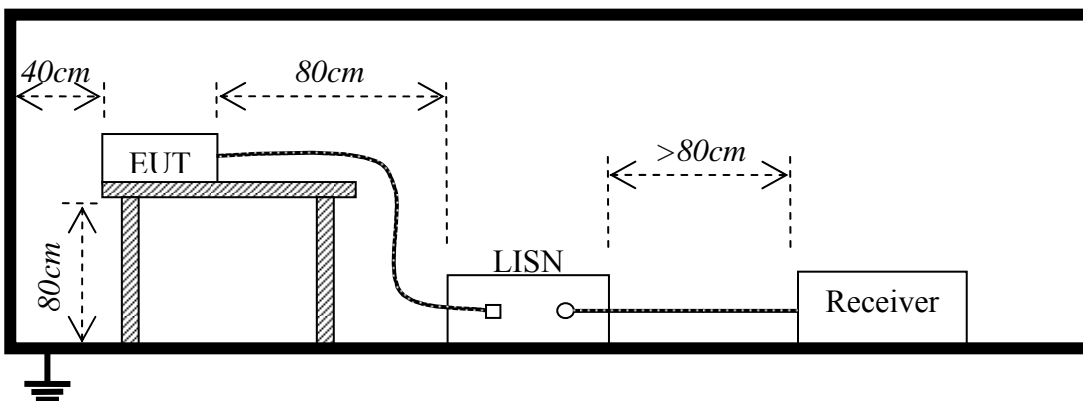

5.2.3 Test procedure

1. The E.U.T and simulators are connected to the main power through a line impedance stabilization network (L.I.S.N.). This provides a 50ohm/50uH coupling impedance for the measuring equipment.
2. Exploratory measurements were made to identify the frequency of the emission that has the highest amplitude relative to the limit;
3. The peripheral devices are also connected to the main power through a LISN that provides a 50ohm/50uH coupling impedance with 50ohm termination. (Please refer to the block diagram of the test setup and photographs).
4. Both sides of A.C. line are checked for maximum conducted interference. In order to find the maximum emission, the relative positions of equipment and all of the interface cables must be changed according to ANSI C63.10: 2013 on conducted measurement.
5. The bandwidth of test receiver (ESCI) set at 9 KHz.
6. All data was recorded in the Quasi-peak and average detection mode.

5.2.4 Test Result

Pass

Note: All test modes are performed, only the worst case is recorded in this report.

Please refer the following pages.

EUT:	TUMI Headphone	M/N:	TUAHP
Mode:	Charging	Phase:	L1
Tested by:	Sunny(Engineer)	Power:	DC 5 V by USB Port
Temperature: / Humidity	23.4°C / 52.9%	Test date:	2016-12-07

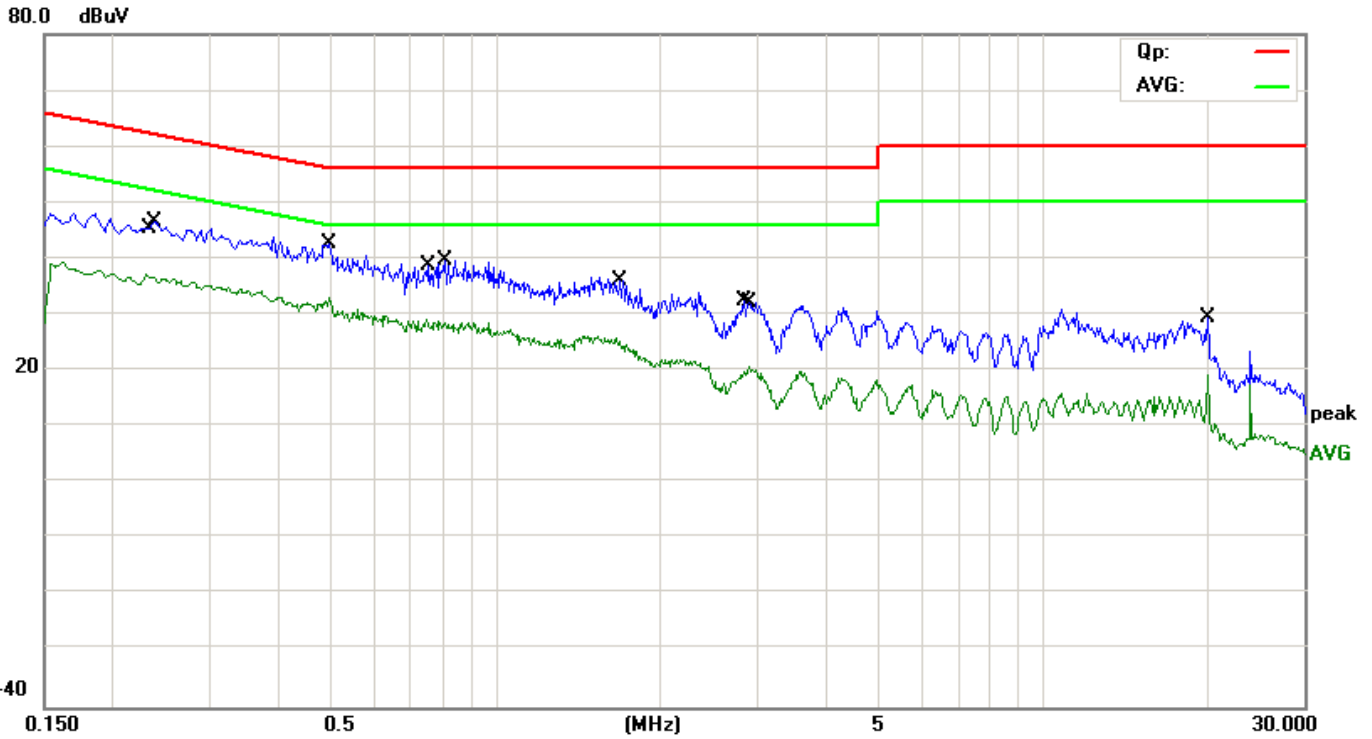

No.	Mk.	Freq. MHz	Reading Level dBuV	Correct Factor dB	Measure- ment dBuV	Limit dBuV	Over dB	Detector	Comment
1		0.2303	27.55	9.60	37.15	52.44	-15.29	AVG	
2		0.2380	37.07	9.60	46.67	62.17	-15.50	QP	
3		0.4980	32.95	9.59	42.54	56.03	-13.49	QP	
4	*	0.4980	23.49	9.59	33.08	46.03	-12.95	AVG	
5		0.7500	19.42	9.60	29.02	46.00	-16.98	AVG	
6		0.8100	29.99	9.60	39.59	56.00	-16.41	QP	
7		1.6700	16.24	9.60	25.84	46.00	-20.16	AVG	
8		1.6900	26.39	9.60	35.99	56.00	-20.01	QP	
9		2.8460	22.70	9.61	32.31	56.00	-23.69	QP	
10		2.9060	11.04	9.61	20.65	46.00	-25.35	AVG	
11		19.9980	19.84	9.73	29.57	60.00	-30.43	QP	
12		19.9980	9.38	9.73	19.11	50.00	-30.89	AVG	

*:Maximum data x:Over limit !:over margin

EUT:	TUMI Headphone	M/N:	TUAHP
Mode:	Charging	Phase:	N
Tested by:	Sunny(Engineer)	Power:	DC 5 V by USB Port
Temperature: / Humidity	23.4°C / 52.9%	Test date:	2016-12-07

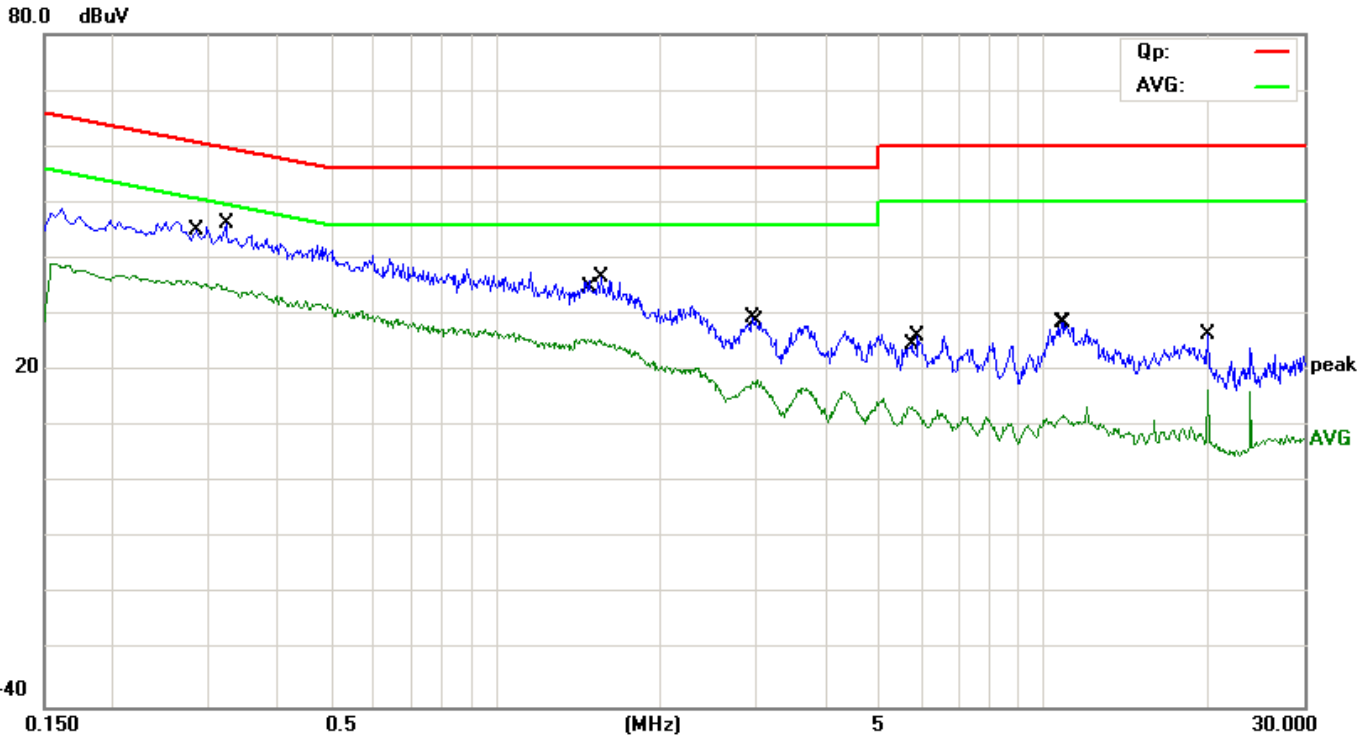

No.	Mk.	Freq. MHz	Reading Level dBuV	Correct Factor dB	Measure- ment dBuV	Limit dBuV	Over dB	Detector	Comment
1		0.2820	26.27	9.59	35.86	50.76	-14.90	AVG	
2	*	0.3220	36.70	9.59	46.29	59.66	-13.37	QP	
3		1.4980	15.92	9.60	25.52	46.00	-20.48	AVG	
4		1.5660	27.17	9.60	36.77	56.00	-19.23	QP	
5		2.9500	19.73	9.61	29.34	56.00	-26.66	QP	
6		3.0140	8.89	9.61	18.50	46.00	-27.50	AVG	
7		5.6940	3.82	9.64	13.46	50.00	-36.54	AVG	
8		5.9100	16.63	9.64	26.27	60.00	-33.73	QP	
9		10.8020	18.82	9.69	28.51	60.00	-31.49	QP	
10		10.9140	2.40	9.69	12.09	50.00	-37.91	AVG	
11		19.9980	16.71	9.73	26.44	60.00	-33.56	QP	
12		19.9980	6.68	9.73	16.41	50.00	-33.59	AVG	

*:Maximum data x:Over limit !:over margin

5.3 Radiated Emission

5.3.1 Requirement

According to FCC section 15.247(d), In addition, radiated emissions which fall in the restricted bands, as defined in §15.205(a), must also comply with the radiated emission limits specified in §15.209(a) (see §15.205(c)).

According to FCC section 15.209(a), Except as provided elsewhere in this subpart, the emissions from an intentional radiator shall not exceed the field strength levels specified in the following table:

Frequency (MHz)	Field Strength ($\mu\text{V}/\text{m}$ at 3-meter)	Test Distance (m)	Field Strength ($\text{dB}\mu\text{V}/\text{m}$ at 3-meter)
0.009 - 0.490	2400/F(kHz)	300	
0.490 - 1.705	24000/F(kHz)	30	
1.705-30	30	30	
30-88	100	3	40
88-216	150	3	43.5
216-960	200	3	46
Above 960	500	3	54

Note:

1. For Above 1000MHz, the emission limit in this paragraph is based on measurement instrumentation employing an average detector, measurement using instrumentation with a peak detector function, corresponding to 20dB above the maximum permitted average limit.

2. For above 1000MHz, limit field strength of harmonics: 54dBuV/m@3m (AV) and 74dBuV/m@3m (PK)

In addition, radiated emissions which fall in the restricted bands, as defined in §15.205(a), must also comply with the radiated emission limits specified in §15.209(a) (see §15.205(c)).

5.3.2 Test Configuration

Test Setup:

1) For radiated emissions from 9kHz to 30MHz

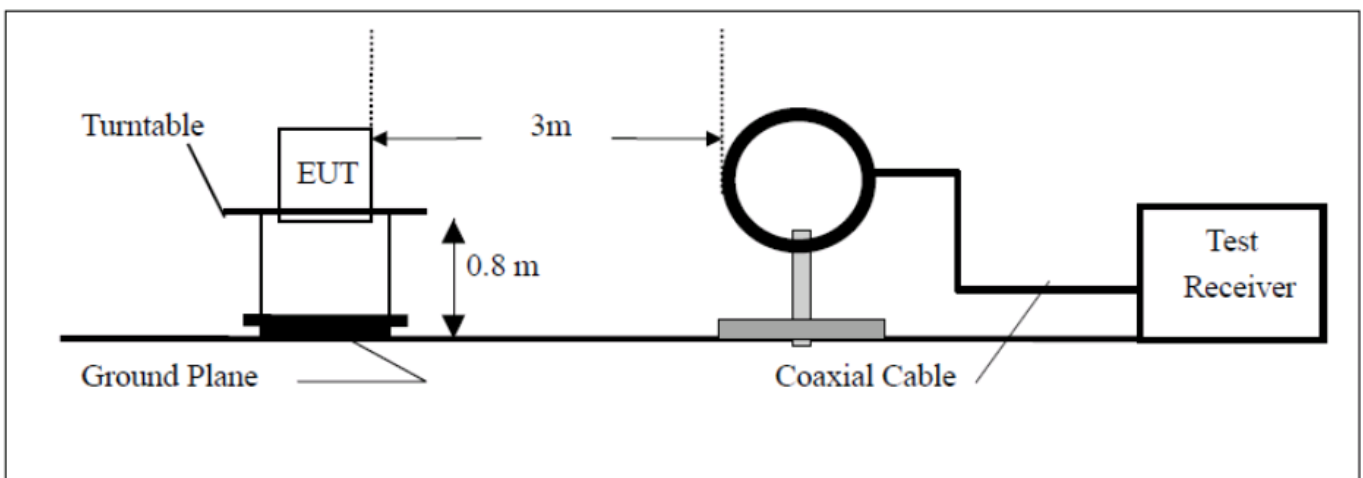

2) For radiated emissions from 30MHz to1GHz

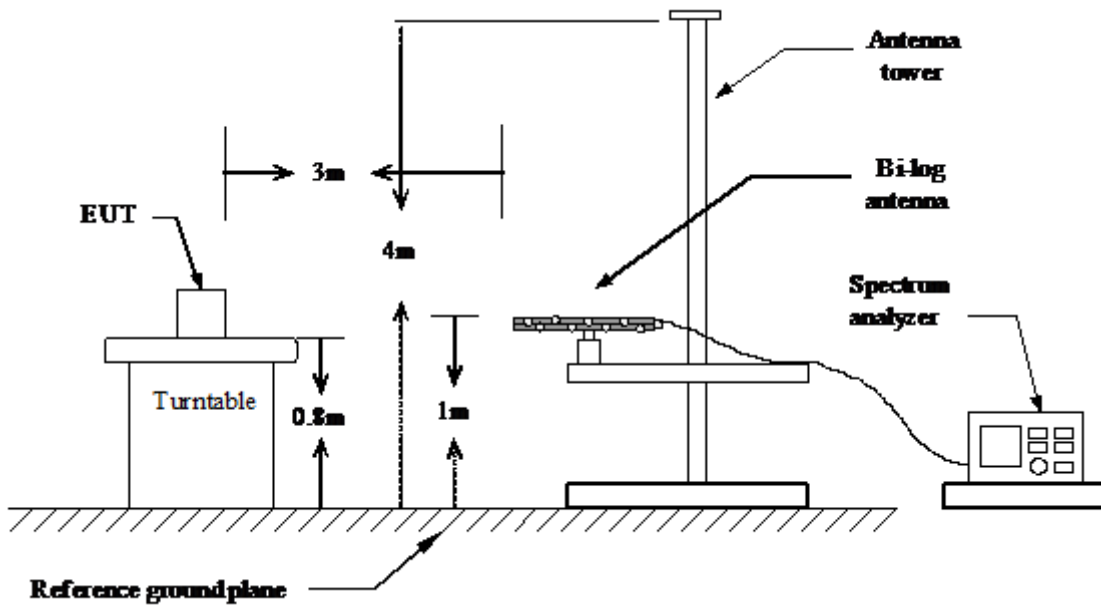

3) For radiated emissions above 1GHz

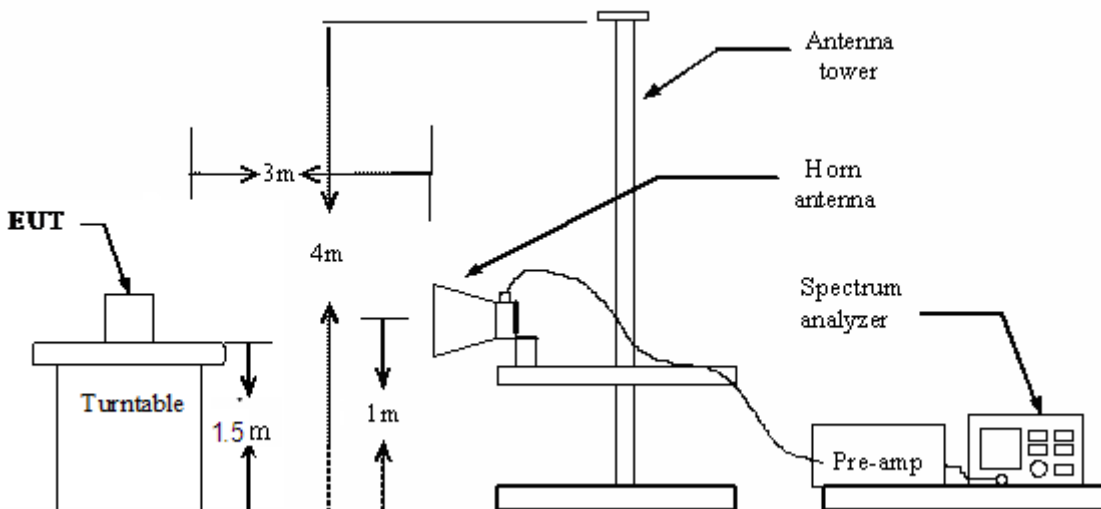

5.3.3 Test Procedure:

1. The EUT was placed on the top of a wooden table 0.8 meters (for measurement at frequency below 1GHz) and a wooden table 1.5 meters (for measurement at frequency above 1GHz) above the ground at a 3 meter semi-anechoic chamber. The table was rotated 360 degrees to determine the position of the highest radiation.
2. The EUT was set 3 meters away from the interference-receiving antenna, which was mounted on the top of a variable-height antenna tower.
3. The antenna height is varied from one meter to four meters above the ground to determine the maximum value of the field strength. Both horizontal and vertical polarizations of the antenna are set to make the measurement.
4. For each suspected emission, the EUT was arranged to its worst case and then the antenna was tuned to heights from 1 meter to 4 meters (for the test frequency of below 30MHz, the antenna was tuned to heights 1 meter, for the test frequency of above 1GHz, horn antenna opening in the test would have been facing the EUT when rise or fall) and the table was turned from 0 degrees to 360 degrees to find the maximum reading.

6. Set the spectrum analyzer in the following setting as:

Below 1GHz: PEAK: RBW=100 kHz / VBW=300 kHz / Sweep=AUTO QP: RBW=120 kHz / Sweep=AUTO

Above 1GHz: (a)PEAK: RBW=VBW=1MHz / Sweep=AUTO

(b)AVERAGE: RBW=1MHz / VBW=10Hz / Sweep=AUTO

The test-receiver system was set to Peak Detect Function and Specified Bandwidth with Maximum Hold Mode.

7. If the emission level of the EUT in peak mode was 10dB lower than the limit specified, then testing could be stopped and the peak values of the EUT would be reported. Otherwise the emissions that did not have 10dB margin would be re-tested one by one using peak, quasi-peak or average method as specified and then reported in a data sheet.

5.3.4 Test Result

Pass

Remark:

1. During the test, pre-scan the GFSK, $\pi/4$ -QPSK, 8DPSK modulation, and found the GFSK modulation Low channel is worse case in above 1GHz and below 1GHz.
2. Pre-scan all kind of the place mode (X-axis, Y-axis, Z-axis), and found the Y-axis which it is worse case.
3. For radiated emissions from 9kHz to 30MHz, Test results show that the margin of over -20db.

Note: All test modes are performed, only the worst case is recorded in this report.

Please refer the following pages

Below 1GHz:

EUT:	TUMI Headphone	M/N:	TUAHP
Mode:	GFSK-CH0	Polarization:	Horizontal
Tested by:	Sunny(Engineer)	Power:	DC 3.7V by Battery
Temperature: / Humidity	23.9°C / 53.6%	Test date:	2016-12-08

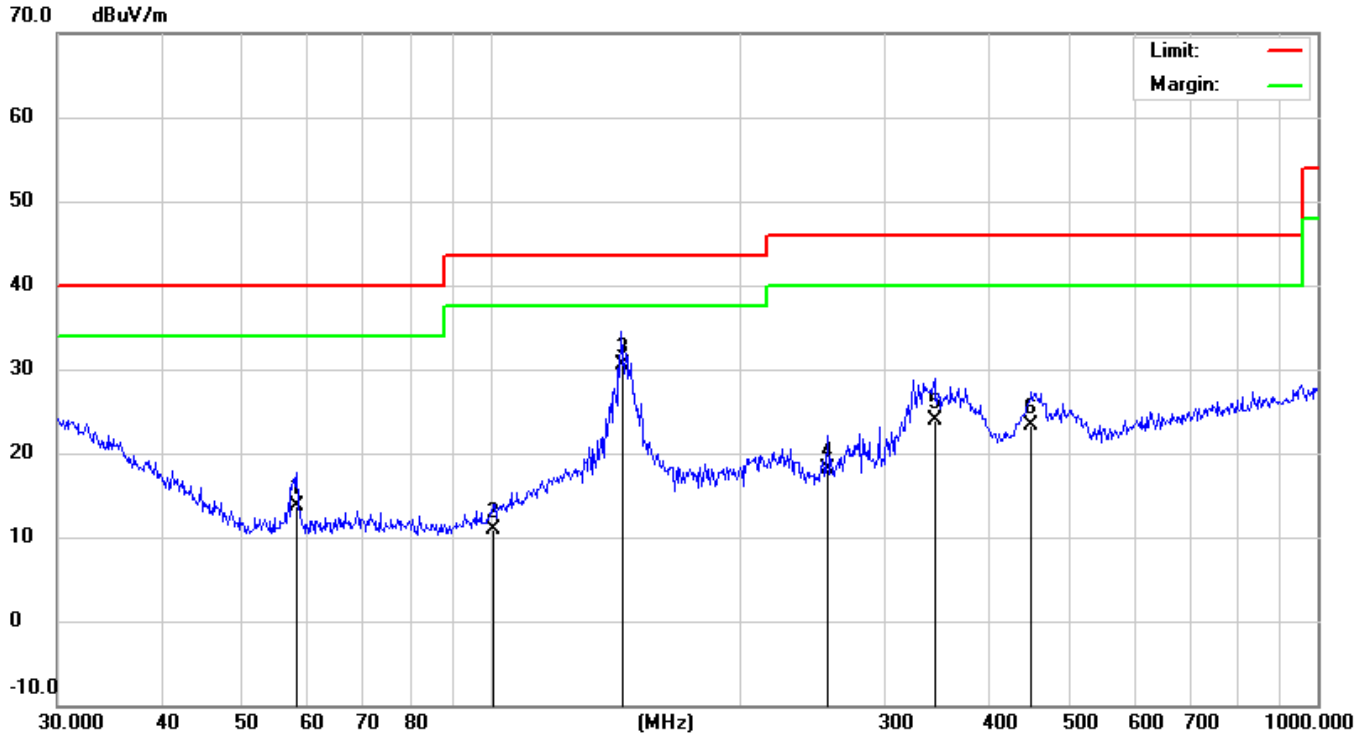

No.	Mk.	Freq. MHz	Reading Level dBuV	Correct Factor dB	Measure- ment dBuV/m	Limit dBuV/m	Over dB	Antenna Height cm	Table Degree	Detector	Comment
1		58.4074	6.05	7.68	13.73	40.00	-26.27			QP	
2		100.9339	1.20	9.80	11.00	43.50	-32.50			QP	
3	*	143.8295	17.45	13.13	30.58	43.50	-12.92			QP	
4		255.6231	6.08	11.99	18.07	46.00	-27.93			QP	
5		344.3855	9.56	14.34	23.90	46.00	-22.10			QP	
6		451.1350	6.66	16.58	23.24	46.00	-22.76			QP	

*:Maximum data x:Over limit !:over margin

EUT:	TUMI Headphone	M/N:	TUAHP
Mode:	GFSK-CH0	Polarization:	Vertical
Tested by:	Sunny(Engineer)	Power:	DC 3.7V by Battery
Temperature: / Humidity	23.9°C / 53.6%	Test date:	2016-12-08

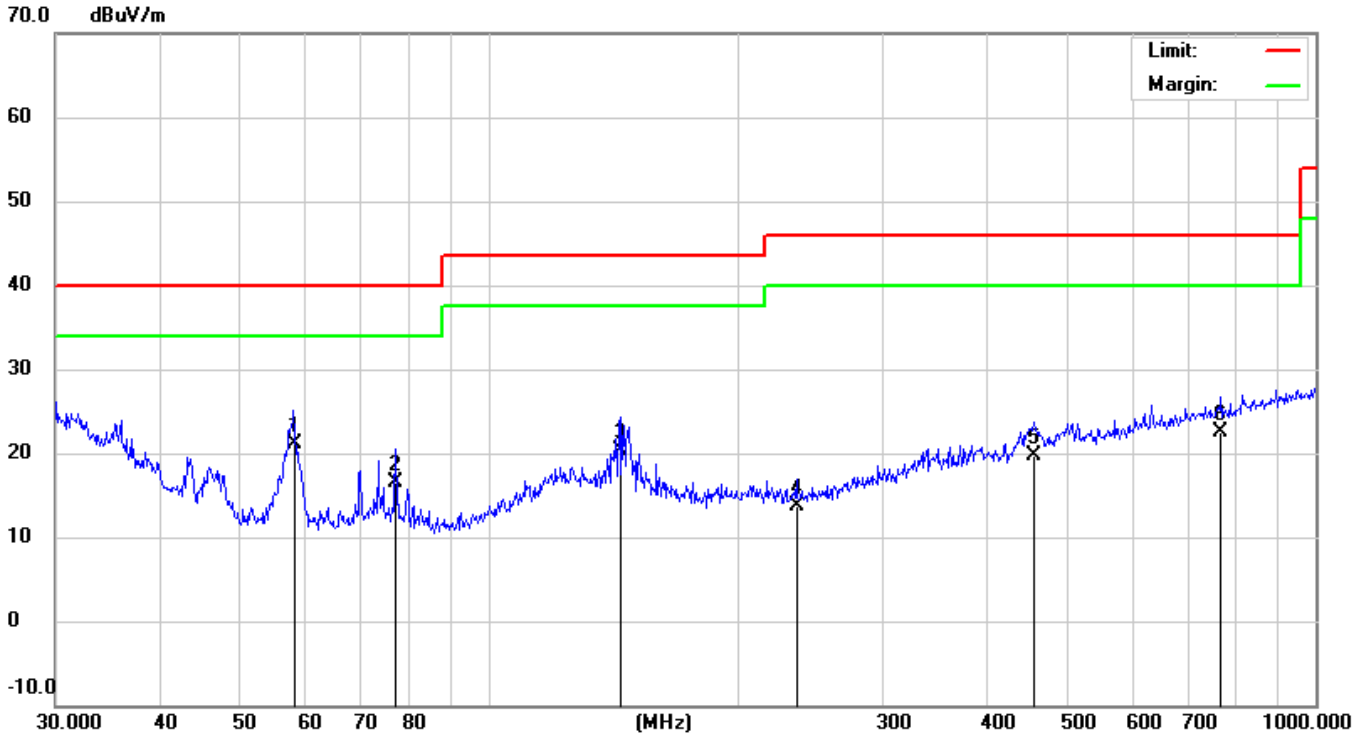

No.	Mk.	Freq.	Reading Level	Correct Factor	Measurement	Limit	Over	Antenna Height	Table Degree	
		MHz	dBuV	dB	dBuV/m	dBuV/m	dB	cm	degree	Comment
1	*	58.2029	13.33	7.69	21.02	40.00	-18.98	QP		
2		77.3210	8.36	8.15	16.51	40.00	-23.49	QP		
3		144.3347	7.27	13.10	20.37	43.50	-23.13	QP		
4		235.8163	1.84	11.91	13.75	46.00	-32.25	QP		
5		457.5073	2.92	16.72	19.64	46.00	-26.36	QP		
6		768.7481	1.95	20.65	22.60	46.00	-23.40	QP		

*:Maximum data x:Over limit !:over margin

Above 1GHz:

EUT:	TUMI Headphone	M/N:	TUAHP
Mode:	GFSK-CH0	Polarization:	Horizontal
Tested by:	Sunny(Engineer)	Power:	DC 3.7V by Battery
Temperature: / Humidity	24.2°C / 51.3%	Test date:	2016-12-08

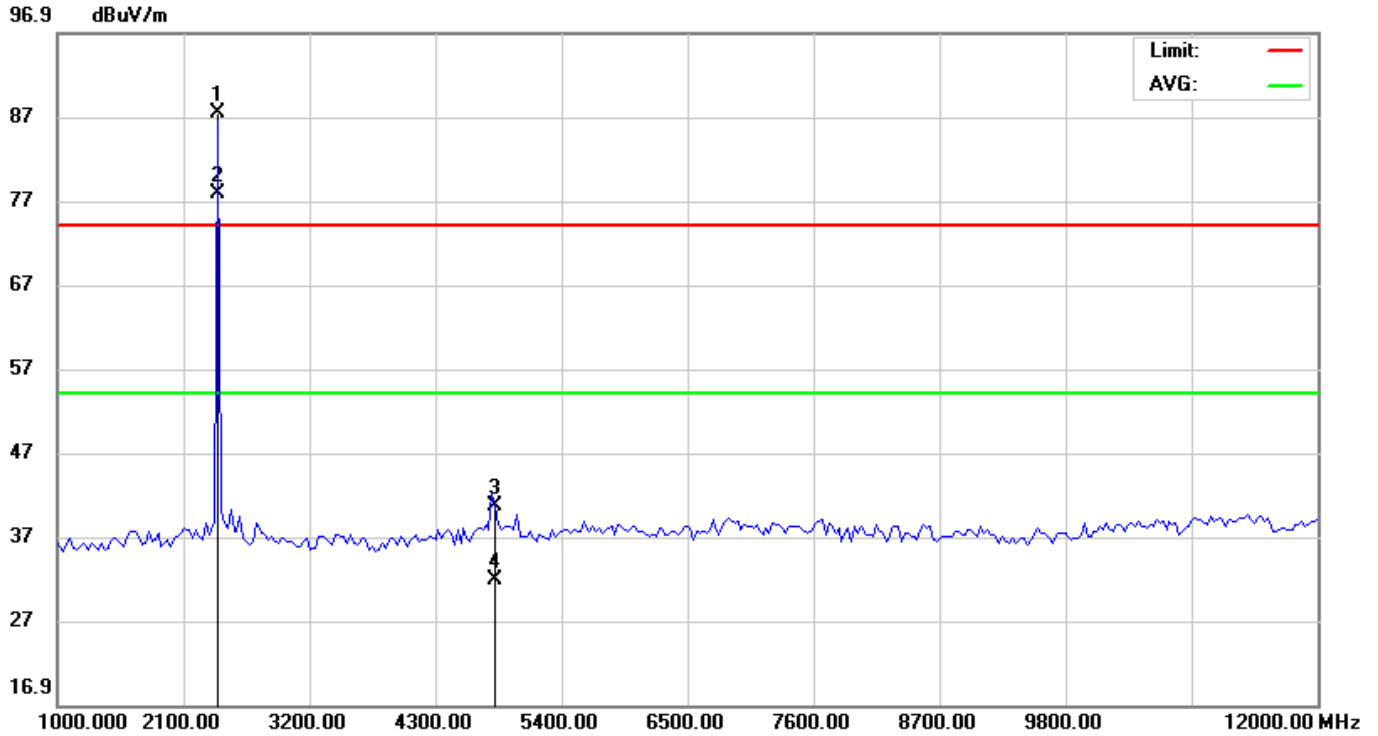

No.	Mk.	Freq.	Reading Level	Correct Factor	Measurement	Limit	Over	Antenna Height	Table Degree	
		MHz	dBuV	dB	dBuV/m	dBuV/m	dB	cm	degree	Comment
1	X	2402.500	95.86	-8.43	87.43	74.00	13.43			peak
2	*	2402.500	86.20	-8.43	77.77	54.00	23.77			AVG
3		4804.000	46.75	-6.15	40.60	74.00	-33.40			peak
4		4804.000	37.90	-6.15	31.75	54.00	-22.25			AVG

*:Maximum data x:Over limit !:over margin

EUT:	TUMI Headphone	M/N:	TUAHP
Mode:	GFSK-CH0	Polarization:	Horizontal
Tested by:	Sunny(Engineer)	Power:	DC 3.7V by Battery
Temperature: / Humidity	24.2°C / 51.3%	Test date:	2016-12-08

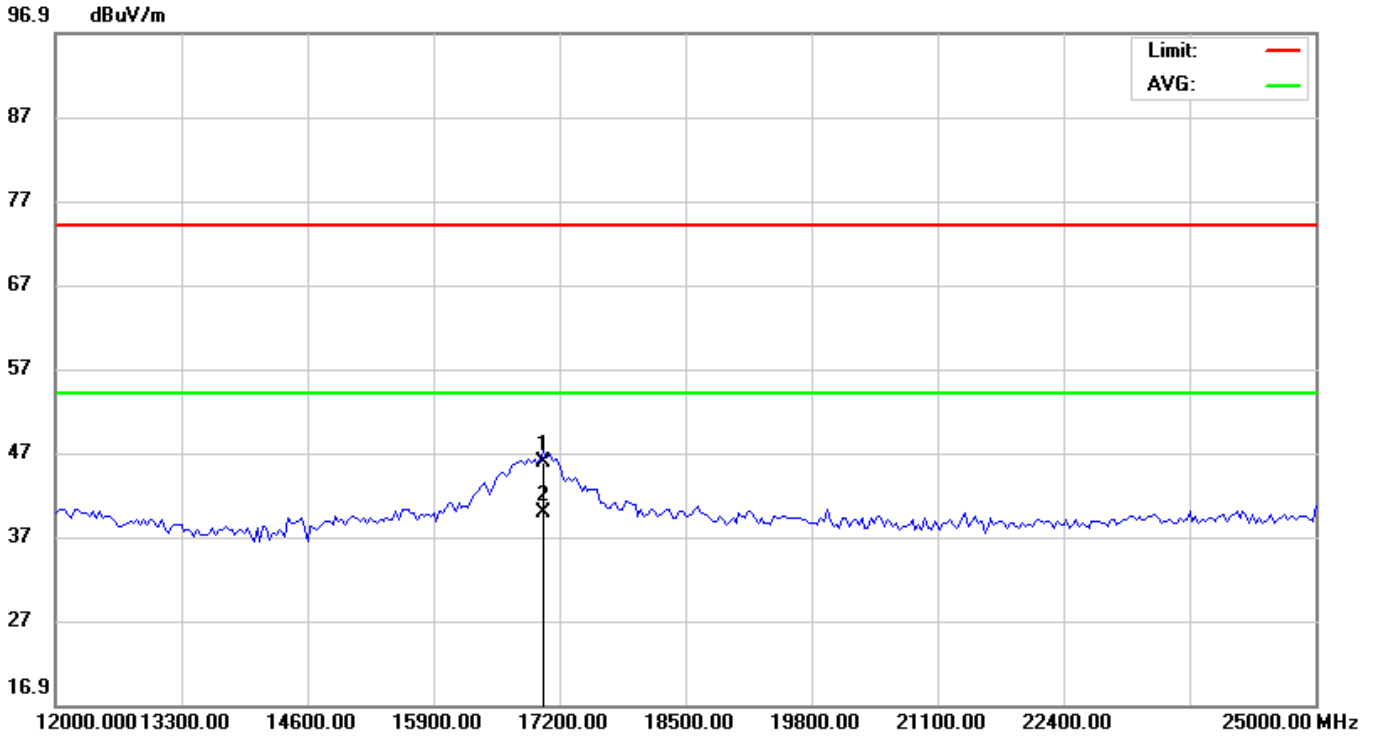

No.	Mk.	Freq.	Reading Level	Correct Factor	Measurement	Limit	Over	Antenna Height	Table Degree	
		MHz	dBuV	dB	dBuV/m	dBuV/m	dB	cm	degree	Comment
1		17037.50	39.01	6.73	45.74	74.00	-28.26			peak
2	*	17037.50	33.15	6.73	39.88	54.00	-14.12			AVG

*:Maximum data x:Over limit !:over margin

EUT:	TUMI Headphone	M/N:	TUAHP
Mode:	GFSK-CH0	Polarization:	Vertical
Tested by:	Sunny(Engineer)	Power:	DC 3.7V by Battery
Temperature: / Humidity	24.2°C / 51.3%	Test date:	2016-12-08

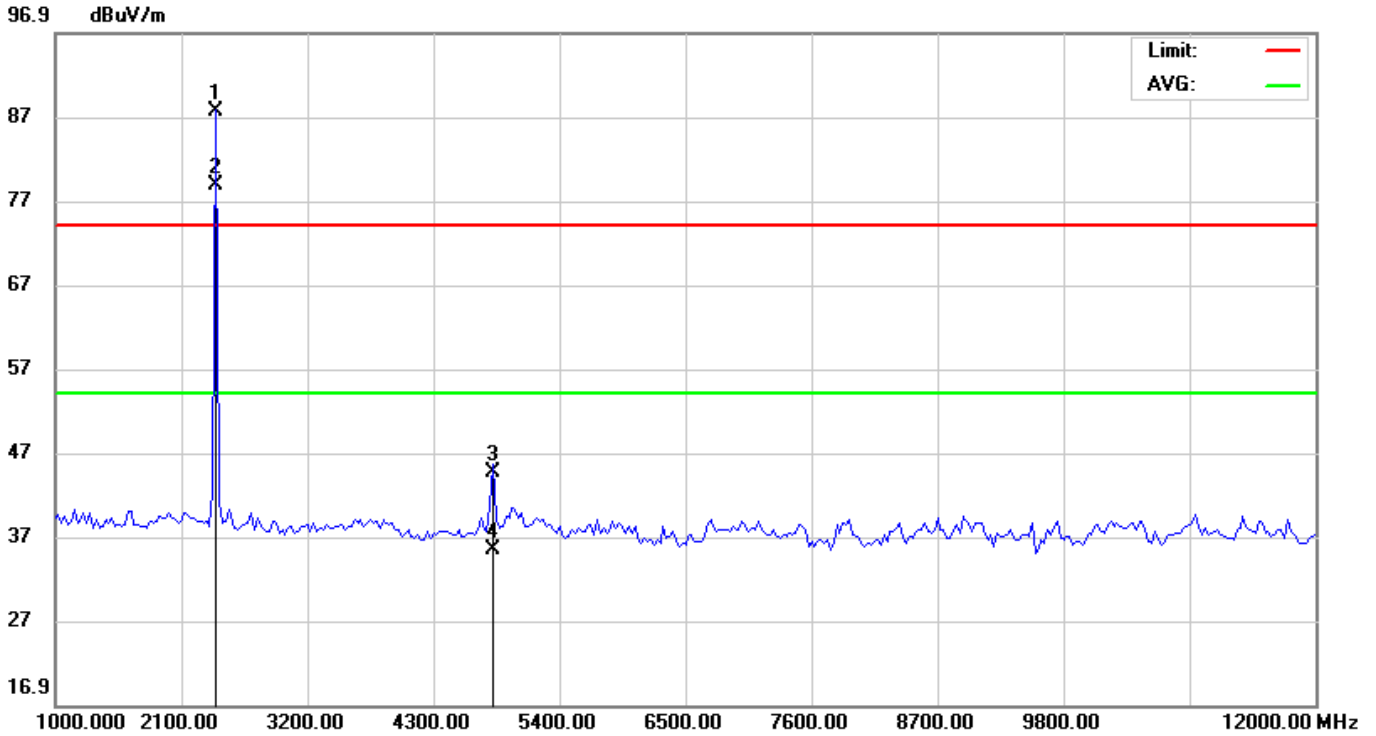

No.	Mk.	Freq. MHz	Reading Level dBuV	Correct Factor dB	Measure- ment dBuV/m	Limit dBuV/m	Over dB	Detector	Antenna Height cm	Table Degree	Comment
1	X	2402.500	96.01	-8.43	87.58	74.00	13.58	peak			
2	*	2402.500	87.30	-8.43	78.87	54.00	24.87	AVG			
3		4804.000	50.76	-6.15	44.61	74.00	-29.39	peak			
4		4804.000	41.50	-6.15	35.35	54.00	-18.65	AVG			

*:Maximum data x:Over limit !:over margin

EUT:	TUMI Headphone	M/N:	TUAHP
Mode:	GFSK-CH0	Polarization:	Vertical
Tested by:	Sunny(Engineer)	Power:	DC 3.7V by Battery
Temperature: / Humidity	24.2°C / 51.3%	Test date:	2016-12-08

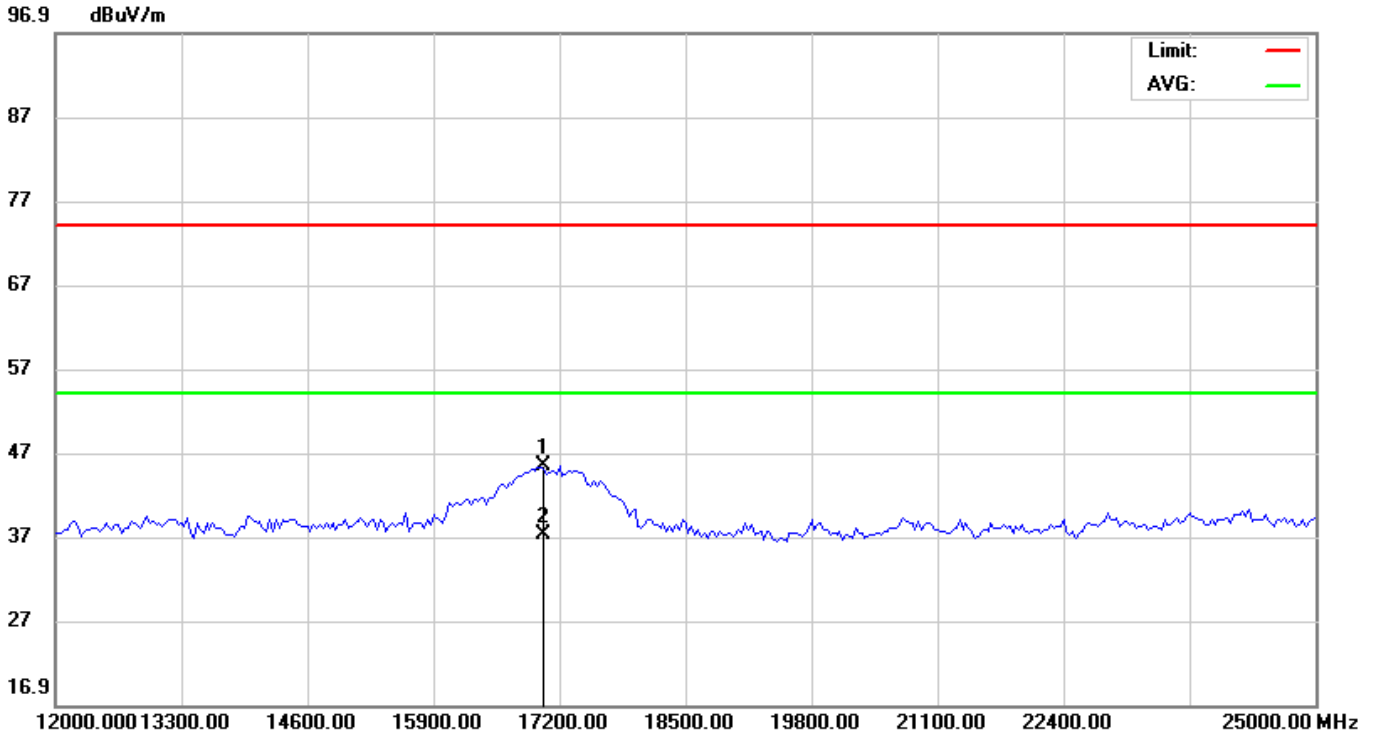

No.	Mk.	Freq. MHz	Reading Level dBuV	Correct Factor dB	Measure- ment dBuV/m	Limit dBuV/m	Over dB	Detector	Antenna Height cm	Table Degree degree	Comment
1		17006.00	38.50	6.90	45.40	74.00	-28.60	peak			
2	*	17006.00	30.24	6.90	37.14	54.00	-16.86	AVG			

*:Maximum data x:Over limit !:over margin

5.4 Conducted Peak Output Power

5.4.1 Requirement

According to FCC Section 15.247(b)(1), for frequency hopping systems operating in the 2400–2483.5 MHz band employing at least 75 non-overlapping hopping channels, and all frequency hopping systems in the 5725- 5850 MHz band: 1 watt. For all other frequency hopping systems in the 2400–2483.5 MHz band: 0.125 watts

5.4.2 Block Diagram of Test Setup



5.4.3 Test Procedure

1. Place the EUT on a bench and set in transmitting mode.
2. Remove the antenna from the EUT and then connect a low loss RF cable from the antenna port to an EMI test receiver.
3. Add a correction factor to the display.

5.4.4 Test Result

Test Item:	Peak Output Power	Temperature :	21°C
Tested by:	Kang (Engineer)	Relative Humidity :	59%

Mode	Channel	Frequency (MHz)	Peak Output Power(dBm)	Limit		Pass/Fail
				(mW)	(dBm)	
BDR (GFSK)	Low	2402	5.265	1000	30	Pass
	Middle	2441	5.600	1000	30	Pass
	High	2480	5.836	1000	30	Pass
EDR ($\pi/4$ -DQPSK)	Low	2402	4.420	125	20.97	Pass
	Middle	2441	4.768	125	20.97	Pass
	High	2480	5.083	125	20.97	Pass
EDR (8DPSK)	Low	2402	4.575	125	20.97	Pass
	Middle	2441	4.954	125	20.97	Pass
	High	2480	5.245	125	20.97	Pass

GFSK Mode

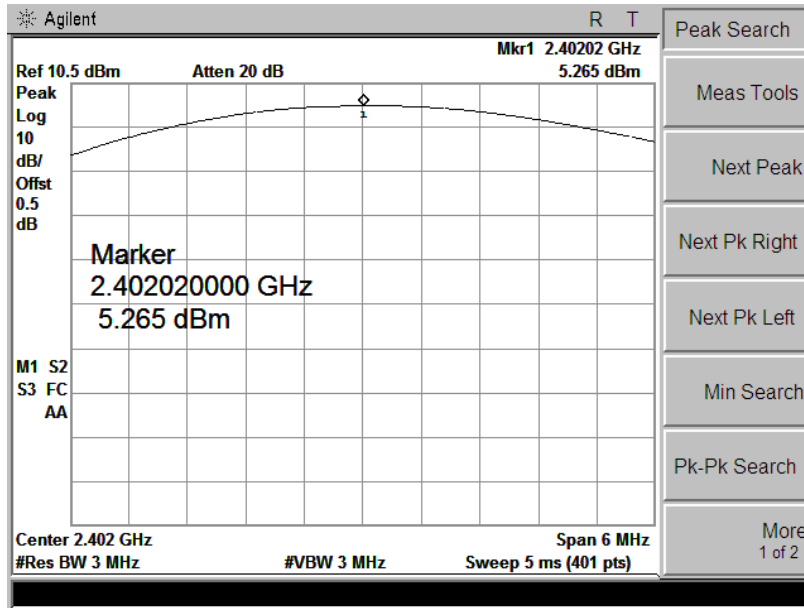

Ch 0

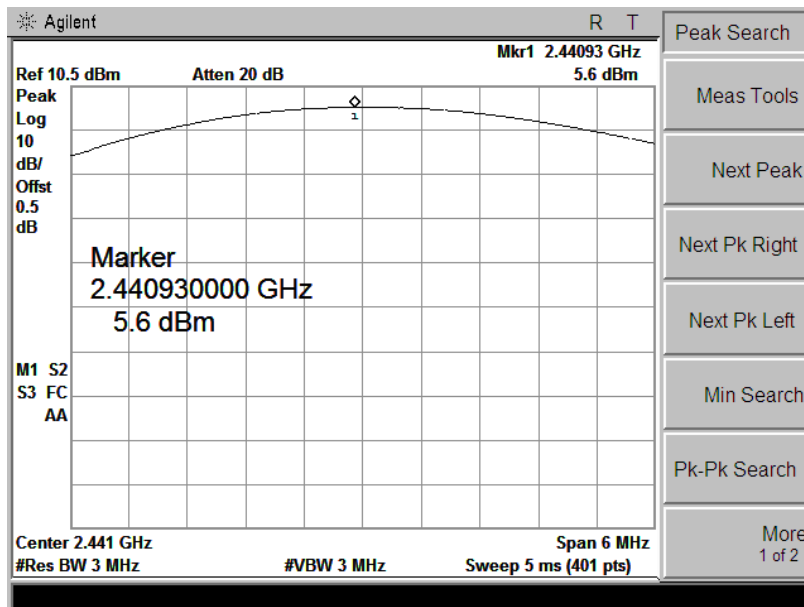

Ch 39

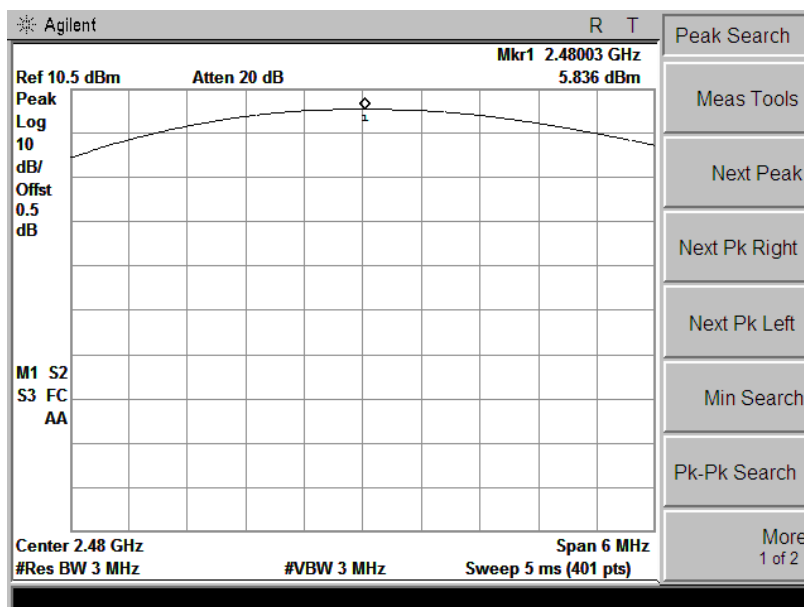

Ch 78

$\pi/4$ -DQPSK Mode

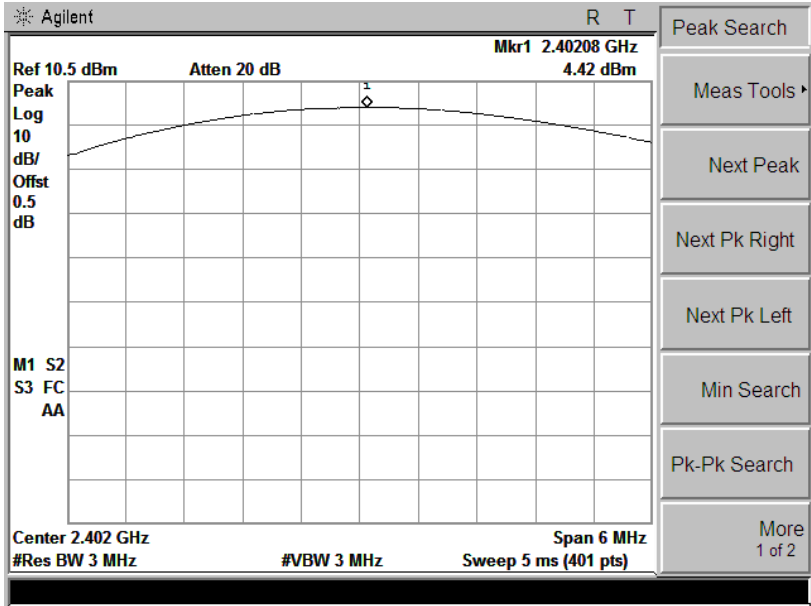

Ch 0

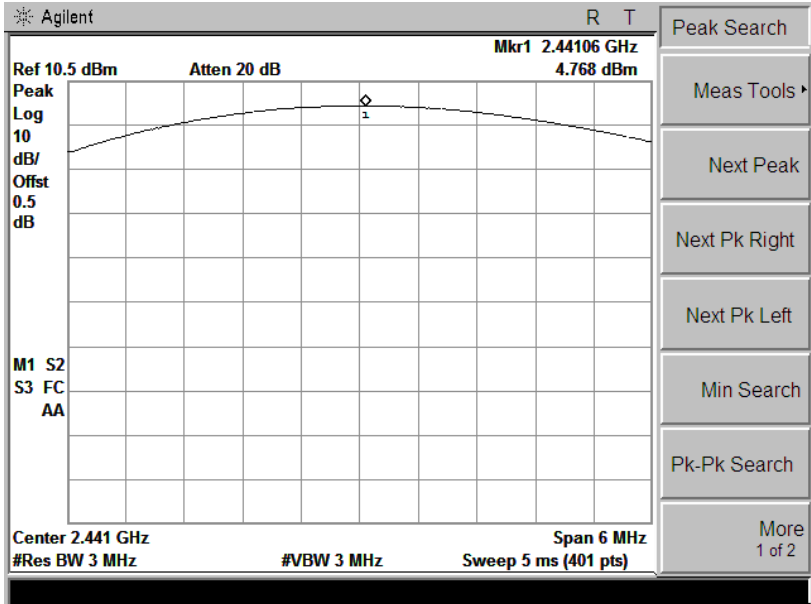

Ch 39

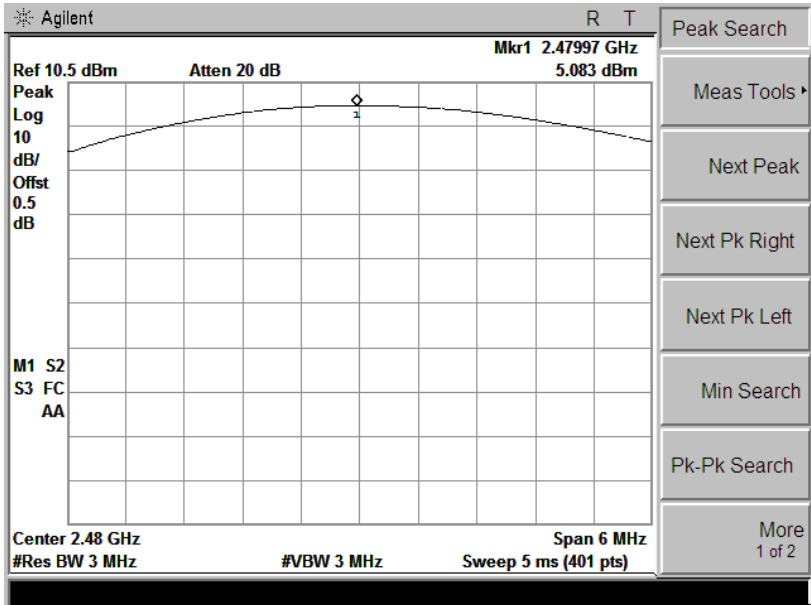

Ch 78

8DPSK Mode

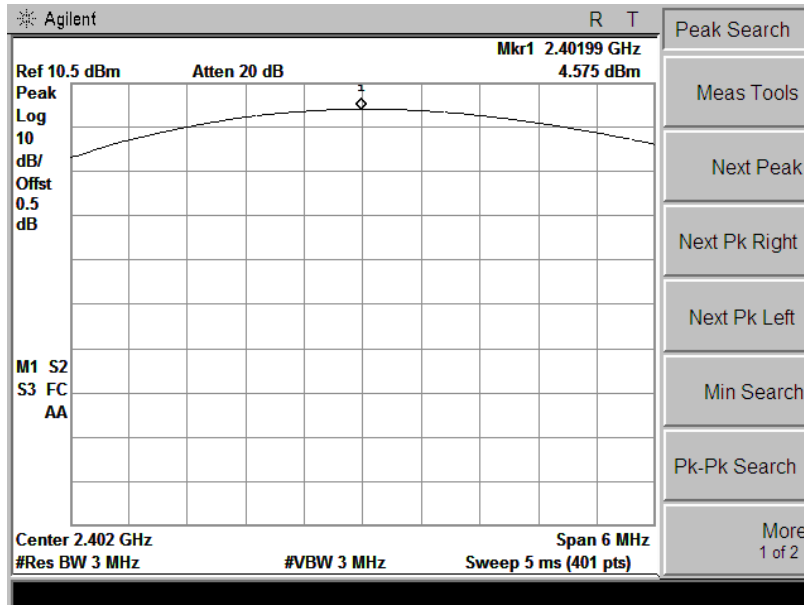

Ch 0

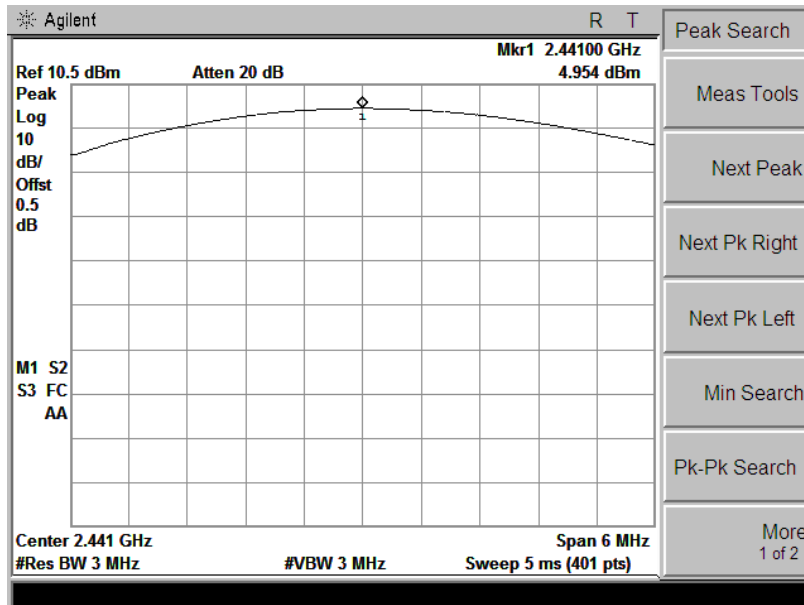

Ch 39

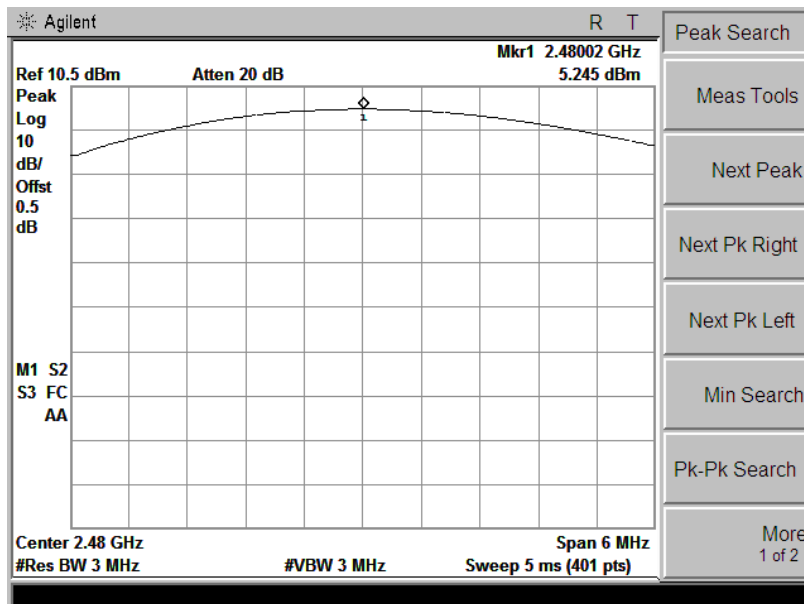

5.5 20dB Emission Bandwidth

5.5.1 Test Requirement

The bandwidth of a frequency hopping channel is the -20 dB emission bandwidth, measured with the hopping stopped.

5.5.2 Test Procedure

1. Check the calibration of the measuring instrument using either an internal calibrator or a known signal from an external generator.
2. Position the EUT on the test table without connection to measurement instrument. Turn on the EUT. Then set it to any one convenient frequency within its operating range. Set a reference level on the measuring instrument equal to the highest peak value.
3. Measure the frequency difference of two frequencies that were attenuated 20 dB from the reference level. Record the frequency difference as the emission bandwidth.
4. Repeat above procedures until all frequencies measured were complete.

5.5.3 Test Result

Test Item:	20dB Emission Bandwidth	Temperature :	23°C
Tested by:	Kang (Engineer)	Relative Humidity :	65%

Mode	Channel	Frequency (MHz)	20dB Bandwidth(MHz)
BDR (GFSK)	Low	2402	0.935
	Middle	2441	0.927
	High	2480	0.927
EDR ($\pi/4$ -DQPSK)	Low	2402	1.259
	Middle	2441	1.263
	High	2480	1.260
EDR (8DPSK)	Low	2402	1.311
	Middle	2441	1.282
	High	2480	1.277

GFSK Mode

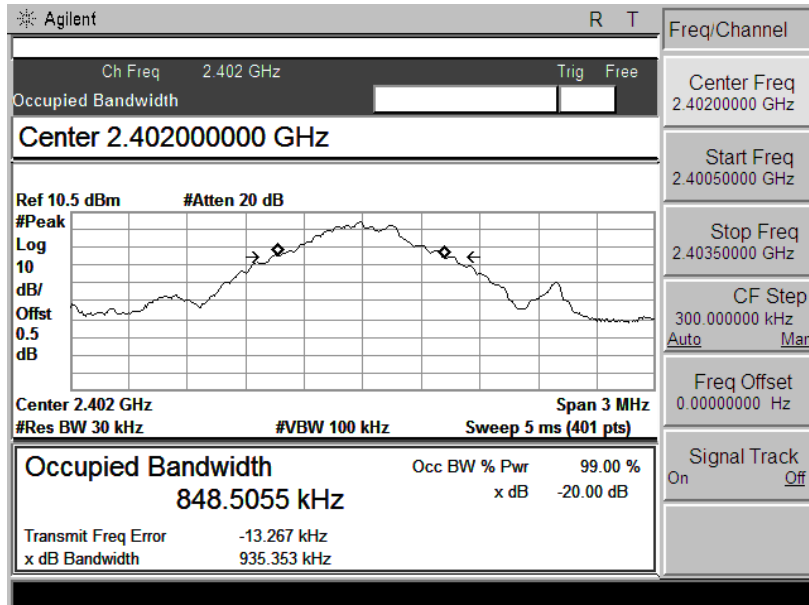

Ch 0

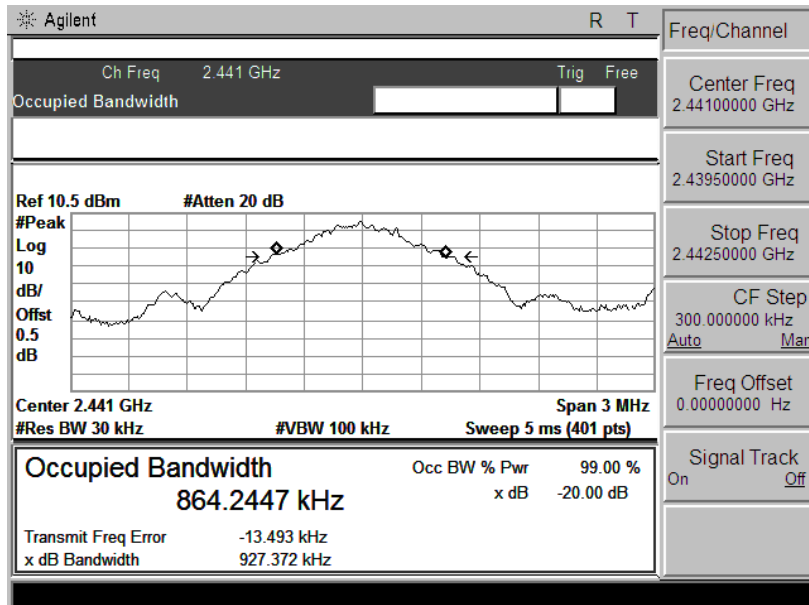

Ch 39

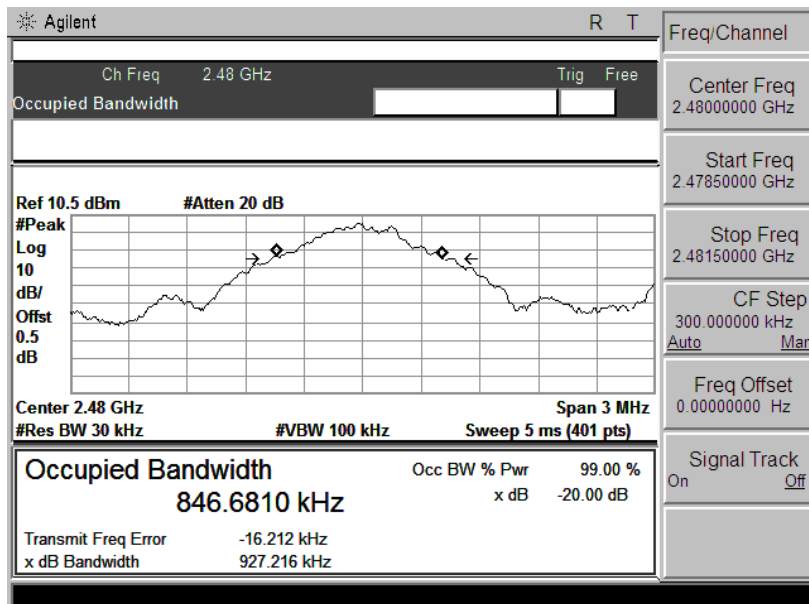

Ch 78

$\pi/4$ -DQPSK Mode

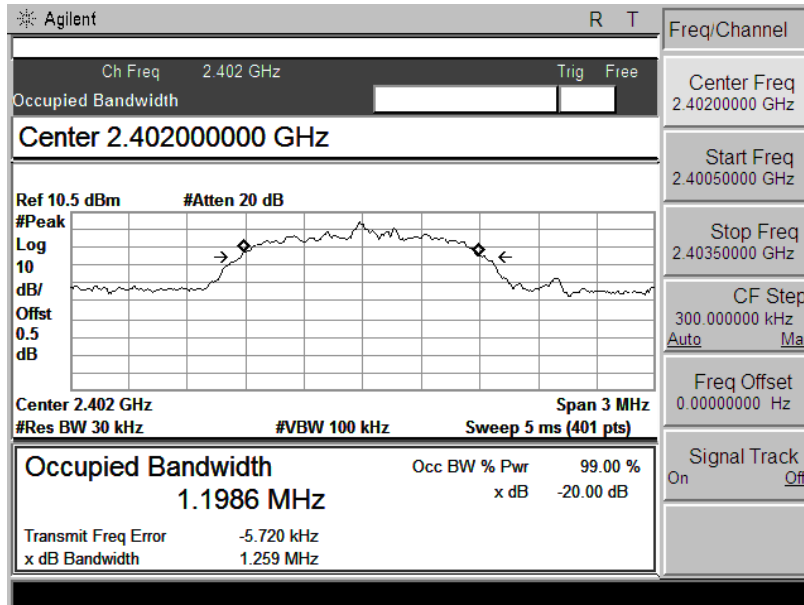

Ch 0

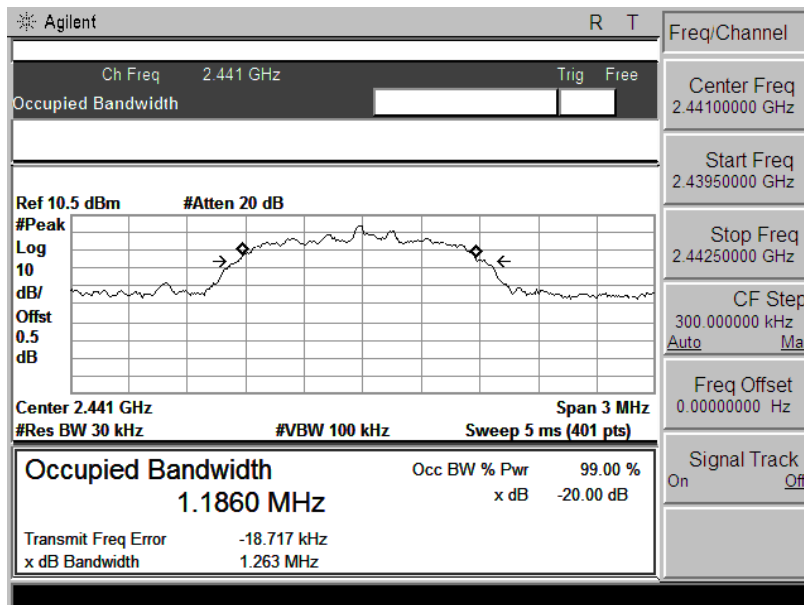

Ch 39

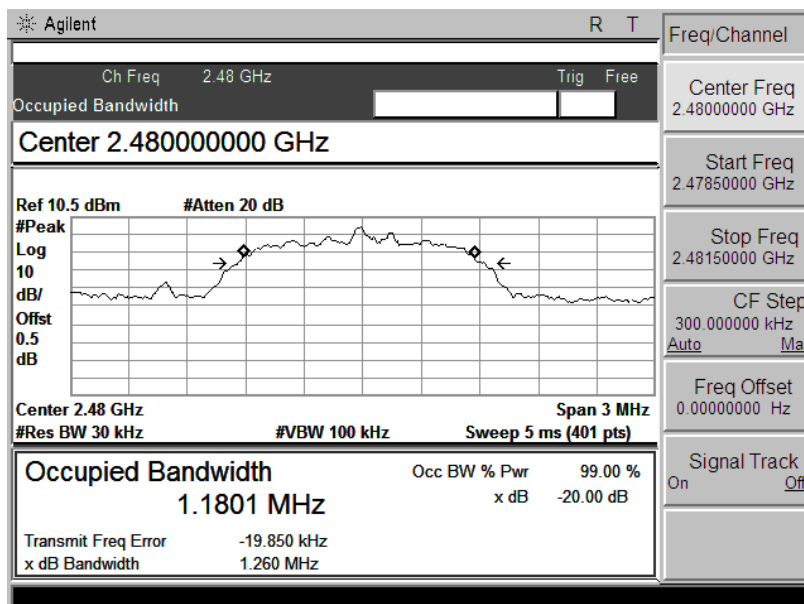

Ch 78

8DPSK Mode

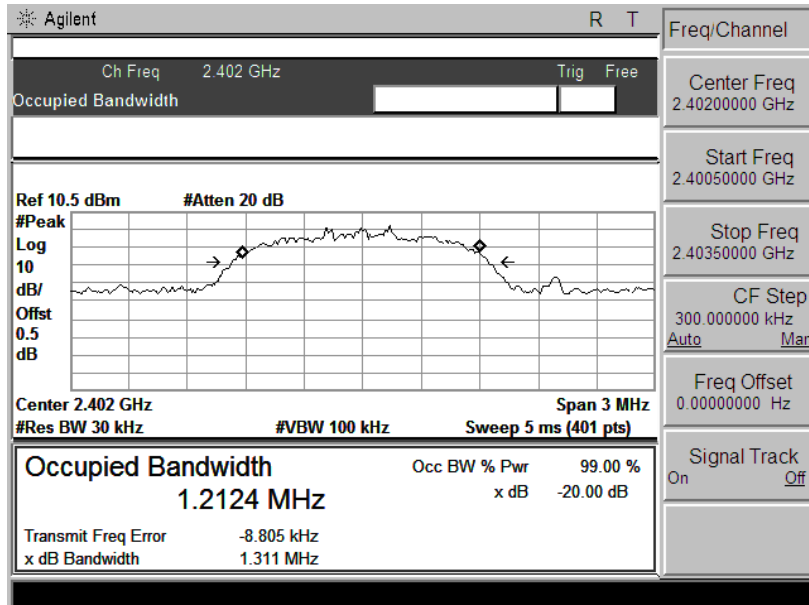

Ch 0

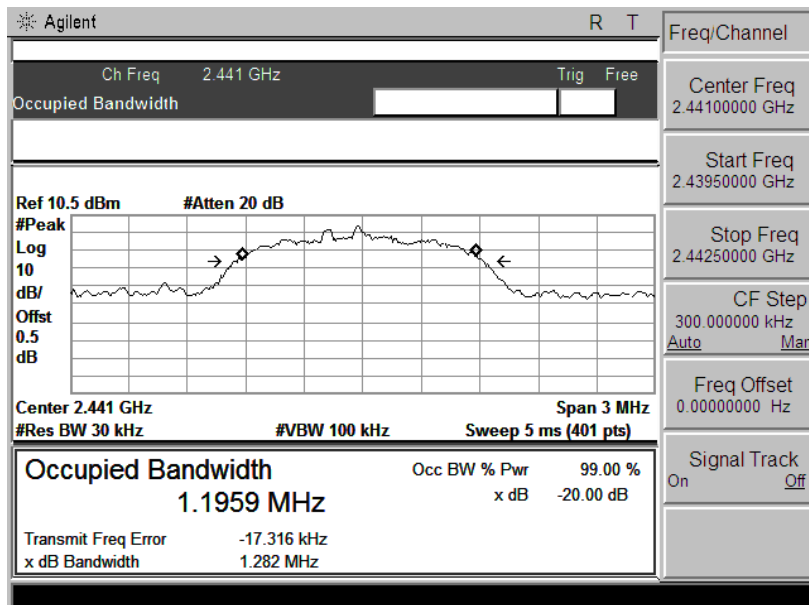

Ch 39

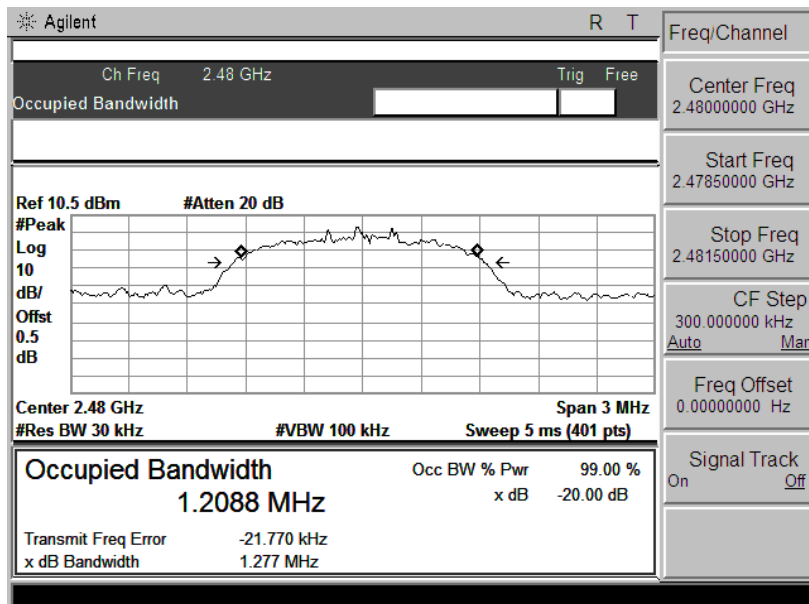

CH78

5.6 Carrier Frequency Separation

5.6.1 Test Requirement

Frequency hopping systems shall have hopping channel carrier frequencies separated by a minimum of 25 kHz or the 20dB bandwidth of the hopping channel, whichever is greater. Alternatively, frequency hopping systems operating in the 2400-2483.50 MHz band may have hopping channel carrier frequencies that are separated by 25 kHz or two-thirds of the 20dB bandwidth of the hopping channel, whichever is greater provided the systems operate with an output power no greater than 125 mW.

5.6.2 Test Procedure

The EUT must have its hopping function enabled. Use the following spectrum analyzer settings:

Span=wide enough to capture the peaks of two adjacent channels

Resolution (or IF) Bandwidth (RBW) $\geq 1\%$ of the span

Video (or Average) Bandwidth (VBW) \leq RBW

Sweep=auto

Detector function=peak

Trace=max hold

5.6.3 Test Result

Test Item:	Carrier Frequency Separation	Temperature :	23°C
Tested by:	Kang (Engineer)	Relative Humidity :	65%

Mode	Channel	Frequency (MHz)	Channel Separation (MHz)	Limit (MHz)	Result
BDR (GFSK)	Low	2402	0.998	0.935	Pass
	Middle	2441	0.983	0.927	Pass
	High	2480	0.998	0.927	Pass
EDR ($\pi/4$ -DQPSK)	Low	2402	1.005	0.839	Pass
	Middle	2441	0.990	0.842	Pass
	High	2480	0.983	0.840	Pass
EDR (8DPSK)	Low	2402	0.998	0.874	Pass
	Middle	2441	0.990	0.855	Pass
	High	2480	0.990	0.851	Pass

GFSK Mode

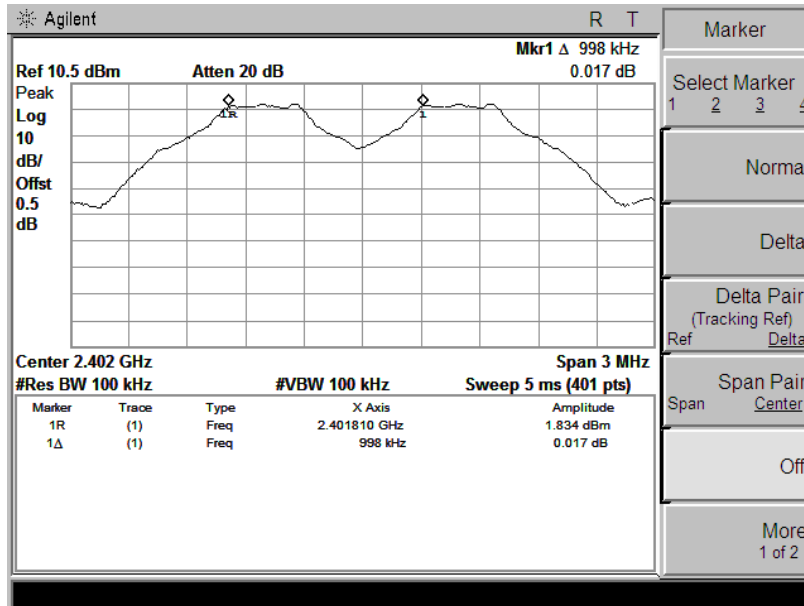

Ch 0

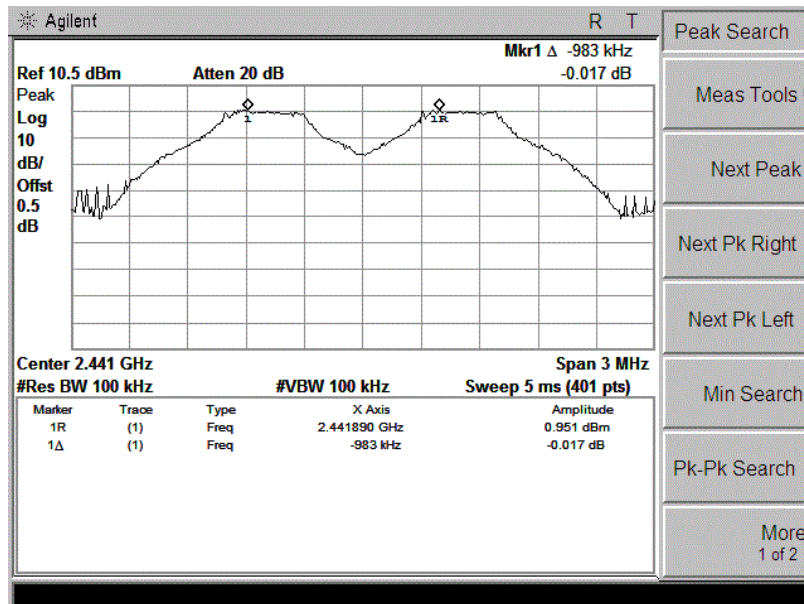

Ch 39

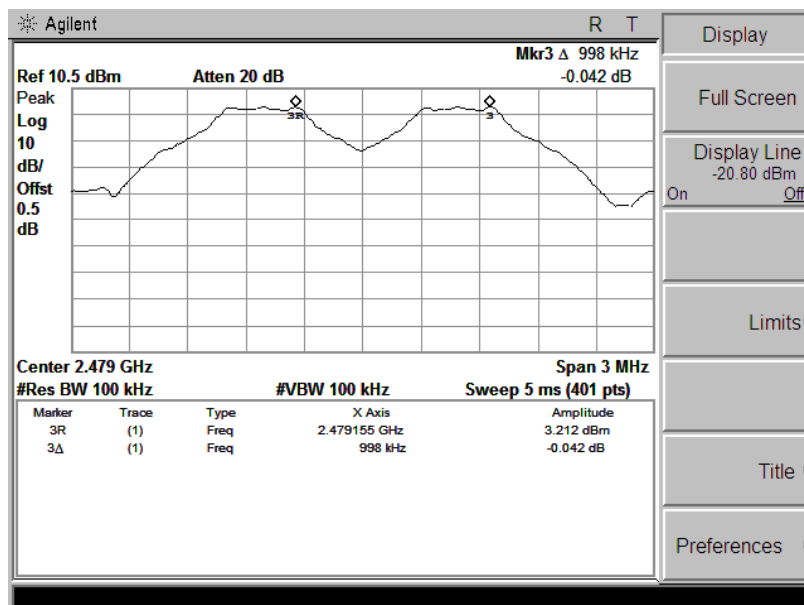

Ch 78

$\pi/4$ -DQPSK Mode

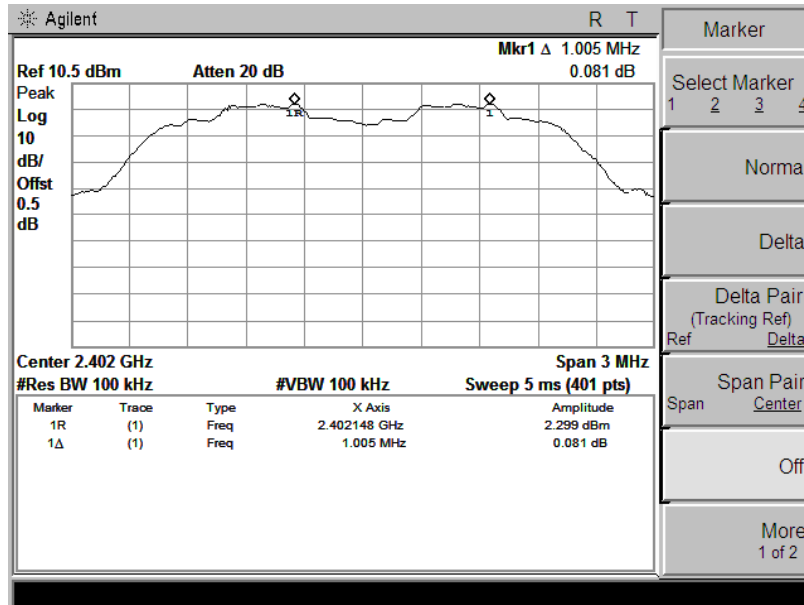

Ch 0

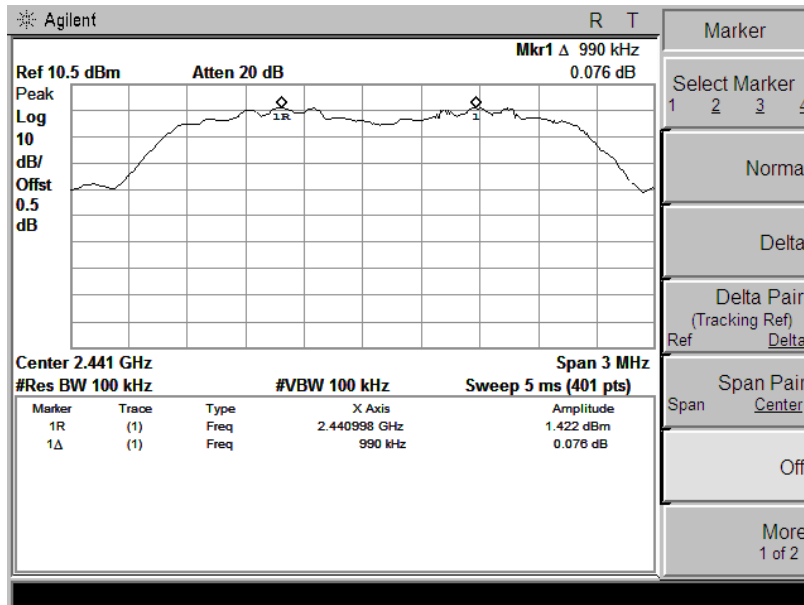

Ch 39

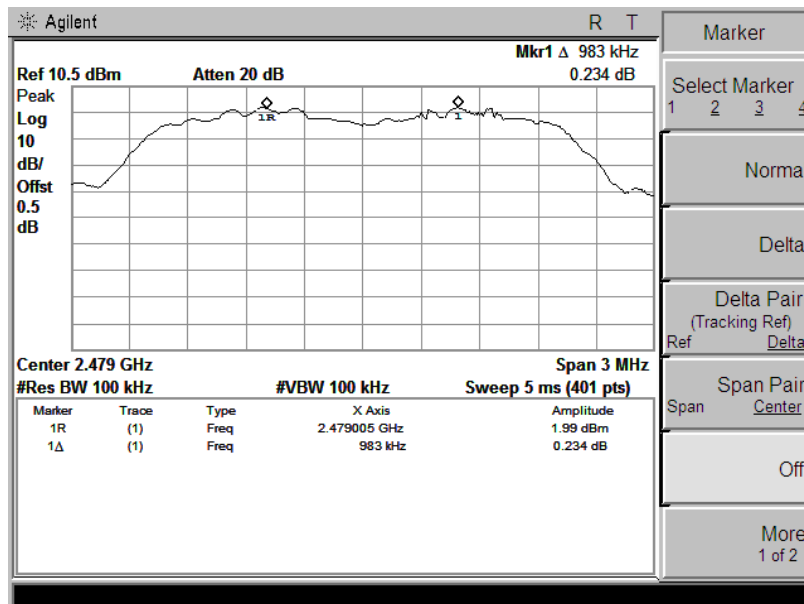

Ch 78

8DPSK Mode

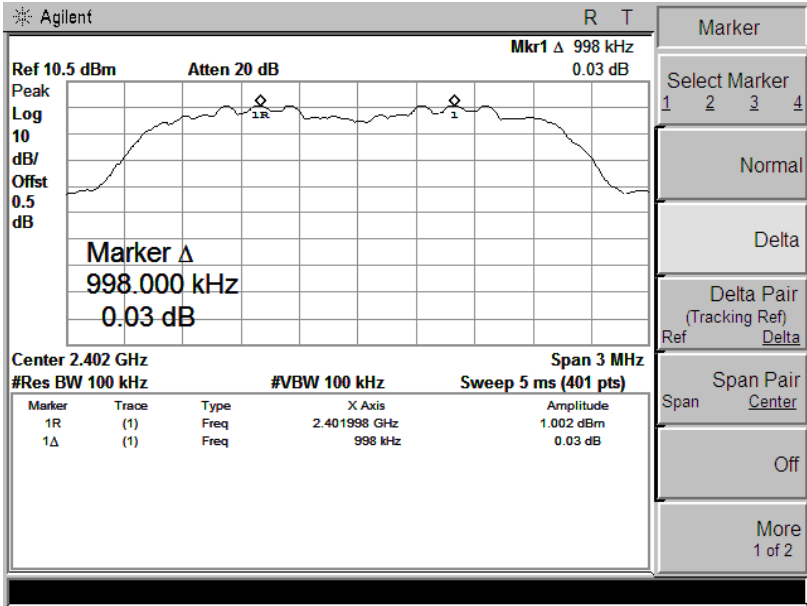

Ch 0

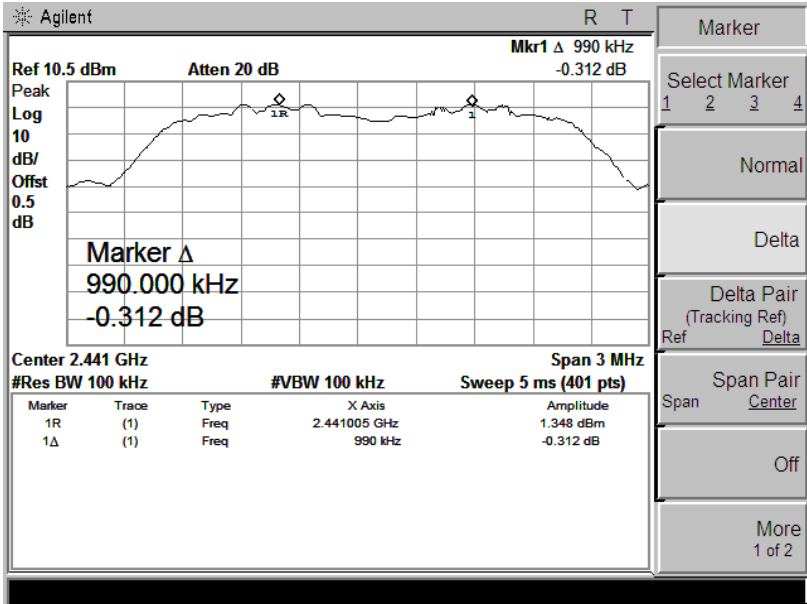

Ch 39

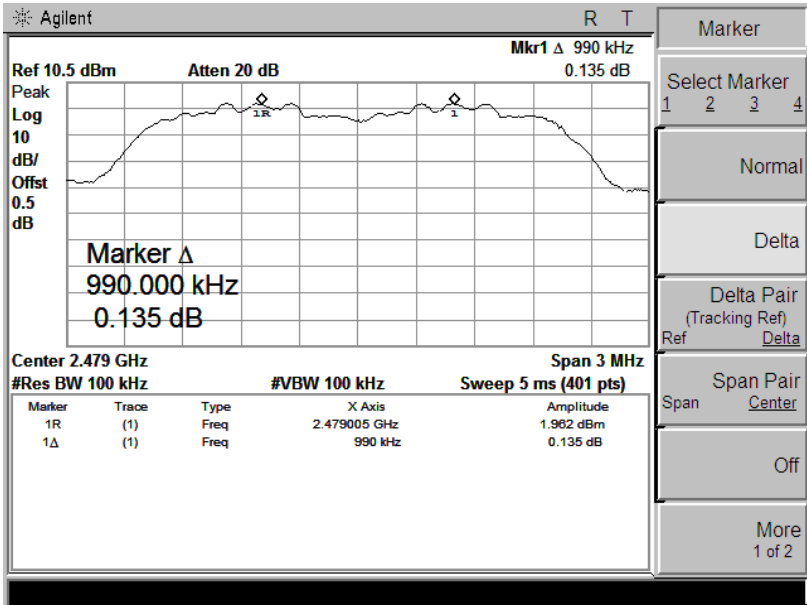

Ch 78

5.7 Number of Hopping Channel

5.7.1 Test Requirement

Frequency hopping systems in the 2400–2483.5 MHz band shall use at least 15 channels. The average time of occupancy on any channel shall not be greater than 0.4 seconds within a period of 0.4 seconds multiplied by the number of hopping channels employed. Frequency hopping systems may avoid or suppress transmissions on a particular hopping frequency provided that a minimum of 15 channels are used.

5.7.2 Test Procedure

1. Check the calibration of the measuring instrument (SA) using either an internal calibrator or a known signal from an external generator.
2. Set the EUT in hopping mode from first channel to last.
3. By using the Max-Hold function record the Quantity of the channel.

5.7.3 Test Result

Test Item:	Number of Hopping Channel	Temperature :	23°C
Tested by:	Kang (Engineer)	Relative Humidity :	65%

Mode	Frequency Range (MHz)	Number of Hopping Channel	Limit
GFSK	2400-2483.5	79	≥15
$\pi/4$ -DQPSK	2400-2483.5	79	≥15
8DPSK	2400-2483.5	79	≥15

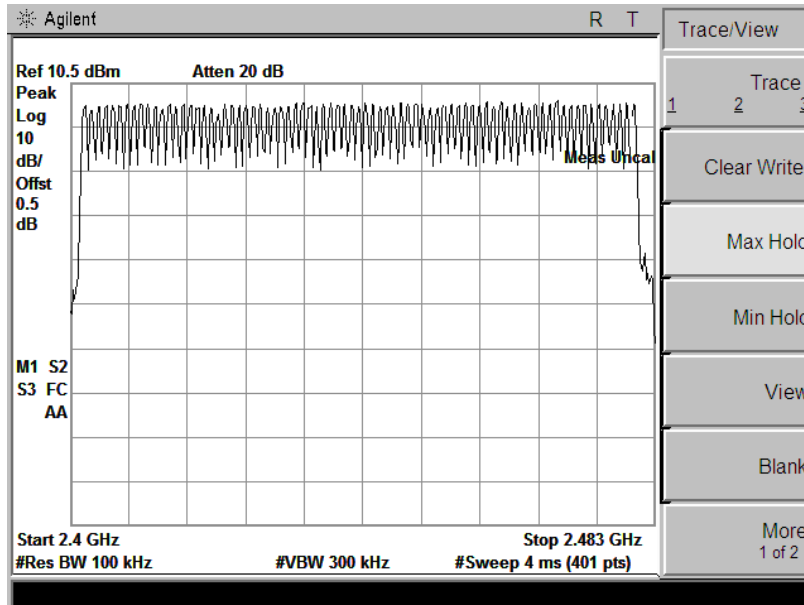

GFSK Mode

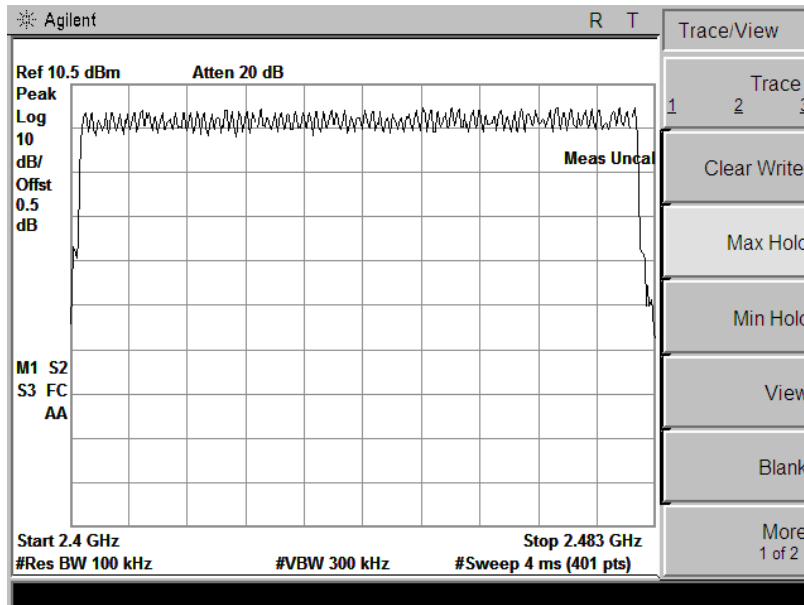

$\pi/4$ -DQPSK

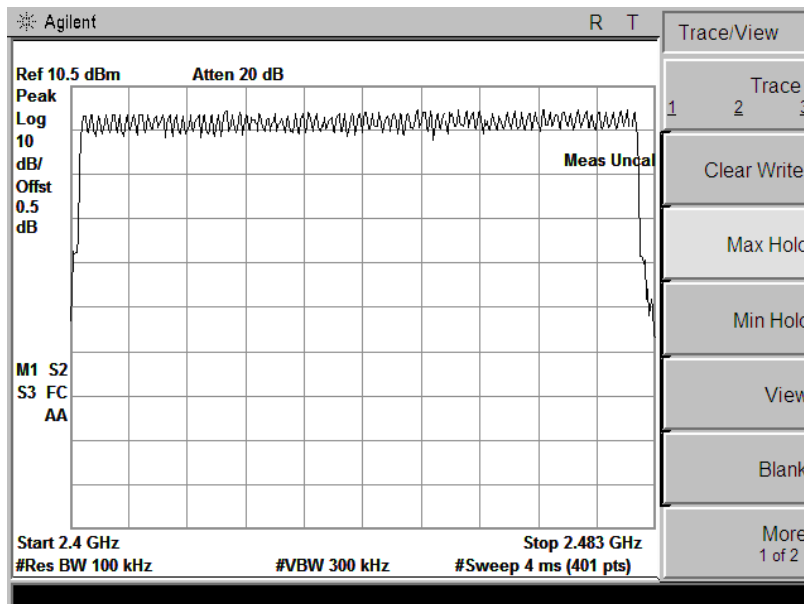

8DPSK Mode

5.8 Dwell Time

5.8.1 Test Requirement

Frequency hopping systems in the 2400-2483.5 MHz shall use at least 15 channels. The average time of occupancy on any channel shall not be greater than 0.4 seconds within a period of 0.4 seconds multiplied by the number of hopping channels employed. Frequency hopping systems may avoid or suppress transmissions on a particular hopping frequency provided that a minimum of 15 channels are used.

5.8.2 Test Procedure

The EUT was worked in channel hopping; Spectrum SPAN was set as 0. Sweep was set as 0.4 * channel no. (s), the quantity of pulse was get from single sweep. In addition, the time of single pulses was tested.

Dwell Time= time slot length * hope rate/ number of hopping channels * 31.6s Hop rate=1600/s

5.8.3 Test Result

Test Item:	Dwell Time	Temperature :	25°C
Tested by:	Kang (Engineer)	Relative Humidity :	65%

Mode	Packet	Pulse Time (ms)	Dwell Time(ms)	Limit(ms)	Result
GFSK	DH1	0.450	144.00	400	Pass
	DH3	1.690	270.40	400	Pass
	DH5	2.970	316.81	400	Pass
π /4DQPSK	2DH1	0.400	128.00	400	Pass
	2DH3	1.720	275.20	400	Pass
	2DH5	2.970	316.81	400	Pass
8DPSK	3DH1	0.490	156.80	400	Pass
	3DH3	1.700	272.00	400	Pass
	3DH5	2.990	318.94	400	Pass

Note: DH1/2DH1/3DH1: Dwell Time=Pulse Time(ms) \times [(1600/2/79) \times 31.6]

DH3/2DH3/3DH3: Dwell Time= Pulse Time(ms) \times [(1600/4/79) \times 31.6]

DH5/2DH5/3DH5: Dwell Time= Pulse Time(ms) \times [(1600/6/79) \times 31.6]

GFSK Mode

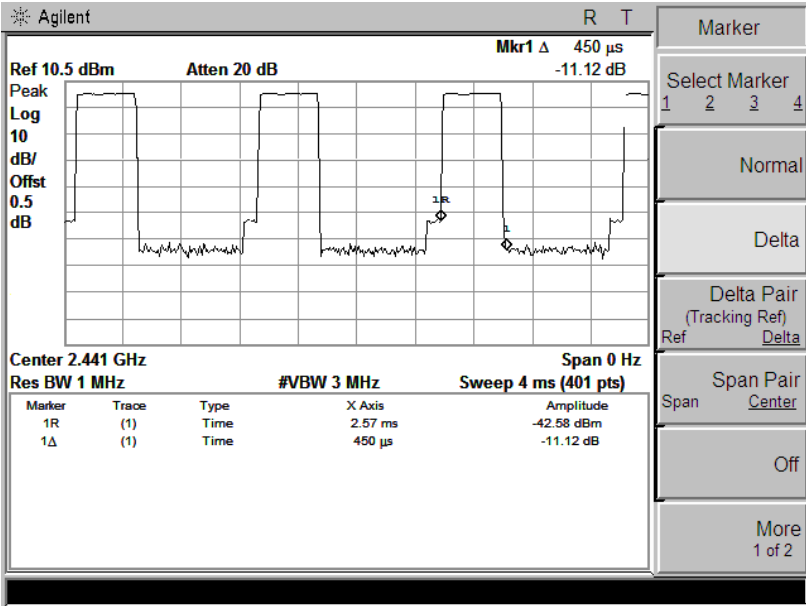

DH1

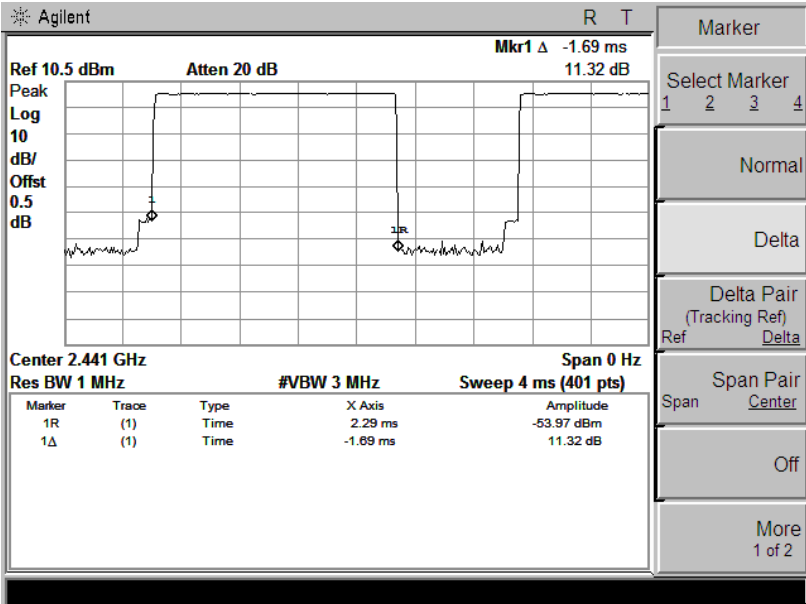

DH3

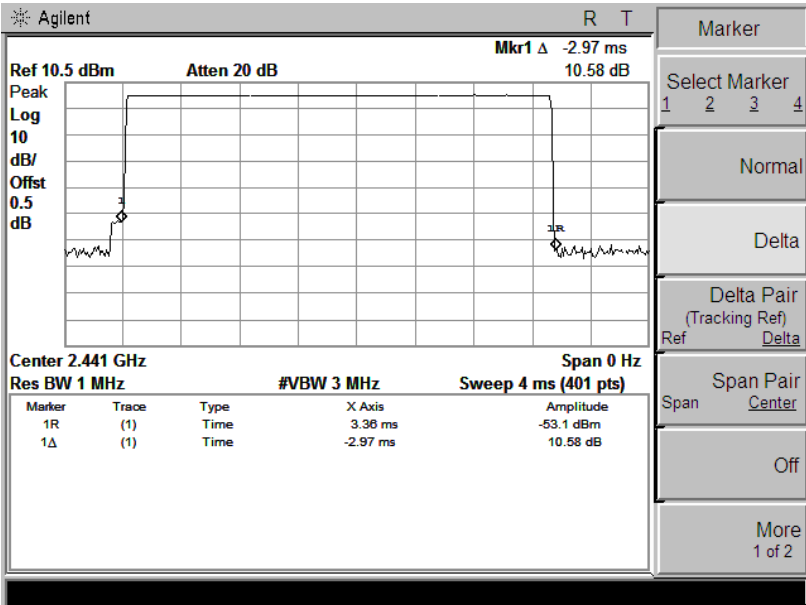

DH5

$\pi/4$ -DQPSK Mode

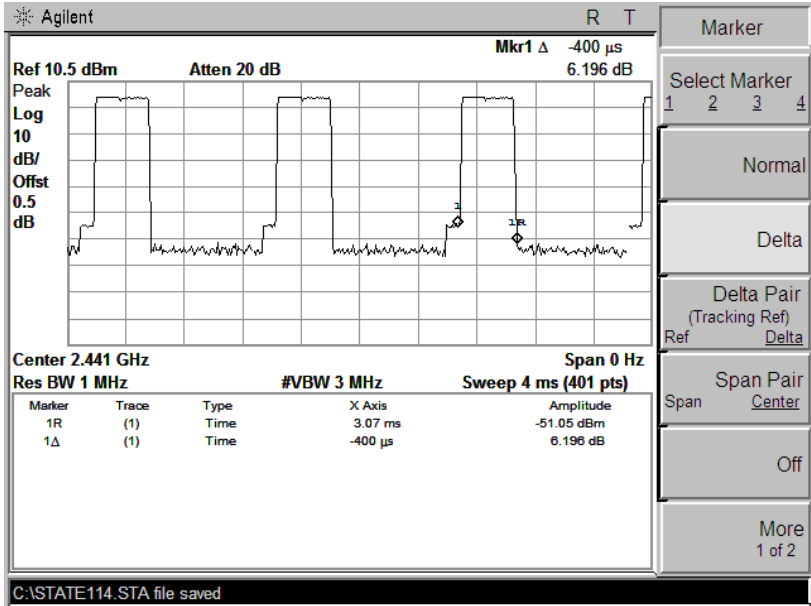

DH1

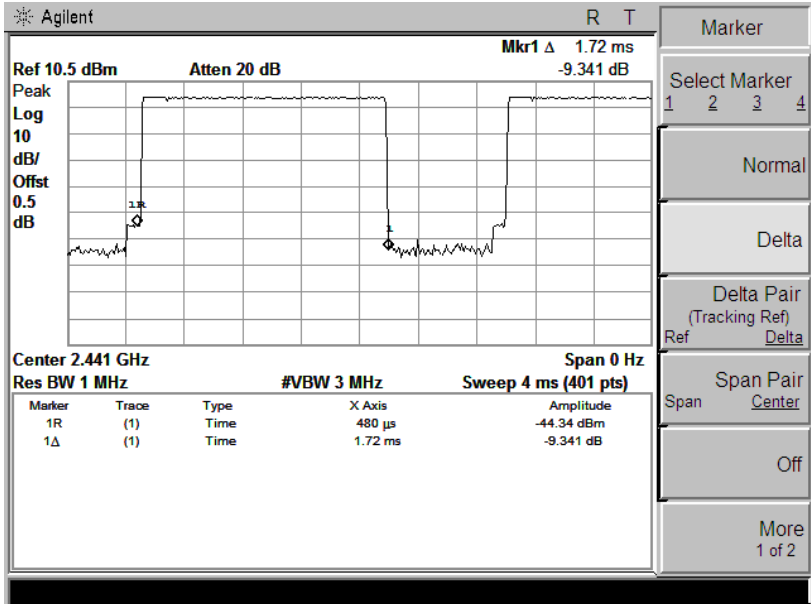

DH3

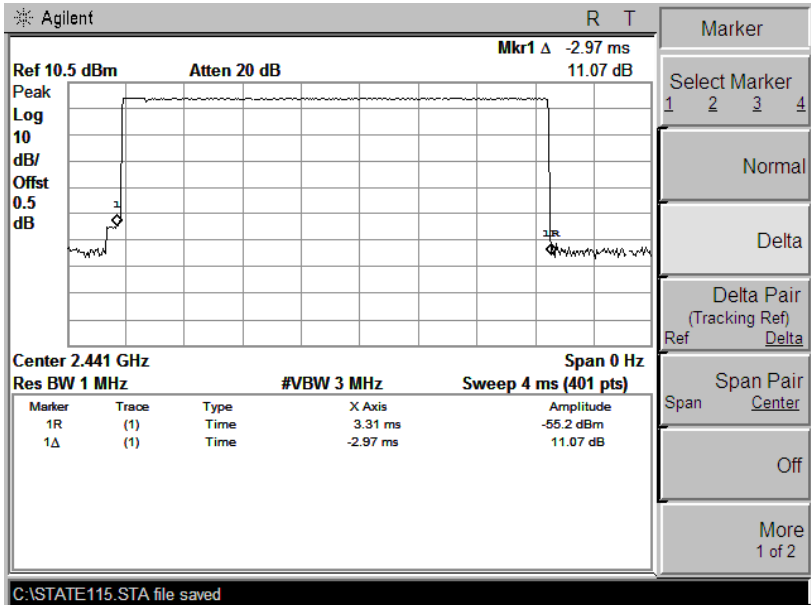

DH5

8DPSK Mode

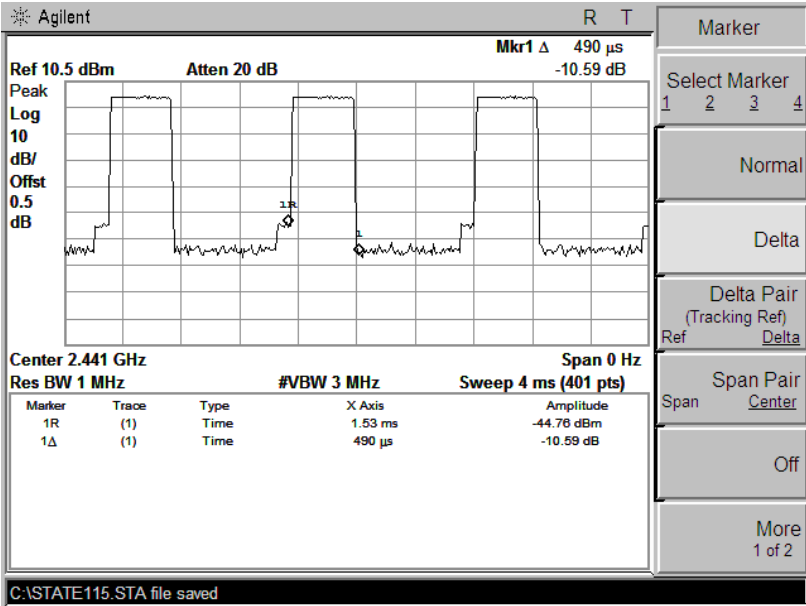

DH1

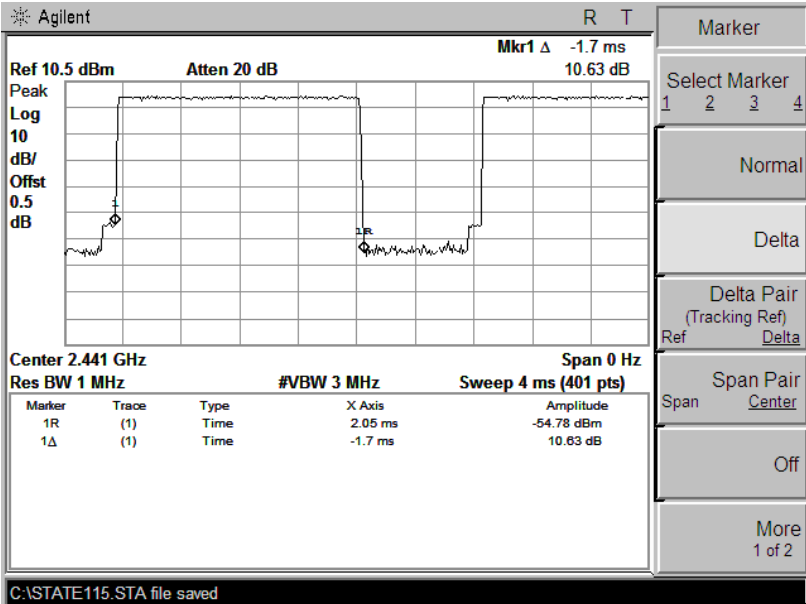

DH3

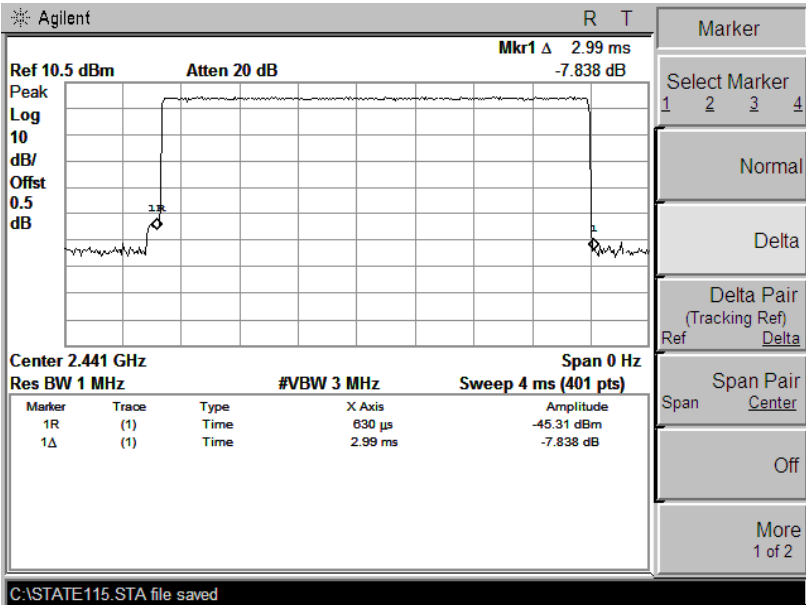

DH5

5.9 Band Edge and Conducted Spurious Emissions

5.9.1 Test Requirement

In any 100 kHz bandwidth outside the frequency band in which the spread spectrum or digitally modulated intentional radiator is operating, the radio frequency power that is produced by the intentional radiator shall be at least 20 dB below that in the 100 kHz bandwidth within the band that contains the highest level of the desired power, based on either an RF conducted or a radiated measurement, provided the transmitter demonstrates compliance with the peak conducted power limits. If the transmitter complies with the conducted power limits based on the use of RMS averaging over a time interval, as permitted under paragraph (b)(3) of this section, the attenuation required under this paragraph shall be 30 dB instead of 20 dB. Attenuation below the general limits specified in §15.209(a) is not required.

5.9.2 Test Procedure

1. Check the calibration of the measuring instrument using either an internal calibrator or a known signal from an external generator.
2. Remove the antenna from the EUT and then connect to a low loss RF cable from the antenna port to a EMI test receiver, then turn on the EUT and make it operate in transmitting mode. Then set it to Low Channel and High Channel within its operating range, and make sure the instrument is operated in its linear range.
3. Set both RBW and VBW of spectrum analyzer to 100 kHz with a convenient frequency span including 100 kHz bandwidth from band edge.
4. Measure the highest amplitude appearing on spectral display and set it as a reference level. Plot the graph with marking the highest point and edge frequency.
5. Repeat above procedures until all measured frequencies were complete.

5.9.3 Test Result

Pass

Remark:

During the Conducted Spurious Emissions test, pre-scan the GFSK, $\pi/4$ -QPSK, 8DPSK modulation, and found the GFSK modulation which it is worse case.

Test Item:	Band Edge	Temperature :	23°C
Tested by:	Kang (Engineer)	Relative Humidity :	65%

Band Edge, Left Side

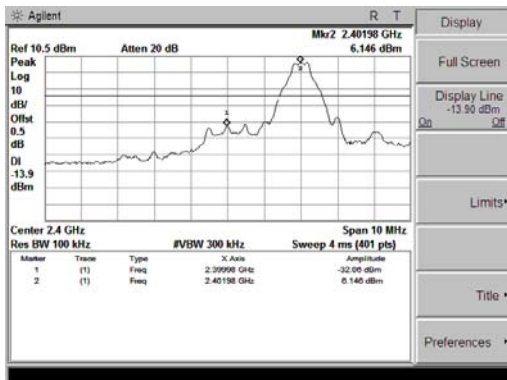

GFSK Mode, Non-Hopping

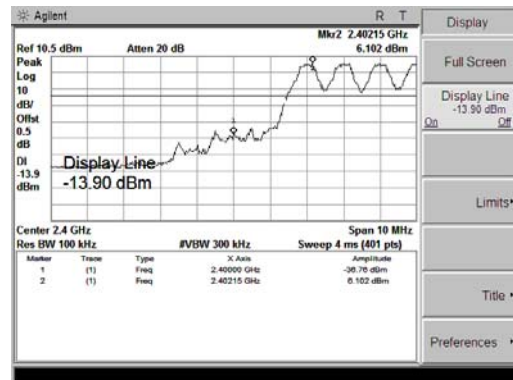

GFSK Mode, Hopping

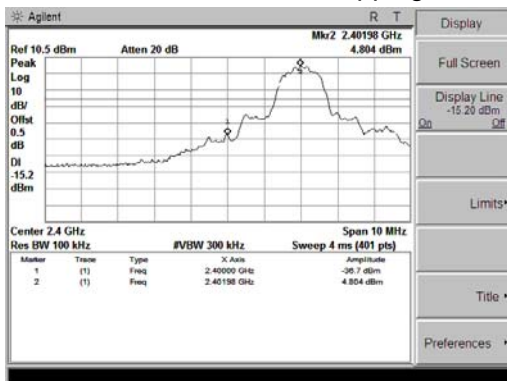

$\pi/4$ -DQPSK Mode, Non-Hopping

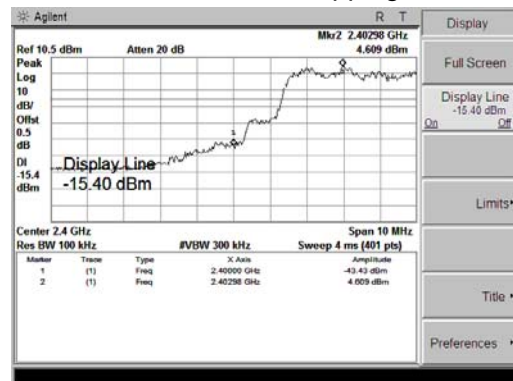

$\pi/4$ -DQPSK Mode, Hopping

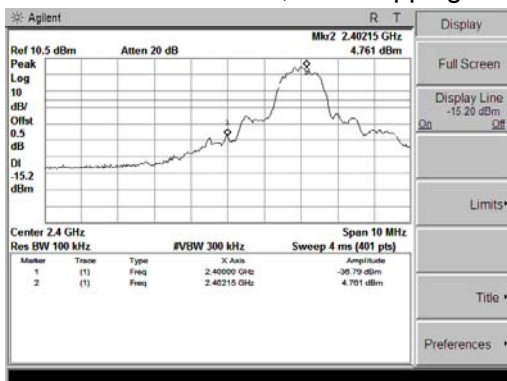

8DPSK Mode, Non-Hopping

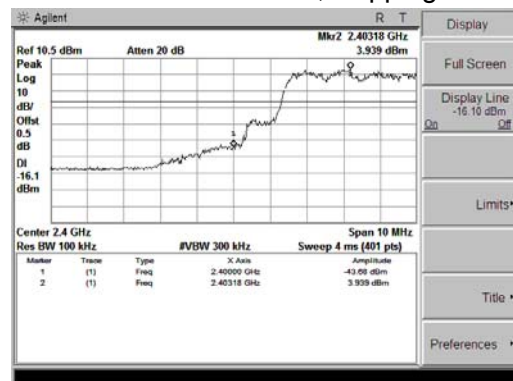

8DPSK Mode, Hopping

Band Edge, Right Side

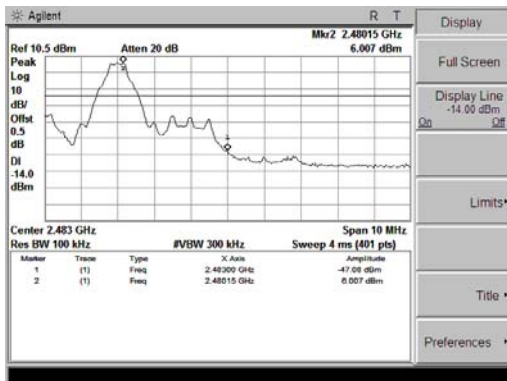

GFSK Mode, Non-Hopping

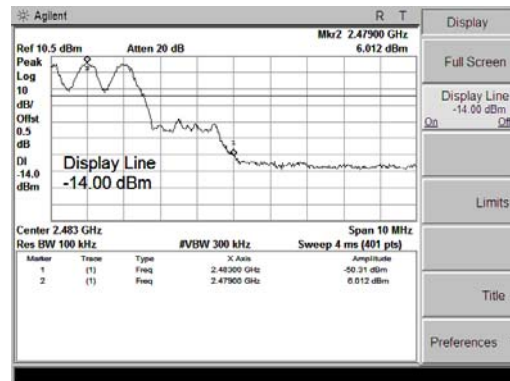

GFSK Mode, Hopping

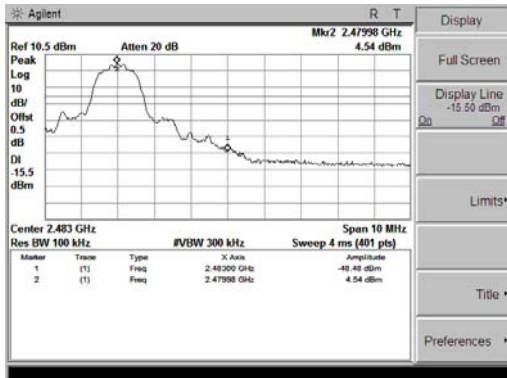

$\pi/4$ -DQPSK Mode, Non-Hopping

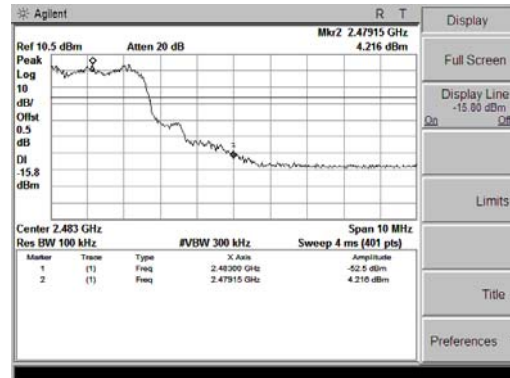

$\pi/4$ -DQPSK Mode, Hopping

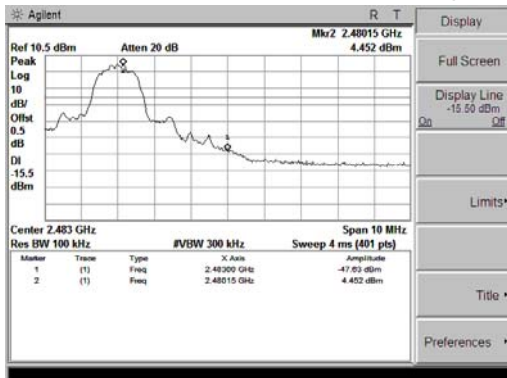

8DPSK Mode, Non-Hopping

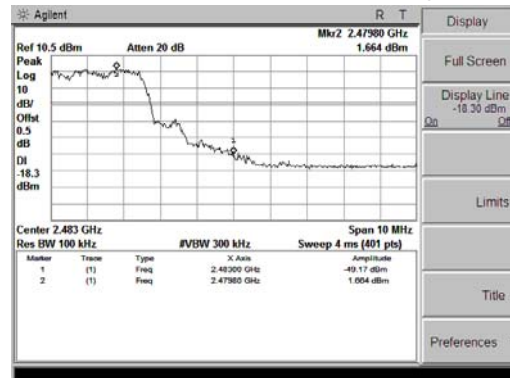

8DPSK Mode, Hopping

Conducted Spurious Emissions

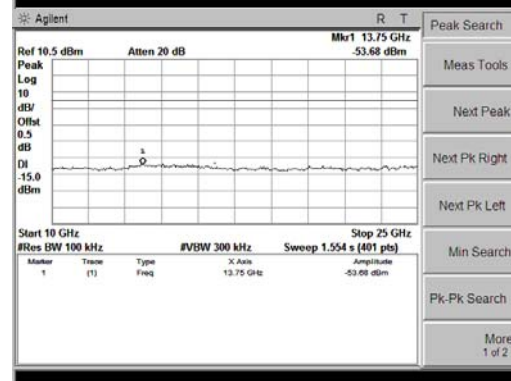
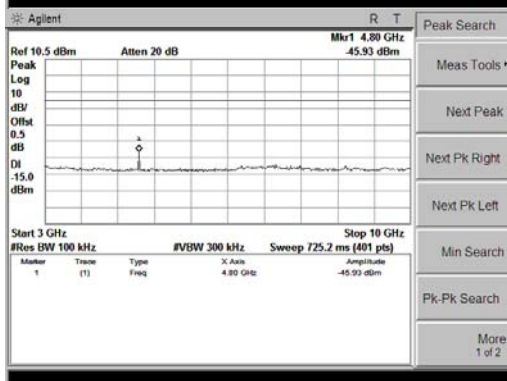
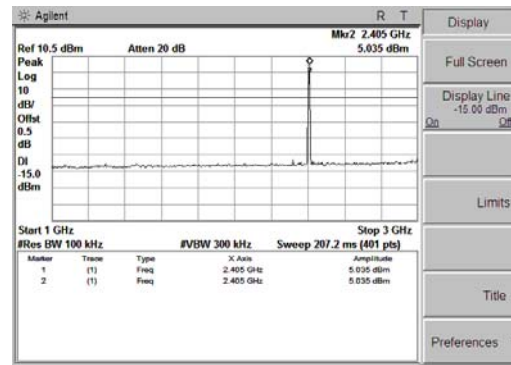
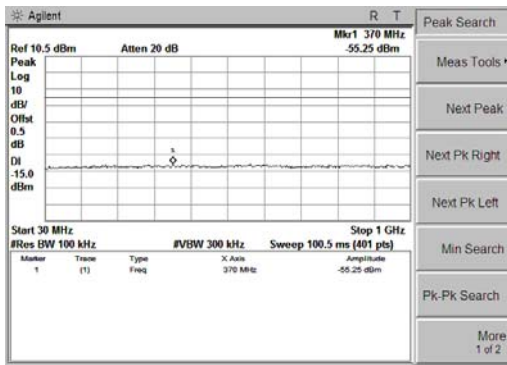

GFSK Mode, Ch0

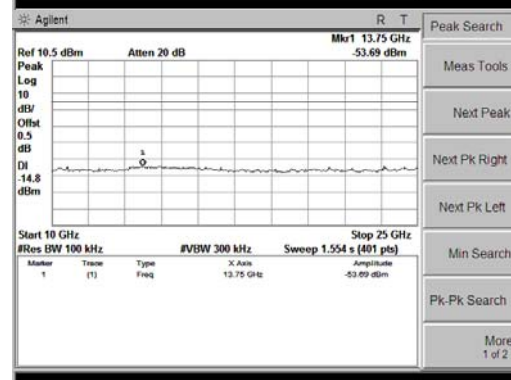
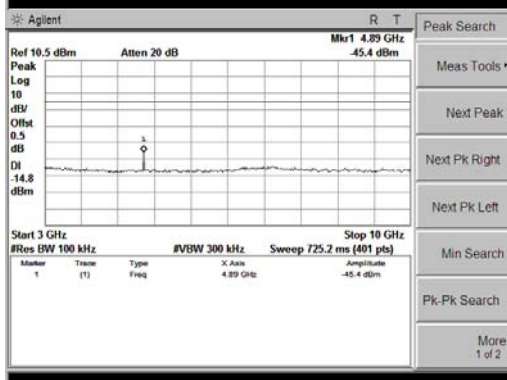
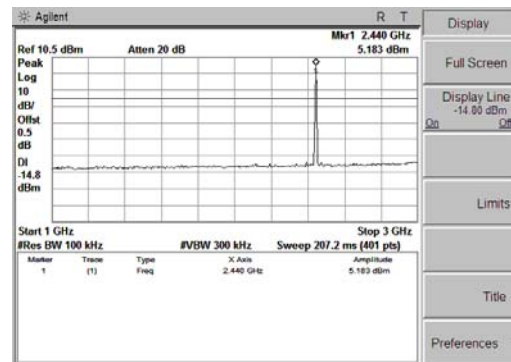
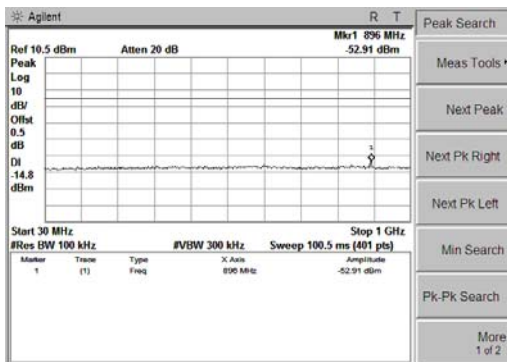

GFSK Mode, Ch39

Conducted Spurious Emissions

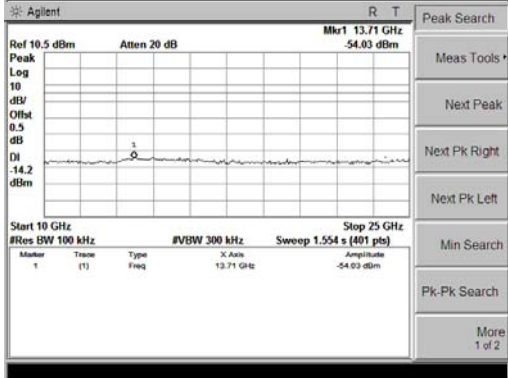
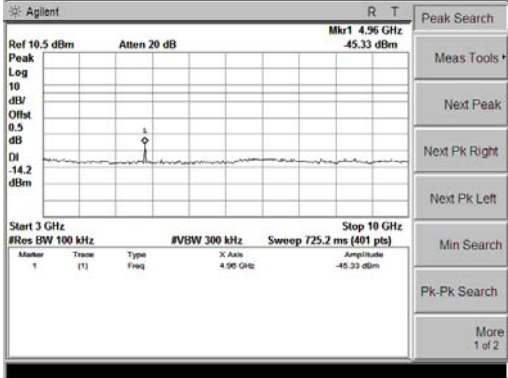
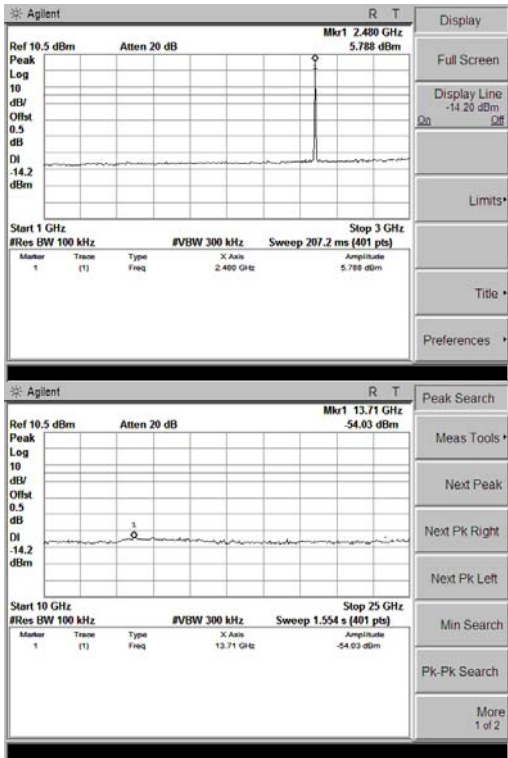
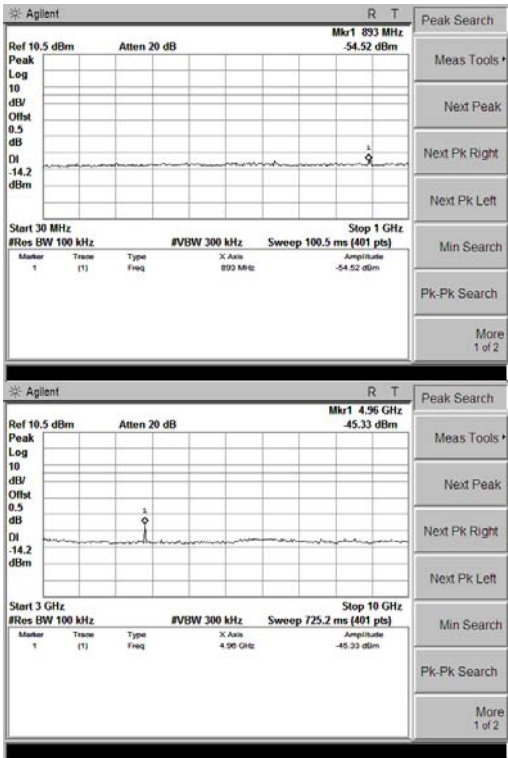

GFSK Mode, Ch78
 $\pi/4$ -DQPSK Mode, Hopping

5.10 Restricted Frequency Bands

5.10.1 Test Requirement

In any 100 kHz bandwidth outside the frequency band in which the spread spectrum or digitally modulated intentional radiator is operating, the radio frequency power that is produced by the intentional radiator shall be at least 20 dB below that in the 100 kHz bandwidth within the band that contains the highest level of the desired power. In addition, radiated emissions which fall in the restricted bands, as defined in §15.205(a), must also comply with the radiated emission limits specified in §15.209(a) (see §15.205(c)).

5.10.2 Test Configuration

Test Setup:

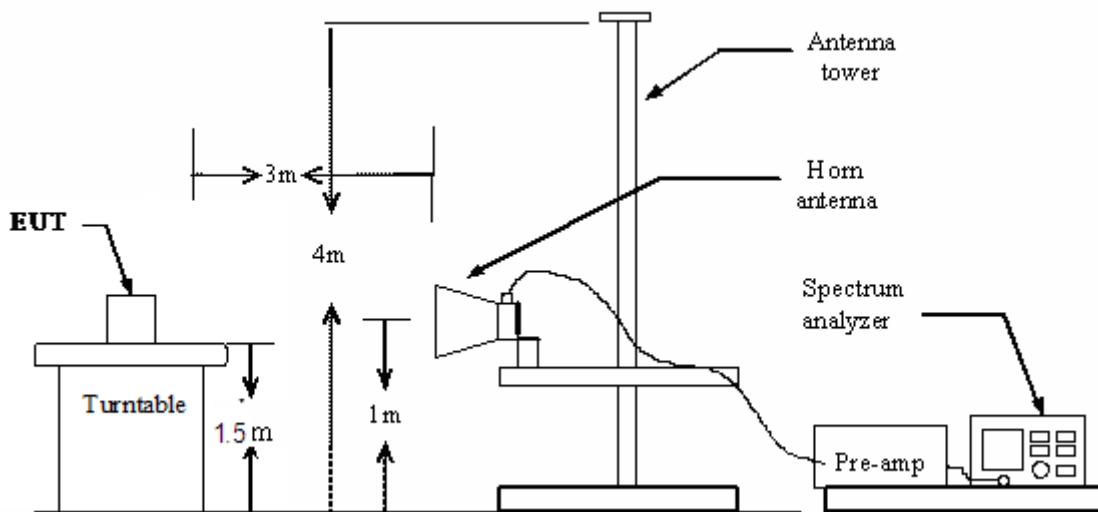

5.10.3 Test Procedure:

1. The EUT was placed on the top of a rotating table 1.5 meters above the ground at a 3 meter chamber. The table was rotated 360 degrees to determine the position of the highest radiation.
2. The EUT was set 3 meters away from the interference-receiving antenna, which was mounted on the top of a variable-height antenna tower.
3. The antenna height is varied from one meter to four meters above the ground to determine the maximum value of the field strength. Both horizontal and vertical polarizations of the antenna are set to make the measurement.
4. For each suspected emission, the EUT was arranged to its worst case and then the antenna was tuned to heights from 1 meter to 4 meters and the table was turned from 0 degrees to 360 degrees to find the maximum reading.

5.10.4 Test Result

Pass

Note: All test modes are performed, only the worst case is recorded in this report.

Please refer the following plots.

EUT:	TUMI Headphone	M/N:	TUAHP
Mode:	GFSK-CH0	Polarization:	Horizontal
Tested by:	Sunny(Engineer)	Power:	DC 3.7V by Battery
Temperature: / Humidity	24°C / 54%	Test date:	2016-12-08

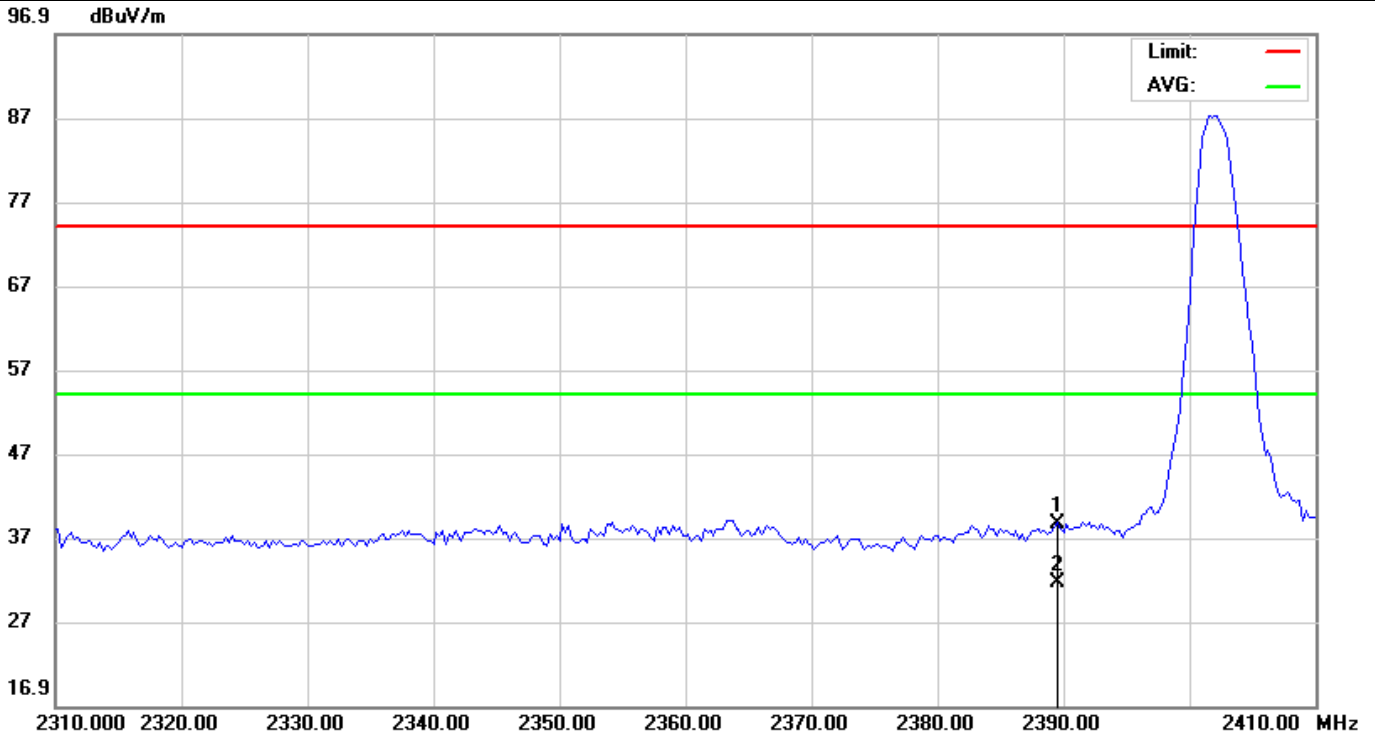

No.	Mk.	Freq. MHz	Reading Level dBuV	Correct Factor dB	Measure- ment dBuV/m	Limit dBuV/m	Over dB	Detector	Antenna Height cm	Table Degree degree	Comment
1		2389.500	47.01	-8.43	38.58	74.00	-35.42	peak			
2	*	2389.500	40.03	-8.43	31.60	54.00	-22.40	AVG			

*:Maximum data x:Over limit !:over margin

EUT:	TUMI Headphone	M/N:	TUAHP
Mode:	GFSK-CH0	Polarization:	Vertical
Tested by:	Sunny(Engineer)	Power:	DC 3.7V by Battery
Temperature: / Humidity	24°C / 54%	Test date:	2016-11-28

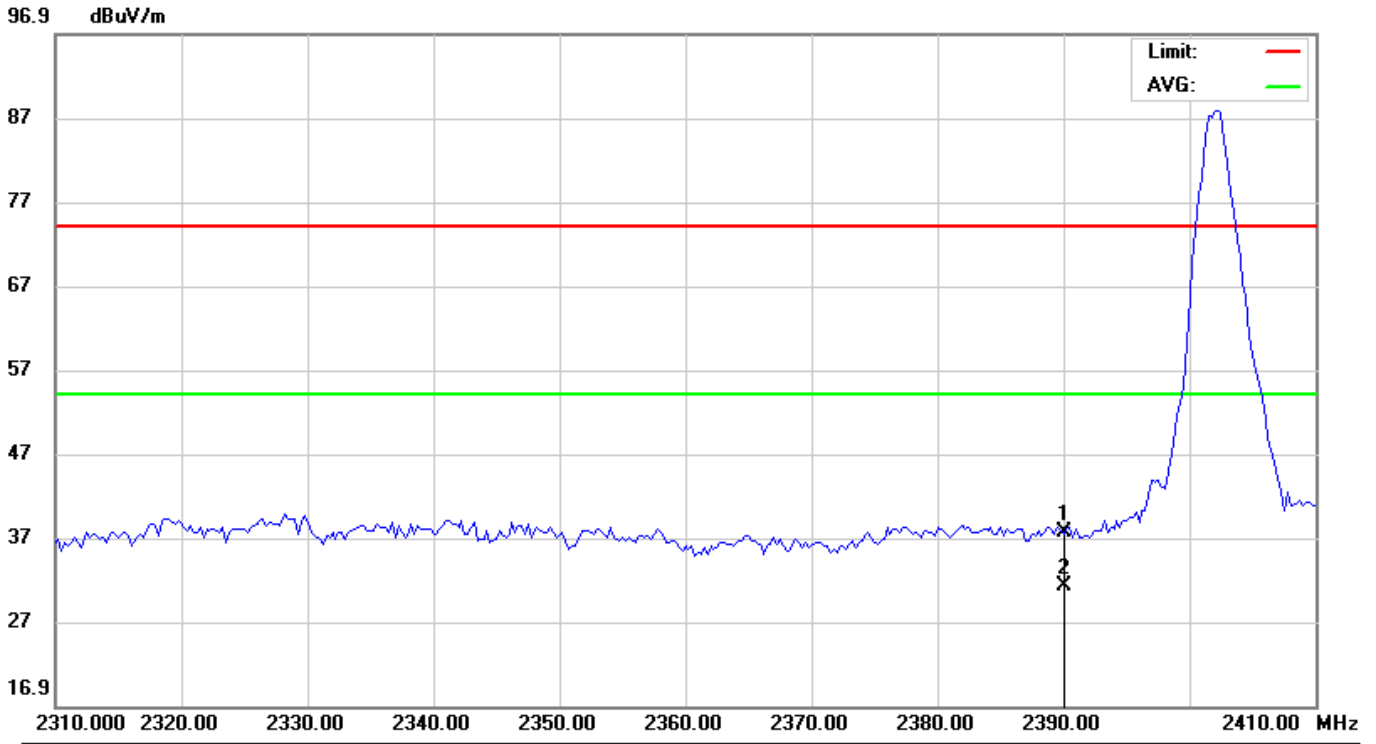

No.	Mk.	Freq.	Reading Level	Correct Factor	Measurement	Limit	Over	Antenna Height	Table Degree	
		MHz	dBuV	dB	dBuV/m	dBuV/m	dB	cm	degree	Comment
1		2390.000	46.01	-8.43	37.58	74.00	-36.42			peak
2	*	2390.000	39.58	-8.43	31.15	54.00	-22.85			AVG

*:Maximum data x:Over limit !:over margin

EUT:	TUMI Headphone	M/N:	TUAHP
Mode:	GFSK-CH78	Polarization:	Horizontal
Tested by:	Sunny(Engineer)	Power:	DC 3.7V by Battery
Temperature: / Humidity	24°C / 54%	Test date:	2016-12-08

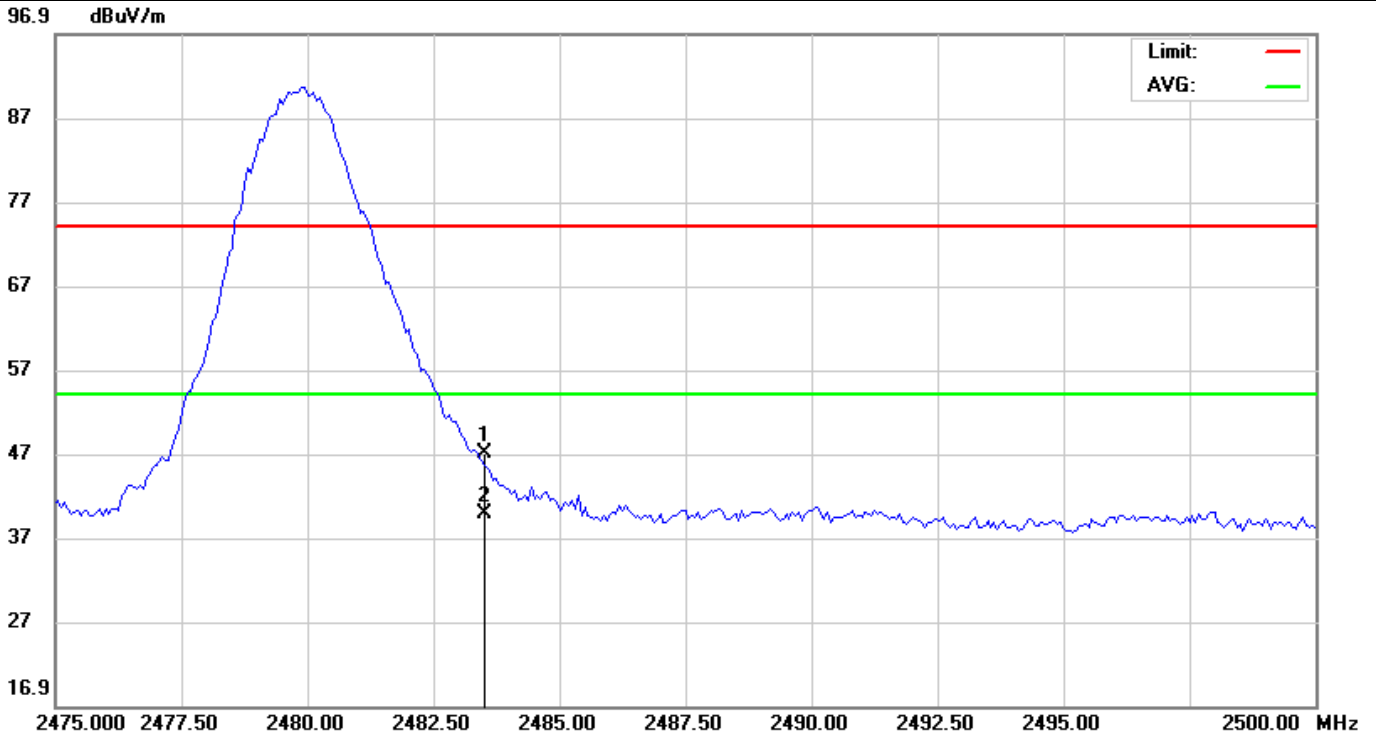

No.	Mk.	Freq.	Reading Level	Correct Factor	Measurement	Limit	Over	Antenna Height	Table Degree	
		MHz	dBuV	dB	dBuV/m	dBuV/m	dB	cm	degree	Comment
1		2483.500	55.23	-8.29	46.94	74.00	-27.06			peak
2	*	2483.500	48.01	-8.29	39.72	54.00	-14.28			AVG

*:Maximum data x:Over limit !:over margin

EUT:	TUMI Headphone	M/N:	TUAHP
Mode:	GFSK-CH78	Polarization:	Vertical
Tested by:	Sunny(Engineer)	Power:	DC 3.7V by Battery
Temperature: / Humidity	24°C/ 54%	Test date:	2016-12-08

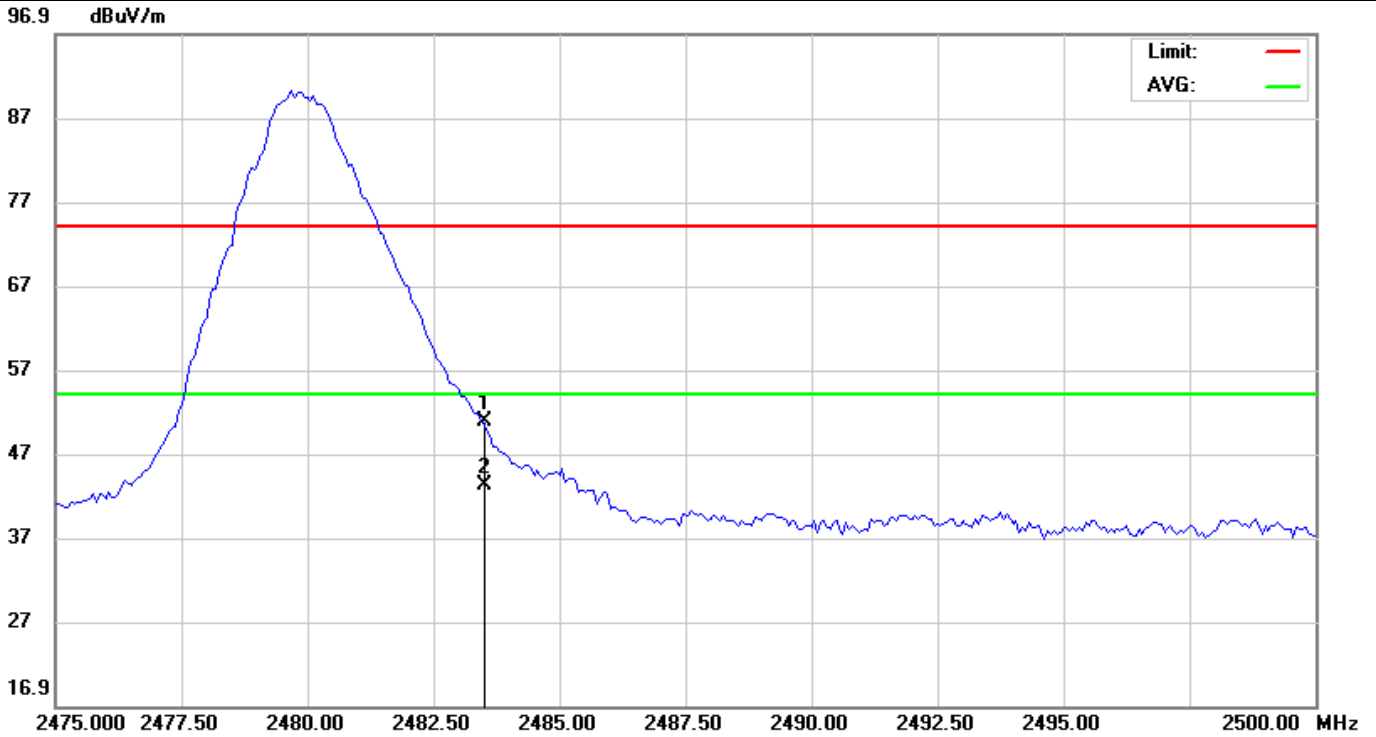

No.	Mk.	Freq. MHz	Reading Level dBuV	Correct Factor dB	Measure- ment dBuV/m	Limit dBuV/m	Over dB	Detector	Antenna Height cm	Table Degree degree	Comment
1		2483.500	59.01	-8.29	50.72	74.00	-23.28	peak			
2	*	2483.500	51.40	-8.29	43.11	54.00	-10.89	AVG			

*:Maximum data x:Over limit !:over margin

EUT:	TUMI Headphone	M/N:	TUAHP
Mode:	$\pi/4$ DQPSK-CH0	Polarization:	Horizontal
Tested by:	Sunny(Engineer)	Power:	DC 3.7V by Battery
Temperature: / Humidity	24°C / 54%	Test date:	2016-12-08

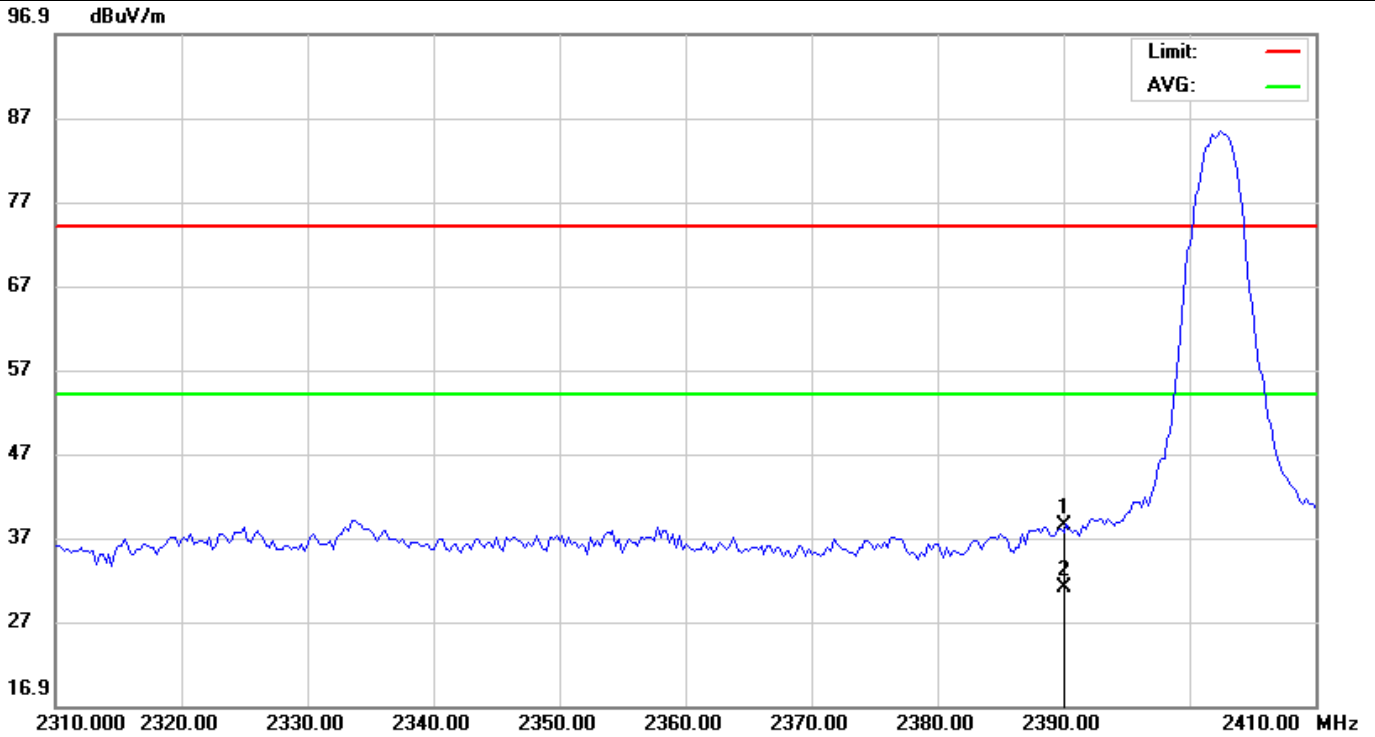

No.	Mk.	Freq. MHz	Reading Level dBuV	Correct Factor dB	Measure- ment dBuV/m	Limit dBuV/m	Over dB	Detector	Antenna Height cm	Table Degree degree	Comment
1		2390.000	46.80	-8.43	38.37	74.00	-35.63	peak			
2	*	2390.000	39.50	-8.43	31.07	54.00	-22.93	AVG			

*:Maximum data x:Over limit !:over margin

EUT:	TUMI Headphone	M/N:	TUAHP
Mode:	$\pi/4$ DQPSK-CH0	Polarization:	Vertical
Tested by:	Sunny(Engineer)	Power:	DC 3.7V by Battery
Temperature: / Humidity	24°C / 54%	Test date:	2016-12-08

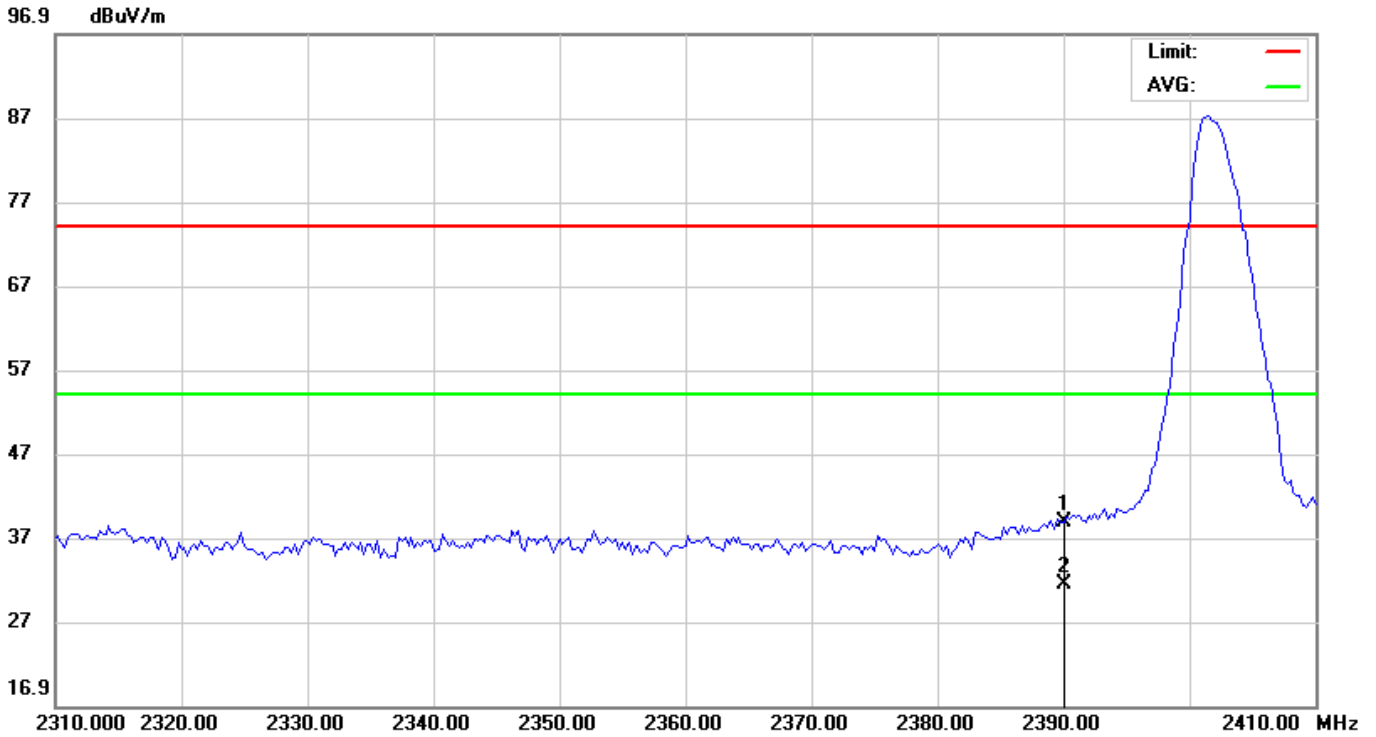

No.	Mk.	Freq. MHz	Reading Level dBuV	Correct Factor dB	Measure- ment dBuV/m	Limit dBuV/m	Over dB	Detector	Antenna Height cm	Table Degree degree	Comment
1		2390.000	47.30	-8.43	38.87	74.00	-35.13	peak			
2	*	2390.000	39.90	-8.43	31.47	54.00	-22.53	AVG			

*:Maximum data x:Over limit !:over margin

EUT:	TUMI Headphone	M/N:	TUAHP
Mode:	$\pi/4$ DQPSK-CH78	Polarization:	Horizontal
Tested by:	Sunny(Engineer)	Power:	DC 3.7V by Battery
Temperature: / Humidity	24°C/ 54%	Test date:	2016-12-08

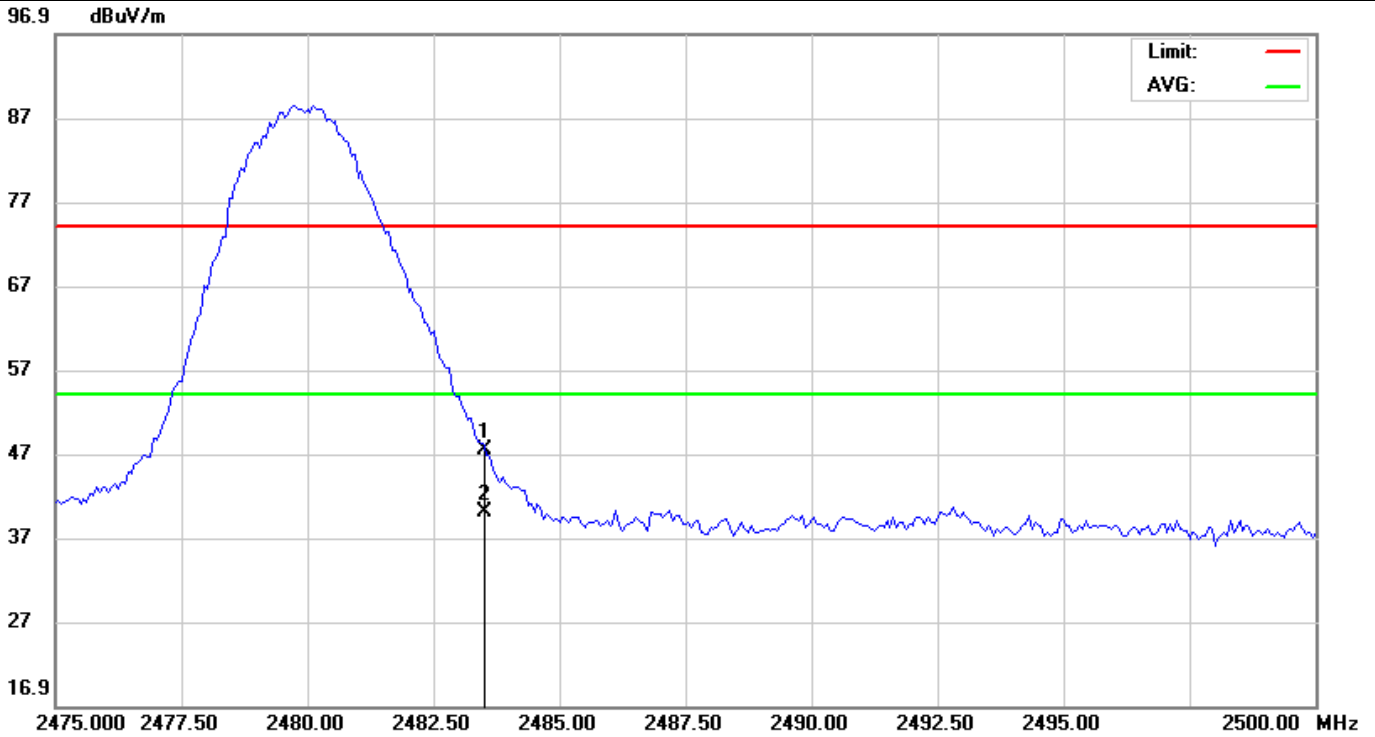

No.	Mk.	Freq. MHz	Reading Level dBuV	Correct Factor dB	Measure- ment dBuV/m	Limit dBuV/m	Over dB	Detector	Antenna Height cm	Table Degree degree	Comment
1		2483.500	55.70	-8.29	47.41	74.00	-26.59	peak			
2	*	2483.500	48.20	-8.29	39.91	54.00	-14.09	AVG			

*:Maximum data x:Over limit !:over margin

EUT:	TUMI Headphone	M/N:	TUAHP
Mode:	$\pi/4$ DQPSK -CH78	Polarization:	Vertical
Tested by:	Sunny(Engineer)	Power:	DC 3.7V by Battery
Temperature: / Humidity	24°C / 54%	Test date:	2016-12-08

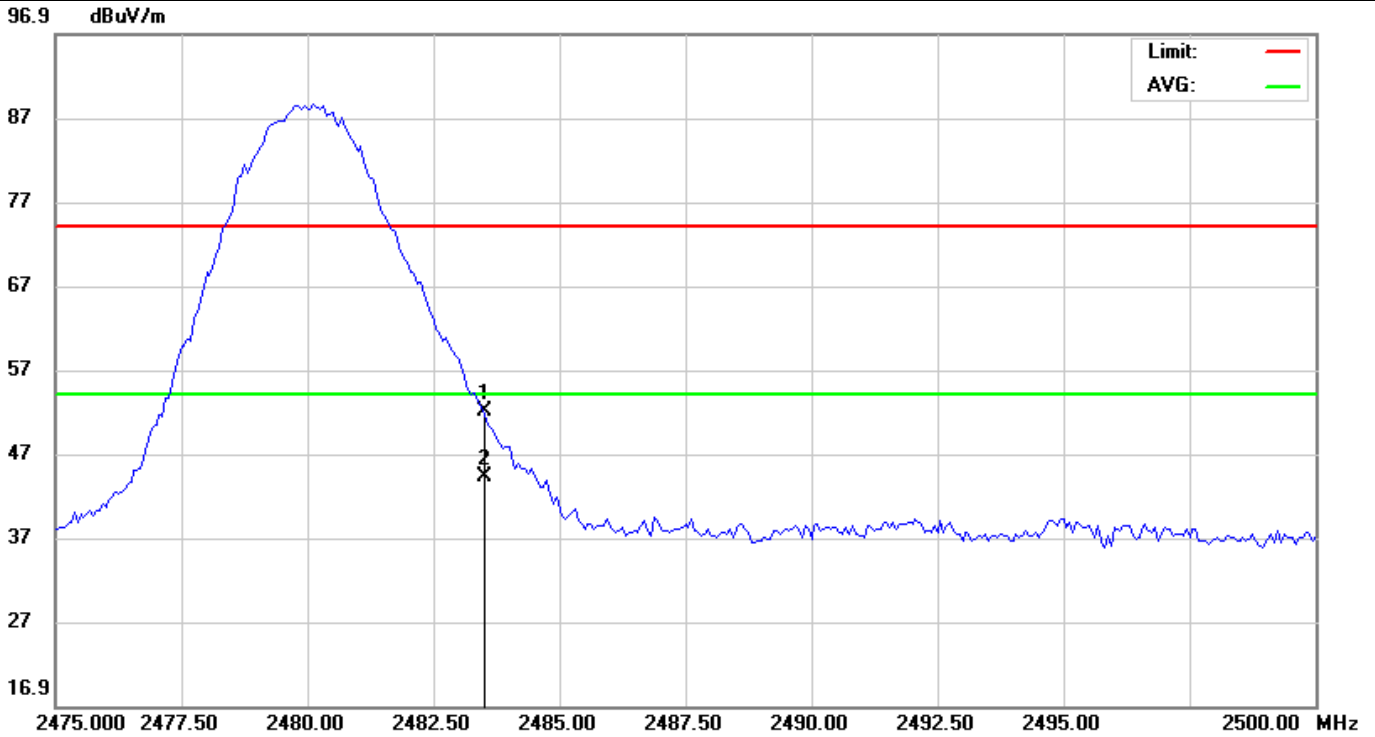

No.	Mk.	Freq. MHz	Reading Level dBuV	Correct Factor dB	Measure- ment dBuV/m	Limit dBuV/m	Over dB	Detector	Antenna Height cm	Table Degree degree	Comment
1		2483.500	60.20	-8.29	51.91	74.00	-22.09	peak			
2	*	2483.500	52.40	-8.29	44.11	54.00	-9.89	AVG			

*:Maximum data x:Over limit !:over margin

EUT:	TUMI Headphone	M/N:	TUAHP
Mode:	8DPSK-CH0	Polarization:	Horizontal
Tested by:	Sunny(Engineer)	Power:	DC 3.7V by Battery
Temperature: / Humidity	24°C / 54%	Test date:	2016-12-08

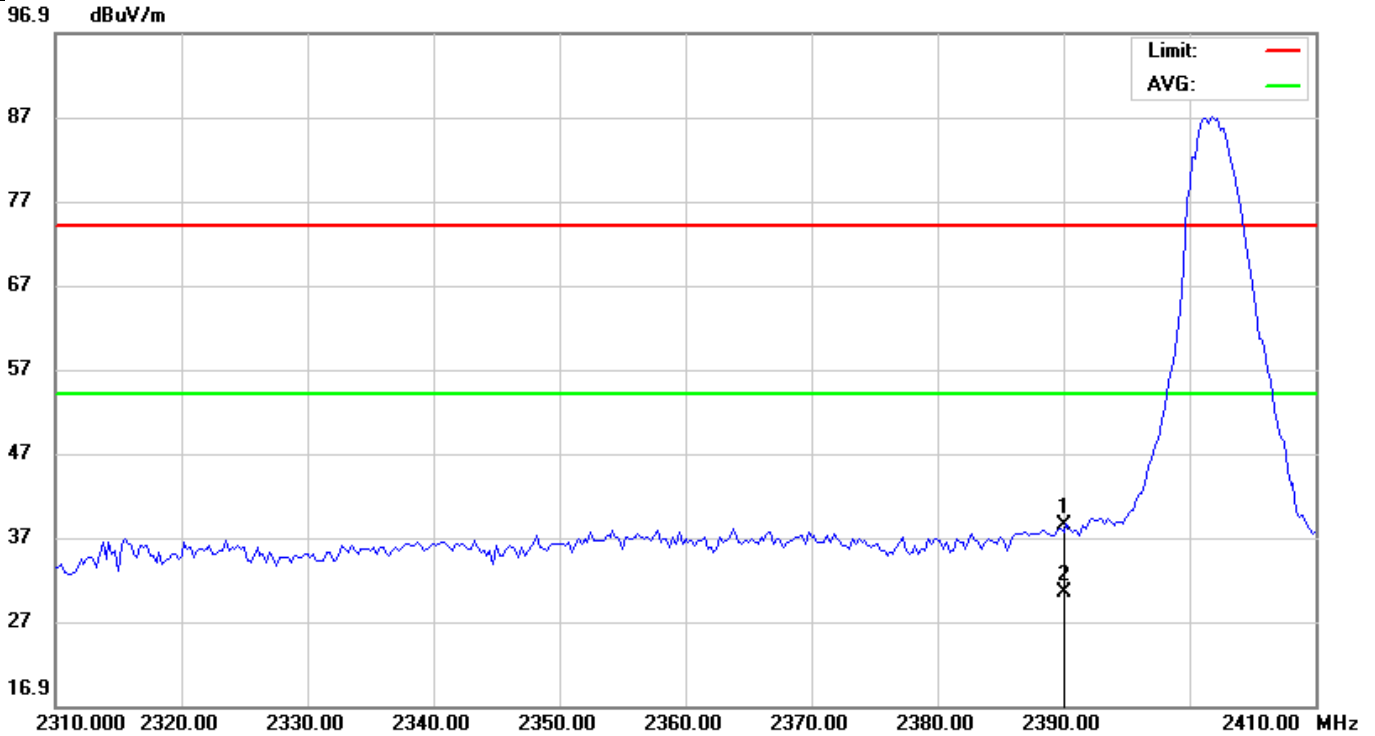

No.	Mk.	Freq.	Reading Level	Correct Factor	Measurement	Limit	Over	Antenna Height	Table Degree	
		MHz	dBuV	dB	dBuV/m	dBuV/m	dB	cm	degree	Comment
1		2390.000	46.80	-8.43	38.37	74.00	-35.63			peak
2	*	2390.000	38.90	-8.43	30.47	54.00	-23.53			AVG

*:Maximum data x:Over limit !:over margin

EUT:	TUMI Headphone	M/N:	TUAHP
Mode:	8DPSK-CH0	Polarization:	Vertical
Tested by:	Sunny(Engineer)	Power:	DC 3.7V by Battery
Temperature: / Humidity	24°C / 54%	Test date:	2016-12-08

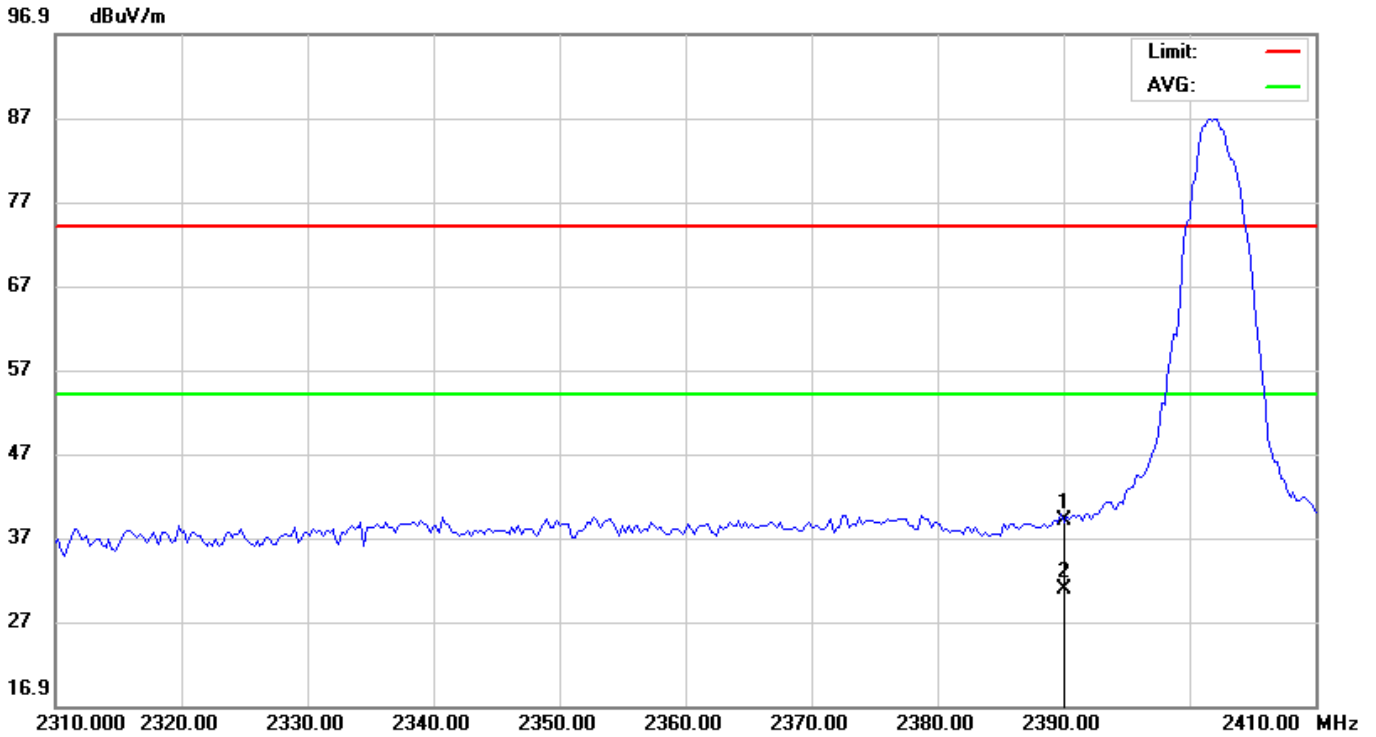

No.	Mk.	Freq. MHz	Reading Level dBuV	Correct Factor dB	Measure- ment dBuV/m	Limit dBuV/m	Over dB	Detector	Antenna Height cm	Table Degree degree	Comment
1		2390.000	47.50	-8.43	39.07	74.00	-34.93	peak			
2	*	2390.000	39.30	-8.43	30.87	54.00	-23.13	AVG			

*:Maximum data x:Over limit !:over margin

EUT:	TUMI Headphone	M/N:	TUAHP
Mode:	8DPSK-CH78	Polarization:	Horizontal
Tested by:	Sunny(Engineer)	Power:	DC 3.7V by Battery
Temperature: / Humidity	24°C / 54%	Test date:	2016-12-08

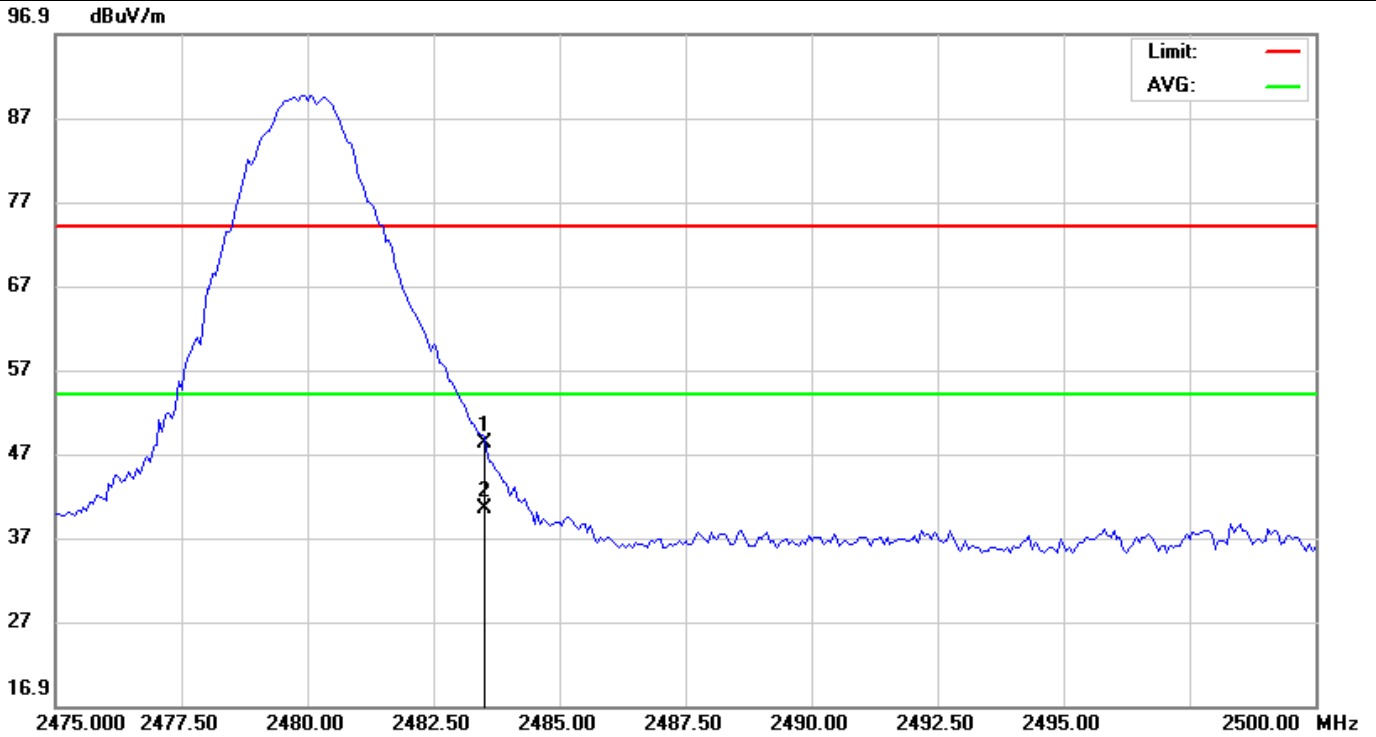

No.	Mk.	Freq.	Reading Level	Correct Factor	Measurement	Limit	Over	Antenna Height	Table Degree	
		MHz	dBuV	dB	dBuV/m	dBuV/m	dB	cm	degree	Comment
1		2483.500	56.40	-8.29	48.11	74.00	-25.89			peak
2	*	2483.500	48.70	-8.29	40.41	54.00	-13.59			AVG

*:Maximum data x:Over limit !:over margin

EUT:	TUMI Headphone	M/N:	TUAHP
Mode:	8DPSK-CH78	Polarization:	Vertical
Tested by:	Sunny(Engineer)	Power:	DC 3.7V by Battery
Temperature: / Humidity	24°C/ 54%	Test date:	2016-12-08

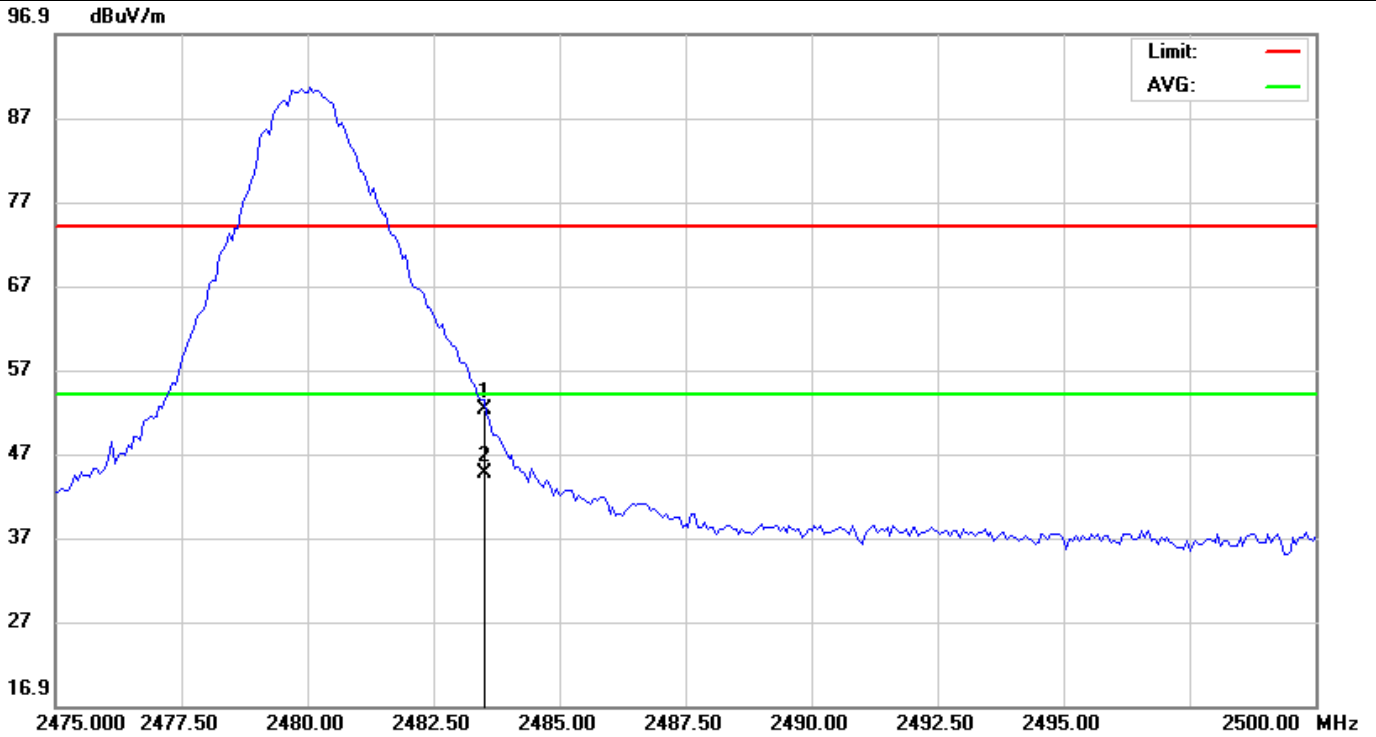

No.	Mk.	Freq.	Reading Level	Correct Factor	Measurement	Limit	Over	Antenna Height	Table Degree	
		MHz	dBuV	dB	dBuV/m	dBuV/m	dB	cm	degree	Comment
1		2483.500	60.40	-8.29	52.11	74.00	-21.89	peak		
2	*	2483.500	52.90	-8.29	44.61	54.00	-9.39	AVG		

*:Maximum data x:Over limit !:over margin

End of the Report