

**ELECTROMAGNETIC EMISSIONS COMPLIANCE REPORT  
INTENTIONAL RADIATOR CERTIFICATION TO  
FCC PART 15 SUBPART C REQUIREMENT**

*OF*

**Thermal Receipt Printer**

**Model No.: DT-210, DT-230**

**FCC ID: Z7OTD2100**

Trademark:   

**Report No.: KAD141121077E**

**Issue Date: January 19, 2015**

*Prepared for*

**Jiangmen Dascom Computer Peripherals Co., Ltd.  
No.399, Jin Xing Road, Jiang Hai District, Jiangmen City, Guang Dong  
Province, P.R. China**

*Prepared by*

**DONGGUAN EMTEK CO., LTD.  
No.281, Guantai Road, Nancheng District,  
Dongguan, Guangdong, China  
TEL: 86-769-22807078  
FAX: 86-769-22807079**

**This report shall not be reproduced, except in full, without the written approval of  
DONGGUAN EMTEK CO., LTD.**

## VERIFICATION OF COMPLIANCE

Applicant:	Jiangmen Dascom Computer Peripherals Co., Ltd. No.399, Jin Xing Road, Jiang Hai District, Jiangmen City, Guang Dong Province, P.R. China
Manufacturer:	Jiangmen Dascom Computer Peripherals Co., Ltd. No.399, Jin Xing Road, Jiang Hai District, Jiangmen City, Guang Dong Province, P.R. China
Product Description:	Thermal Receipt Printer
Model Number:	DT-210, DT-230
Trade Mark:	
Date of Test:	November 21, 2014 to January 08, 2015

### We hereby certify that:

The above equipment was tested by DONGGUAN EMTEK CO., LTD. The test data, data evaluation, test procedures, and equipment configurations shown in this report were made in accordance with the procedures given in ANSI C63.4 (2014) and the energy emitted by the sample EUT tested as described in this report is in compliance with conducted and radiated emission limits of FCC Rules Part 15.247(2014).

**Approved By**



---

**Sam Lv / Q.A. Manager  
DONGGUAN EMTEK CO., LTD.**

## Modified Information

Version	Summary	Revision Date	Report No.
Ver.1.0	Original Report	/	KAD141121077E

## Table of Contents

<b>1. GENERAL INFORMATION .....</b>	<b>6</b>
1.1 PRODUCT DESCRIPTION .....	6
1.2 RELATED SUBMITTAL(S) / GRANT(S) .....	6
1.3 TEST METHODOLOGY .....	7
1.4 SPECIAL ACCESSORIES.....	7
1.5 EQUIPMENT MODIFICATIONS.....	7
1.6 TEST FACILITY.....	7
<b>2. SYSTEM TEST CONFIGURATION .....</b>	<b>8</b>
2.1 EUT CONFIGURATION.....	8
2.2 EUT EXERCISE .....	8
2.3 TEST PROCEDURE.....	8
2.4 CONFIGURATION OF TESTED SYSTEM .....	8
<b>3. DESCRIPTION OF TEST MODES.....</b>	<b>9</b>
<b>4. SUMMARY OF TEST RESULTS.....</b>	<b>10</b>
<b>5. CONDUCTED EMISSIONS TEST .....</b>	<b>11</b>
5.1 MEASUREMENT PROCEDURE .....	11
5.2 TEST SET-UP (BLOCK DIAGRAM OF CONFIGURATION) .....	11
5.3 MEASUREMENT EQUIPMENT USED .....	11
5.4 CONDUCTED EMISSION LIMIT .....	11
5.5 MEASUREMENT RESULT.....	12
<b>6. RADIATED EMISSION TEST.....</b>	<b>14</b>
6.1 MEASUREMENT PROCEDURE .....	14
6.2 TEST SET-UP (BLOCK DIAGRAM OF CONFIGURATION) .....	15
6.3 MEASUREMENT EQUIPMENT USED .....	16
6.4 RADIATED EMISSION LIMIT .....	16
6.5 MEASUREMENT RESULT.....	18
<b>7. 6DB BANDWIDTH TEST .....</b>	<b>27</b>
7.1 MEASUREMENT PROCEDURE .....	27
7.2 TEST SET-UP (BLOCK DIAGRAM OF CONFIGURATION) .....	27
7.3 MEASUREMENT EQUIPMENT USED .....	27
7.4 MEASUREMENT RESULTS.....	27
<b>8. MAXIMUM PEAK OUTPUT POWER TEST .....</b>	<b>36</b>
8.1 MEASUREMENT PROCEDURE .....	36
8.2 TEST SET-UP (BLOCK DIAGRAM OF CONFIGURATION) .....	36
8.3 MEASUREMENT EQUIPMENT USED .....	36
8.4 PEAK POWER OUTPUT LIMIT .....	36
8.5 MEASUREMENT RESULTS.....	36
<b>9. BAND EDGE TEST .....</b>	<b>37</b>
9.1 MEASUREMENT PROCEDURE .....	37
9.2 TEST SET-UP (BLOCK DIAGRAM OF CONFIGURATION) .....	38
9.3 MEASUREMENT EQUIPMENT USED .....	38
9.4 MEASUREMENT RESULTS.....	38
<b>10. POWER DENSITY.....</b>	<b>51</b>
10.1 TEST EQUIPMENT .....	51
10.2 MEASURING INSTRUMENTS AND SETTING.....	51
10.3 TEST PROCEDURES.....	51

10.4	BLOCK DIAGRAM OF TEST SETUP .....	51
10.5	LIMIT.....	51
10.6	TEST RESULT .....	52
<b>11.</b>	<b>ANTENNA PORT EMISSION.....</b>	<b>60</b>
11.1	TEST EQUIPMENT .....	60
11.2	MEASURING INSTRUMENTS AND SETTING.....	60
11.3	TEST PROCEDURES.....	60
11.4	BLOCK DIAGRAM OF TEST SETUP .....	60
11.5	TEST RESULT .....	60
<b>12.</b>	<b>ANTENNA APPLICATION .....</b>	<b>67</b>
12.1	ANTENNA REQUIREMENT .....	67
12.2	RESULT.....	67

Appendix I (Photos of EUT)(6 Pages)

## 1. General Information

### 1.1 Product Description

A major technical descriptions of EUT is described as following:

- A). Operation Frequency: 2412-2462MHz for 802.11b/g/n(H20) ;  
2422-2452MHz for 802.11n(H40)
- B). Modulation: OFDM with BPSK/QPSK/16QAM/64QAM for 802.11g/n,  
DSSS with DBPSK/DQPSK/CCK for 802.11b;
- C). Number of Channel: 11 Channels for 802.11b/g/n(H20)  
7 Channels for 802.11n(H40)
- D). Antenna Type: Internal PCB Antenna
- E). Antenna Gain: 2.18dBi
- F). Power Supply for Adapter:  
Model: TM-K072V-2403000PD  
Input: AC 100-240V, 50/60Hz, 1.8A  
Output: DC 24V, 3000mA, 72W

### 1.2 Related Submittal(s) / Grant(s)

This submittal(s) (test report) is intended for filing to comply with Section 15.247 of the FCC Part 15, Subpart C Rules. The composite system is compliance with Subpart B is authorized under a DOC procedure.

### 1.3 Test Methodology

All the test program has follow FCC new test procedure KDB558074 D01 v03r02, Both conducted and radiated testing was performed according to the procedures in ANSI C63.4 (2014). Radiated testing was performed at an antenna to EUT distance 3 meters.

### 1.4 Special Accessories

Not available for this EUT intended for grant.

### 1.5 Equipment Modifications

Not available for this EUT intended for grant.

### 1.6 Test Facility

#### Site Description

EMC Lab : Accredited by FCC, June 18, 2014  
The Certificate Number is 247565

Accredited by Industry Canada, February 19, 2014  
The Certificate Number is 9444A

Name of Firm : DONGGUAN EMTEK CO., LTD.  
Site Location : No.281, Guantai Road, Nancheng District,  
Dongguan, Guangdong, China

## 2. System Test Configuration

### 2.1 EUT Configuration

The EUT configuration for testing is installed on RF field strength measurement to meet the Commissions requirement and operating in a manner which intends to maximize its emission characteristics in a continuous normal application.

### 2.2 EUT Exercise

The Transmitter was operated in the normal operating mode. The TX frequency was fixed which was for the purpose of the measurements.

### 2.3 Test Procedure

#### 2.3.1 Conducted Emissions

The EUT is a placed on as turn table which is 0.8 m above ground plane. According to the requirements in Section 13.1.4.1 of ANSI C63.4-2014 Conducted emissions from the EUT measured in the frequency range between 0.15 MHz and 30 MHz using CISPR Quasi-Peak and average detector mode.

#### 2.3.2 Radiated Emissions

The EUT is a placed on as turn table which is 0.8 m above ground plane. The turn table shall rotate 360 degrees to determine the position of maximum emission level. EUT is set 3m away from the receiving antenna which varied from 1m to 4m to find out the highest emission. And also, each emission was to be maximized by changing the polarization of receiving antenna both horizontal and vertical. In order to find out the max. Emission, the relative positions of this hand-held transmitter (EUT) was rotated through three orthogonal axes according to the requirements in Section 13.1.4.1 of ANSI C63.4-2014.

### 2.4 Configuration of Tested System

**Fig. 2-1 Configuration of Tested System**

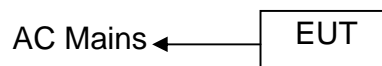

**Table 2-1 Equipment Used in Tested System**

Item	Equipment	Trademark	Model No.	FCC ID	Note
1.	Thermal Receipt Printer	<b>Tally</b> <b>DASCOM</b>	DT-210	Z7OTD2100	EUT

**Note:**

- (1) Unless otherwise denoted as EUT in 『Remark』 column, device(s) used in tested system is a support equipment.



### 3. Description of Test Modes

The EUT configuration for testing is installed on RF field strength measurement to meet the Commissions requirement and operating in a manner which intends to maximize its emission characteristics in a continuous normal application.

The Transmitter was operated in the normal operating mode. The TX frequency was fixed which was for the purpose of the measurements.

Test of channel included the lowest and middle and highest frequency to perform the test, then record on this report.

Those data rates (802.11b: 1 Mbps; 802.11g: 6 Mbps; 802.11n (HT20) : MCS0; 802.11n (HT40) : MCS8) were used for all test.

Pre-defined engineering program for regulatory testing used to control the EUT for staying in continuous transmitting and receiving mode is programmed.

Frequency and Channel list for 802.11 b/g/n (HT20):

Channel	Frequency (MHz)	Channel	Frequency (MHz)	Channel	Frequency (MHz)
1	2412	5	2432	9	2452
2	2417	6	2437	10	2457
3	2422	7	2442	11	2462
4	2427	8	2447		

Frequency and Channel list for 802.11 n (HT40):

Channel	Frequency (MHz)	Channel	Frequency (MHz)	Channel	Frequency (MHz)
3	2422	5	2432	8	2447
4	2427	6	2437	9	2452
		7	2442		

Test Frequency and Channel for 802.11 b/g/n (HT20):

Lowest Frequency		Middle Frequency		Highest Frequency	
Channel	Frequency (MHz)	Channel	Frequency (MHz)	Channel	Frequency (MHz)
1	2412	6	2437	11	2462

Test Frequency and channel for 802.11 n (HT40):

Lowest Frequency		Middle Frequency		Highest Frequency	
Channel	Frequency (MHz)	Channel	Frequency (MHz)	Channel	Frequency (MHz)
3	2422	6	2437	9	2452

#### 4. Summary of Test Results

<b>FCC Rules</b>	<b>Description Of Test</b>	<b>Result</b>
§15.247(a)(2)	6dB bandwidth	Pass
§15.247(b)(3)	Max Peak output Power test	Pass
§15.247(e)	Power density	Pass
§15.247(d)	Band edge test	Pass
§15.207	AC Power Conducted Emission	Pass
§15.247(d), §15.209	Radiated Emission	Pass
§15.247(d)	Antenna Port Emission	Pass
§15.247(b)&§15.203	Antenna Application	Pass

## 5. Conducted Emissions Test

### 5.1 Measurement Procedure

1. The EUT was placed on a table which is 0.8m above ground plane.
2. Maximum procedure was performed on the six highest emissions to ensure EUT compliance.
3. Repeat above procedures until all frequency measured were complete.

### 5.2 Test SET-UP (Block Diagram of Configuration)

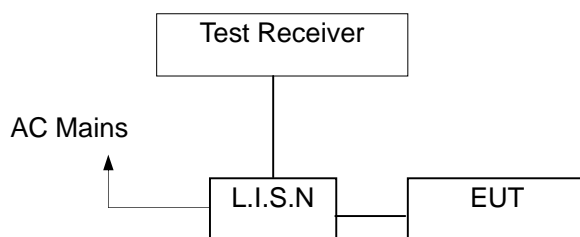

### 5.3 Measurement Equipment Used

Item	Equipment	Manufacturer	Model No.	Serial No.	Last Cal.	Cal. Interval
1.	Test Receiver	Rohde&Schwarz	ESCS30	100018	May 16, 2014	1 Year
2.	L.I.S.N.	Rohde&Schwarz	ENV216	100017	May 16, 2014	1Year
3.	RF Switching Unit	CDS	RSU-M2	38401	May 16, 2014	1Year

### 5.4 Conducted Emission Limit

Conducted Emission Frequency(MHz)	Quasi-peak	Average
0.15-0.5	66-56	56-46
0.5-5.0	56	46
5.0-30.0	60	50

- Note:** 1. The lower limit shall apply at the transition frequencies  
 2. The limit decreases in line with the logarithm of the frequency in the range of 0.15 to 0.50MHz.

### 5.5 Measurement Result

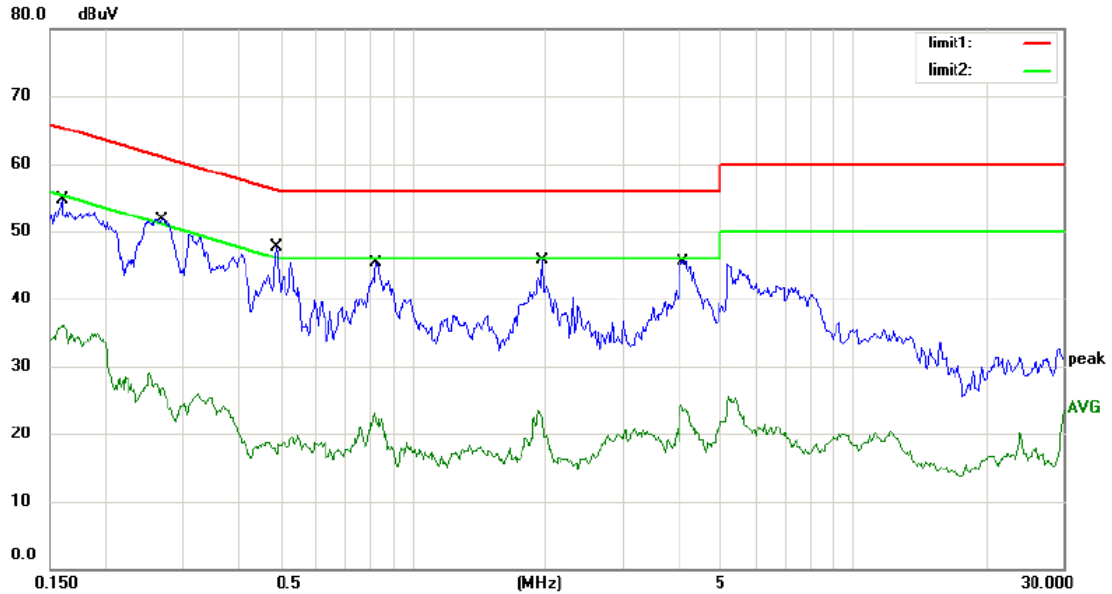

Site Chamber #1 Phase: **L1** Temperature 24  
 Limit: (CE)FCC PART 15 class B\_QP Power: AC 120V/60Hz Humidity: 55 %  
 Mode: TX  
 Note:

No.	Mk.	Freq.	Reading Level	Correct Factor	Measurement	Limit	Over	Detector	Comment
		MHz	dBuV	dB	dBuV	dBuV	dB		
1		0.1600	54.62	0.00	54.62	65.46	-10.84	QP	
2		0.1600	36.11	0.00	36.11	55.46	-19.35	AVG	
3		0.2700	51.73	0.00	51.73	61.12	-9.39	QP	
4		0.2700	27.34	0.00	27.34	51.12	-23.78	AVG	
5	*	0.4900	47.66	0.00	47.66	56.17	-8.51	QP	
6		0.4900	18.43	0.00	18.43	46.17	-27.74	AVG	
7		0.8300	45.24	0.00	45.24	56.00	-10.76	QP	
8		0.8300	22.37	0.00	22.37	46.00	-23.63	AVG	
9		1.9800	45.61	0.00	45.61	56.00	-10.39	QP	
10		1.9800	23.51	0.00	23.51	46.00	-22.49	AVG	
11		4.1135	45.51	0.00	45.51	56.00	-10.49	QP	
12		4.1135	24.28	0.00	24.28	46.00	-21.72	AVG	

\*:Maximum data x:Over limit !:over margin Comment: Factor build in receiver. Operator: QIU

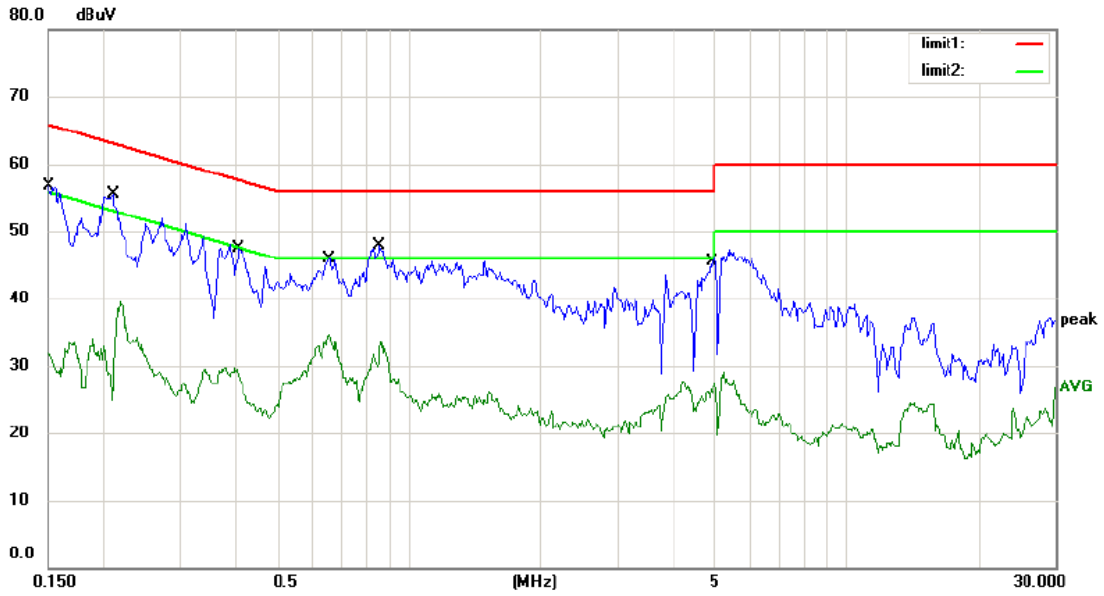

Site Chamber #1

Phase: N

Temperature 24

Limit: (CE)FCC PART 15 class B\_QP

Power: AC 120V/60Hz

Humidity: 55 %

Mode: TX

Note:

No.	Mk.	Freq. MHz	Reading Level dBuV	Correct Factor dB	Measure- ment dBuV	Limit dBuV	Over dB	Detector	Comment
1		0.1500	56.61	0.00	56.61	66.00	-9.39	QP	
2		0.1500	31.94	0.00	31.94	56.00	-24.06	AVG	
3	*	0.2106	55.60	0.00	55.60	63.18	-7.58	QP	
4		0.2106	39.43	0.00	39.43	53.18	-13.75	AVG	
5		0.4100	47.43	0.00	47.43	57.65	-10.22	QP	
6		0.4100	29.76	0.00	29.76	47.65	-17.89	AVG	
7		0.6600	45.95	0.00	45.95	56.00	-10.05	QP	
8		0.6600	34.80	0.00	34.80	46.00	-11.20	AVG	
9		0.8600	47.93	0.00	47.93	56.00	-8.07	QP	
10		0.8600	33.66	0.00	33.66	46.00	-12.34	AVG	
11		4.9256	45.51	0.00	45.51	56.00	-10.49	QP	
12		4.9256	27.54	0.00	27.54	46.00	-18.46	AVG	

\*:Maximum data x:Over limit !:over margin Comment: Factor build in receiver. Operator: QIU

## 6. Radiated Emission Test

### 6.1 Measurement Procedure

1. The EUT was placed on a turn table which is 0.8m above ground plane.
2. Maximum procedure was performed on the six highest emissions to ensure EUT compliance.
3. And also, each emission was to be maximized by changing the polarization of receiving antenna both horizontal and vertical.
4. Repeat above procedures until all frequency measured was complete.

When spectrum scanned from 30MHz to 1GHz setting resolution bandwidth 120KHz and video bandwidth 300KHz:

EMI Test Receiver	Setting
Attenuation	Auto
RB	120KHz
VB	300KHz
Detector	QP
Trace	Max hold

When spectrum scanned above 1GHz setting resolution bandwidth 1MHz, video bandwidth 3MHz:

EMI Test Receiver	Setting
Attenuation	Auto
RB	1MHz
VB	3MHz
Detector	Peak
Trace	Max hold

When spectrum scanned above 1GHz setting resolution bandwidth 1MHz, video bandwidth 10Hz:

EMI Test Receiver	Setting
Attenuation	Auto
RB	1MHz
VB	10Hz
Detector	Peak
Trace	Max hold

## 6.2 Test SET-UP (Block Diagram of Configuration)

### (A) Radiated Emission Test Set-Up, Frequency Below 30MHz

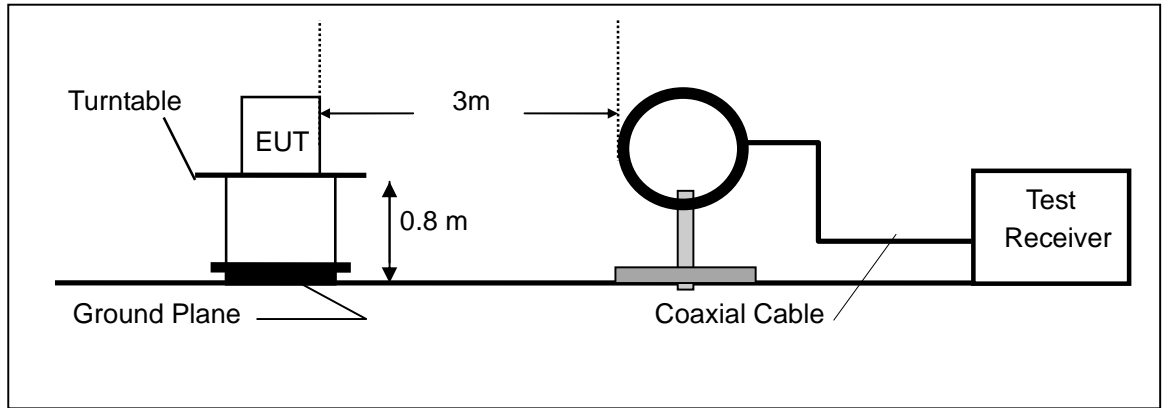

### (B) Radiated Emission Test Set-Up, Frequency Below 1000MHz

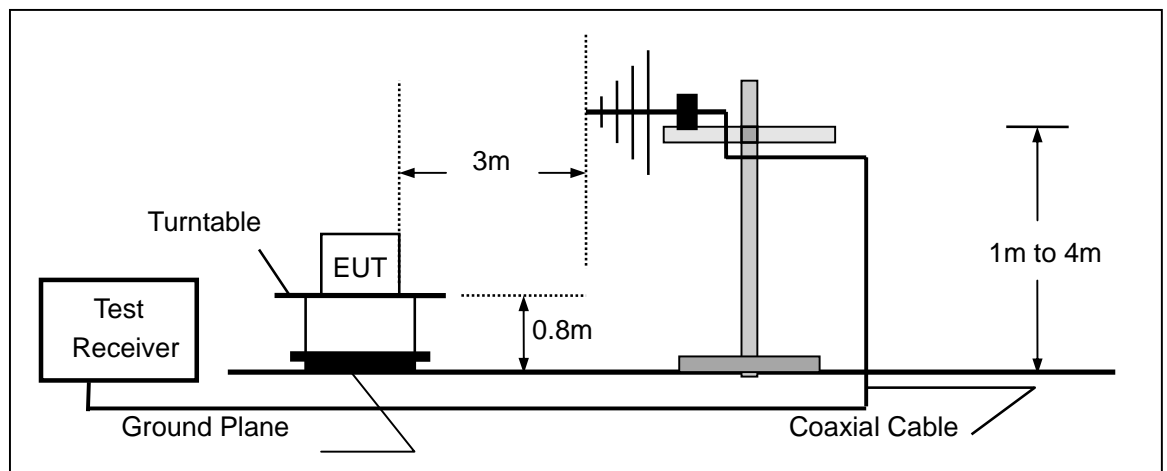

(C) Radiated Emission Test Set-Up, Frequency above 1000MHz

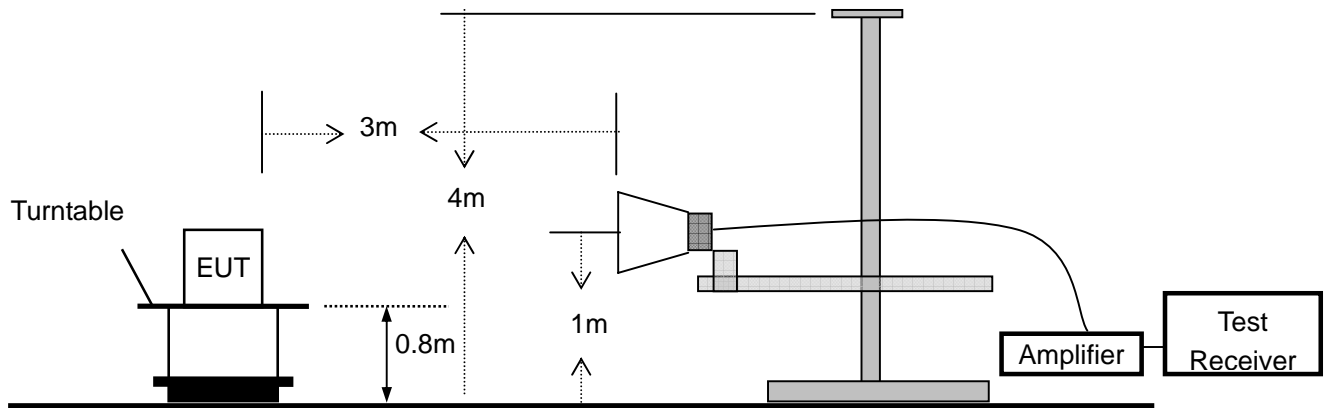

6.3 Measurement Equipment Used

EQUIPMENT TYPE	MFR	MODEL NUMBER	SERIAL NUMBER	LAST CAL.	CAL DUE.
Spectrum Analyzer	Rohde & Schwarz	FSV30	1321.3008K	05/16/2014	05/15/2015
Spectrum Analyzer	HP	E4407B	839840481	05/16/2014	05/15/2015
EMI Test Receiver	Rohde & Schwarz	ESU	1302.6005.26	05/16/2014	05/15/2015
Pre-Amplifier	HP	8447D	2944A07999	05/16/2014	05/15/2015
Bilog Antenna	Schwarzbeck	VULB9163	142	05/19/2014	05/18/2015
Loop Antenna	Schwarzbeck	FMZB 1519	012	05/19/2014	05/18/2015
Horn Antenna	Schwarzbeck	BBHA 9170	BBHA9170399	05/19/2014	05/18/2015
Horn Antenna	Schwarzbeck	BBHA 9120	D143	05/19/2014	05/18/2015
Spectrum Analyzer	Agilent	E4446A	US44300399	05/16/2014	05/15/2015

6.4 Radiated Emission Limit

The emissions from an intentional radiator shall not exceed the field strength levels specified in the following table 15.209(a):

Frequencies (MHz)	Field Strength (micorvolts/meter)	Measurement Distance (meters)
0.009~0.490	2400/F(KHz)	300
0.490~1.705	24000/F(KHz)	30
1.705~30.0	30	30
30~88	100	3
88~216	150	3
216~960	200	3
Above 960	500	3



Restricted bands of operation

MHz	MHz	MHz	GHz
0.090 - 0.110	16.42 - 16.423	399.9 - 410	4.5 - 5.15
<sup>1</sup> 0.495 - 0.505	16.69475 - 16.69525	608 - 614	5.35 - 5.46
2.1735 - 2.1905	16.80425 - 16.80475	960 - 1240	7.25 - 7.75
4.125 - 4.128	25.5 - 25.67	1300 - 1427	8.025 - 8.5
4.17725 - 4.17775	37.5 - 38.25	1435 - 1626.5	9.0 - 9.2
4.20725 - 4.20775	73 - 74.6	1645.5 - 1646.5	9.3 - 9.5
6.215 - 6.218	74.8 - 75.2	1660 - 1710	10.6 - 12.7
6.26775 - 6.26825	108 - 121.94	1718.8 - 1722.2	13.25 - 13.4
6.31175 - 6.31225	123 - 138	2200 - 2300	14.47 - 14.5
8.291 - 8.294	149.9 - 150.05	2310 - 2390	15.35 - 16.2
8.362 - 8.366	156.52475 - 156.52525	2483.5 - 2500	17.7 - 21.4
8.37625 - 8.38675	156.7 - 156.9	2690 - 2900	22.01 - 23.12
8.41425 - 8.41475	162.0125 - 167.17	3260 - 3267	23.6 - 24.0
12.29 - 12.293	167.72 - 173.2	3332 - 3339	31.2 - 31.8
12.51975 - 12.52025	240 - 285	3345.8 - 3358	36.43 - 36.5
12.57675 - 12.57725	322 - 335.4	3600 - 4400	( <sup>2</sup> )

Remark 1. Emission level in dBuV/m=20 log (uV/m)

- :
2. Measurement was performed at an antenna to the closed point of EUT distance of meters.
  3. Only spurious frequency is permitted to locate within the Restricted Bands specified in provision of § 15.205, and the emissions located in restricted bands also comply with 15.209 limit.

## 6.5 Measurement Result

### Below 30MHz:

All the modulation modes were tested the data of the test mode are recorded in the following pages.

Operation Mode: TX Mode                      Test Date : November 25, 2014  
Frequency Range: 9KHz~30MHz              Temperature : 28°C  
Test Result: PASS                              Humidity : 60 %  
Measured Distance: 3m                        Test By: WOLF

Freq. (MHz)	Ant.Pol. H/V	Emission Level (dBuV/m)	Limit 3m (dBuV/m)	Over (dB)
--	--	--	--	--

Note: the amplitude of spurious emission that is attenuated by more than 20dB below the permissible limit has no need to be reported.

Distance extrapolation factor =  $40\log(\text{Specific distance/ test distance})$  (dB);

Limit line = Specific limits(dBuV) + distance extrapolation factor.

### Below 1000MHz:

All the modulation modes were tested the data of the worst mode (TX 802.11g) are recorded in the following pages and the others modulation methods do not exceed the limits.

Please refer to the following test plots:

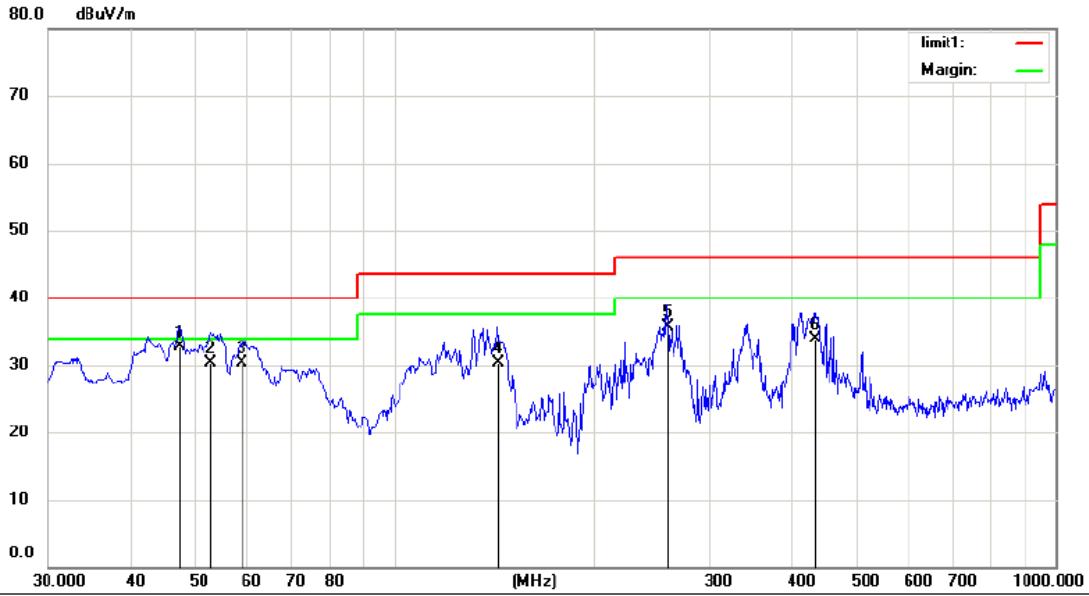

Site Chamber #1 Polarization: **Horizontal** Temperature: 26  
 Limit: (RE)FCC PART 15 class B 3m Power: AC 120V/60Hz Humidity: 55 %  
 Mode:TX2412  
 Note:

No.	Mk.	Freq.	Reading Level	Correct Factor	Measurement	Limit	Over	Antenna Height	Table Degree	
		MHz	dBuV	dB	dBuV/m	dBuV/m	dB	cm	degree	Comment
1	*	47.4600	47.10	-14.38	32.72	40.00	-7.28	QP		
2		52.9453	46.80	-16.57	30.23	40.00	-9.77	QP		
3		58.8185	49.30	-18.95	30.35	40.00	-9.65	QP		
4		143.4900	47.50	-17.29	30.21	43.50	-13.29	QP		
5		258.9200	51.20	-15.43	35.77	46.00	-10.23	QP		
6		432.5500	45.30	-11.32	33.98	46.00	-12.02	QP		

\*:Maximum data x:Over limit !:over margin

Operator: QIU

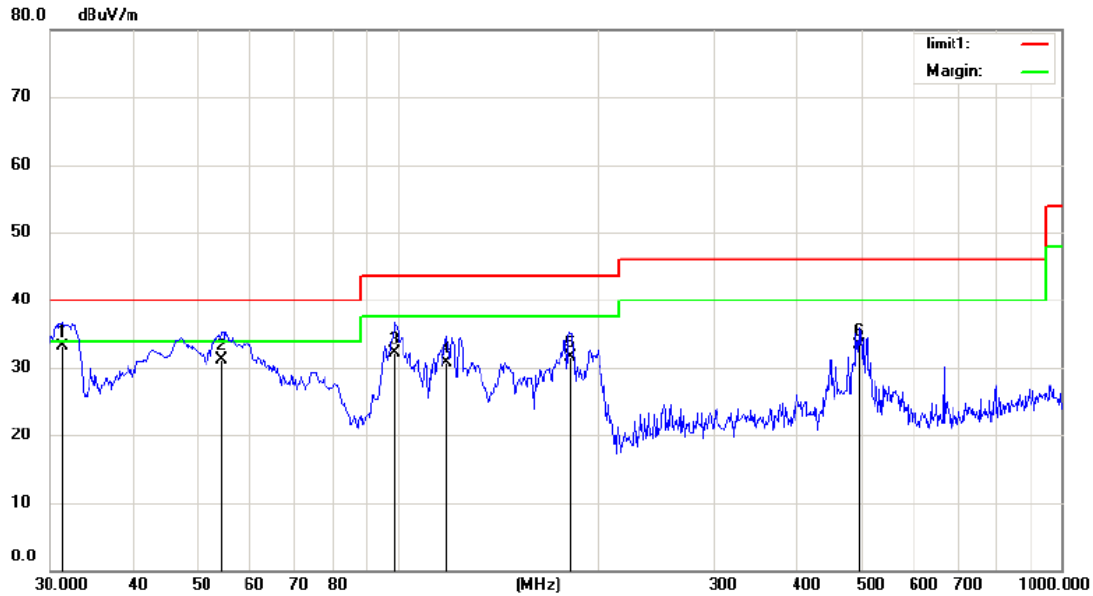

Site: Chamber #1  
 Limit: (RE)FCC PART 15 class B 3m  
 Mode: TX2412  
 Note:  
 Polarization: **Vertical**  
 Power: AC 120V/60Hz  
 Temperature: 26  
 Humidity: 55 %

No.	Mk.	Freq. MHz	Reading Level dBuV	Correct Factor dB	Measure- ment dBuV/m	Limit dBuV/m	Over dB	Antenna Height cm	Table Degree degree	Detector	Comment
1	*	31.3992	47.90	-14.78	33.12	40.00	-6.88			QP	
2		54.4515	48.20	-17.16	31.04	40.00	-8.96			QP	
3		99.1795	51.30	-19.22	32.08	43.50	-11.42			QP	
4		118.6012	47.70	-17.05	30.65	43.50	-12.85			QP	
5		182.2900	50.10	-18.66	31.44	43.50	-12.06			QP	
6		496.5700	43.60	-10.38	33.22	46.00	-12.78			QP	

\*:Maximum data x:Over limit !:over margin

Operator: QIU

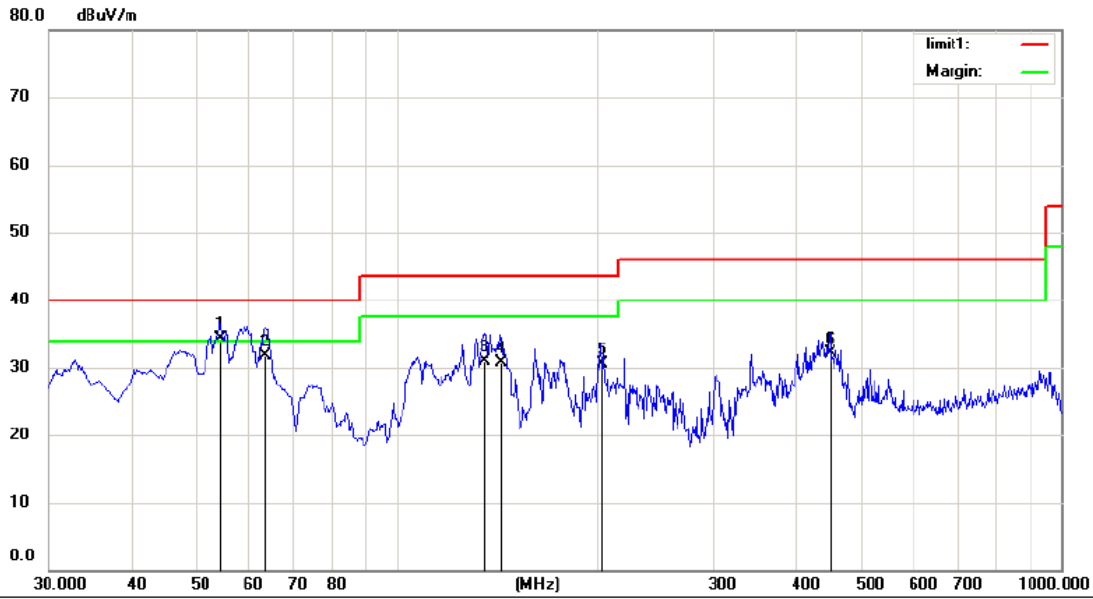

Site Chamber #1 Polarization: **Horizontal** Temperature: 26  
 Limit: (RE)FCC PART 15 class B 3m Power: AC 120V/60Hz Humidity: 55 %  
 Mode: TX2437  
 Note:

No.	Mk.	Freq. MHz	Reading Level dBuV	Correct Factor dB	Measure- ment dBuV/m	Limit dBuV/m	Over dB	Antenna Height cm	Table Degree degree	Comment
1	*	54.2610	51.30	-17.08	34.22	40.00	-5.78	QP		
2		63.5356	52.10	-20.43	31.67	40.00	-8.33	QP		
3		135.9821	47.60	-16.61	30.99	43.50	-12.51	QP		
4		143.8291	48.00	-17.31	30.69	43.50	-12.81	QP		
5		203.6300	47.90	-17.47	30.43	43.50	-13.07	QP		
6		449.0400	43.30	-11.23	32.07	46.00	-13.93	QP		

\*:Maximum data x:Over limit !:over margin

Operator: QIU

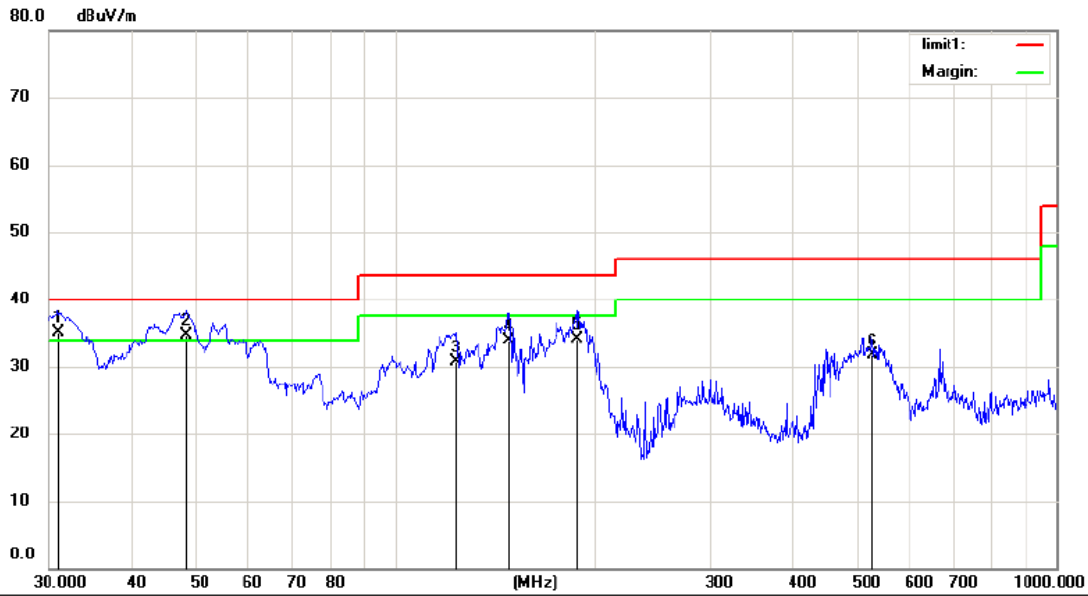

Site Chamber #1 Polarization: **Vertical** Temperature: 26  
 Limit: (RE)FCC PART 15 class B 3m Power: AC 120V/60Hz Humidity: 55 %  
 Mode: TX2437  
 Note:

No.	Mk.	Freq. MHz	Reading Level dBuV	Correct Factor dB	Measure- ment dBuV/m	Limit dBuV/m	Over dB	Antenna Height cm	Table Degree	Detector	Comment
1	*	30.9700	50.10	-14.90	35.20	40.00	-4.80			QP	
2	!	48.4300	49.40	-14.74	34.66	40.00	-5.34			QP	
3		124.0900	47.30	-16.50	30.80	43.50	-12.70			QP	
4		148.3400	51.60	-17.63	33.97	43.50	-9.53			QP	
5		188.4122	52.40	-18.37	34.03	43.50	-9.47			QP	
6		527.6100	41.50	-9.85	31.65	46.00	-14.35			QP	

\*:Maximum data x:Over limit !:over margin

Operator: QIU

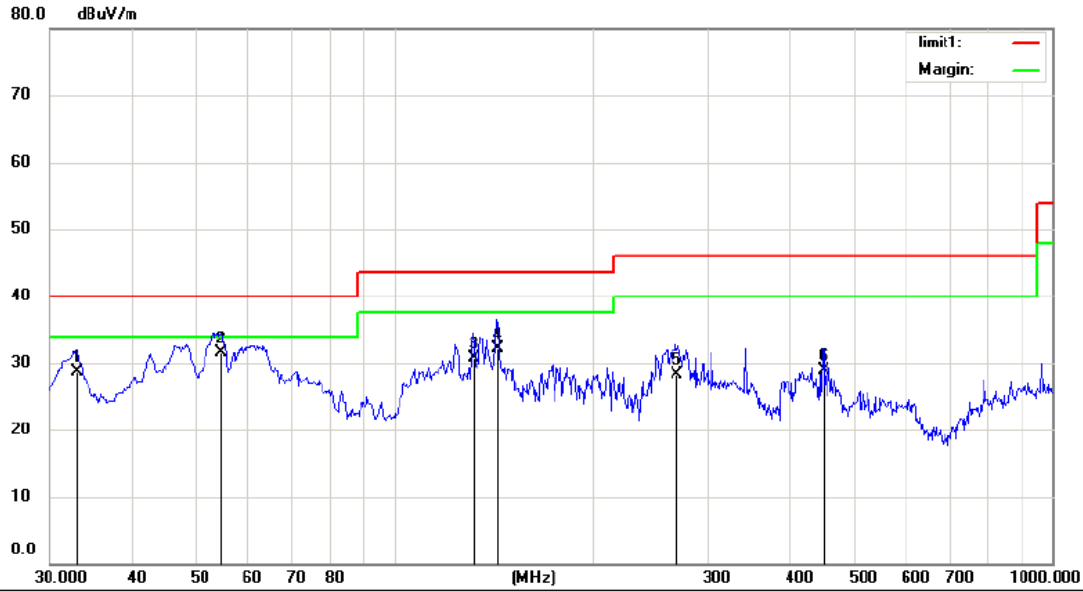

Site Chamber #1 Polarization: **Horizontal** Temperature: 26  
 Limit: (RE)FCC PART 15 class B 3m Power: AC 120V/60Hz Humidity: 55 %  
 Mode: TX2462  
 Note:

No.	Mk.	Freq. MHz	Reading Level dBuV	Correct Factor dB	Measure- ment dBuV/m	Limit dBuV/m	Over dB	Antenna Height cm	Table Degree	Detector	Comment
1		32.9100	43.20	-14.46	28.74	40.00	-11.26			QP	
2	*	54.6428	48.80	-17.23	31.57	40.00	-8.43			QP	
3		131.8500	47.10	-16.34	30.76	43.50	-12.74			QP	
4		143.4900	49.30	-17.29	32.01	43.50	-11.49			QP	
5		268.6200	43.50	-15.24	28.26	46.00	-17.74			QP	
6		449.0400	40.20	-11.23	28.97	46.00	-17.03			QP	

\*:Maximum data x:Over limit !:over margin

Operator: QIU

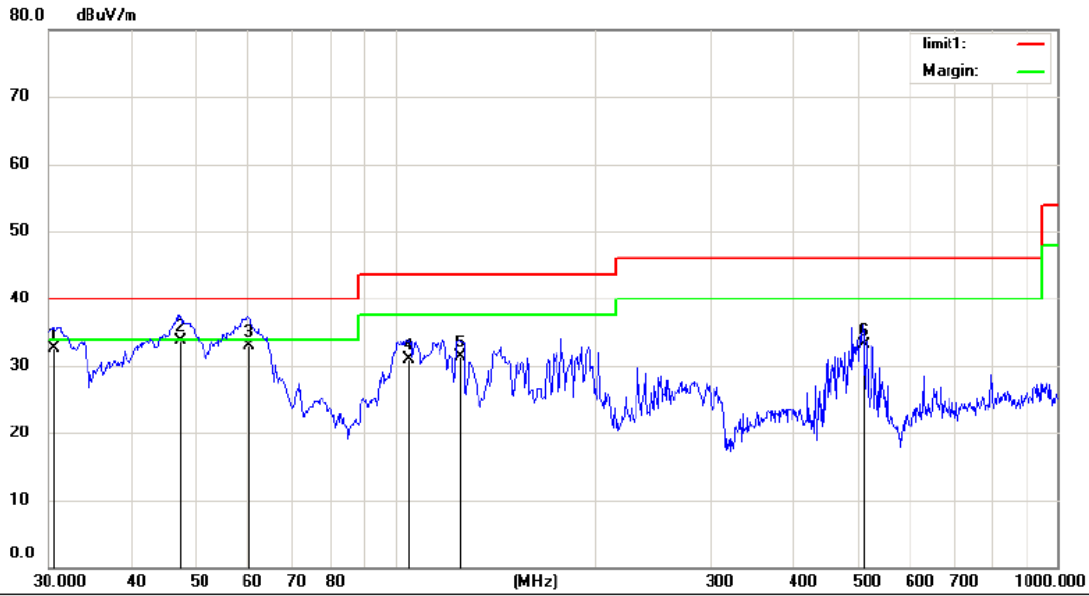

Site Chamber #1 Polarization: **Vertical** Temperature: 26  
 Limit: (RE)FCC PART 15 class B 3m Power: AC 120V/60Hz Humidity: 55 %  
 Mode: TX2462  
 Note:

No.	Mk.	Freq. MHz	Reading Level dBuV	Correct Factor dB	Measure- ment dBuV/m	Limit dBuV/m	Over dB	Antenna Height cm	Table Degree	Comment
1		30.6371	47.50	-14.98	32.52	40.00	-7.48	QP		
2	*	47.4600	48.10	-14.38	33.72	40.00	-6.28	QP		
3		60.0700	52.30	-19.42	32.88	40.00	-7.12	QP		
4		105.2716	49.10	-18.18	30.92	43.50	-12.58	QP		
5		125.0600	47.70	-16.40	31.30	43.50	-12.20	QP		
6		509.1800	43.30	-10.19	33.11	46.00	-12.89	QP		

\*:Maximum data x:Over limit !:over margin

Operator: QIU



**Above 1000MHz:**

Operation Mode: 802.11g Lowest Test Date : November 25, 2014

Freq. (MHz)	Ant. Pol. H/V	Emission Level(dBuV/m)		Limit 3m(dBuV/m)		Over(dB)	
		PK	AV	PK	AV	PK	AV
4824	V	65.11	44.29	74	54	-8.89	-9.71
7236	V	63.95	43.21	74	54	-10.05	-10.79
9648	V	62.58	42.87	74	54	-11.42	-11.13
12060	V	61.84	41.06	74	54	-12.16	-12.94
14472	V	60.32	40.28	74	54	-13.68	-13.72
16884	V	59.17	38.51	74	54	-14.83	-15.49
4824	H	65.49	44.86	74	54	-8.51	-9.14
7236	H	64.38	43.79	74	54	-9.62	-10.21
9648	H	63.24	42.37	74	54	-10.76	-11.63
12060	H	62.96	41.56	74	54	-11.04	-12.44
14472	H	60.75	40.93	74	54	-13.25	-13.07
16884	H	59.77	39.64	74	54	-14.23	-14.36

Operation Mode: 802.11g Middle Test Date : November 25, 2014

Freq. (MHz)	Ant. Pol. H/V	Emission Level(dBuV/m)		Limit 3m(dBuV/m)		Over(dB)	
		PK	AV	PK	AV	PK	AV
4874	V	64.87	45.94	74	54	-9.13	-8.06
7311	V	63.25	44.67	74	54	-10.75	-9.33
9688	V	62.16	43.22	74	54	-11.84	-10.78
12185	V	61.48	42.86	74	54	-12.52	-11.14
14622	V	60.35	40.73	74	54	-13.65	-13.27
17059	V	58.76	39.62	74	54	-15.24	-14.38
4874	H	65.36	45.86	74	54	-8.64	-8.14
7311	H	64.99	44.61	74	54	-9.01	-9.39
9688	H	63.82	43.15	74	54	-10.18	-10.85
12185	H	61.42	42.69	74	54	-12.58	-11.31
14622	H	60.46	41.08	74	54	-13.54	-12.92
17059	H	59.75	40.43	74	54	-14.25	-13.57

Operation Mode: 802.11g Highest

Test Date : November 25, 2014

Freq. (MHz)	Ant. Pol. H/V	Emission Level(dBuV/m)		Limit 3m(dBuV/m)		Over(dB)	
		PK	AV	PK	AV	PK	AV
4924	V	65.23	45.86	74	54	-8.77	-8.14
7386	V	64.26	44.92	74	54	-9.74	-9.08
9848	V	63.42	42.96	74	54	-10.58	-11.04
12310	V	62.05	41.38	74	54	-11.95	-12.62
14772	V	61.87	40.72	74	54	-12.13	-13.28
17234	V	60.39	38.91	74	54	-13.61	-15.09
4924	H	64.75	44.19	74	54	-9.25	-9.81
7386	H	62.95	43.28	74	54	-11.05	-10.72
9848	H	61.43	42.07	74	54	-12.57	-11.93
12310	H	60.27	41.33	74	54	-13.73	-12.67
14772	H	59.34	40.14	74	54	-14.66	-13.86
17234	H	58.64	39.57	74	54	-15.36	-14.43

**All emissions not reported were more than 20dB below the specified limit or in the noise floor.**

- Note:**
- (1) All Readings are Peak Value and AV.
  - (2) Emission Level= Reading Level+Probe Factor +Cable Loss.
  - (3) Data of measurement within this frequency range shown " - " in the table above means the reading of emissions are attenuated more than 20Db below the permissible limits or the field strength is too small to be measured.

## 7. 6dB Bandwidth Test

### 7.1 Measurement Procedure

The EUT was operating in IEEE 802.11b, 802.11g, 802.11n(H20), 802.11n(H40) mode or could be controlled its channel. Printed out the test result from the spectrum by hard copy function.

1. Set resolution bandwidth (RBW) = 100 kHz.
2. Set the video bandwidth (VBW) = 300 kHz
3. Detector = Peak.
4. Trace mode = max hold.
5. Sweep = auto couple.
6. Allow the trace to stabilize.
7. Measure the maximum width of the emission that is constrained by the frequencies associated with the two outermost amplitude points (upper and lower frequency) that are attenuated by 6 dB relative to the maximum level measured in the fundamental emission.

### 7.2 Test SET-UP (Block Diagram of Configuration)

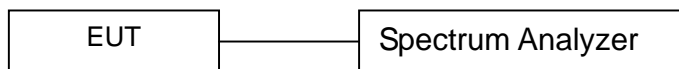

### 7.3 Measurement Equipment Used

EQUIPMENT TYPE	MFR	MODEL NUMBER	SERIAL NUMBER	LAST CAL.	CAL DUE.
Spectrum Analyzer	Agilent	FSV30	1321.3008K	05/16/2014	05/15/2015

### 7.4 Measurement Results

6 Bandwidth Test Data Chart:

Refer to attached data chart.

Spectrum Detector: PK                      Test Date : November 25, 2014  
 Test By: Andy                              Temperature : 28°C  
 Test Mode: 802.11b                      Humidity : 60%

Channel frequency (MHz)	Measurement level (KHz)	Required Limit (KHz)	Result
2412	9530	>500	Pass
2437	9530	>500	
2462	9530	>500	

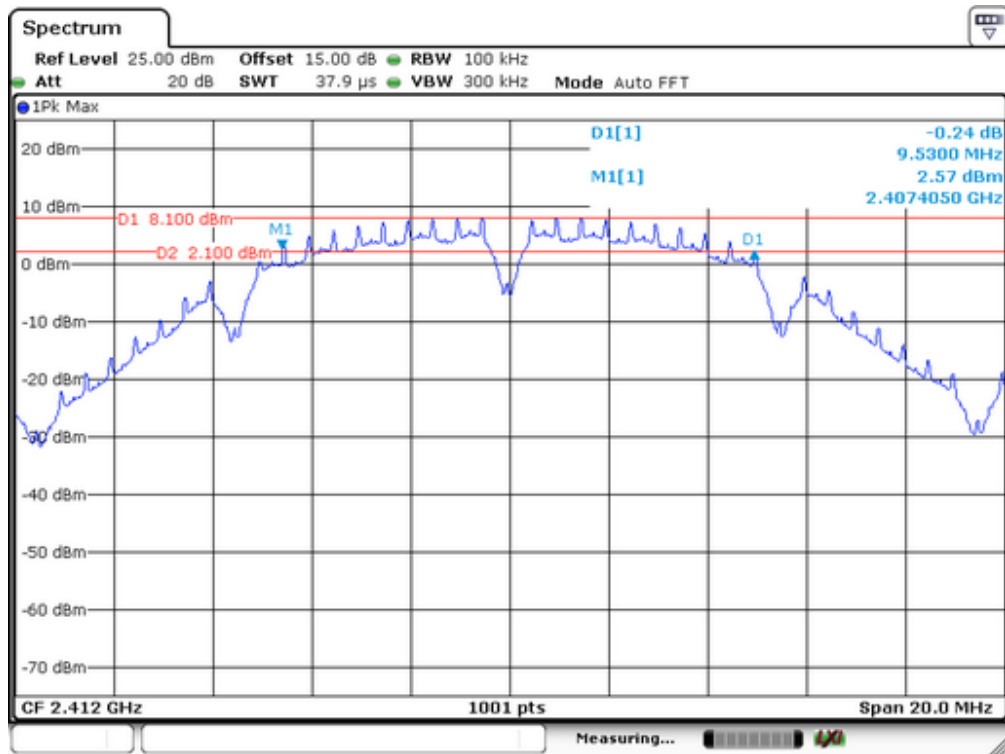

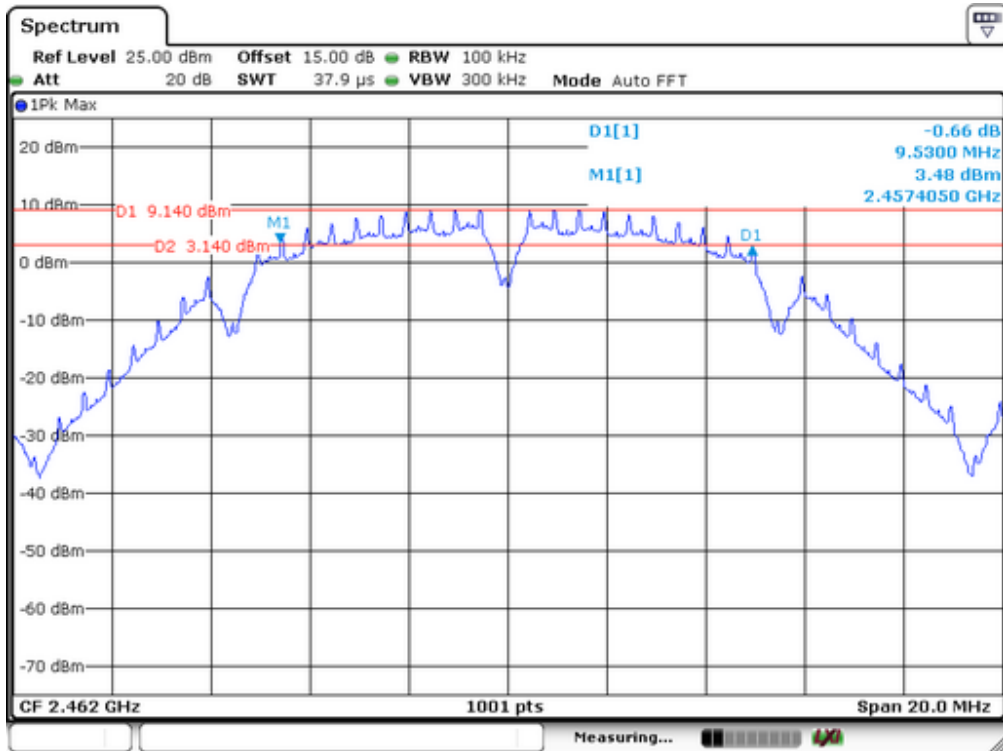
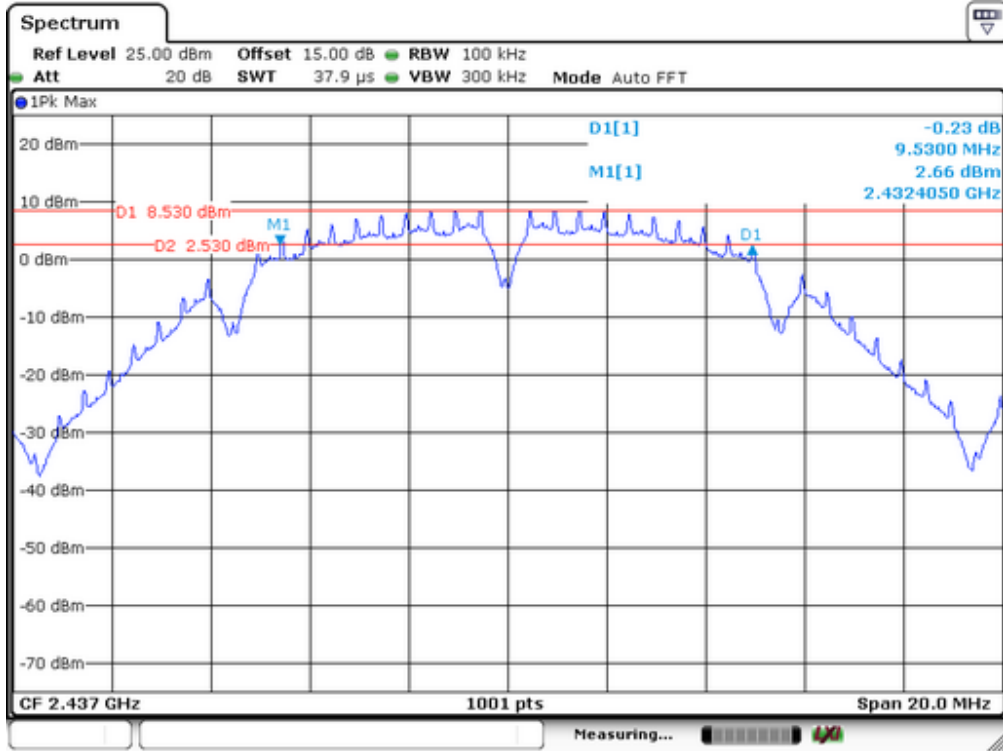

Spectrum Detector: PK                      Test Date : November 25, 2014  
 Test By: Andy                              Temperature : 28°C  
 Test Mode: 802.11g                      Humidity : 60%

Channel frequency (MHz)	Measurement level (KHz)	Required Limit (KHz)	Result
2412	16364	>500	Pass
2437	16424	>500	
2462	16344	>500	

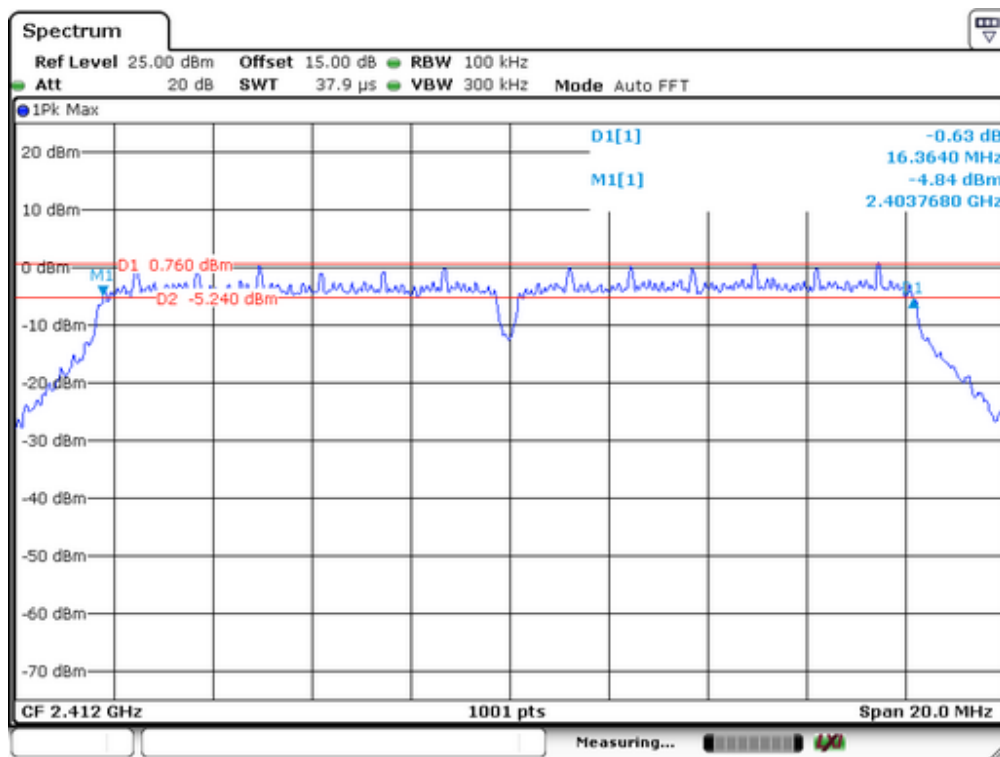

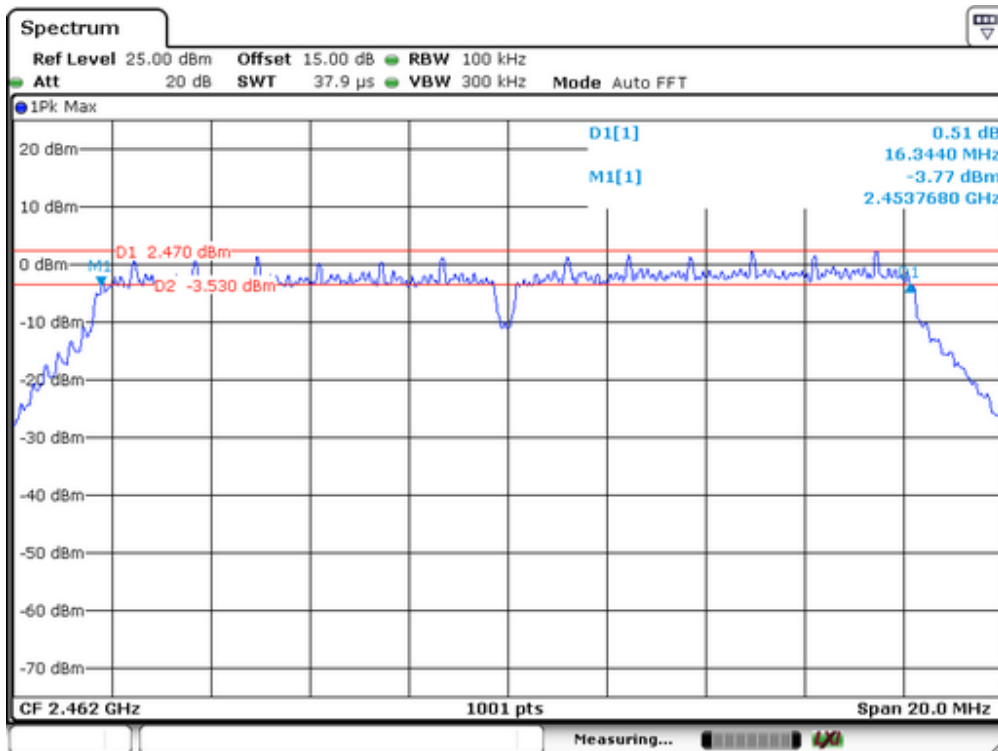
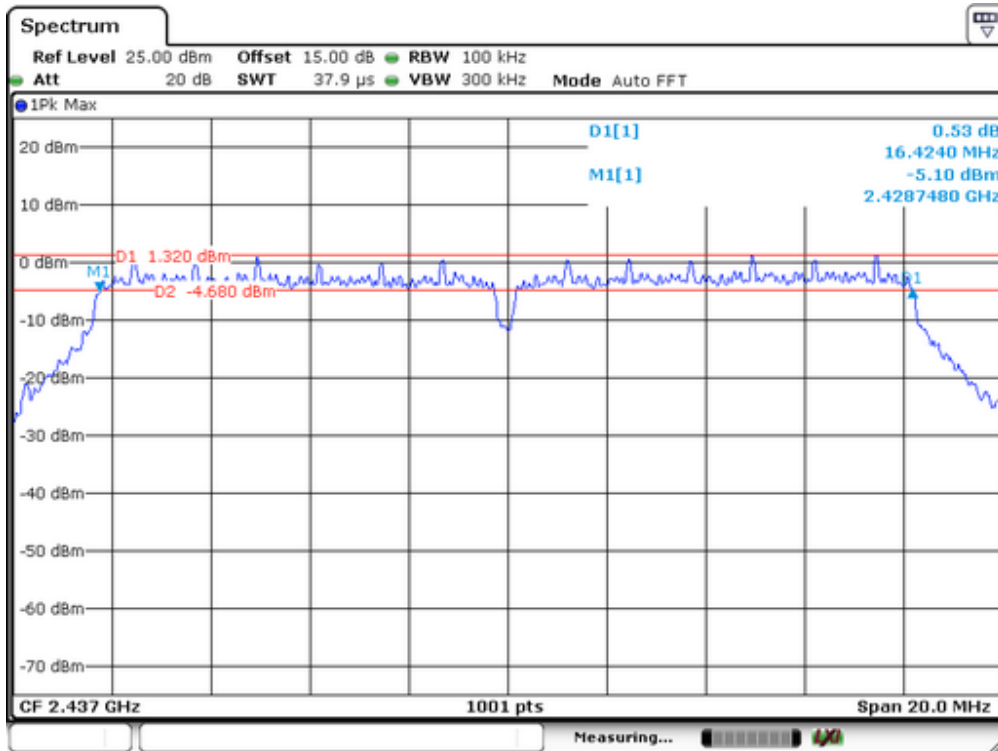

Spectrum Detector: PK                      Test Date : November 25, 2014  
 Test By: Andy                              Temperature : 28°C  
 Test Mode: 802.11n(H20)                  Humidity : 60%

Channel frequency (MHz)	Measurement level (KHz)	Required Limit (KHz)	Result
2412	17303	>500	Pass
2437	17323	>500	
2462	17283	>500	

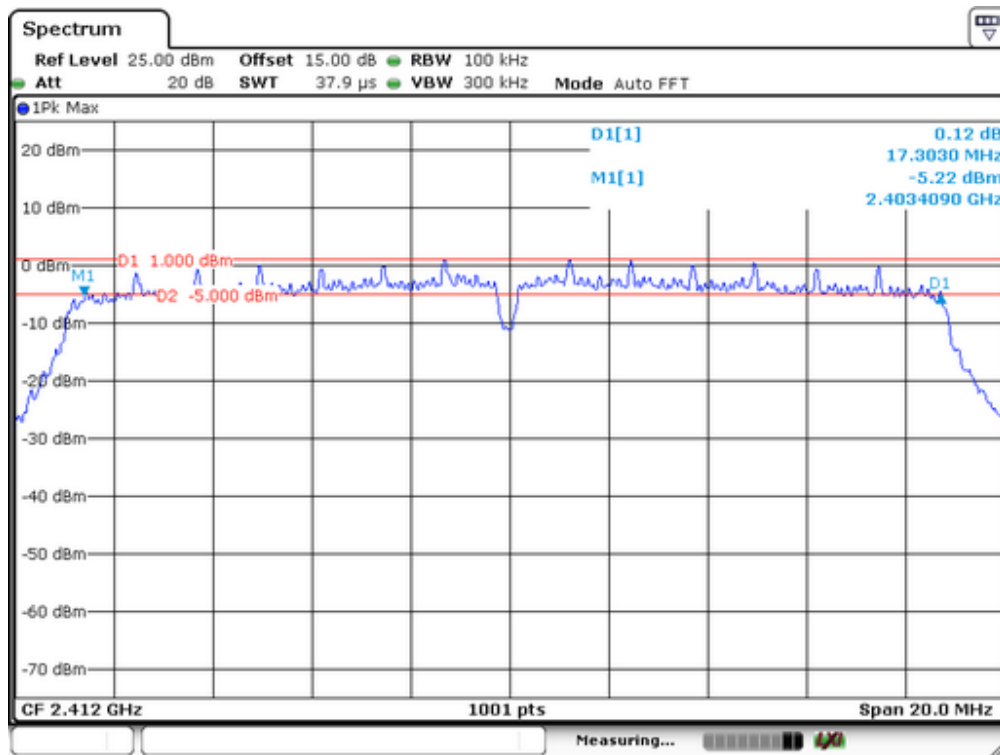



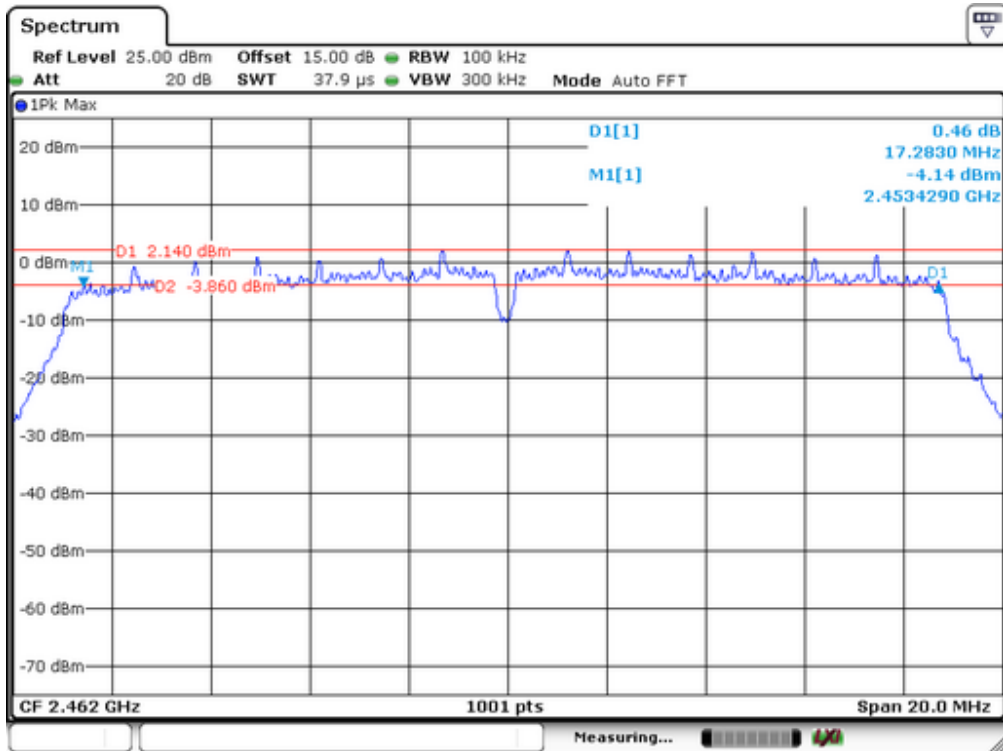
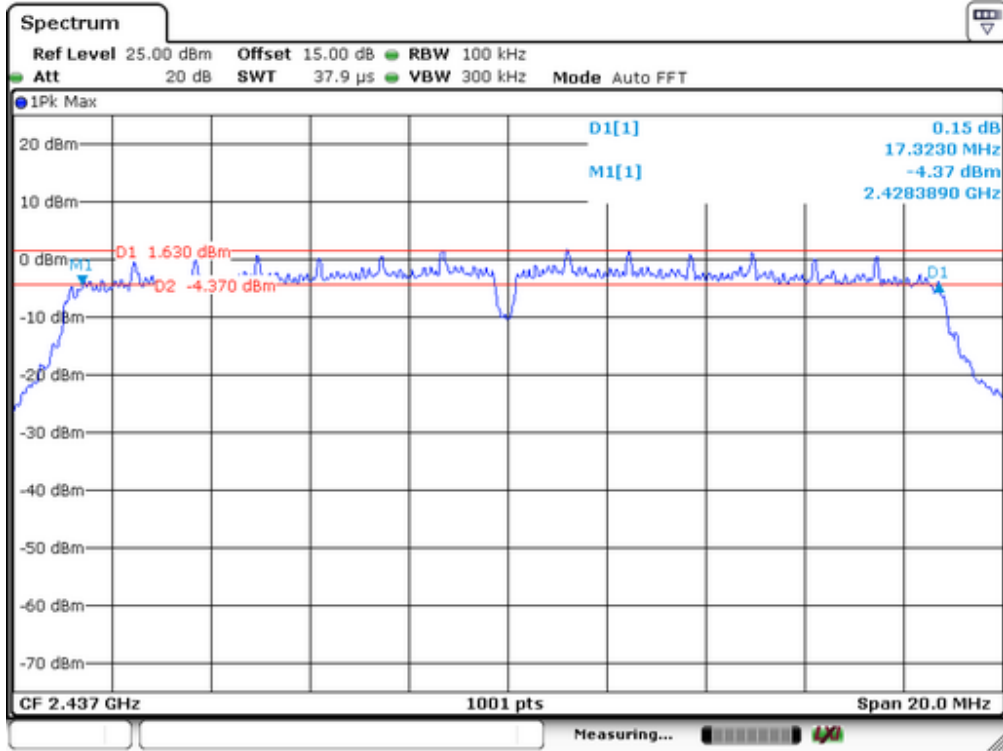

Spectrum Detector: PK                      Test Date : November 25, 2014  
 Test By: Andy                              Temperature : 28°C  
 Test Mode: 802.11n(H40)                  Humidity : 60%

Channel frequency (MHz)	Measurement level (KHz)	Required Limit (KHz)	Result
2422	36084	>500	Pass
2437	36044	>500	
2452	35764	>500	

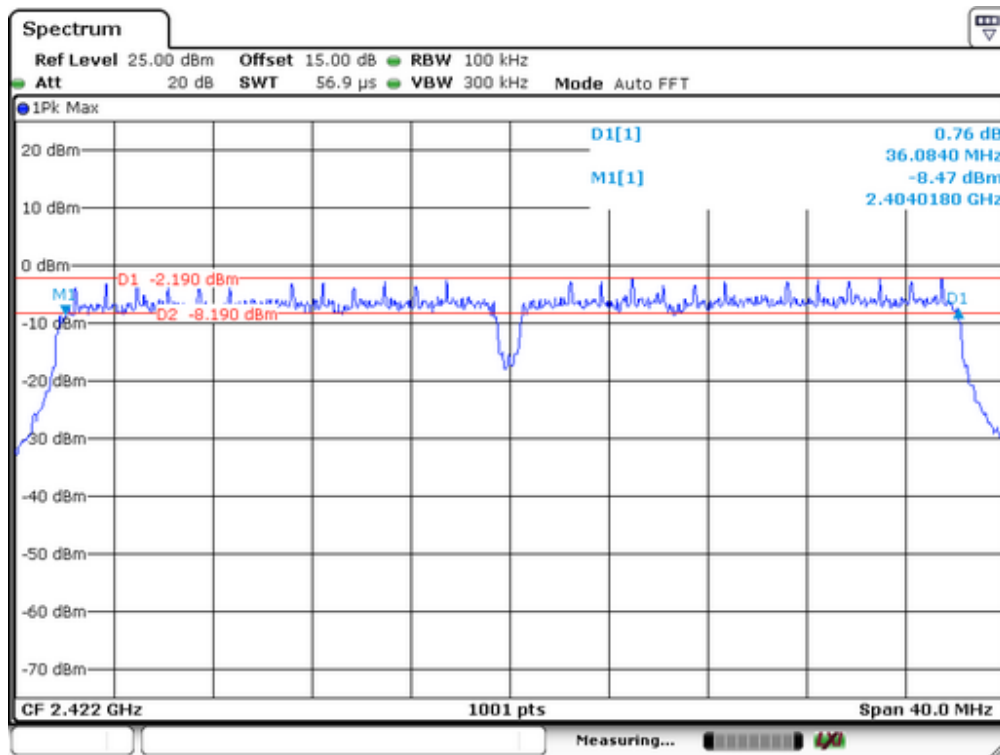

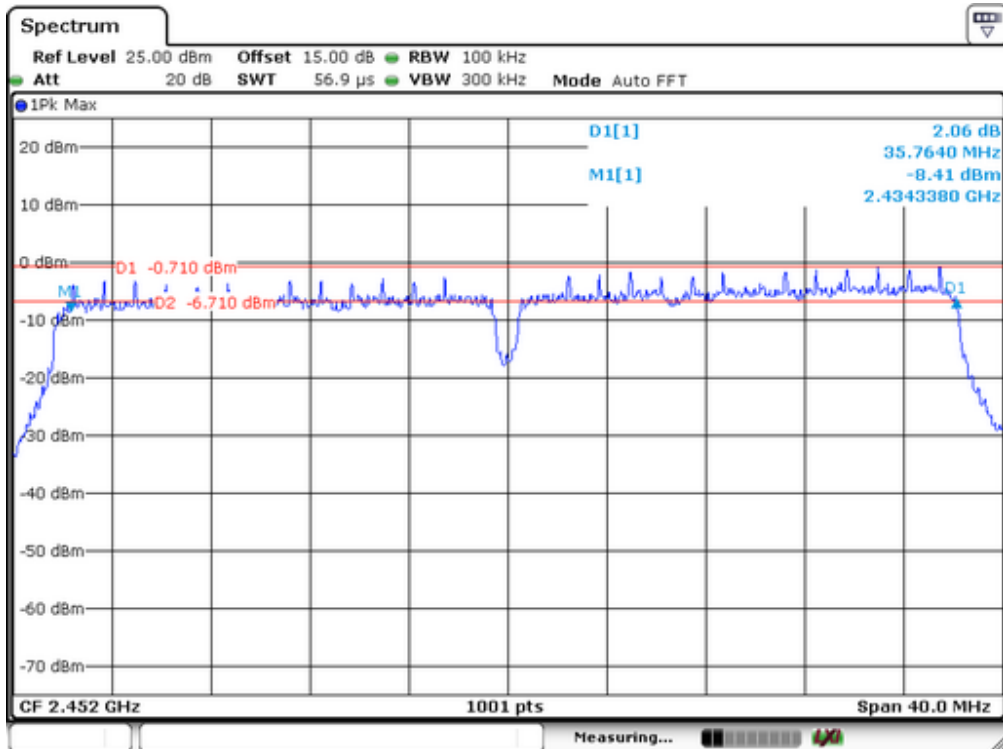
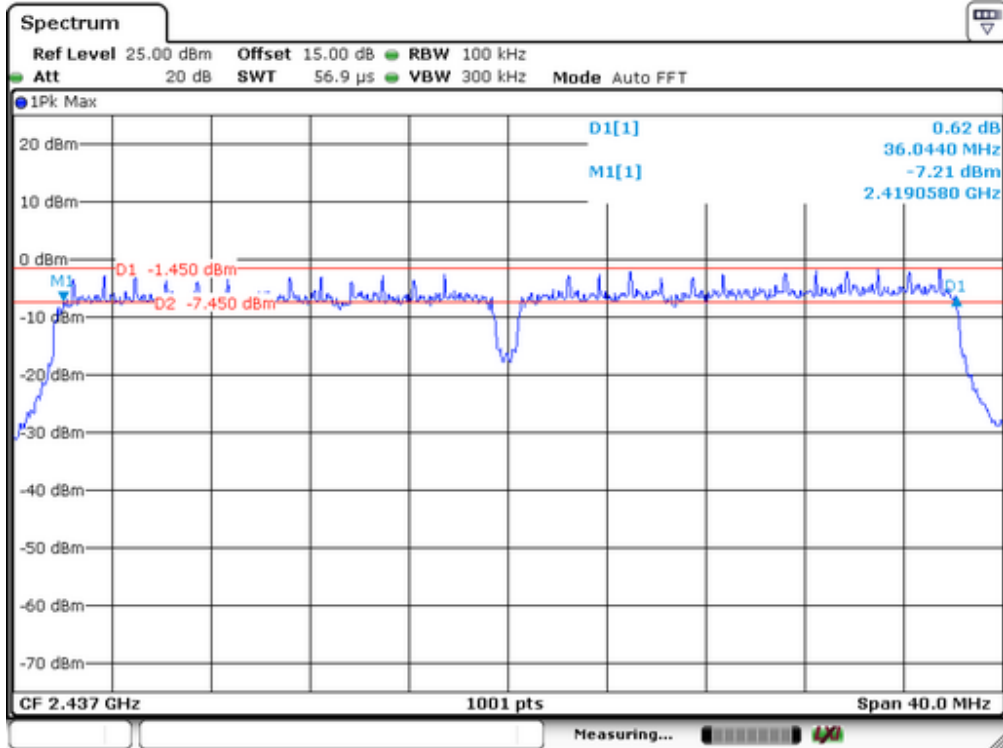

## 8. Maximum Peak Output Power Test

### 8.1 Measurement Procedure

The maximum peak conducted output power can be measured using a broadband peak RF power meter. The power meter must have a video bandwidth that is greater than or equal to the DTS bandwidth and shall utilize a fast, average-responding diode type sensor.

- a. The Transmitter output (antenna port) was connected to the power meter.
- b. Turn on the EUT and power meter and then record the peak power value.
- c. Repeat above procedures on all channels needed to be tested.

### 8.2 Test SET-UP (Block Diagram of Configuration)



### 8.3 Measurement Equipment Used

EQUIPMENT TYPE	MODEL NUMBER	SERIAL NUMBER	LAST CAL.	CAL DUE.
Power meter	ML2495A	0824006	05/16/2014	05/15/2015
Power sensor	MA2411B	0738172	05/16/2014	05/15/2015

### 8.4 Peak Power output limit

The maximum peak power shall be less 1Watt.

### 8.5 Measurement Results

Spectrum Detector:	PK	Test Date :	November 25, 2014
Test By:	Jack	Temperature :	28°C
Test Result:	PASS	Humidity :	60%

Test Channel	Max Output Power (dBm)				Limit(dBm)	Result
	802.11b	802.11g	802.11n(H20)	802.11n(H40)		
Lowest	16.59	13.11	13.21	13.01	30	Pass
Middle	17.45	13.86	13.86	13.31		
Highest	17.46	14.03	13.87	13.62		

## 9. Band Edge Test

### 9.1 Measurement Procedure

#### For Conducted Test

1. The testing follows FCC KDB Publication No. 558074 D01 DTS Meas. Guidance v03r02.
2. The RF output of EUT was connected to the spectrum analyzer by RF cable and attenuator. The path loss was compensated to the results for each measurement.
3. Set to the maximum power setting and enable the EUT transmit continuously.
4. Set RBW = 100 kHz, VBW=300 kHz, Peak Detector. Unwanted Emissions measured in any 100 kHz bandwidth outside of the authorized frequency band shall be attenuated by at least 20 dB relative to the maximum in-band peak PSD level in 100 kHz when maximum peak conducted output power procedure is used. Measure and record the results in the test report.
5. The RF fundamental frequency should be excluded against the limit line in the operating frequency band.

#### For Radiated emission Test

1. The testing follows FCC KDB Publication No. 558074 D01 DTS Meas. Guidance v03r02.
2. The EUT was arranged to its worst case and then tune the antenna tower (from 1 m to 4 m) and turntable (from 0 degree to 360 degrees) to find the maximum reading. A pre-amp and a high pass filter are used for the test in order to get better signal level.
3. The EUT was placed on a turntable with 0.8 meter above ground.
4. The EUT was set 3 meters from the interference receiving antenna, which was mounted on the top of a variable height antenna tower.
5. Corrected Reading: Antenna Factor + Cable Loss + Read Level - Preamp Factor = Level.
6. For measurement below 1GHz, If the emission level of the EUT measured by the peak detector is 3 dB lower than the applicable limit, the peak emission level will be reported. Otherwise, the emission measurement will be repeated using the quasi-peak detector and reported.
7. Repeat above procedures until all frequency measured were complete.

When spectrum scanned above 1GHz setting resolution bandwidth 1MHz, video bandwidth 3MHz.

EMI Test Receiver	Setting
Attenuation	Auto
RB	1MHz
VB	3MHz
Detector	Peak
Trace	Max hold

When spectrum scanned above 1GHz setting resolution bandwidth 1MHz, video bandwidth 10Hz.

EMI Test Receiver	Setting
Attenuation	Auto
RB	1MHz
VB	10Hz
Detector	Peak
Trace	Max hold

## 9.2 Test SET-UP (Block Diagram of Configuration)

As 6.2 Test set up (B) and (C)

## 9.3 Measurement Equipment Used

Same as 6.3 Radiated Emission Measurement.

## 9.4 Measurement Results

### 1. Conducted Test

Test Mode: 802.11b

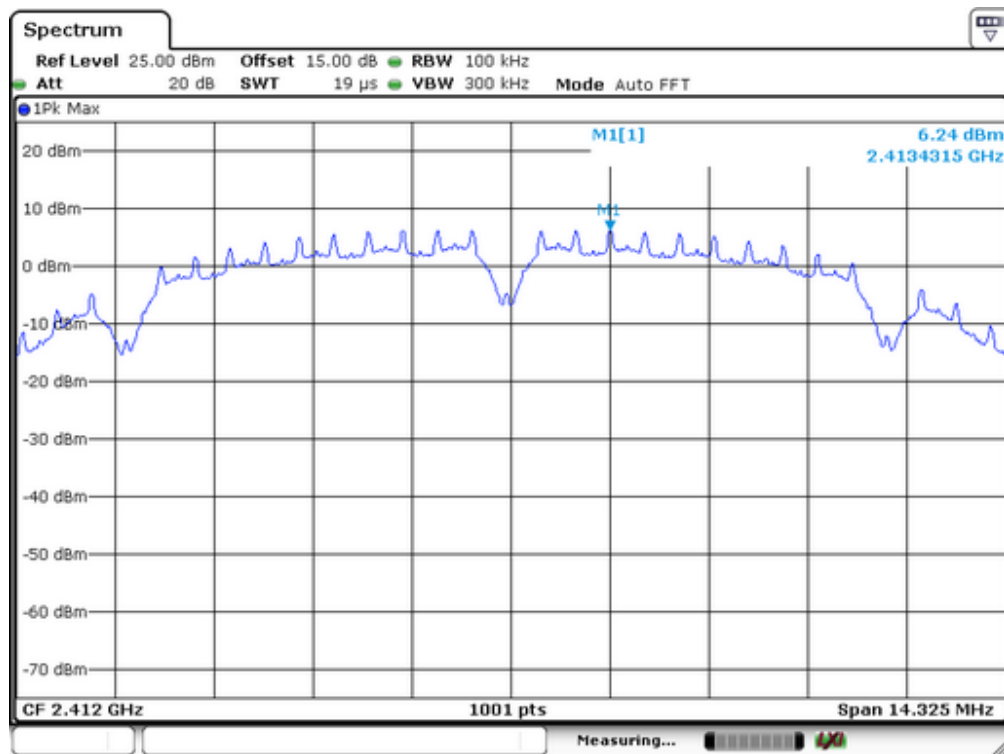

Lowest Channel

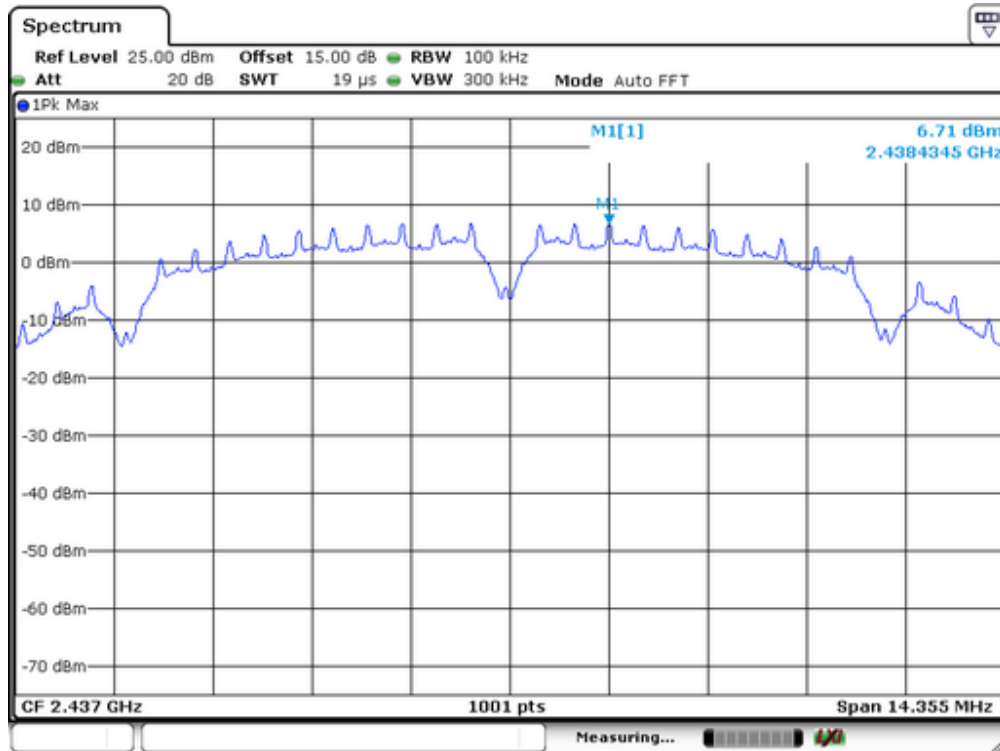

Middle Channel

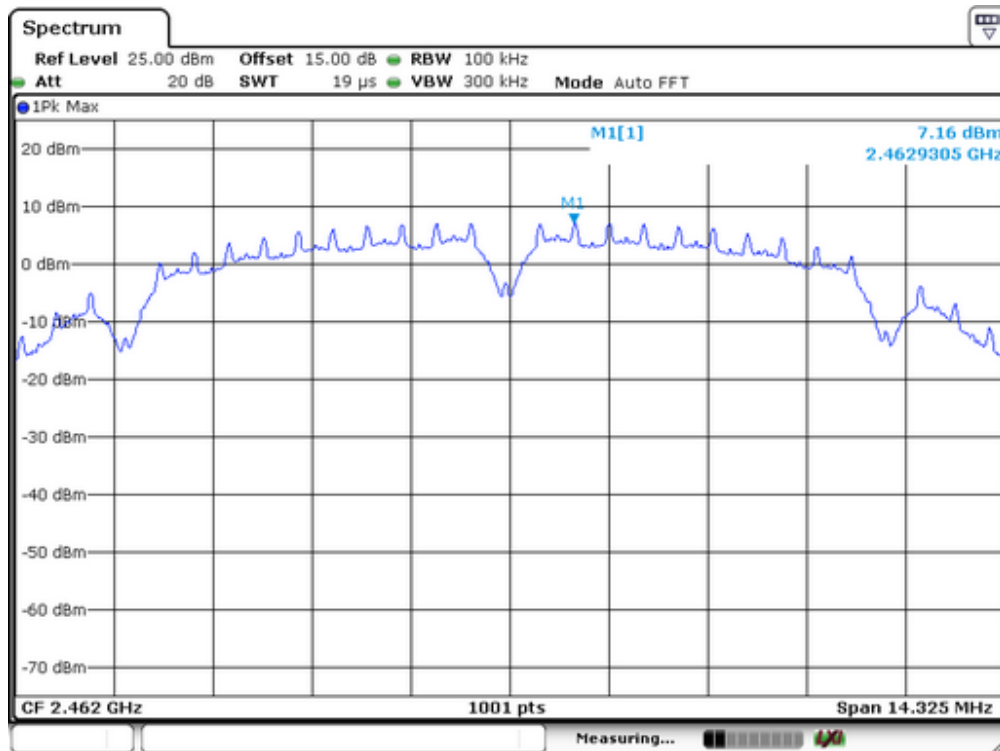

Highest Channel

Test Mode: 802.11g

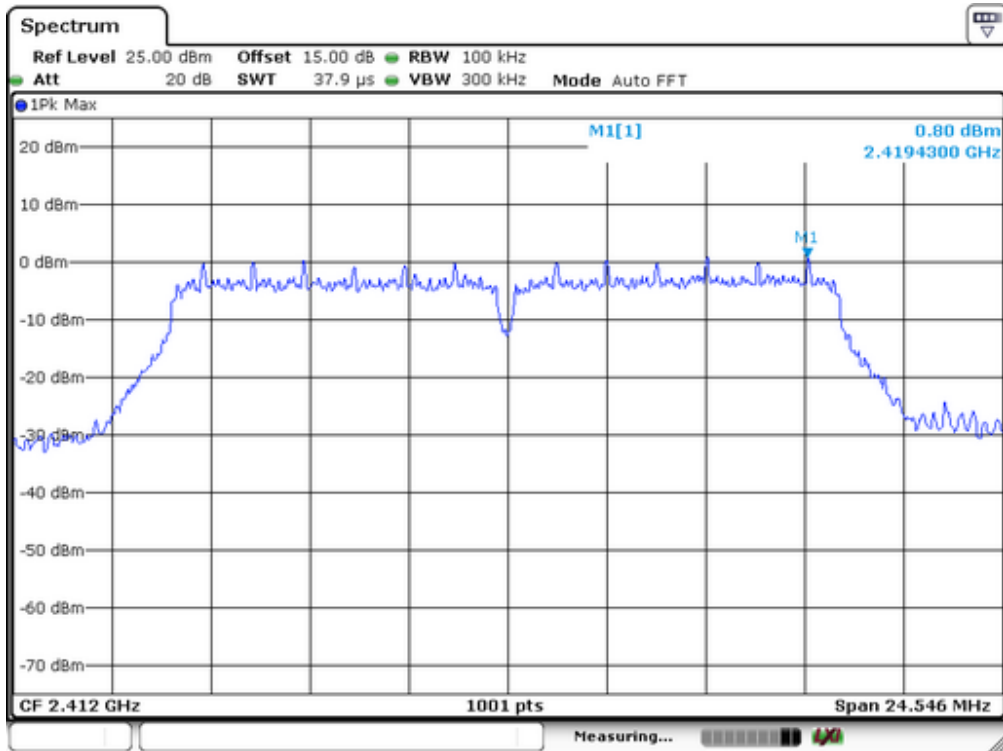

Lowest Channel

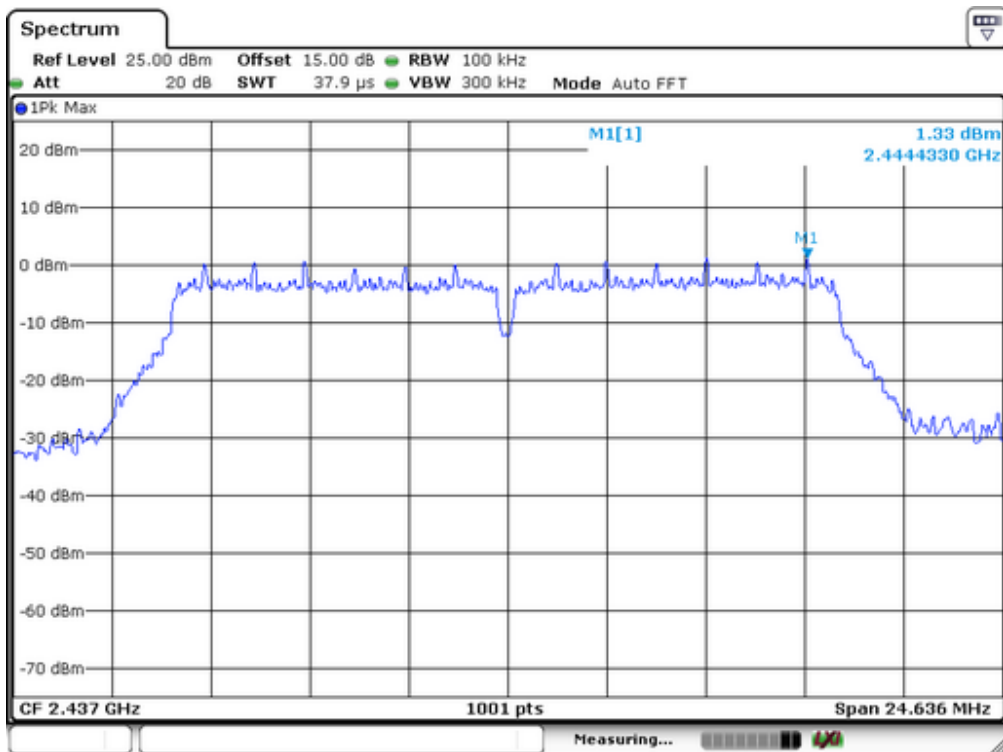

Middle Channel



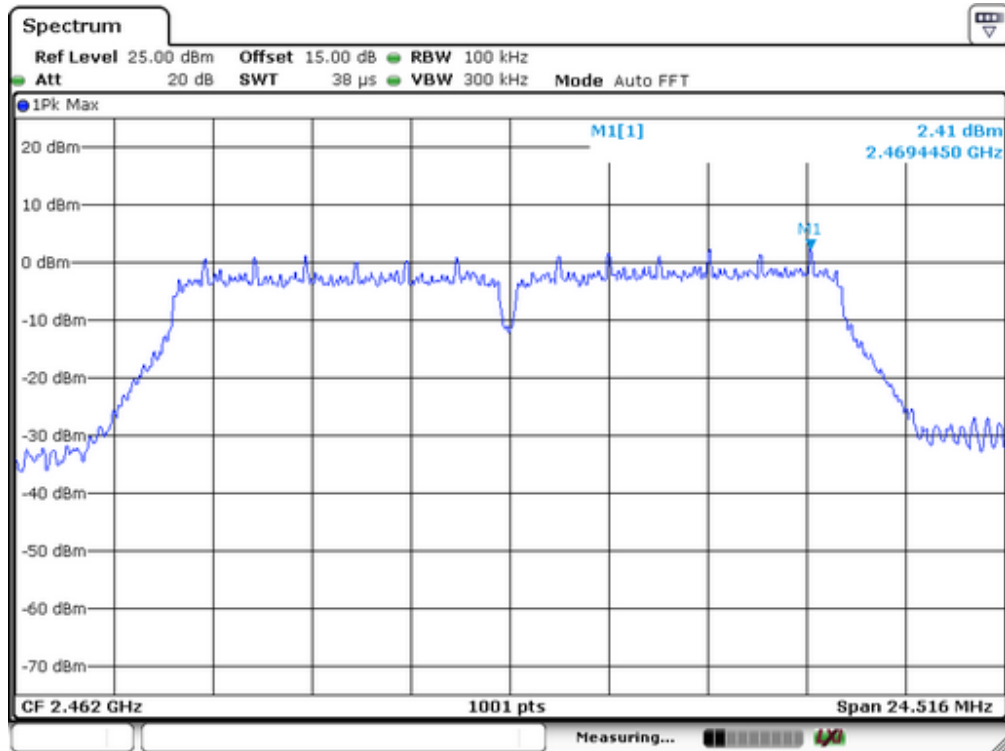

Highest Channel

Test Mode: 802.11n(H20)

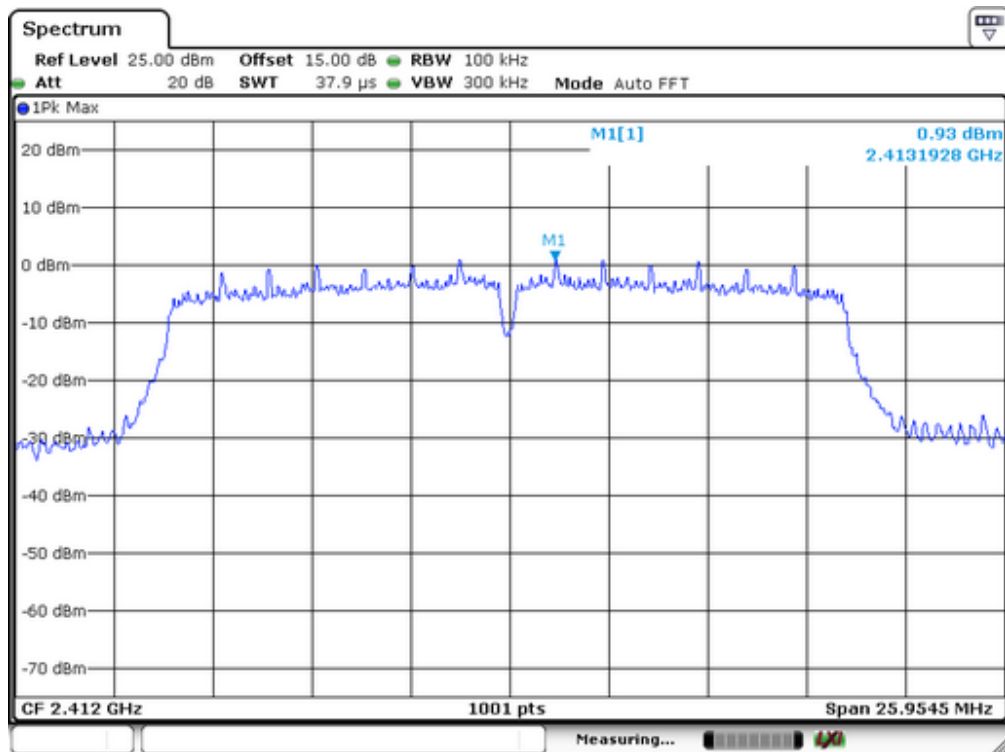

Lowest Channel

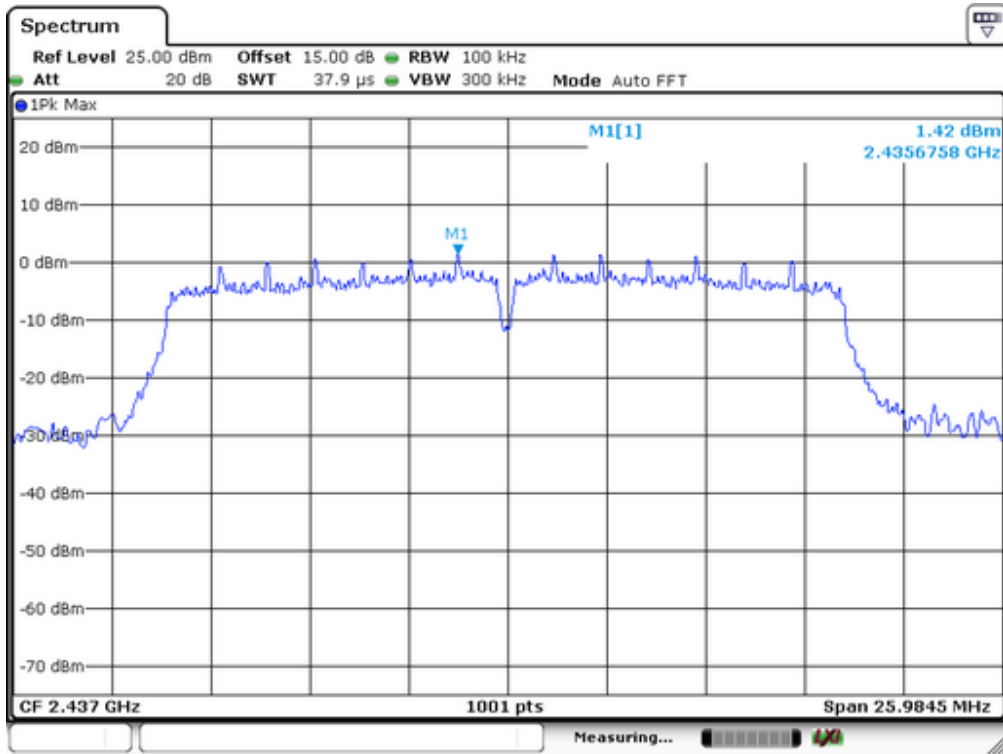

Middle Channel

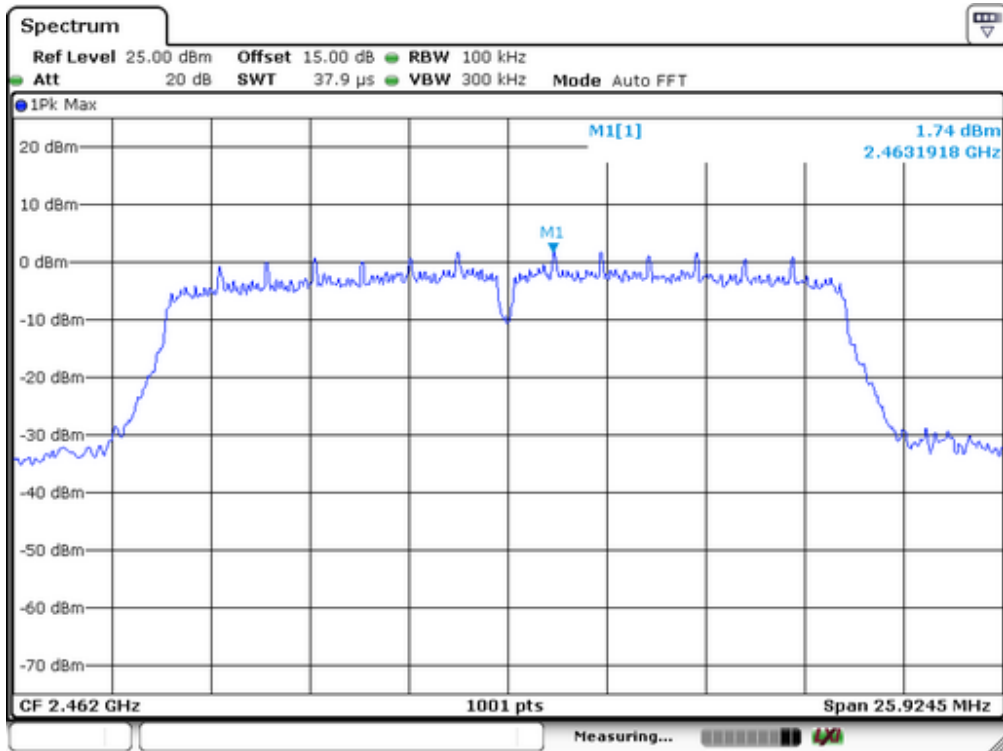

Highest Channel

Test Mode: 802.11n(H40)

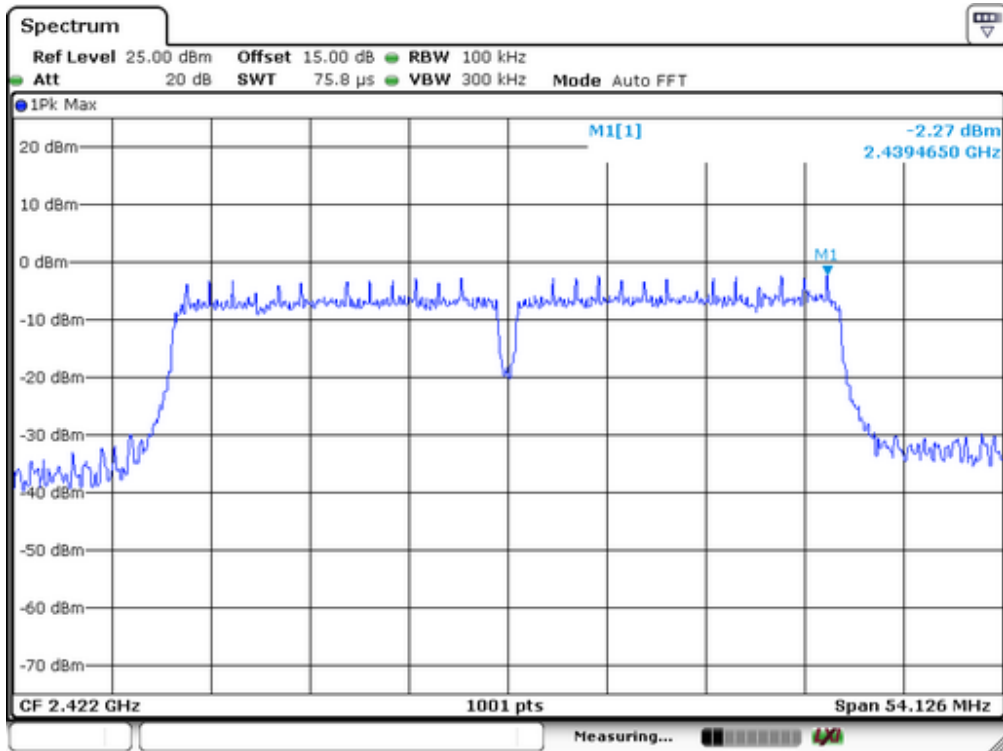

Lowest Channel

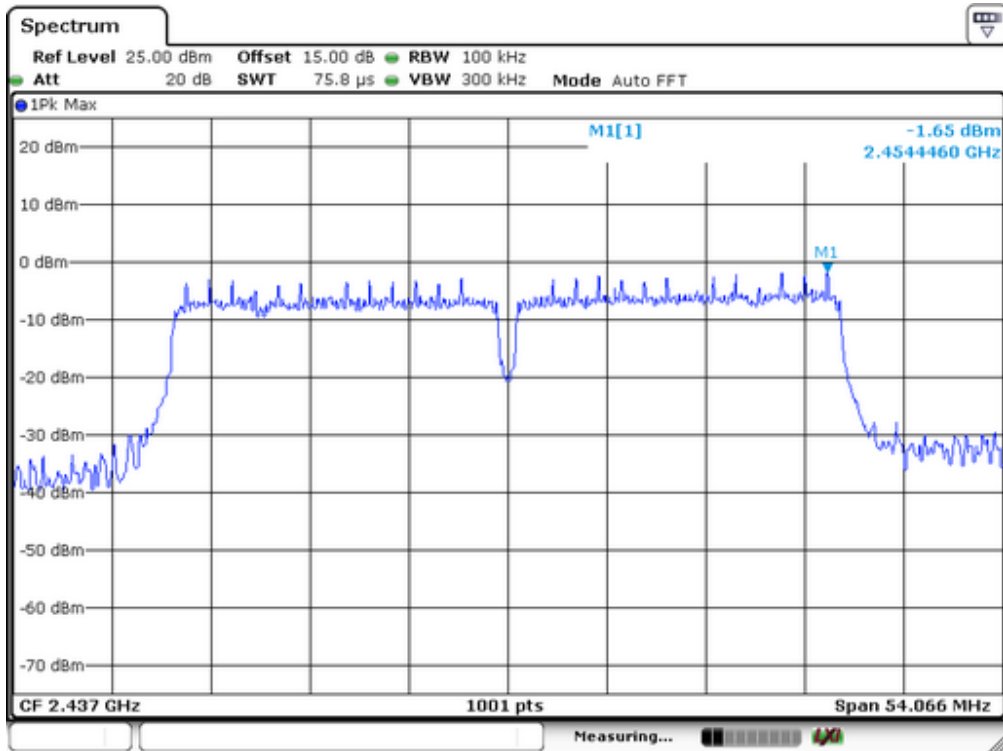

Middle Channel

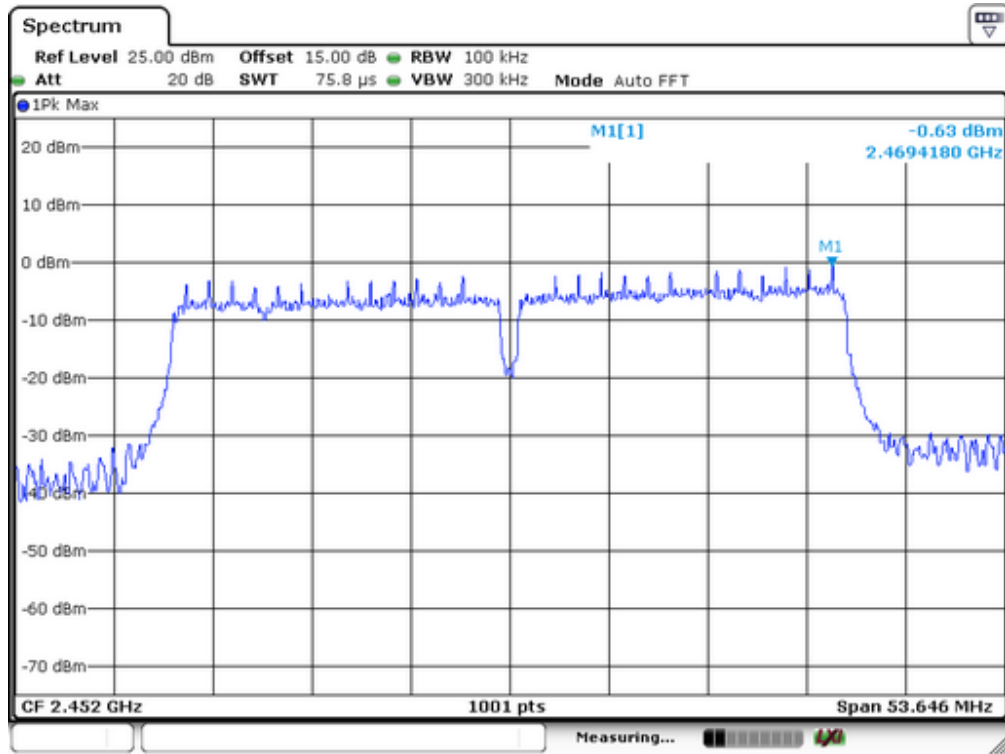

Highest Channel

Test mode: 802.11b

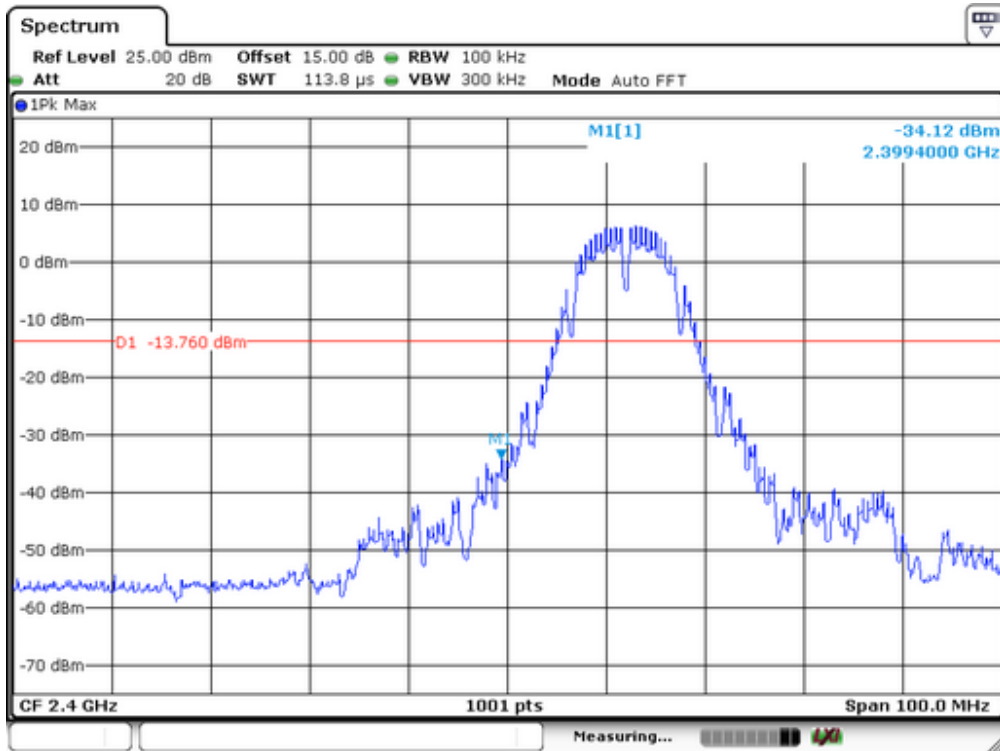

Lowest Channel

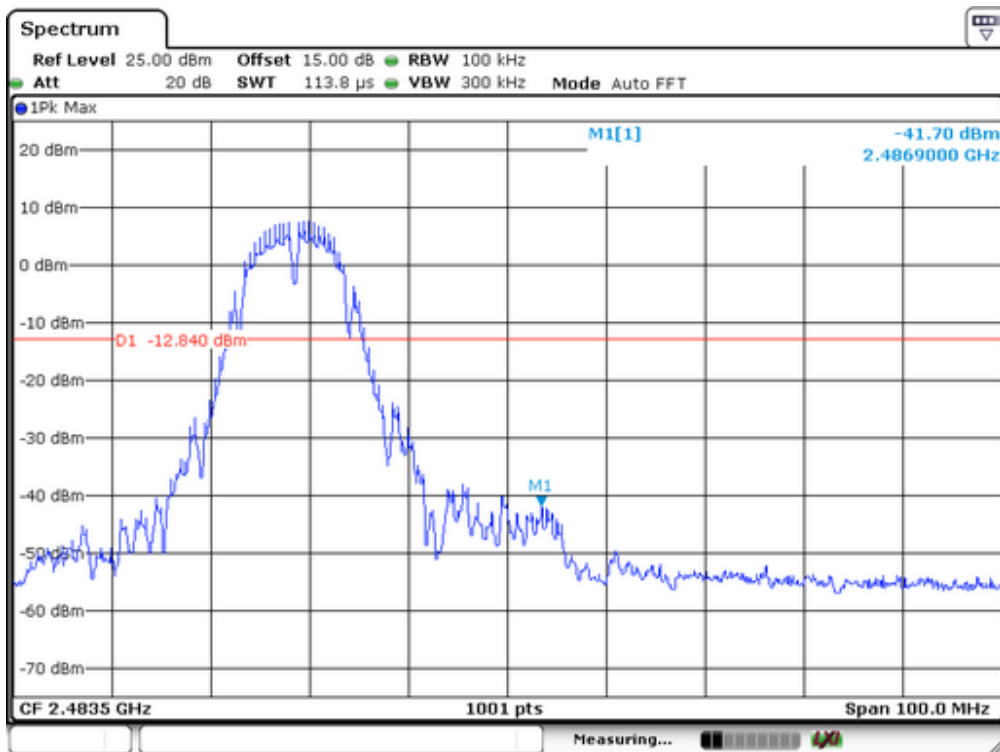

Highest Channel

Test mode: 802.11g

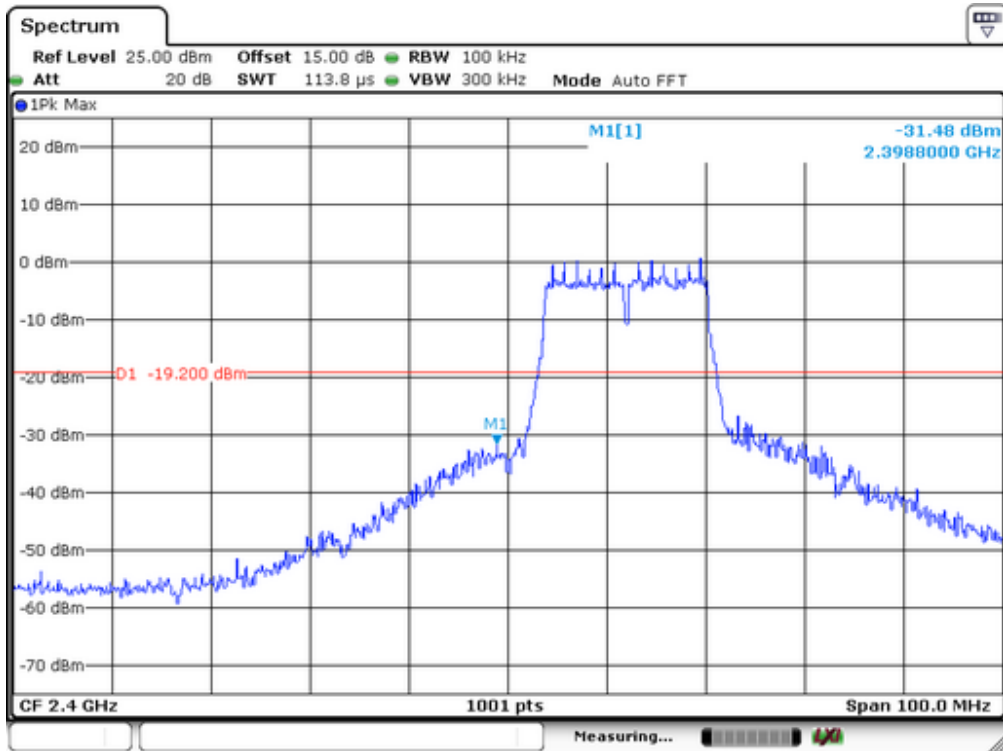

Lowest Channel

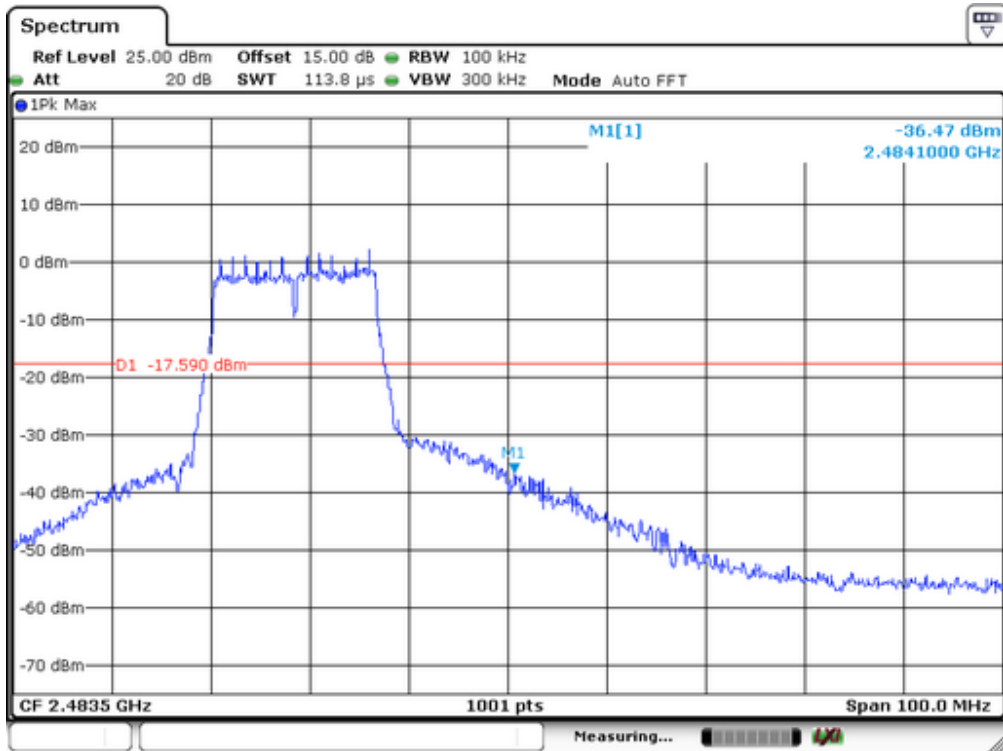

Highest Channel

Test mode: 802.11n(H20)

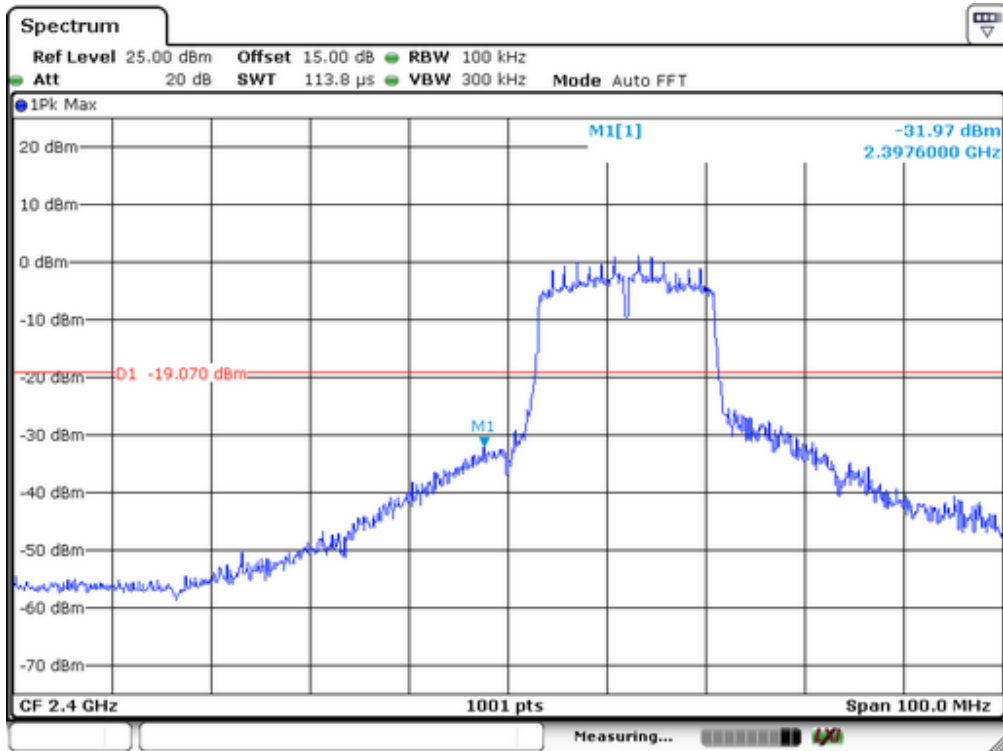

Lowest Channel

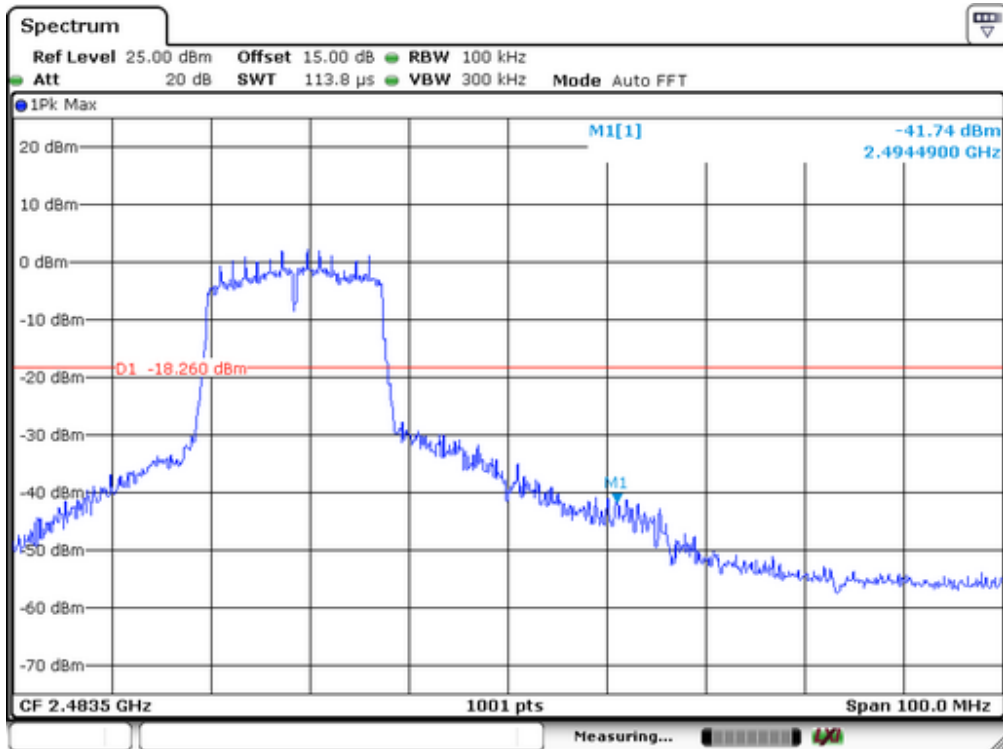

Highest Channel

Test mode: 802.11n(H40)

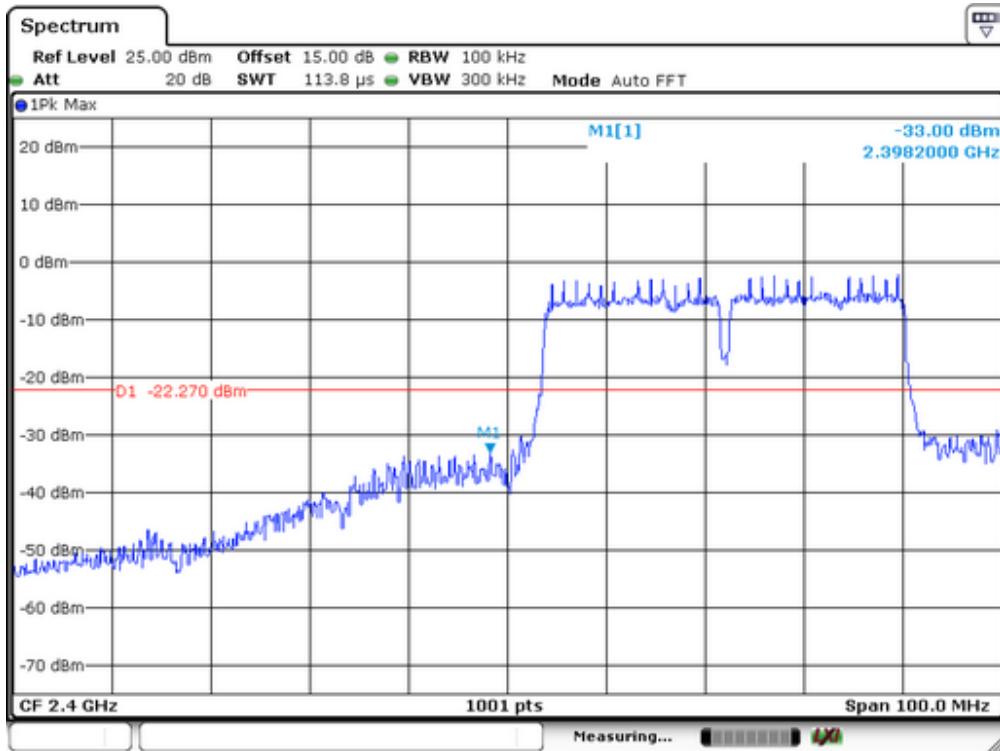

Lowest Channel

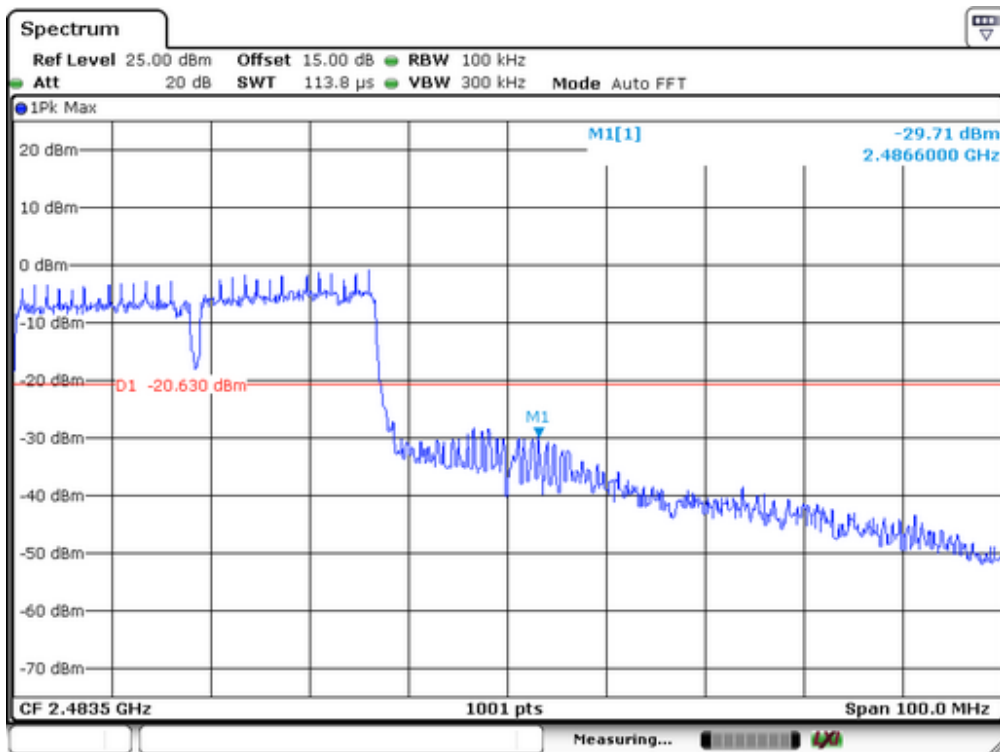

Highest Channel



## 2. Radiated emission Test

Spectrum Detector: PK/AV      Test Date : November 25, 2014  
 Test By: Andy      Temperature : 28 °C  
 Test mode: 802.11b      Humidity : 65 %

Frequency (MHz)	Antenna polarization (H/V)	Emission (dBuV/m)		Band edge Limit (dBuV/m)		Margin (dB)	
		PK	AV	PK	AV	PK	AV
<2400	H	65.34	45.12	74.00	54.00	-8.66	-8.88
<2400	V	59.82	40.76	74.00	54.00	-14.18	-13.24
>2483.5	H	64.95	44.79	74.00	54.00	-9.05	-9.21
>2483.5	V	60.37	40.26	74.00	54.00	-13.63	-13.74

Spectrum Detector: PK/AV      Test Date : November 25, 2014  
 Test By: Andy      Temperature : 28 °C  
 Test mode: 802.11g      Humidity : 65 %

Frequency (MHz)	Antenna polarization (H/V)	Emission (dBuV/m)		Band edge Limit (dBuV/m)		Margin (dB)	
		PK	AV	PK	AV	PK	AV
<2400	H	65.93	45.86	74.00	54.00	-8.07	-8.14
<2400	V	58.41	40.08	74.00	54.00	-15.59	-13.92
>2483.5	H	64.75	45.56	74.00	54.00	-9.25	-8.44
>2483.5	V	60.39	40.87	74.00	54.00	-13.61	-13.13

Spectrum Detector: PK/AV      Test Date : November 25, 2014  
 Test By: Andy      Temperature : 28 °C  
 Test mode: 802.11n(H20)      Humidity : 65 %

Frequency (MHz)	Antenna polarization (H/V)	Emission (dBuV/m)		Band edge Limit (dBuV/m)		Margin (dB)	
		PK	AV	PK	AV	PK	AV
<2400	H	63.89	43.22	74.00	54.00	-10.11	-10.78
<2400	V	55.21	39.66	74.00	54.00	-18.79	-14.34
>2483.5	H	64.29	45.27	74.00	54.00	-9.71	-8.73
>2483.5	V	58.19	40.24	74.00	54.00	-15.81	-13.76

Spectrum Detector: PK/AV                      Test Date : November 25, 2014  
 Test By: Andy                                      Temperature : 28 °C  
 Test mode: 802.11n(H40)                      Humidity : 65 %

Frequency (MHz)	Antenna polarization (H/V)	Emission (dBuV/m)		Band edge Limit (dBuV/m)		Margin (dB)	
		PK	AV	PK	AV	PK	AV
<2400	H	66.47	46.52	74.00	54.00	-7.53	-7.48
<2400	V	60.34	40.11	74.00	54.00	-13.66	-13.89
>2483.5	H	65.82	45.84	74.00	54.00	-8.18	-8.16
>2483.5	V	58.94	39.65	74.00	54.00	-15.06	-14.35

## 10. Power Density

### 10.1 Test Equipment

EQUIPMENT TYPE	MFR	MODEL NUMBER	SERIAL NUMBER	LAST CAL.	CAL DUE.
Spectrum Analyzer	Agilent	FSV30	1321.3008K	05/16/2014	05/15/2015

### 10.2 Measuring Instruments and Setting

The following table is the setting of spectrum analyzer.

Spectrum analyzer	Setting
Attenuation	Auto
Span Frequency	Set the span to 1.5 times the DTS bandwidth.
RB	100KHz
VB	300KHz
Detector	Peak
Trace	Max hold
Sweep Time	Automatic

### 10.3 Test Procedures

- The transmitter output (antenna port) was connected to the spectrum analyzer.
- Set analyzer center frequency to DTS channel center frequency.
- Set the analyzer span to a minimum of 1.5 times the DTS bandwidth.
- Set the RBW=100KHz. Set the VBW=300KHz
- Detector = peak.
- Sweep time = auto couple.
- Trace mode = max hold.
- Allow trace to fully stabilize.
- Use the peak marker function to determine the maximum amplitude level.

### 10.4 Block Diagram of Test Setup

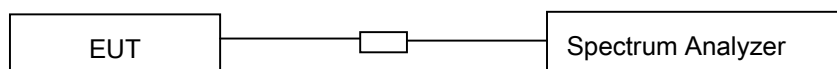

### 10.5 Limit

The transmitted power density averaged over any 1 second interval shall not be greater +8dBm in any 3 kHz bandwidth.

### 10.6 Test Result

Spectrum Detector:	PK	Test Date :	November 25, 2014
Test By:	Andy	Temperature :	28°C
Test Mode:	802.11b	Humidity :	60%

Channel frequency (MHz)	Measurement level (dBm/3KHz)	Limit(dBm/3KHz)	Result
2412	-7.52	8	Pass
2437	-6.70		
2462	-6.99		

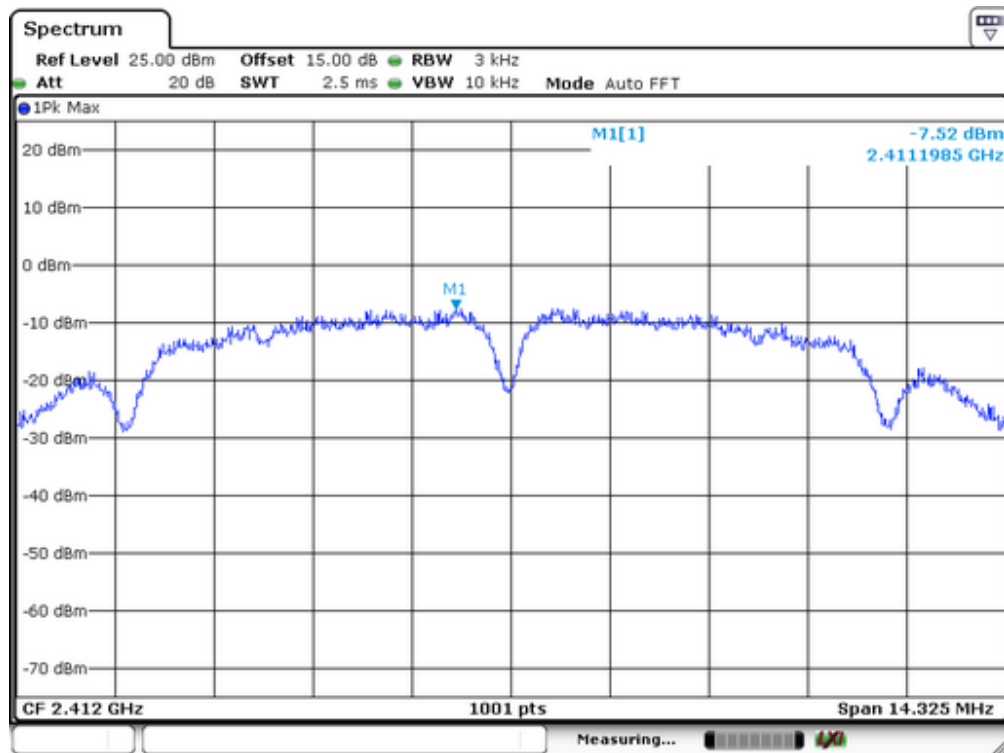

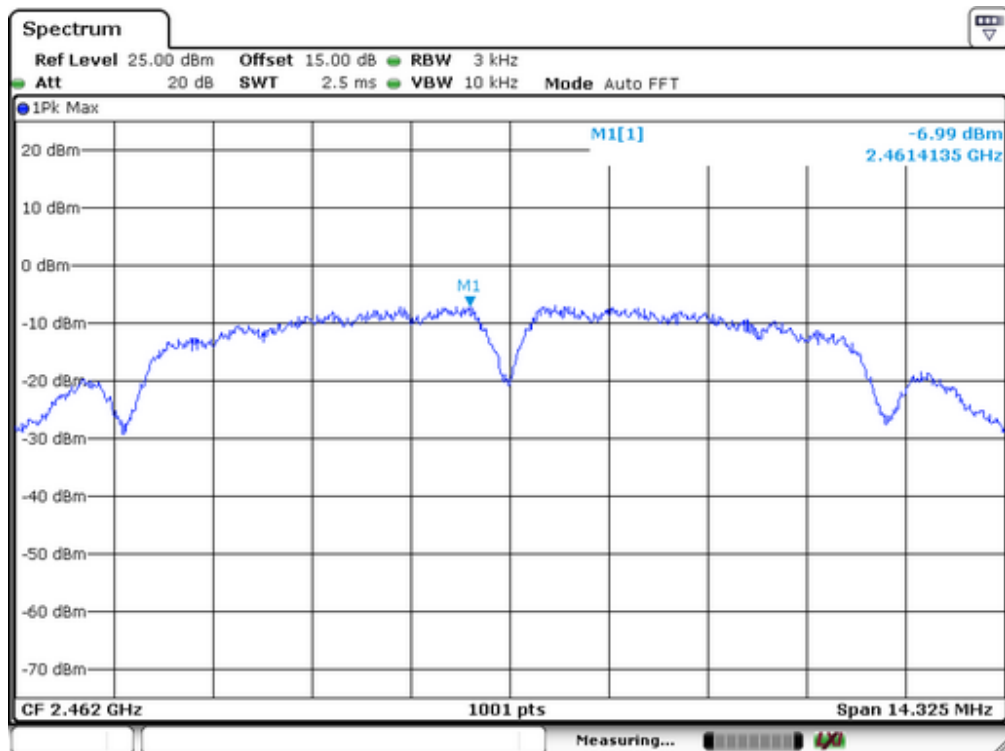
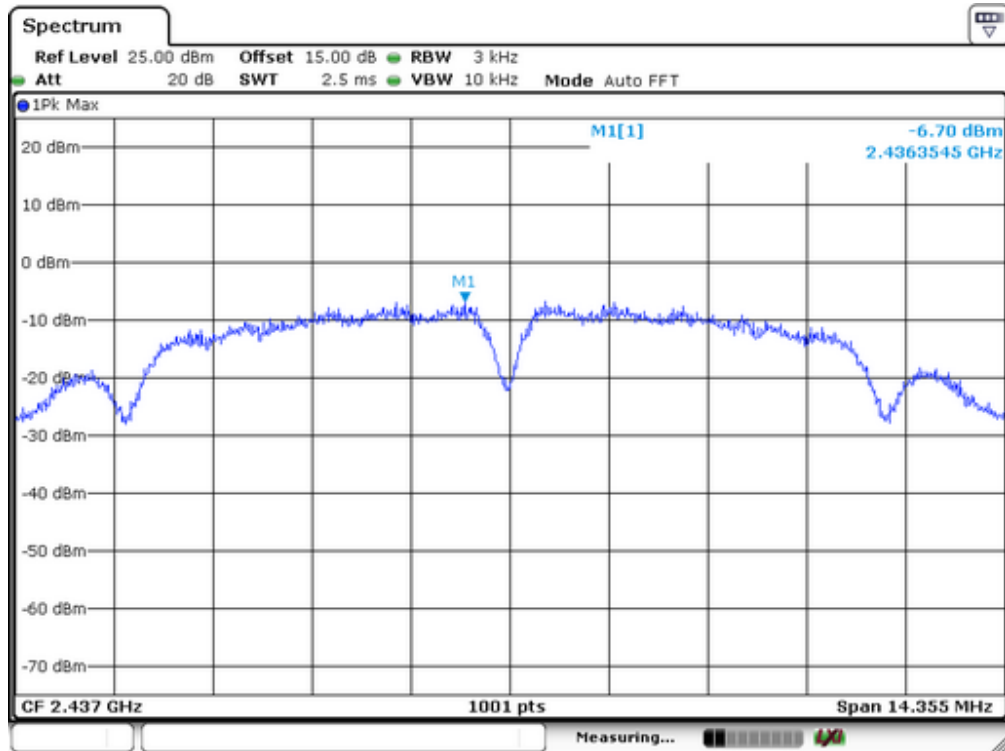

Spectrum Detector: PK Test Date : November 25, 2014  
 Test By: Andy Temperature : 28°C  
 Test Mode: 802.11g Humidity : 60%

Channel frequency (MHz)	Measurement level (dBm/3KHz)	Limit(dBm/3KHz)	Result
2412	-11.75	8	Pass
2437	-10.58		
2462	-9.97		

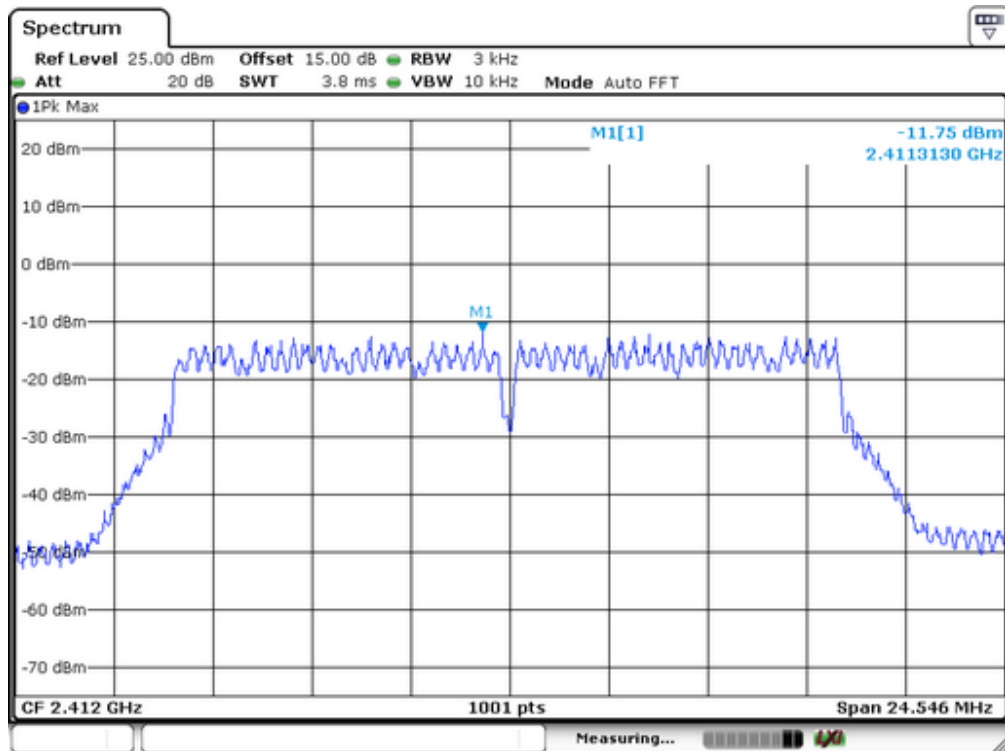

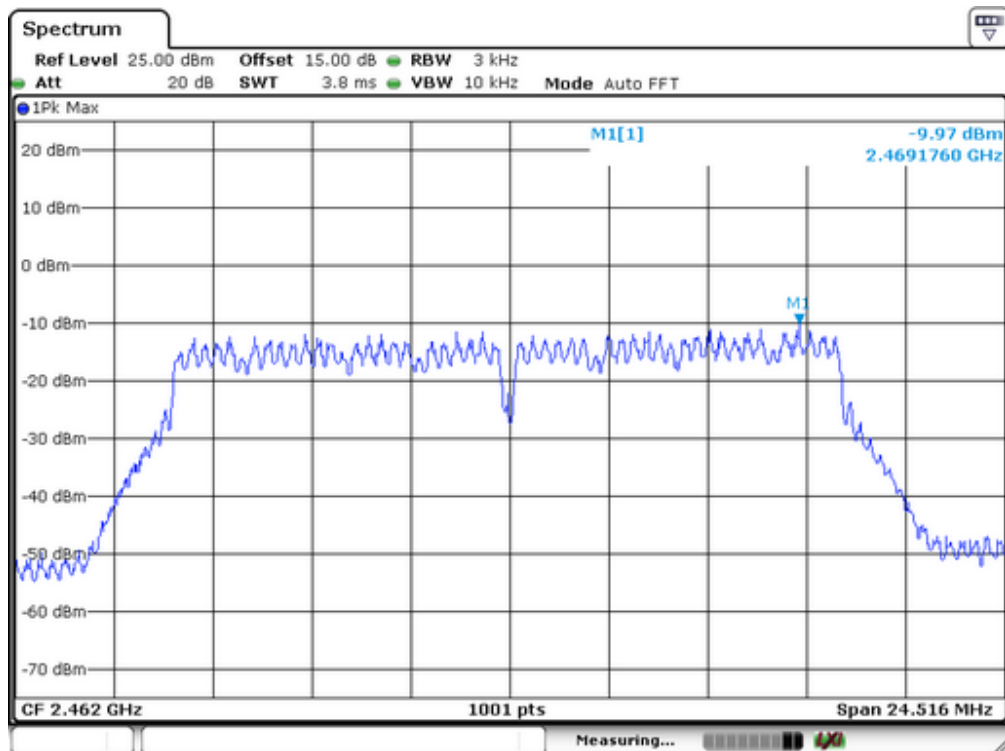
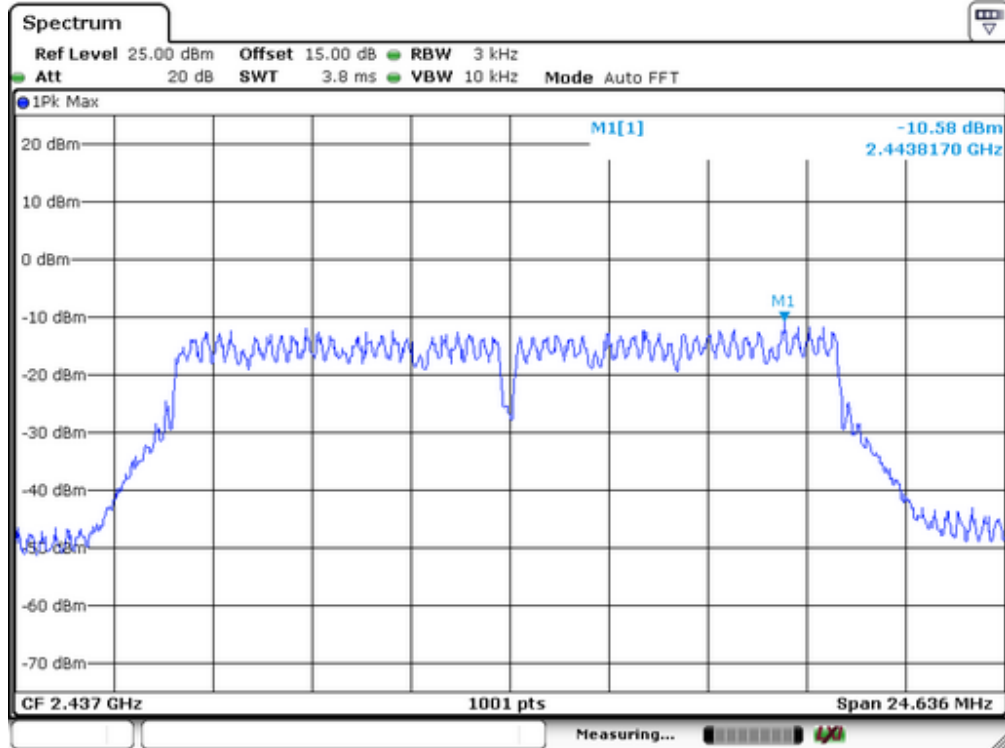

Spectrum Detector: PK                      Test Date : November 25, 2014  
 Test By: Andy                              Temperature : 28°C  
 Test Mode: 802.11n(H20)                  Humidity : 60%

Channel frequency (MHz)	Measurement level (dBm/3KHz)	Limit(dBm/3KHz)	Result
2412	-11.64	8	Pass
2437	-11.28		
2462	-11.62		

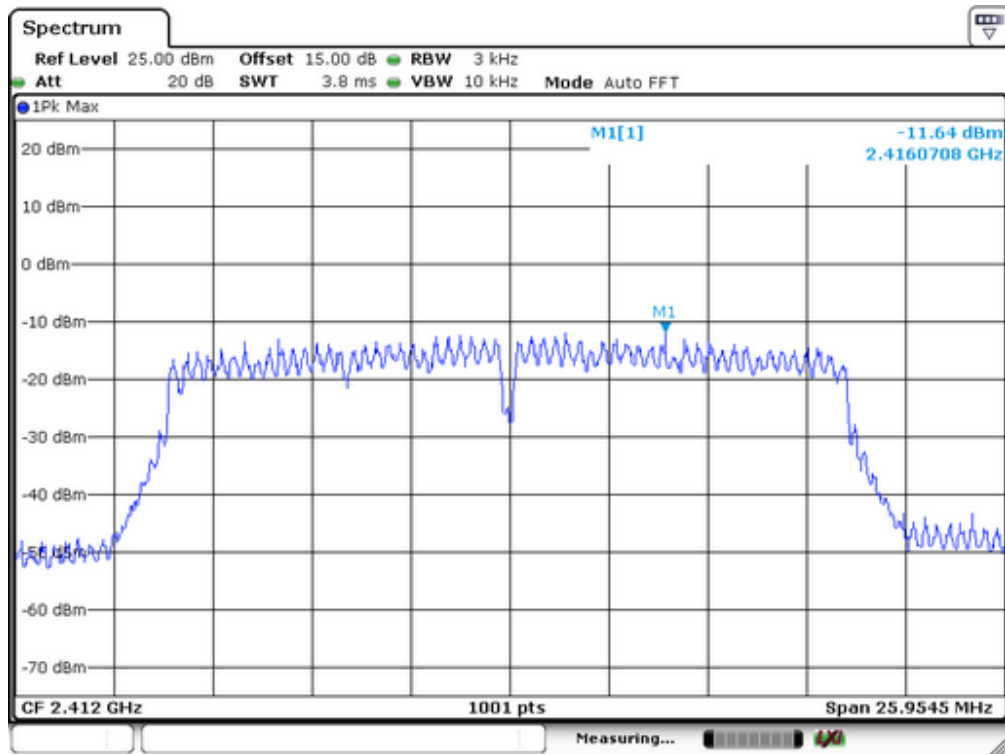



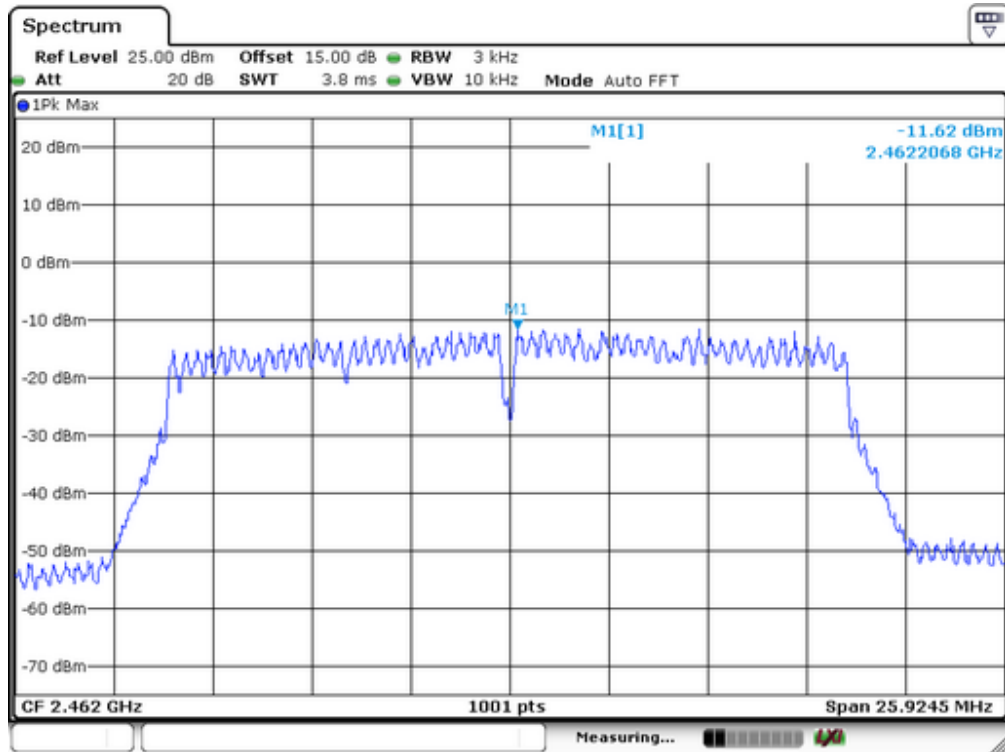
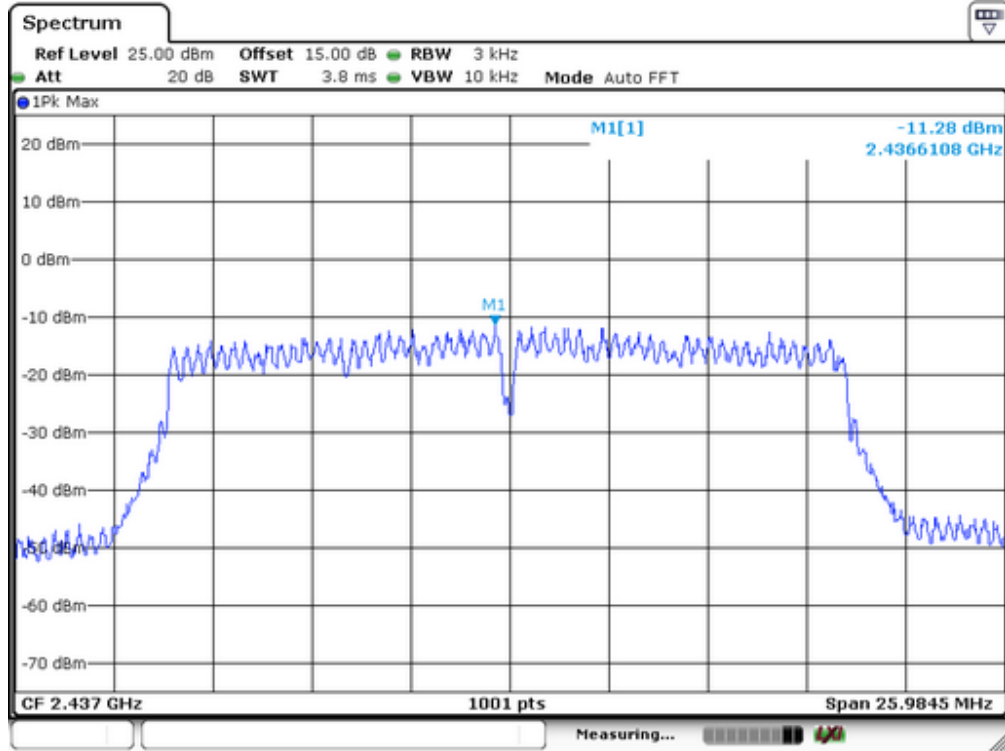

Spectrum Detector: PK                      Test Date : November 25, 2014  
 Test By: Andy                              Temperature : 28°C  
 Test Mode: 802.11n(H40)                  Humidity : 60%

Channel frequency (MHz)	Measurement level (dBm/3KHz)	Limit(dBm/3KHz)	Result
2422	-14.72	8	Pass
2437	-14.71		
2452	-13.93		

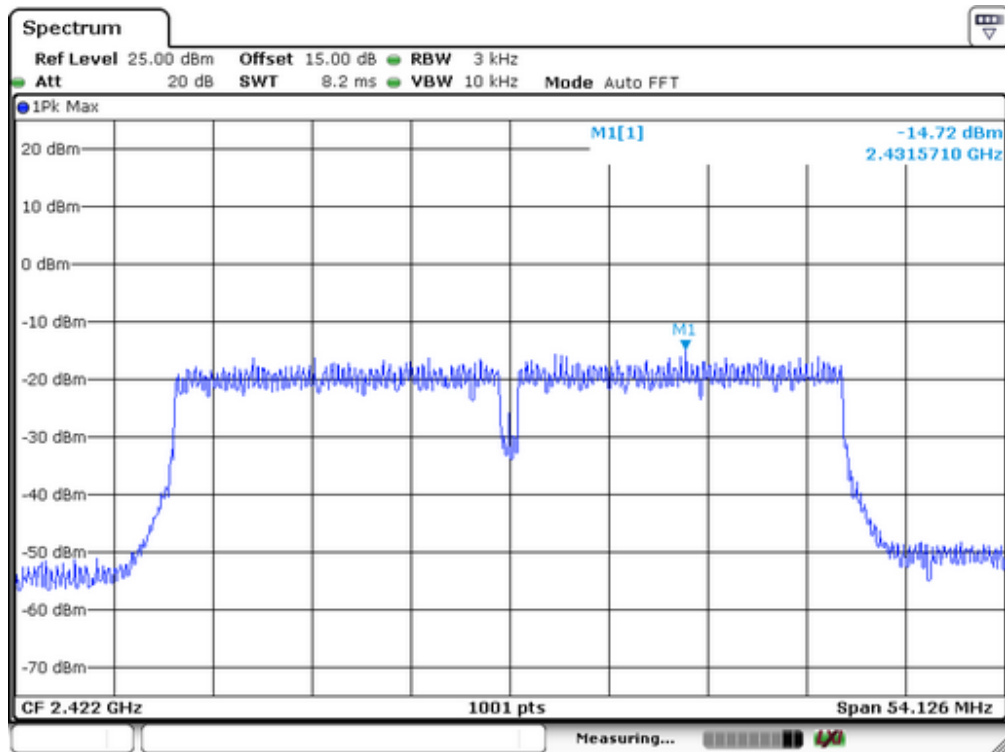

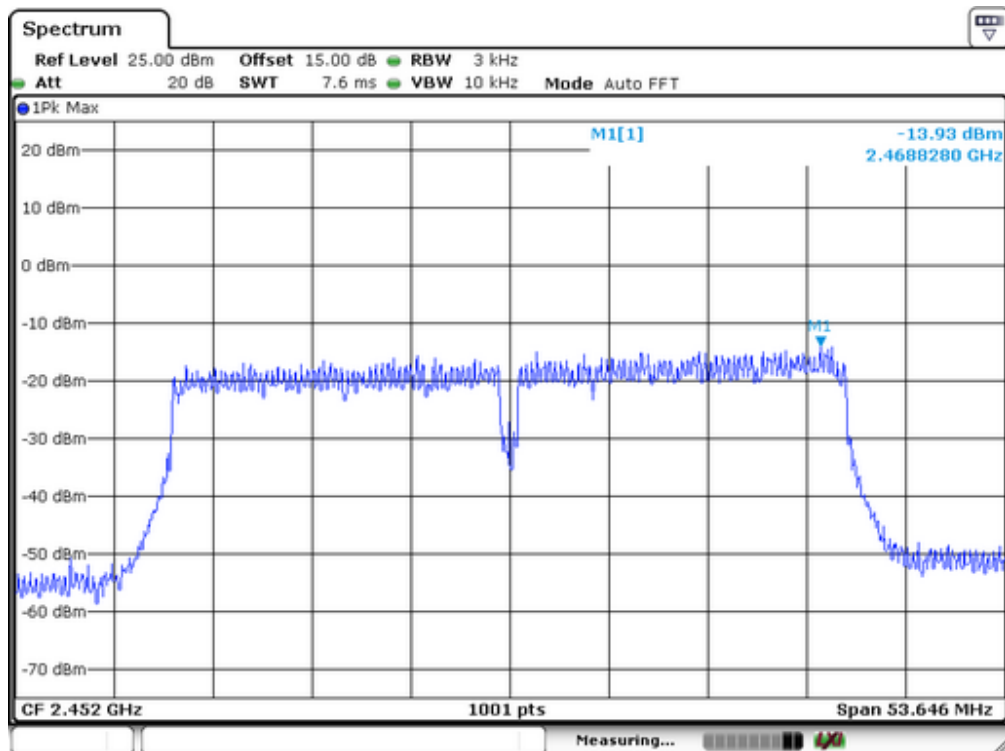
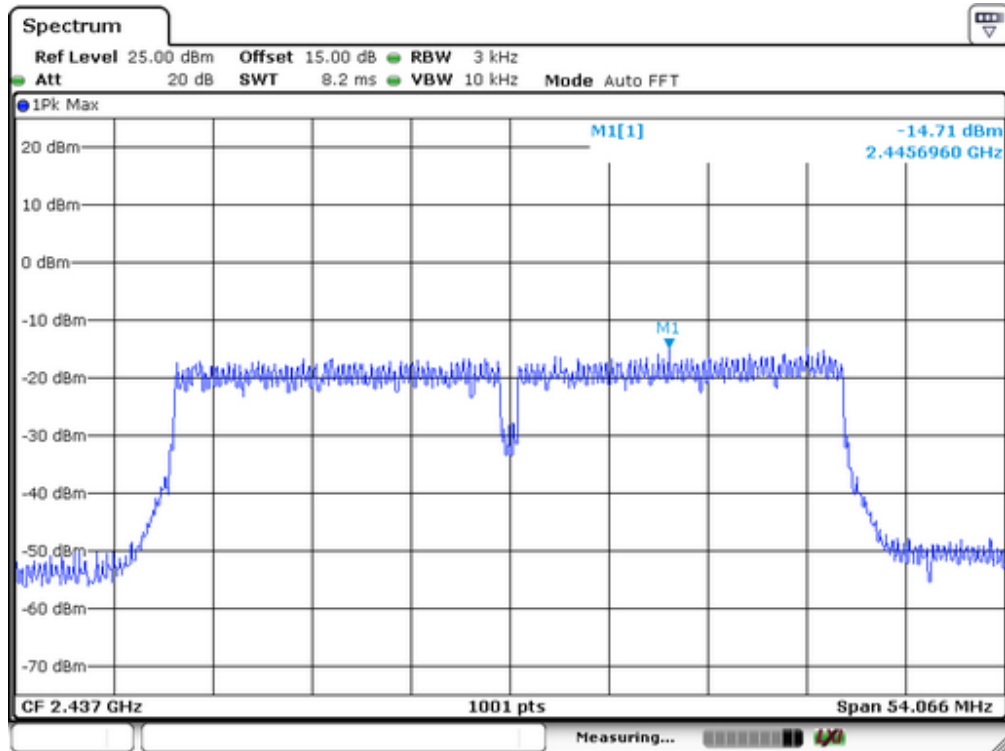

## 11. Antenna Port Emission

### 11.1 Test Equipment

EQUIPMENT TYPE	MFR	MODEL NUMBER	SERIAL NUMBER	LAST CAL.	CAL DUE.
Spectrum Analyzer	Agilent	FSV30	1321.3008K	05/16/2014	05/15/2015

### 11.2 Measuring Instruments and Setting

The following table is the setting of spectrum analyzer.

Spectrum analyzer	Setting
Attenuation	Auto
RB	100kHz
VB	300kHz
Detector	Peak
Trace	Max hold

### 11.3 Test Procedures

The conducted spurious emissions were measured conducted using a spectrum analyzer at low, Middle, and high channels, the limit was determined by attenuation 20dB of the RF peak power output.

### 11.4 Block Diagram of Test setup

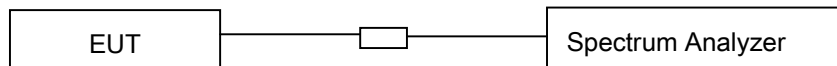

### 11.5 Test Result

**PASS.**

Test Mode: 802.11b

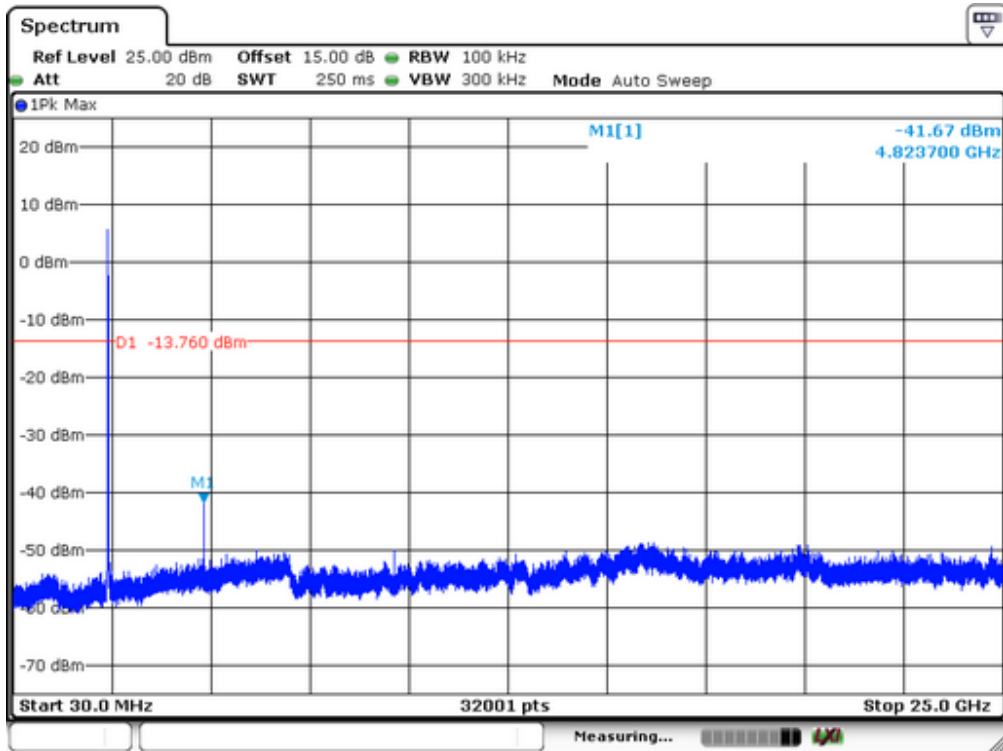

Lowest Channel

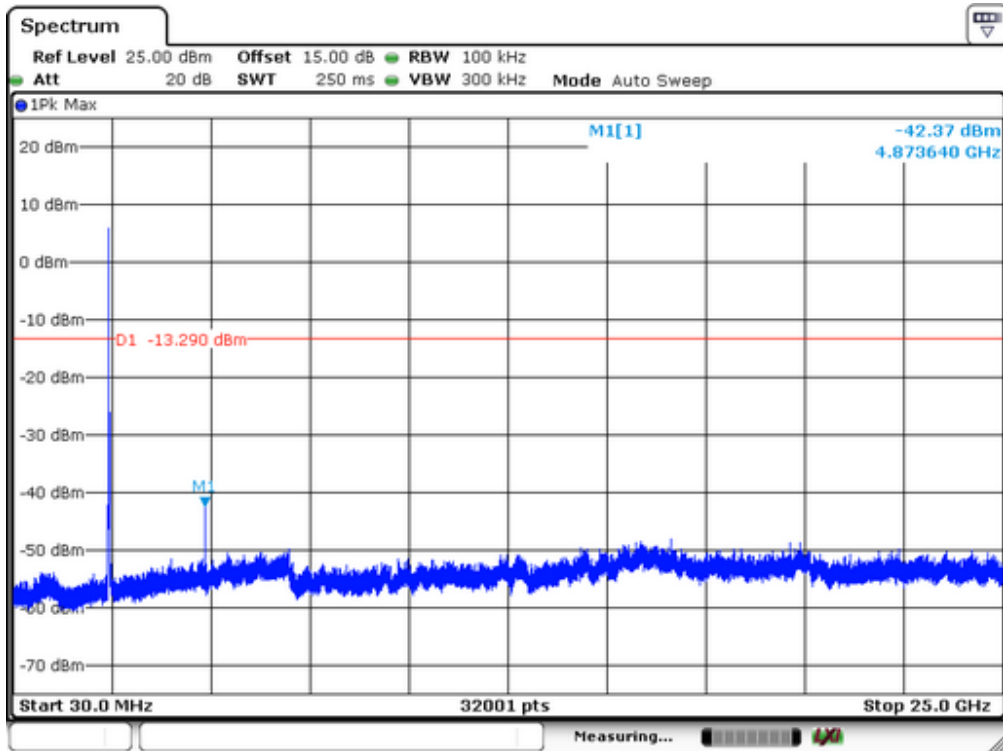

Middel Channel

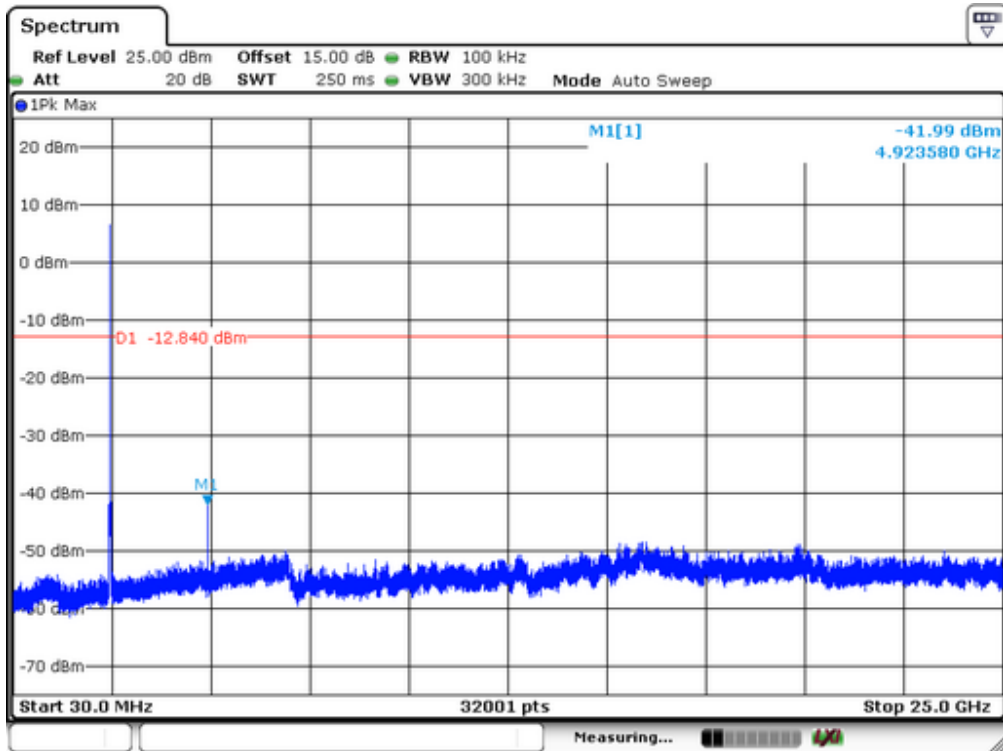

Highest Channel

Test Mode: 802.11g

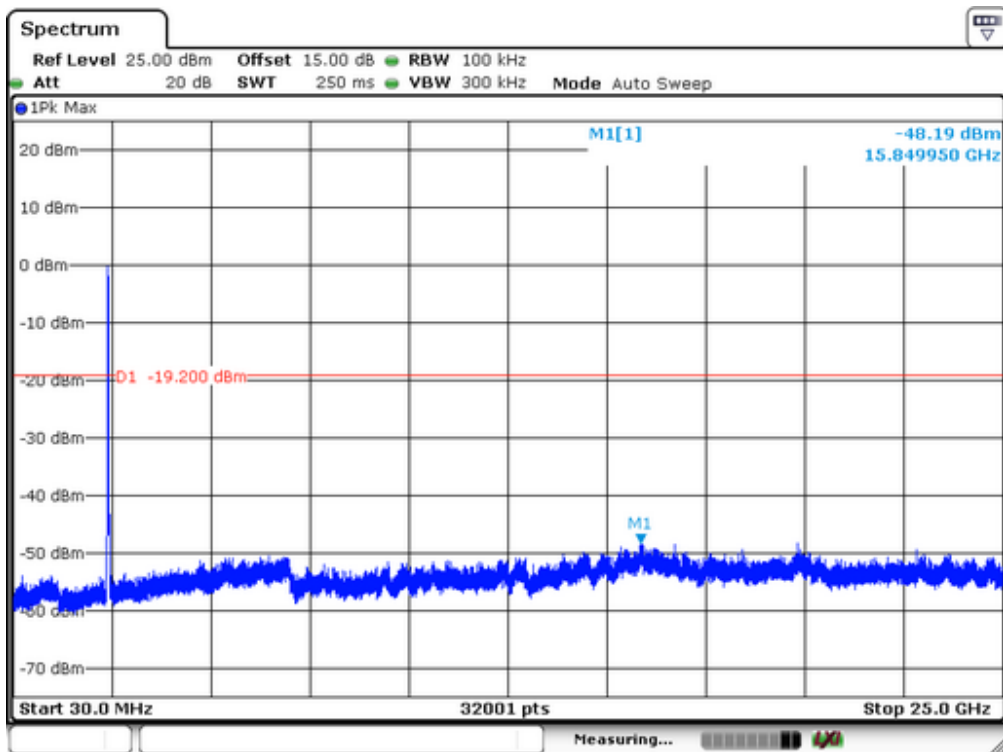

Lowest Channel

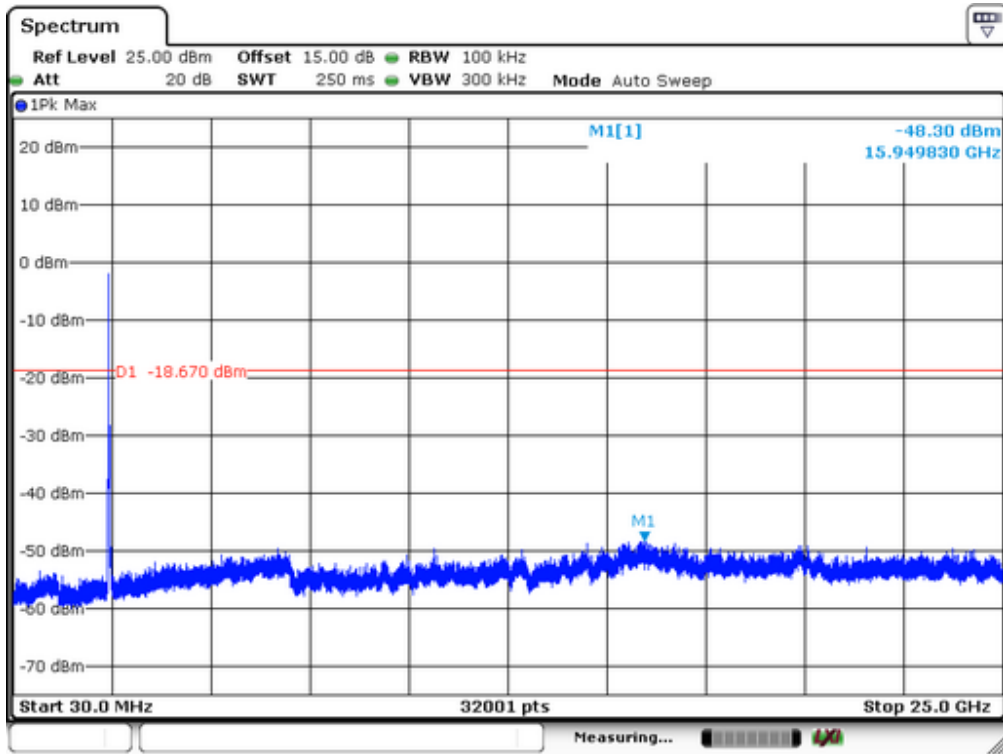

Middle Channel

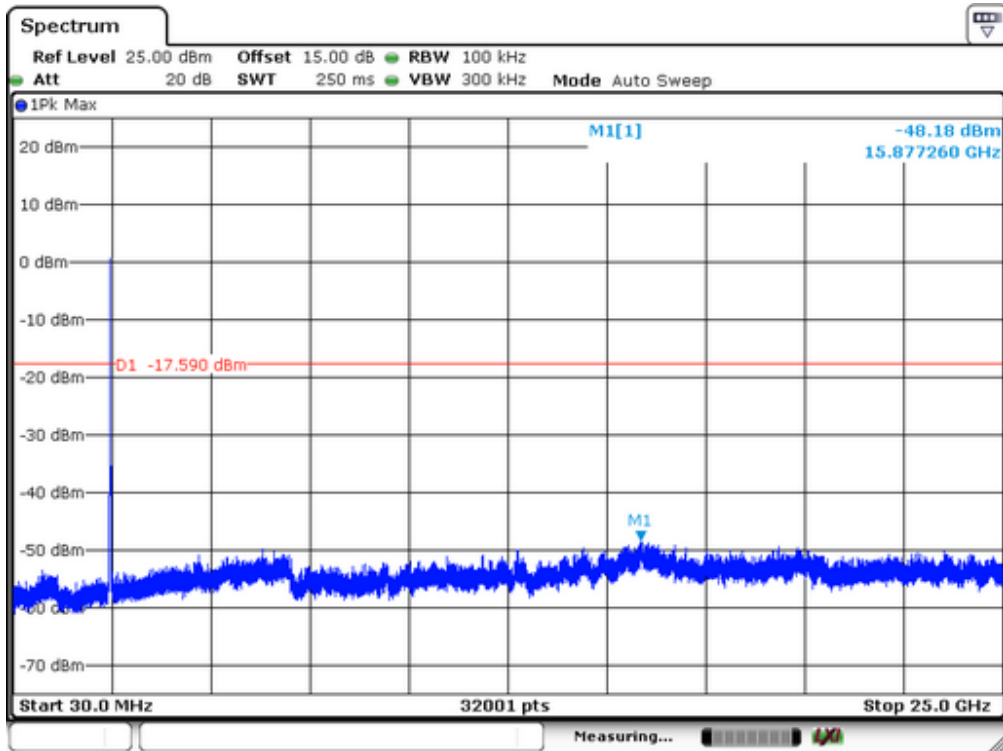

Highest Channel

Test Mode: 802.11n(H20)

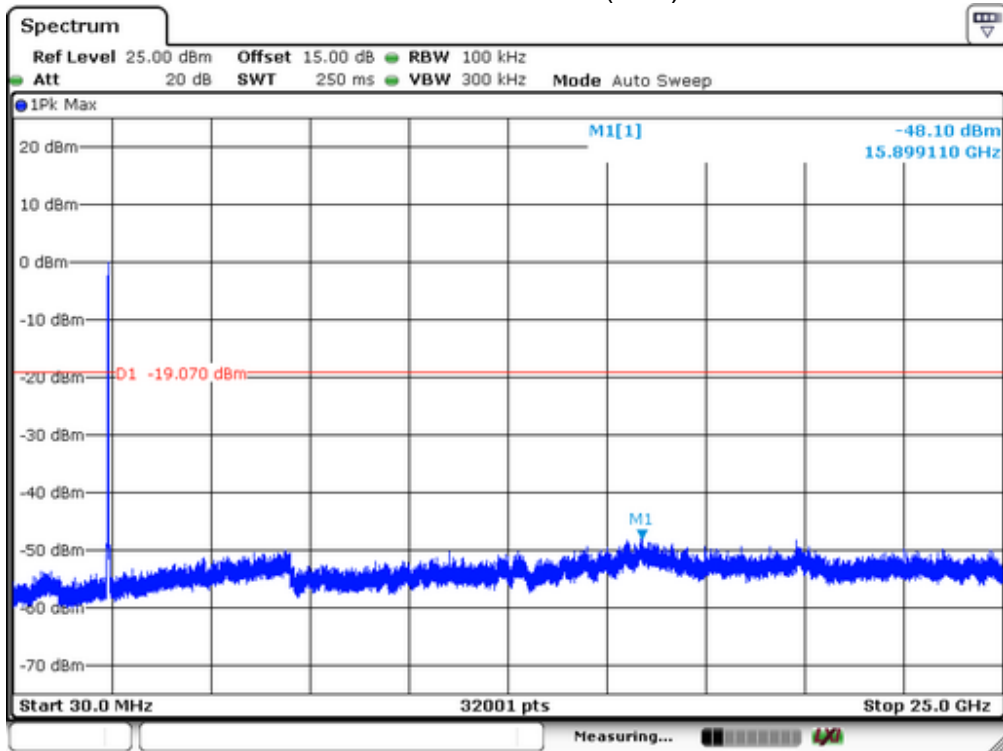

Lowest Channel

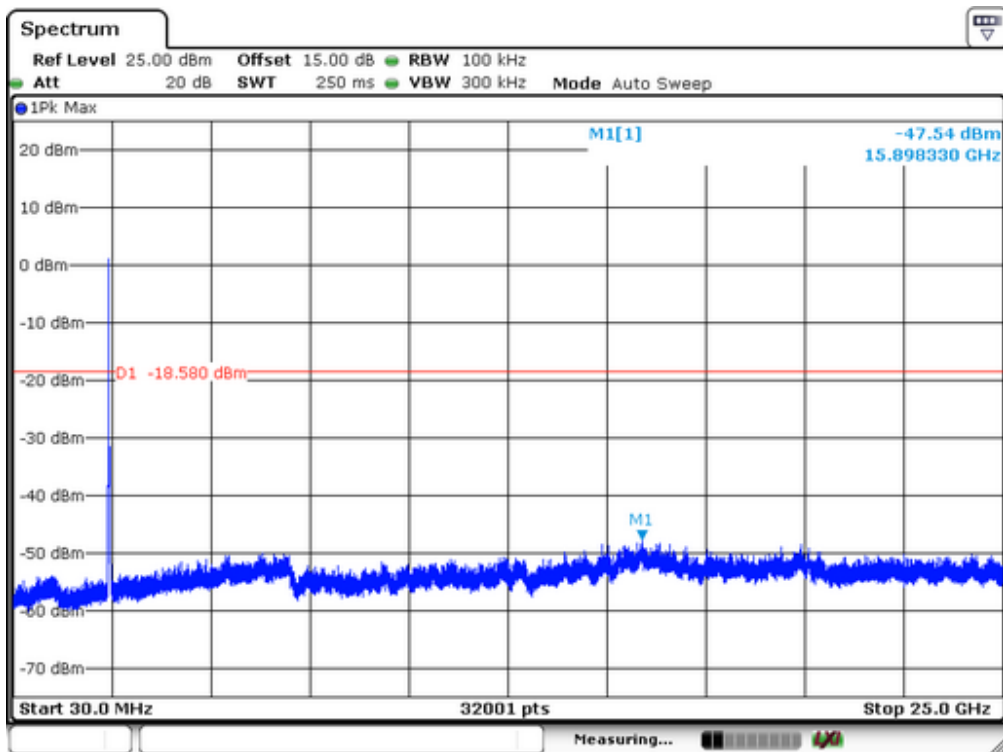

Middle Channel



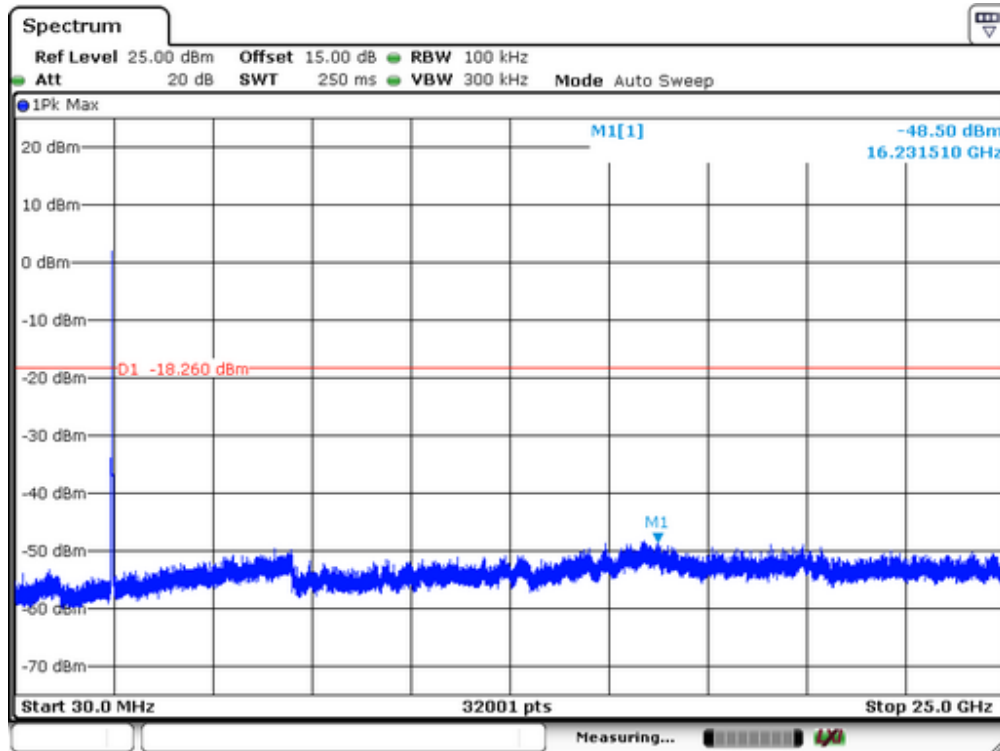

Highest Channel

Test Mode: 802.11n(H40)

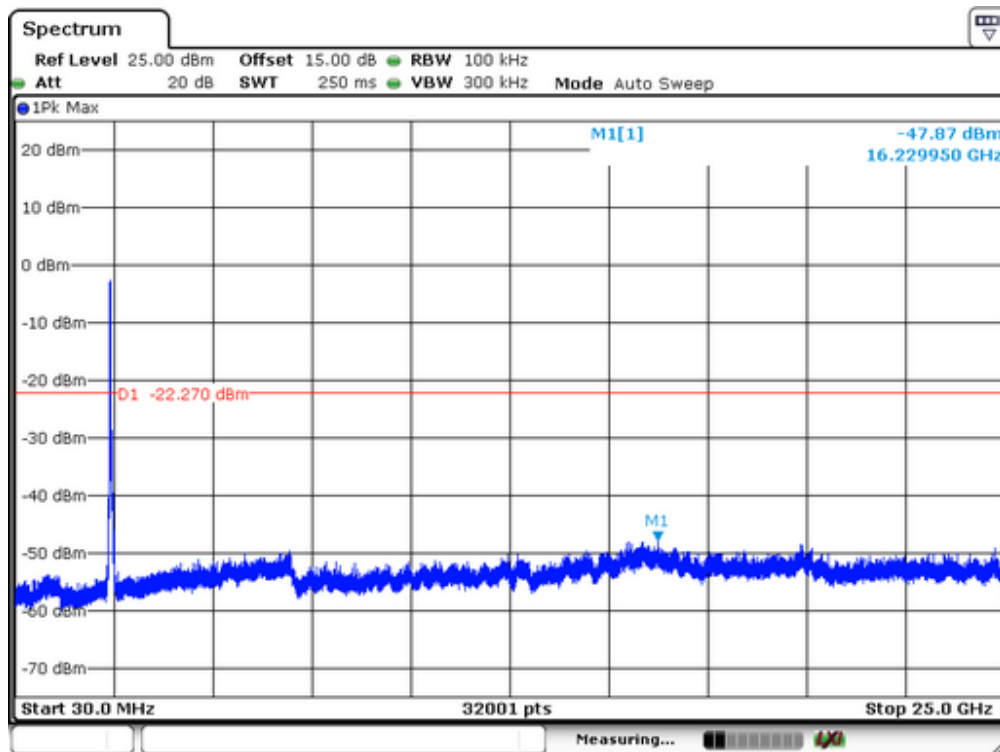

Lowest Channel

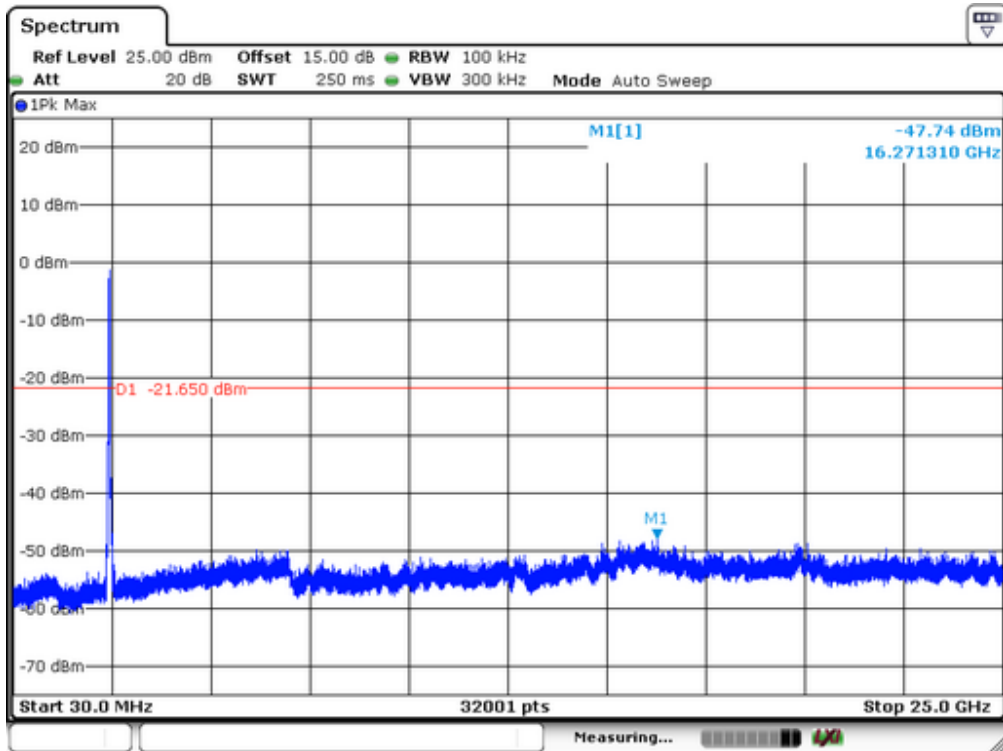

Middle Channel

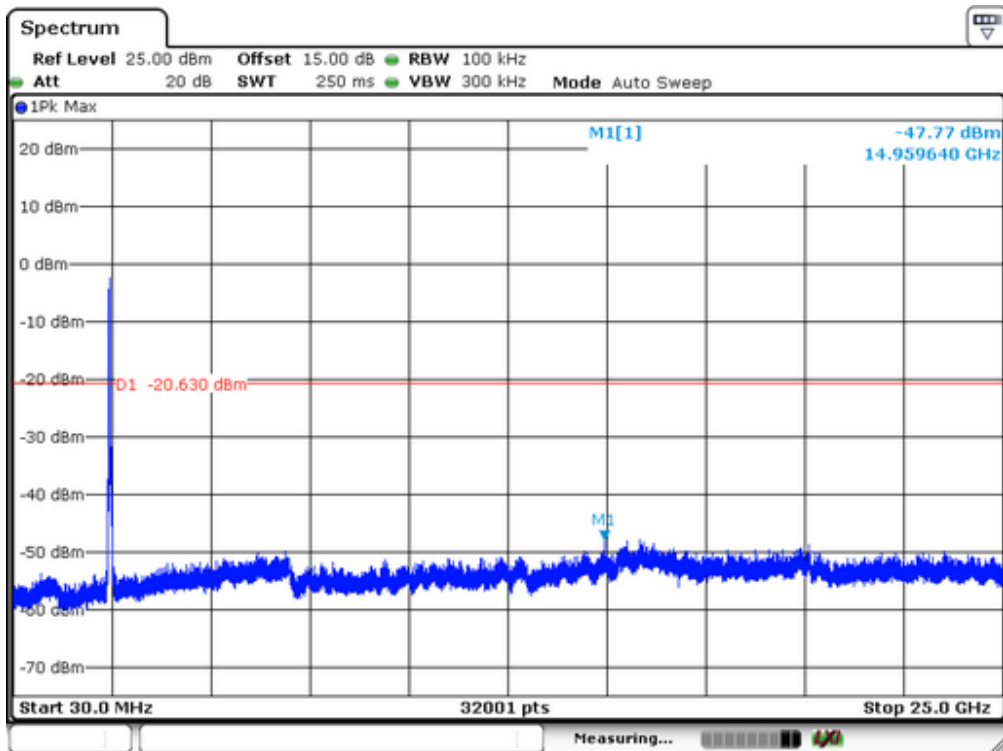

Highest Channel

## **12. Antenna Application**

### **12.1 Antenna Requirement**

For intentional device, according to FCC 47 CFR Section 15.203, an intentional radiator shall be designed to ensure that no antenna other than that furnished by the responsible party shall be used with the device. And according to FCC 47 CFR Section 15.247 (b), if transmitting antennas of directional gain greater than 6dBi are used, the power shall be reduced by the amount in dB that the directional gain of the antenna exceeds 6dBi.

### **12.2 Result**

The EUT'S antenna, permanent attached antenna, is an internal PCB antenna. The antenna's gain is 2.18 dBi and meets the requirement.

# APPENDIX I (PHOTOS OF EUT)





