

FCC PART 15C TEST REPORT FOR CERTIFICATION
On Behalf of

Jiangmen Dascom Computer Peripherals Co.,Ltd.

Card Printer

Model Number: DC-2300, KT-200

Additional Model: DC-2350, DC-240, DC-250

FCC ID: Z7OKT200



Applicant :	Jiangmen Dascom Computer Peripherals Co.,Ltd.
Address:	No.399, Jin Xing Road, Jiang Hai District, Jiangmen City,
	Guang Dong Province, P.R. China
Prepared By:	EST Technology Co., Ltd.
	Chilingxiang, Qishantou, Santun, Houjie, Dongguan, Guangdong, China
	Tel: 86-769-83081888-808

Report Number:	ESTE-R2306087
Date of Test:	May. 05~Jun. 11, 2023
Date of Report:	Jun. 19, 2023

TABLE OF CONTENTS

Description	Page
TEST REPORT VERIFICATION.....	3
1. GENERAL INFORMATION.....	4
1.1. Description of Device (EUT).....	4
1.2. Antenna Information.....	4
1.3. Information of RF Cable.....	4
2. SUMMARY OF TEST.....	5
2.1. Summary of test result.....	5
2.2. Test Facilities.....	6
2.3. Measurement uncertainty.....	7
2.4. Assistant equipment used for test.....	7
2.5. Block Diagram.....	7
2.6. Test mode.....	8
2.7. Channel List.....	8
2.8. Test Equipment.....	9
3. AC POWER LINE CONDUCTED EMISSIONS.....	10
3.1. Limit.....	10
3.2. Test Setup.....	10
3.3. Spectrum Analyzer Setting.....	10
3.4. Test Procedure.....	10
3.5. Test Result.....	11
4. RADIATED EMISSION.....	15
4.1. Limit.....	15
4.2. Test Setup.....	16
4.3. Spectrum Analyzer Setting.....	17
4.4. Test Procedure.....	17
4.5. Test Result.....	18
5. FREQUENCY TOLERANCE.....	32
5.1. Limit.....	32
5.2. Test Setup.....	32
5.3. Spectrum Analyzer Setting.....	32
5.4. Test Procedure.....	33
5.5. Test Result.....	34
6. 20DB BANDWIDTH&99% OCCUPIED BANDWIDTH.....	36
6.1. Limit.....	36
6.2. Test Setup.....	36
6.3. Spectrum Analyzer Setting.....	36
6.4. Test Procedure.....	37
6.5. Test Result.....	38
7. ANTENNA REQUIREMENTS.....	39
7.1. Limit.....	39
7.2. Test Result.....	39
8. TEST SETUP PHOTO.....	40
9. EUT PHOTO.....	44

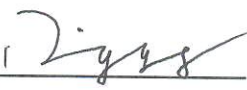
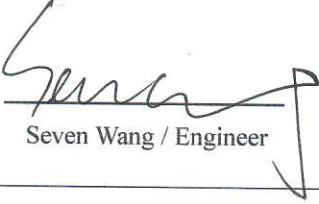
EST Technology Co., Ltd.

Applicant:	Jiangmen Dascom Computer Peripherals Co.,Ltd.		
Address:	No.399, Jin Xing Road, Jiang Hai District, Jiangmen City, Guang Dong Province, P.R. China		
Manufacturer:	Jiangmen Dascom Computer Peripherals Co.,Ltd.		
Address:	No.399, Jin Xing Road, Jiang Hai District, Jiangmen City, Guang Dong Province, P.R. China		
Factory:	Jiangmen Dascom Computer Peripherals Co.,Ltd.		
Address:	No.399, Jin Xing Road, Jiang Hai District, Jiangmen City, Guang Dong Province, P.R. China		
E.U.T:	Card Printer		
Model Number:	DC-2300, KT-200		
Additional Model:	DC-2350, DC-240, DC-250 Note: The model DC-2300, DC-2350, DC-240, DC-250, KT-200 are the same in hardware aspect. The difference in model number serves as marketing strategy. The product have two different optional shells. But the hardware aspect and the circuit schematic and PCB diagram are the same.		
Power Supply:	DC 24V From Adapter Input AC 120V/60Hz		
Trade Name:	TALLY/DASCOM, DASCOM, PRINTEK	Serial No.:	-----
Date of Receipt:	May. 05, 2023	Date of Test:	May. 05~Jun. 11, 2023
Test Specification:	FCC Part 15 Subpart C (15.225) ANSI C63.10:2013		
Test Result:	<p>The device described above is tested by EST Technology Co., Ltd. The measurement results were contained in this test report and EST Technology Co., Ltd. was assumed full responsibility for the accuracy and completeness of these measurements. Also, this report shows that the EUT to be technically compliance with the FCC Rules and Regulations Part 15 Subpart C requirements.</p> <p style="text-align: center;">This report applies to above tested sample only and shall not be reproduced in part without written approval of EST Technology Co., Ltd.</p>		
Prepared by:	Reviewed by:	Date: Jun. 19, 2023	
 _____ Ring Yang / Assistant	 _____ Seven Wang / Engineer	Approved by:  _____ Iceman Hu / Manager	
Other Aspects:	None.		
Abbreviations: OK/P=passed fail/F=failed n.a/N=not applicable E.U.T=equipment under tested			
This test report is based on a single evaluation of one sample of above mentioned products ,It is not permitted to be duplicated in extracts without written approval of EST Technology Co., Ltd.			

1. GENERAL INFORMATION

1.1. Description of Device (EUT)

Product Name	:	Card Printer
Model Number	:	DC-2300, KT-200
Software Version	:	N/A
Hardware Version	:	N/A
Operation frequency	:	13.56MHz
Number of channel	:	1
Modulation Type	:	ASK
Sample Type	:	Prototype production

Note: For a more detailed features description, please refer to the manufacturer's specifications or the user's manual.

1.2. Antenna Information

Ant No.	Brand	Model Name	Antenna Type	Connector	Gain (dBi)
1	-	75011567	PCB	-	0
2		7501137e	PCB		0

Note: With two antennas working simultaneously, This information is provided by the applicant.

1.3. Information of RF Cable

Cable Loss(dB)	Provided by
1.0	Jiangmen Dascom Computer Peripherals Co.,Ltd.

Note: 1. The customer declared the loss value of the RF Cable, and the test results of this report only apply to the sample as received.
2. This information is provided by the applicant.

2. SUMMARY OF TEST

2.1. Summary of test result

No.	Description of Test Item	FCC Standard Section	Results
1	AC Power Line Conducted Emissions	15.207	PASS
2	Radiated Emission	15.225(a)(b)(c)(d)	PASS
3	Frequency Tolerance	15.225(e)	PASS
4	20dB Bandwidth&99% Occupied Bandwidth	15.215	PASS
5	Antenna Requirement	15.203	PASS

Note: "N/A" denotes test is not applicable in this test report.

2.2. Test Facilities

EMC Lab : Certificated by CNAS, CHINA
Registration No.: L5288
This Certificate is valid until: November 12, 2023

Certificated by FCC, USA
Designation Number: CN1215
This Certificate is valid until: January 31, 2024

Certificated by A2LA, USA
Registration No.: 4366.01
This Certificate is valid until: January 31, 2024

Certificated by Industry Canada
CAB identifier No.: CN0035
This Certificate is valid until: January 31, 2024

Certificated by VCCI, Japan
Registration No.:C-14103; T-20073; R-13663;
R-20103; G-20097
Date of registration: Apr. 20, 2020
This Certificate is valid until: Apr. 19, 2023

Certificated by TUV Rheinland, Germany
Registration No.: UA 50413872 0001
Date of registration: July 31, 2018

Certificated by Intertek
Registration No.: 2011-RTL-L2-64
Date of registration: November 08, 2018

Name of Firm : EST Technology Co., Ltd.

Site Location : Chilingxiang, Qishantou, Santun, Houjie, Dongguan,
Guangdong, China

2.3. Measurement uncertainty

Test Item	Uncertainty
Uncertainty for Conduction emission test	±3.48dB
Uncertainty for spurious emissions test (Below 30MHz)	±1.62 dB
Uncertainty for spurious emissions test (30MHz-1GHz)	±4.60 dB(Polarize: H)
	±4.68 dB(Polarize: V)
Uncertainty for spurious emissions test (1GHz to 18GHz)	±4.96dB
Uncertainty for radio frequency	7×10^{-8}
Uncertainty for conducted RF Power	1.08dB
Uncertainty for Power density test	0.26dB

Note: This uncertainty represents an expanded uncertainty expressed at approximately the 95% confidence level using a coverage factor of k=2.

2.4. Assistant equipment used for test

Item	Equipment	Brand	Model Name/Type No.	FCC ID	Series No.
A	Adapter	-	SAWA-55-25024B	-	-

Item	Shielded Type	Ferrite Core	Length	Note
1	NO	NO	1.8m	AC Cable
2	NO	NO	1.2m	DC Cable

2.5. Block Diagram

For radiated emissions test: EUT was placed on a turn table, which is 0.8 (or 1.5) meter high above ground.

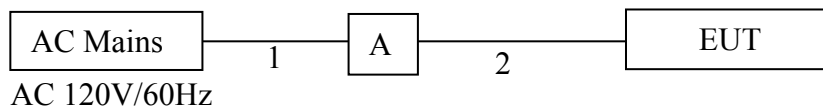

Note: Internal add two optional mainboard Photo for all models. The circuit schematic and PCB diagram of the two optional mainboard are the same, the difference is only that I/O interface are different installation way. Internal add two optional mainboard Photo for all models, all were tested and only a worse case was reported.

(EUT: Card Printer)

2.6. Test mode

The final test as listed below.

Test Item	Modulation Type	Operating Mode
AC Power Line Conducted Emissions	ASK	TX Mode
Radiated Emission	ASK	TX Mode
Frequency Tolerance	ASK	TX Mode
20dB Bandwidth&99% Occupied Bandwidth	ASK	TX Mode

Note: In radiated measurement, the EUT had been pre-scan on the positioned of each 3 axis(X, Y, Z), the worst case was found when positioned on **X-plane**.

2.7. Channel List

Channel No.	Frequency (MHz)
1	13.56

2.8. Test Equipment

For conducted emission test						
Equipment	Manufacturer	Model No.	Serial No.	Calibration Body	Last Cal.	Next Cal.
EMI Test Receiver	Rohde & Schwarz	ESHS30	EST-E001	LISAI	June 13,22	1 Year
Artificial Mains Network	Rohde & Schwarz	ENV216	EST-E002	LISAI	June 13,22	1 Year
Pulse Limiter	Rohde & Schwarz	ESH3-Z2	EST-E078	LISAI	June 13,22	1 Year
Test Software	Audix	e3-6.111221a	N/A	N/A	N/A	N/A

For radiated emission test(9kHz-30MHz)						
Equipment	Manufacturer	Model No.	Serial No.	Calibration Body	Last Cal.	Next Cal.
EMI Test Receiver	Rohde & Schwarz	ESR7	EST-E047	LISAI	June 13,22	1 Year
Active Loop Antenna	SCHWARZB ECK	FMZB 1519B	EST-E054	LISAI	June 13,22	1 Year
Test Software	Audix	e3-6.111221a	N/A	N/A	N/A	N/A
9kHz-30MHz Cable	N/A	EST-001	N/A	N/A	N/A	N/A

For radiated emission test(Above 1000MHz)						
Equipment	Manufacturer	Model No.	Serial No.	Calibration Body	Last Cal.	Next Cal.
Horn Antenna	SCHWARZB ECK	BBHA9120D	EST-E144	LISAI	June 13,22	1 Year
Horn Antenna	Com-Power	AHA-840	EST-E133	LISAI	June 13,22	1 Year
Low Noise Amplifier	RF	TRLA-01018 0G45N	EST-E142	LISAI	June 13,22	1 Year
Spectrum Analyzer	Rohde &Schwarz	FSV40	EST-E069	LISAI	June 13,22	1 Year
Test Software	Audix	e3-6.111221a	N/A	N/A	N/A	N/A
Above 1GHz Cable	N/A	EST-003	N/A	N/A	N/A	N/A

For connect EUT antenna terminal test						
Equipment	Manufacturer	Model No.	Serial No.	Calibration Body	Last Cal.	Next Cal.
TS 1120	Tonscend	/	/	/	/	/
Test Software	Tonscend	TS1120-3	3.2.11	/	/	/
RF Control Unit	Tonscend	JS0806-2	EST-E134	LISAI	June 13,22	1 Year
Signal and Spectrum Analyzer	Rohde &Schwarz	FSV 40	EST-E136	LISAI	June 13,22	1 Year

3. AC POWER LINE CONDUCTED EMISSIONS

3.1. Limit

Frequency	Maximum RF Line Voltage	
	Quasi-Peak Level dB(μV)	Average Level dB(μV)
150kHz ~ 500kHz	66 ~ 56*	56 ~ 46*
500kHz ~ 5MHz	56	46
5MHz ~ 30MHz	60	50

Note:

1. * Decreasing linearly with logarithm of frequency.
2. The lower limit shall apply at the transition frequencies.

3.2. Test Setup

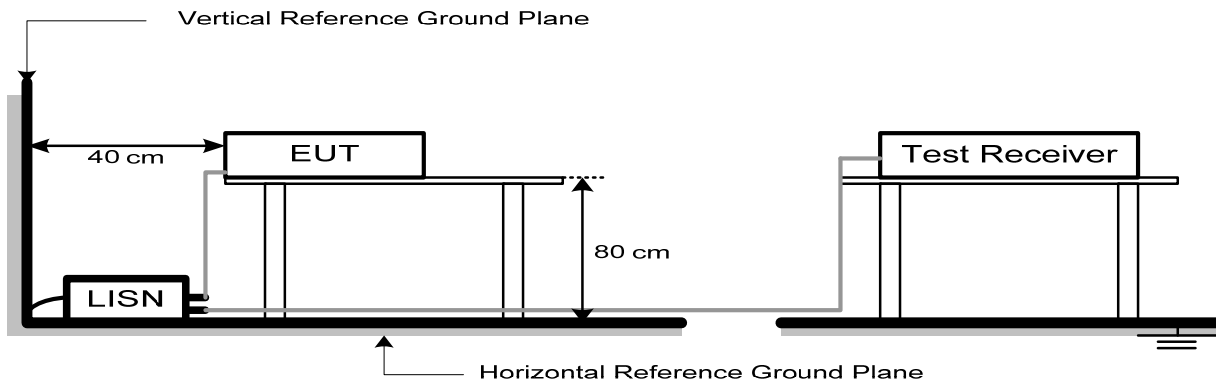

3.3. Spectrum Analyzer Setting

Spectrum Parameters	Setting
RBW	9KHz
VBW	9KHz
Start frequency	150KHz
Stop frequency	30MHz
Sweep Time	Auto
Detector	QP/AVG
Trace Mode	Max Hold

3.4. Test Procedure

- a. The EUT was placed on a non-metallic table, 80cm above the ground plane.
- b. The EUT Power connected to the power mains through a line impedance stabilization network.
- c. Provides a 50 ohm coupling impedance for the EUT (Please refer the block diagram of the test setup and photographs).
- d. Set the EUT transmit continuously with maximum output power.
- e. Spectrum analyzer setting parameters in accordance with section 3.3.
- f. The AC line are checked to find out the maximum conducted emission. In order to find the maximum emission levels, the relative positions of equipment and all of the interface cables shall be changed according to ANSI C63.10: 2013 on Conducted Emission Test.
- g. Record the results in the test report.

3.5. Test Result

EST Technology

Chilingxiang, Qishantou, Santun,
Houjie, Dongguan, Guangdong, China
Tel: +86-769-83081888
Fax: +86-769-83081878

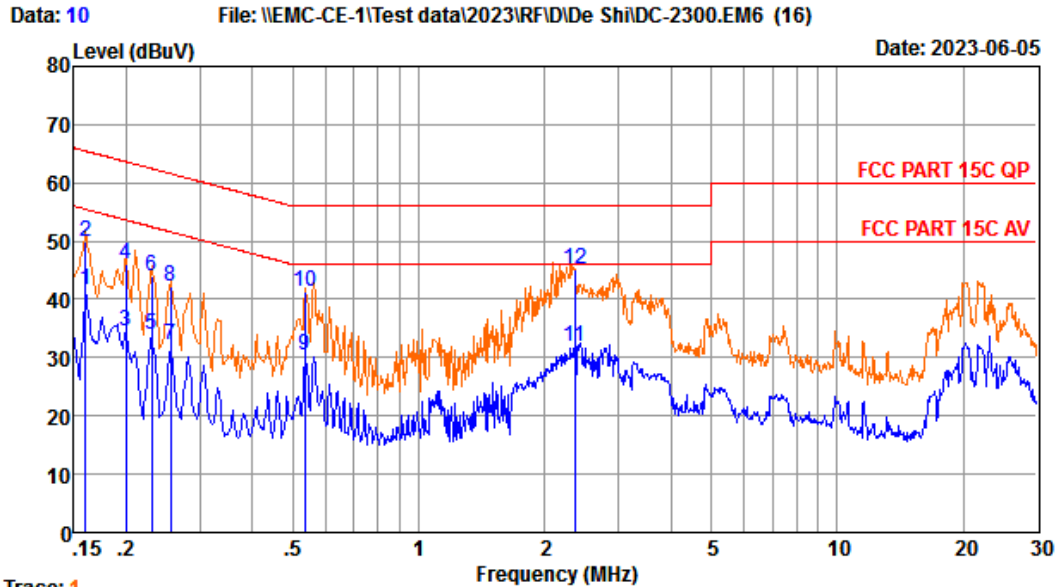

Trace: 1
 Site no : 1#CE Shield Room Data no. : 10
 Env. / Ins. : Temp:24.1'C Humi:43% Press:100.80kPa LINE Phase : NEUTRAL
 Limit : FCC PART 15C QP
 Engineer : MRS
 EUT : Card Printer
 Power : DC 24V From Adapter Input AC 120V/60Hz
 M/N : KT-200
 Test Mode : Working

	Freq. (MHz)	LISN Factor (db)	Cable Loss (db)	Reading dBuV	Emission Level (dBuV)	Limits (dBuV)	Margin (dB)	Remark
1	0.160	10.14	9.69	21.90	41.73	55.47	13.74	Average
2	0.160	10.14	9.69	29.99	49.82	65.47	15.65	QP
3	0.200	10.37	9.77	14.49	34.63	53.62	18.99	Average
4	0.200	10.37	9.77	25.98	46.12	63.62	17.50	QP
5	0.230	10.31	9.84	13.83	33.98	52.44	18.46	Average
6	0.230	10.31	9.84	23.98	44.13	62.44	18.31	QP
7	0.255	10.24	9.92	11.88	32.04	51.60	19.56	Average
8	0.255	10.24	9.92	22.14	42.30	61.60	19.30	QP
9	0.535	9.83	9.92	10.51	30.26	46.00	15.74	Average
10	0.535	9.83	9.92	21.59	41.34	56.00	14.66	QP
11	2.358	9.80	9.96	12.22	31.98	46.00	14.02	Average
12	2.358	9.80	9.96	25.29	45.05	56.00	10.95	QP

Remarks: 1. Emission Level= LISN Factor + Cable Loss + Reading.
 2. Margin= Limit - Emission Level.
 3. If the average limit is met when using a quasi-peak detector, the EUT shall be deemed to meet both limits and measurement with average detector is unnecessary.

Data: 12 File: \\EMC-CE-1\Test data\2023\RFID\De Shi\DC-2300.EM6 (16) Date: 2023-06-05

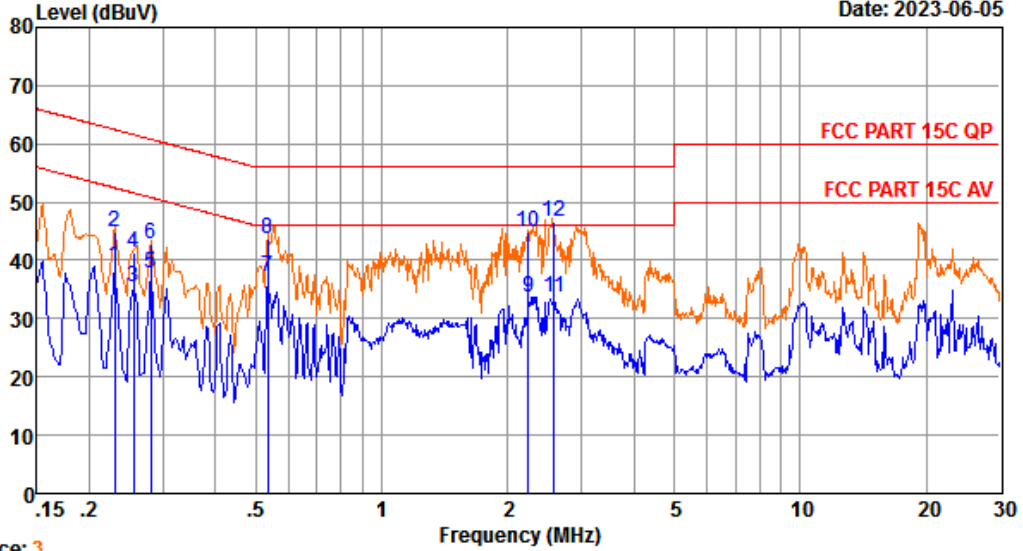

Trace: 3
 Site no : 1#CE Shield Room Data no. : 12
 Env. / Ins. : Temp:24.1'C Humi:43% Press:100.80kPa LINE Phase : LINE
 Limit : FCC PART 15C QP
 Engineer : MRS
 EUT : Card Printer
 Power : DC 24V From Adapter Input AC 120V/60Hz
 M/N : KT-200
 Test Mode : Working

	Freq. (MHz)	LISN Factor (db)	Cable Loss (db)	Reading (dBuV)	Emission Level (dBuV)	Limits (dBuV)	Margin (dB)	Remark
1	0.230	9.91	9.84	19.16	38.91	52.44	13.53	Average
2	0.230	9.91	9.84	25.17	44.92	62.44	17.52	QP
3	0.255	9.94	9.92	15.66	35.52	51.60	16.08	Average
4	0.255	9.94	9.92	21.59	41.45	61.60	20.15	QP
5	0.280	9.91	9.92	17.84	37.67	50.81	13.14	Average
6	0.280	9.91	9.92	22.96	42.79	60.81	18.02	QP
7	0.535	9.90	9.92	17.26	37.08	46.00	8.92	Average
8	0.535	9.90	9.92	23.98	43.80	56.00	12.20	QP
9	2.237	9.77	9.96	14.03	33.76	46.00	12.24	Average
10	2.237	9.77	9.96	25.19	44.92	56.00	11.08	QP
11	2.581	9.74	9.97	14.03	33.74	46.00	12.26	Average
12	2.581	9.74	9.97	26.96	46.67	56.00	9.33	QP

Remarks: 1. Emission Level= LISN Factor + Cable Loss + Reading.
 2. Margin= Limit - Emission Level.
 3. If the average limit is met when using a quasi-peak detector, the EUT shall be deemed to meet both limits and measurement with average detector is unnecessary.

Data: 14 File: \\EMC-CE-1\Test data\2023\RFID\De Shi\DC-2300.EM6 (16) Date: 2023-06-05

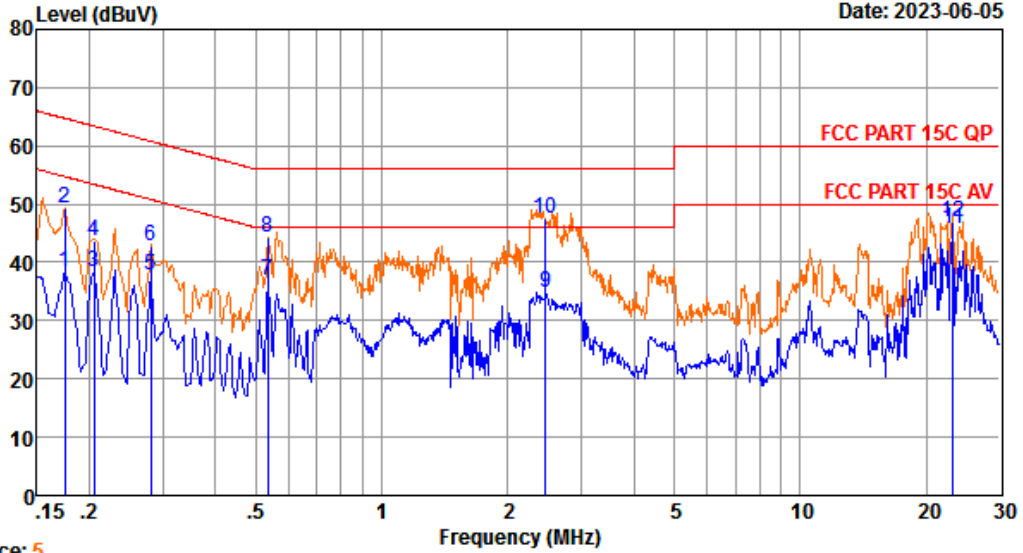

Trace: 5
 Site no : 1#CE Shield Room Data no. : 14
 Env. / Ins. : Temp:24.1'C Humi:43% Press:100.80kPa LINE Phase : LINE
 Limit : FCC PART 15C QP
 Engineer : MRS
 EUT : Card Printer
 Power : DC 24V From Adapter Input AC 120V/60Hz
 M/N : DC-2300
 Test Mode : Working

	Freq. (MHz)	LISN Factor (db)	Cable Loss (db)	Reading (dBuV)	Emission Level (dBuV)	Limits (dBuV)	Margin (dB)	Remark
1	0.175	9.89	9.77	18.83	38.49	54.72	16.23	Average
2	0.175	9.89	9.77	29.65	49.31	64.72	15.41	QP
3	0.205	9.91	9.84	18.71	38.46	53.40	14.94	Average
4	0.205	9.91	9.84	23.95	43.70	63.40	19.70	QP
5	0.280	9.91	9.92	17.84	37.67	50.81	13.14	Average
6	0.280	9.91	9.92	22.98	42.81	60.81	18.00	QP
7	0.535	9.90	9.92	17.21	37.03	46.00	8.97	Average
8	0.535	9.90	9.92	24.51	44.33	56.00	11.67	QP
9	2.461	9.73	9.96	15.24	34.93	46.00	11.07	Average
10	2.461	9.73	9.96	27.98	47.67	56.00	8.33	QP
11	23.140	9.74	10.17	25.88	45.79	50.00	4.21	Average
12	23.140	9.74	10.17	26.97	46.88	60.00	13.12	QP

Remarks: 1. Emission Level= LISN Factor + Cable Loss + Reading.
 2. Margin= Limit - Emission Level.
 3. If the average limit is met when using a quasi-peak detector, the EUT shall be deemed to meet both limits and measurement with average detector is unnecessary.

Data: 16 File: \\EMC-CE-1\Test data\2023\RFID\De Shi\DC-2300.EM6 (16)

Date: 2023-06-05

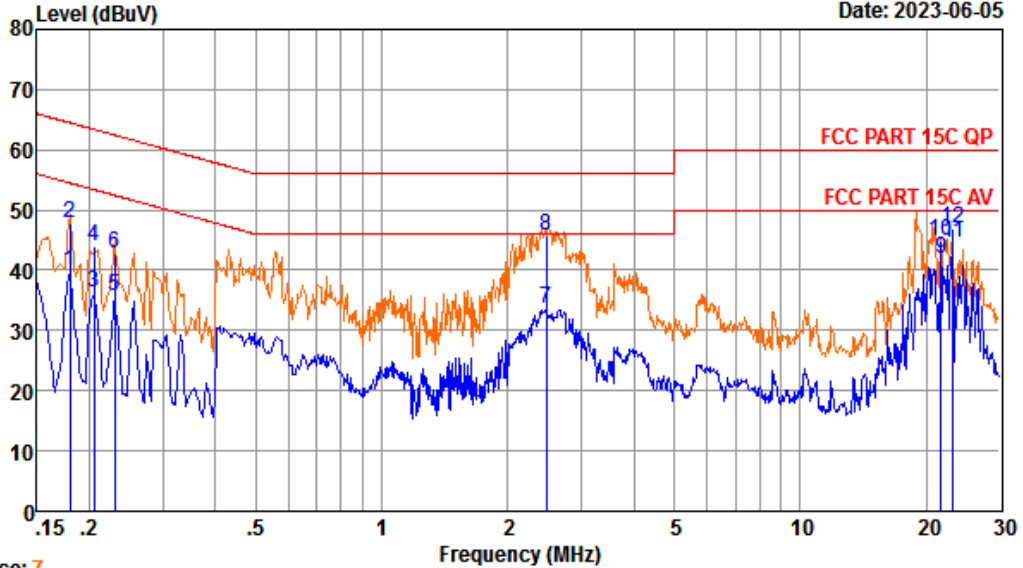

Trace: 7
 Site no : 1#CE Shield Room Data no. : 16
 Env. / Ins. : Temp:24.1'C Humi:43% Press:100.80kPa LINE Phase : NEUTRAL
 Limit : FCC PART 15C QP
 Engineer : MRS
 EUT : Card Printer
 Power : DC 24V From Adapter Input AC 120V/60Hz
 M/N : DC-2300
 Test Mode : Working

	Freq. (MHz)	LISN Factor (db)	Cable Loss (db)	Reading dBuV	Emission Level (dBuV)	Limits (dBuV)	Margin (dB)	Remark
1	0.180	10.37	9.77	19.58	39.72	54.50	14.78	Average
2	0.180	10.37	9.77	27.59	47.73	64.50	16.77	QP
3	0.205	10.31	9.84	16.16	36.31	53.40	17.09	Average
4	0.205	10.31	9.84	23.96	44.11	63.40	19.29	QP
5	0.230	10.31	9.84	15.68	35.83	52.44	16.61	Average
6	0.230	10.31	9.84	22.65	42.80	62.44	19.64	QP
7	2.474	9.81	9.96	13.78	33.55	46.00	12.45	Average
8	2.474	9.81	9.96	25.97	45.74	56.00	10.26	QP
9	21.715	9.80	10.16	21.95	41.91	50.00	8.09	Average
10	21.715	9.80	10.16	24.98	44.94	60.00	15.06	QP
11	23.140	9.75	10.17	24.60	44.52	50.00	5.48	Average
12	23.140	9.75	10.17	27.06	46.98	60.00	13.02	QP

Remarks: 1. Emission Level= LISN Factor + Cable Loss + Reading.
 2. Margin= Limit - Emission Level.
 3. If the average limit is met when using a quasi-peak detector,
 the EUT shall be deemed to meet both limits and measurement
 with average detector is unnecessary.

4. RADIATED EMISSION

4.1. Limit

Frequency (MHz)	Field Strength($\mu\text{V/m}$)	Distance(m)
0.009~ 0.490	2400/F(KHz)	300
0.490~ 1.705	24000/F(KHz)	30
1.705~ 13.110	30	30
13.110 ~ 13.410	106	30
13.410 ~ 13.553	334	30
13.553 ~13.567	15.848	30
13.567 ~ 13.710	334	30
13.710 ~14.010	106	30
14.010~30	30	30
30~ 88	100	3
88~ 216	150	3
216~ 960	200	3
Above 960	500	3

Note:

1. Field Strength ($\text{dB}\mu\text{V/m}$) = $20 \times \log[\text{Field Strength } (\mu\text{V/m})]$.
2. At frequencies below 30 MHz, measurements may be performed at a distance closer than that specified in the regulations; however, an attempt should be made to avoid making measurements in the near field. Pending the development of an appropriate measurement procedure for measurements performed below 30 MHz, when performing measurements at a closer distance than specified, the results shall be extrapolated to the specified distance by either making measurements at a minimum of two distances on at least one radial to determine the proper extrapolation factor or by using the square of an inverse linear distance extrapolation factor (40 dB/decade).

For example: When measurement the frequencies form 13.553MHz to 13.567Mhz at 3m distance, the Limit show in below:

$$\text{Limit}(\text{dB}\mu\text{V/m})@3\text{m} = 20 \times \log(15,848)\text{dB}\mu\text{V/m} + 40 \times \log(30/3)\text{dB} = 124\text{dB}\mu\text{V/m}$$

4.2. Test Setup

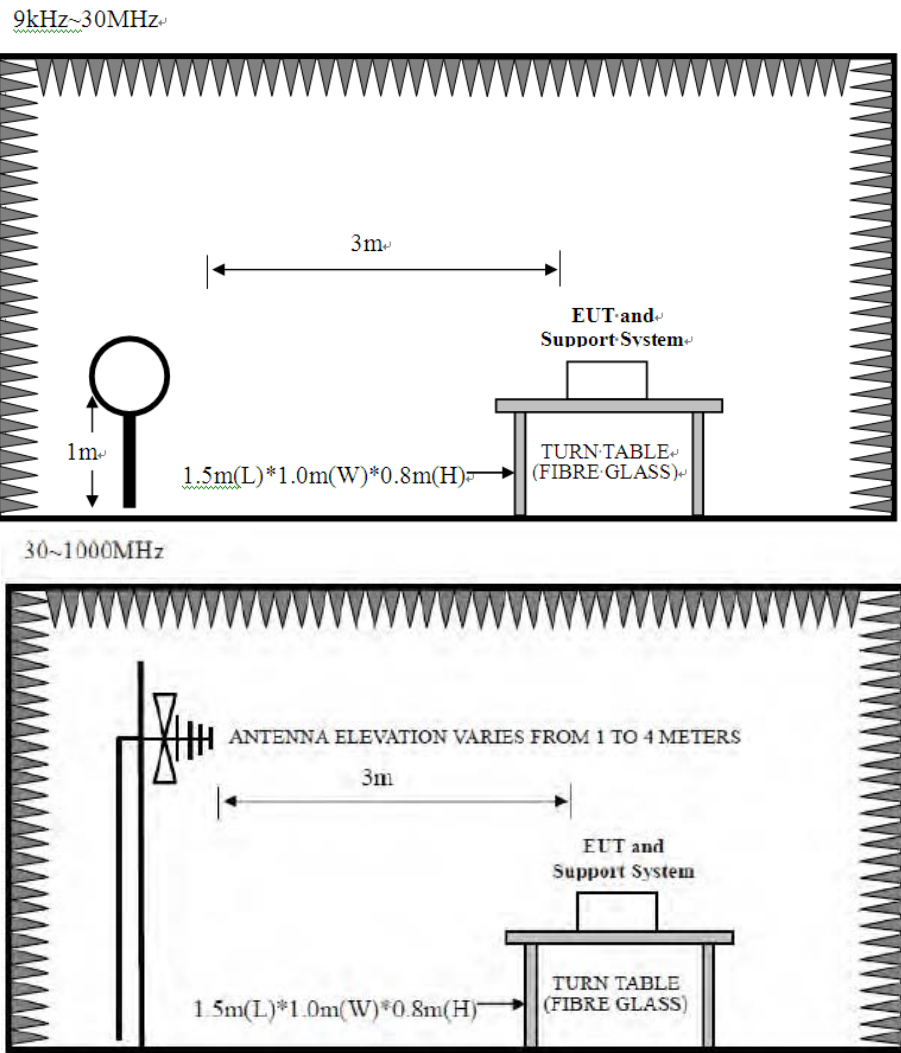

4.3. Spectrum Analyzer Setting

For 9KHz-150KHz

Spectrum Parameters	Setting
RBW	300Hz(for Peak&AVG)/CISPR 200Hz(for QP)
VBW	300Hz(for Peak&AVG)/CISPR 200Hz(for QP)
Start frequency	9KHz
Stop frequency	150KHz
Sweep Time	Auto
Detector	PEAK/QP/AVG
Trace Mode	Max Hold

For 150KHz-30MHz

Spectrum Parameters	Setting
RBW	9KHz
VBW	9KHz
Start frequency	150KHz
Stop frequency	30MHz
Sweep Time	Auto
Detector	QP
Trace Mode	Max Hold

For 30MHz-1GHz

Spectrum Parameters	Setting
RBW	120KHz
VBW	300KHz
Start frequency	30MHz
Stop frequency	1GHz
Sweep Time	Auto
Detector	QP
Trace Mode	Max Hold

4.4. Test Procedure

- a. EUT was placed on a turn table, which is 0.8 meter high above ground.
- b. EUT is set 3 meters away from the receiving antenna, which is mounted on a antenna tower.
- c. Set the EUT transmit continuously with maximum output power.
- d. Spectrum analyzer setting parameters in accordance with section 4.3.
- e. The turn table can rotate 360 degrees to determine the position of the maximum emission level.
- f. For below 30MHz test, the center of the Loop Test Antenna is 1m above the ground. During the measurement the Loop Test Antenna rotates both horizontal and vertical polarization to find out the maximum emission level.
- g. For above 30MHz test, the antenna can be moved up and down between 1 meter and 4 meters to find out the maximum emission level. Both horizontal and vertical polarization of the antenna are set on test.
- h. Record the results in the test report.

4.5. Test Result

Field strength of fundamental

EST Technology

Chilingxiang, Qishantou, Santun,
Houjie, Dongguan, Guangdong, China
Tel: +86-769-83081888
Fax: +86-769-83081878

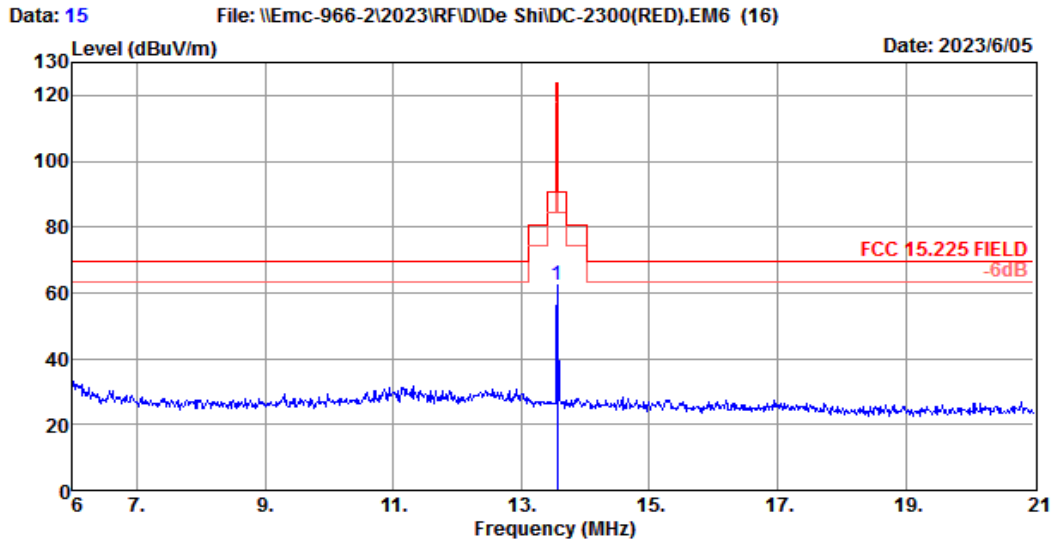

Site no. : 2# 966 chamber Data no. : 15
 Dis. / Ant. : 3m FMZB 1519B Ant. pol. : COPLANAR
 Limit : FCC 15.225 FIELD
 Env. / Ins. : Temp:20.6°C;Humi:48%;Press:101.52kPa
 Engineer : JBR
 EUT : Card Printer
 Power : DC 24V From Adapter Input AC 120V/60Hz
 M/N : DC-2300
 Test Mode : TX Mode

	Freq. (MHz)	ANT Factor (dB/m)	Cable Loss (dB)	Reading (dBuV)	Emission Level (dBuV/m)	Limit (dBuV/m)	Margin (dB)	Remark
1	13.56	19.59	0.15	42.67	62.41	124.00	61.59	Peak

Remarks: 1. Emission Level= Antenna Factor + Cable Loss + Reading.
 2. Margin= Limit - Emission Level.
 3. The emission levels that are 20dB below the official limit are not reported.

EST Technology

Chilingxiang, Qishantou, Santun,
Houjie, Dongguan, Guangdong, China
Tel: +86-769-83081888
Fax: +86-769-83081878

Data: 16 File: \\Emc-966-2\2023\RFID\De Shi\DC-2300(RED).EM6 (16) Date: 2023/6/05

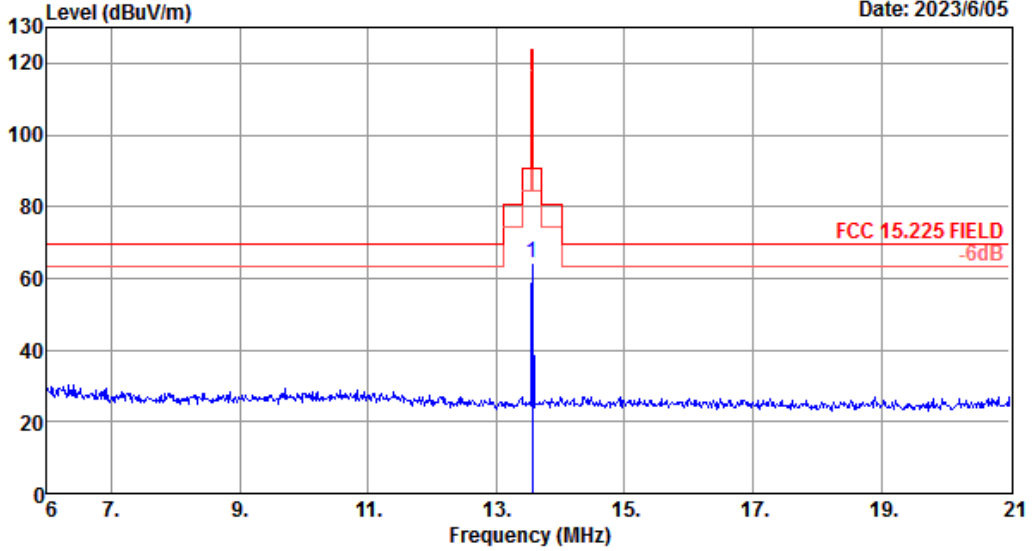

Site no. : 2# 966 chamber Data no. : 16
 Dis. / Ant. : 3m FMZB 1519B Ant. pol. : COAXIAL
 Limit : FCC 15.225 FIELD
 Env. / Ins. : Temp:20.6°C;Humi:48%;Press:101.52kPa
 Engineer : JBR
 EUT : Card Printer
 Power : DC 24V From Adapter Input AC 120V/60Hz
 M/N : DC-2300
 Test Mode : TX Mode

	Freq. (MHz)	ANT Factor (dB/m)	Cable Loss (dB)	Reading (dBuV)	Emission Level (dBuV/m)	Limit (dBuV/m)	Margin (dB)	Remark
1	13.56	19.59	0.15	44.51	64.25	124.00	59.75	Peak

Remarks: 1. Emission Level= Antenna Factor + Cable Loss + Reading.
 2. Margin= Limit - Emission Level.
 3. The emission levels that are 20dB below the official limit are not reported.

Below 30MHz Spurious Emission

EST Technology

Chilingxiang, Qishantou, Santun,
Houjie, Dongguan, Guangdong, China
Tel:+86-769-83081888
Fax:+86-769-83081878

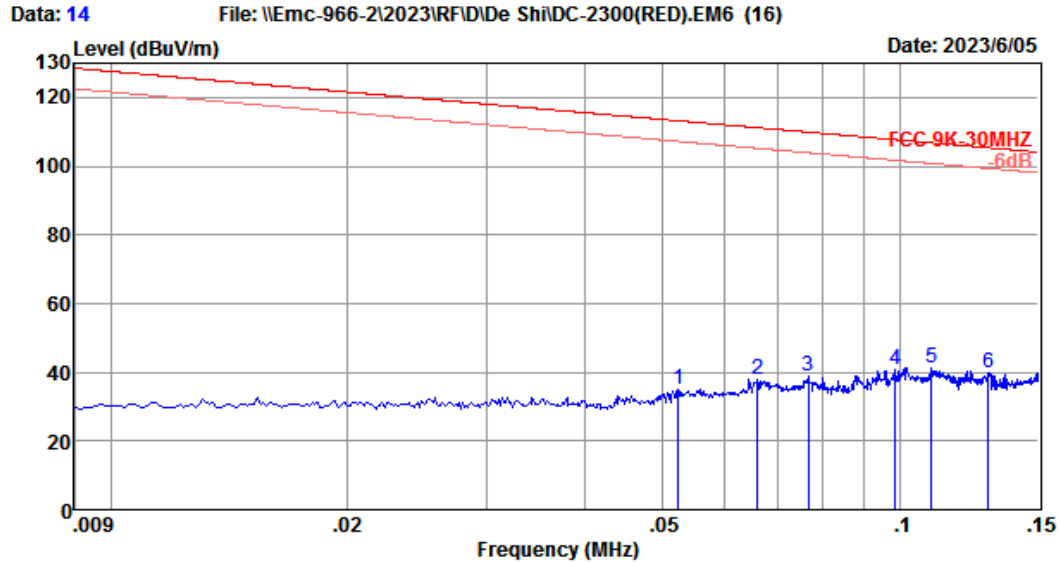

```

Site no.       : 2# 966 chamber           Data no.   : 14
Dis. / Ant.   : 3m FMZB 1519B          Ant. pol.  : COAXIAL
Limit         : FCC 9K-30MHZ
Env. / Ins.   : Temp:20.6°C;Humi:48%;Press:101.52kPa
Engineer      : JBR
EUT           : Card Printer
Power         : DC 24V From Adapter Input AC 120V/60Hz
M/N           : DC-2300
Test Mode     : TX Mode
    
```

	Freq. (MHz)	ANT Factor (dB/m)	Cable Loss (dB)	Reading (dBuV)	Emission Level (dBuV/m)	Limit (dBuV/m)	Margin (dB)	Remark
1	0.05	20.60	0.10	14.28	34.98	113.21	78.23	Peak
2	0.07	20.20	0.10	17.39	37.69	111.20	73.51	Peak
3	0.08	20.20	0.10	18.40	38.70	109.93	71.23	Peak
4	0.10	20.70	0.10	19.82	40.62	107.71	67.09	Peak
5	0.11	20.70	0.10	20.54	41.34	106.79	65.45	Peak
6	0.13	20.40	0.10	19.14	39.64	105.35	65.71	Peak

Remarks: 1. Emission Level= Antenna Factor + Cable Loss + Reading.
 2. Margin= Limit - Emission Level.
 3. The emission levels that are 20dB below the official limit are not reported.

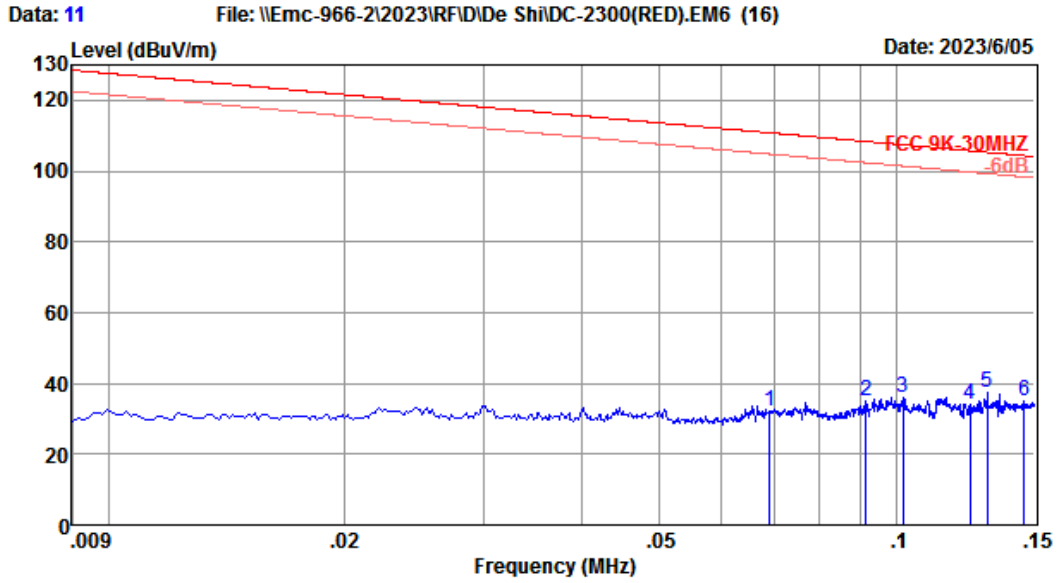

Site no. : 2# 966 chamber Data no. : 11
 Dis. / Ant. : 3m FMZB 1519B Ant. pol. : COPLANAR
 Limit : FCC 9K-30MHZ
 Env. / Ins. : Temp:20.6°C;Humi:48%;Press:101.52kPa
 Engineer : JBR
 EUT : Card Printer
 Power : DC 24V From Adapter Input AC 120V/60Hz
 M/N : DC-2300
 Test Mode : TX Mode

	Freq. (MHz)	ANT Factor (dB/m)	Cable Loss (dB)	Reading (dBUV)	Emission Level (dBUV/m)	Limit (dBUV/m)	Margin (dB)	Remark
1	0.07	20.20	0.10	11.80	32.10	110.82	78.72	Peak
2	0.09	20.70	0.10	14.04	34.84	108.38	73.54	Peak
3	0.10	20.70	0.10	15.35	36.15	107.44	71.29	Peak
4	0.12	20.40	0.10	13.73	34.23	105.73	71.50	Peak
5	0.13	20.40	0.10	16.72	37.22	105.29	68.07	Peak
6	0.15	20.20	0.10	14.81	35.11	104.36	69.25	Peak

Remarks: 1. Emission Level= Antenna Factor + Cable Loss + Reading.
 2. Margin= Limit - Emission Level.
 3. The emission levels that are 20dB below the official limit are not reported.

Data: 12 File: \\Emc-966-2\2023\RFID\De Shi\DC-2300(RED).EM6 (16) Date: 2023/6/05

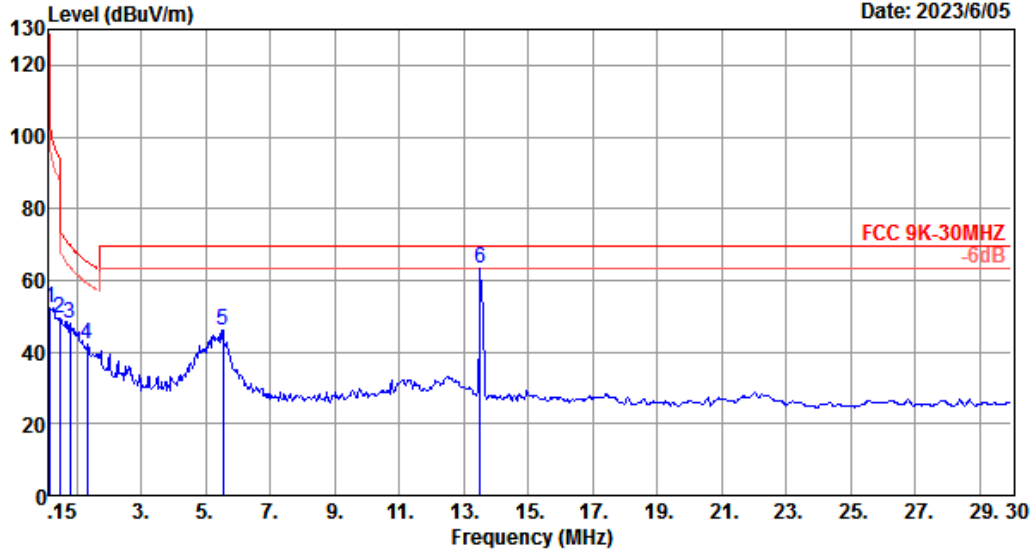

Site no. : 2# 966 chamber Data no. : 12
 Dis. / Ant. : 3m FMZB 1519B Ant. pol. : COPLANAR
 Limit : FCC 9K-30MHZ
 Env. / Ins. : Temp:20.6°C;Humi:48%;Press:101.52kPa
 Engineer : JBR
 EUT : Card Printer
 Power : DC 24V From Adapter Input AC 120V/60Hz
 M/N : DC-2300
 Test Mode : TX Mode

	Freq. (MHz)	ANT Factor (dB/m)	Cable Loss (dB)	Reading (dBuV)	Emission Level (dBuV/m)	Limit (dBuV/m)	Margin (dB)	Remark
1	0.18	20.25	0.10	31.83	52.18	102.51	50.33	Peak
2	0.48	20.80	0.10	28.66	49.56	94.01	44.45	Peak
3	0.81	20.86	0.10	27.17	48.13	69.47	21.34	Peak
4	1.34	20.81	0.10	21.36	42.27	65.04	22.77	Peak
5	5.55	20.10	0.12	25.82	46.04	69.54	23.50	Peak
6	13.52	19.59	0.15	43.76	63.50	69.54	6.04	Peak

Remarks: 1. Emission Level= Antenna Factor + Cable Loss + Reading.
 2. Margin= Limit - Emission Level.
 3. The emission levels that are 20dB below the official limit are not reported.

Data: 13

File: \\Emc-966-2\2023\IRFID\De Shi\DC-2300(RED).EM6 (16)

Date: 2023/6/05

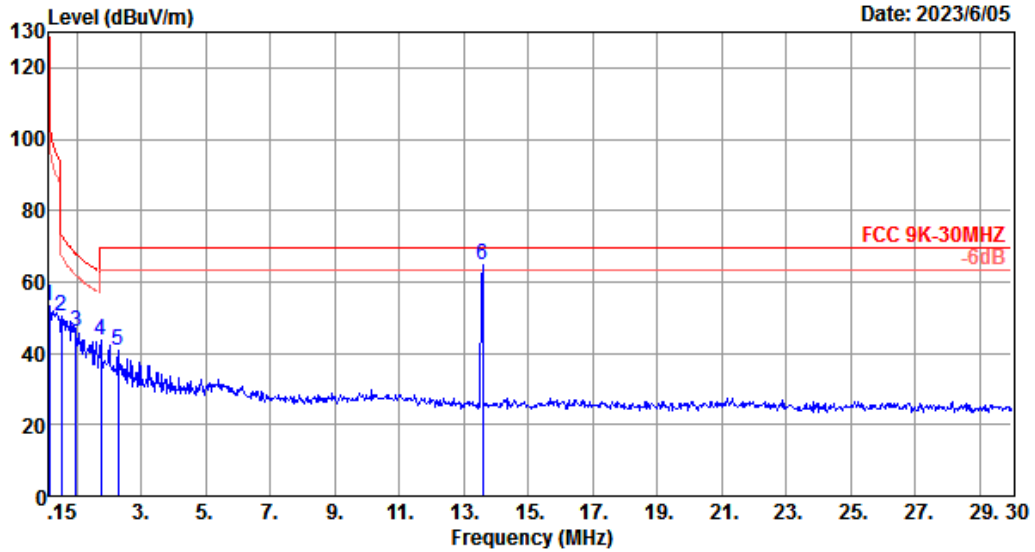

Site no. : 2# 966 chamber Data no. : 13
 Dis. / Ant. : 3m FMZB 1519B Ant. pol. : COAXIAL
 Limit : FCC 9K-30MHZ
 Env. / Ins. : Temp:20.6°C;Humi:48%;Press:101.52kPa
 Engineer : JBR
 EUT : Card Printer
 Power : DC 24V From Adapter Input AC 120V/60Hz
 M/N : DC-2300
 Test Mode : TX Mode

	Freq. (MHz)	ANT Factor (dB/m)	Cable Loss (dB)	Reading (dBuV)	Emission Level (dBuV/m)	Limit (dBuV/m)	Margin (dB)	Remark
1	0.15	20.20	0.10	32.83	53.13	104.08	50.95	Peak
2	0.54	20.81	0.10	29.49	50.40	72.99	22.59	Peak
3	0.99	20.90	0.10	24.84	45.84	67.73	21.89	Peak
4	1.76	20.71	0.11	22.87	43.69	69.54	25.85	Peak
5	2.30	20.58	0.11	20.15	40.84	69.54	28.70	Peak
6	13.58	19.58	0.15	44.83	64.56	69.54	4.98	Peak

Remarks: 1. Emission Level= Antenna Factor + Cable Loss + Reading.
 2. Margin= Limit - Emission Level.
 3. The emission levels that are 20dB below the official limit are not reported.

Above 30MHz Spurious Emission

EST Technology

Chilingxiang, Qishantou, Santun,
Houjie, Dongguan, Guangdong, China
Tel: +86-769-83081888
Fax: +86-769-83081878

Data: 5

File: \\EMC-966-1\test data\2023\RFID\IDE SH\DC-2300.EM6 (10)

Date: 2023-06-05

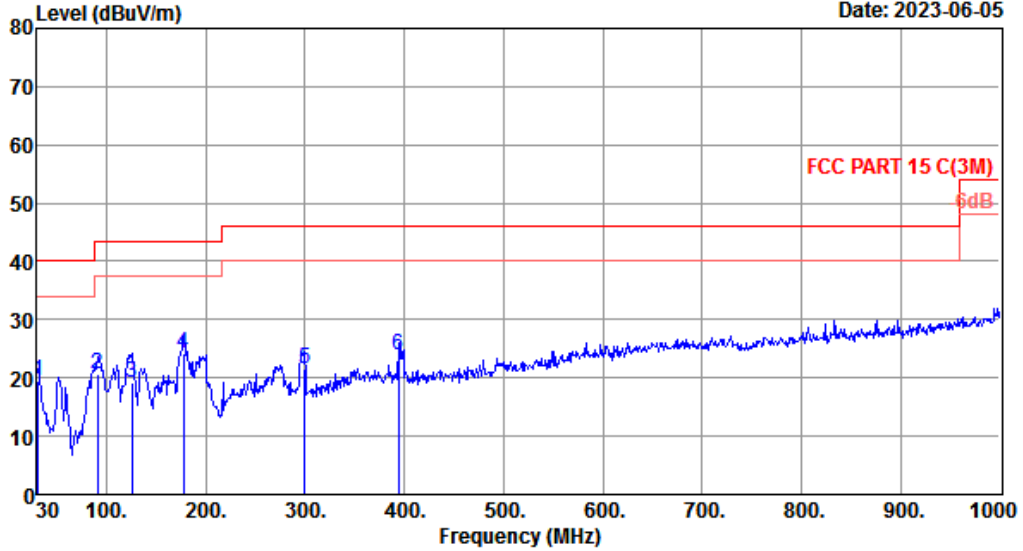

```

Site no.       : 1# 966 Chamber           Data no.      : 5
Dis. / Ant.    : 3m 37062                Ant. pol.    : HORIZONTAL
Limit         : FCC PART 15 C(3M)
Env. / Ins.    : Temp:24.8°C,Humi:56.7%;Press:101.43KPa
Engineer      : XLong
EUT           : Card Printer
Power         : DC 24V From Adapter Input AC 120V/60Hz
M/N           : DC-2300
Test Mode     : TX Mode
    
```

	Freq. (MHz)	ANT Factor (dB/m)	Cable Loss (dB)	Reading (dBuV)	Emission Level (dBuV/m)	Limit (dBuV/m)	Margin (dB)	Remark
1	30.97	18.30	0.59	0.66	19.55	40.00	20.45	QP
2	91.11	10.02	1.05	9.45	20.52	43.50	22.98	QP
3	126.03	11.92	1.04	6.25	19.21	43.50	24.29	QP
4	177.44	9.95	1.23	13.04	24.22	43.50	19.28	QP
5	299.66	14.30	1.70	5.63	21.63	46.00	24.37	QP
6	393.75	16.94	1.78	5.25	23.97	46.00	22.03	QP

Remarks: 1. Emission Level= Antenna Factor + Cable Loss + Reading.
 2. Margin= Limit - Emission Level.
 3. The emission levels that are 20dB below the official limit are not reported.

Data: 6 File: \\EMC-966-1\test data\2023\RFID\IDE SH\DC-2300.EM6 (10) Date: 2023-06-05

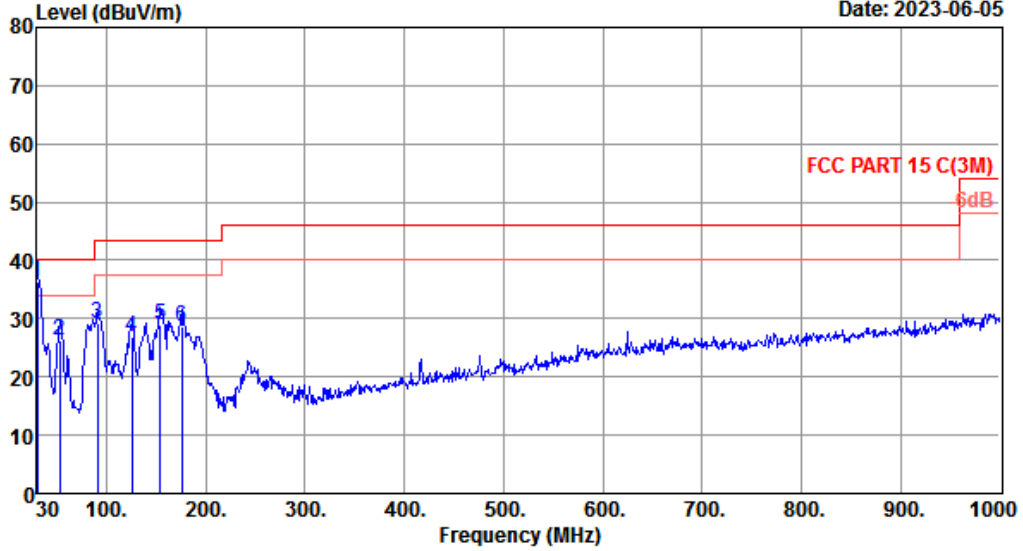

Site no. : 1# 966 Chamber Data no. : 6
 Dis. / Ant. : 3m 37062 Ant. pol. : VERTICAL
 Limit : FCC PART 15 C(3M)
 Env. / Ins. : Temp:24.8°C, Humi:56.7%; Press:101.43KPa
 Engineer : XLong
 EUT : Card Printer
 Power : DC 24V From Adapter Input AC 120V/60Hz
 M/N : DC-2300
 Test Mode : TX Mode

	Freq. (MHz)	ANT Factor (dB/m)	Cable Loss (dB)	Reading (dBuV)	Emission Level (dBuV/m)	Limit (dBuV/m)	Margin (dB)	Remark
1	30.00	19.20	0.59	16.63	36.42	40.00	3.58	QP
2	53.28	7.60	0.68	18.12	26.40	40.00	13.60	QP
3	91.11	10.02	1.05	18.28	29.35	43.50	14.15	QP
4	126.03	11.92	1.04	13.93	26.89	43.50	16.61	QP
5	154.16	11.74	1.20	15.92	28.86	43.50	14.64	QP
6	175.50	10.05	1.14	17.44	28.63	43.50	14.87	QP

Remarks: 1. Emission Level= Antenna Factor + Cable Loss + Reading.
 2. Margin= Limit - Emission Level.
 3. The emission levels that are 20dB below the official limit are not reported.

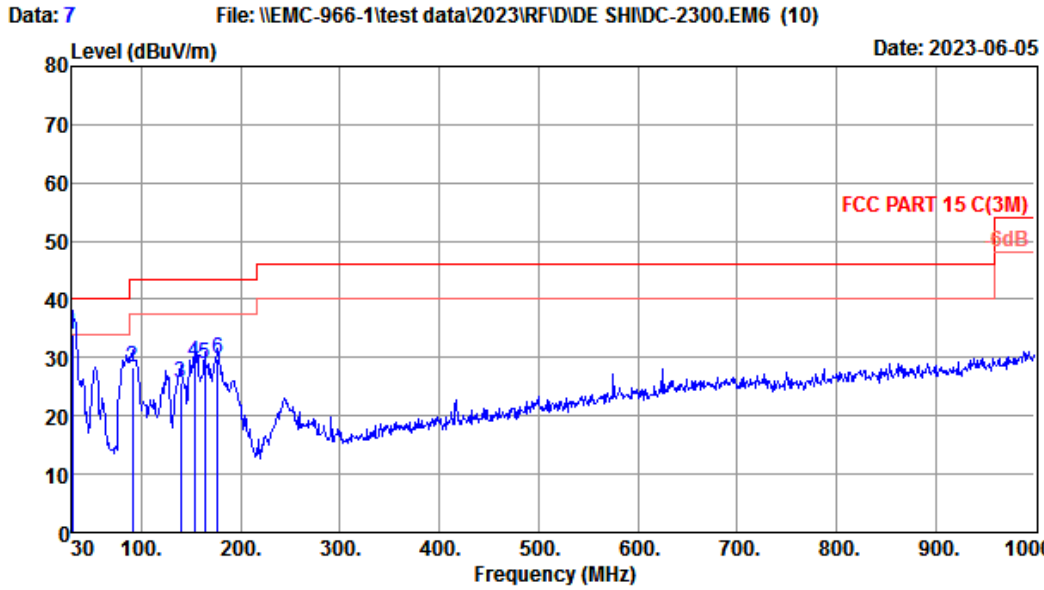

Site no. : 1# 966 Chamber Data no. : 7
 Dis. / Ant. : 3m 37062 Ant. pol. : VERTICAL
 Limit : FCC PART 15 C(3M)
 Env. / Ins. : Temp:24.8°C, Humi:56.7%; Press:101.43KPa
 Engineer : XLong
 EUT : Card Printer
 Power : DC 24V From Adapter Input AC 120V/60Hz
 M/N : DC-2300
 Test Mode : RX Mode

	Freq. (MHz)	ANT Factor (dB/m)	Cable Loss (dB)	Reading (dBuV)	Emission Level (dBuV/m)	Limit (dBuV/m)	Margin (dB)	Remark
1	30.00	19.20	0.59	14.28	34.07	40.00	5.93	QP
2	91.11	10.02	1.05	17.17	28.24	43.50	15.26	QP
3	139.61	12.80	1.11	11.63	25.54	43.50	17.96	QP
4	153.19	11.78	1.18	16.14	29.10	43.50	14.40	QP
5	163.86	11.04	1.25	16.65	28.94	43.50	14.56	QP
6	176.47	10.00	1.18	18.52	29.70	43.50	13.80	QP

Remarks: 1. Emission Level= Antenna Factor + Cable Loss + Reading.
 2. Margin= Limit - Emission Level.
 3. The emission levels that are 20dB below the official limit are not reported.

Data: 8 File: \\EMC-966-1\test data\2023\RFID\IDE SH\DC-2300.EM6 (10) Date: 2023-06-05

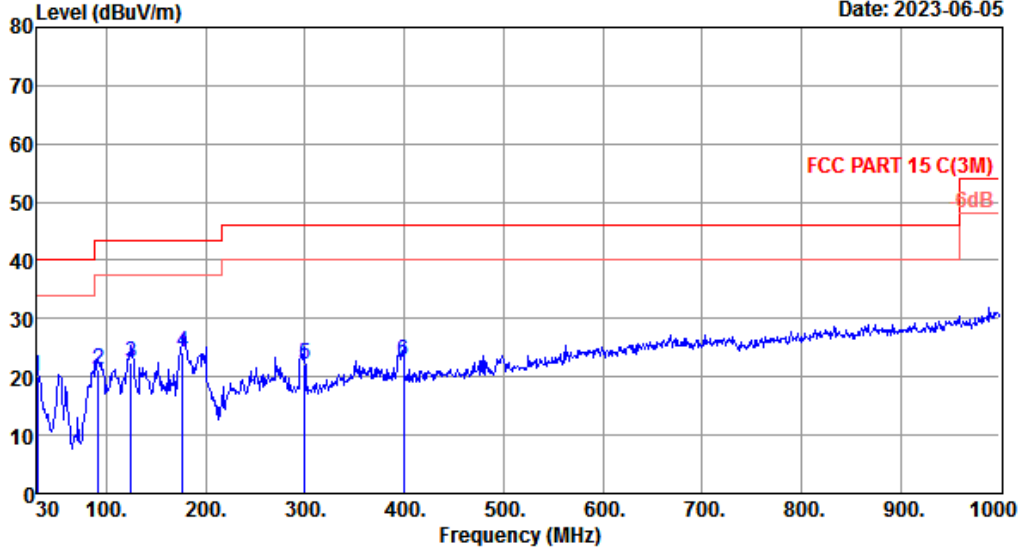

Site no. : 1# 966 Chamber Data no. : 8
 Dis. / Ant. : 3m 37062 Ant. pol. : HORIZONTAL
 Limit : FCC PART 15 C(3M)
 Env. / Ins. : Temp:24.8°C, Humi:56.7%; Press:101.43KPa
 Engineer : XLong
 EUT : Card Printer
 Power : DC 24V From Adapter Input AC 120V/60Hz
 M/N : DC-2300
 Test Mode : RX Mode

	Freq. (MHz)	ANT Factor (dB/m)	Cable Loss (dB)	Reading (dBuV)	Emission Level (dBuV/m)	Limit (dBuV/m)	Margin (dB)	Remark
1	30.00	19.20	0.59	0.19	19.98	40.00	20.02	QP
2	92.08	10.04	1.01	10.11	21.16	43.50	22.34	QP
3	125.06	11.90	1.04	9.52	22.46	43.50	21.04	QP
4	176.47	10.00	1.18	13.04	24.22	43.50	19.28	QP
5	299.66	14.30	1.70	6.22	22.22	46.00	23.78	QP
6	399.57	17.00	1.79	4.00	22.79	46.00	23.21	QP

Remarks: 1. Emission Level= Antenna Factor + Cable Loss + Reading.
 2. Margin= Limit - Emission Level.
 3. The emission levels that are 20dB below the official limit are not reported.

Data: 5 File: \\EMC-966-1\test data\2023\RFID\IDE SHIKT-200.EM6 (10) Date: 2023-06-05

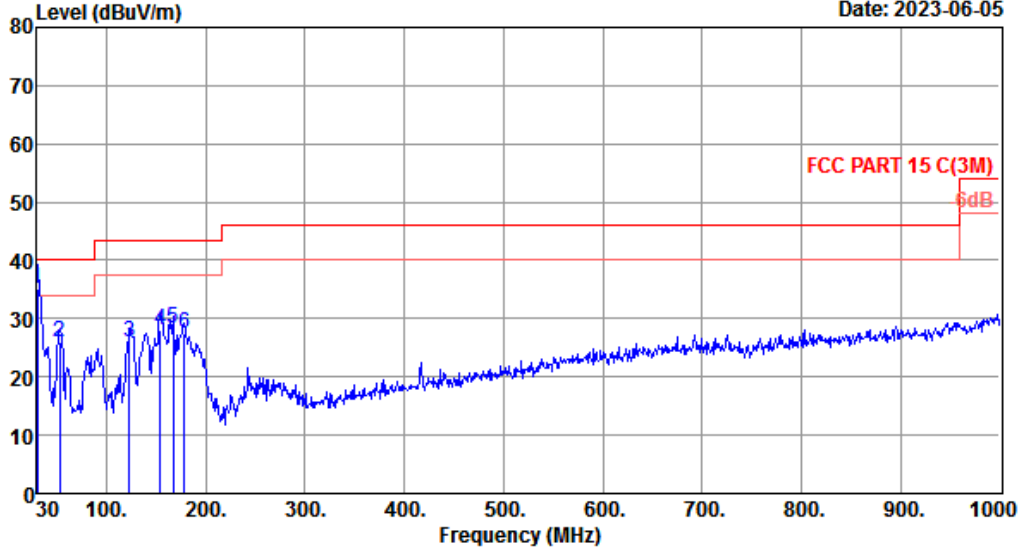

Site no. : 1# 966 Chamber Data no. : 5
 Dis. / Ant. : 3m 37062 Ant. pol. : VERTICAL
 Limit : FCC PART 15 C(3M)
 Env. / Ins. : Temp:24.8°C, Humi:56.7%; Press:101.43KPa
 Engineer : XLong
 EUT : Card Printer
 Power : DC 24V From Adapter Input AC 120V/60Hz
 M/N : KT-200
 Test Mode : TX Mode

	Freq. (MHz)	ANT Factor (dB/m)	Cable Loss (dB)	Reading (dBuV)	Emission Level (dBuV/m)	Limit (dBuV/m)	Margin (dB)	Remark
1	30.00	19.20	0.59	15.35	35.14	40.00	4.86	QP
2	53.28	7.60	0.68	17.80	26.08	40.00	13.92	QP
3	123.12	11.78	1.07	13.12	25.97	43.50	17.53	QP
4	154.16	11.74	1.20	15.06	28.00	43.50	15.50	QP
5	166.77	10.50	1.20	16.65	28.35	43.50	15.15	QP
6	178.41	9.90	1.23	16.22	27.35	43.50	16.15	QP

Remarks: 1. Emission Level= Antenna Factor + Cable Loss + Reading.
 2. Margin= Limit - Emission Level.
 3. The emission levels that are 20dB below the official limit are not reported.

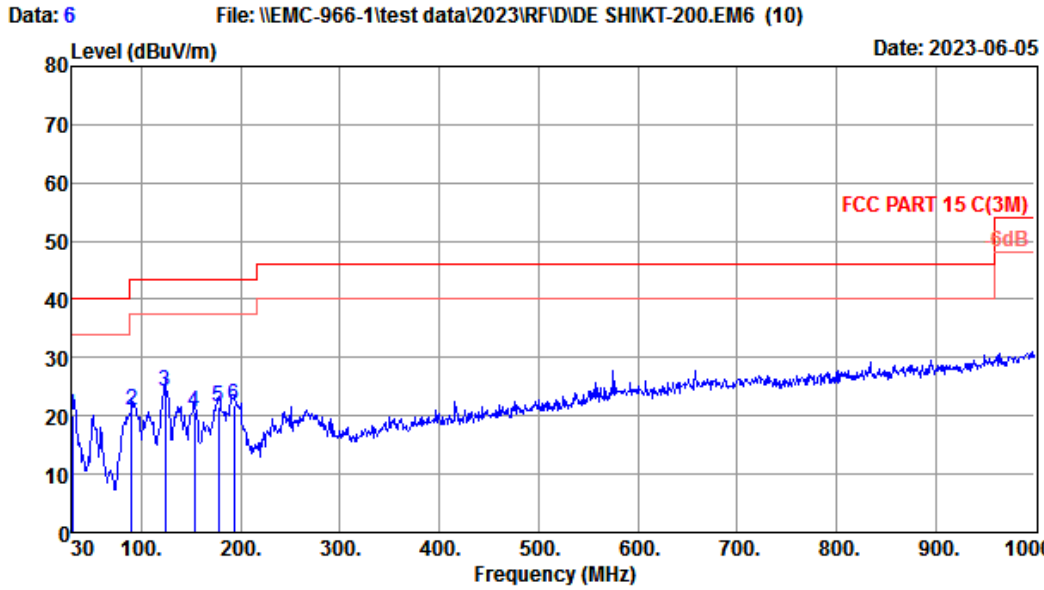

Site no. : 1# 966 Chamber Data no. : 6
 Dis. / Ant. : 3m 37062 Ant. pol. : HORIZONTAL
 Limit : FCC PART 15 C(3M)
 Env. / Ins. : Temp:24.8°C, Humi:56.7%; Press:101.43KPa
 Engineer : XLong
 EUT : Card Printer
 Power : DC 24V From Adapter Input AC 120V/60Hz
 M/N : KT-200
 Test Mode : TX Mode

	Freq. (MHz)	ANT Factor (dB/m)	Cable Loss (dB)	Reading (dBuV)	Emission Level (dBuV/m)	Limit (dBuV/m)	Margin (dB)	Remark
1	30.00	19.20	0.59	0.38	20.17	40.00	19.83	QP
2	90.14	10.00	1.09	9.96	21.05	43.50	22.45	QP
3	124.09	11.84	1.05	11.41	24.30	43.50	19.20	QP
4	153.19	11.78	1.18	7.58	20.54	43.50	22.96	QP
5	177.44	9.95	1.23	10.27	21.45	43.50	22.05	QP
6	192.96	9.14	1.19	11.43	21.76	43.50	21.74	QP

Remarks: 1. Emission Level= Antenna Factor + Cable Loss + Reading.
 2. Margin= Limit - Emission Level.
 3. The emission levels that are 20dB below the official limit are not reported.

Data: 7 File: \\EMC-966-1\test data\2023\RFID\IDE SHIKT-200.EM6 (10) Date: 2023-06-05

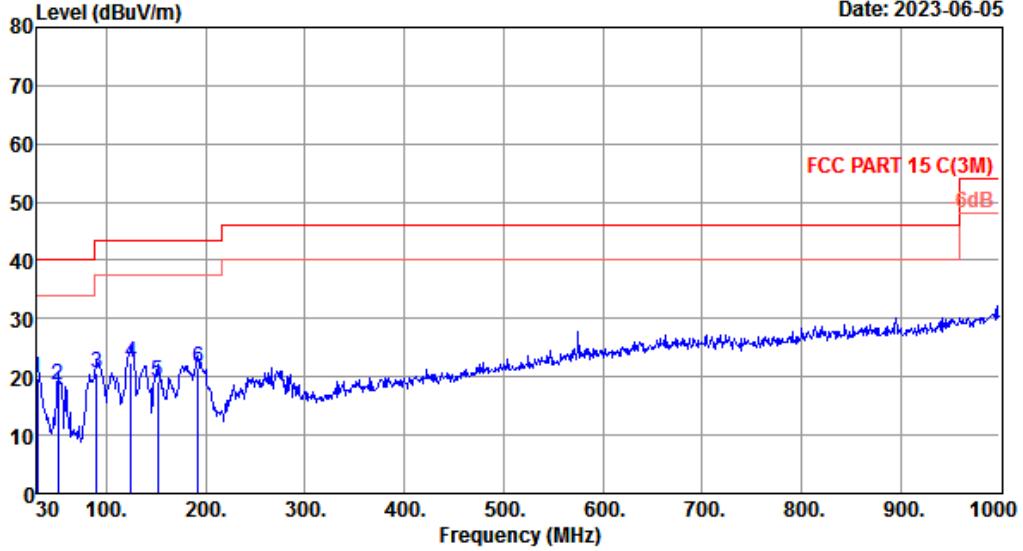

Site no. : 1# 966 Chamber Data no. : 7
 Dis. / Ant. : 3m 37062 Ant. pol. : HORIZONTAL
 Limit : FCC PART 15 C(3M)
 Env. / Ins. : Temp:24.8°C, Humi:56.7%; Press:101.43KPa
 Engineer : XLong
 EUT : Card Printer
 Power : DC 24V From Adapter Input AC 120V/60Hz
 M/N : KT-200
 Test Mode : RX Mode

	Freq. (MHz)	ANT Factor (dB/m)	Cable Loss (dB)	Reading (dBuV)	Emission Level (dBuV/m)	Limit (dBuV/m)	Margin (dB)	Remark
1	30.00	19.20	0.59	0.08	19.87	40.00	20.13	QP
2	51.34	8.45	0.71	9.42	18.58	40.00	21.42	QP
3	90.14	10.00	1.09	9.60	20.69	43.50	22.81	QP
4	125.06	11.90	1.04	9.57	22.51	43.50	20.99	QP
5	151.25	11.86	1.15	6.06	19.07	43.50	24.43	QP
6	191.99	9.16	1.19	11.14	21.49	43.50	22.01	QP

Remarks: 1. Emission Level= Antenna Factor + Cable Loss + Reading.
 2. Margin= Limit - Emission Level.
 3. The emission levels that are 20dB below the official limit are not reported.

EST Technology

Chilingxiang, Qishantou, Santun,
Houjie, Dongguan, Guangdong, China
Tel: +86-769-83081888
Fax: +86-769-83081878

Data: 8 File: \\EMC-966-1\test data\2023\RFID\IDE SHIKT-200.EM6 (10) Date: 2023-06-05

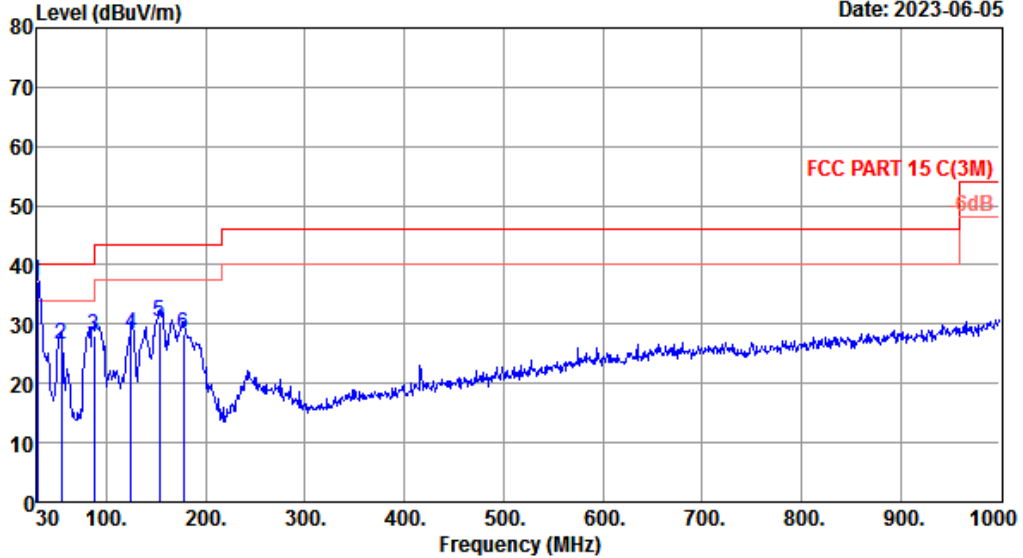

Site no. : 1# 966 Chamber Data no. : 8
 Dis. / Ant. : 3m 37062 Ant. pol. : VERTICAL
 Limit : FCC PART 15 C(3M)
 Env. / Ins. : Temp:24.8°C, Humi:56.7%, Press:101.43KPa
 Engineer : XLong
 EUT : Card Printer
 Power : DC 24V From Adapter Input AC 120V/60Hz
 M/N : KT-200
 Test Mode : RX Mode

	Freq. (MHz)	ANT Factor (dB/m)	Cable Loss (dB)	Reading (dBuV)	Emission Level (dBuV/m)	Limit (dBuV/m)	Margin (dB)	Remark
1	30.00	19.20	0.59	17.33	37.12	40.00	2.88	QP
2	54.25	7.10	0.66	18.95	26.71	40.00	13.29	QP
3	87.23	9.34	0.94	17.77	28.05	40.00	11.95	QP
4	125.06	11.90	1.04	15.46	28.40	43.50	15.10	QP
5	153.19	11.78	1.18	17.53	30.49	43.50	13.01	QP
6	177.44	9.95	1.23	17.22	28.40	43.50	15.10	QP

Remarks: 1. Emission Level= Antenna Factor + Cable Loss + Reading.
 2. Margin= Limit - Emission Level.
 3. The emission levels that are 20dB below the official limit are not reported.

5. FREQUENCY TOLERANCE

5.1. Limit

The devices operating in the 13.553-13.567 MHz shall maintain the carrier frequency within 0.01% of the operating frequency over the temperature variation of -20°C to +50°C using an environmental chamber. The primary supply voltage is varied from 85% to 115% of the voltage normally at the input to the device or at the power supply terminals if cables are not normally supplied.

5.2. Test Setup

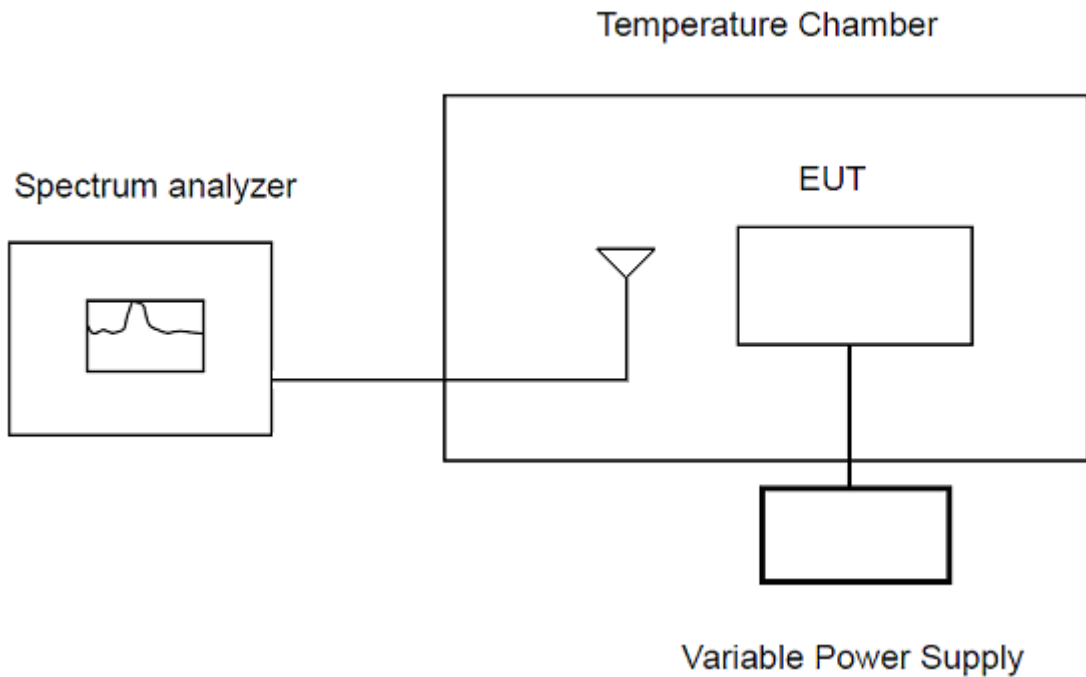

5.3. Spectrum Analyzer Setting

Spectrum Parameters	Setting
RBW	10KHz
VBW	10KHz
Span	50KHz
Sweep Time	Auto
Detector	PEAK
Trace Mode	Max Hold

5.4. Test Procedure

For measurement frequency stability under temperature variation :

- a. Supply the EUT with a nominal ac voltage or install a new or fully charged battery in the EUT.
- b. Turn the EUT OFF and place it inside the environmental temperature chamber.
- c. The spectrum analyzer connected a receive antenna and place near the EUT.
- d. Spectrum analyzer setting parameters in accordance with section 5.3.
- e. Set the temperature control on the chamber to the Specified temperature and allow the oscillator heater and the chamber temperature to stabilize.
- f. Turn the EUT ON with the rated voltage, and the EUT transmit continuously with maximum output power.
- g. Record the operating frequency at startup, and at 2 minutes, 5 minutes, and 10 minutes after the EUT is energized.
- h. Repeat step d through step g to measured the temperature form -20°C to $+50^{\circ}\text{C}$ in 10°C steps.

For frequency stability under voltage variation:

- a. Supply the EUT with a nominal ac voltage or install a new or fully charged battery in the EUT.
- b. Turn the EUT OFF and place it inside the environmental temperature chamber.
- c. The spectrum analyzer connected a receive antenna and place near the EUT.
- d. Spectrum analyzer setting parameters in accordance with section 5.3.
- e. Unless otherwise specified, set the temperature control on the chamber to the ambient room temperature ($+15^{\circ}\text{C}$ to $+25^{\circ}\text{C}$) and allow the oscillator heater and the chamber temperature to stabilize.
- f. Turn the EUT ON with the rated voltage, and the EUT transmit continuously with maximum output power.
- g. Record the operating frequency.
- h. Repeat step d through step g to measured the varied from 85% to 115% of the rated voltage.

5.5. Test Result

Frequency Stability Under Temperature Variation							
Declared Frequency (MHz)	Voltage (V)	Temperature (°C)	Time (minutes)	Measurement Value (MHz)	Frequency Deviation (%)	Limit (%)	Test Result
13.56	3	50	0	13.5606015	0.0044358	±0.01	PASS
			2	13.5599015	-0.0007264	±0.01	PASS
			5	13.5606015	0.0044358	±0.01	PASS
			10	13.5606015	0.0044358	±0.01	PASS
		40	0	13.5606015	0.0044358	±0.01	PASS
			2	13.5606015	0.0044358	±0.01	PASS
			5	13.5606015	0.0044358	±0.01	PASS
			10	13.5606015	0.0044358	±0.01	PASS
		30	0	13.5606015	0.0044358	±0.01	PASS
			2	13.5606015	0.0044358	±0.01	PASS
			5	13.5606015	0.0044358	±0.01	PASS
			10	13.5606015	0.0044358	±0.01	PASS
		20	0	13.5606015	0.0044358	±0.01	PASS
			2	13.5606015	0.0044358	±0.01	PASS
			5	13.5606015	0.0044358	±0.01	PASS
			10	13.5606015	0.0044358	±0.01	PASS
		10	0	13.5606015	0.0044358	±0.01	PASS
			2	13.5606015	0.0044358	±0.01	PASS
			5	13.5606015	0.0044358	±0.01	PASS
			10	13.5606015	0.0044358	±0.01	PASS
		0	0	13.5606015	0.0044358	±0.01	PASS
			2	13.5606015	0.0044358	±0.01	PASS
			5	13.5606015	0.0044358	±0.01	PASS
			10	13.5606015	0.0044358	±0.01	PASS
		-10	0	13.5606015	0.0044358	±0.01	PASS
			2	13.5606015	0.0044358	±0.01	PASS
			5	13.5606015	0.0044358	±0.01	PASS
			10	13.5606015	0.0044358	±0.01	PASS
		-20	0	13.5606015	0.0044358	±0.01	PASS
			2	13.5606015	0.0044358	±0.01	PASS
			5	13.5606015	0.0044358	±0.01	PASS
			10	13.5606015	0.0044358	±0.01	PASS

Note: Frequency Deviation(%)=[(Measurement Value- Declared Frequency)/ Declared Frequency]*100%.

Frequency Stability Under Voltage Variation						
Frequency (MHz)	Temperature (°C)	Voltage (V)	Measurement Value (MHz)	Frequency Error (%)	Limit (%)	Test Result
13.56	25	3.00	13.5606015	0.0044358	±0.01	PASS
		3.45	13.5606015	0.0044358	±0.01	PASS
		2.55	13.5599015	-0.0007264	±0.01	PASS

Note:Frequency Deviation(%)=[(Measurement Value- Declared Frequency)/ Declared Frequency]*100%.

6. 20DB BANDWIDTH&99% OCCUPIED BANDWIDTH

6.1. Limit

Intentional radiators operating under the alternative provisions to the general emission limits, as contained in §13.553-13.567 MHz and in subpart E of this part, must be designed to ensure that the 20 dB bandwidth of the emission, or whatever bandwidth may otherwise be specified in the specific rule section under which the equipment operates, is contained within the frequency band designated in the rule section under which the equipment is operated. In the case of intentional radiators operating under the provisions of subpart E, the emission bandwidth may span across multiple contiguous frequency bands identified in that subpart. The requirement to contain the designated bandwidth of the emission within the specified frequency band includes the effects from frequency sweeping, frequency hopping and other modulation techniques that may be employed as well as the frequency stability of the transmitter over expected variations in temperature and supply voltage. If a frequency stability is not specified in the regulations, it is recommended that the fundamental emission be kept within at least the central 80% of the permitted band in order to minimize the possibility of out-of-band operation.

6.2. Test Setup

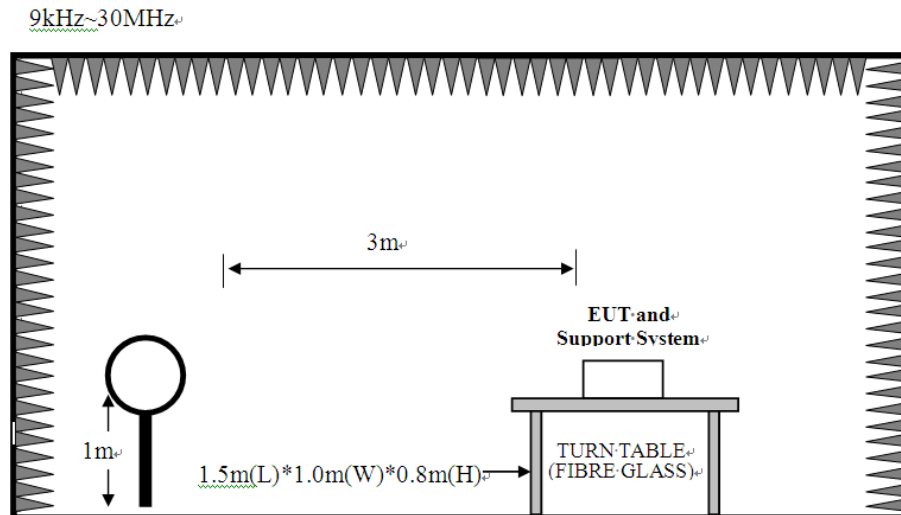

6.3. Spectrum Analyzer Setting

Spectrum Parameters	Setting
RBW	10KHz
VBW	30KHz
Span	two times and five times the OBW
Sweep Time	Auto
Detector	Peak
Trace Mode	Max Hold

6.4. Test Procedure

- a. EUT was placed on a turn table, which is 0.8 meter high above ground
- b. EUT is set 3 meters away from the receiving antenna, which is mounted on a antenna tower.
- c. Set the EUT transmit continuously with maximum output power.
- d. The turn table can rotate 360 degrees to determine the position of the maximum emission level.
- e. Spectrum analyzer setting parameters in accordance with section 6.3.
- f. Allow the trace to stabilize, Set the spectrum analyzer marker to the highest level of the displayed trace, use the 99% power bandwidth function to measure 99% occupied bandwidth, and use mark-dettle function measure the maximum width of the emission that is constrained by the frequencies associated with the two outermost amplitude points (upper and lower frequencies) that are attenuated by 20 dB relative to the maximum level measured in the fundamental emission.
- g. Record the the value of 99% occupied bandwidth and 20 dB bandwidth.

6.5. Test Result

Temperature	24°C	Relative Humidity	51%	
Test Voltage	AC 120V/60Hz			
Frequency (MHz)	20dB Bandwidth (KHz)	99% Occupied Bandwidth (KHz)	20 dB Bandwidth Limit (KHz)	Test Result
13.56	7.5539	6.3965	≤ 11.2	PASS

Note :For NFC devices,the permitted band is 13.553MHz-13.567MHz,the bandwidth is 14KHz,so the Limit=14KHz× 80%=11.2KHz.

20dB Bandwidth

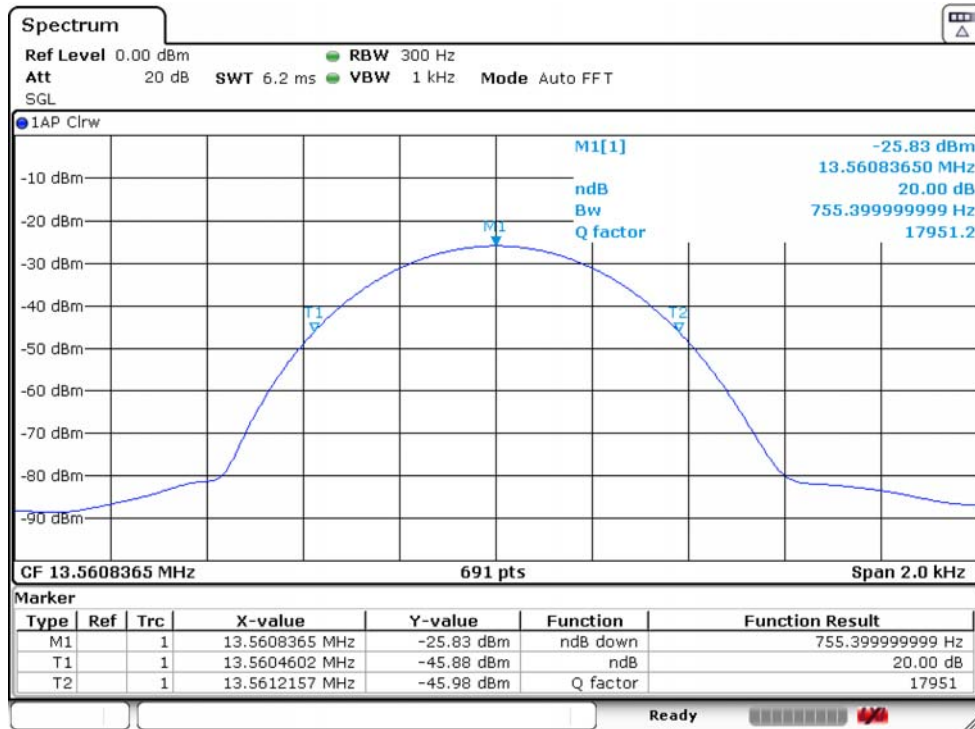

99% Occupied Bandwidth

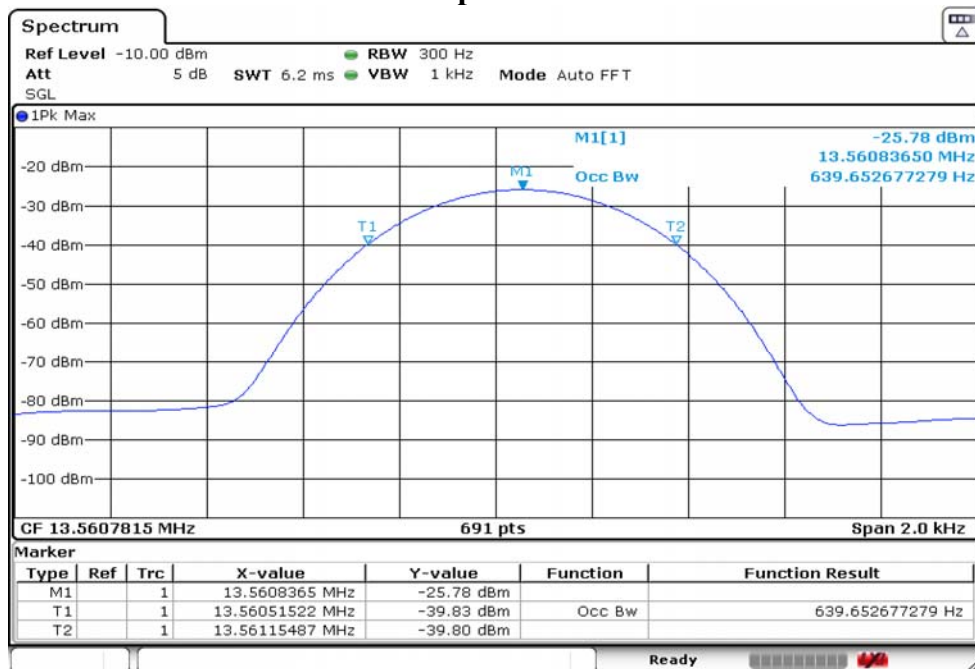

7. ANTENNA REQUIREMENTS

7.1. Limit

An intentional radiator shall be designed to ensure that no antenna other than that furnished by the responsible party shall be used with the device. The use of a permanently attached antenna or of an antenna that uses a unique coupling to the intentional radiator shall be considered sufficient to comply with the provisions of this section. The manufacturer may design the unit so that a broken antenna can be replaced by the user, but the use of a standard antenna jack or electrical connector is prohibited. This requirement does not apply to carrier current devices or to devices operated under the provisions of §§15.211, 15.213, 15.217, 15.219, 15.221, or §15.236. Further, this requirement does not apply to intentional radiators that must be professionally installed, such as perimeter protection systems and some field disturbance sensors, or to other intentional radiators which, in accordance with §15.31(d), must be measured at the installation site. However, the installer shall be responsible for ensuring that the proper antenna is employed so that the limits in this part are not exceeded.

7.2. Test Result

The antennas used for this product is internal antenna ,so compliance with antenna requirements.
(Please refer to the EUT photo for details)

8. TEST SETUP PHOTO

M/N: DC-2300
Conducted Emissions Test



M/N: KT-200

Conducted Emissions Test

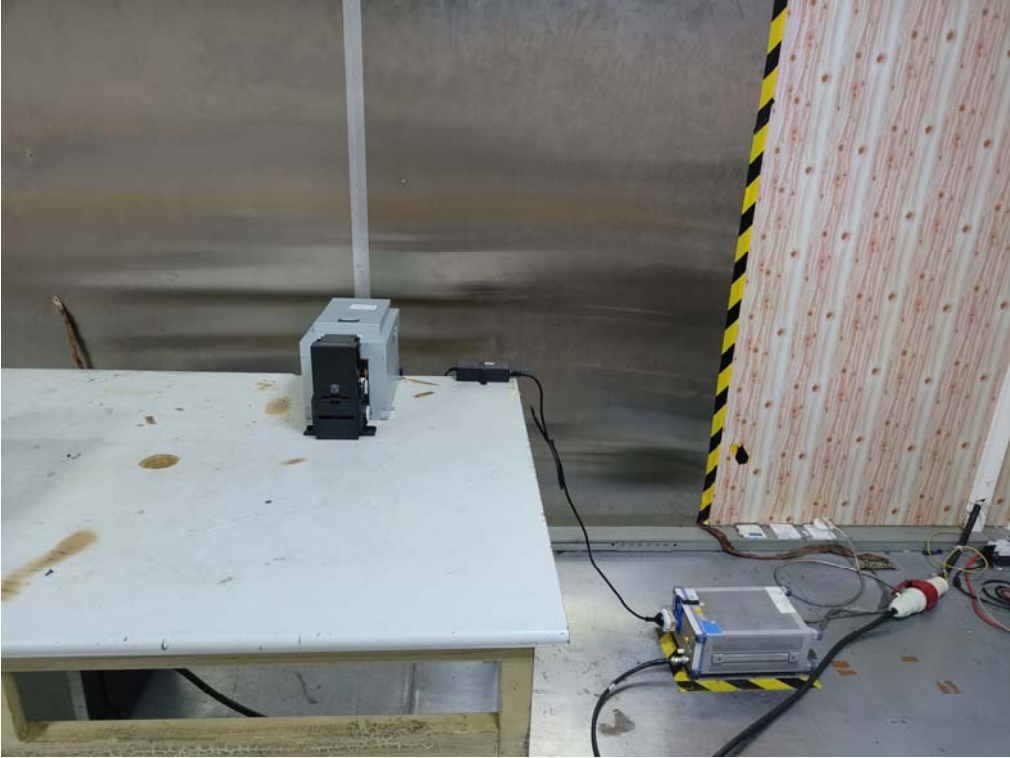

M/N: DC-2300

Radiated Test (Below 30MHz)

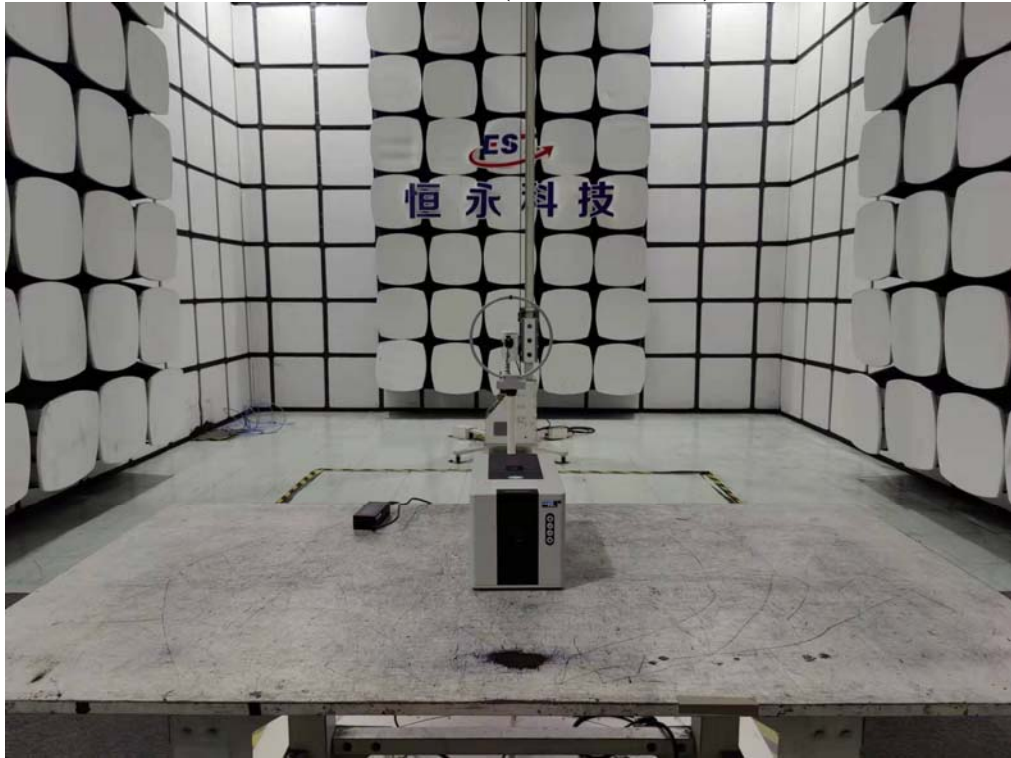

Radiated Test (Above 30MHz)

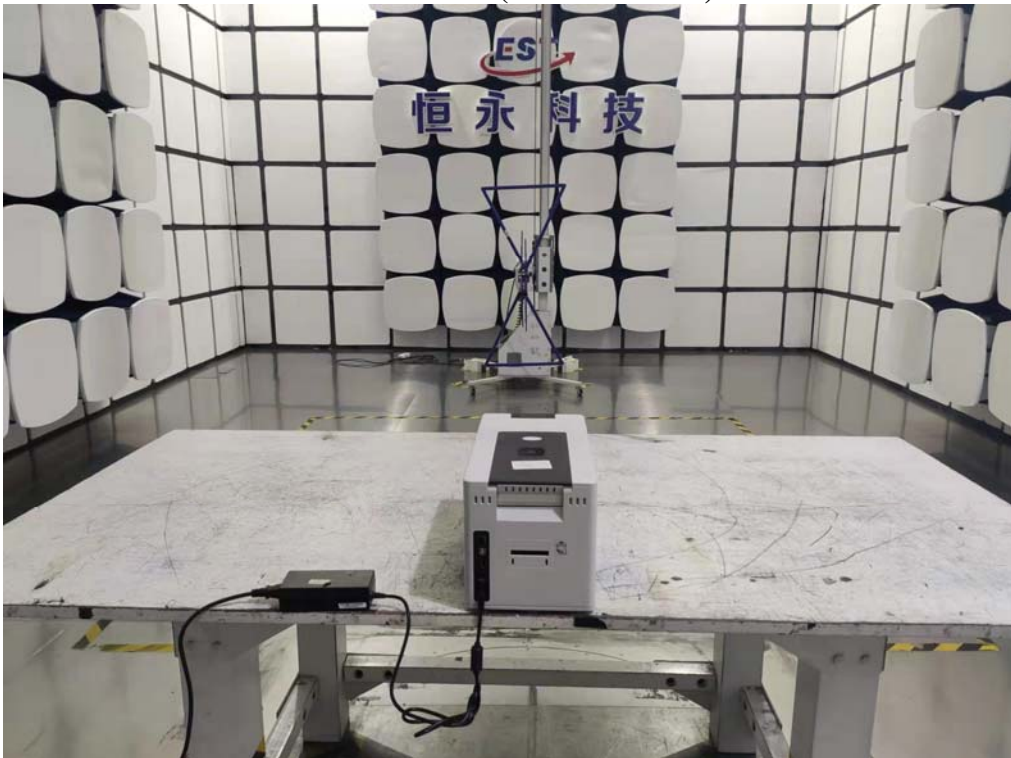

M/N: KT-200

Radiated Test (Above 30MHz)

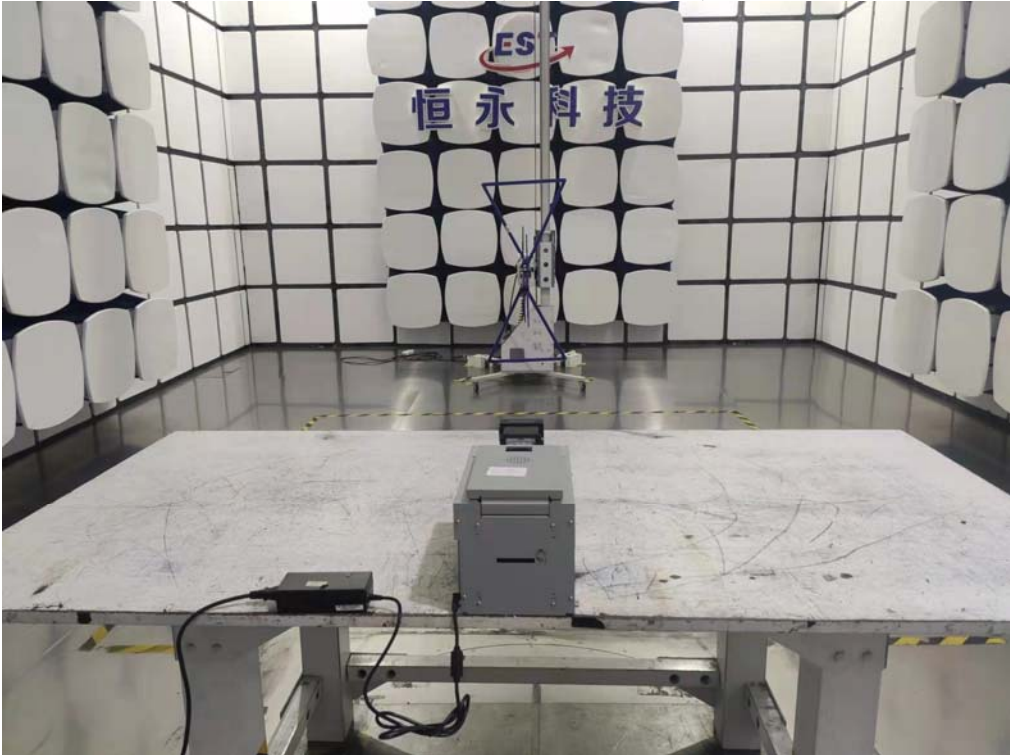

9. EUT PHOTO

External Photos for models DC-2300, DC-2350, DC-240, DC-250, KT-200

External Photos



External Photos



External Photos



External Photos



Internal Photo for models DC-2300, DC-2350, DC-240, DC-250, KT-200

Internal Photos

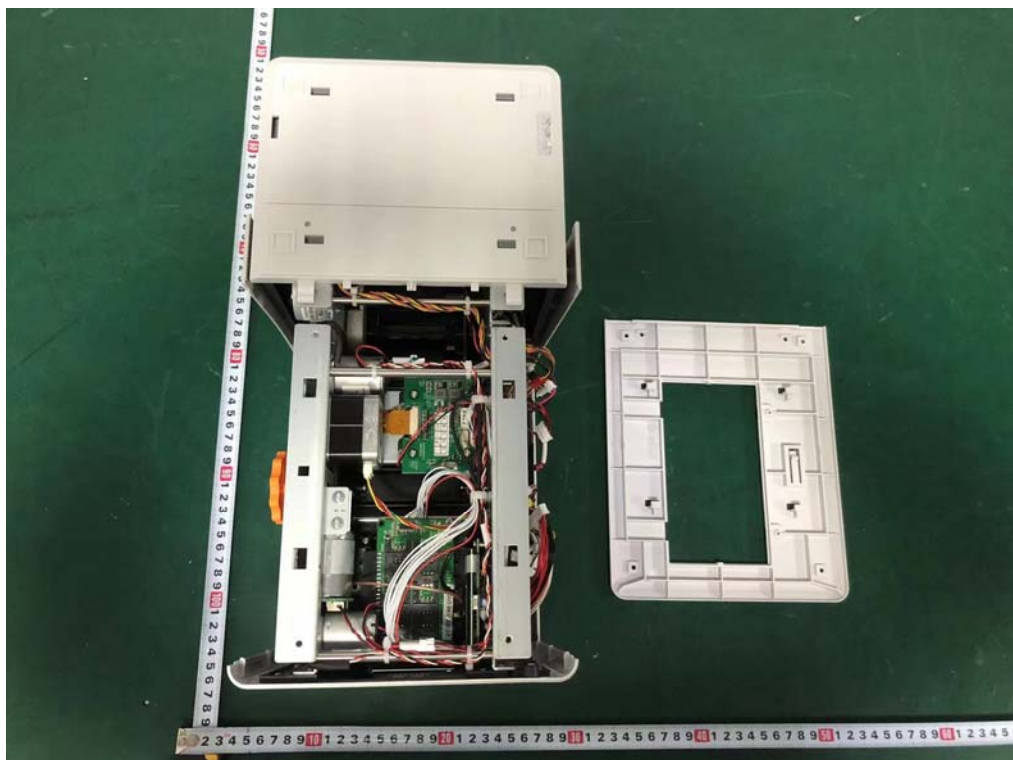

Internal Photos



Internal Photos

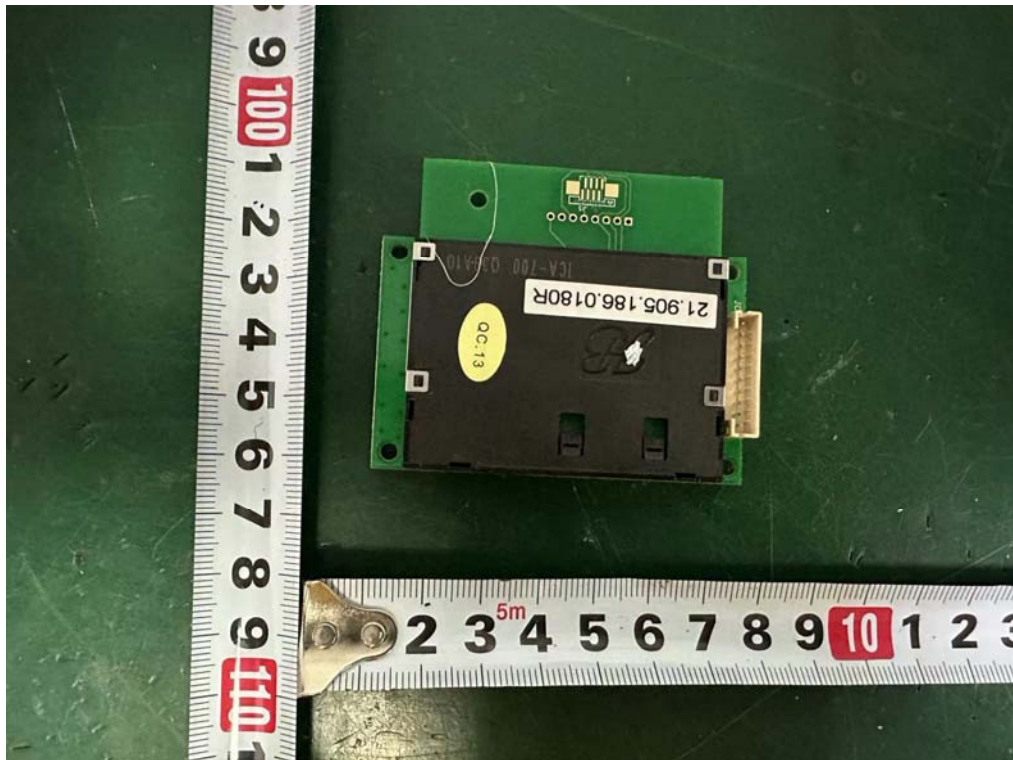
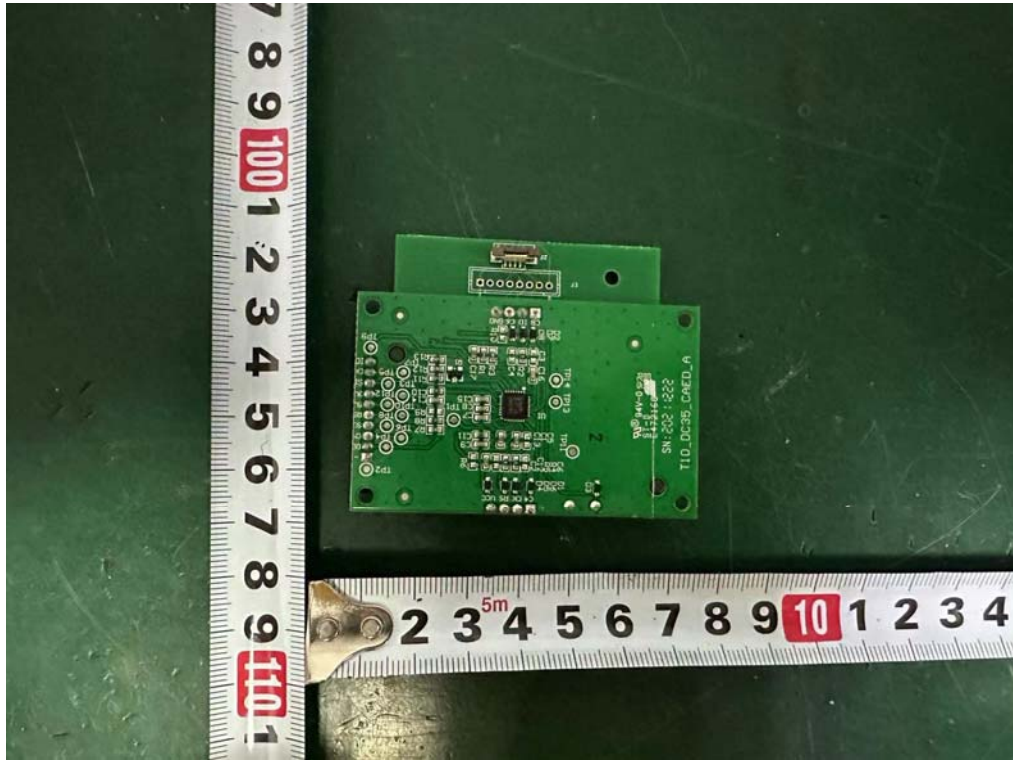

Internal Photos

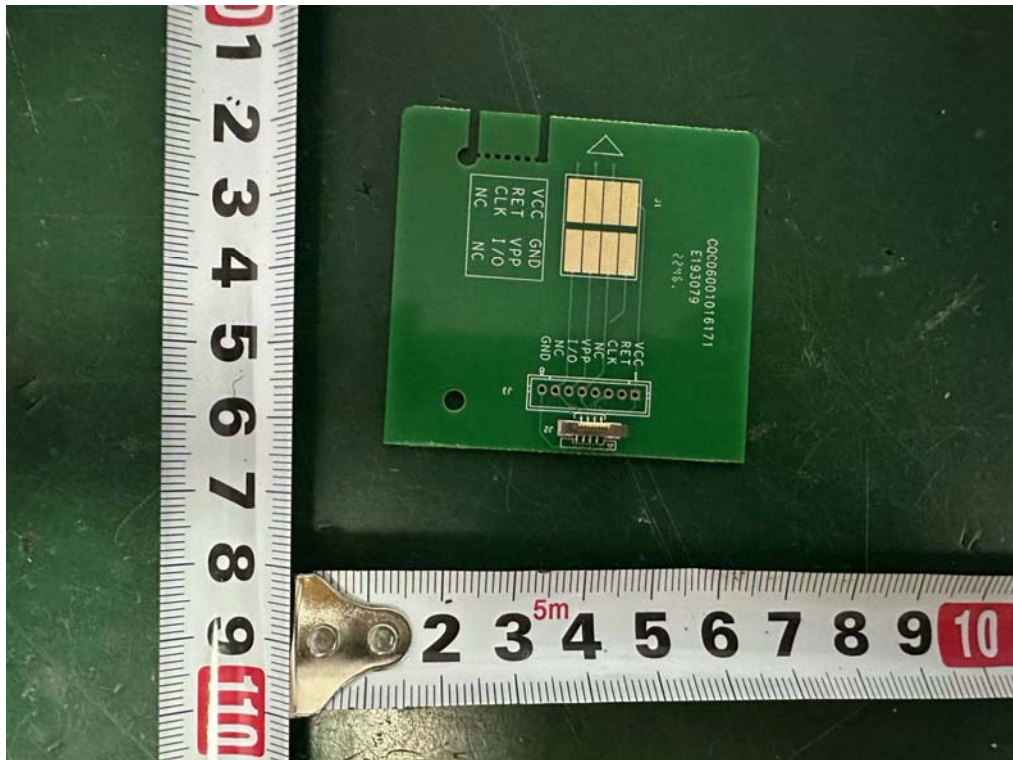
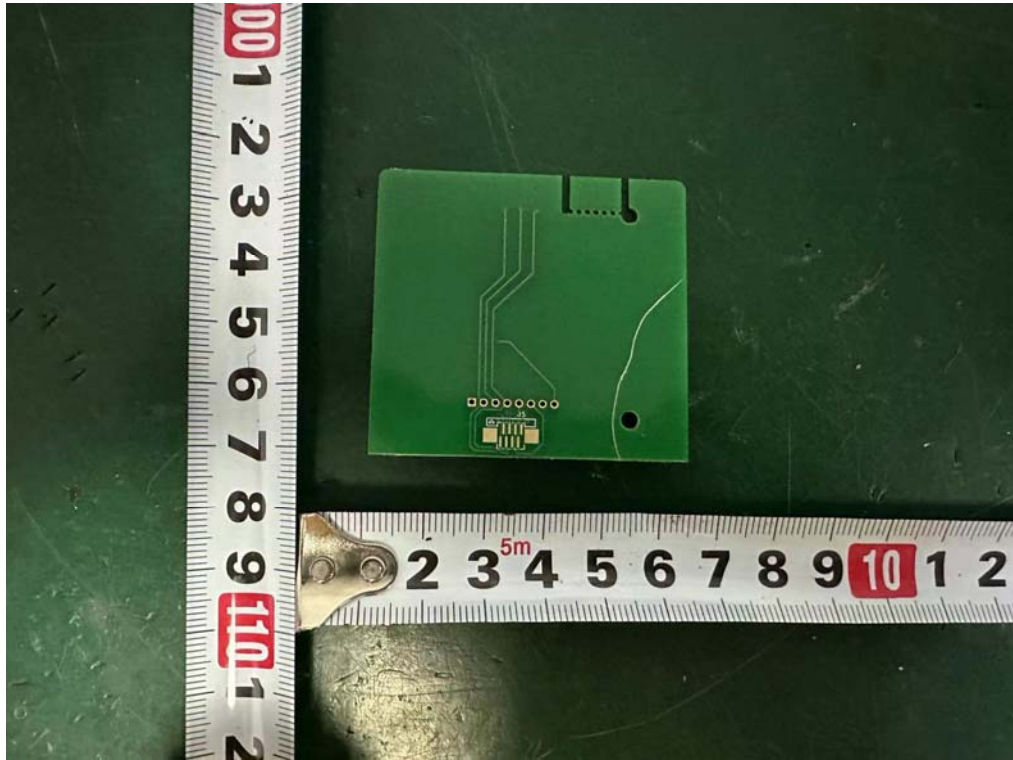

Internal Photos

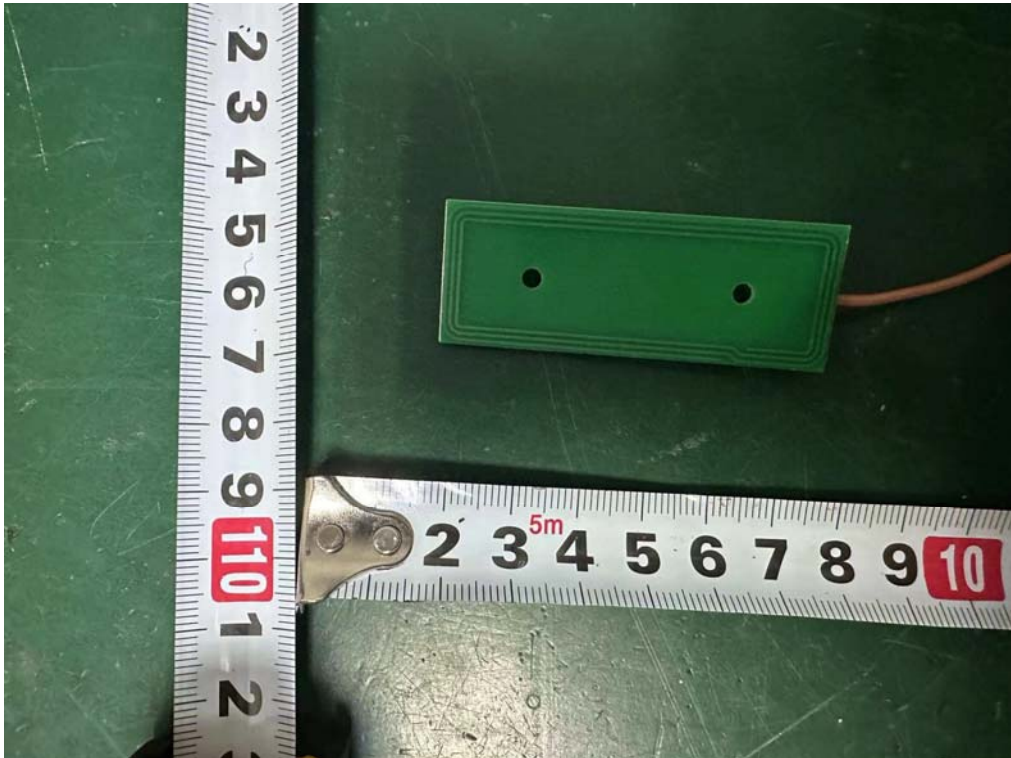
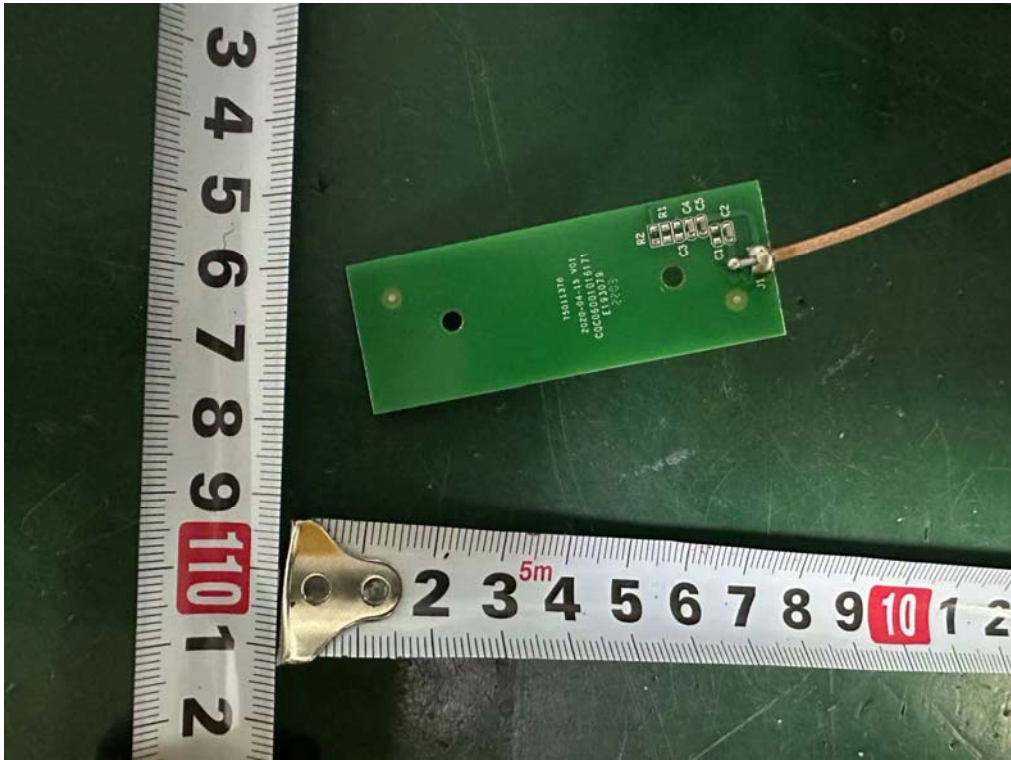

Internal Photos

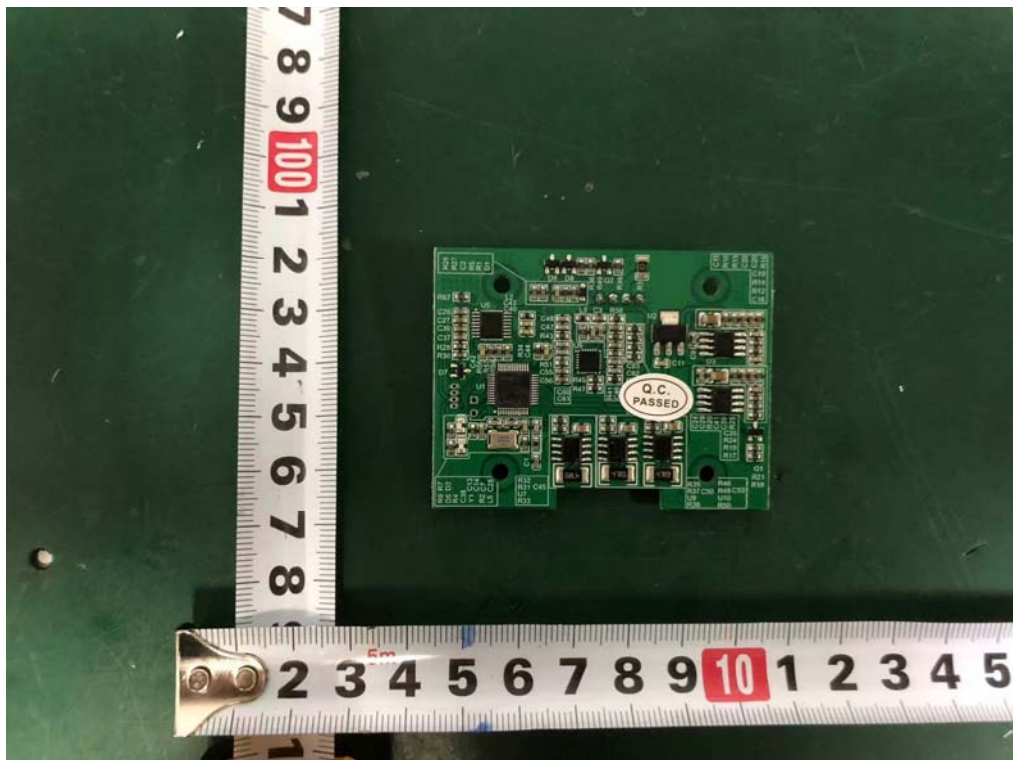
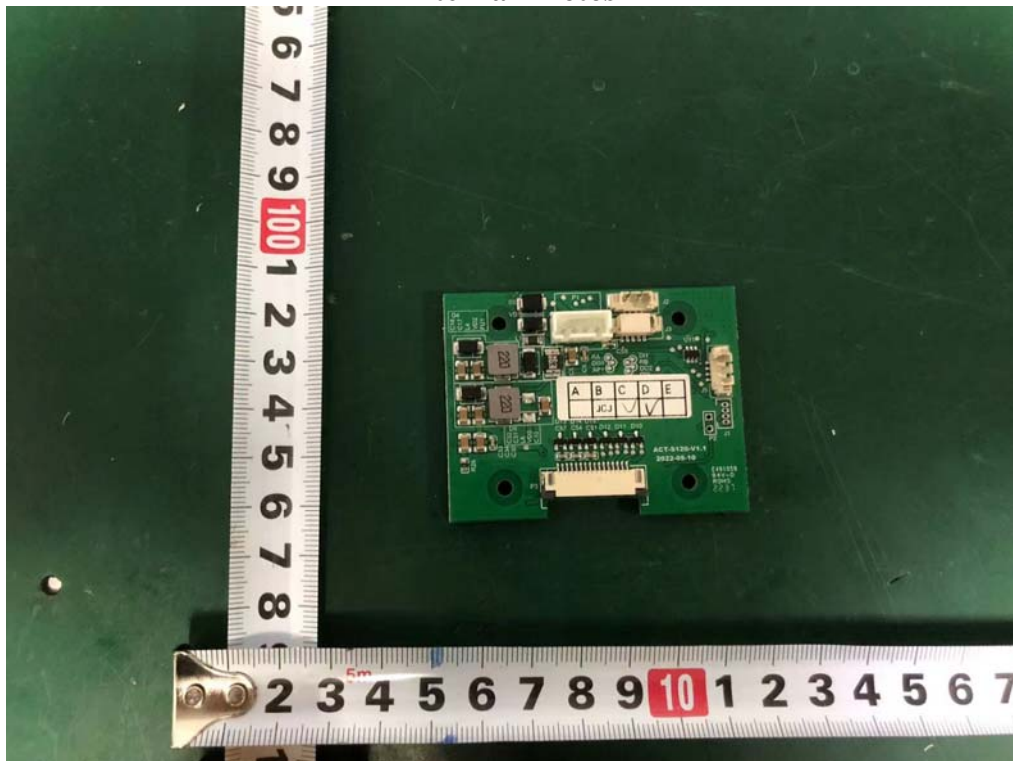

Internal Photos

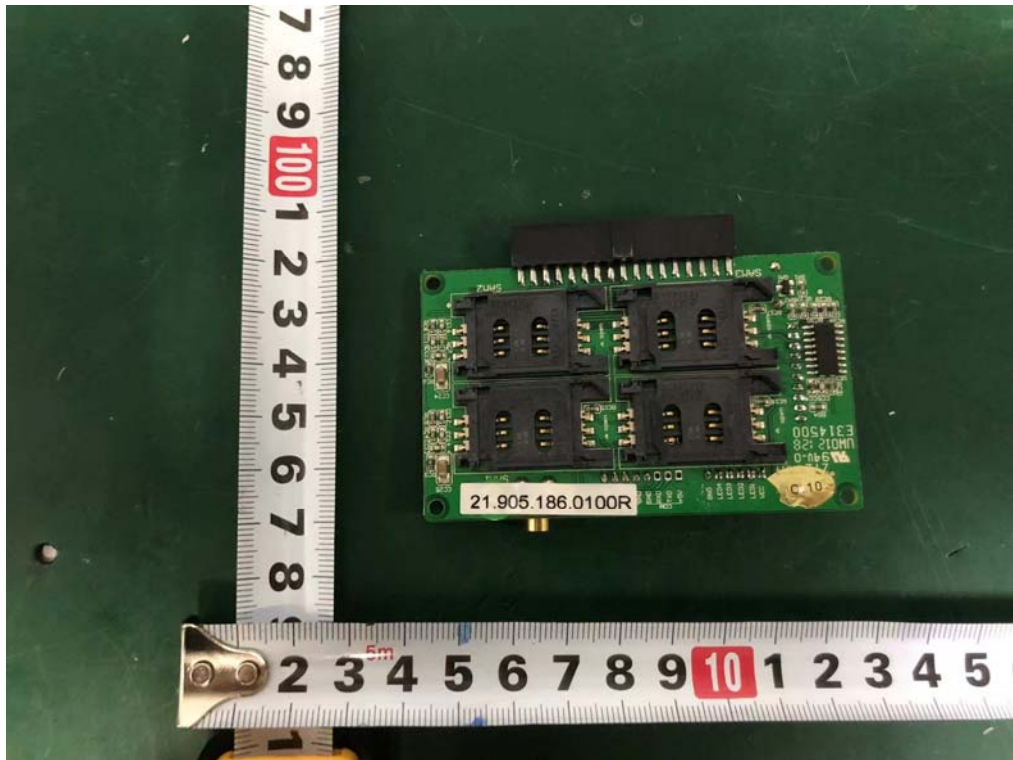

Internal add two optional mainboard Photo for all models. The circuit schematic and PCB diagram of the two optional mainboard are the same, the difference is only that I/O interface are different installation way . Internal add two optional mainboard Photo for all models

Optional mainboard 1 Photo

Internal Photos

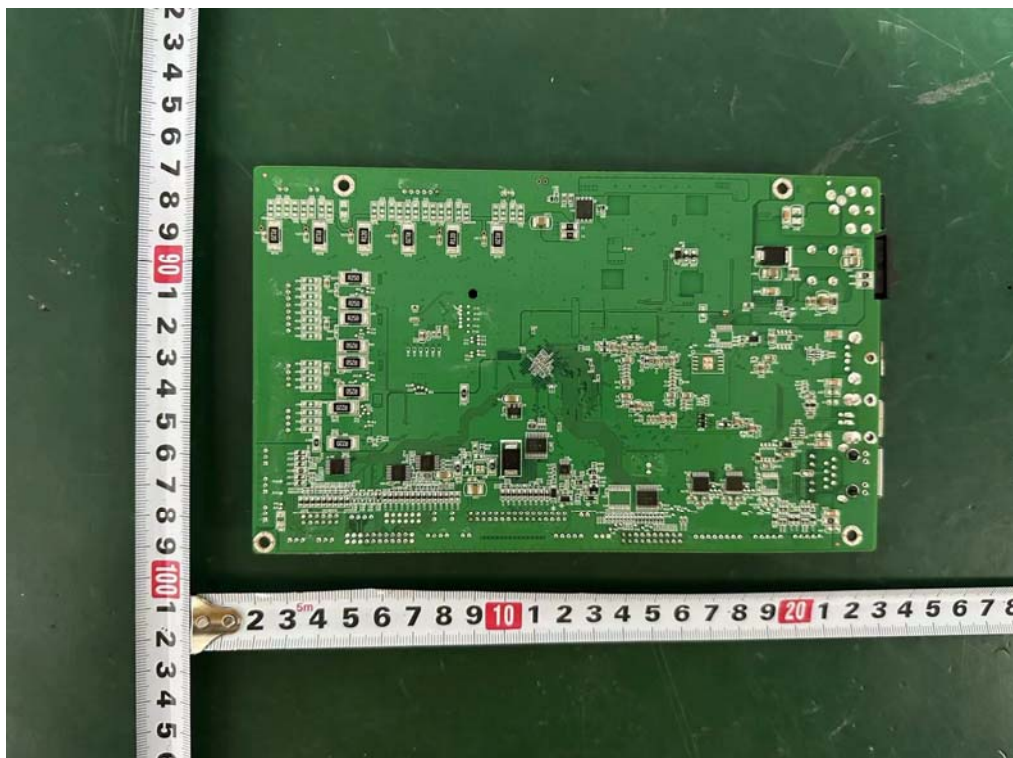
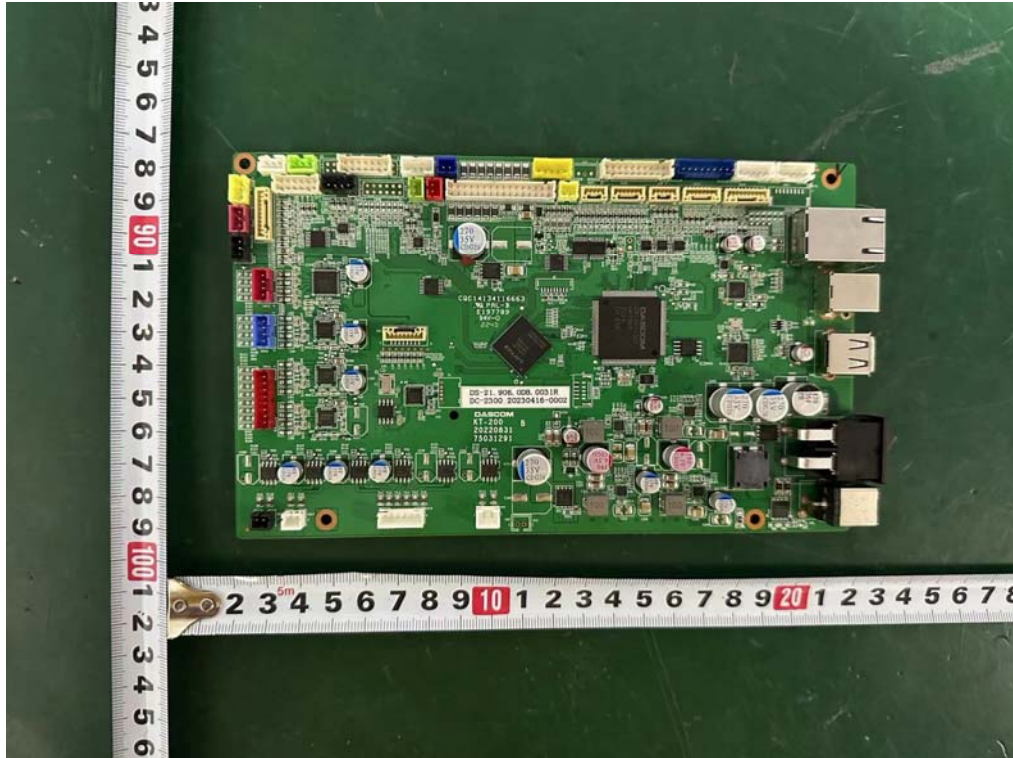

Optional mainboard 2 Photo

Internal Photos

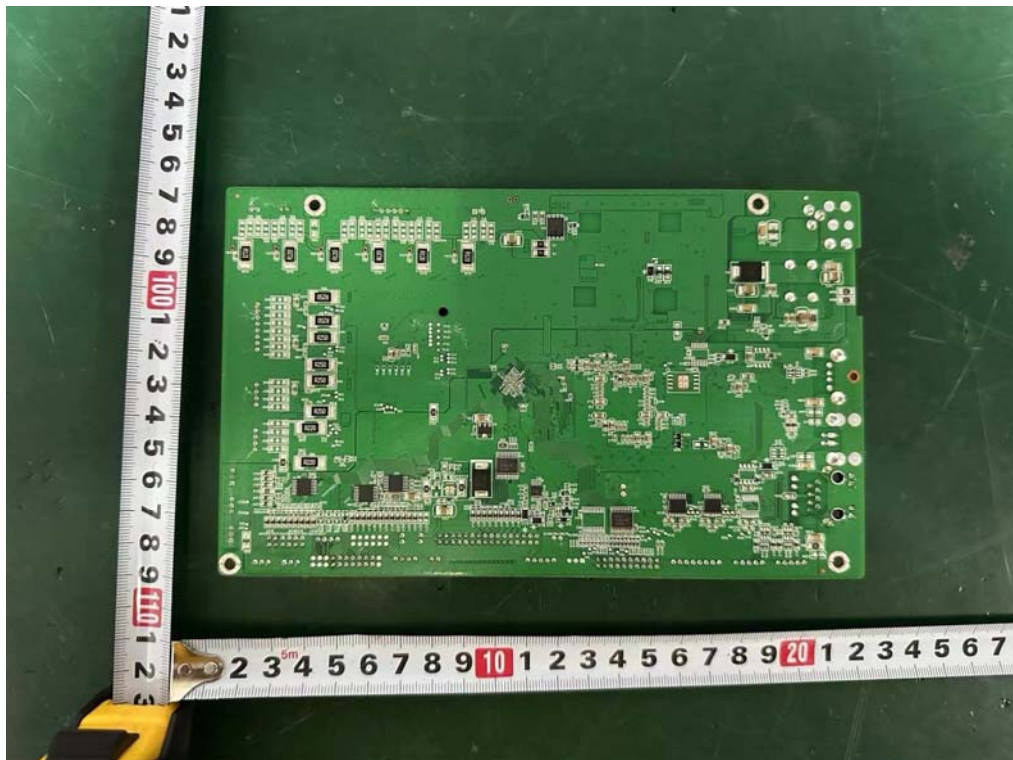

External Photos alternative optional shells

External Photos



External Photos

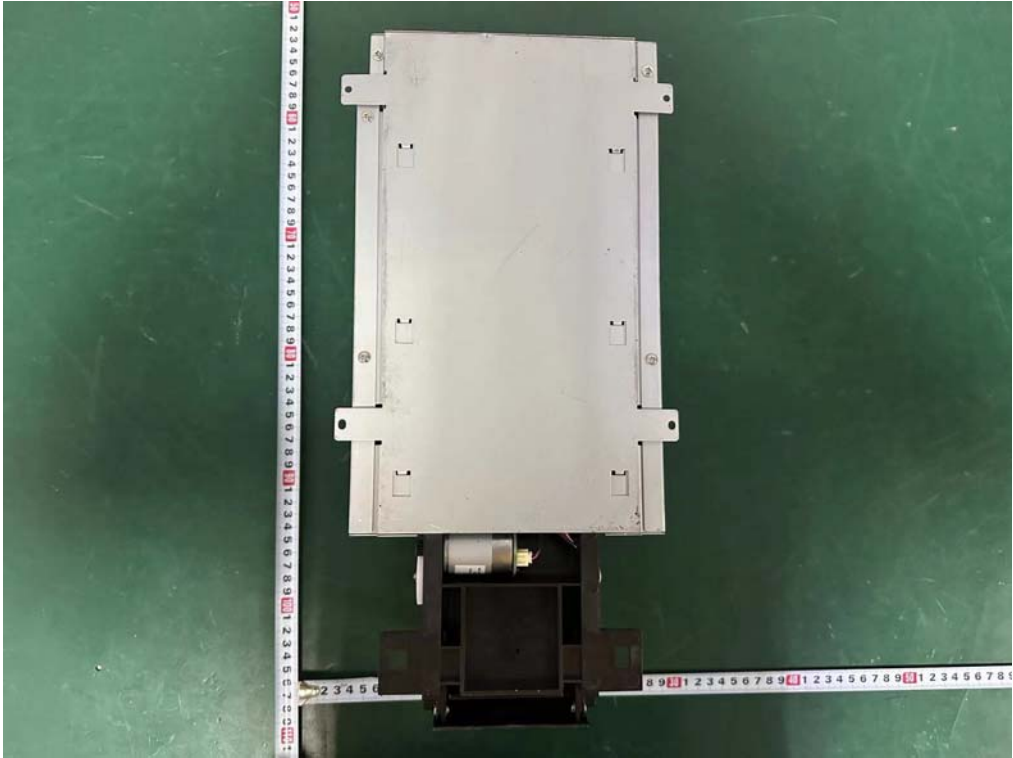

External Photos

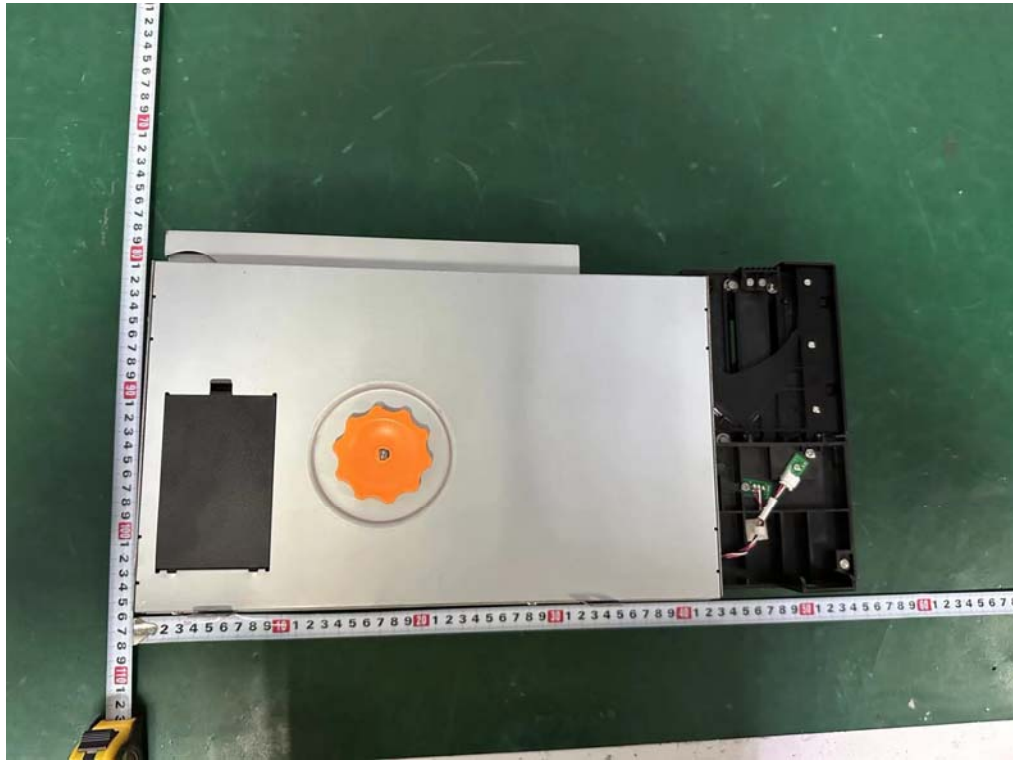

External Photos



Internal Photo for alternative optional shells

Internal Photos

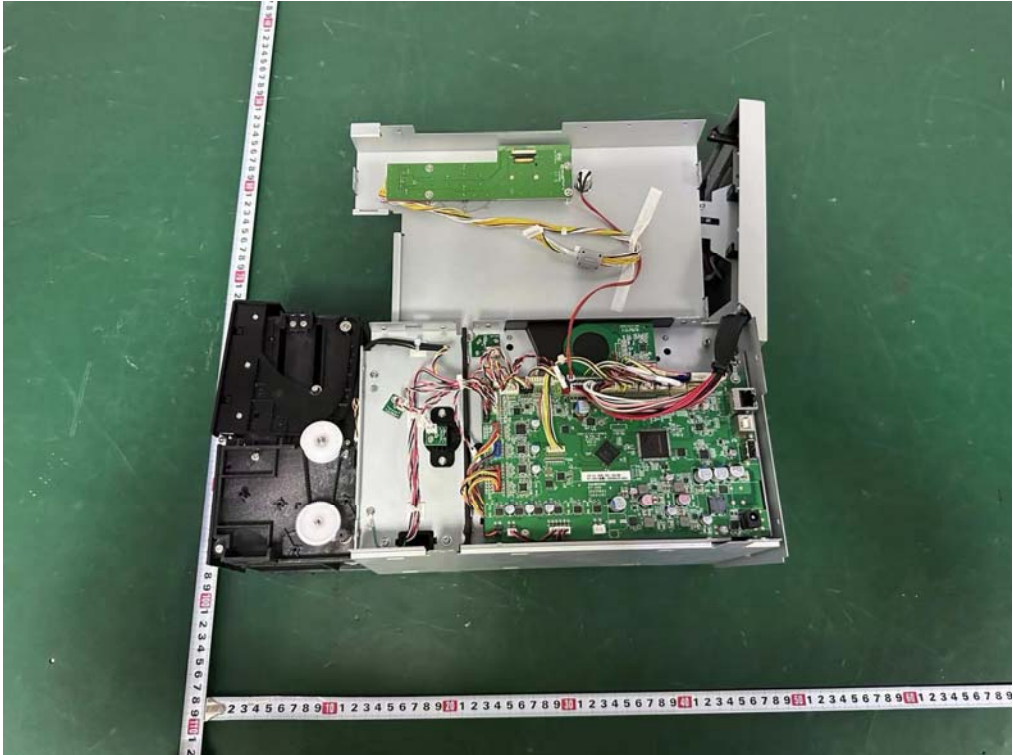

End of Test Report