

FieldPro 641 Series

Operator's Manual



PRINTEKMOBILE™

Printek, LLC
3515 Lakeshore Drive
Saint Joseph, MI 49085-2977
269-925-3200
www.printek.com

Printek, LLC. A **DASCOM** Company.



This device complies with Part 15 of the FCC Rules. Operation is subject to the following two conditions: (1) this device may not cause harmful interference, and (2) this device must accept any interference received, including interference that may cause undesired operation.

This equipment has been tested and found to comply with the limits for a Class B digital device, pursuant to Part 15 of the FCC rules. These limits are designed to provide reasonable protection against harmful interference in a residential installation. This equipment generates, uses, and can radiate radio frequency energy and, if not installed and used in accordance with the instructions, may cause harmful interference to radio communications. However, there is no guarantee that interference will not occur in a particular installation. If this equipment does cause harmful interference to radio or television reception, which can be determined by turning the equipment off and on, the user is encouraged to try to correct the interference by one or more of the following measures:

- Reorient or relocate the receiving antenna.
- Increase the separation between the equipment and the receiver.
- Connect the equipment into an outlet on a circuit different from that to which the receiver is connected.
- Consult the dealer or an experienced radio/TV technician for help.

This equipment complies with Canadian and FCC radiation exposure limits set forth for an uncontrolled environment. This transmitter must not be co-located or operating in conjunction with any other antenna or transmitter.

Part 15.21 Caution: Changes or modifications not expressly approved by Printek could void the user's authority to operate the equipment.

RF warning statement:

The device has been evaluated to meet general RF exposure requirement. The device can be used in portable exposure condition without restriction.

This device contains licence-exempt transmitter(s)/receiver(s) that comply with Innovation, Science and Economic Development Canada's licence-exempt RSS(s). Operation is subject to the following two conditions:

- (1) This device may not cause interference.
- (2) This device must accept any interference, including interference that may cause undesired operation of the device.

L'émetteur/récepteur exempt de licence contenu dans le présent appareil est conforme aux CNR d'Innovation, Sciences et Développement économique Canada applicables aux appareils radio exempts de licence. L'exploitation est autorisée aux deux conditions suivantes :

- 1) L'appareil ne doit pas produire de brouillage;
- 2) L'appareil doit accepter tout brouillage radioélectrique subi, même si le brouillage est susceptible d'en compromettre le fonctionnement

The SAR limit of Canada (ICES) is 1.6 W/kg for head averaged over one gram of tissue. Device types DP-641,FP641 (Model) (IC: 28818-FP641) has also been tested with 0mm against this SAR limit.

The SAR limit of USA (FCC) is 1.6 W/kg for body averaged over one gram of tissue. Device types DP-641,FP641 (Model) (FCC ID: Z70FP641) has also been tested with 0mm against this SAR limit.



This device fulfills the European standards requirements by complying with the Directive relating to electromagnetic compatibility and relating to low-voltage electrical equipment. Furthermore it fulfills the requirements for RoHS and R&TTE if applicable.

Conformity with the above mentioned Directives is indicated by the CE symbol attached to the device.

Note: Conformity may be affected by:

- using interface cables not complying with the specifications
- non-observance of important instructions in the operator's manual
- installing components not approved for this device by the manufacturer
- unauthorized manipulation



Dieses Gerät erfüllt die Anforderungen der Europäischen Normen durch Einhaltung der Richtlinien bezüglich der Elektromagnetischen Verträglichkeit sowie bezüglich Elektrischer Betriebsmittel mit Niederspannung. Des Weiteren werden die Anforderungen bezüglich RoHS und falls anwendbar R&TTE erfüllt.

Die Konformität zu den oben angeführten Richtlinien ist durch das am Gerät angebrachte CE-Zeichen gekennzeichnet.

Hinweis: Die Konformität kann beeinflusst werden durch:

- Benutzung von nicht spezifizierten Schnittstellen
- Nichtbeachtung wichtiger Hinweise der Bedienungsanleitung
- Ersetzen von Bauteilen, die nicht vom Hersteller für dieses Gerät freigegeben wurden
- Fingriffe durch Unbefugte



This device complies with the requirements of the United Kingdom (UK) legislation of Electrical Safety Regulations, Electromagnetic Compatibility Regulations, if applicable the Radio Regulations and the Restriction of the Hazardous Substances in Electrical and Electronic Equipment Regulations.



 (Waste electrical products should not be disposed of with household waste. Please recycle where facilities exist. Check with your Local Authority or local store for recycling advice.)

Battery Disposal

Only dispose of used batteries according to your local regulations. If you do not know your local regulations, the Rechargeable Battery Recycling Corporation (RBRC) is a non-profit organization created to promote recycling of rechargeable batteries. For more information visit www.rbrc.org.



Acknowledgments:

Printek is a registered trademark of Printek, LLC

Bluetooth is a registered trademark of Bluetooth SIG, Inc.

Zebra, CPCL and ZPLare registered trademarks of Zebra Technologies

Wi-Fi is a registered trademark of the Wi-Fi Alliance

Windows is a registered trademark of Microsoft Corporation

All other trademarks are the property of their respective owners.

© 2017 By Printek LLC, 3515 Lakeshore Drive, Saint Joseph, MI 49085-2977. All rights reserved.



Read all set up and operating instructions before proceeding with operation. Do not operate in an enclosure unless properly ventilated. Do not operate near a heat source.



Lesen Sie vor der Inbetriebnahme die Aufbau- und Bedienungsanleitung. Betreiben Sie den Drucker nicht in einem kleinen, geschlossenen Raum, es sei denn dieser wird ordnungsgemäß belüftet. Nehmen Sie den Drucker nicht in der Nähe einer Wärmequelle in Betrieb.



No user-serviceable parts inside. Refer service or repairs to a qualified service professional. Use of genuine Printek replacement parts is required to warrant proper, safe operation. Any alteration or modification of this device voids the user warranty and may make the product unsafe to operate. The print head and motors get hot during use. Wait until they cool before touching them. Make certain the printer is disconnected from AC power before removing any covers or performing any required cleaning or maintenance. Connecting this printer to an ungrounded receptacle can result in electrical shock. Never place the printer near inflammable or explosive substances. Do not operate near liquid or spill liquid into the printer at any time.



Enthält keine Teile, die vom Bediener instandgesetzt werden können. Bitte wenden Sie sich bei Instandsetzung oder Reparatur an qualifiziertes Kundendienstpersonal. Die Verwendung von echten Printek Ersatzteilen ist notwendig, um ordnungsgemäßen, sicheren Betrieb zu gewährleisten. Änderungen oder Modifikationen dieses Geräts machen die Garantie ungültig und können den sicheren Betrieb des Produkts gefährden. Während des Druckens werden Druckerkopf und Motoren heiß. Warten Sie, bis sich die Teile abgekühlt haben, bevor Sie sie berühren. Vergewissern Sie sich, dass der Drucker nicht mehr an die Stromquelle angeschlossen ist, bevor Sie Abdeckungen abnehmen oder das Gerät reinigen bzw. warten. Schließen Sie diesen Drucker nicht an eine ungeerdete Steckdose an; dies kann zum Elektroschock führen. Setzen Sie den Drucker niemals in die Nähe von feuer- oder explosionsgefährlichen Stoffen. Betreiben Sie den Drucker nicht in der Nähe von Flüssigkeiten und lassen Sie keine Flüssigkeiten in den Drucker gelangen.

Specifications are subject to change without notice.

TABLE OF CONTENTS

Introduction	2
Printer Features	3
Quick Start Instructions	4
A. Paper Load	4
B. Battery Installation	5
C. Charge Battery.....	5
D. Power On.....	5
E. Control Panel.....	6
F. Setting Descriptions.....	6
G. Performing a Printer Self-Test	6
Configuration	7
A. Connectivity Parameters.....	8
B. Image Parameters	12
C. Device Config	13
D. Fonts.....	15
E. Graphics	16
F. Update Printer Firmware, Upload Files to Printer Memory	17
G. Reset Printer Configuration to Factory Defaults (Safe Mode)	17
Printing Modes	18
A. ASCII Based Print Jobs	18
B. Graphic Based Print Jobs	18
Integrating the Printer into your Business Applications	19
A. Windows Desktop Computers	19
Print Drivers.....	19
I. USB	19
II. Bluetooth – General.....	19
III. Bluetooth – Windows 7 and above	19
IV. Wi-Fi	20
B. Windows Tablets and Smartphones	20
C. Android Tablets & Smart phones.....	20
I. Bluetooth	20
II. Wi- Fi	21
D. Apple™ Tablets & Smartphones	21
I. Bluetooth	21
II. Wi-Fi	21
Media	22
A. Standard Media	22
B. Black Mark Media Position	22
Maintenance and Troubleshooting	23
A. Cleaning.....	23
B. Battery Care.....	23
I. Getting the Maximum Battery Life	23
II. Charging the Battery.....	23
III. Additional Battery and Safety Information	24
IV. Testing the Power Adapter and Battery.....	24
C. Troubleshooting.....	25
I. General Error Conditions	25
II. Fault Description and Resolution.....	25
D. Obtaining Service	26
APPENDIX	28
A. Appendix A – FieldPro 641 Printer Specifications	28
Glossary of Terms	29
Index	30

Introduction

Thank you for purchasing the Printek FieldPro 641 Series mobile thermal printer also referred to in this manual as the “FP641”. The FP641 series prints on special thermal media supplied in roll form up to 4.1 inches wide. All models are equipped with a USB port which supports cabled communications. All models support an optional internal Bluetooth or Wi-Fi interface. Complete specifications may be found in [Appendix A – FieldPro 641 Printer Specifications](#).

The remainder of this manual focuses on preparing the printer for initial use and performing tasks that will be encountered during daily use.

[Maintenance and Troubleshooting](#) describes how to maintain the printer for optimal performance and has information on how to diagnose any problems that may occur.

Printek recommends using genuine Printek supplied media and accessories. For detailed lists, please contact your PrintekMobile sales representative.

Printer Features

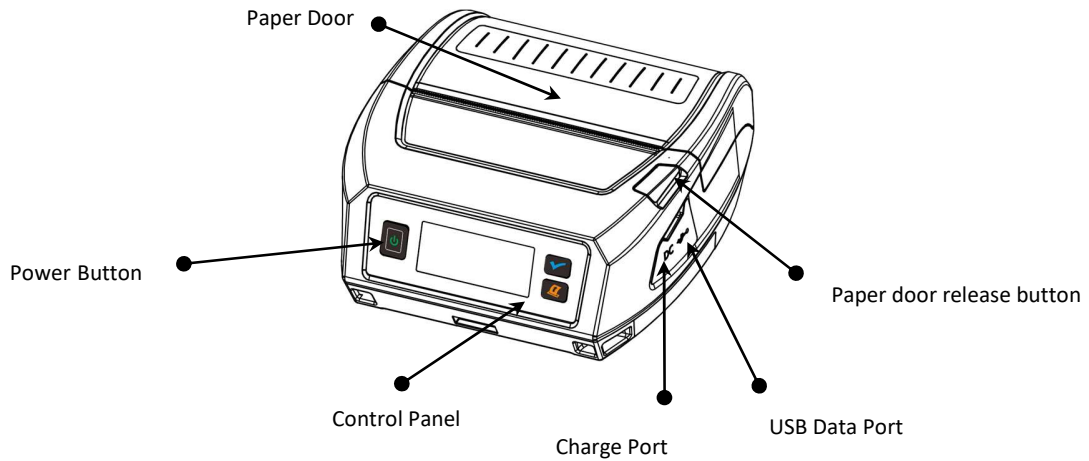

Your FieldPro 641 features:

- Easy-to-read control face and simple drop-in paper loading
- Quickly prints a wide variety of tickets, and receipts.
- IP54 rated for water and dust resistance... plus rated for repeated 6-foot drops to concrete
- Print speeds up to 6 ips
- Extensive fonts, character sets, bar codes and graphic capabilities
- Printer configuration is quick and easy with a web based interface
- The latest in battery technology provides for full-shift printing in all modes
- Compatible with Windows, Windows Mobile, Apple iOS, and Android
- Emulations that allow the printer to be a drop-in replacement for nearly any mobile printer

For detailed specifications reference [Appendix A – FieldPro 641 Printer Specifications](#).

Quick Start Instructions

A. Paper Load

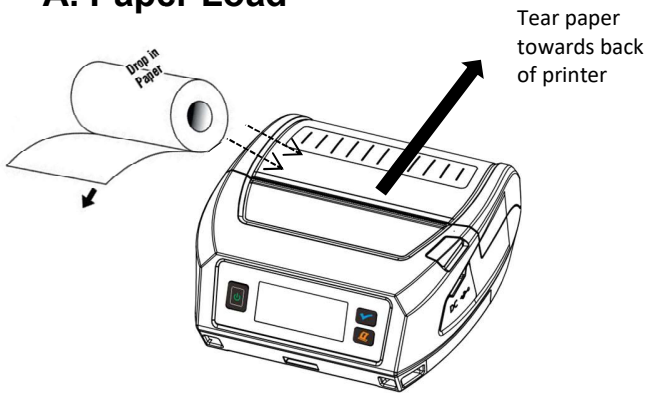

Press Paper door release button to open the paper compartment door.
Pull small leader of paper out and close paper door.
“ Clicks” when properly closed.

B. Battery Installation

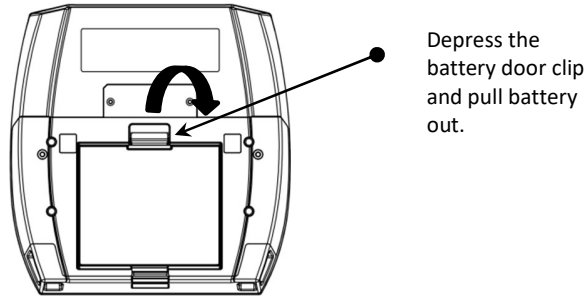

The battery icon on the display will indicate the battery level.

Disposal

Please dispose the batteries separately and free of cost at your sales agency or the designated local collecting points.

Therefore please consider the national recycling standards!

Disassembly and removal of the batteries are described in the User Guide.



C. Charge Battery



Uncover the printer ports and plug in your AC power adapter to the Power port (must be a Printek-supplied accessory). The yellow LED will show solid ON while the printer battery is charging.

D. Power On

Depress the Power button on the control panel. The red, green and yellow LED will be lit while the printer is going through its startup sequence (about 20 seconds). The red LED will go off, leaving the green LED on to indicate the printer is ready to print.

E. Control Panel

Power & Status (Green)		Power & Status (Yellow)		Power & Status (Red)		Indication
On		Off		Off		Power supplied by battery
On		Off		Off		Power supplied by adapter
Off		On		Off		Charging battery
Off		On		Off		Booting up
Off		Off		On		Power up/down
Off		Off		On		Battery failure
Flashing (If no battery is charged)		Flashing (If battery is being charged)				Config mode

	Function:	How to:
Power Button 	Power up / Power down Access to Web page	Press & Hold Press Twice
Menu Button 	Menu setup	Press Once
Paper Feed Button 	Advance paper Select menu Self-test print	Press & Hold Press Once Press Twice

F. Setting Descriptions

System Config		
LCD Contrast	Adjust LCD brightness	1*,2,3,4,5

Image Config		
Emulation	Allows for use of different print commands	ESCPOS*,ZPL,CPCL,PRINTEK

Device Config		
Max paper speed	Selects print speed	1ips, 1.5ips, 2.0ips, 2.5ips, 3.0ips, 3.5ips, 4.0ips, 4.5ips, 5.0ips, 5.5ips, 6.0ips*
Mark seek	Selects type of paper	Rollpaper*, front, rear, gap
Power sleep	Sets energy setting	Disable, 30 seconds, 1min*, 2min, 5min, 10min
Paper size	Selects print size	2 inch, 3 inch, 4 inch*
Contrast	Sets print darkness	1, 2, 3, 4, 5*, 6, 7, 8, 9, 10
Left margin	Sets left offset	0 inch*, 1inch, 2inch/0mm* to 50mm
Unit	Set unit	Inch*, mm

BT Config		
On/off	Turn bluetooth on or off	On,off
BT address	Display BT address	/
BT Pin	Display BT Pin	/
BT Name	Display BT name	/
BT Paired Mode	Display BT Paired Mode	/

Wireless Config		
Wireless method	Select wifi mode	Static,DHCP,Access point
IP ADDRESS	Display IP ADDRESS	/
NETMASK	Display NETMASK	/
WIFI BROADCAST	Display BROADCAST	/
SSID	Display SSID	/
WIFI PORT	Display WIFI PORT	/
WIFI MAC	Display WIFI MAC	/

About		
Model	Display printer model	/
SN	Display printer SN	/
Vkernel	Display printer vkernel	/
Vpsw	Display printer vpsw	/
Vcsw	Display printer vcsw	/
Vfpga	Display printer vfpga	/

Reset printer		
Do not reset	/	/
Reset all settings	/	/
Reset image cfg	/	/
Reset device cfg	/	/
Reset bt cfg	/	/
Reset wifi cfg	/	/

BAT INFO		
CAP	Display battery capacity	/
TEMP	Display battery temperature	/
STAT	Display battery status	Discharging,charging,FULL, unknow

G. Performing a Printer Self-Test



With power on, press the paper feed button twice quickly.

Configuration

Configuration of the FP641 printer is done through a built-in web page. This allows you to configure the printer from any device that has a browser and is compatible with your FP641 communication capabilities.

1. Turn the printer ON.
2. Connect a USB cable between the printer and a PC.
3. To access the FP641 web page, push the Power button twice rapidly. This will put the printer into Configuration mode.
4. When the printer is in Configuration mode the POWER LED will flash.
 - a. Open browser on your PC and type **169.254.200.1** into the address bar of the browser and hit Enter - A login box should appear:

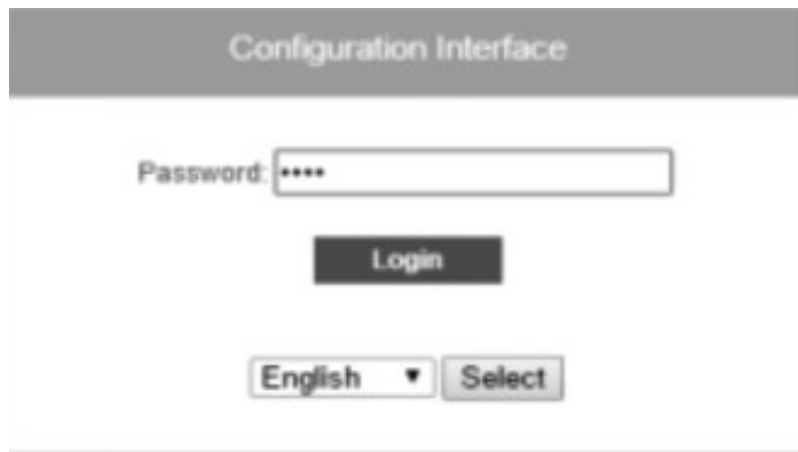

- b. Type "0000" and hit Enter- you should now be at the home page for FP641 Configuration.

5. The main configuration screen of the FP641:

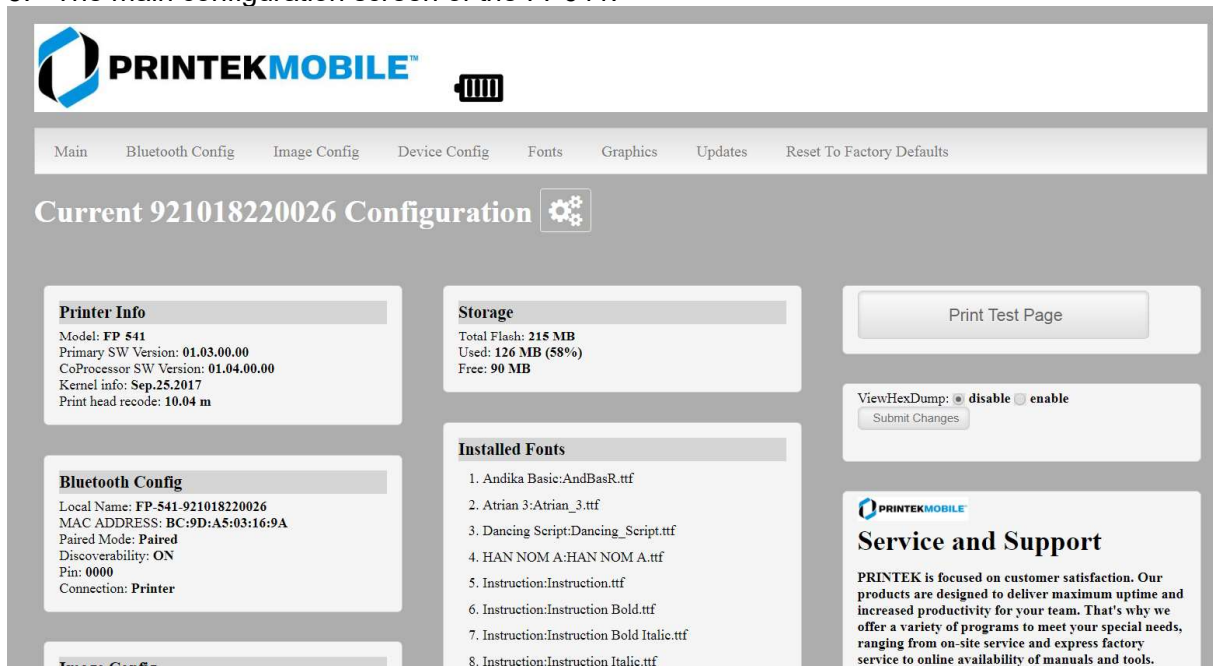

This is an overview of the printer configuration. The battery icon shows the relative charge in the battery. The more bars, the higher the charge. An AC plug will appear in the battery icon when the printer is plugged into an external power source.

To return the printer to normal operating mode, double-click the Power button. The POWER LED will be returned to a solid light.

At the top of the Main Page are selections to access the sub-menus.



Wherever the book icon appears in the printer configuration pages, click it to access the user manual pages for help.

A. Connectivity Parameters

This page allows you to setup the connection to your printer. Depending on the optional interface installed, you will see either Bluetooth Config or WI-FI Config. In the detailed descriptions, an asterisk (*) indicates the factory default value.

Bluetooth Config:

The screenshot shows the 'Bluetooth Config' page of the Printek Mobile web interface. At the top, there is a navigation menu with links for 'Main', 'Bluetooth Config', 'Image Config', 'Device Config', 'Fonts', 'Graphics', and 'Updates'. The 'Bluetooth Config' page features a header with the Printek Mobile logo and a printer icon. The main content area is titled 'Bluetooth Config' with a gear icon. The configuration form includes the following fields and options:

- Local Name:** A text input field containing 'FP-541-KAB66666'.
- MAC ADDRESS:** A read-only field displaying '00:16:A4:06:B1:71'.
- Paired Mode:** Radio buttons for 'UnPaired' and 'Paired', with 'Paired' selected.
- Discoverability:** Radio buttons for 'Off' and 'On', with 'On' selected.
- Pin:** A text input field containing '0000'.
- Connection:** Radio buttons for 'Printer' and 'Personal Area Network', with 'Printer' selected.
- Buttons:** 'Submit Changes' and 'Discard Changes' buttons at the bottom of the form.

Paired Mode:

Possible values: UnPaired, Paired*

This feature allows Bluetooth pairing to occur between the printer and the connecting device whenever Pairing is required by either device. Pairing requires that the PIN on the printer and the connecting device exactly match each other.

Discoverability:

Possible Values: Off, On*

This feature is used to set whether the printer may be discovered by other Bluetooth devices. It should only be set to "Off" after the printer has been discovered and paired with a host computer.

PIN:

Possible Values: 0000*, Up to 16 Numeric Characters.

Note that this feature is only available if Pairing Mode is set to "Paired". The PIN value must exactly match the PIN value set in the Bluetooth manager on the host computer.

Connection:

Possible Values: Printer*, Personal Area Network

This feature selects the role of the printer's interface in the Bluetooth network.

In Printer mode, the printer behaves as a regular Bluetooth device.

In Personal Area Network mode, the printer behaves similar to a Wi-Fi access point.

The Power LED will flash off every two seconds while in this mode.

After pairing with the printer, the host Bluetooth icon will appear different, indicating that an access point is present.



Some hosts require an extra connect step after pairing. After connecting, the printer will issue an IP address to the host and the host can communicate to the printer as if it were a Wi-Fi printer. The printer's address to the host is always **169.254.200.1**.

In the host device's browser (if equipped) this address may be entered in the address bar to access the printer web page.

WI-FI Config:

The screenshot shows the 'Wireless Configuration' page in the Printek Mobile web interface. The page has a header with the Printek Mobile logo and a navigation menu. The main content area is titled 'Wireless Configuration' and contains a table with the following fields:

IP Address	<input type="text" value="0"/> <input type="text" value="0"/> <input type="text" value="0"/> <input type="text" value="0"/>
SubnetMask	<input type="text" value="0"/> <input type="text" value="0"/> <input type="text" value="0"/> <input type="text" value="0"/>
Gateway	<input type="text" value="0"/> <input type="text" value="0"/> <input type="text" value="0"/> <input type="text" value="0"/>
Wifi Port	<input type="text" value="8023"/>

Below the table are two buttons: 'Submit Changes' and 'Discard Changes'. At the bottom of the page, there is a section for 'Address Method' with the following options:

- Static
- DHCP
- Personal Area Network

A 'Submit Address Method Change' button is located to the right of these options.

Wireless Configuration

This will display the current Wi-Fi configuration:

IP Address – user defined. If Static Address Method is selected, type in the address the printer will use on the network.

SubNetMask – user defined. If Static Address Method is selected, type in the subnet mark of the network.

GateWay – user defined. If Static Address Method is selected, type in the gateway address of the network.

WiFi Port – user defined. Type in the IP port to be used by the printer. (default value = 8023)

Address Method – user selectable

Static – printer will always connect to the network using the IP address defined.

DHCP – printer will acquire an IP address from your network DHCP server

Personal Area Network –The printer will broadcast itself as a network connection. The Power LED will flash off every two seconds while in this mode. The SSID will be the serial number of the printer. When connecting to the printer, the passphrase is the printer's serial number.

Personal Area Network mode can also be activated outside of the printer web page. To enter Personal Area Network mode, press and hold the Power and Paper Feed buttons until the

Power and Alert LEDs light. Release both buttons, and the printer will restart in Personal Area Network mode. To exit Personal Area Network mode, press and hold the Power and Paper Feed buttons until the Power and Alert LEDs light. Release both buttons, and the printer will restart in normal Wi-Fi mode.

The screenshot shows a web-based configuration interface for a printer's network settings. It is divided into four main sections:

- Available Networks:** A table listing detected access points with columns for BSSID, Frequency, Signal Level, Flags, SSID, and an Add/Connect button.

BSSID	Frequency	Signal Level	Flags	SSID	Add/Connect
c8:b3:73:5a:2d:67	2412	183	[WPA2-EAP-CCMP-preauth][ESS]	EngineeringTest	Add/Connect
c0:56:27:71:e8:98	2412	210	[WPA-PSK-TKIP][WPA2-PSK-CCMP][WPS][ESS]	Printek3	Add/Connect
00:25:9e:77:d4:57	2437	184	[WPA-PSK-TKIP][ESS]	Printek2	Add/Connect
- Previously Connected Networks:** A table showing networks the printer has previously connected to, with columns for Network ID, SSID, BSSID, Status, Connect/Disconnect, and Remove.

Network ID	SSID	BSSID	Status	Connect/Disconnect	Remove
0	Testing	any		Connect	Remove
- Currently Configured Networks:** A table showing networks currently configured on the printer, with columns for SSID and Remove.

SSID	Remove
Testing	Remove
- Set Date:** A section with a calendar icon, a text input field for the year (currently showing 2016), and a Submit button.

Available Networks – access points detected by the printer will be displayed. Select Add/Connect to use one of these access points.

Previously Connected Networks – access points detected by the printer or added through Add/Edit Network will be displayed. Select Connect to use one of these access points, or Remove to delete it from printer.

Currently Configured Networks – access points added through Add/Edit. They may not have been connected yet. Select Remove to delete access point from printer.

Set Date – Some Enterprise network connections require this setting. Simply enter the current year.

Add/Edit Network

Enter the SSID of a network connection. If authentication is used select the authentication type. Click Next. The following form will change depending on the authentication type:

WPA-PSK

Enter the password for the network connection.

Add/Edit Network

Key Management Protocol WPA-PSK	Network Name Test1	Next
Password		
Submit Changes	Discard Changes	

WPA-EAP or IEEE8021X

These are Enterprise network settings. Consult your server manual for recommended settings.

Add/Edit Network

Key Management Protocol IEEE8021X	Network Name Test2	Next
EAP TTLS		
Phase1	Phase2	
Identity	Anonymous Identity	
Password		
Private Key Password	Private Key2 Password	
CA Certificate File	Client Certificate File	Private Key
CA2 Certificate File	Client2 Certificate File	Private Key2
Submit Changes	Discard Changes	

Upload Digital Certificate

If your enterprise network uses digital certificates as another form of authentication, you can upload the certificates here.

B. Image Parameters

This page allows you to make selections about the image to be printed.

Encoding	<input checked="" type="radio"/> GB18030 <input type="radio"/> UNICODE <input type="radio"/> UTF-8
Current Emulation	ESCPOS
Font Type	Font A Font A: 12*24 Font B: 9*17
Letter Shape	Art Style
Digit Shape	Normal
Chinese Font Type	Font A Font A: 24*24 Font B: 32*32
Character Type	Chinese Character Set
Default Line Spacing	30 Unit: point

Submit Changes Discard Changes

Current Emulation:

Possible Values: ESCPOS*, PRINTEK, ZPL, CPCL, AUTOIMAGE, PDF, POSTSCRIPT, IMAGE

The FP641 printer is capable of using several different emulation modes. This feature sets the family of printer commands that may be used by a host application program to control the various capabilities of the printer. The printer will only respond to commands valid for the currently selected emulation. For more information, please refer to the *Integrator's Guide*.

Besides the popular printer languages to choose from, the following selections allow the FP641 to print many other file formats directly, without the need for a driver.

AUTOIMAGE – selected when mixed PDF and POSTSCRIPT images are sent to the printer. The printer will determine which type of file has been sent. This can increase printer response time.

PDF – When in this mode the printer will directly print Portable Document Files (PDF).

POSTSCRIPT – When in this mode the printer will directly print Postscript formatted files (.ps). You can also use a generic Postscript driver to print when in this mode.

IMAGE – selected if just image files are being sent to the printer. When in this mode the printer will directly print the following file types: .png, .jpg, .bmp, .pbm, .svg, .tiff

Default Font:

The FP641 has the ability to use True Type Fonts. All True Type Fonts loaded into printer memory are listed here. When using emulations that do not specify the font for each line of text, select the font you would like to use as the default font. All print jobs will use the default font unless a command is sent to the printer to use another font.

Chars Per Inch and Default Text Line Spacing:

NOTE: These settings only function in Printek Emulation

This determines how large the characters are and how many characters will print in a one inch space. The higher the number, the greater the number of lines per vertical inch of print.

C. Device Config

This page allows you to set certain hardware parameters on the printer.

Device Config

Form

Units	<input type="text" value="inch"/>
Max Paper Speed	<input type="text" value="5.0"/> inches per sec.
Mark Seek	<input checked="" type="radio"/> RollPaper <input type="radio"/> Front <input type="radio"/> Rear <input type="radio"/> Gap
Paper Sensor Threshold	<input type="text" value="40"/> % range 0-100%
Backup Distance Before Printing	<input type="text" value="0.0"/> inches
Feed Distance After Printing	<input type="text" value="0"/> inches
Left Margin	<input type="text" value="0"/> inches
Contrast	<input type="text" value="5"/> 1 - 10
Power Sleep	<input type="text" value="Disabled"/> min(s)

Paper Sensitivity

Thermal paper settings: Locked  	Thermal paper type: <input type="text" value="8"/>
---	--

Units

Select between inches or millimeters. If you change units, do so before entering other settings.

Max Paper Speed

Possible values: 1.0 to 5.0 ips, Default = 5.0

When using labels or heavy paper stock, you may need to decrease the paper speed to prevent paper jams.

Mark Seeking

Possible values: Off*, Front, Rear, Gap.

Set the value when using regular or label media with black alignment marks or label media with gaps between the labels. Depending on the value selected here you may or may not see some of the sensor threshold settings listed below.

NOTE : Before adjusting black mark gap thresholds set the Mark Width to match the width of the black mark or label gap on your media.

Paper Sensor Threshold

When using paper with a black on the front adjust this setting to insure the paper stops at the black mark. Normal value is between 70-90%.

Rear Paper Sensor Threshold

This is set the same as the paper threshold, but using the rear (in lid) paper.

Gap Paper Sensor Threshold

When using labels without a Black Mark, adjust this setting to insure the label stops at the gap in between labels. Normal value is about 60%.

Backup Distance Before Printing

Used with Mark Seek. User defined. This is the distance the printer will pull in the paper before starting to print.

Stop Distance after Mark

Use with Mark Seeking. User defined. This is the distance the printer will advance the paper after the mark is detected.

Left Margin

Setting this value will tell the printer how far from the left edge of the paper to start the print job.

Contrast

Possible values 0 – 10. Default value is 5.

The lower the value the lighter the print. The higher the value the darker the print.

Power Sleep

Possible values: Disabled*, 10, 30, 60, 120, 180 minutes.

Set this value to have the printer power off after a specified tie of inactivity.

Paper Energy Values

This is a locked value. These settings are supplied by the paper manufacturer. The default settings cover most grades of paper. If you are using non-standard paper consult the paper manufacturer for recommended settings.

D. Fonts

Font Family Name	Index	Indicator(System default fonts, which cannot be removed.)
Andika Basic	A	*
Liberation Mono	B	*
MICR	C	*
Instruction	D	*
Liberation Sans	E	*
OCRA	F	*
HAN NOM A	G	*
Liberation Serif	H	*
VCR OSD Mono	I	*
Dancing Script	J	*
Atrian 3	K	*
OCR B Std	L	*

Upload Font File

Truetype Fonts (.tff, .otf, .ttc and .bdf) can be uploaded here. Languages like ZPL and CPCL can use the fonts by referring to them by their Font Family Name. Printek emulation uses the Index value when selecting a font.

Font Aliases

Languages like ZPL and CPCL can use an uploaded Font Alias Table so legacy jobs can have their font names mapped to other uploaded fonts. Contact Printek Technical Support at (800) 368-4636 for more information.

E. Graphics

This menu will allow you to load a graphics file into printer memory for use in creating your output. For instance, logos can be stored for recall and use by your host program (see *Integrator's Guide* for more details).

Logo Name	Index	Image(not actual size)	Size
Note: may need to refresh page to update mapping after upload or removal.			

Upload File

Select the graphics file to load into printer memory. Acceptable graphics formats are .jpeg, .pbm, .pcx, .bmp, .png and .svg.

Set Width

Select the width you want to use to display your logo: full width, half width, or small width.

Set index

Depending on the Index value used, you can automatically print the graphics file as a header (prints at the beginning of the print job), footer (prints at the end of a print job) or use the graphics print command to print anywhere on your receipt or label. See *Integrator's Guide* for more information on graphics commands.

When selecting header, the graphics file will automatically print the logo at the beginning of each print job. When selecting footer, the graphics file will automatically print the logo at the end of each print job.

You must set each of these values before selecting Upload Logo or the default values will be associated with your image.

Current Logo Mapping

Once uploaded into the printer memory, your image and settings will be displayed here.

F. Update Printer Firmware, Upload Files to Printer Memory

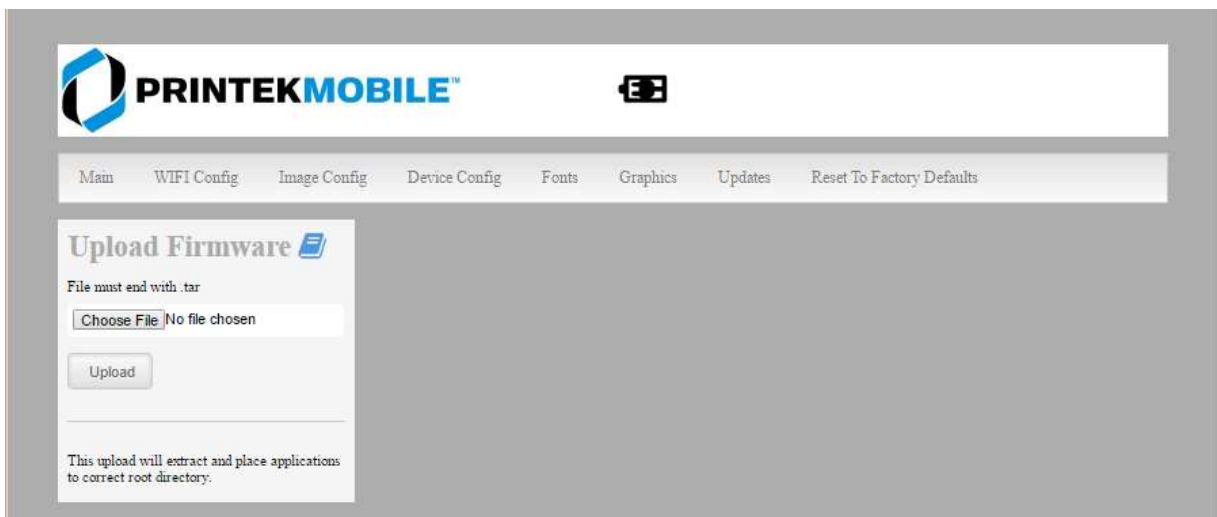

Printer Application Updates, OEM information and Manuals and more can be uploaded here. Contact Printek Technical Support at (800) 368-4636 for more information.

G. Reset Printer Configuration to Factory Defaults (Safe Mode)

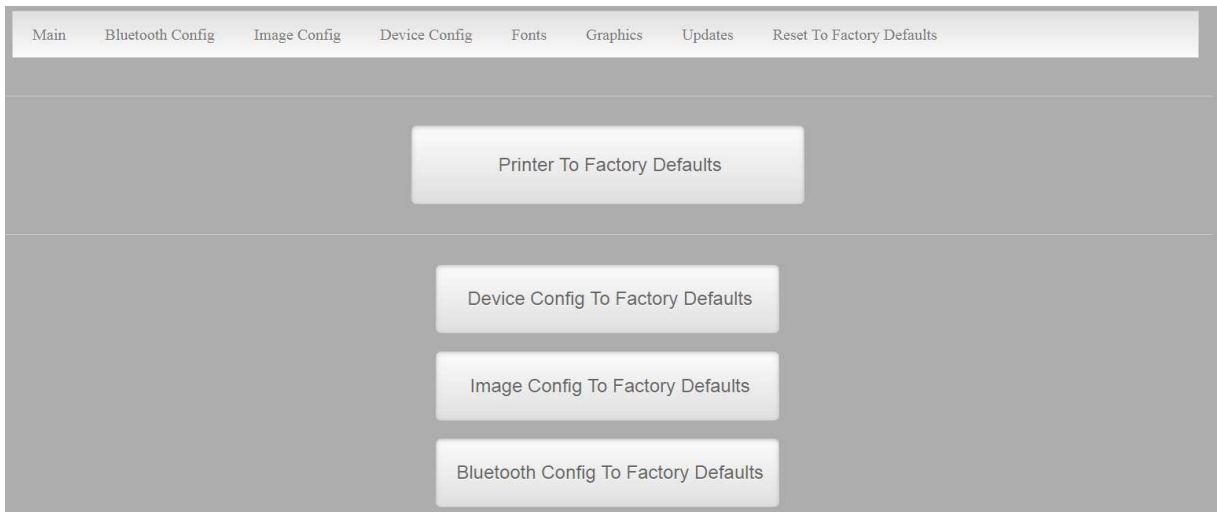

Printer settings can be restored to factory configurations.
Note that WIFI network configurations will be lost when Network Config to Factory Defaults is checked.

Printing Modes

There are two fundamental printing modes with mobile printers.

A. ASCII Based Print Jobs

The host sends the print job as a series of lines of characters, some of which represent the text to be printed, while other portions are command codes which tell the printer which font to use, where to locate the text, what barcodes to use, etc. These text-based files are encoded in a print language specific to the target printer.

The FP641 understands ASCII based jobs in several different print languages. Refer to the [Appendix](#) or the *Integrator's Guide* for the list of print languages supported.

B. Graphic Based Print Jobs

The host assembles the printed image as a series of lines of dots, and transmits this image as a sequence of data bytes that represent the dot patterns assembled. Often these jobs or files have some control characters on the front end and / or rear end of the dot pattern bytes to define their format, help control pagination, etc.

Windows drivers in particular encode the image as a graphic based print job before it is passed along to the printer.

In addition to accepting graphic jobs from its Windows driver, the FP641 can accept and print directly many other graphic image file types. This opens up the option to print job images from a variety of devices for which drivers or print utilities don't exist, such as some tablets and smartphones.

Please see the *Integrator's Guide* or your system integrator for more details.

Integrating the Printer into your Business Applications

Step by Step – Creating a Link from Host to Printer

A. Windows Desktop Computers

Print Drivers

You may download the appropriate Windows driver from our website. Install the printer driver by the standard method for your version of Windows.

I. USB

- a) Install the printer driver onto your host before connecting the printer. Follow prompts displayed during installation.
- b) Plug the printer into a USB port on your host system using a mini-USB cable.
- c) The printer will appear in the “Unspecified” devices section. Right click on the icon.
- d) In the popup window, select the Hardware tab. Note the USB port number displayed.
- e) Using the “Add Printer” wizard, install the printer using the driver file obtained from Printek and the USB port number noted above.
- f) After the printer driver installs, the printer will appear as “Printek 4-inch printer” under the “Printers and Faxes” heading of your Windows “Devices and Printers” screen.

II. Bluetooth – General

- a) Turn on printer. Make sure Bluetooth on your host device is turned ON.
- b) Your host Bluetooth manager may automatically scan for new devices, or you may need to tell it to scan. The discover name of the FP641 printer will be “FP641-XXXxxxxx”, where XXXxxxxx = the Printer Serial Number.
- c) For Pairing, the default passkey is “0000”.

Note: Bluetooth host devices pair after discovery, but only **connect** to Bluetooth printers when the host application has asked it to print.

III. Bluetooth – Windows 7 and above

- a) Turn on printer. Make sure Bluetooth on your host device is turned ON.
- b) Open the “Devices and Printers” folder.
- c) Select “Add a Device”. The printer will display using the discover name listed above.
- d) Select the printer from the list of devices.
- e) Select “Enter the Device’s Pairing Code”. The default pairing code is “0000”.
- f) A window will display informing you the device was successfully added, and the printer name will appear in the devices list. Close this.
- g) Printer now appears under “Printer and Faxes” heading of the “Devices and Printers” screen, as “FP641-serial #”. The icon may show that it is still configuring.
- h) Right click on the printer name or icon and select Properties. Select “Services” tab and deselect all items except for “SPP”.
- i) Now select “Hardware” tab. A virtual com port number will be listed here – make note of this COM Port number. Use this Com Port number when setting up the printer driver, under the “port settings”.

- j) Install the printer driver. Using the “Add Printer” wizard, install the printer using the driver file obtained from Printek and the COM port number noted above.
- k) After the printer driver installs, the printer will appear as “FP641-serial #” under the “Printers and Faxes” heading of your Windows “Devices and Printers” screen.

IV. Wi-Fi

Note: The following instructions are fundamentally the same for an Infrastructure or Wi-Fi Direct (peer to peer) setup. They also assume that you have already configured your Wi-Fi interface via the FP641 printer web page (see the section on Configuration).

- a) Perform a configuration printout to verify the printer Wi-Fi setup and to record the IP address assigned and the Port number.
- b) Install the printer as a local printer using the USB instructions above.
- c) In the “Devices and Printers” screen, right click the printer icon representing your mobile printer.
- d) Under Printer Properties, select the Ports tab, then select “Add a Port”
- e) In the new dialog box which appears, select “Standard TCP/IP ports”; this will open the Standard TCP/IP Printer Port wizard.
- f) Follow the on-screen prompts in this wizard. You’ll use the IP address recorded above to set up the port. In the same screen you can also name the port something familiar and relevant, and this will appear as the name of the printer to the user.
- g) After the port is detected, it will be displayed as a “generic network card” – accept this by clicking Next / Finish.
- h) After you are finished adding the port, Windows will report it as a “Standard TCP/IP port”; click OK to accept this.
- i) Close the Printer Port window.
- j) Now in the Printer Properties dialog box your IP address (or the familiar name you assigned above) will appear in the list of ports available. Select it to configure the port.
- k) Windows defaults standard TCP/IP ports to port number 9100. The FP641 Wi-Fi port number is internally set to 8023. Change the port number to 8023 in the Windows screen and click OK.
- l) Click “Apply” in the Printer Properties box.
- m) Your FP641 printer driver should now be properly coupled to the Wi-Fi parameters you have chosen.

B. Windows Tablets and Smartphones

This feature and/or specific directions for use were not available as of this printing.

C. Android Tablets & Smart phones

I. Bluetooth

- a) Turn on printer. Make sure Bluetooth on your host device is turned ON.

- b) Your host Bluetooth manager may automatically scan for new devices, or you may need to tell it to scan. The discover name of the FP641 printer will be “FP641-XXXxxxxx”, where XXXxxxxx = the Printer Serial Number.
- c) For Pairing, the default passkey is “0000”.
- d) The printer should appear in your paired devices list.

Note: Android devices pair after discovery, but only **connect** to Bluetooth printers when the host application has asked it to print.

II. Wi- Fi

This feature and/or specific directions for use were not available as of this printing.

D. Apple™ Tablets & Smartphones

I. Bluetooth

This feature and/or specific directions for use were not available as of this printing.

II. Wi-Fi

This feature and/or specific directions for use were not available as of this printing.

Media

A. Standard Media

Printek offers a variety of media types. You may visit our website or contact your PrintekMobile sales representative for a complete and up to date description of our consumables and accessory products.

B. Black Mark Media Position

For automatic ticket printing, the Black Mark should be positioned as shown in the figure below. When using Mark Sensing mode (see [Configuration](#), earlier in this document), FieldPro printers will automatically position the output for tear-off and printing following a Form Feed command or by pressing the Paper Feed button.

For non-automatic paper positioning, refer to the *Integrator's Guide* for sensing and positioning commands.

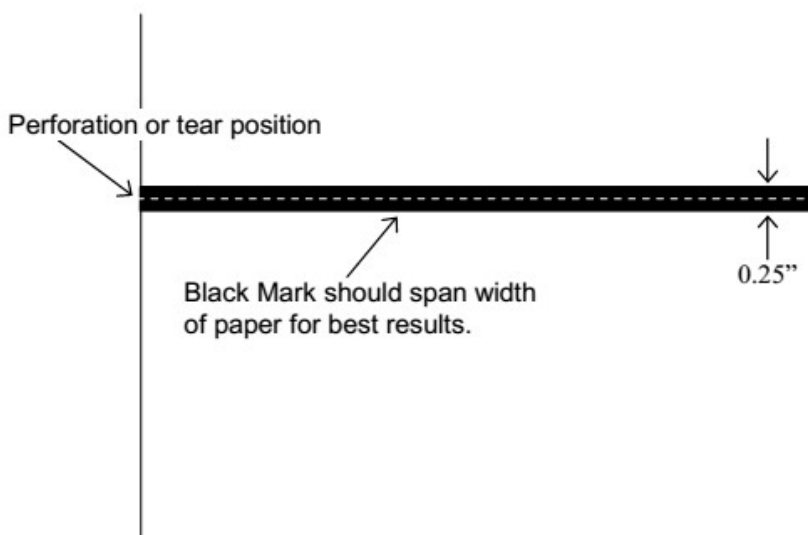

Optimum Black Mark Position

Maintenance and Troubleshooting

A. Cleaning

In normal environments, the printer should be cleaned after printing a few rolls of paper or if there are voids in the printout. For optimum performance and life, you should clean the Print Head and Platen Roller whenever you load new paper.

To clean the printer areas as described below, use a Thermal Head Cleaning Pen and MCR Cleaning Card available from Printek, or you may use cotton swabs moistened with isopropyl alcohol.

- Turn the printer off. Open the Paper Door and remove the paper.
- Using a Thermal Head Cleaning Pen, clean the white ceramic surface on the Print Head.
Caution: Do not use sharp objects to clean the print head. This may damage the printer and require service. Such damage is not covered under warranty.
- Clean the Black Mark Sensor below the print head.
- Clean the Tear Bar.
- Clean the Platen Roller. Turn the Platen Roller with your finger to clean the entire surface.
- If a Magnetic Card Reader is installed, pass and MCR Cleaning Card through the MCR slot to clean the head.

You may also experience a buildup of paper dust in the printer. This may be removed using a can of compressed air or by vacuuming.

To clean the exterior of the printer, turn the printer off and use a soft cloth moistened with a mild detergent.

B. Battery Care

I. Getting the Maximum Battery Life

New batteries are shipped in an “uncharged” state and must be charged for at least 4 hours prior to the first use. Maximum battery capacity is not reached until after completing a minimum of three complete charge and discharge cycles.

II. Charging the Battery

- Plug the power adapter into a power source appropriate for the adapter being used.
- Plug the power adapter into the power connector on the side of the printer. The printer’s battery charging circuitry will analyze the condition of the battery and begin charging it if necessary.
- If the battery is not fully charged, charging will begin and the Battery Indicator will illuminate.
- When the battery is fully charged, the Battery Indicator will turn off. Charging may take up to 8 hours (4 hours with external desktop charger accessory) depending on the condition of the battery.
- The printer may be used while the battery is charging, but this will extend the time required to fully charge the battery.

- The power adapter may remain connected to the printer to keep the battery fully charged and will not cause damage to the printer or battery.

III. Additional Battery and Safety Information

- The FieldPro 641 series printers use an 11.2 volt 4400 mAh Lithium Ion battery.

Caution: Risk of explosion if battery is replaced by incorrect type. Dispose of used batteries according to the instructions.

- The recommended ambient temperature for charging is 68-77° Fahrenheit (20-25° Centigrade).
- Take the battery out of the printer when storing the printer for long periods of time. The battery storage temperature is 40-104° Fahrenheit (4-40° Centigrade). Do not store a fully charged battery at temperatures above this range for long periods of time or the battery may permanently lose charge capacity.
- Do not disassemble, short circuit, heat above 80°C, or incinerate the battery. The battery may explode.
- Only dispose of used batteries according to your local regulations. If you do not know your local regulations, the Rechargeable Battery Recycling Corporation (RBRC) is a non-profit organization created to promote recycling of rechargeable batteries. For more information visit www.rbrc.org.



IV. Testing the Power Adapter and Battery

To verify that the printer's internal battery charger is functioning properly, perform the following steps.

- Test the power adapter (100-240VAC/50-60Hz, 12/24VDC adapter) with a voltmeter to verify that its output voltage is 24 VDC.
- Connect the power adapter to a power source and then connect it to the printer.
- Verify that the printer's Battery Indicator is illuminated. If illuminated, the charging circuit is functioning properly.

Note: If the battery is already fully charged, the Battery Indicator may not illuminate.

- After the battery has been charged for five minutes, disconnect the power adapter.
- Perform a printer Self-Test.
 - Make sure the printer is turned off.
 - Press and hold the Paper Feed Button while turning the printer on.
- If the printer successfully prints the Self-Test, the battery is functional. If the Self-Test does not complete and the printer turns off, repeat this test with a known good battery.
- Once this test has completed successfully, allow the battery to fully charge. At the end of this time the Battery Indicator will turn off.

If the printer and battery do not appear to successfully pass these tests, refer to the [Troubleshooting](#) section for possible causes and solutions.

Note: This test only verifies that the power adapter, the internal charging circuit, and the battery are functioning properly. This test does not provide a valid indication of the relative capacity of the battery or how long it may hold a charge.

C. Troubleshooting

When encountering problems, the cause may be the printer or may sometimes be due to other problems with your system. Please review the following tables to solve common problems you may encounter with your printer. You may also visit www.printek.com for additional “FAQ’s” that may assist you.

If you are still unable to solve your problem, please contact the company from whom you purchased your printer since they are most familiar with your systems. If they are unable to help you, please contact Printek Technical Support at (800) 368-4636.

I. General Error Conditions

Whenever the printer detects an error condition the Alert (red) Indicator will either flash or stay on. In some cases the audible alarm will also sound. Please refer to the following table for a list of what causes these conditions and how they may be corrected.

Error Indicator	Possible Cause	Solution
Flashes	Paper Out or Paper Door not fully closed	Make sure the door is fully closed by opening the door and closing it again until the door “clicks” closed. Check the platen roller for damage.
Stays On, With Alarm	Print job too large for printer memory	Divide long documents into individual pages. Printer power must be cycled to clear error.

II. Fault Description and Resolution

Problem	Possible Cause	Solution
Printer will not turn on.	Battery not installed properly	Remove and reinstall battery making sure the battery is seated with door closed.
	Discharged battery	Recharge battery.
Printer turns itself off.	Battery discharged	Replace or recharge battery.
	Electrostatic discharge	May occur in extreme low humidity conditions. Turn printer back on with power button.
Battery Indicator does not light or does not stay lit when power adapter is connected.	Battery already fully charged	No action required.
	Power supply not receiving power	Check building/vehicle circuit breakers/fuses.
	Faulty power adapter	Check output of power adapter with voltmeter. Should be 24 VDC.
Battery not charging.	Faulty power adapter or battery	Try new power adapter, or replace battery.

Problem	Possible Cause	Solution
Poor print quality.	Low battery	Check and recharge battery.
	Print head dirty	Clean print head. Refer to " Maintenance " section of this document.
	Poor quality or "old" paper	Verify paper from approved source. Try new roll of paper.
Paper not feeding.	Obstruction in paper path, or paper improperly installed	Check paper path and reinstall paper (see " Quick Start Instructions ").
	Poor quality paper	Verify paper from approved source.
	Paper Door not fully closed	Verify door is closed.
Paper does not advance to black mark reliably.	Dirty Black Mark/Paper Sensor	Clean Sensor as described in " Maintenance " section of this document.
	Black Mark density/contrast	Adjust Mark Sensitivity as described in Device Settings Menu .
Paper not feeding reliably or print is compressed vertically	Poor quality paper	Verify paper from approved source.
	Heavy or thick forms; specialty paper with slick finish	Lower the Max Paper Speed as described in Device Config Menu .
	Paper Door not fully closed	Verify door is closed.
Print Garbled.	Low Battery	Check and recharge battery.
	Improper Interface configuration	Verify printer and host settings match.
	Paper Door not fully closed	Verify door is closed.
Printer will not print.	Low Battery	Check and recharge battery.
	Paper not loaded correctly	Check paper path and reinstall paper (see " Quick Start Instructions ").
	Improper Interface configuration	Verify printer and host settings match. Print a self-test to verify printer settings and to verify printer is functioning properly.

D. Obtaining Service

If service is required for your printer, please contact the company where you purchased your printer.

If they are unable to assist you, contact Printek Customer Service at (800) 368-4636 to obtain a Return Authorization Number. Printers without Return Authorization will not be accepted.

APPENDIX

A. Appendix A – FieldPro 641 Printer Specifications

Printing Specifications

Printing Method: Direct thermal.
Printing Resolution: 203 dpi (8 dots per mm).
Printing Speed: Up to 6 ips.
Printing Width: Up to 4.25 inches (108 mm).

Fonts/Characters/Bar Codes

Fonts: Virtually all TrueType fonts, from 6 cpi to 34 cpi depending on emulation chosen, plus scaling.
International Characters: All common sets available via UTF-8 encoding. Unicode support.
Bar Codes: Virtually all 1D and 2D codes supported, depending on emulation chosen.
Downloadable firmware, fonts, graphics, and logos.

Connectivity

Standard (All Units): USB 2.0 PNP. USB-C input connector.

Wireless Options:

Bluetooth

Fully qualified Bluetooth BT4.2 and support Bluetooth 5.

Baseband and radio BDR and EDR packet types

Enhanced Data Rate (EDR) compliant for both 2Mbps and 3Mbps supported.

Wi-Fi 802.11 a/b/g/n/ac compatible

Software

Drivers and Utilities: Drivers for XP, WIN 7, WIN 8, WIN 10.
Compatible with Windows CE/Pocket PC, Windows Mobile, Apple iOS, Android. Print utilities and SDK's for all platforms. Native App and Web printing.

Printer Setup via internal web page, access with browser from any host (tablets and smartphones included).

Emulations: Emulates many popular printer brands and languages including: Zebra CPCL and ZPL, Extech, and ESC POS. Firmware can be upgraded as new emulations become available. Supports direct printing of Postscript, PDF, PBM, JPG, PNG, BMP, SVG, & TIFF files.

Print Media

Paper Type: Direct Thermal Roll.
Roll Size: Maximum roll diameter 2.28" (58 mm), roll widths up to 4.45" (113 mm).

Roll Capacity

Label Media: Approx. 75' (23 m), creating 148 6" long labels.
Receipt Media: Approx. 173' (52.6 m), creating 346 6" long receipts.

Core Size: both 0.75" and 0.5" are available.

Power Management

Battery: Rechargeable 3 cell Lithium Ion, (10.8 V, 4400 mAh, 47.52 Wh).

Endurance: Over 3,500 printed inches per charge.

Power Option: 100-240 VAC wall adapter, or 12-24 VDC in-vehicle adapter. When plugged in, the printer can be used while recharging the battery or can be run without the battery (print & charge adapter).

Physical Specifications

W x D x H: 6.02" x 6.25" x 2.68" (153 x 158.7 x 68mm).

Weight: 0.6 kg without battery, 0.8kg with battery

Environmental Specifications

Operating Temp: 0° to 122°F (-18° to 50°C).

Storage Temp: -4° to 140°F (-20° to 60°C).

Humidity: 10% to 90% RH (non-condensing).

Rated IP54 per IEC 529

Operator Controls and Indicators

LED indicators for general fault, power and battery status indication. Buttons for power and paper feed. Sensors for paper out, black mark detection, and door open. "Gas gauge" on LCD display.

Memory Capacity

FLASH 4GB, LPDDR2 512MB.
Standard memory supports large and graphic intensive print jobs.

Durability and Reliability

Survives multiple 6 foot drops to concrete (each face) per IEC 68-2. MTBF: 10,000 hours in normal use.

Regulatory Approvals

FCC Class B, CE mark, RoHS, UL listed AC adapters, e-mark.

Warranty

2-year printer warranty on the entire printer—case and print head included.
1-year warranty on the battery.

Options and Accessories

- AC Wall Adapter, 100 to 240 VAC
 - Print and charge version
- In-Vehicle Power Adapter, 12 to 24 VDC
- Shoulder Strap
- Data Cables, USB-C
- Spare Batteries in Multi-Packs
- Media in Case Quantities
- Popular Mounting Systems
 - In-Vehicle Systems
 - Cart Mounting Systems
 - Fixed Mounting Systems

Glossary of Terms

802.11	Wireless networking communication standards created by IEEE.
Ad-Hoc	A Wi-Fi network consisting of only stations (no access point). Same as Peer-to-Peer.
authentication	The process a Wi-Fi station uses to identify itself to another station.
baud rate	The rate at which characters are transmitted over a serial interface. This is also often referred to as bits per second.
Bluetooth	A definition for short range radio frequency communications.
client	Any node on a network that requests services from another node (server).
character pitch	The horizontal spacing of characters. Measured in cpi.
cpi	Characters per inch.
default	Value or configuration assumed when the printer is powered on or reset.
DHCP	Dynamic Host Configuration Protocol. A method used to centrally control the assignment of IP addresses on a network.
dpi	Dots per inch. Generally used to refer to graphics density or resolution.
font	A group of characters of a given shape or style.
infrastructure	A Wi-Fi network consisting of stations connecting to a wired network or other stations via an access point.
interface	The connection between the printer and the host computer.
IP	Internet Protocol. A specification for packets, or datagrams, of data and an addressing method to allow the exchange of data with another system. Must be combined with another protocol such as TCP to create a complete connection with the other system.
LAN	Local Area Network.
LED	Light emitting diode.
lpi	Lines per inch.
margin	An area along any edge of a form where data may not be printed.
Peer-to-Peer	A network consisting of only stations (no access point or central server). Same as Ad-Hoc.

reset	Initialization of various operating features of the printer to the value or state assumed when the printer is powered on.
server	Any node on a network that provides services to another node (client).
SSID	Service Set Identifier. An identifier attached to packets on a Wi-Fi network that identify the particular network the packets are intended for.
TCP	Transmission Control Protocol. A specification that controls the connection between systems on a network.
top of form	The vertical position where the first line is printed on the paper. Also the position the paper is advanced to when a form feed (FF) character is received from the host or the Form Feed button is pressed on the printer's control panel.
USB	Universal Serial Bus.
WAN	Wide Area Network. Refers to connections that allow one LAN to communicate with another LAN(s).
WEP	Wired Equivalent Privacy. A security protocol for wireless LANs designed to provide data security similar to a wired LAN.
Wi-Fi	Refers to any of the IEEE 802.11 standards.
WLAN	Wireless Local Area Network. A LAN made up of wireless nodes.

Index

- 802.11, 30
- Add Enterprise Network, 11
- Add Personal Network, 11
- Address Method, 10
- Ad-Hoc, 30
- Alert, 6
- Android, 3, 20
- Android Tablets & Smart phones, 20
- Apple, 3, 21
- authentication, 30
- Auto Off Timer, 15
- AUTOIMAGE, 12
- Available Networks, 11
- Backup Distance Before Printing, 14
- battery, 3, 5, 7, 23, 24, 25, 26
- Battery Care, 23
- Battery Disposal, ii
- Battery Installation, 5
- baud rate, 30
- Bluetooth, ii, 2, 8, 9, 19, 20, 21, 30
- Canadian Department of Communications Radio Interference Statement, i
- character pitch, 30
- Charge Battery, 5
- Charging the Battery, 23
- Cleaning, 23, 29
- client, 30
- Com Port, 19
- Configuration, 7, 22, 30
- Connectivity Parameters, 8
- Contrast, 14
- Control Panel, 6
- CPCL, ii, 12
- cpi, 30
- Current Emulation, 12
- Current Logo Mapping, 16
- Current Printer Config, 10
- default, 30
- Default Font, 12
- Default Text Line Spacing, 13
- Device Config, 13
- DHCP, 30
- discover name, 19, 21
- Discoverability, 9
- dpi, 30
- driver, 19
- Drivers, 19
- ESCPOS, 12
- Fault Description and Resolution, 25
- FCC Part 15 Class B, i
- features, 31
- Font Aliases, 15
- Fonts, 15
- form, 31
- Front Paper Sensor Threshold, 14
- Gap Paper Sensor Threshold, 14
- GateWay, 10
- General Error Conditions, 25
- Graphics, 16
- IMAGE, 12
- Image Parameters, 12
- infrastructure, 30
- interface, 30
- IP Address, 10
- IP54, 3
- LAN, 30
- LED, 30
- Left Margin, 14
- lpi, 30
- Maintenance, 2, 23, 26
- margin, 30
- Mark Seeking, 14
- Max Mark Search Distance, 14
- Max Paper Speed, 13, 26
- Maximum Battery Life, 23
- Media, 2, 22, 27, 28, 29
- Mounting Options, 29
- Obtaining Service, 26
- Paired Mode, 8
- pairing code, 19
- Paper Energy Values, 14
- Paper Feed Button, 6
- Paper Load, 4
- passkey, 19, 21
- PDF, 12
- Peer-to-Peer, 30
- PIN, 8, 9
- POSTSCRIPT, 12
- power, i, ii
- Power Button, 6
- Power On, 5
- Quick Start Instructions, 4
- Rear Paper Sensor Threshold, 14
- reset, 31
- Role Policy, 9
- Safety Information, 24
- Self-Test, 6, 24
- server, 31
- Set Date, 11
- Set index, 16
- Set Width, 16
- Specifications, 2, 3, 27, 28
- SSID, 31
- Stop Distance after Mark, 14
- SubNetMask, 10
- Supplies and Accessories, 2, 29
- TCP, 31
- Testing the Power Adapter and Battery, 24
- Troubleshooting, 2, 23, 24, 25
- Units, 13
- Upload Digital Certificate, 12
- Upload File, 16
- Upload Font File, 15
- USB, 19, 31
- USB port, 2, 19
- WAN, 31
- web page, 7
- WEP, 31
- Wi-Fi, ii, 2, 20, 30, 31
- WI-FI Config, 8, 9
- Wifi Port, 10
- Windows, ii, 3, 18, 19, 20
- WLAN, 31
- ZPL, 12