



Valued Quality. Delivered.

TEST REPORT

Report Number: 16081243HKG-003

Application
for
Original Grant of 47 CFR Part 15 Certification

Drone DX 14.4inch with Camera HD

FCC ID: Z6QFX129APPRX

Prepared and Checked by:

Approved by:

Signed On File
Lok Chi Hang, Wil
Assistant Engineer

Wong Kwok Yeung, Kenneth
Senior Lead Engineer
December 02, 2016

- Intertek's standard Terms and Conditions can be obtained at our website: <http://www.intertek.com/terms/>.
- The test report only allows to be revised within the retention period unless further standard or the requirement was noticed.
- This report is for the exclusive use of Intertek's Client and is provided pursuant to the agreement between Intertek and its Client. Intertek's responsibility and liability are limited to the terms and conditions of the agreement. Intertek assumes no liability to any party, other than to the Client in accordance with the agreement, for any loss, expense or damage occasioned by the use of this report. Only the Client is authorized to permit copying or distribution of this report and then only in its entirety. Any use of the Intertek name or one of its marks for the sale or advertisement of the tested material, product or service must first be approved in writing by Intertek. The observations and test results in this report are relevant only to the sample tested. This report by itself does not imply that the material, product, or service is or has ever been under an Intertek certification program.
- © 2016 Intertek

Intertek Testing Services Hong Kong Ltd.

2/F., Garment Centre, 576 Castle Peak Road, Kowloon, Hong Kong.
Tel: (852) 2173 8888 Fax: (852) 2785 5487 Website: www.hk.intertek-etlsemko.com

INTERTEK TESTING SERVICES

GENERAL INFORMATION

Applicant Name:	Guangdong Feilun Technology Industrial Co., Ltd.
Applicant Address:	Haisheng Road, Laimei Industrial District, Fengxiang Chenghai, Shantou, Guangdong, China.
Buyer:	Merchsource, LLC
FCC Specification Standard:	FCC Part 15, October 1, 2015 Edition
FCC ID:	Z6QFX129APPRX
FCC Model(s):	FL2016F
Type of EUT:	Spread Spectrum Transmitter
Description of EUT:	Drone DX 14.4inch with Camera HD
Serial Number:	N/A
Sample Receipt Date:	August 22, 2016
Date of Test:	August 22, 2016 to September 02, 2016
Report Date:	December 02, 2016
Environmental Conditions:	Temperature: +10 to 40°C Humidity: 10 to 90%

INTERTEK TESTING SERVICES

Table of Contents

1.0 Test Results Summary & Statement of Compliance	4
1.1 Summary of Test Results.....	4
1.2 Statement of Compliance.....	4
2.0 General Description	6
2.1 Product Description.....	6
2.2 Test Methodology.....	6
2.3 Test Facility.....	7
2.4 Related Submittal(s) Grants.....	7
3.0 System Test Configuration	9
3.1 Justification.....	9
3.2 EUT Exercising Software.....	10
3.3 Details of EUT and Description of Accessories.....	11
3.4 Measurement Uncertainty.....	11
4.0 Test Results	13
4.1 Maximum Conducted Output Power at Antenna Terminals.....	13
4.2 Minimum 6dB RF Bandwidth.....	15
4.3 Maximum Power Spectral Density.....	22
4.4 Out of Band Conducted Emissions.....	29
4.5 Field Strength Calculation.....	42
4.6 Transmitter Radiated Emissions in Restricted Bands and Spurious Emissions.....	43
4.6.1 Radiated Emission Configuration Photograph.....	43
4.6.2 Radiated Emission Data.....	43
4.6.3 Radiated Emission Test Setup.....	56
4.6.4 Transmitter Duty Cycle Calculation.....	57
4.7 AC Power Line Conducted Emission.....	58
5.0 Equipment List	60

INTERTEK TESTING SERVICES

**EXHIBIT 1
TEST RESULTS SUMMARY & STATEMENT OF COMPLIANCE**

INTERTEK TESTING SERVICES

1.0 Test Results Summary & Statement of Compliance

1.1 Summary of Test Results

Test Items	FCC Part 15 Section	Results	Details see section
Antenna Requirement	15.203	Pass	2.1
Max. Conducted Output Power (average)	15.247(b)(3)&(4)	Pass	4.1
Min. 6dB RF Bandwidth	15.247(a)(2)	Pass	4.2
Max. Power Density (average)	15.247(e)	Pass	4.3
Out of Band Antenna Conducted Emission	15.247(d)	Pass	4.4
Radiated Emission in Restricted Bands and Spurious Emissions	15.247(d), 15.209 & 15.109	Pass	4.6
AC Power Line Conducted Emission	15.207 & 15.107	Pass	4.7

Note: Pursuant to FCC Part 15 Section 15.215(c), the 20dB bandwidth of the emission was contained within the frequency band designated (mentioned as above) which the EUT operated. The effects, if any, from frequency sweeping, frequency hopping, other modulation techniques and frequency stability over expected variations in temperature and supply voltage were considered.

1.2 Statement of Compliance

The equipment under test is found to be complying with the following standard:

FCC Part 15, October 1, 2015 Edition

INTERTEK TESTING SERVICES

**EXHIBIT 2
GENERAL DESCRIPTION**

INTERTEK TESTING SERVICES

2.0 General Description

2.1 Product Description

The FL2016F is a Drone DX 14.4inch with Camera HD.

The Equipment Under Test (EUT) operates at frequency range of 2412MHz to 2462MHz with 11 channels. For 802.11g mode, it operates at frequency range of 2412.000MHz to 2462.000MHz with 11 channels. It transmits via Orthogonal Frequency Division Multiplexing (OFDM) modulation. Maximum bit rate can be up to 54Mbps. For 802.11n (with 20MHz bandwidth) mode, it operates at frequency range of 2412.000MHz to 2462.000MHz with 11 channels. It transmits via Orthogonal Frequency Division Multiplexing (OFDM) modulation. Maximum bit rate can support up to 65Mbps.

The EUT is a Drone DX 14.4inch with Camera HD, It plays under voice control after connected to WiFi, by switches embedded in the rooms and features and through APPs installed on Smart Device. Sounds and Lights will be responded by specific commands.

It operates at frequency range of The EUT is power by a fully charged to 1X3.7V rechargeable battery.

The antenna(s) used in the EUT is integral, and the test sample is a prototype.

The circuit description is saved with filename: descri.pdf.

2.2 Test Methodology

Both AC power line-conducted and radiated emission measurements were performed according to the procedures in ANSI C63.4 (2014). Preliminary radiated scans and all radiated measurements were performed in radiated emission test sites. All Radiated tests were performed at an antenna to EUT distance of 3 meters, unless stated otherwise in the "**Justification Section**" of this Application. Antenna port conducted measurements were performed according to ANSI C63.10 (2013) and KDB Publication No.558074 D01 v03r05 (08-April-2016). All other measurements were made in accordance with the procedures in 47 CFR Part 2.

INTERTEK TESTING SERVICES

2.3 Test Facility

The radiated emission test site and antenna port conducted measurement facility used to collect the radiated data and conductive data are at Workshop No. 3, G/F., World-Wide Industrial Centre, 43-47 Shan Mei Street, Fo Tan, Sha Tin, N.T., Hong Kong. This test facility and site measurement data have been fully placed on file with the FCC.

2.4 Related Submittal(s) Grants

This is a single application for certification of a transceiver (WiFi portion)

INTERTEK TESTING SERVICES

**EXHIBIT 3
SYSTEM TEST CONFIGURATION**

INTERTEK TESTING SERVICES

3.0 System Test Configuration

3.1 Justification

For radiated emissions testing, the equipment under test (EUT) was setup to transmit / receive continuously to simplify the measurement methodology. Care was taken to ensure proper power supply voltages during testing. During testing, all cables (if any) were manipulated to produce worst case emissions.

The EUT was powered by a fully charged to 1X3.7V rechargeable battery.

For the measurements, the EUT was attached to a plastic stand if necessary and placed on the wooden turntable. If the base unit attached to peripherals, they were connected and operational (as typical as possible).

The signal was maximized through rotation and placement in the three orthogonal axes. The antenna height and polarization were varied during the search for maximum signal level. The antenna height was varied from 1 to 4 meters. Radiated emissions were taken at three meters unless the signal level was too low for measurement at that distance. If necessary, a pre-amplifier was used and/or the test was conducted at a closer distance.

For any intentional radiator powered by AC power line, measurements of the radiated signal level of the fundamental frequency component of the emission was performed with the supply voltage varied between 85% and 115% of the nominal rated supply voltage.

Radiated emission measurement for transmitter were performed from the lowest radio frequency signal generated in the device which is greater than 9 kHz to the tenth harmonic of the highest fundamental frequency or to 40 GHz, whichever is lower.

Emission that are directly caused by digital circuits in the transmit path and transmitter portion were measured, and the limit are according to FCC Part 15 Section 15.209. Digital circuitries used to control additional functions other than the operation of the transmitter are subject to FCC Part 15 Section 15.109 Limits.

INTERTEK TESTING SERVICES

3.1 Justification – Cont'd

Detector function for radiated emissions was in peak mode. Average readings are obtained by average detector as required from ANSI C63.10 2013.

Determination of pulse desensitization was made according to *Hewlett Packard Application Note 150-2, Spectrum Analysis... Pulsed RF*. The effective period (Teff) was referred to Exhibit 4.6.3. With the resolution bandwidth 1MHz and spectrum analyzer IF bandwidth 3dB, the pulse desensitization factor was 0dB.

The EUT along with its peripherals were placed on a 1.0m(W)x1.5m(L) and 0.8m in height wooden table and the EUT was adjusted to maintain a 0.4 meter space from a vertical reference plane. The EUT power cord connected to one LISN (Line impedance stabilization network), which provided 50ohm coupling impedance for measuring instrument. Meanwhile, the peripheral or support equipment power cords connected to a separate LISN. The ac powers for all LISNs were obtained from the same power source. The LISN housing, measuring instrument case, reference ground plane, and vertical ground plane were bounded together. The excess power cable between the EUT and the LISN was bundled. Power cords of non-EUT equipment (peripherals) were not bundled. AC power cords of peripheral equipments draped over the rear edge of the table, and routed them down onto the floor of the ac power line conducted emission test site to the second LISN.

All connecting cables of EUT and peripherals were manipulated to find the maximum emission.

Different data rates have been tested. Worst case is reported only.

All relevant operation modes have been tested, and the worst case data is included in this report.

All data rates were tested under normal mode of WiFi. Only the worst-case data is shown in the report for DSSS and OFDM

3.2 EUT Exercising Software

The EUT exercise program (if any) used during radiated and conducted testing was designed to exercise the various system components in a manner similar to a typical use.

INTERTEK TESTING SERVICES

3.3 Details of EUT and Description of Accessories

Details of EUT:

An AC adaptor (provided with the unit) was used to power the device. Their description are listed below.

(1) N/A

Description of Accessories:

There are no special accessories necessary for compliance of this product.

3.4 Measurement Uncertainty

When determining of the test conclusion, the Measurement Uncertainty of test at a level of confidence of 95% has been considered. The values of the Measurement uncertainty for radiated emission test and RF conducted measurement test are $\pm 5.3\text{dB}$ and $\pm 0.99\text{dB}$ respectively. The value of the Measurement uncertainty for conducted emission test is $\pm 4.2\text{dB}$.

Uncertainty and Compliance - Unless the standard specifically states that measured values are to be extended by the measurement uncertainty in determining compliance, all compliance determinations are based on the actual measured value.

INTERTEK TESTING SERVICES

**EXHIBIT 4
TEST RESULTS**

INTERTEK TESTING SERVICES

4.0 Test Results

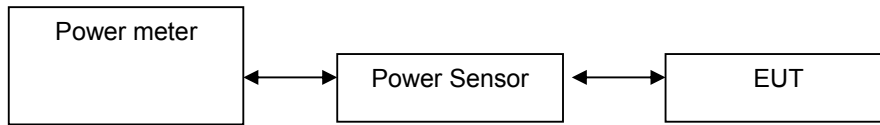

4.1 Maximum Conducted (peak) Output Power at Antenna Terminals

The antenna port of the EUT was connected to the input of a spectrum analyzer.

- The antenna power of the EUT was connected to the input of a power meter. Power was read directly and cable loss correction was added to the reading to obtain power at the EUT antenna terminals. The measurement procedure 9.1.2 was used.
- The EUT should be configured to transmit continuously (at a minimum duty cycle of 98%) at full power over the measurement duration. The measurement procedure AVG1 was used.

IEEE 802.11b (DSSS, 1 Mbps) Antenna Gain = 2 dBi		
Frequency (MHz)	Output in dBm	Output in mWatt
Low Channel: 2412	12.27	16.87
Middle Channel: 2437	11.66	14.66
High Channel: 2462	11.16	13.06

IEEE 802.11g (OFDM, 6 Mbps) Antenna Gain = 2 dBi		
Frequency (MHz)	Output in dBm	Output in mWatt
Low Channel: 2412	17.02	50.35
Middle Channel: 2437	17.05	50.70
High Channel: 2462	16.95	49.55

IEEE 802.11n (20MHz) (OFDM, MCS0) Antenna Gain = 2 dBi		
Frequency (MHz)	Output in dBm	Output in mWatt
Low Channel: 2412	17.42	55.21
Middle Channel: 2437	17.22	52.72
High Channel: 2462	17.14	51.76

INTERTEK TESTING SERVICES

4.1 Maximum Conducted Output Power at Antenna Terminals – Cont'd

Cable loss : 0.5 dB External Attenuation : 0 dB

Cable loss, external attenuation: included in OFFSET function
 added to SA raw reading

IEEE 802.11b (DSSS, 1 Mbps)
max. conducted (average) output level = 12.27 dBm

IEEE 802.11g (OFDM, 9 Mbps)
max. conducted (average) output level = 17.05 dBm

IEEE 802.11n (20MHz) (OFDM, MCS0)
max. conducted (average) output level = 17.42 dBm

Limits:

1W (30dBm) for antennas with gains of 6dBi or less

___W (___dBm) for antennas with gains more than 6dBi

The plots of conducted output power are saved as below.

INTERTEK TESTING SERVICES

4.2 Minimum 6dB RF Bandwidth

The antenna port of the EUT was connected to the input of a spectrum analyzer. The EBW measurement procedure was used. A PEAK output reading was taken, a DISPLAY line was drawn 6dB lower than PEAK level. The 6dB bandwidth was determined from where the channel output spectrum intersected the display line.

IEEE 802.11b (DSSS, 1 Mbps)	
Frequency (MHz)	6dB Bandwidth (MHz)
Low Channel: 2412	10.56
Middle Channel: 2437	10.28
High Channel: 2462	10.52

IEEE 802.11g (OFDM, 6 Mbps)	
Frequency (MHz)	6dB Bandwidth (MHz)
Low Channel: 2412	16.64
Middle Channel: 2437	16.60
High Channel: 2462	16.64

IEEE 802.11n (20MHz) (OFDM, MCS0)	
Frequency (MHz)	6dB Bandwidth (MHz)
Low Channel: 2412	17.84
Middle Channel: 2437	17.84
High Channel: 2462	17.92

Limits

6 dB bandwidth shall be at least 500kHz

The plots of 6dB RF bandwidth and occupied bandwidth are saved as below.

INTERTEK TESTING SERVICES

Plots of 6dB RF bandwidth

802.11b, Lowest Channel

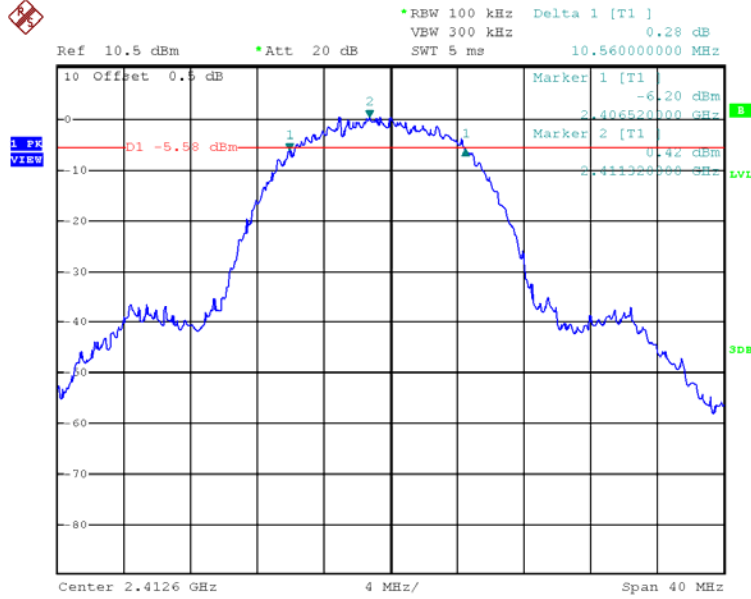

802.11b, Middle Channel

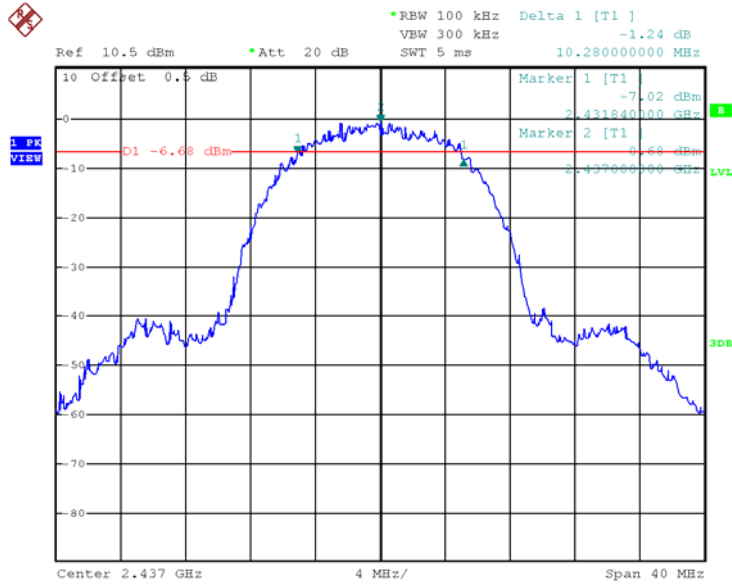

INTERTEK TESTING SERVICES

Plots of 6dB RF bandwidth

802.11b, Highest Channel

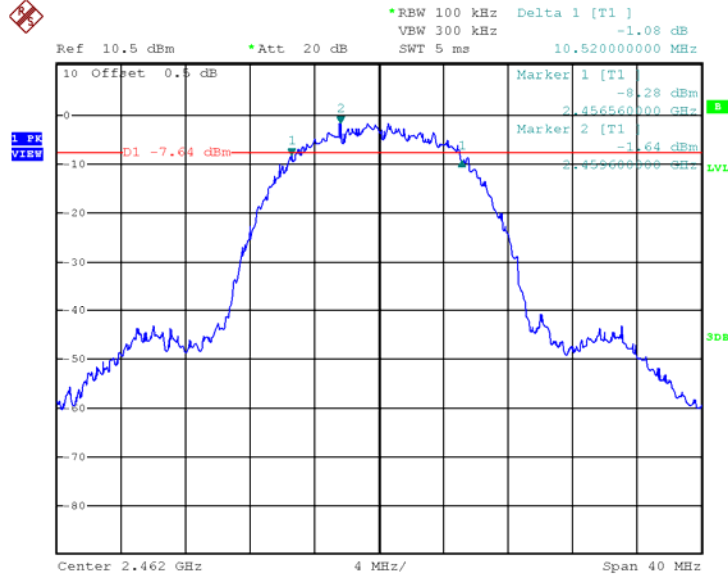

INTERTEK TESTING SERVICES

Plots of 6dB RF bandwidth

802.11g, Lowest Channel

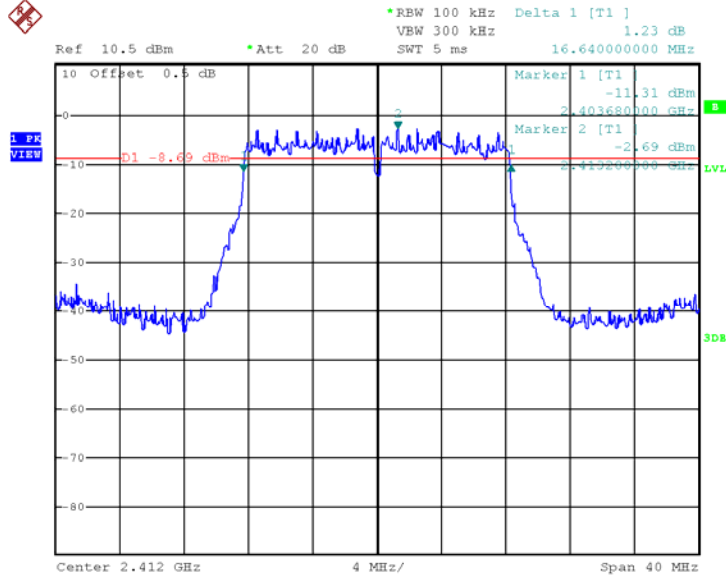

802.11g, Middle Channel

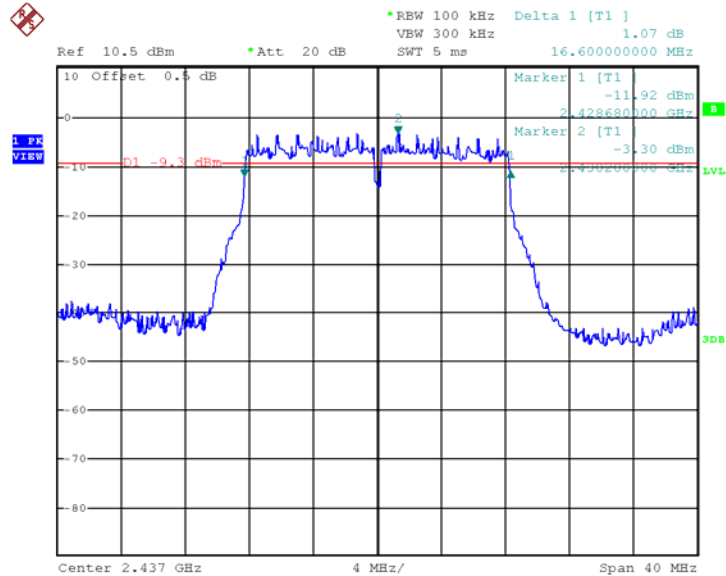

INTERTEK TESTING SERVICES

Plots of 6dB RF bandwidth

802.11g, Highest Channel

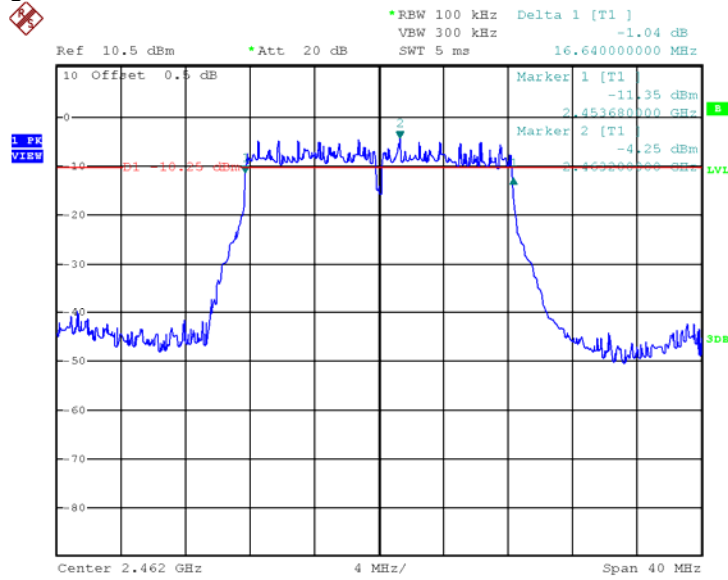

INTERTEK TESTING SERVICES

Plots of 6dB RF bandwidth 802.11n(20M), Lowest Channel

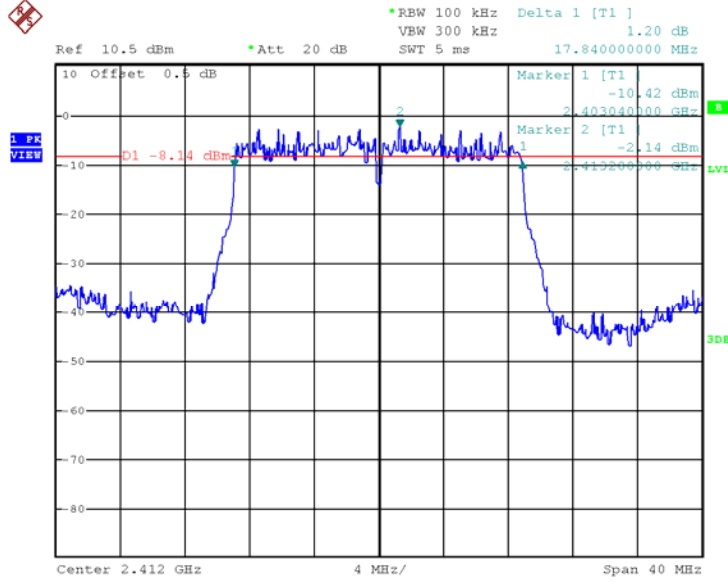

802.11n(20M), Middle Channel

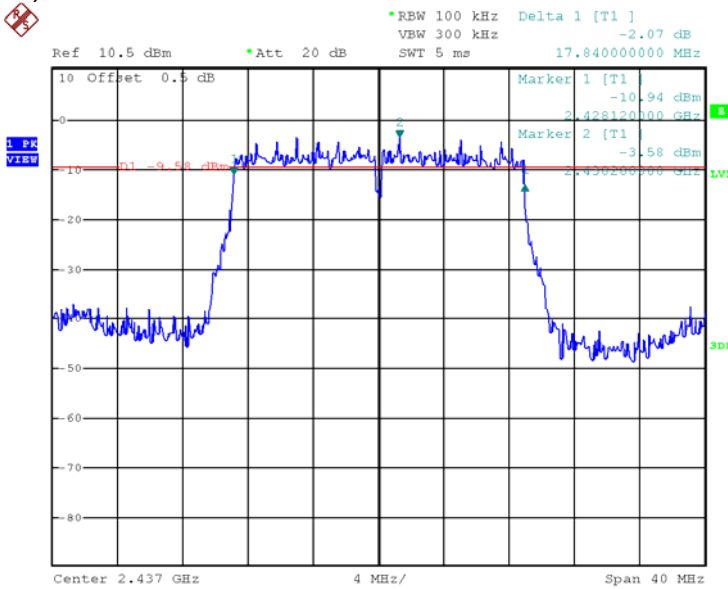

INTERTEK TESTING SERVICES

Plots of 6dB RF bandwidth 802.11n(20M), Highest Channel

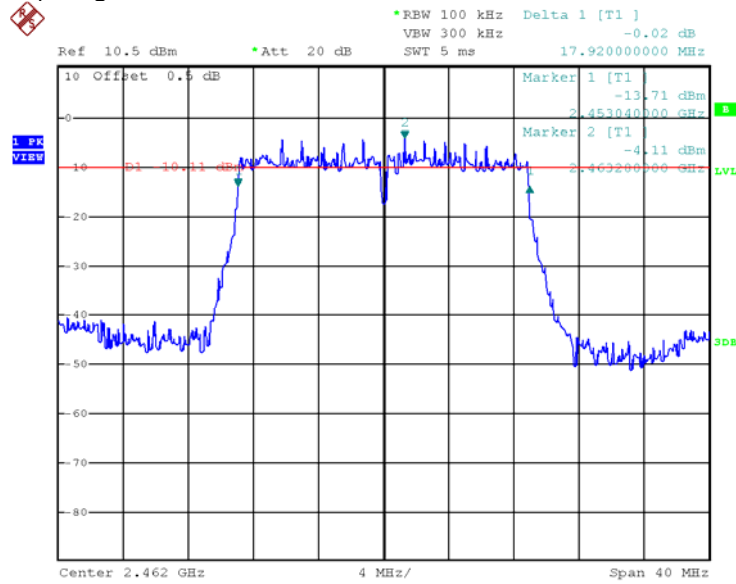

INTERTEK TESTING SERVICES

4.3 Maximum Power Spectral Density

Antenna output of the EUT was coupled directly to spectrum analyzer. The measurement procedure 10.2 PKPSD-1 was used. If an external attenuator and/or cable was used, these losses are compensated for using the OFFSET function of the analyser.

IEEE 802.11b (DSSS, 1 Mbps)	
Frequency (MHz)	PSD in 100kHz (dBm)
Low Channel: 2412	0.54
Middle Channel: 2437	-0.38
High Channel: 2462	-1.52

IEEE 802.11g (OFDM, 6 Mbps)	
Frequency (MHz)	PSD in 100kHz (dBm)
Low Channel: 2412	-2.18
Middle Channel: 2437	-3.18
High Channel: 2462	-3.97

IEEE 802.11n (20MHz) (OFDM, MCS0)	
Frequency (MHz)	PSD in 100kHz (dBm)
Low Channel: 2412	-2.38
Middle Channel: 2437	-3.55
High Channel: 2462	-4.28

Cable Loss: 0.5 dB

Limit:
8dBm

The plots of n power spectral density are as below.

INTERTEK TESTING SERVICES

Plots of power spectral density

802.11b, Lowest channel

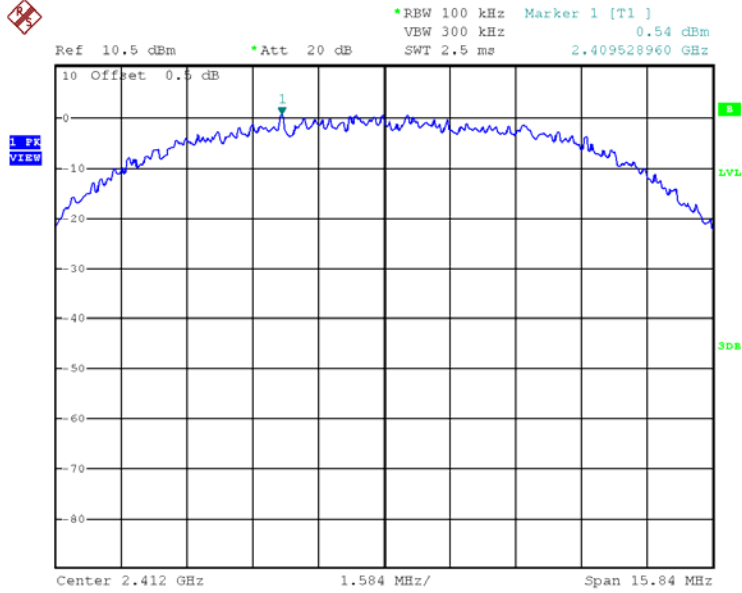

802.11b, Middle channel

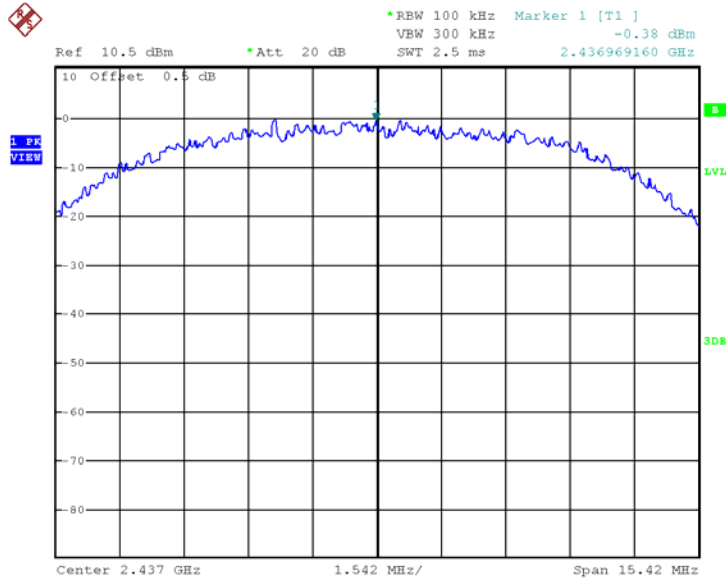

INTERTEK TESTING SERVICES

Plots of power spectral density

802.11b, Highest channel

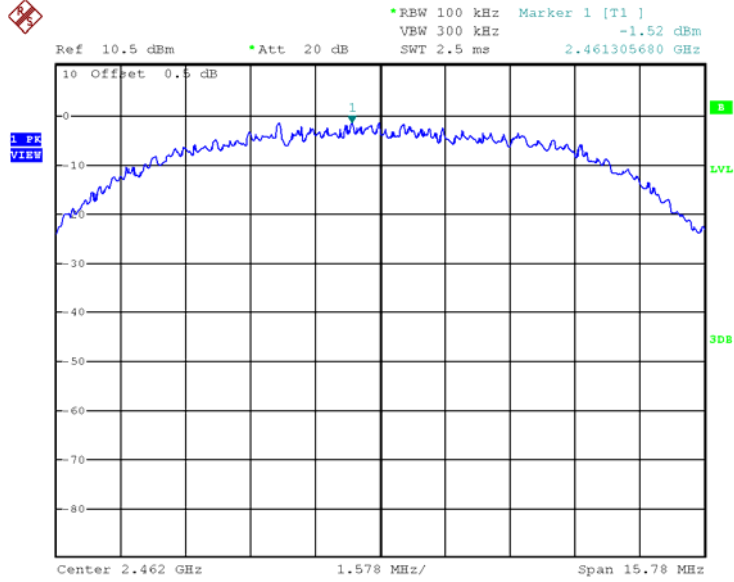

INTERTEK TESTING SERVICES

Plots of power spectral density

802.11g, Lowest channel

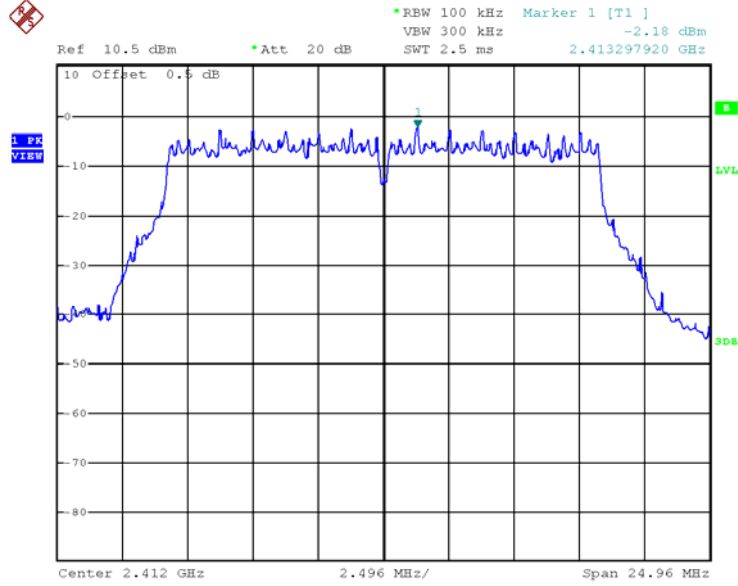

802.11g, Middle channel

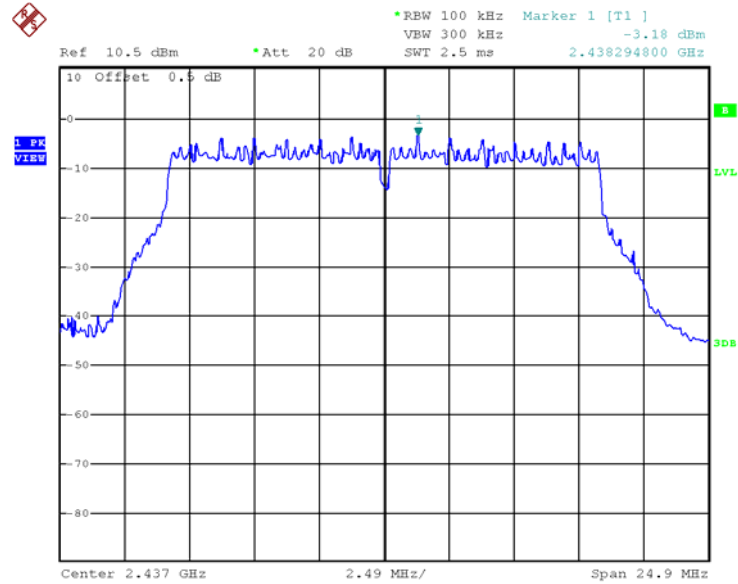

INTERTEK TESTING SERVICES

Plots of power spectral density

802.11g, Highest channel

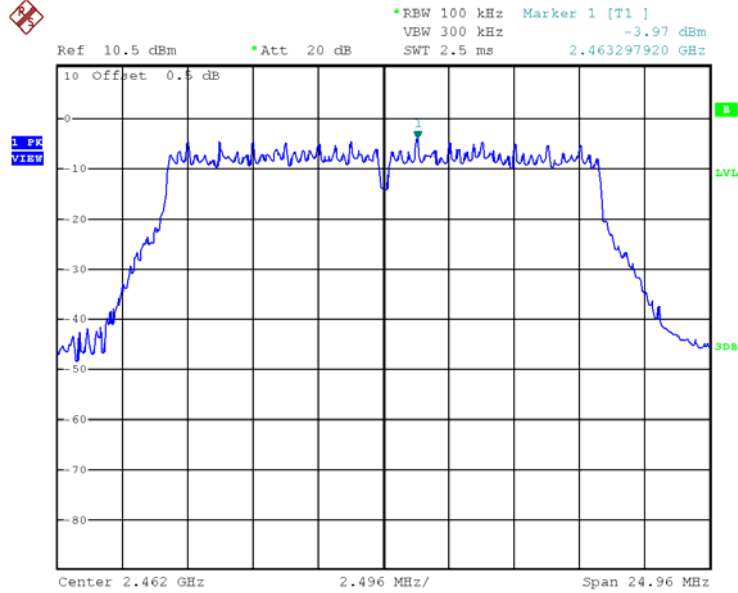

INTERTEK TESTING SERVICES

Plots of power spectral density

802.11n(20M), Lowest channel

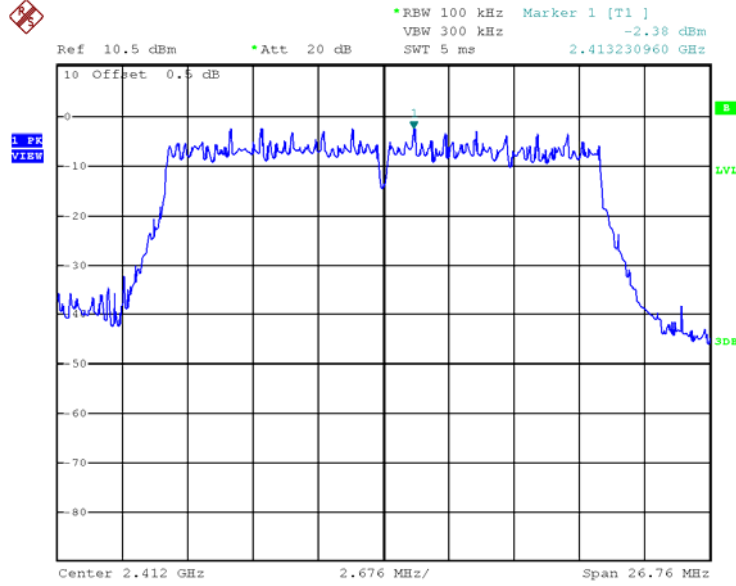

802.11n(20M), Middle channel

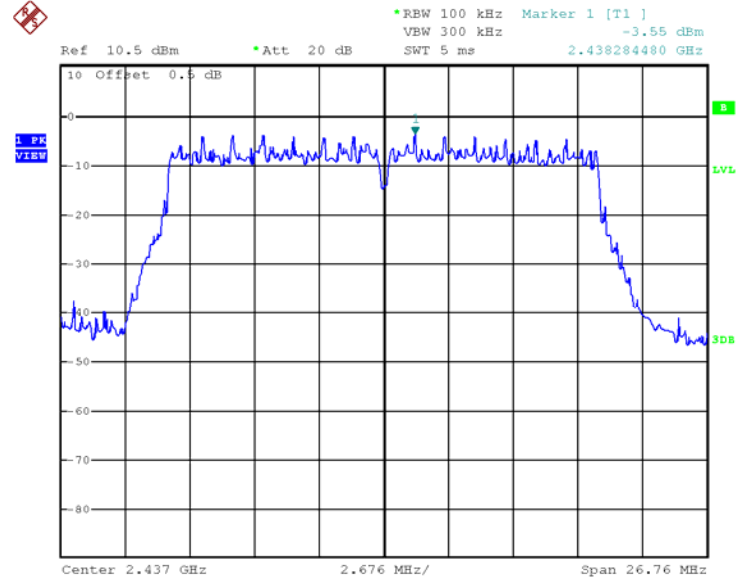

INTERTEK TESTING SERVICES

Plots of power spectral density

802.11n(20M), Highest channel

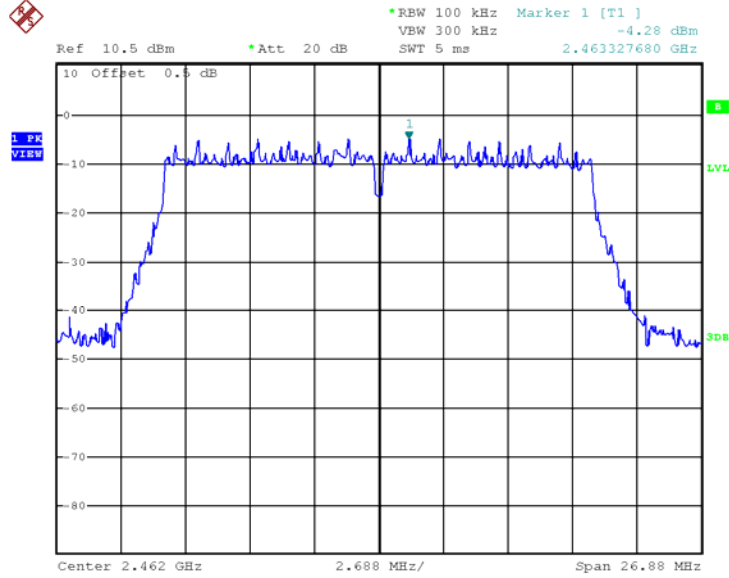

INTERTEK TESTING SERVICES

4.4 Out of Band Conducted Emissions

For 802.11b/g/n20MHz, the maximum conducted (peak) output power was used to demonstrate compliance as described in 9.1. Then the display line (in red) shown in the following plots denotes the limit at 20dB below maximum measured in-band peak PSD level in 100 KHz bandwidth.

The measurement procedures under sections 11 of KDB558074 D01 v03r03 (08-April-2016) were used.

Furthermore, delta measurement technique for measuring bandedge emissions was incorporated in the test of the edge at 2483.5MHz.

Limits:

All spurious emission and up to the tenth harmonic was measured and they were found to be at least 20 dB for 802.11b,g,n20MHz below the maximum measured in-band peak PSD level.

The plots of reference level measurement and out of band conducted emissions are as below.

INTERTEK TESTING SERVICES

Plots of out of band conducted emissions

802.11b

2400

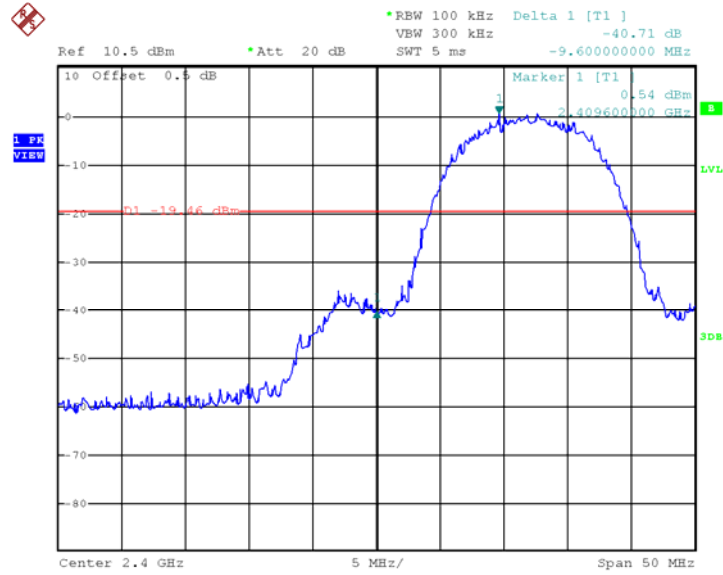

2483.5

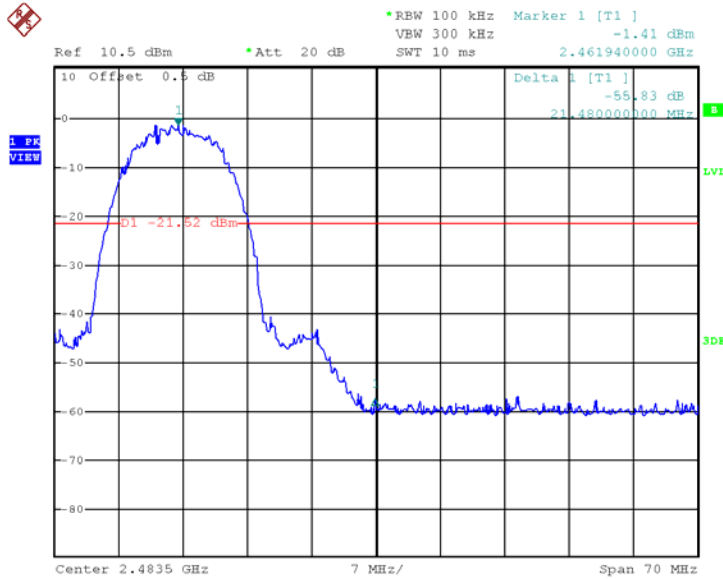

INTERTEK TESTING SERVICES

Plots of out of band conducted emissions

802.11b, Lowest Channel, Plot A

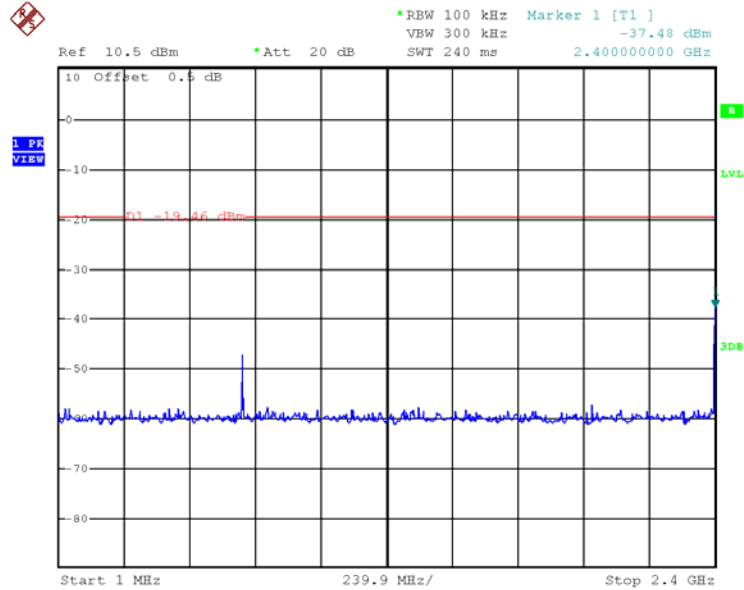

802.11b, Lowest Channel, Plot B

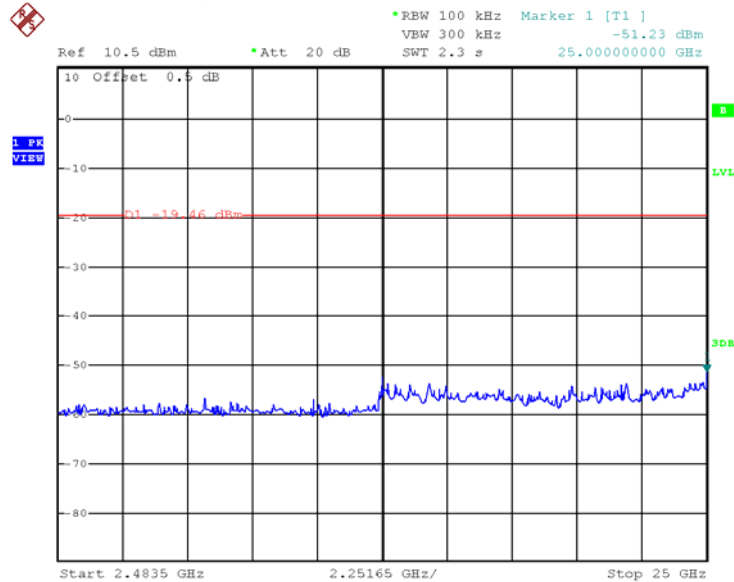

INTERTEK TESTING SERVICES

Plots of out of band conducted emissions

802.11b, Middle Channel, Plot A

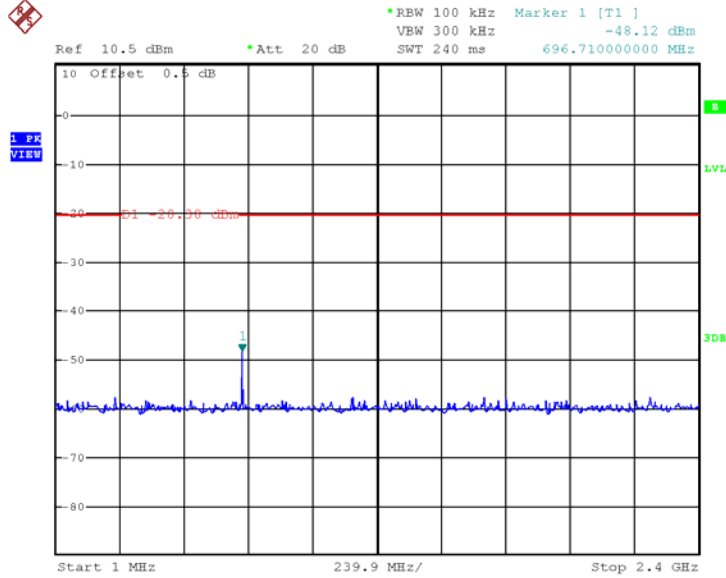

802.11b, Middle Channel, Plot B

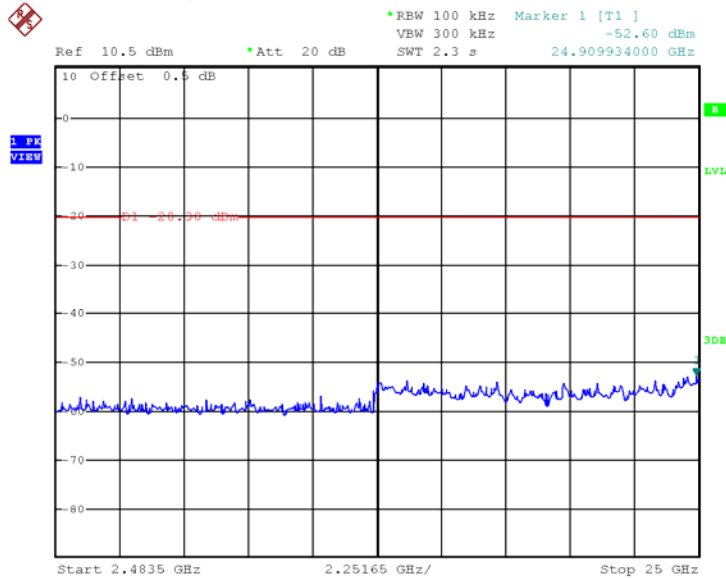

INTERTEK TESTING SERVICES

Plots of out of band conducted emissions

802.11b, Highest Channel, Plot A

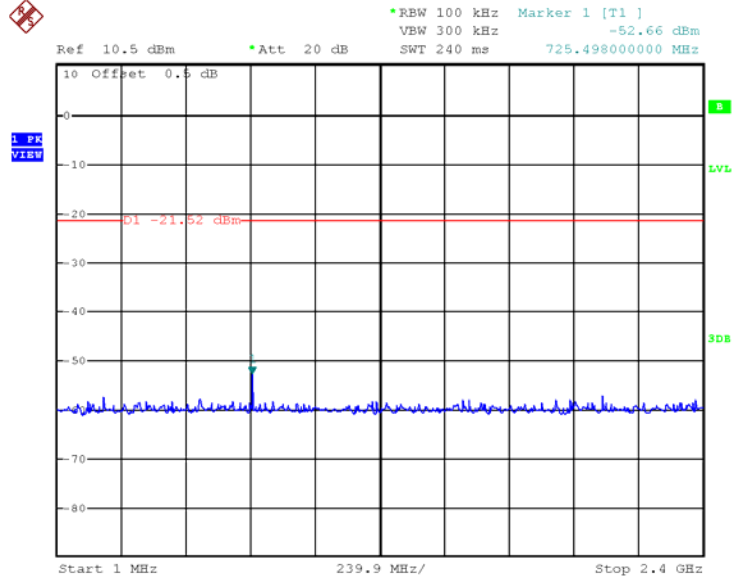

802.11b, Highest Channel, Plot B

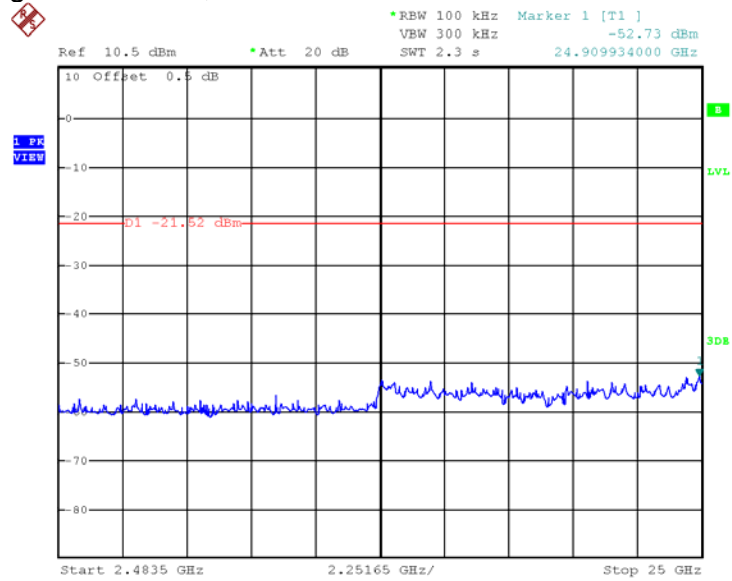

INTERTEK TESTING SERVICES

Plots of out of band conducted emissions

802.11g

2400

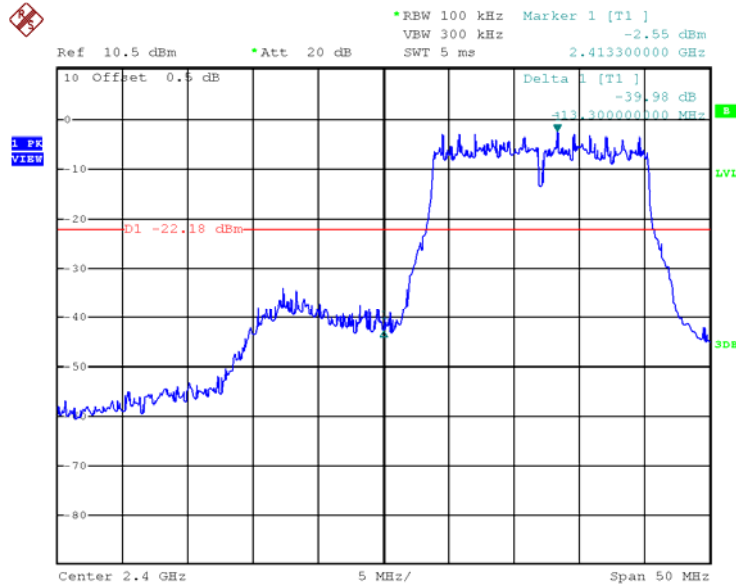

2483.5

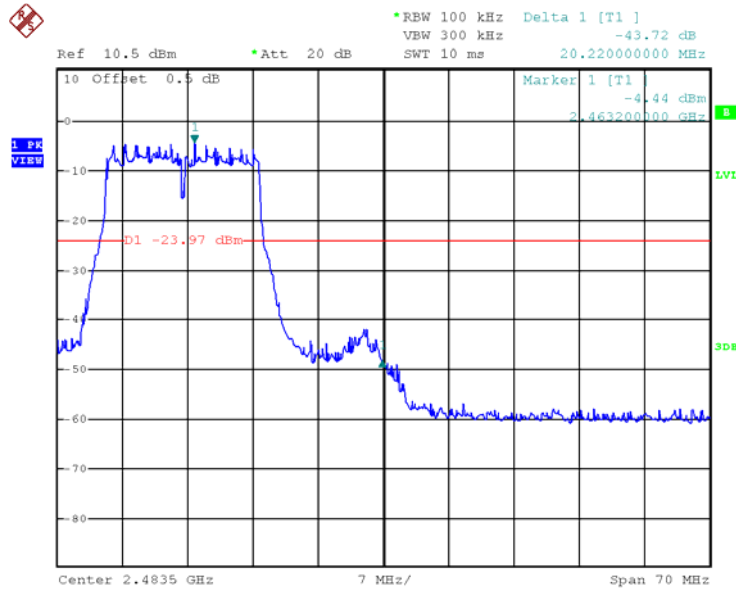

INTERTEK TESTING SERVICES

Plots of out of band conducted emissions

802.11g, Lowest Channel, Plot A

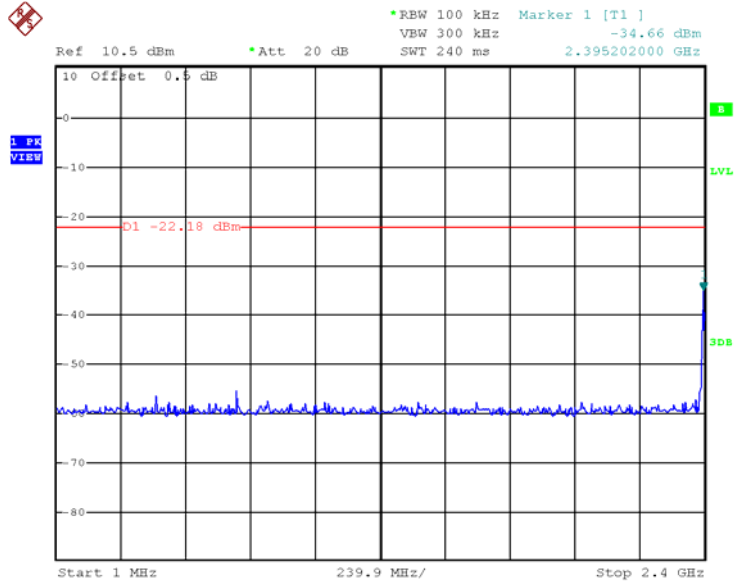

802.11g, Lowest Channel, Plot B

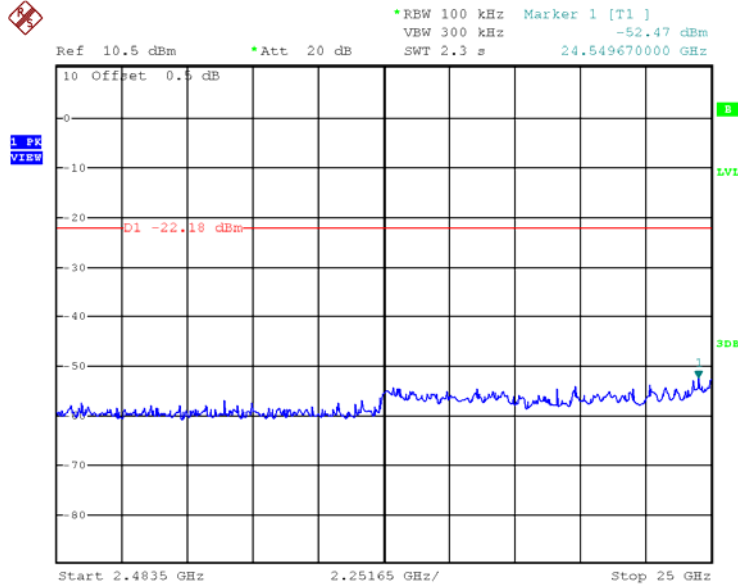

INTERTEK TESTING SERVICES

Plots of out of band conducted emissions

802.11g, Middle Channel, Plot A

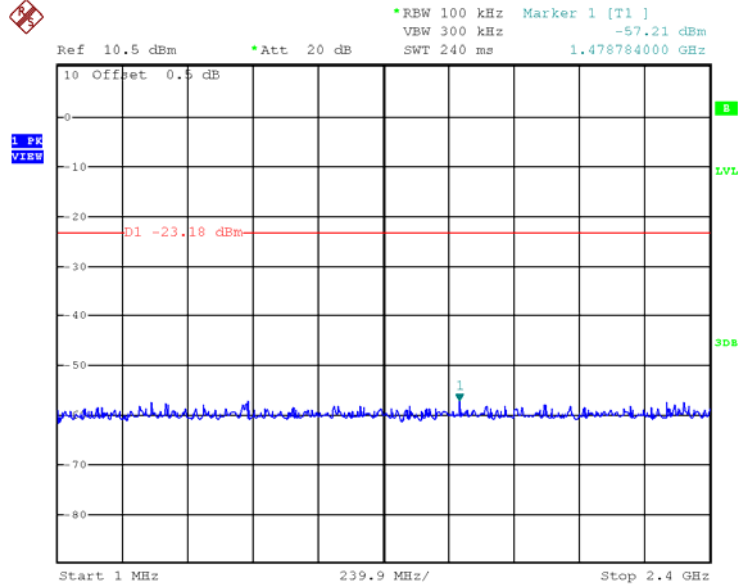

802.11g, Middle Channel, Plot B

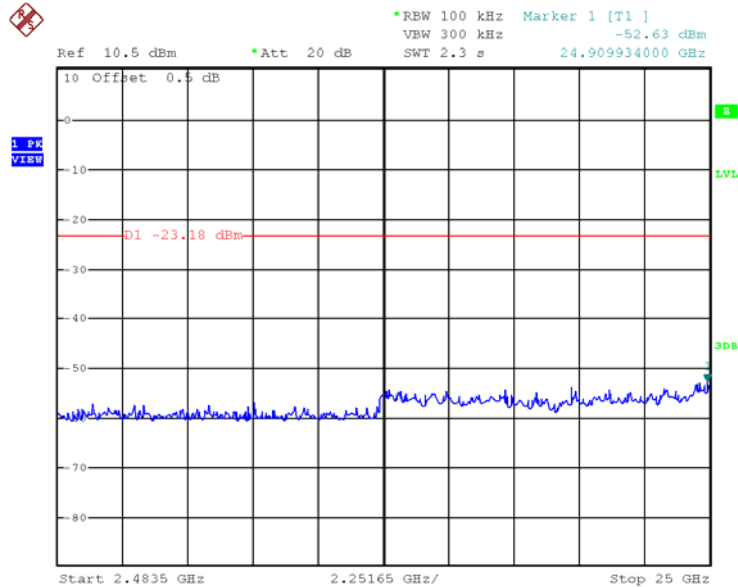

INTERTEK TESTING SERVICES

Plots of out of band conducted emissions

802.11g, Highest Channel, Plot A

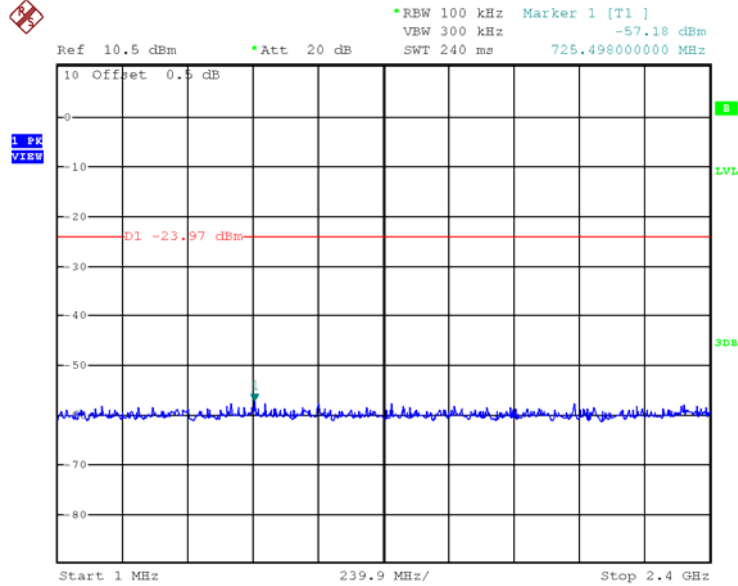

802.11g, Highest Channel, Plot B

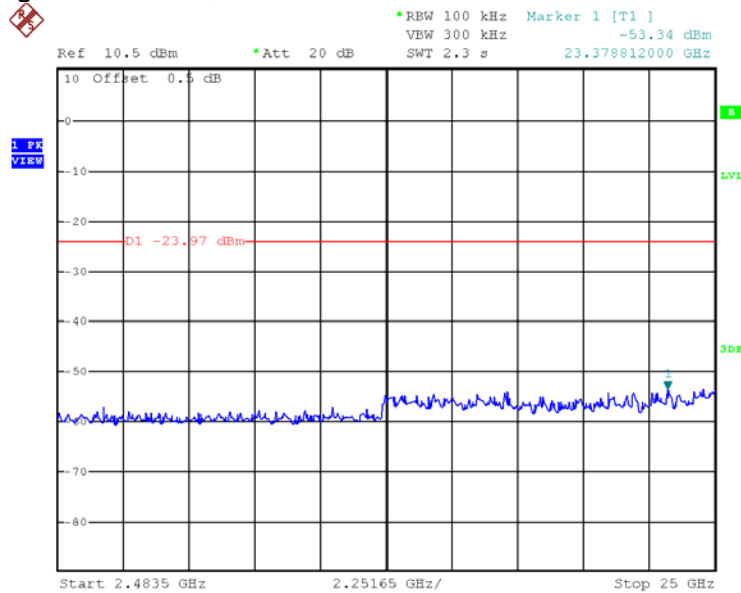

INTERTEK TESTING SERVICES

Plots of out of band conducted emissions

802.11n (20m)

2400

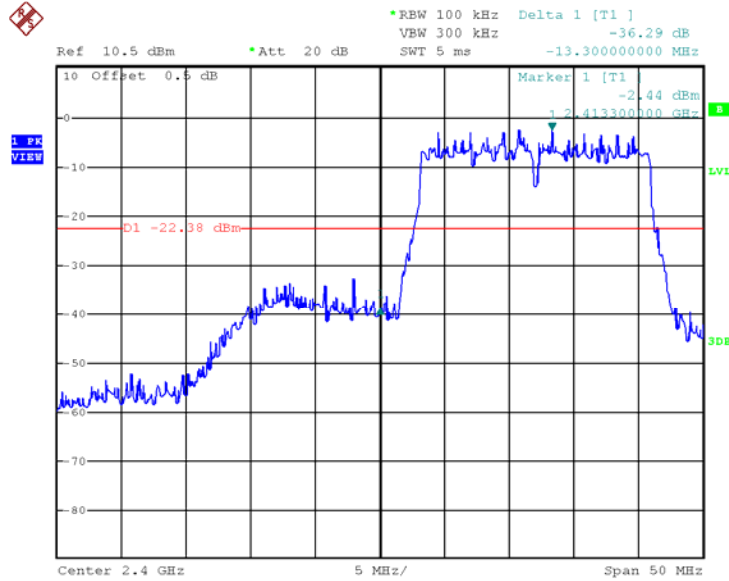

2483.5

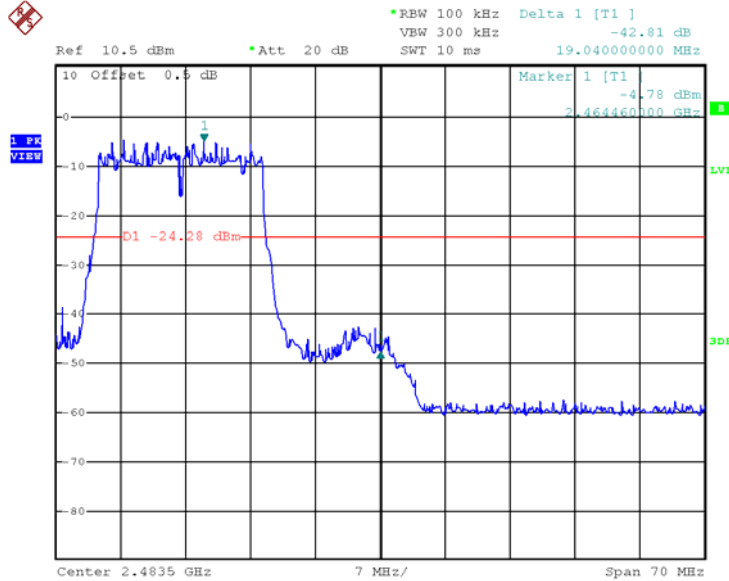

INTERTEK TESTING SERVICES

Plots of out of band conducted emissions

802.11n (20m), Lowest Channel, Plot A

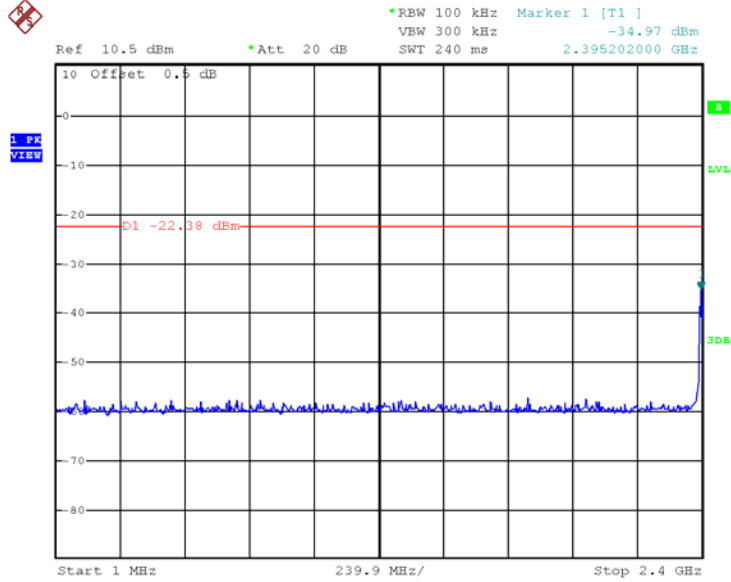

802.11n (20m), Lowest Channel, Plot B

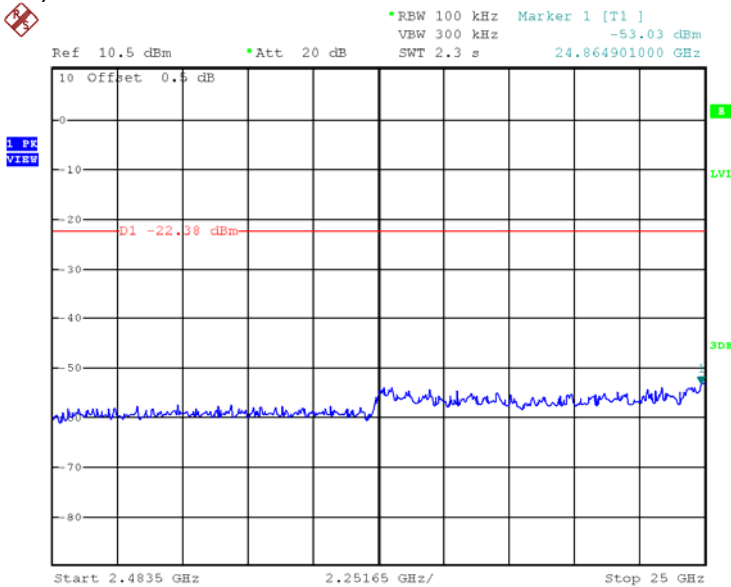

INTERTEK TESTING SERVICES

Plots of out of band conducted emissions

802.11n (20m), Middle Channel, Plot A

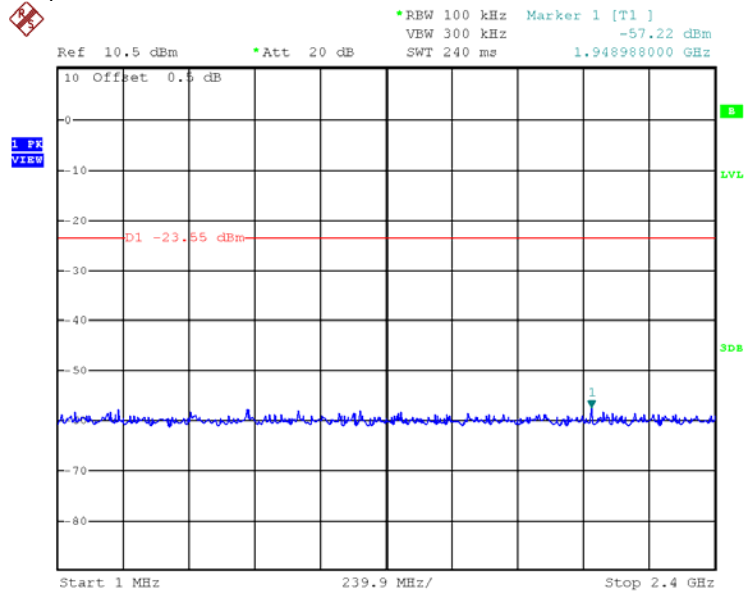

802.11n (20m), Middle Channel, Plot B

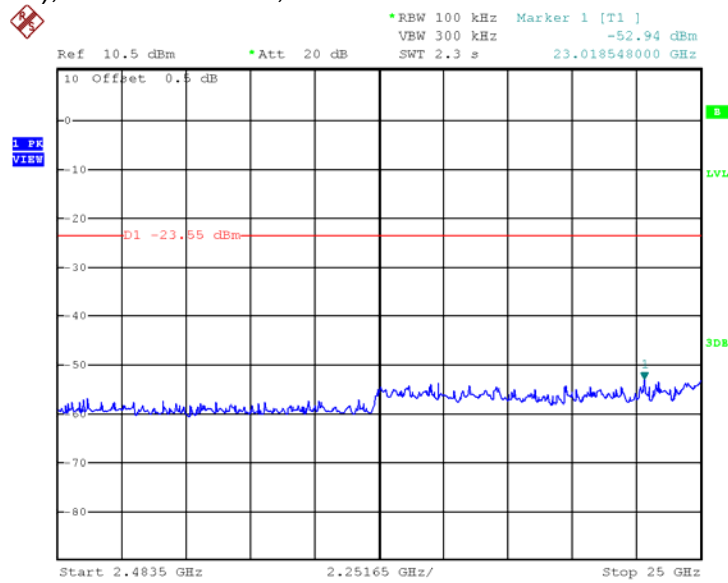

INTERTEK TESTING SERVICES

Plots of out of band conducted emissions

802.11n (20m), Highest Channel, Plot A

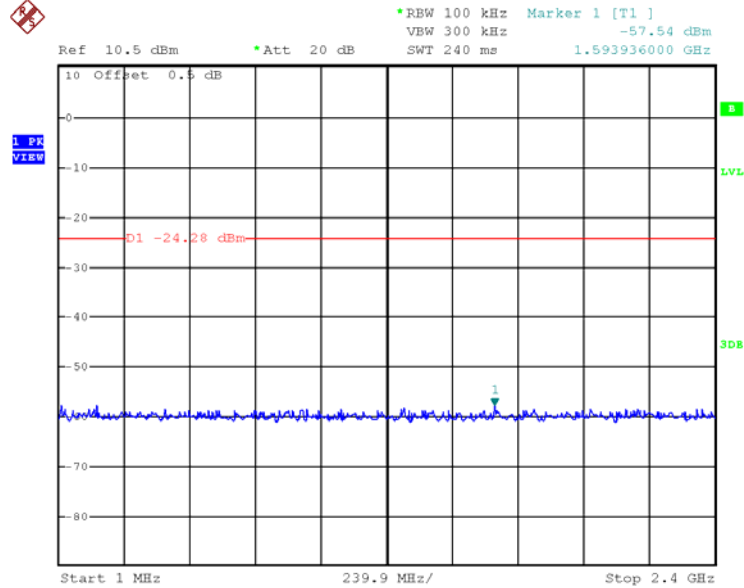

802.11n (20m), Highest Channel, Plot B

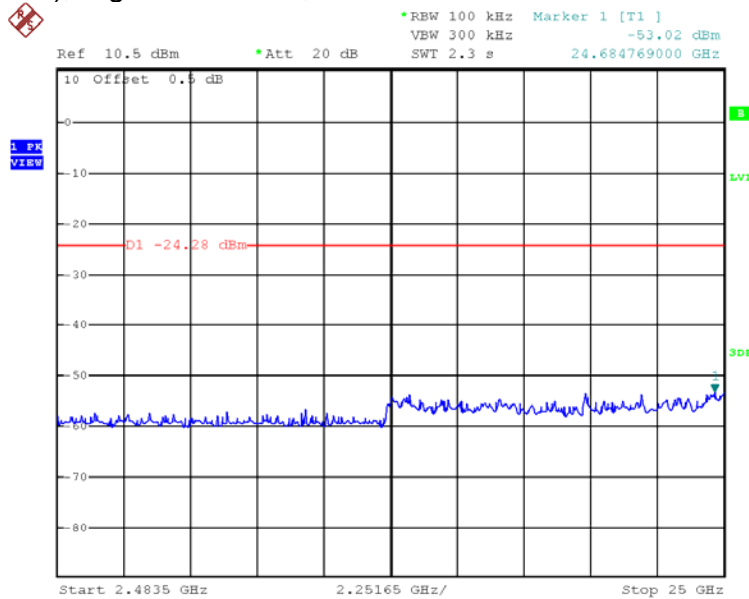

INTERTEK TESTING SERVICES

4.5 Field Strength Calculation

The field strength is calculated by adding the reading on the Spectrum Analyzer to the factors associated with preamplifiers (if any), antennas, cables, pulse desensitization and average factors (when specified limit is in average and measurements are made with peak detectors). A sample calculation is included below.

$$FS = RA + AF + CF - AG + PD + AV$$

Where

- FS = Field Strength in dB μ V/m
- RA = Receiver Amplitude (including preamplifier) in dB μ V
- CF = Cable Attenuation Factor in dB
- AF = Antenna Factor in dB
- AG = Amplifier Gain in dB
- PD = Pulse Desensitization in dB
- AV = Average Factor in -dB

In the radiated emission table which follows, the reading shown on the data table may reflect the preamplifier gain. An example of the calculations, where the reading does not reflect the preamplifier gain, follows:

$$FS = RA + AF + CF - AG + PD + AV$$

Example

Assume a receiver reading of 62.0 dB μ V is obtained. The antenna factor of 7.4 dB and cable factor of 1.6 dB is added. The amplifier gain of 29.0 dB is subtracted. The pulse desensitization factor of the spectrum analyzer is 0.0 dB, and the resultant average factor is -10.0 dB. The net field strength for comparison to the appropriate emission limit is 32.0 dB μ V/m. This value in dB μ V/m is converted to its corresponding level in μ V/m.

RA = 62.0 dB μ V
AF = 7.4 dB
CF = 1.6 dB
AG = 29.0 dB
PD = 0.0 dB
AV = -10 dB

$$FS = 62.0 + 7.4 + 1.6 - 29.0 + 0.0 + (-10.0) = 32.0 \text{ dB}\mu\text{V/m}$$

$$\text{Level in } \mu\text{V/m} = \text{Common Antilogarithm } [(32.0 \text{ dB}\mu\text{V/m})/20] = 39.8 \mu\text{V/m}$$

INTERTEK TESTING SERVICES

4.6 Transmitter Radiated Emissions in Restricted Bands and Spurious Emissions

Data is included of the worst case configuration (the configuration which resulted in the highest emission levels). A sample calculation, configuration photographs and data tables of the emissions are included.

The data on the following pages list the significant emission frequencies, the limit and the margin of compliance.

4.6.1 Radiated Emission Configuration Photograph

Worst Case Restricted Band Radiated Emission
at

215.997MHz

The worst case radiated emission configuration photographs are saved with filename:
config photos.pdf

4.6.2 Radiated Emission Data

The data in tables 1-10 list the significant emission frequencies, the limit and the margin of compliance.

Judgement -

Passed by 1.0 dB margin compare with peak limit

INTERTEK TESTING SERVICES

Mode: TX-Channel 01

Table 1
IEEE 802.11b (DSSS, 1 Mbps)

Radiated Emission Data

Polarization	Frequency (MHz)	Reading (dB μ V)	Pre-Amp Gain (dB)	Antenna Factor (dB)	Net at 3m - Average (dB μ V/m)	Average Limit at 3m (dB μ V/m)	Margin (dB)
<i>H</i>	<i>2390.000</i>	<i>50.1</i>	<i>33</i>	<i>29.4</i>	<i>46.5</i>	<i>54.0</i>	<i>-7.5</i>
<i>H</i>	<i>4824.000</i>	<i>34.5</i>	<i>33</i>	<i>34.9</i>	<i>36.4</i>	<i>54.0</i>	<i>-17.6</i>
<i>V</i>	<i>12060.000</i>	<i>33.6</i>	<i>33</i>	<i>40.5</i>	<i>41.1</i>	<i>54.0</i>	<i>-12.9</i>
<i>H</i>	<i>14472.000</i>	<i>35.2</i>	<i>33</i>	<i>40.0</i>	<i>42.2</i>	<i>54.0</i>	<i>-11.8</i>

Remark: Average measurement method is used according to ANSI C63.10.

Polarization	Frequency (MHz)	Reading (dB μ V)	Pre-Amp Gain (dB)	Antenna Factor (dB)	Net at 3m - Peak (dB μ V/m)	Peak Limit at 3m (dB μ V/m)	Margin (dB)
<i>H</i>	<i>2390.000</i>	<i>62.1</i>	<i>33</i>	<i>29.4</i>	<i>58.5</i>	<i>74.0</i>	<i>-15.5</i>
<i>H</i>	<i>4824.000</i>	<i>50.6</i>	<i>33</i>	<i>34.9</i>	<i>52.5</i>	<i>74.0</i>	<i>-21.5</i>
<i>V</i>	<i>12060.000</i>	<i>42.8</i>	<i>33</i>	<i>40.5</i>	<i>50.3</i>	<i>74.0</i>	<i>-23.7</i>
<i>H</i>	<i>14472.000</i>	<i>44.5</i>	<i>33</i>	<i>40.0</i>	<i>51.5</i>	<i>74.0</i>	<i>-22.5</i>

Remarks: Peak detector is used for the emission measurement.

- NOTES:
1. Peak detector is used for the emission measurement.
 2. All measurements were made at 3 meters. Radiated emissions not detected at the 3-meter distance were measured at 0.3-meter and an inverse proportional extrapolation was performed to compare the signal level to the 3-meter limit. No other radiated emissions than those reported were detected at a test distance of 0.3-meter.
 3. Negative value in the margin column shows emission below limit.
 4. Horn antenna is used for the emission over 1000MHz.
 5. Emission (the row indicated by ***bold italic***) within the restricted band meets the requirement of FCC Part 15 Section 15.205.
 6. For the measurement of radiated emission, summation method was used which numerical integrating (in terms of linear power) over the transmitter occupied bandwidth.
 7. For the linear power measurement, data in 1MHz spacing was collected by spectrum analyzer with 1MHz resolution bandwidth.

INTERTEK TESTING SERVICES

Mode: TX-Channel 07

Table 2
IEEE 802.11b (DSSS, 1 Mbps)

Radiated Emission Data

Polarization	Frequency (MHz)	Reading (dB μ V)	Pre-Amp Gain (dB)	Antenna Factor (dB)	Net at 3m - Average (dB μ V/m)	Average Limit at 3m (dB μ V/m)	Margin (dB)
H	4874.000	35.3	33	34.9	37.2	54.0	-16.8
H	7311.000	30.7	33	37.9	35.6	54.0	-18.4
V	12185.000	33.8	33	40.5	41.3	54.0	-12.7

Remark: Average measurement method is used according to ANSI C63.10.

Polarization	Frequency (MHz)	Reading (dB μ V)	Pre-Amp Gain (dB)	Antenna Factor (dB)	Net at 3m - Peak (dB μ V/m)	Peak Limit at 3m (dB μ V/m)	Margin (dB)
H	4874.000	51.2	33	34.9	53.1	74.0	-20.9
H	7311.000	40.4	33	37.9	45.3	74.0	-28.7
V	12185.000	42.9	33	40.5	50.4	74.0	-23.6

Remarks: Peak detector is used for the emission measurement.

- NOTES:
1. Peak detector is used for the emission measurement.
 2. All measurements were made at 3 meters. Radiated emissions not detected at the 3-meter distance were measured at 0.3-meter and an inverse proportional extrapolation was performed to compare the signal level to the 3-meter limit. No other radiated emissions than those reported were detected at a test distance of 0.3-meter.
 3. Negative value in the margin column shows emission below limit.
 4. Horn antenna is used for the emission over 1000MHz.
 5. Emission (the row indicated by **bold italic**) within the restricted band meets the requirement of FCC Part 15 Section 15.205.
 6. For the measurement of radiated emission, summation method was used which numerical integrating (in terms of linear power) over the transmitter occupied bandwidth.
 7. For the linear power measurement, data in 1MHz spacing was collected by spectrum analyzer with 1MHz resolution bandwidth.

INTERTEK TESTING SERVICES

Mode: TX-Channel 11

Table 3
IEEE 802.11b (DSSS, 1 Mbps)

Radiated Emission Data

Polarization	Frequency (MHz)	Reading (dB μ V)	Pre-Amp Gain (dB)	Antenna Factor (dB)	Net at 3m - Average (dB μ V/m)	Average Limit at 3m (dB μ V/m)	Margin (dB)
H	2483.500	50.3	33	29.4	46.7	54.0	-7.3
H	4924.000	34.4	33	34.9	36.3	54.0	-17.7
H	7386.000	30.6	33	37.9	35.5	54.0	-18.5
V	12310.000	33.5	33	40.5	41.0	54.0	-13.0

Remark: Average measurement method is used according to ANSI C63.10.

Polarization	Frequency (MHz)	Reading (dB μ V)	Pre-Amp Gain (dB)	Antenna Factor (dB)	Net at 3m - Peak (dB μ V/m)	Peak Limit at 3m (dB μ V/m)	Margin (dB)
H	2483.500	62.6	33	29.4	59.0	74.0	-15.0
H	4924.000	50.6	33	34.9	52.5	74.0	-21.5
H	7386.000	40.4	33	37.9	45.3	74.0	-28.7
V	12310.000	42.6	33	40.5	50.1	74.0	-23.9

Remarks: Peak detector is used for the emission measurement.

- NOTES:
1. Peak detector is used for the emission measurement.
 2. All measurements were made at 3 meters. Radiated emissions not detected at the 3-meter distance were measured at 0.3-meter and an inverse proportional extrapolation was performed to compare the signal level to the 3-meter limit. No other radiated emissions than those reported were detected at a test distance of 0.3-meter.
 3. Negative value in the margin column shows emission below limit.
 4. Horn antenna is used for the emission over 1000MHz.
 5. Emission (the row indicated by **bold italic**) within the restricted band meets the requirement of FCC Part 15 Section 15.205.
 6. For the measurement of radiated emission, summation method was used which numerical integrating (in terms of linear power) over the transmitter occupied bandwidth.
 7. For the linear power measurement, data in 1MHz spacing was collected by spectrum analyzer with 1MHz resolution bandwidth.

INTERTEK TESTING SERVICES

Mode: TX-Channel 01

Table 4
IEEE 802.11g (OFDM, 6 Mbps)

Radiated Emission Data

Polarization	Frequency (MHz)	Reading (dB μ V)	Pre-Amp Gain (dB)	Antenna Factor (dB)	Net at 3m - Average (dB μ V/m)	Average Limit at 3m (dB μ V/m)	Margin (dB)
H	2390.000	51.4	33	29.4	47.8	54.0	-6.2
H	4824.000	34.7	33	34.9	36.6	54.0	-17.4
H	12060.000	33.7	33	40.5	41.2	54.0	-12.8
V	14472.000	35.4	33	40.0	42.4	54.0	-11.6

Remark: Average measurement method is used according to ANSI C63.10.

Polarization	Frequency (MHz)	Reading (dB μ V)	Pre-Amp Gain (dB)	Antenna Factor (dB)	Net at 3m - Peak (dB μ V/m)	Peak Limit at 3m (dB μ V/m)	Margin (dB)
H	2390.000	70.7	33	29.4	67.1	74.0	-6.9
H	4824.000	51.0	33	34.9	52.9	74.0	-21.1
H	12060.000	42.8	33	40.5	50.3	74.0	-23.7
V	14472.000	44.6	33	40.0	51.6	74.0	-22.4

Remarks: Peak detector is used for the emission measurement.

- NOTES:
1. Peak detector is used for the emission measurement.
 2. All measurements were made at 3 meters. Radiated emissions not detected at the 3-meter distance were measured at 0.3-meter and an inverse proportional extrapolation was performed to compare the signal level to the 3-meter limit. No other radiated emissions than those reported were detected at a test distance of 0.3-meter.
 3. Negative value in the margin column shows emission below limit.
 4. Horn antenna is used for the emission over 1000MHz.
 5. Emission (the row indicated by **bold italic**) within the restricted band meets the requirement of FCC Part 15 Section 15.205.
 6. For the measurement of radiated emission, summation method was used which numerical integrating (in terms of linear power) over the transmitter occupied bandwidth.
 7. For the linear power measurement, data in 1MHz spacing was collected by spectrum analyzer with 1MHz resolution bandwidth.

INTERTEK TESTING SERVICES

Mode: TX-Channel 07

Table 5
IEEE 802.11g (OFDM, 6 Mbps)

Radiated Emission Data

Polarization	Frequency (MHz)	Reading (dB μ V)	Pre-Amp Gain (dB)	Antenna Factor (dB)	Net at 3m - Average (dB μ V/m)	Average Limit at 3m (dB μ V/m)	Margin (dB)
<i>H</i>	4874.000	35.4	33	34.9	37.3	54.0	-16.7
<i>H</i>	7311.000	30.5	33	37.9	35.4	54.0	-18.6
<i>H</i>	12185.000	33.8	33	40.5	41.3	54.0	-12.7

Remark: Average measurement method is used according to ANSI C63.10.

Polarization	Frequency (MHz)	Reading (dB μ V)	Pre-Amp Gain (dB)	Antenna Factor (dB)	Net at 3m - Peak (dB μ V/m)	Peak Limit at 3m (dB μ V/m)	Margin (dB)
<i>H</i>	4874.000	51.3	33	34.9	53.2	74.0	-20.8
<i>H</i>	7311.000	40.3	33	37.9	45.2	74.0	-28.8
<i>H</i>	12185.000	43.0	33	40.5	50.5	74.0	-23.5

Remarks: Peak detector is used for the emission measurement.

- NOTES:
1. Peak detector is used for the emission measurement.
 2. All measurements were made at 3 meters. Radiated emissions not detected at the 3-meter distance were measured at 0.3-meter and an inverse proportional extrapolation was performed to compare the signal level to the 3-meter limit. No other radiated emissions than those reported were detected at a test distance of 0.3-meter.
 3. Negative value in the margin column shows emission below limit.
 4. Horn antenna is used for the emission over 1000MHz.
 5. Emission (the row indicated by ***bold italic***) within the restricted band meets the requirement of FCC Part 15 Section 15.205.
 6. For the measurement of radiated emission, summation method was used which numerical integrating (in terms of linear power) over the transmitter occupied bandwidth.
 7. For the linear power measurement, data in 1MHz spacing was collected by spectrum analyzer with 1MHz resolution bandwidth.

INTERTEK TESTING SERVICES

Mode: TX-Channel 11

Table 6
IEEE 802.11g (OFDM, 6 Mbps)

Radiated Emission Data

Polarization	Frequency (MHz)	Reading (dB μ V)	Pre-Amp Gain (dB)	Antenna Factor (dB)	Net at 3m - Average (dB μ V/m)	Average Limit at 3m (dB μ V/m)	Margin (dB)
<i>H</i>	<i>2483.500</i>	<i>50.3</i>	<i>33</i>	<i>29.4</i>	<i>46.7</i>	<i>54.0</i>	<i>-7.3</i>
<i>H</i>	<i>4924.000</i>	<i>34.5</i>	<i>33</i>	<i>34.9</i>	<i>36.4</i>	<i>54.0</i>	<i>-17.6</i>
<i>H</i>	<i>7386.000</i>	<i>30.8</i>	<i>33</i>	<i>37.9</i>	<i>35.7</i>	<i>54.0</i>	<i>-18.3</i>
<i>H</i>	<i>12310.000</i>	<i>33.8</i>	<i>33</i>	<i>40.5</i>	<i>41.3</i>	<i>54.0</i>	<i>-12.7</i>

Remark: Average measurement method is used according to ANSI C63.10.

Polarization	Frequency (MHz)	Reading (dB μ V)	Pre-Amp Gain (dB)	Antenna Factor (dB)	Net at 3m - Peak (dB μ V/m)	Peak Limit at 3m (dB μ V/m)	Margin (dB)
<i>H</i>	<i>2483.500</i>	<i>65.8</i>	<i>33</i>	<i>29.4</i>	<i>62.2</i>	<i>74.0</i>	<i>-11.8</i>
<i>H</i>	<i>4924.000</i>	<i>50.7</i>	<i>33</i>	<i>34.9</i>	<i>52.6</i>	<i>74.0</i>	<i>-21.4</i>
<i>H</i>	<i>7386.000</i>	<i>40.6</i>	<i>33</i>	<i>37.9</i>	<i>45.5</i>	<i>74.0</i>	<i>-28.5</i>
<i>H</i>	<i>12310.000</i>	<i>42.8</i>	<i>33</i>	<i>40.5</i>	<i>50.3</i>	<i>74.0</i>	<i>-23.7</i>

Remarks: Peak detector is used for the emission measurement.

- NOTES:
1. Peak detector is used for the emission measurement.
 2. All measurements were made at 3 meters. Radiated emissions not detected at the 3-meter distance were measured at 0.3-meter and an inverse proportional extrapolation was performed to compare the signal level to the 3-meter limit. No other radiated emissions than those reported were detected at a test distance of 0.3-meter.
 3. Negative value in the margin column shows emission below limit.
 6. Horn antenna is used for the emission over 1000MHz.
 7. Emission (the row indicated by ***bold italic***) within the restricted band meets the requirement of FCC Part 15 Section 15.205.
 6. For the measurement of radiated emission, summation method was used which numerical integrating (in terms of linear power) over the transmitter occupied bandwidth.
 7. For the linear power measurement, data in 1MHz spacing was collected by spectrum analyzer with 1MHz resolution bandwidth.

INTERTEK TESTING SERVICES

Mode: TX-Channel 01

Table 7
IEEE 802.11n (20MHz) (OFDM, MCS0)

Radiated Emission Data

Polarization	Frequency (MHz)	Reading (dB μ V)	Pre-Amp Gain (dB)	Antenna Factor (dB)	Net at 3m - Average (dB μ V/m)	Average Limit at 3m (dB μ V/m)	Margin (dB)
<i>H</i>	<i>2390.000</i>	<i>50.6</i>	<i>33</i>	<i>29.4</i>	<i>47.0</i>	<i>54.0</i>	<i>-7.0</i>
<i>H</i>	<i>4824.000</i>	<i>34.0</i>	<i>33</i>	<i>34.9</i>	<i>35.9</i>	<i>54.0</i>	<i>-18.1</i>
<i>H</i>	<i>12060.000</i>	<i>33.8</i>	<i>33</i>	<i>40.5</i>	<i>41.3</i>	<i>54.0</i>	<i>-12.7</i>
<i>V</i>	<i>14472.000</i>	<i>35.3</i>	<i>33</i>	<i>40.0</i>	<i>42.3</i>	<i>54.0</i>	<i>-11.7</i>

Remark: Average measurement method is used according to ANSI C63.10.

Polarization	Frequency (MHz)	Reading (dB μ V)	Pre-Amp Gain (dB)	Antenna Factor (dB)	Net at 3m - Peak (dB μ V/m)	Peak Limit at 3m (dB μ V/m)	Margin (dB)
<i>H</i>	<i>2390.000</i>	<i>68.1</i>	<i>33</i>	<i>29.4</i>	<i>64.5</i>	<i>74.0</i>	<i>-9.5</i>
<i>H</i>	<i>4824.000</i>	<i>43.7</i>	<i>33</i>	<i>34.9</i>	<i>45.6</i>	<i>74.0</i>	<i>-28.4</i>
<i>H</i>	<i>12060.000</i>	<i>43.0</i>	<i>33</i>	<i>40.5</i>	<i>50.5</i>	<i>74.0</i>	<i>-23.5</i>
<i>V</i>	<i>14472.000</i>	<i>44.5</i>	<i>33</i>	<i>40.0</i>	<i>51.5</i>	<i>74.0</i>	<i>-22.5</i>

Remarks: Peak detector is used for the emission measurement.

- NOTES:
1. Peak detector is used for the emission measurement.
 2. All measurements were made at 3 meters. Radiated emissions not detected at the 3-meter distance were measured at 0.3-meter and an inverse proportional extrapolation was performed to compare the signal level to the 3-meter limit. No other radiated emissions than those reported were detected at a test distance of 0.3-meter.
 3. Negative value in the margin column shows emission below limit.
 8. Horn antenna is used for the emission over 1000MHz.
 9. Emission (the row indicated by ***bold italic***) within the restricted band meets the requirement of FCC Part 15 Section 15.205.
 6. For the measurement of radiated emission, summation method was used which numerical integrating (in terms of linear power) over the transmitter occupied bandwidth.
 7. For the linear power measurement, data in 1MHz spacing was collected by spectrum analyzer with 1MHz resolution bandwidth.

INTERTEK TESTING SERVICES

Mode: TX-Channel 07

Table 8
IEEE 802.11n (20MHz) (OFDM, MCS0)

Radiated Emission Data

Polarization	Frequency (MHz)	Reading (dB μ V)	Pre-Amp Gain (dB)	Antenna Factor (dB)	Net at 3m - Average (dB μ V/m)	Average Limit at 3m (dB μ V/m)	Margin (dB)
<i>H</i>	<i>4874.000</i>	<i>33.9</i>	<i>33</i>	<i>34.9</i>	<i>35.8</i>	<i>54.0</i>	<i>-18.2</i>
<i>H</i>	<i>7311.000</i>	<i>30.5</i>	<i>33</i>	<i>37.9</i>	<i>35.4</i>	<i>54.0</i>	<i>-18.6</i>
<i>H</i>	<i>12185.000</i>	<i>33.9</i>	<i>33</i>	<i>40.5</i>	<i>41.4</i>	<i>54.0</i>	<i>-12.6</i>

Remark: Average measurement method is used according to ANSI C63.10.

Polarization	Frequency (MHz)	Reading (dB μ V)	Pre-Amp Gain (dB)	Antenna Factor (dB)	Net at 3m - Peak (dB μ V/m)	Peak Limit at 3m (dB μ V/m)	Margin (dB)
<i>H</i>	<i>4874.000</i>	<i>43.6</i>	<i>33</i>	<i>34.9</i>	<i>45.5</i>	<i>74.0</i>	<i>-28.5</i>
<i>H</i>	<i>7311.000</i>	<i>40.2</i>	<i>33</i>	<i>37.9</i>	<i>45.1</i>	<i>74.0</i>	<i>-28.9</i>
<i>H</i>	<i>12185.000</i>	<i>43.2</i>	<i>33</i>	<i>40.5</i>	<i>50.7</i>	<i>74.0</i>	<i>-23.3</i>

Remarks: Peak detector is used for the emission measurement.

- NOTES:
1. Peak detector is used for the emission measurement.
 2. All measurements were made at 3 meters. Radiated emissions not detected at the 3-meter distance were measured at 0.3-meter and an inverse proportional extrapolation was performed to compare the signal level to the 3-meter limit. No other radiated emissions than those reported were detected at a test distance of 0.3-meter.
 3. Negative value in the margin column shows emission below limit.
 4. Horn antenna is used for the emission over 1000MHz.
 5. Emission (the row indicated by ***bold italic***) within the restricted band meets the requirement of FCC Part 15 Section 15.205.
 6. For the measurement of radiated emission, summation method was used which numerical integrating (in terms of linear power) over the transmitter occupied bandwidth.
 7. For the linear power measurement, data in 1MHz spacing was collected by spectrum analyzer with 1MHz resolution bandwidth.

INTERTEK TESTING SERVICES

Mode: TX-Channel 11

Table 9
IEEE 802.11n (20MHz) (OFDM, MCS0)

Radiated Emission Data

Polarization	Frequency (MHz)	Reading (dB μ V)	Pre-Amp Gain (dB)	Antenna Factor (dB)	Net at 3m - Average (dB μ V/m)	Average Limit at 3m (dB μ V/m)	Margin (dB)
<i>H</i>	<i>2483.500</i>	<i>50.3</i>	<i>33</i>	<i>29.4</i>	<i>46.7</i>	<i>54.0</i>	<i>-7.3</i>
<i>H</i>	<i>4924.000</i>	<i>34.1</i>	<i>33</i>	<i>34.9</i>	<i>36.0</i>	<i>54.0</i>	<i>-18.0</i>
<i>H</i>	<i>7386.000</i>	<i>30.8</i>	<i>33</i>	<i>37.9</i>	<i>35.7</i>	<i>54.0</i>	<i>-18.3</i>
<i>H</i>	<i>12310.000</i>	<i>33.9</i>	<i>33</i>	<i>40.5</i>	<i>41.4</i>	<i>54.0</i>	<i>-12.6</i>

Remark: Average measurement method is used according to ANSI C63.10.

Polarization	Frequency (MHz)	Reading (dB μ V)	Pre-Amp Gain (dB)	Antenna Factor (dB)	Net at 3m - Peak (dB μ V/m)	Peak Limit at 3m (dB μ V/m)	Margin (dB)
<i>H</i>	<i>2483.500</i>	<i>65.9</i>	<i>33</i>	<i>29.4</i>	<i>62.3</i>	<i>74.0</i>	<i>-11.7</i>
<i>H</i>	<i>4924.000</i>	<i>43.9</i>	<i>33</i>	<i>34.9</i>	<i>45.8</i>	<i>74.0</i>	<i>-28.2</i>
<i>H</i>	<i>7386.000</i>	<i>40.5</i>	<i>33</i>	<i>37.9</i>	<i>45.4</i>	<i>74.0</i>	<i>-28.6</i>
<i>H</i>	<i>12310.000</i>	<i>43.0</i>	<i>33</i>	<i>40.5</i>	<i>50.5</i>	<i>74.0</i>	<i>-23.5</i>

Remarks: Peak detector is used for the emission measurement.

- NOTES:
1. Peak detector is used for the emission measurement.
 2. All measurements were made at 3 meters. Radiated emissions not detected at the 3-meter distance were measured at 0.3-meter and an inverse proportional extrapolation was performed to compare the signal level to the 3-meter limit. No other radiated emissions than those reported were detected at a test distance of 0.3-meter.
 3. Negative value in the margin column shows emission below limit.
 4. Horn antenna is used for the emission over 1000MHz.
 5. Emission (the row indicated by ***bold italic***) within the restricted band meets the requirement of FCC Part 15 Section 15.205
 6. For the measurement of radiated emission, summation method was used which numerical integrating (in terms of linear power) over the transmitter occupied bandwidth.
 7. For the linear power measurement, data in 1MHz spacing was collected by spectrum analyzer with 1MHz resolution bandwidth.

INTERTEK TESTING SERVICES

Mode: WIFI Tx B transmitting

Table 10

Radiated Emission Data

Polarization	Frequency (MHz)	Reading (dB μ V)	Pre-amp (dB)	Antenna Factor (dB)	Net at 3m (dB μ V/m)	Limit at 3m (dB μ V/m)	Margin (dB)
H	87.836	40.3	16	9.0	33.3	40.0	-6.7
H	90.326	41.1	16	11.0	36.1	43.5	-7.4
H	288.020	38.1	16	22.0	44.1	46.0	-1.9
H	300.023	32.8	16	22.0	38.8	46.0	-7.2
H	432.065	27.3	16	25.0	36.3	46.0	-9.7
H	503.966	24.3	16	26.0	34.3	46.0	-11.7
H	575.988	27.0	16	28.0	39.0	46.0	-7.0
H	756.045	23.5	16	30.0	37.5	46.0	-8.5

- NOTES:
1. Peak detector is used for the emission measurement.
 2. All measurements were made at 3 meters. Radiated emissions not detected at the 3-meter distance were measured at 0.3-meter and an inverse proportional extrapolation was performed to compare the signal level to the 3-meter limit. No other radiated emissions than those reported were detected at a test distance of 0.3-meter.
 3. Negative value in the margin column shows emission below limit.
 4. Emission (the row indicated by ***bold italic***) within the restricted band meets the requirement of FCC Part 15 Section 15.205.

INTERTEK TESTING SERVICES

Mode: WIFI Tx G transmitting

Table 11

Radiated Emission Data

Polarization	Frequency (MHz)	Reading (dB μ V)	Pre-amp (dB)	Antenna Factor (dB)	Net at 3m (dB μ V/m)	Limit at 3m (dB μ V/m)	Margin (dB)
H	87.351	39.4	16	9.0	32.4	40.0	-7.6
H	93.656	41.8	16	11.0	36.8	43.5	-6.7
H	215.997	37.9	16	17.0	38.9	43.5	-4.6
V	252.008	36.5	16	20.0	40.5	46.0	-5.5
H	288.020	36.7	16	22.0	42.7	46.0	-3.3
V	324.031	33.2	16	24.0	41.2	46.0	-4.8
H	431.943	28.6	16	25.0	37.6	46.0	-8.4
H	720.033	20.8	16	30.0	34.8	46.0	-11.2

- NOTES:
1. Peak detector is used for the emission measurement.
 2. All measurements were made at 3 meters. Radiated emissions not detected at the 3-meter distance were measured at 0.3-meter and an inverse proportional extrapolation was performed to compare the signal level to the 3-meter limit. No other radiated emissions than those reported were detected at a test distance of 0.3-meter.
 3. Negative value in the margin column shows emission below limit.
 4. Emission (the row indicated by **bold italic**) within the restricted band meets the requirement of FCC Part 15 Section 15.205.

INTERTEK TESTING SERVICES

Mode: WIFI Tx N transmitting

Table 12

Radiated Emission Data

Polarization	Frequency (MHz)	Reading (dB μ V)	Pre-amp (dB)	Antenna Factor (dB)	Net at 3m (dB μ V/m)	Limit at 3m (dB μ V/m)	Margin (dB)
H	87.593	39.4	16	9.0	32.4	40.0	-7.6
H	90.503	42.7	16	11.0	37.7	43.5	-5.8
H	215.997	41.5	16	17.0	42.5	43.5	-1.0
H	252.008	37.1	16	20.0	41.1	46.0	-4.9
H	288.020	36.9	16	22.0	42.9	46.0	-3.1
V	324.031	33.6	16	24.0	41.6	46.0	-4.4
H	359.921	32.3	16	24.0	40.3	46.0	-5.7
H	431.943	27.9	16	25.0	36.9	46.0	-9.1

- NOTES:
1. Peak detector is used for the emission measurement.
 2. All measurements were made at 3 meters. Radiated emissions not detected at the 3-meter distance were measured at 0.3-meter and an inverse proportional extrapolation was performed to compare the signal level to the 3-meter limit. No other radiated emissions than those reported were detected at a test distance of 0.3-meter.
 3. Negative value in the margin column shows emission below limit.
 4. Emission (the row indicated by **bold italic**) within the restricted band meets the requirement of FCC Part 15 Section 15.205.

INTERTEK TESTING SERVICES

4.6.3 Radiated Emission Test Setup

The figure below shows the test setup, which is utilized to make these measurements.

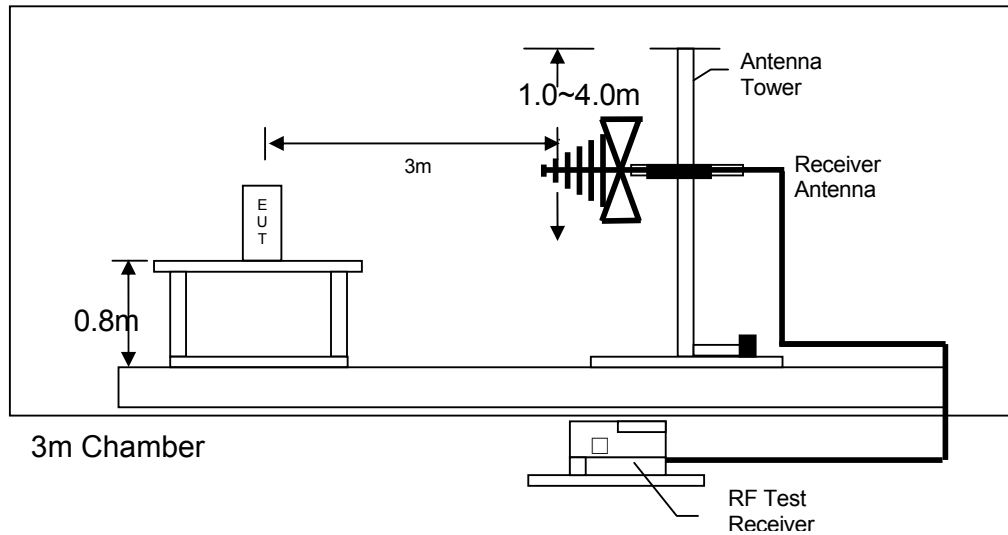

Test setup of radiated emissions up to 1GHz

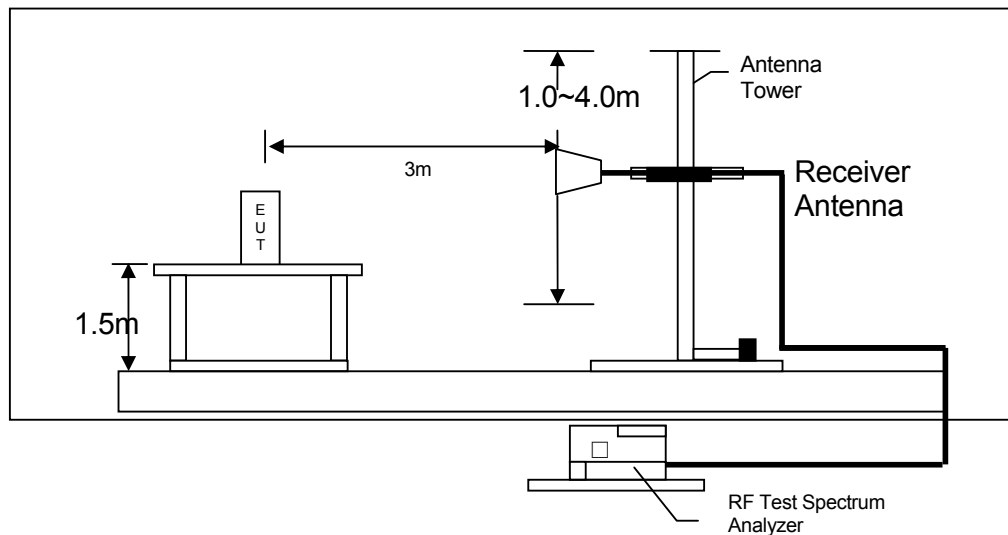

Test setup of radiated emissions above 1GHz

INTERTEK TESTING SERVICES

4.6.4 Transmitter Duty Cycle Calculation

Not applicable – No average factor is required.

INTERTEK TESTING SERVICES

4.7 AC Power Line Conducted Emission

- Not applicable – EUT is only powered by battery for operation.
- EUT connects to AC power line. Emission Data is listed in following pages.
- Base Unit connects to AC power line and has transmission. Handset connects to AC power line but has no transmission. Emission Data of Base Unit is listed in following pages.

INTERTEK TESTING SERVICES

**EXHIBIT 5
EQUIPMENT LIST**

INTERTEK TESTING SERVICES

5.0 Equipment List

1) Radiated Emissions Test

Equipment	EMI Test Receiver	Spectrum Analyzer	Biconical Antenna
Registration No.	EW-3156	EW-2249	EW-0571
Manufacturer	R&S	R&S	EMCO
Model No.	ESR26	FSP30	3104C
Calibration Date	Nov. 03, 2015	Nov. 27, 2015	Jun. 23, 2015
Calibration Due Date	Nov. 03, 2016	Nov. 27, 2016	Dec. 23, 2016

Equipment	Log Periodic Antenna	Double Ridged Guide Antenna
Registration No.	EW-0447	EW-1133
Manufacturer	EMCO	EMCO
Model No.	3146	3115
Calibration Date	Mar. 16, 2015	Nov. 05, 2015
Calibration Due Date	Sep. 16, 2016	May 05, 2017

2) RF Conductive Measurement Test

Equipment	RF Power Meter with Power Sensor	Spectrum Analyzer
Registration No.	EW-2270	EW-2249
Manufacturer	AGILENTTECH	R&S
Model No.	N1911A, N1921A(Sensor)	FSP30
Calibration Date	Jan. 19, 2016	Nov. 17, 2015
Calibration Due Date	Jan. 19, 2017	Nov. 27, 2016

END OF TEST REPORT