

Rechargeable 2.4GHz DX-1 MICRO DRONE

GETTING TO KNOW YOUR DRONE

PLEASE READ ALL WARNINGS AND INSTRUCTIONS PRIOR TO USE. KEEP THIS DOCUMENT AS IT CONTAINS IMPORTANT INFORMATION ABOUT YOUR DRONE.



1. CHARGING

- Drone must be charged before each use (USB cable included)
- Indicator light will turn off once fully charged
- Install batteries in remote

2. PAIRING

Before each flight pair the remote with the drone:

1. Turn your drone on and place on a flat, level surface
2. Turn on the remote on and move the left joystick down, then up, then down again
3. The beep will indicate successful pairing

3. DIRECTIONAL LIGHTS

- White lights indicate the front of the drone
- Red lights indicate the back of the drone
- Not applicable in auto-orientation mode

4. REMOTE CONTROL OVERVIEW

Practice flying your drone below 10 feet and at low speeds until comfortable with all controls to avoid unnecessary damage or injury

- **Left joystick:**
 - Up/Down controls elevation
 - Left/Right controls spin
 - **Right joystick:** controls flight direction
 - **Direction Trim:** use to eliminate drift
- To cut power to drone, move left joystick to down position

QUESTIONS OR CONCERNS? PLEASE GIVE US A CALL... WE'RE HERE TO HELP

CUSTOMER SERVICE

(800) 374-2744

Before calling please locate the 10-digit code printed on the back of your remote



Rechargeable 2.4GHz DX-1 MICRO DRONE

INTRODUCTION

Congratulations on your purchase of the Sharper Image Rechargeable 2.4 GHz DX-1 Micro Drone. Get ready to soar to new heights. Master the art of drone flying with remote control maneuverability. This lightweight micro drone will provide hours of fun.

SPECIFICATIONS

Drone Battery: 100 mAh Li-po
Remote Controller Battery: 2 x 1.5V AAA
Charging Time: Approximately 30 minutes
Maximum Recommended Altitude 65 ft.

TABLE OF CONTENTS

General Warnings	Page 1
Contents and Remote Battery Installation	Page 2
Charging LiPo and Drone Storage	Page 3
Blade Guard Installation	Page 4
Remote Control and Drone Overview	Page 5
Operating Drone	Page 6
Modes and Replacing Propellers	Page 7
Troubleshooting and FCC Warning	Page 8

Rechargeable 2.4GHz DX-1 MICRO DRONE

READ ALL WARNINGS AND PRECAUTIONS BEFORE USE

SAFETY WARNINGS:

- Not recommended for children under 12 years of age. As with all electrical products, precaution should be observed during handling and use to reduce the risk of electrical shock.
- Adult supervision is required at all times.
- Before each use, an adult should review the product and battery to determine that no damage or hazards exist.
- **DO NOT TOUCH SPINNING PROPELLERS**
- Do not allow anything to intentionally make contact in any way with spinning propellers.
 - Prevent contact with spinning blades by turning off remote prior to handling drone.
- **Use caution and pay attention to your surroundings while operating drone.**
- **Do not fly drone into animals, people, or inanimate objects.**
- Keep drone away from power lines, buildings, trees, public areas, and any other potentially hazardous areas.
- Do not operate in rain, heavy wind, and/or any type of severe weather.
- Do not land drone on wet surfaces.
- Never touch or allow others to touch drone while it is flying.
- Always turn drone off when it is not in use.
- Always fly drone in large open areas.
- Never fly drones above or near people, sudden changes in wind or other conditions could lead to unexpected crashes.
- Always use caution when flying drone vehicles, obey relevant laws, respect the privacy and property rights of others.
- The drone shall never be modified or used for anything except its intended purpose.

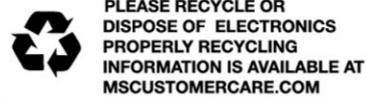

Rechargeable 2.4GHz DX-1 MICRO DRONE

CONTENTS

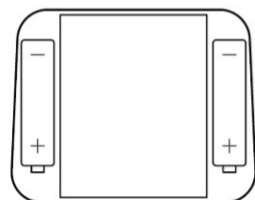
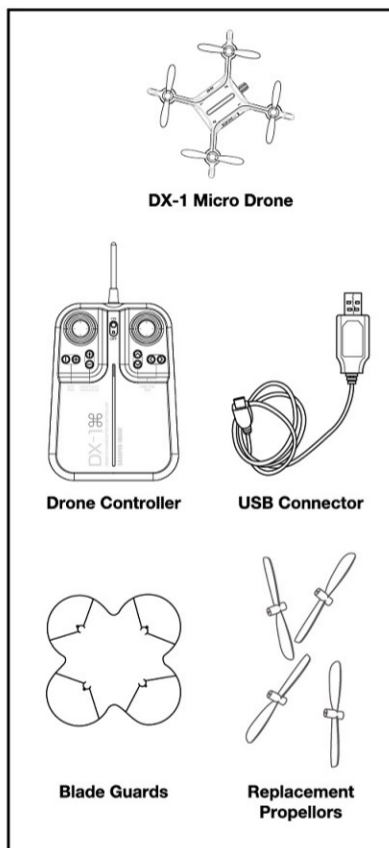

REMOTE BATTERY INFORMATION

1. Slide open battery compartment.
2. Install 2 "AAA" batteries as shown in diagram shown above.
3. Replace and close battery compartment.

LITHIUM-POLYMER BATTERY WARNING

There is a risk of fire and personal injury if Li-Po battery is punctured, damaged or misused.

- Never expose battery to extreme temperatures or moisture.
- Do not subject battery to strong impacts.
- Always keep battery away from flammable materials.
- Only use manufacturer specified battery(ies), charger(s), and/or adapters, if applicable, specified by the manufacturer.
- Battery is not serviceable.
- Let battery cool to room temperature before charging.
- While charging, never leave battery unattended.
- Recycle or dispose of battery according to federal, state and local laws.

KEEP THIS INSTRUCTION MANUAL FOR REFERENCE

BATTERY WARNING

- Do not mix old and new batteries.
- Recycle or dispose of battery according to federal, state and local laws.
- Never use batteries using the correct polarity. Do not short-circuit the supply terminal.
- Only use manufacturer specified battery(ies), charger(s), and/or adapters, if applicable, specified by the manufacturer.
- Always use, replace, and recharge (if applicable) batteries under adult supervision.

KEEP THE PACKAGE FOR REFERENCE AS IT CONTAINS IMPORTANT INFORMATION

Rechargeable 2.4GHz DX-1 MICRO DRONE

CHARGING BATTERY

Note: The Battery Charger will light up when it is charging the battery and turn off when the battery is fully charged. Charge time is approximately 30 minutes.

Turn off the drone before charging.

Carefully connect the Drone to USB charging cord as the connector. Connector is delicate and must be handled with care.

Connect USB connector to power source.

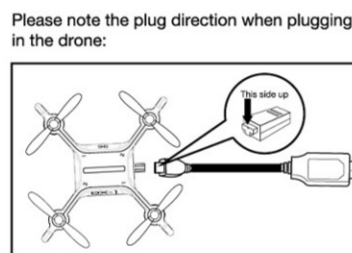

Drone can be charged and stored inside of controller:

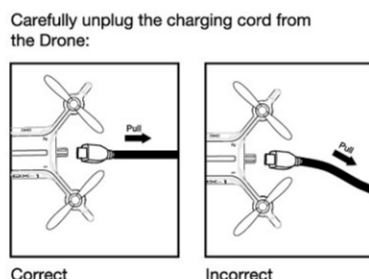
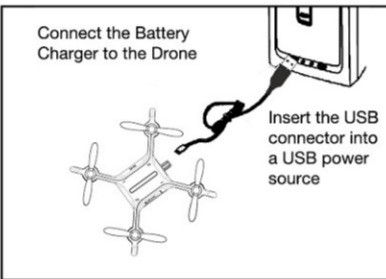
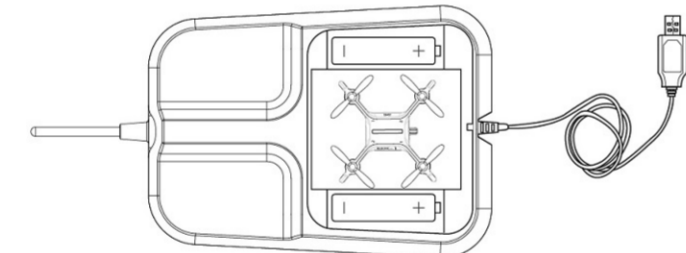

Rechargeable 2.4GHz DX-1 MICRO DRONE

BLADE GUARD INSTALLATION

Blade guards should be installed prior to flying the drone. The blade guards will help protect your drone and bystanders from the spinning propellers. They will protect the propellers if the drone is dropped or has a rough landing. The blade guards will also allow you to see the drone while it is in flight. Please see below on how to properly install the blade guards.

BEFORE INSTALLATION:

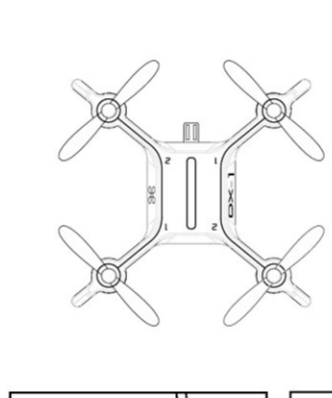

AFTER INSTALLATION:

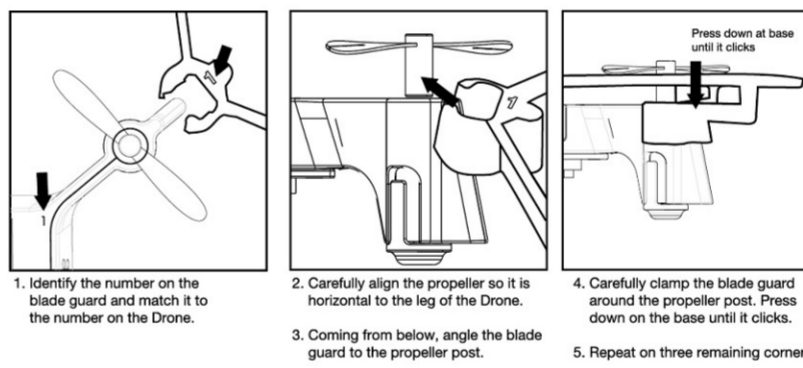
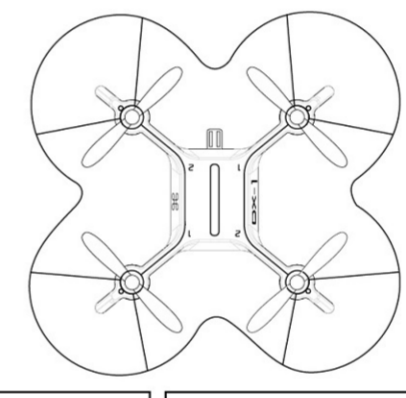

Rechargeable 2.4GHz DX-1 MICRO DRONE

REMOTE CONTROL OVERVIEW

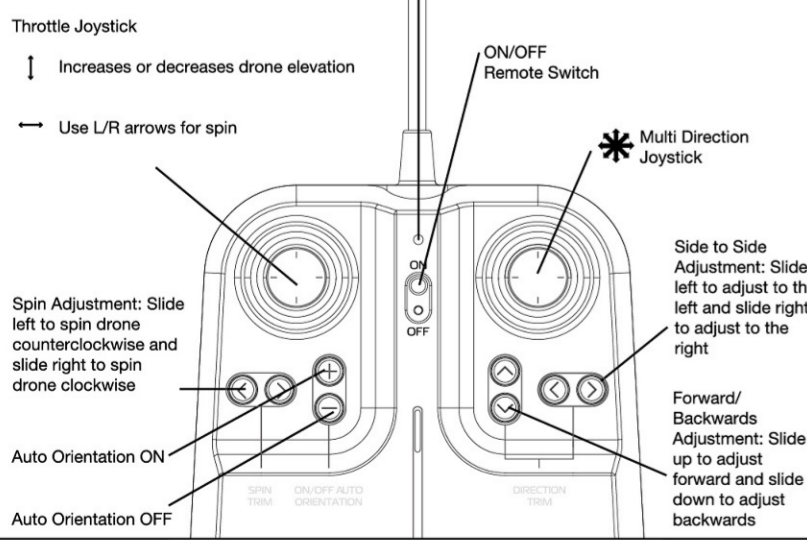

Rechargeable 2.4GHz DX-1 MICRO DRONE

OPERATING DRONE

Step 1 - Pre Flight Checklist

1. Read all warnings and instructions
2. Install remote batteries, page 2
3. Make sure that drone and remote are powered off
4. Install Blade Guards, page 6.
5. Charge batteries, page 3.

Step 2 - Choosing a location

- Drone is designed to be flown indoors only
- Always make sure you have enough space to fly drone
- Always follow warnings, page 1

Step 3 - Starting Drone

1. Making sure your remote is off, slide drone switch to ON. Drone lights will begin to flicker
2. Choose a flat even surface and follow the diagram
3. Turn remote on. Bring the Throttle all the way up then bring it all the way down. Remote will beep and drone lights will flicker rapidly then turn on permanently once paired.
4. Drone is ready for flight.

Step 4 - Lift Off

1. Slowly and carefully bring the throttle up. Propellers will begin to spin and drone will begin to elevate. You can compensate for some of the drones drifting by using the Multi Directional Button or by following step 5. You may need to practice this step several times before successfully getting drone into the air.

Step 5 - Drone Begins to Drift

- Follow this step if your drone begins to drift while take off or during flight
- Drone drifts backwards: Slide the Forward/Backwards Adjustment up
 - Drone drifts forwards: Slide the Forward/Backwards Adjustment down
 - Drone drifts left: Slide the Side to Side Adjustment to the right
 - Drone drifts right: Slide the Side to Side Adjustment to the left
 - Drone spins clockwise (viewing drone from top): Slide the Spin Adjustment to the left
 - Drone spins counter-clockwise (viewing drone from top): Slide the Spin Adjustment to the right.

Always turn off remote prior to retrieving or picking up drone. This will help you avoid accidentally activating propellers.

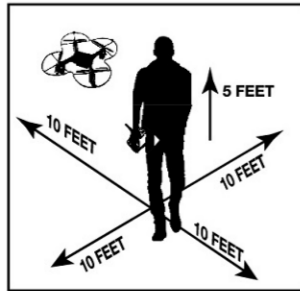

- Step 6 - Operating Drone in Flight**
The drones range is approximately 100 feet
- Read and be aware of all warnings found on page 1.
 - Maintain your desired elevation by using the Throttle
 - Use the Throttle joystick in a circle motion to spin the drone.
 - Use the Multi Directional Joystick to move forwards, backwards, and side to side
 - Review step 5 if your drone begins to drift

Rechargeable 2.4GHz DX-1 MICRO DRONE

MODES

Auto Landing

- Make sure you have achieved level, balanced flight, where the drone is neither climbing nor descending. This mode will activate when the remote loses signal or when remote is turned off or when battery gets too low.
- The ideal auto landing height is 15ft.
- This mode allows you to safely and slowly land your drone without having to control the speed. It is done for you automatically.

Auto Orientation

- Auto Orientation default setting is off. To enter this mode press Auto Orientation "+" button. Remote will beep twice.
- After drone success paired, the 2 white LED lights toward orientation will be the original forward orientation, when drone is in auto orientation mode, whatever the drone spin, the forward orientation will be previous original forward orientation.
- Remote will beep every 6s to indicate the drone is in Auto Orientation mode.
- To exit mode, press the "-" button. Remote will sound 1 long beep indicating that it has exited Auto Orientation mode.

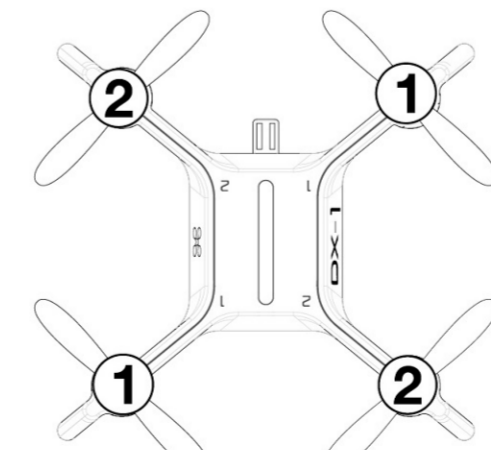

REPLACING PROPELLERS

1. Follow diagram to the right.
2. Make sure you installed the correct blade Each blade has a letter written on it

NOTE: Blade 1 turns counter clockwise and Blade 2 turns clockwise

Rechargeable 2.4GHz DX-1 MICRO DRONE

CUSTOMER SERVICE

(800) 374-2744

- TIPS**
- Do not crash drone into sand or dirt. Drone gears may become clogged
 - When first learning to fly, practice lifting off and hovering
 - Stay several feet from walls and buildings
 - Always Press Throttle all the way down after crashing or when something gets stuck in propellers
 - Never fly drones above or near people, sudden changes in wind or other conditions could lead to unexpected crashes.
 - Always use caution when flying drone vehicles, obey relevant laws, respect the privacy and property rights of others.
 - The drone shall never be modified or used for anything except its intended purpose.

WARNING: Changes or modifications to this unit not expressly approved by the party responsible for compliance could void the user's authority to operate the equipment.

TROUBLESHOOTING:
When remote switch is turned on, the remote light does not illuminate:

- 1) Check that batteries in the remote are installed correctly OR
- 2) Replace with new batteries

During drone flight, if the remote LED is flashing:

- 1) Remote batteries are low; replace them with new batteries.

Drone and remote properly pair, but the drone will not lift-off:

- 1) Drone Li-Po needs charging. Use charging cable to connect the drone to power source.
- 2) Drone Li-Po needs charging. Use charging cable to connect the drone to power source.
- 3) Replace with the proper number replacement blade and try flying again.

After pairing, the drone is unstable:

- 1) Put the left remote control lever to the left bottom and put the right remote control lever to the right bottom at the same time which connected to the drone (diagram to right).
- 2) If the above does not resolve the issue, reboot the drone and controller and pair again.

Remote Controller and Drone can not be paired:

- 1) Check Point: Remote Controller must be closed to Drone, not exceed 4 meters.

Note: If there are 2 sets of Drones within 4 meters for Pairing, you must pair one successfully before pairing the second set.

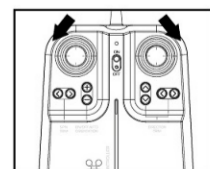

This device complies with Part 15 of the FCC Rules. Operation is subject to the following two conditions: (1) This device may not cause harmful interference, and (2) this device must accept any interference received, including interference that may cause undesired operation.

NOTE: This equipment has been tested and found to comply with the limits for a Class B digital device, pursuant to Part 15 of the FCC Rules. These limits are designed to provide reasonable protection against harmful interference in a residential installation. This equipment generates, uses and can radiate radio frequency energy and, if not installed and used in accordance with the instructions, may cause harmful interference to radio communications. However, there is no guarantee that interference will not occur in a particular installation.

If this equipment does cause harmful interference to radio or television reception, which can be determined by turning the equipment off and on, the user is encouraged to try to correct the interference by one or more of the following measures:

- Reorient or relocate the receiving antenna.
- Increase the separation between the equipment and receiver.
- Connect the equipment into an outlet on a circuit different from that to which the receiver is connected.
- Consult the dealer or an experienced radio/TV technician for help.

© Sharper Image. All Rights Reserved.
SHARPER IMAGE name and logo are registered trademarks manufactured and marketed by MarchSource, LLC under license. All other logos and trademarks are proprietary to their respective owners. The artwork and design of this package are protected by US copyright law and may not be reproduced, distributed, displayed, published or used for any purpose without prior written permission. Altering, removing or reproducing any of the trademarks or copyright notices on this package is not permitted.

©2016 MarchSource, LLC. All rights reserved.
Distributed by MarchSource, LLC, Irvine, CA 92618.

PATENT PENDING
Printed in China