

FCC TEST REPORT
for
Shenzhen Anbash Technology Co., Ltd.

Network Camera
Model No.: NC613W, NC623W, NC633W, NC633SW, BABEN300,
BABEN5HD, BABEN6HD, BABEN7HD, BABEN5EX, BABEN7EX

Prepared for : Shenzhen Anbash Technology Co., Ltd.
Address : Area B, 4/FL, Block G, Heng Chang Rong Xinghui Technology
Park, West Hua Ning Road, Da Lang Community, Bao An
District, Shenzhen, 518109, China

Prepared By : Shenzhen Anbotek Compliance Laboratory Limited
Address : 1/F., Building 1, SEC Industrial Park, No.0409 Qianhai Road,
Nanshan District, Shenzhen, Guangdong, China
Tel: (86) 755-26066544
Fax: (86) 755-26014772

Report Number : R011607616I
Date of Test : Jul. 18~ Sept. 20, 2016
Date of Report : Sept. 21, 2016

TABLE OF CONTENT

Description

Page

Test Report

1. GENERAL INFORMATION.....	4
1.1. Description of Device (EUT).....	4
1.2. Auxiliary Equipment Used during Test.....	5
1.3. Description of Test Facility.....	6
1.4. Measurement Uncertainty.....	6
2. TEST METHODOLOGY.....	7
2.1. Summary of Test Results.....	7
2.2. Description of Test Modes.....	7
2.3. List of channels:.....	8
3. CONDUCTED EMISSION TEST.....	9
3.1. Block Diagram of Test Setup.....	9
3.2. Power Line Conducted Emission Measurement Limits (15.207).....	9
3.3. Configuration of EUT on Measurement.....	9
3.4. Operating Condition of EUT.....	9
3.5. Test Procedure.....	10
3.6. Test equipment.....	10
3.7. Power Line Conducted Emission Measurement Results.....	10
4. FCC PART 15.247 REQUIREMENTS FOR DSSS & OFDM MODULATION.....	15
4.1 Test Setup.....	15
4.2 6dB Bandwidth.....	15
4.3. Maximum Output Power Test.....	23
4.4. Band Edges Measurement.....	27
4.5. Peak Power Spectral Density.....	63
4.6. Radiated Emissions.....	67
5. ANTENNA APPLICATION.....	78
5.1. Antenna requirement.....	78
5.2. Result.....	78
6. PHOTOGRAPH.....	79
6.1. Photo of Conducted Emission Measurement.....	79
6.2. Photo of Radiation Emission Test.....	79
APPENDIX I (EXTERNAL PHOTOS).....	81
APPENDIX II (INTERNAL PHOTOS).....	85

TEST REPORT

Applicant : Shenzhen Anbash Technology Co., Ltd.
Manufacturer : Shenzhen Anbash Technology Co., Ltd.
EUT : Network Camera
Model No. : NC613W, NC623W, NC633W, NC633SW, BABEN300,
BABEN5HD, BABEN6HD, BABEN7HD, BABEN5EX, BABEN7EX
Serial No. : N.A.
Trade Mark : Anbash
Rating : DC 12V, 1000mA

Measurement Procedure Used:
FCC Part15 Subpart C 2015, Paragraph 15.247

The device described above is tested by Shenzhen Anbotek Compliance Laboratory Limited to determine the maximum emission levels emanating from the device and the severe levels of the device can endure and its performance criterion. The measurement results are contained in this test report and Shenzhen Anbotek Compliance Laboratory Limited is assumed full of responsibility for the accuracy and completeness of these measurements. Also, this report shows that the EUT (Equipment Under Test) is technically compliant with the FCC Part 15 Subpart C requirements.

This report applies to above tested sample only and shall not be reproduced in part without written approval of Shenzhen Anbotek Compliance Laboratory Limited.

Date of Test : Jul. 18~ Sept. 20, 2016

Prepared by : *Baron Wen*
(Tested Engineer / Baron Wen)

Reviewer : *Amy Ding*
(Project Manager / Amy Ding)

Approved & Authorized Signer : *Tom Chen*
(Manager / Tom Chen)

1. GENERAL INFORMATION

1.1. Description of Device (EUT)

EUT	: Network Camera
Model Number	: NC613W, NC623W, NC633W, NC633SW, BABEN300, BABEN5HD, BABEN6HD, BABEN7HD, BABEN5EX, BABEN7EX (Note: All samples are the same except the model number and colour, so we prepare “NC613W” for test only.)
Test Power Supply	: AC 120V, 60Hz for adapter/ AC 240V, 60Hz for adapter
Adapter	: Model No.: FJ-SW1261201000DU Input: AC 100-240V, 50/60Hz, 0.4A Max Output: DC 12V, 1000mA
RF Transmission Frequency	: 2412MHz~2462MHz (802.11b/802.11g/802.11n(HT20)) 2422MHz~2452MHz (802.11n(HT40))
Channels	: 11 For (802.11b/802.11g/802.11n(HT20)) 7 For (802.11n(HT40))
Modulation	: 802.11b CCK; 802.11g OFDM; 802.11n MCS
Antenna Gain:	: 5dBi
Applicant Address	: Shenzhen Anbash Technology Co., Ltd. Area B, 4/FL, Block G, Heng Chang Rong Xinghui Technology Park, West Hua Ning Road, Da Lang Community, Bao An District, Shenzhen, 518109, China
Manufacturer Address	: Shenzhen Anbash Technology Co., Ltd. Area B, 4/FL, Block G, Heng Chang Rong Xinghui Technology Park, West Hua Ning Road, Da Lang Community, Bao An District, Shenzhen, 518109, China
Factory Address	: Shenzhen Anbash Technology Co., Ltd. Area B, 4/FL, Block G, Heng Chang Rong Xinghui Technology Park, West Hua Ning Road, Da Lang Community, Bao An District, Shenzhen, 518109, China
Date of receipt	: Jul. 18, 2016
Date of Test	: Jul. 18~ Sept. 20, 2016

1.2. Auxiliary Equipment Used during Test

PC	: Manufacturer: DELL M/N: Optiplex 3020 MT S/N: CN-079V51-70163-4AD-089K-A00 Input Rating: AC 100-240V, 50-60Hz 5.4A CE , FCC DOC, CCC
MONITOR	: Manufacturer: DELL M/N: UZ2215Hf S/N: CN-035VN6-72872-45A-A3AB Input Rating: AC 100-240V, 50-60Hz, 1.5A Output Rating: DC 19.5V, 4.62A TUV-GS FCC CE KCC VCCI
KEYBOARD	: Manufacturer: DELL M/N: SK-8120 S/N: CN-0DJ365-71616-49J-0MVR-A00 Input Rating: DC 5V,0.05A CE FCC VCCI KCC TUV-GS Cable: 1.8m, unshielded
MOUSE	: Manufacturer: DELL M/N: MS111-T S/N: CN-0KW2YH-71616-488-1CBJ Input Rating: DC 5V,0.1A Cable: 1.8m, unshielded CE FCC VCCI KCC TUV-GS
Printer	: Manufacturer:Brother M/N: MFC-3360C S/N: N/A CE, FCC:DOC
Power Line	: Non-Shielded, 1.5m
VGA Cable	: Non-Shielded, 1.5m

1.3. Description of Test Facility

The test facility is recognized, certified, or accredited by the following organizations:

FCC-Registration No.: 752021

Shenzhen Anbotek Compliance Laboratory Limited, EMC Laboratory has been registered and fully described in a report filed with the (FCC) Federal Communications Commission. The acceptance letter from the FCC is maintained in our files. Registration 752021, July 06, 2016.

IC-Registration No.: 8058A-1

Shenzhen Anbotek Compliance Laboratory Limited., EMC Laboratory has been registered and fully described in a report filed with the (IC) Industry Canada. The acceptance letter from the IC is maintained in our files. Registration 8058A, Jun. 13, 2016.

Test Location

All Emissions tests were performed at Shenzhen Anbotek Compliance Laboratory Limited. at 1/F., Building 1, SEC Industrial Park, No.0409 Qianhai Road, Nanshan District, Shenzhen, Guangdong, China

1.4. Measurement Uncertainty

Radiation Uncertainty : Ur = 4.1 dB (Horizontal)
Ur = 4.3 dB (Vertical)

Conduction Uncertainty : Uc = 3.4dB

2. TEST METHODOLOGY

The tests documented in this report were performed in accordance with ANSI C63.10: 2013 and FCC Part 15, Paragraph 15.247.

2.1. Summary of Test Results

The EUT has been tested according to the following specifications:

Standard	Test Type	Result	Notes
FCC Part 15, Paragraph 15.107, 15.207	Conducted Emission Test	PASS	Complies
FCC Part 15, Paragraph 15.247(b)(1)	Maximum Output Power	PASS	Complies
FCC Part 15, Paragraph 15.247(a)(2)	6dB Bandwidth	PASS	Complies
FCC Part 15, Paragraph 15.247(c)	100kHz Bandwidth of Frequency Band Edges	PASS	Complies
FCC Part 15, Paragraph 15.209(a)(f)	Spurious Emission	PASS	Complies
FCC Part 15, Paragraph 15.247(a)(1)	Frequency Separation	-	N/A
FCC Part 15, Paragraph 15.247(a)(1)(iii)	Number of Hopping Frequency	-	N/A
FCC Part 15, Paragraph 15.247(a)(1)(iii)	Time of Occupancy	-	N/A
FCC Part 15, Paragraph 15.247(c)	Peak Power Density	PASS	Complies

2.2. Description of Test Modes

The EUT has been tested under operating condition.

Software used to control the EUT for staying in continuous transmitting and receiving mode is programmed.

IEEE802.11b: Channel 1(2412MHz), Channel 6(2437MHz) and Channel 11(2462MHz) with 1 Mbps lowest data rate (worst case) are chosen for the final testing.

IEEE802.11g: Channel 1(2412MHz), Channel 6(2437MHz) and Channel 11(2462MHz) with 6 Mbps lowest data rate (the worst case) are chosen for the final testing.

IEEE802.11n (HT20): Channel 1(2412MHz), Channel 6(2437MHz) and Channel 11(2462MHz) with MCS 0 Mbps lowest data rate (the worst case) are chosen for the final testing.

IEEE802.11n (HT40): Channel 3(2422MHz), Channel 6(2437MHz) and Channel 9(2452MHz) with MCS 0 Mbps lowest data rate (the worst case) are chosen for the final testing.

2.3. List of channels:

√ - available

X - tested

Number	Frequency(MHz)		802.11 b/g/n (HT20)	802.11 b/g/n (HT40)
1	2412	√	X	
2	2417	√		
3	2422	√		X
4	2427	√		
5	2432	√		
6	2437	√	X	X
7	2442	√		
8	2447	√		
9	2452	√		X
10	2457	√		
11	2462	√	X	

3. Conducted Emission Test

3.1. Block Diagram of Test Setup

3.1.1. Block diagram of connection between the EUT and simulators

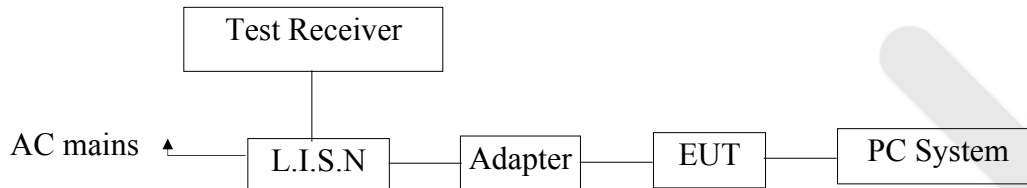

3.2. Power Line Conducted Emission Measurement Limits (15.207)

Frequency MHz	Limits dB(μV)	
	Quasi-peak Level	Average Level
0.15 ~ 0.50	66 ~ 56*	56 ~ 46*
0.50 ~ 5.00	56	46
5.00 ~ 30.00	60	50

- Notes: 1. *Decreasing linearly with logarithm of frequency.
2. The lower limit shall apply at the transition frequencies.

3.3. Configuration of EUT on Measurement

The following equipments are installed on Power Line Conducted Emission Measurement to meet the commission requirement and operating regulations in a manner which tends to maximize its emission characteristics in a normal application.

3.4. Operating Condition of EUT

- 3.4.1. Setup the EUT and simulator as shown as Section 3.1.
- 3.4.2. Turn on the power of all equipment.
- 3.4.3. Let the EUT work in test mode (Internet Mode) and measure it.

3.5. Test Procedure

The EUT system is connected to the power mains through a line impedance stabilization network (L.I.S.N.). This provides a 50ohm coupling impedance for the EUT system. Please refer the block diagram of the test setup and photographs. Both sides of AC line are checked to find out the maximum conducted emission. In order to find the maximum emission levels, the relative positions of equipment and all of the interface cables shall be changed according to FCC ANSI C63.10-2013 on Conducted Emission Measurement.

The bandwidth of test receiver (ESCI) set at 9KHz.

The frequency range from 150KHz to 30MHz is checked.

The test results are reported on Section 3.6.

3.6. Test equipment

Item	Equipment	Manufacturer	Model No.	Serial No.	Last Cal.	Cal. Interval
1.	Two-Line V-network	Rohde & Schwarz	ENV216	100055	Apr. 16, 2016	1 Year
2.	EMI Test Receiver	Rohde & Schwarz	ESCI	100627	Apr. 16, 2016	1 Year
3.	RF Switching Unit	Compliance Direction	RSU-M2	38303	Apr. 16, 2016	1 Year

3.7. Power Line Conducted Emission Measurement Results

PASS.

The frequency range from 150KHz to 30 MHz is investigated.

Please refer the following pages.

CONDUCTED EMISSION TEST DATA

Test Site: 1# Shielded Room
 Operating Condition: Internet Mode
 Test Specification: AC 120V, 60Hz for adapter
 Comment: Live Line
 Tem.:25°C Hum.:50%

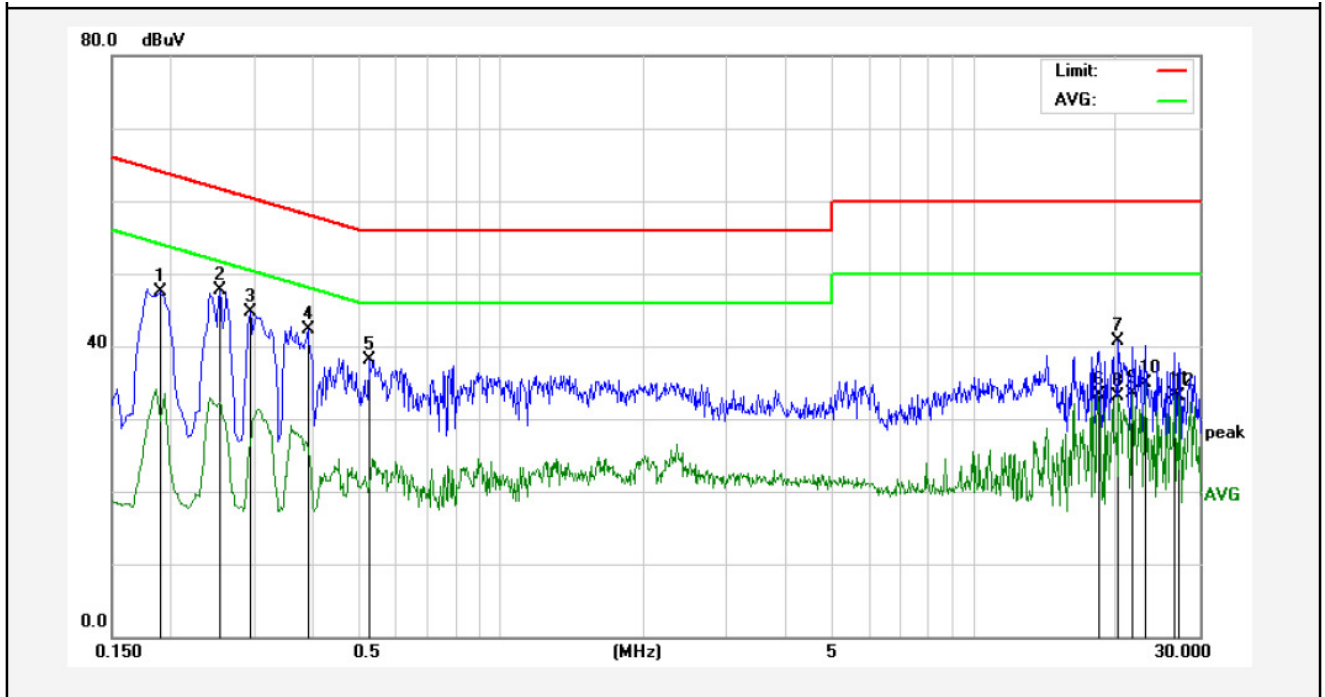

No.	Freq. (MHz)	Reading (dBuV)	Factor (dB)	Result (dBuV)	Limit dBuV	Over Limit (dB)	Detector	Remark
1	0.1900	27.47	20.00	47.47	64.03	-16.56	QP	
2	0.2540	27.78	20.00	47.78	61.62	-13.84	QP	
3	0.2940	24.74	20.00	44.74	60.41	-15.67	QP	
4	0.3899	22.33	20.00	42.33	58.06	-15.73	QP	
5	0.5260	18.07	20.00	38.07	56.00	-17.93	QP	
6	18.2420	13.28	20.00	33.28	50.00	-16.72	AVG	
7	20.2580	20.64	20.00	40.64	60.00	-19.36	QP	
8	20.2580	13.08	20.00	33.08	50.00	-16.92	AVG	
9	21.6620	13.59	20.00	33.59	50.00	-16.41	AVG	
10	23.1299	14.82	20.00	34.82	50.00	-15.18	AVG	
11	26.6100	13.29	20.00	33.29	50.00	-16.71	AVG	
12	27.1580	13.07	20.00	33.07	50.00	-16.93	AVG	

CONDUCTED EMISSION TEST DATA

Test Site:	1# Shielded Room
Operating Condition:	Internet Mode
Test Specification:	AC 120V, 60Hz for adapter
Comment:	Neutral Line
	Tem.:25°C Hum.:50%

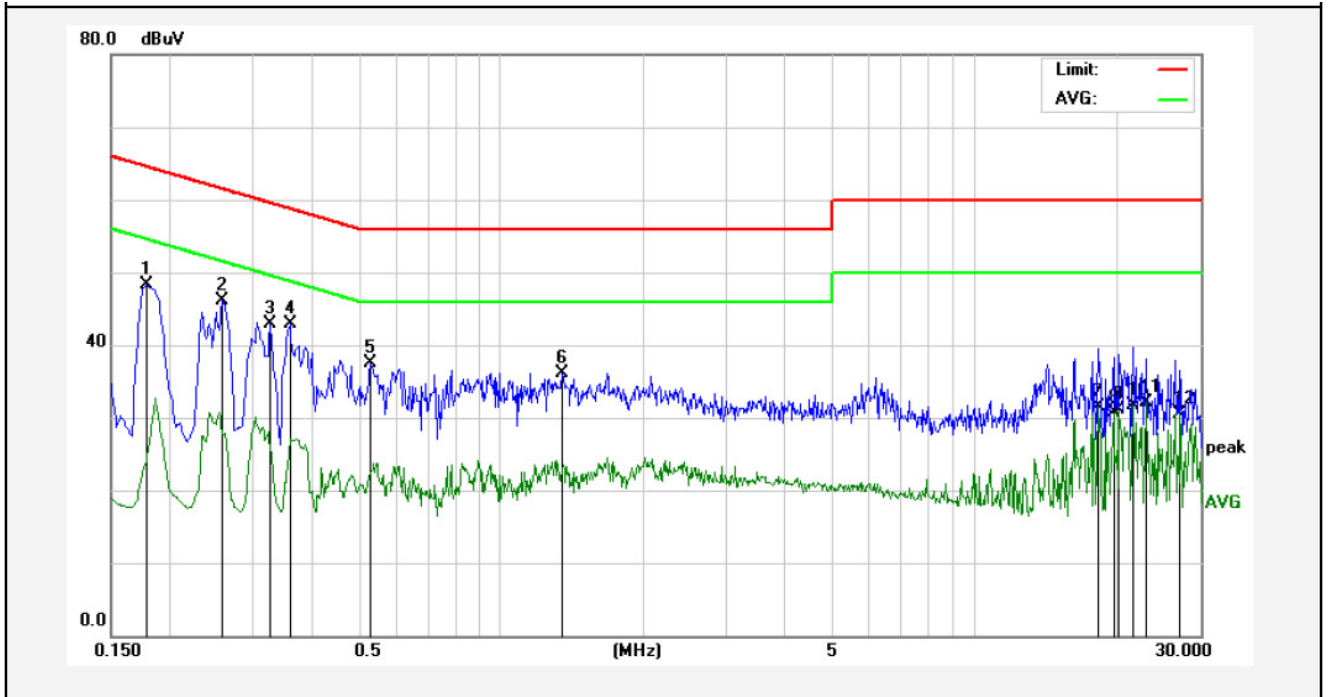

No.	Freq. (MHz)	Reading (dBuV)	Factor (dB)	Result (dBuV)	Limit dBuV	Over Limit (dB)	Detector	Remark
1	0.1780	28.36	20.00	48.36	64.57	-16.21	QP	
2	0.2580	26.10	20.00	46.10	61.49	-15.39	QP	
3	0.3260	22.83	20.00	42.83	59.55	-16.72	QP	
4	0.3580	22.96	20.00	42.96	58.77	-15.81	QP	
5	0.5299	17.50	20.00	37.50	56.00	-18.50	QP	
6	1.3460	16.19	20.00	36.19	56.00	-19.81	QP	
7	18.2420	11.43	20.00	31.43	50.00	-18.57	AVG	
8	19.7099	10.80	20.00	30.80	50.00	-19.20	AVG	
9	20.2580	11.17	20.00	31.17	50.00	-18.83	AVG	
10	21.6620	11.73	20.00	31.73	50.00	-18.27	AVG	
11	23.1299	12.05	20.00	32.05	50.00	-17.95	AVG	
12	27.1580	10.50	20.00	30.50	50.00	-19.50	AVG	

CONDUCTED EMISSION TEST DATA

Test Site: 1# Shielded Room
 Operating Condition: Internet Mode
 Test Specification: AC 240V, 60Hz for adapter
 Comment: Live Line
 Tem.:25°C Hum.:50%

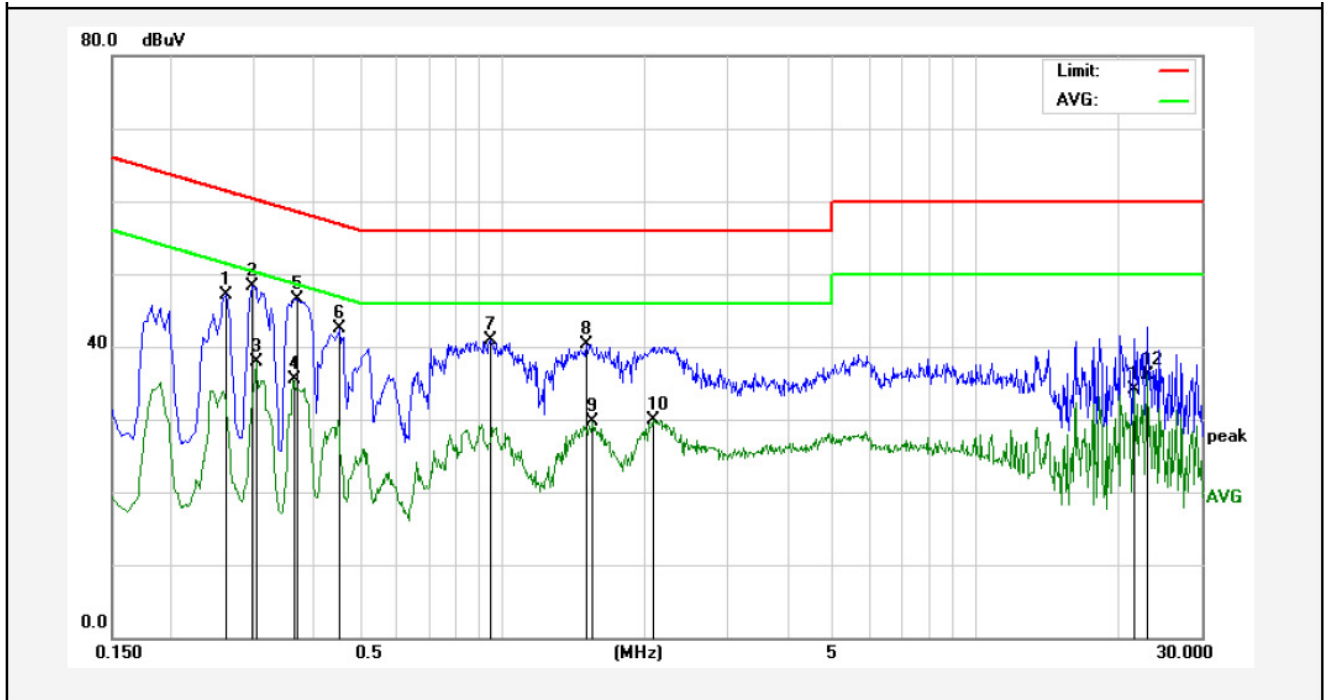

No.	Freq. (MHz)	Reading (dBuV)	Factor (dB)	Result (dBuV)	Limit dBuV	Over Limit (dB)	Detector	Remark
1	0.2620	27.20	20.00	47.20	61.36	-14.16	QP	
2	0.2980	28.24	20.00	48.24	60.30	-12.06	QP	
3	0.3020	17.94	20.00	37.94	50.19	-12.25	AVG	
4	0.3620	15.52	20.00	35.52	48.68	-13.16	AVG	
5	0.3700	26.59	20.00	46.59	58.50	-11.91	QP	
6	0.4540	22.45	20.00	42.45	56.80	-14.35	QP	
7	0.9460	20.82	20.00	40.82	56.00	-15.18	QP	
8	1.5060	20.32	20.00	40.32	56.00	-15.68	QP	
9	1.5540	9.77	20.00	29.77	46.00	-16.23	AVG	
10	2.0820	9.96	20.00	29.96	46.00	-16.04	AVG	
11	21.6620	14.08	20.00	34.08	50.00	-15.92	AVG	
12	23.1259	16.03	20.00	36.03	50.00	-13.97	AVG	

CONDUCTED EMISSION TEST DATA

Test Site: 1# Shielded Room
 Operating Condition: Internet Mode
 Test Specification: AC 240V, 60Hz for adapter
 Comment: Neutral Line
 Tem.:25°C Hum.:50%

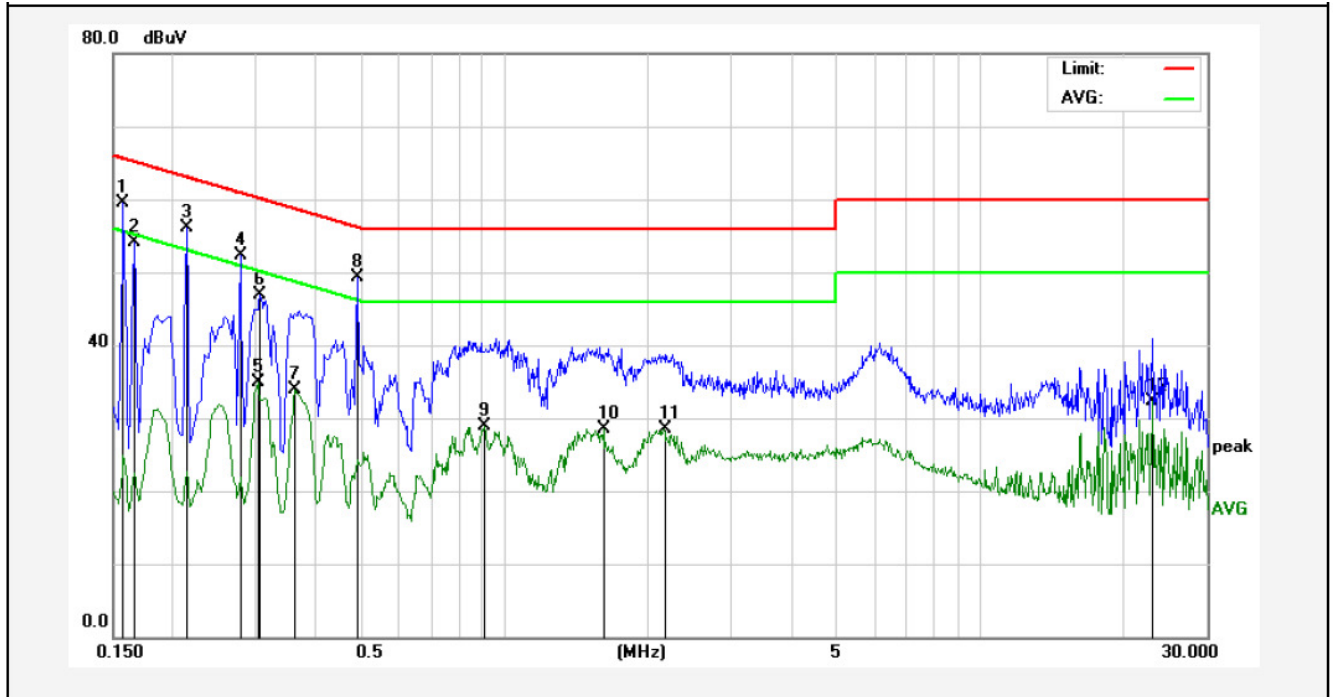

No.	Freq. (MHz)	Reading (dBuV)	Factor (dB)	Result (dBuV)	Limit dBuV	Over Limit (dB)	Detector	Remark
1	0.1580	39.55	20.00	59.55	65.56	-6.01	QP	
2	0.1660	34.07	20.00	54.07	65.15	-11.08	QP	
3	0.2140	36.07	20.00	56.07	63.04	-6.97	QP	
4	0.2779	32.36	20.00	52.36	60.88	-8.52	QP	
5	0.3020	14.82	20.00	34.82	50.19	-15.37	AVG	
6	0.3060	26.97	20.00	46.97	60.08	-13.11	QP	
7	0.3620	13.87	20.00	33.87	48.68	-14.81	AVG	
8	0.4900	29.37	20.00	49.37	56.17	-6.80	QP	
9	0.9060	8.81	20.00	28.81	46.00	-17.19	AVG	
10	1.6140	8.52	20.00	28.52	46.00	-17.48	AVG	
11	2.1660	8.46	20.00	28.46	46.00	-17.54	AVG	
12	23.1259	12.23	20.00	32.23	50.00	-17.77	AVG	

4. FCC Part 15.247 Requirements for DSSS & OFDM Modulation

4.1 Test Setup

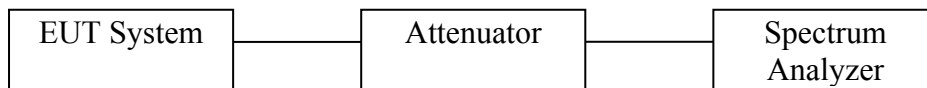

4.2 6dB Bandwidth

a. Limit

For the direct sequence systems, the minimum 6dB bandwidth shall be at least 500kHz.

b. Test Procedure

1. Place the EUT on the table and set it in the transmitting mode.
2. Remove the antenna from the EUT and then connect a low loss RF cable from the antenna port to the spectrum analyzer.
3. Set the spectrum analyzer as:
RBW = 100kHz, VBW $\geq 3 \times$ RBW = 300kHz,
Detector = Peak
Trace mode = Max hold.
Sweep - auto couple.
4. Mark the peak frequency and -6dB (upper and lower) frequency.
5. Repeat until all the rest channels are investigated.

20dB Bandwidth:

C63.10

Occupied Bandwidth (OBW=20dB Bandwidth)

1. Set RBW = 1% ~ 5% OBW
2. Set the VBW $\geq 3 \times$ RBW
3. Set the span range between 2 times and 5 times of the OBW
4. Sweep Time = Auto
Detector = Peak
Trace = Max hold
5. Once the reference level is established, the equipment is conditioned with typical modulating signals to produce the worst case (i.e. the widest) bandwidth. Unless otherwise specified for an unlicensed wireless device, measure the bandwidth at the -20dB levels with respect to the reference level.

c. Test Setup See 4.1

d. Test Equipment

Item	Equipment	Manufacturer	Model No.	Serial No.	Last Cal.	Cal. Interval
1.	Spectrum Analysis	Agilent	E4407B	US39390582	Apr. 16, 2016	1 Year
2.	Preamplifier	Instruments corporation	EMC011830	980100	Apr. 16, 2016	1 Year
3.	EMI Test Receiver	Rohde & Schwarz	ESPI	101604	Apr. 16, 2016	1 Year
4.	Double Ridged Horn Antenna	Instruments corporation	GTH-0118	351600	Apr. 19, 2016	1 Year
5.	Bilog Broadband Antenna	Schwarzbeck	VULB9163	VULB 9163-289	Apr. 19, 2016	1 Year
6.	Pre-amplifier	SONOMA	310N	186860	Apr. 16, 2016	1 Year
7.	EMI Test Software EZ-EMC	SHURPLE	N/A	N/A	N/A	N/A
8	Power Sensor	DAER	RPR3006W	15I00041SN046	Jun 30, 2016	1 Year
9	MXA Spectrum Analysis	Agilent	N9020A	MY51170037	Jun 30, 2016	1 Year
10	MXG RF Vector Signal Generator	Agilent	N5182A	MY48180656	Jun 30, 2016	1 Year
11	Signal Generator	Agilent	E4421B	MY41000743	Jun 30, 2016	1 Year
12	DC Power supply	IV	IV-8080	YQSB0096	Jun 30, 2016	1 Year
13	TEMP&HUMI PROGRAMMABLE CHAMBER	Bell Group	BE-THK-150M8	SE-0137	Mar. 16, 2016	1 Year

e. Test Results

Pass.

f. Test Data
6dB Bandwidth

Test mode: IEEE 802.11b

Channel	Frequency (MHz)	Bandwidth (MHz)	Limit (kHz)	Results
Low	2412	10.03		Pass
Mid	2437	10.02	>500	Pass
High	2462	10.02		Pass

Test mode: IEEE 802.11g

Channel	Frequency (MHz)	Bandwidth (MHz)	Limit (kHz)	Results
Low	2412	16.57		Pass
Mid	2437	16.57	>500	Pass
High	2462	16.57		Pass

Test mode: IEEE 802.11n (HT20)

Channel	Frequency (MHz)	Bandwidth (MHz)	Limit (kHz)	Results
Low	2412	16.56		Pass
Mid	2437	16.57	>500	Pass
High	2462	16.56		Pass

Test mode: IEEE 802.11n (HT40)

Channel	Frequency (MHz)	Bandwidth (MHz)	Limit (kHz)	Results
Low	2422	36.54		Pass
Mid	2437	36.56	>500	Pass
High	2452	36.54		Pass

Test Plots See the following page.

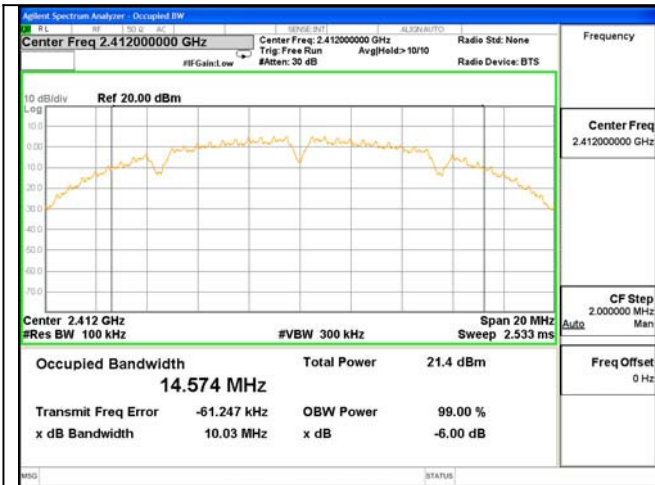

Test Mode: 802.11b---Low

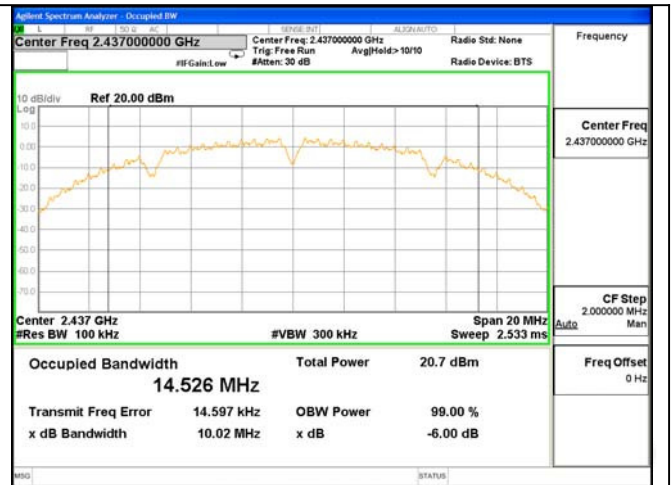

Test Mode: 802.11b---Mid

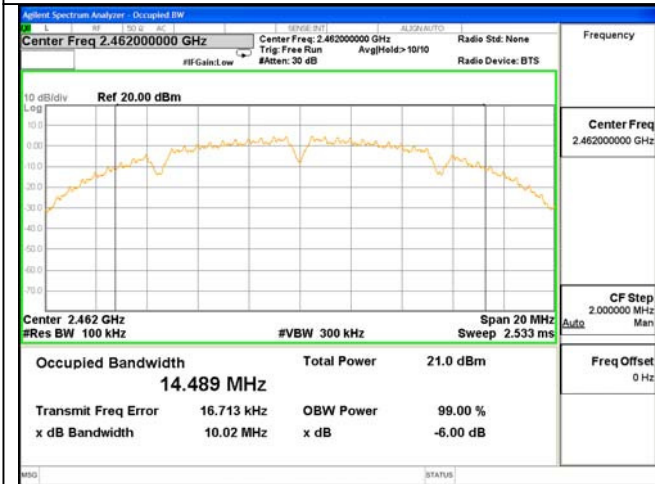

Test Mode: 802.11b---High

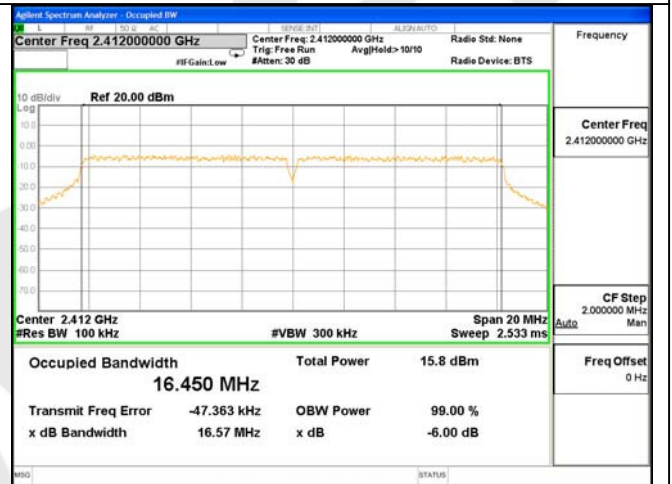

Test Mode: 802.11g---Low

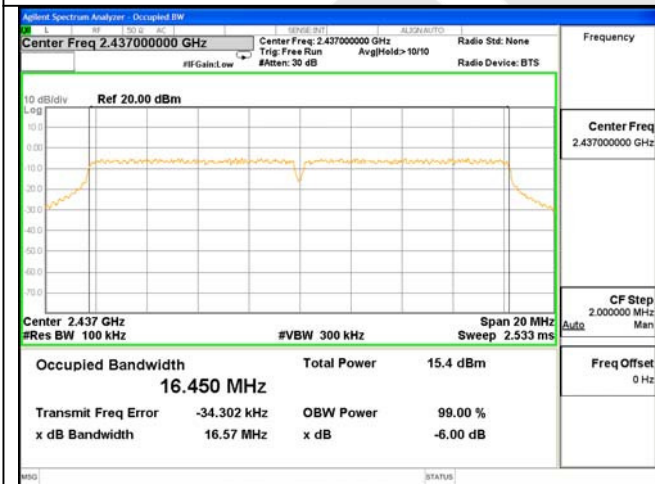

Test Mode: 802.11g---Mid

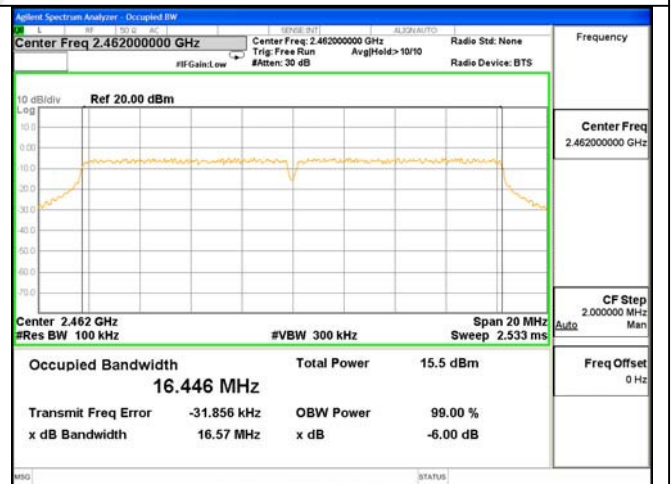

Test Mode: 802.11g---High

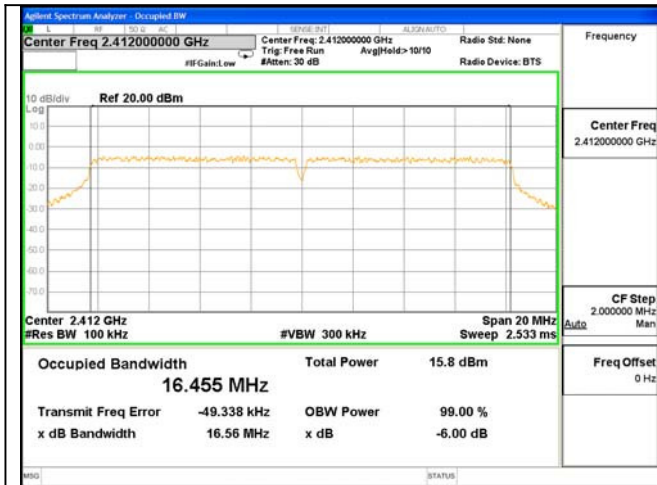

Test Mode: 802.11n20---Low

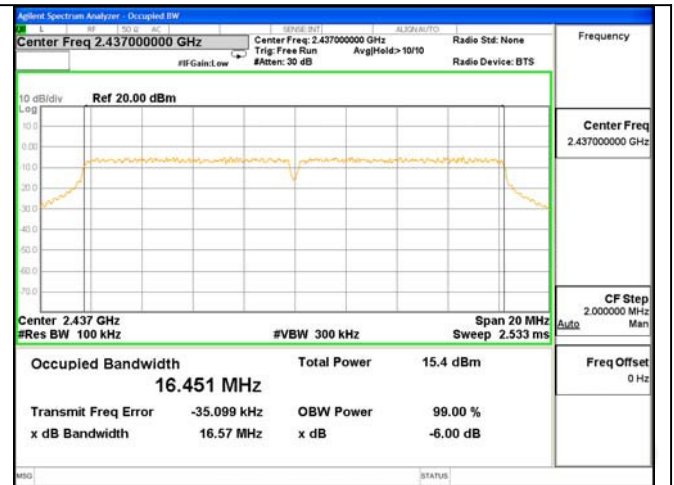

Test Mode: 802.11n20---Mid

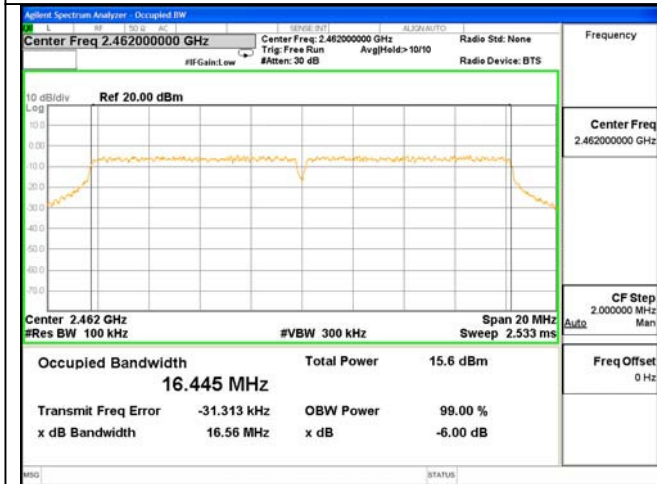

Test Mode: 802.11n20---High

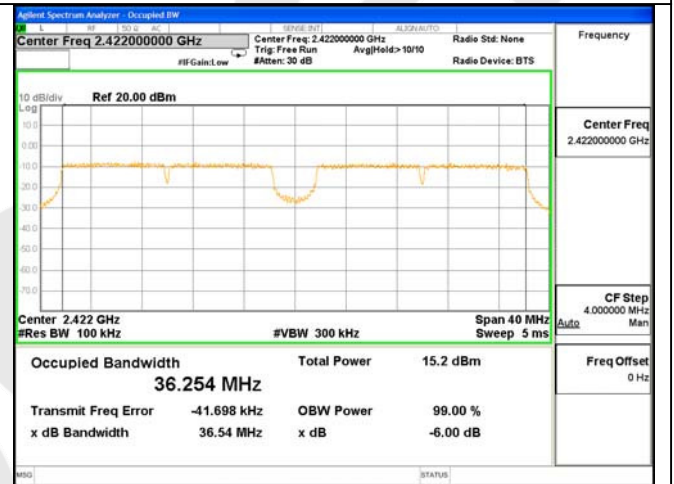

Test Mode: 802.11n40---Low

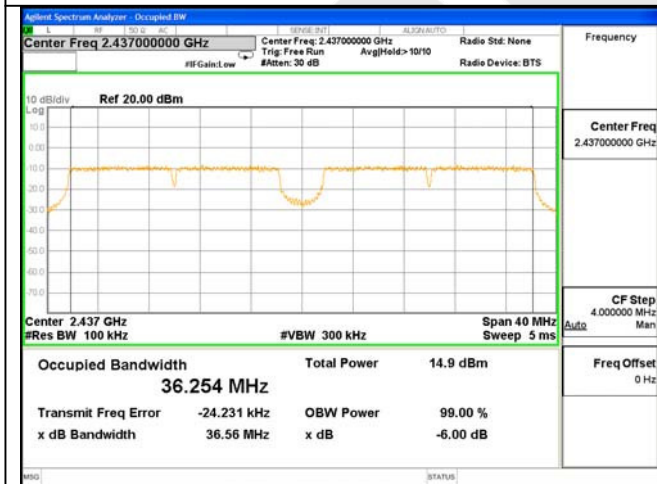

Test Mode: 802.11n40---Mid

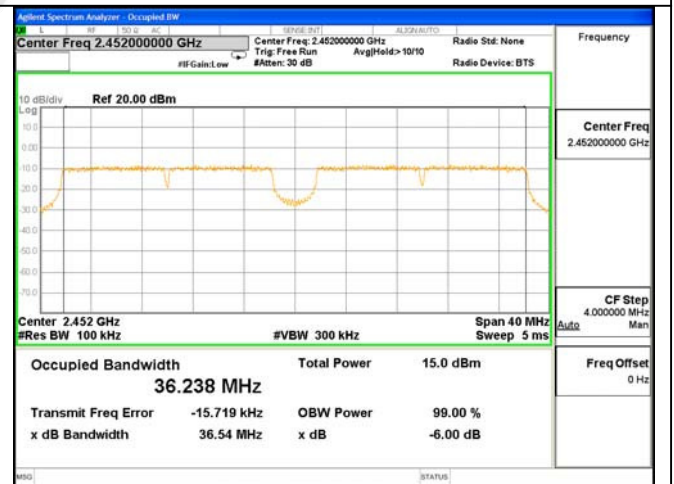

Test Mode: 802.11n40---High

20dB Bandwidth

Test mode: IEEE 802.11b

Channel	Frequency (MHz)	Bandwidth (MHz)	Results
Low	2412	16.70	Pass
Mid	2437	16.70	Pass
High	2462	16.34	Pass

Test mode: IEEE 802.11g

Channel	Frequency (MHz)	Bandwidth (MHz)	Results
Low	2412	19.20	Pass
Mid	2437	19.29	Pass
High	2462	19.09	Pass

Test mode: IEEE 802.11n (HT20)

Channel	Frequency (MHz)	Bandwidth (MHz)	Results
Low	2412	19.06	Pass
Mid	2437	19.22	Pass
High	2462	19.11	Pass

Test mode: IEEE 802.11n (HT40)

Channel	Frequency (MHz)	Bandwidth (MHz)	Results
Low	2422	43.40	Pass
Mid	2437	43.44	Pass
High	2452	42.80	Pass

Test Plots See the following page.

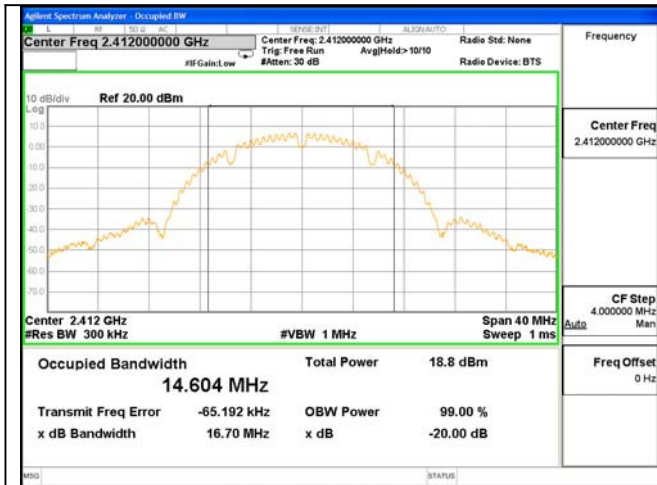

Test Mode: 802.11b---Low

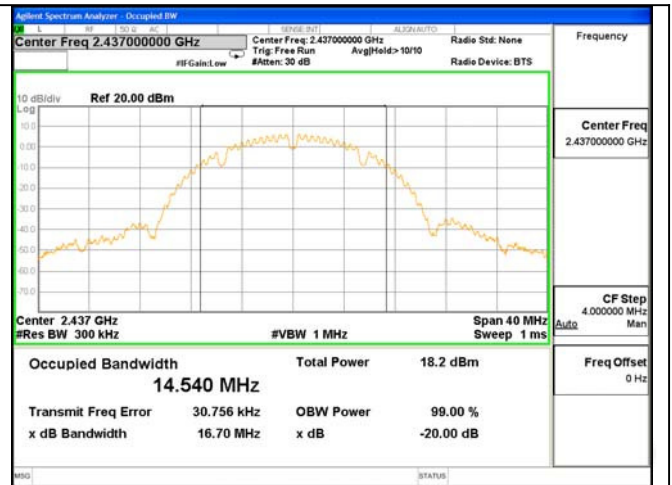

Test Mode: 802.11b---Mid

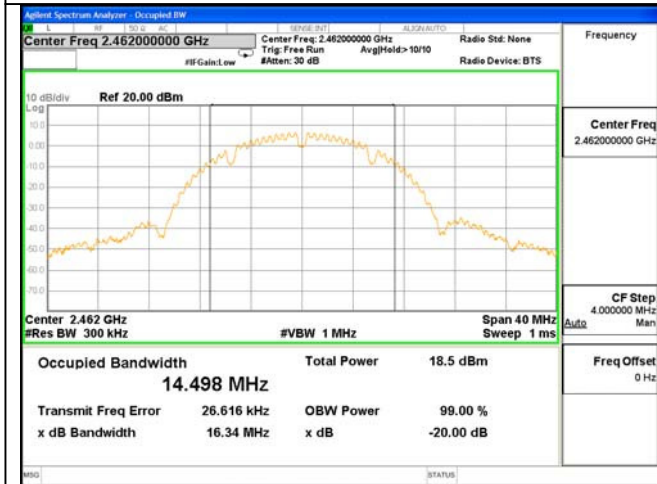

Test Mode: 802.11b---High

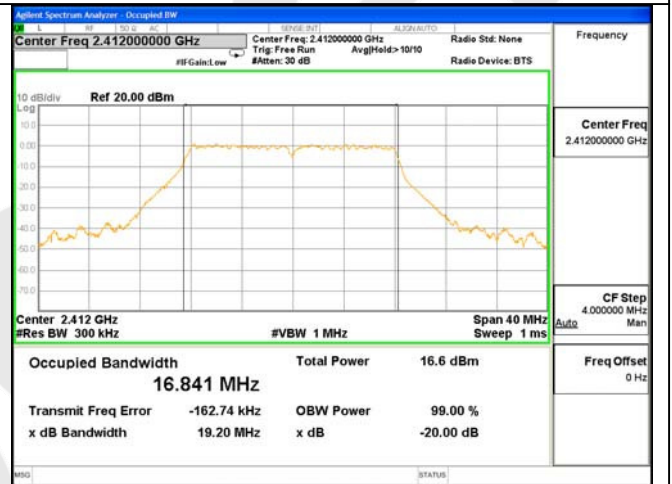

Test Mode: 802.11g---Low

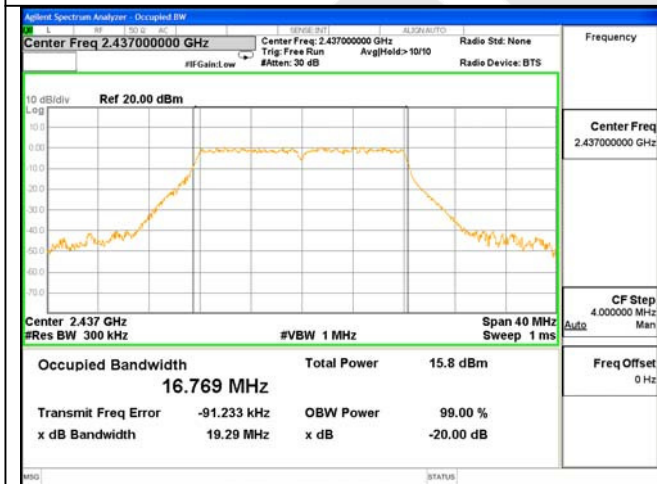

Test Mode: 802.11g---Mid

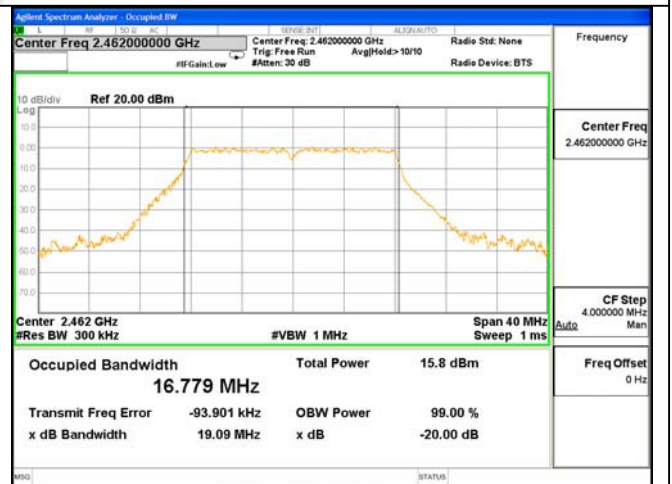

Test Mode: 802.11g---High

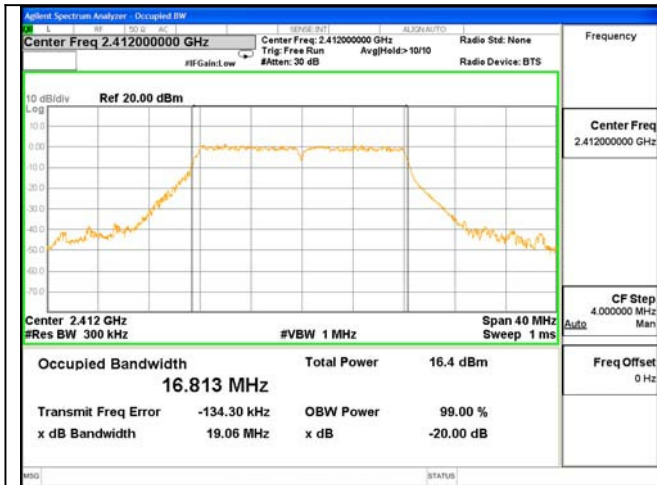

Test Mode: 802.11n20---Low

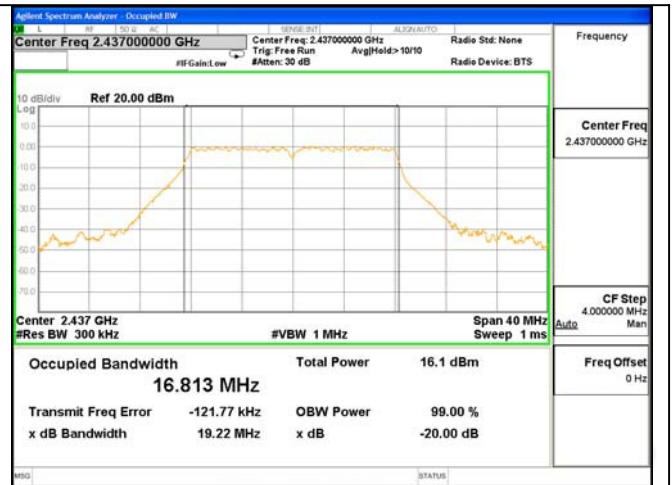

Test Mode: 802.11n20---Mid

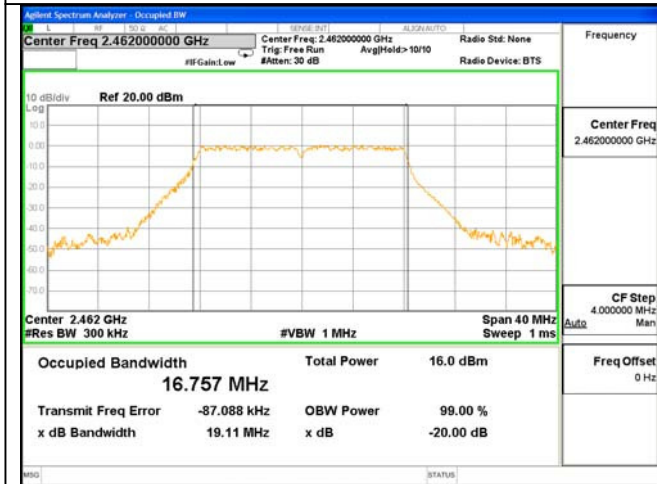

Test Mode: 802.11n20---High

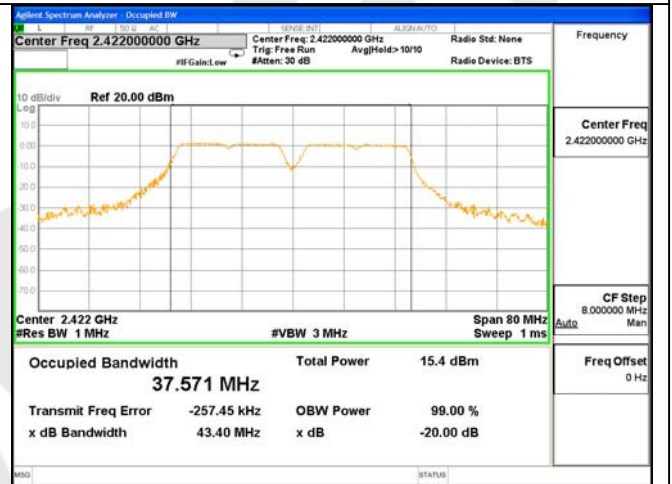

Test Mode: 802.11n40---Low

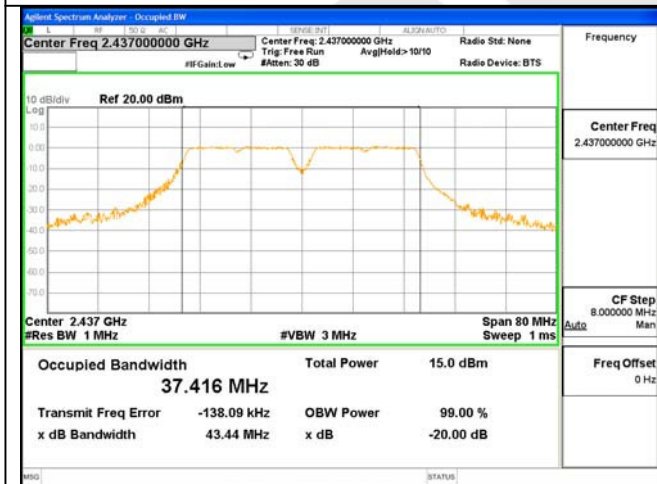

Test Mode: 802.11n40---Mid

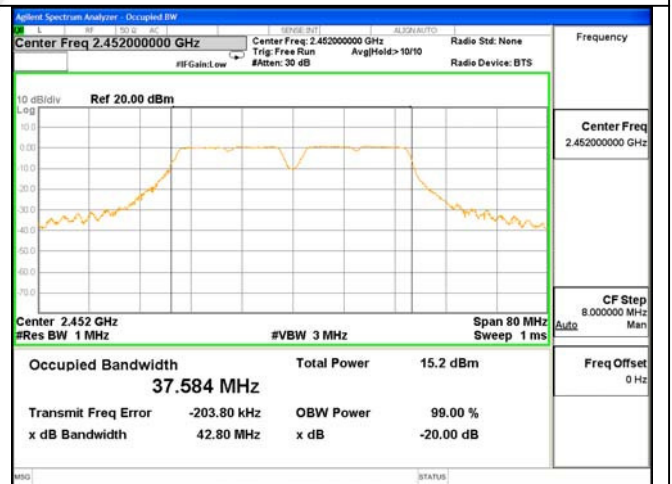

Test Mode: 802.11n40---High

4.3. Maximum Output Power Test

a. Limit

The maximum output power of the intentional radiator shall not exceed the following:

1. For systems using digital modulation in the bands of 902-928 MHz, 2400-2483.5 MHz, and 5725-5850 MHz: 1 watt (30dBm).
2. Except as shown in paragraphs (b)(3) (i), (ii) and (iii) of this section, if transmitting antenna of directional gain greater than 6 dBi are used the peak output power from the intentional radiator shall be reduced below the stated values in paragraphs (b)(1) or (b)(2) of this section, as appropriate, by the amount in dB that the directional gain of the antenna exceeds 6 dBi.

b. Configuration of Measurement

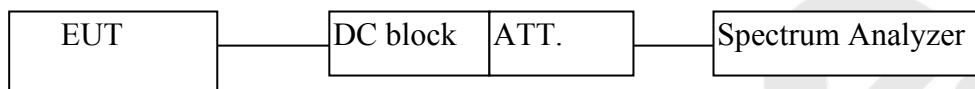

c. Data Rates

IEEE802.11b: Channel 1(2412MHz), Channel 6(2437MHz) and Channel 11(2462MHz) with 1 Mbps data rate (worst case) are chosen for the final testing.

IEEE802.11g: Channel 1(2412MHz), Channel 6(2437MHz) and Channel 11(2462MHz) with 6 Mbps data rate (the worst case) are chosen for the final testing.

IEEE802.11n (HT20): Channel 1(2412MHz), Channel 6(2437MHz) and Channel 11(2462MHz) with 6.5Mbps data rate (the worst case) are chosen for the final testing.

IEEE802.11n (HT40): Channel 3(2422MHz), Channel 6(2437MHz) and Channel 9(2452MHz) with 13.5Mbps data rate (the worst case) are chosen for the final testing.

d. Test Procedure

This test was according the kDB 558074 D01 DTS Meas Guidance v03r05 9.1.1:

1. Set span to at least 1.5 times the OBW.
2. Set the RBW = 1~5% of the OBW, not to exceed 1MHz.
3. Set VBW ≥ 3 * RBW.
4. Detector = Average.
5. Sweep time = auto couple.
6. Trace mode = max hold.
7. Allow trace to fully stabilize.

e. Test Equipment

Same as the equipment listed in 4.2.

f. Test Results

Pass.

g. Test Data

Test mode: IEEE 802.11b

Channel	Frequency (MHz)	Maximum transmit power (dBm)	Limit		Result
			(dBm)	(watts)	
Low	2412	18.19	30	1	Pass
Mid	2437	17.44			Pass
High	2462	17.68			Pass

Test mode: IEEE 802.11g

Channel	Frequency (MHz)	Maximum transmit power (dBm)	Limit		Result
			(dBm)	(watts)	
Low	2412	15.75	30	1	Pass
Mid	2437	15.34			Pass
High	2462	15.18			Pass

Test mode: IEEE 802.11n (HT20)

Channel	Frequency (MHz)	Maximum transmit power (dBm)	Limit		Result
			(dBm)	(watts)	
Low	2412	15.55	30	1	Pass
Mid	2437	15.12			Pass
High	2462	15.45			Pass

Test mode: IEEE 802.11n (HT40)

Channel	Frequency (MHz)	Maximum transmit power (dBm)	Limit		Result
			(dBm)	(watts)	
Low	2422	14.69	30	1	Pass
Mid	2437	14.37			Pass
High	2452	14.94			Pass



Test Mode: 802.11b---Low



Test Mode: 802.11b---Mid



Test Mode: 802.11b---High



Test Mode: 802.11g---Low



Test Mode: 802.11g---Mid

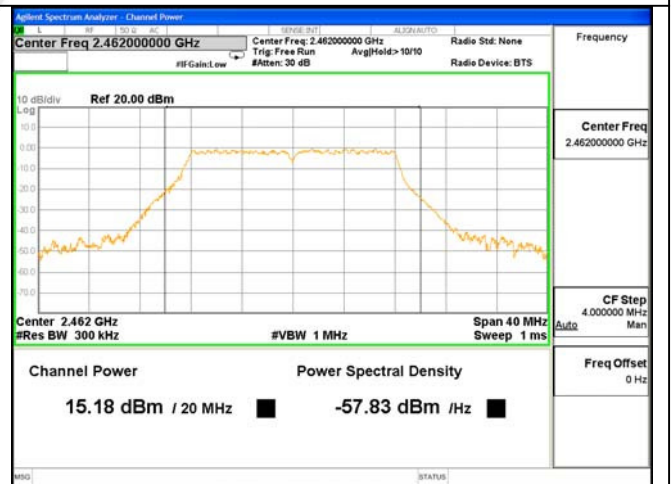

Test Mode: 802.11g---High



Test Mode: 802.11n20---Low



Test Mode: 802.11n20---Mid



Test Mode: 802.11n20---High



Test Mode: 802.11n40---Low



Test Mode: 802.11n40---Mid

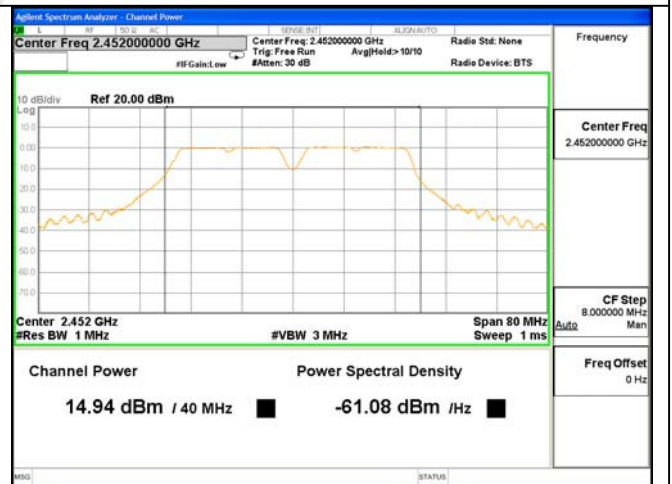

Test Mode: 802.11n40---High

4.4. Band Edges Measurement

a. Limit

According to §15.247(c), in any 100 kHz bandwidth outside the frequency bands in which the spread spectrum intentional radiator is operating, the radio frequency power that is produced by the intentional radiator shall be at least 20dB below that in the 100kHz bandwidth within the band that contains the highest level of the desired power, In addition, radiated emissions which fall in the restricted bands, as defined in §15.205(a), must also comply with the radiated emission limits specified in §15.209(a).

b. Test Procedure

1. Conducted Method:

- 1) Set RBW=100KHz, VBW=300KHz
- 2) Detector=peak
- 3) Sweep time= auto
- 4) Trace mode=max hold.

2. Radiated Method:

- 1) For below 1GHz: The EUT is placed on a turntable, which is 0.8m above the ground plane. The EUT is tested in 9*6*6 Chamber.
For above 1GHz: The EUT is placed on a turntable, which is 1.5m above the ground plane. The EUT is tested in 9*6*6 Chamber.
- 2) The turntable shall be rotated for 360 degrees to determine the position of maximum emission level.
- 3) EUT is set 3m away from the receiving antenna, which is varied from 1m to 4m to find out the highest emission.
- 4) Peak detector: RBW=1MHz, VBW=3MHz, SWT=AUTO
Average detector: RBW=1MHz, VBW=10Hz, SWT=AUTO
The EUT is tested in 9*6*6 Chamber.
- 5) Repeat the procedures until all the PEAK and AVERAGE versus POLARIZATION are measured.

30M to 1G emissions:

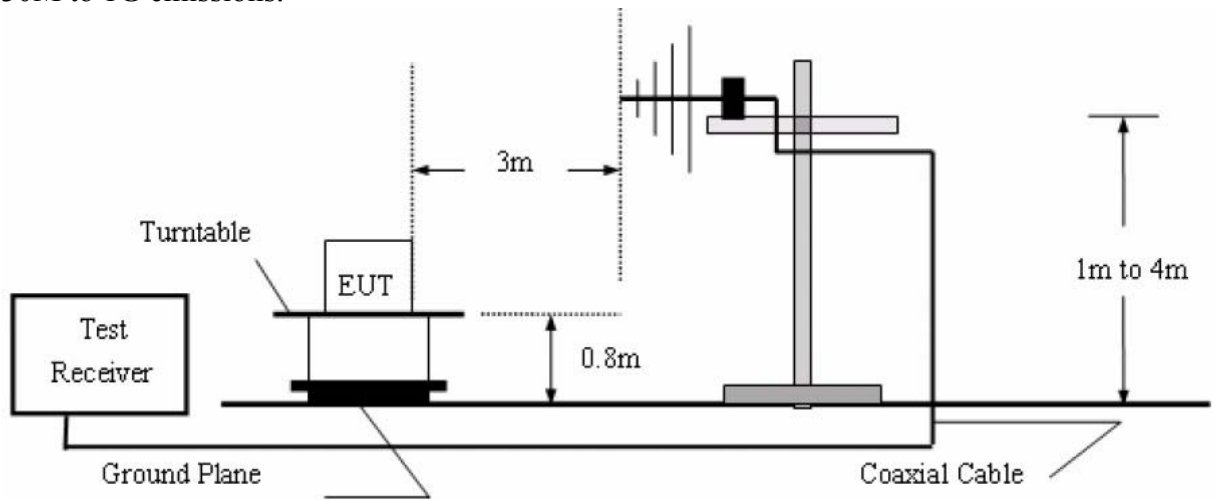

1G to 40G emissions:

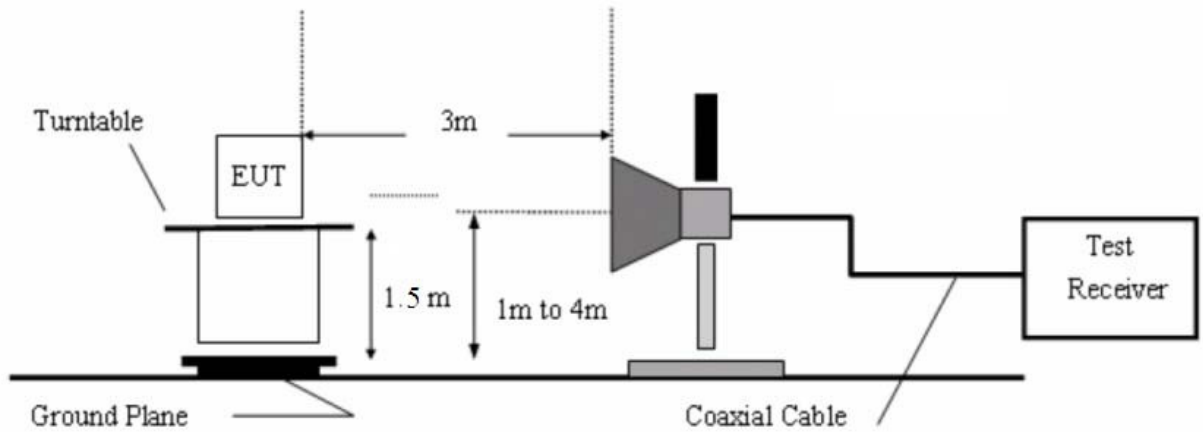

c. Test Equipment

Same as the equipment listed in 4.2.

d. Test Results

Pass.

e. Test Plots

See the following page.

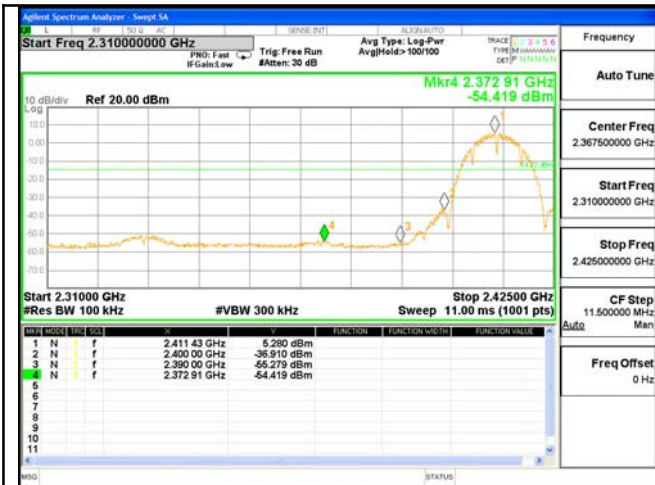

Test Mode: 802.11b---Low



Test Mode: 802.11b---High



Test Mode: 802.11g---Low

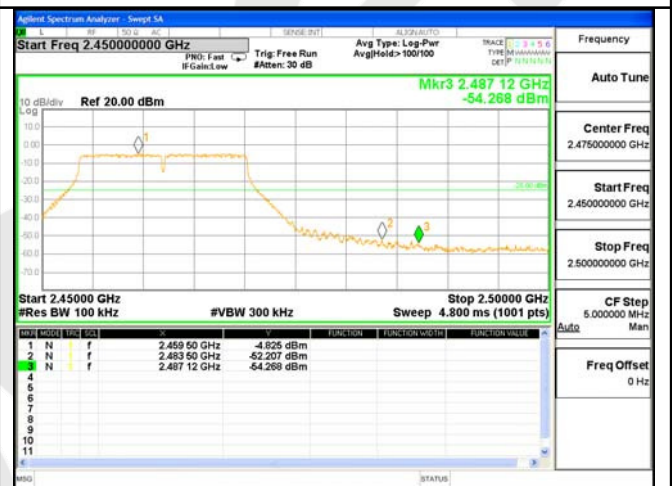

Test Mode: 802.11g---High



Test Mode: 802.11n20---Low

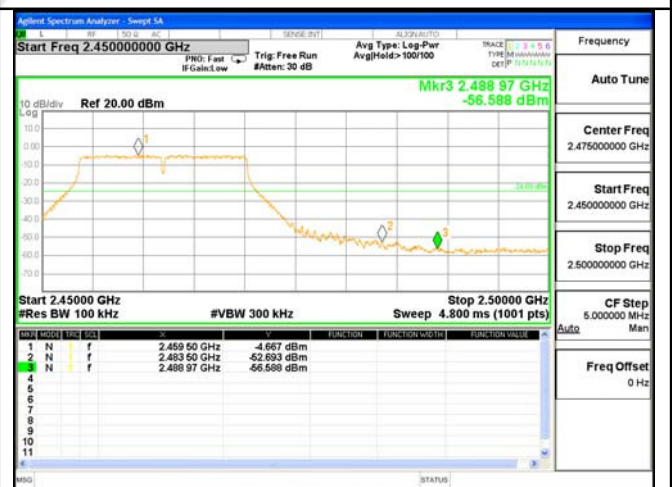

Test Mode: 802.11n20---High

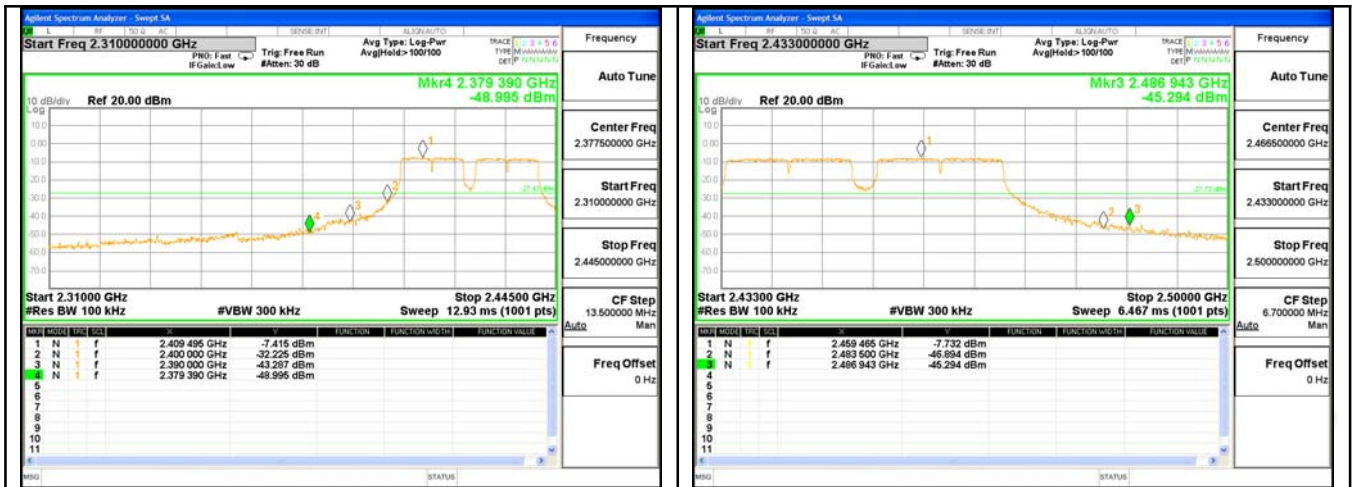

Test Mode: 802.11n40---Low

Test Mode: 802.11n40---High



Test Mode: 802.11b
2412MHz
Horizontal-PEAK:

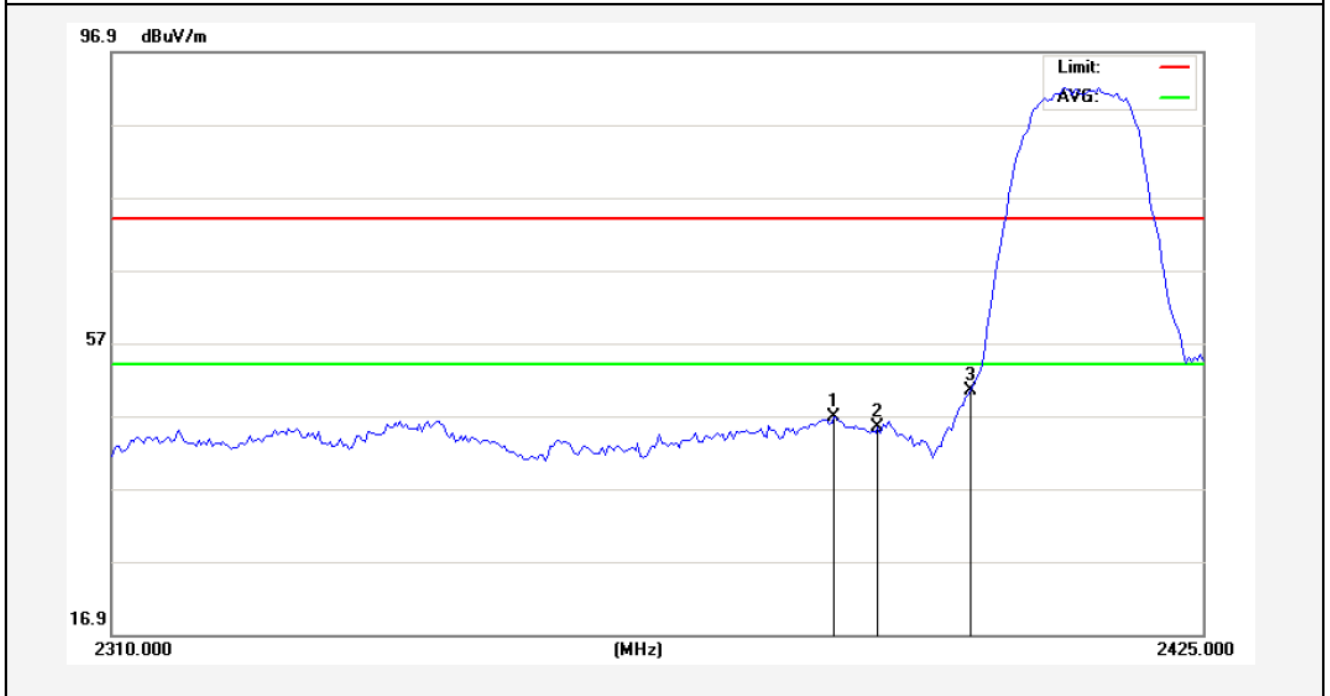

Frequency	CableLoss	AntFactor	PreampFactor	ReadLevel	Level	Limit	Over Limit	Remark
MHz	dB	dB/m	dB	dBμV	dBμV/m	dBμV/m	dB	
2385.613	2.23	30.38	31.47	45.59	46.73	74.00	-27.27	Peak
2390.000	2.21	30.38	31.47	44.25	45.37	74.00	-28.63	Peak
2400.000	2.22	30.38	31.47	49.20	50.33	74.00	-23.67	Peak

A M I

Horizontal-AV:

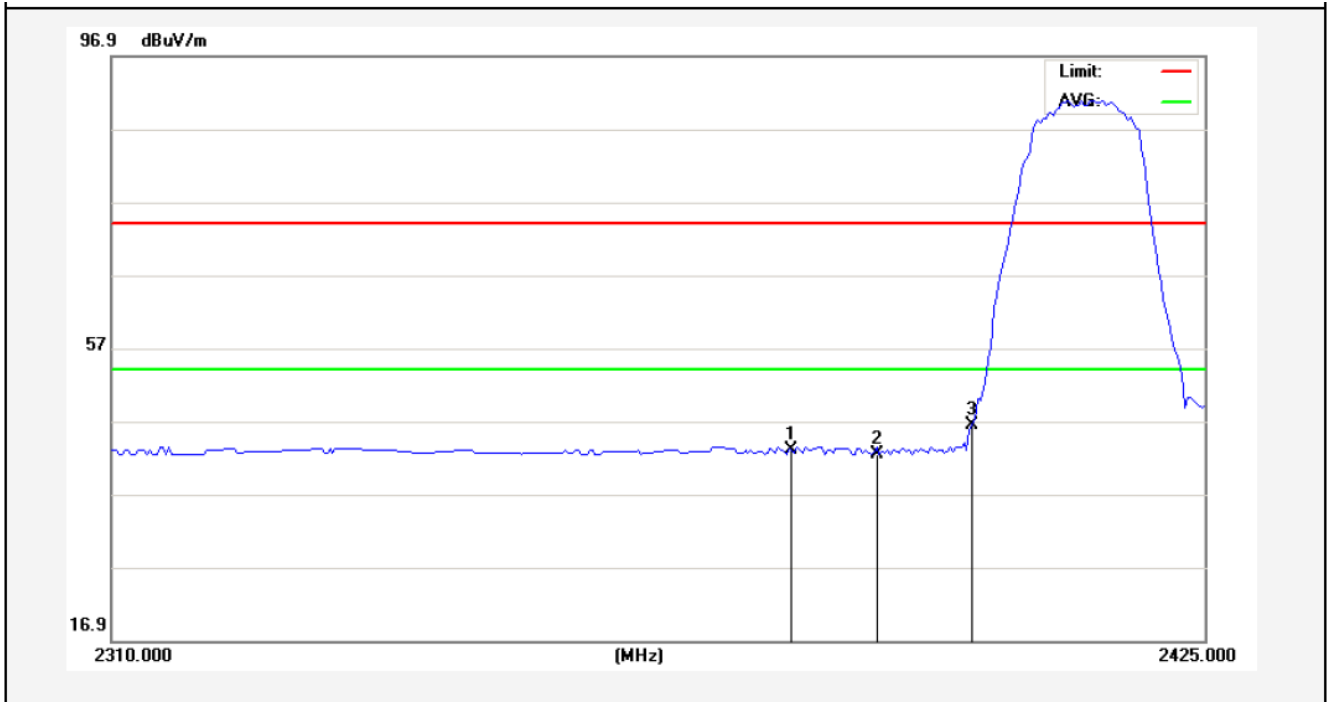

Frequency	CableLoss	AntFactor	Preamplifier	ReadLevel	Level	Limit	Over Limit	Remark
MHz	dB	dB/m	dB	dBμV	dBμV/m	dBμV/m	dB	
2381.012	2.17	30.38	31.47	41.84	42.92	54.00	-11.08	AVG
2390.000	2.21	30.38	31.47	41.32	42.44	54.00	-11.56	AVG
2400.000	2.22	30.38	31.47	45.31	46.44	54.00	-7.56	AVG

Anbotek

Test Mode: 802.11b
2412MHz
Vertical-PEAK:

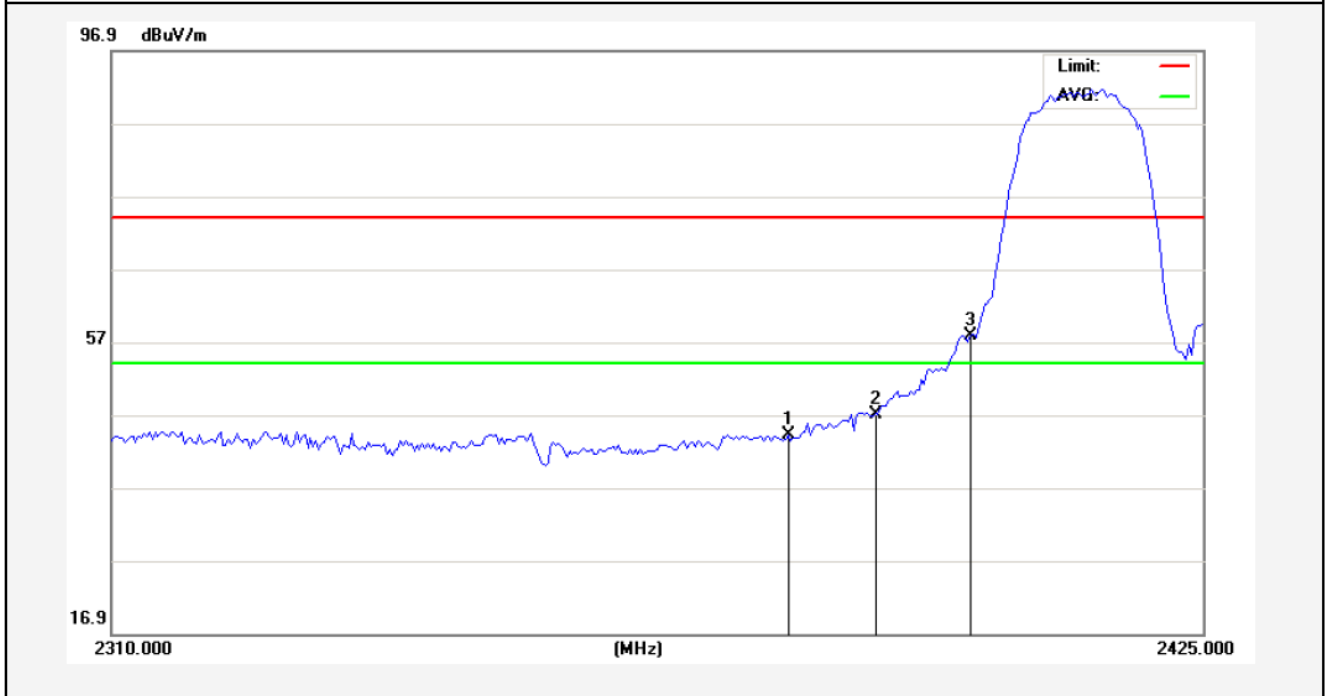

Frequency	CableLoss	AntFactor	PreampFactor	ReadLevel	Level	Limit	Over Limit	Remark
MHz	dB	dB/m	dB	dBμV	dBμV/m	dBμV/m	dB	
2380.725	2.17	30.38	31.47	43.05	44.13	74.00	-29.87	Peak
2390.000	2.21	30.38	31.47	45.98	47.10	74.00	-26.90	Peak
2400.000	2.22	30.38	31.47	56.69	57.82	74.00	-16.18	Peak

A M U

Vertical-AV:

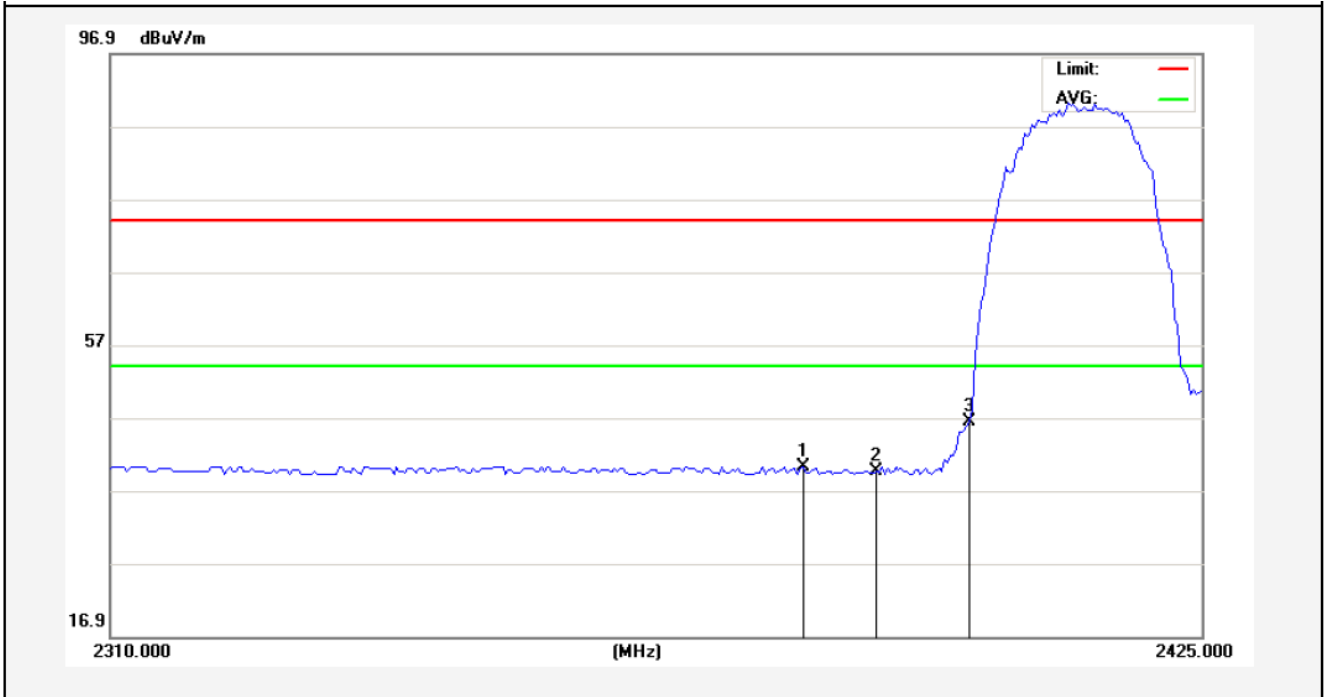

Frequency	CableLoss	AntFactor	Preamplifier	ReadLevel	Level	Limit	Over Limit	Remark
MHz	dB	dB/m	dB	dBμV	dBμV/m	dBμV/m	dB	
2382.450	2.18	30.38	31.47	39.05	40.14	54.00	-13.86	AVG
2390.000	2.21	30.38	31.47	38.51	39.63	54.00	-14.37	AVG
2400.000	2.22	30.38	31.47	45.34	46.47	54.00	-7.53	AVG

Anbotek

Test Mode: 802.11b
2462MHz
Horizontal-PEAK:

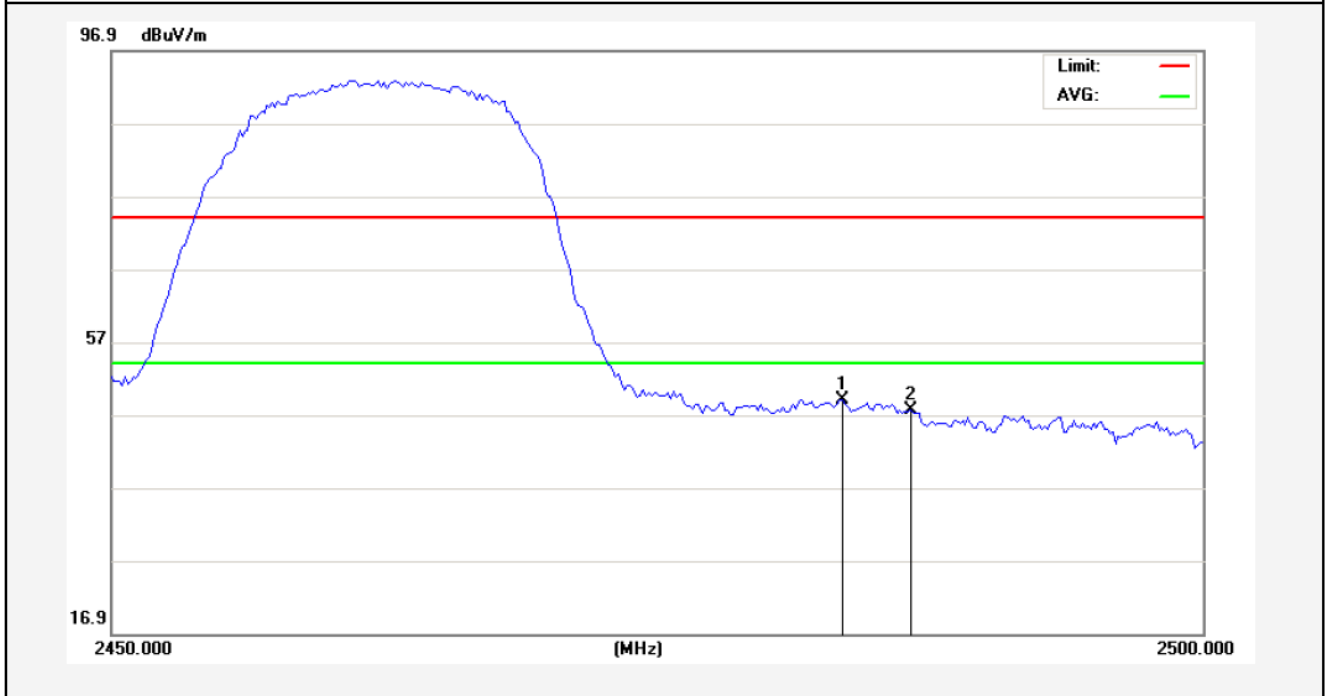

Frequency	CableLoss	AntFactor	PreampFactor	ReadLevel	Level	Limit	Over Limit	Remark
MHz	dB	dB/m	dB	dBμV	dBμV/m	dBμV/m	dB	
2483.500	2.35	30.38	31.47	47.73	48.99	74.00	-25.01	Peak
2486.625	2.36	30.38	31.47	46.29	47.56	74.00	-26.44	Peak

Anbotek

Horizontal-AV:

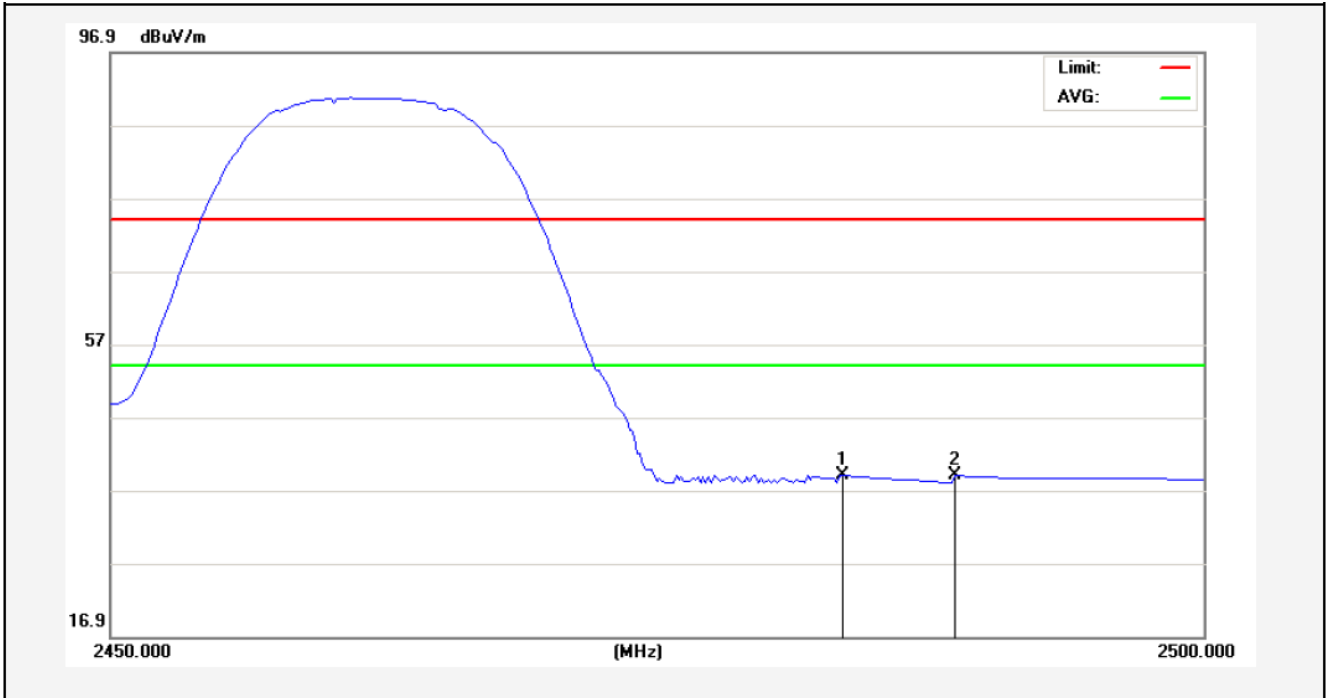

Frequency	CableLoss	AntFactor	Preamplifier	ReadLevel	Level	Limit	Over Limit	Remark
MHz	dB	dB/m	dB	dBμV	dBμV/m	dBμV/m	dB	
2483.500	2.35	30.38	31.47	37.69	38.95	54.00	-15.05	AVG
2488.625	2.37	30.38	31.47	37.70	38.98	54.00	-15.02	AVG

Anbotek

Test Mode: 802.11b
2462MHz
Vertical-PEAK:

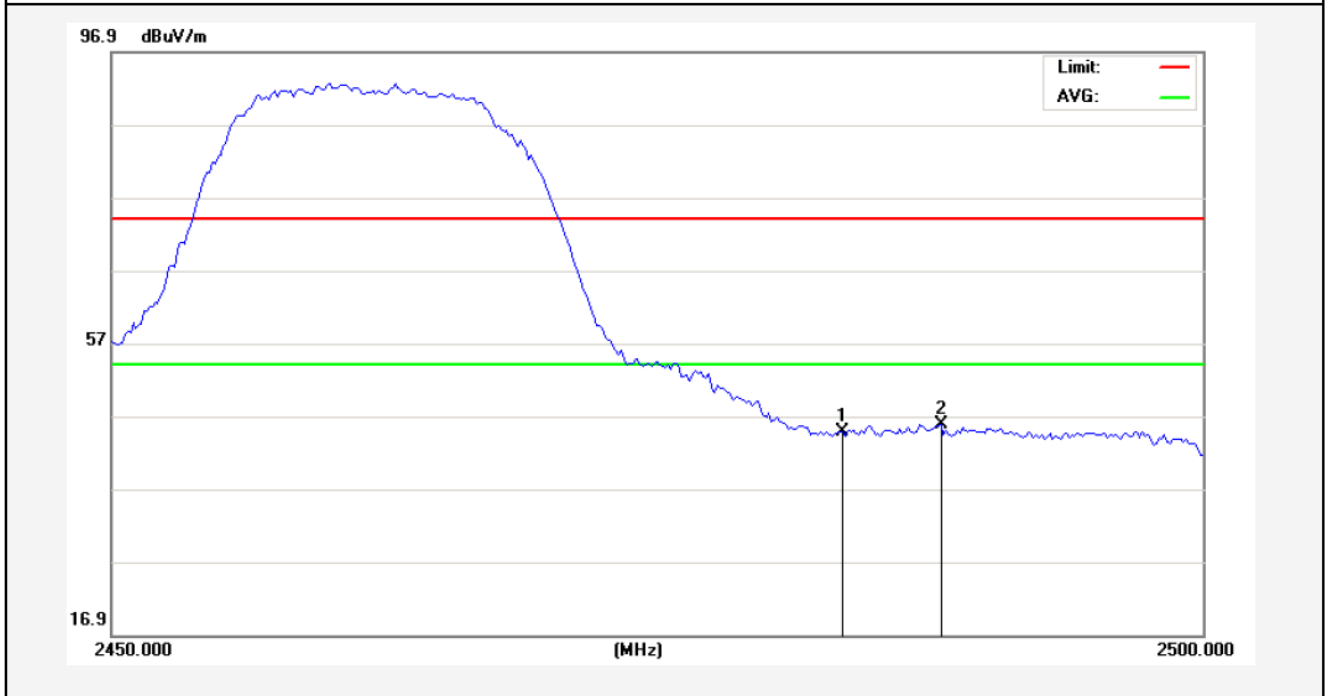

Frequency	CableLoss	AntFactor	PreampFactor	ReadLevel	Level	Limit	Over Limit	Remark
MHz	dB	dB/m	dB	dBμV	dBμV/m	dBμV/m	dB	
2483.500	2.35	30.38	31.47	43.46	44.72	74.00	-29.28	Peak
2488.000	2.38	30.38	31.47	44.58	45.87	74.00	-28.13	Peak

Anbotek

Vertical-AV:

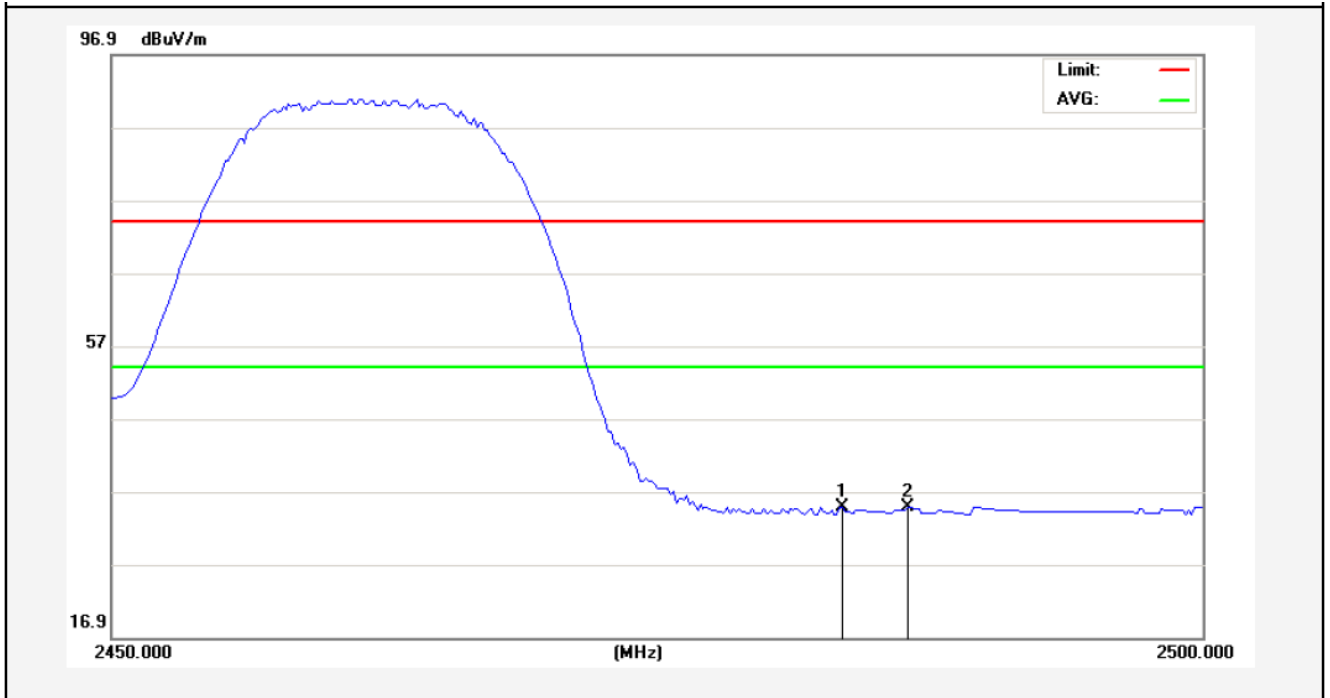

Frequency	CableLoss	AntFactor	Preamplifier	ReadLevel	Level	Limit	Over Limit	Remark
MHz	dB	dB/m	dB	dBμV	dBμV/m	dBμV/m	dB	
2483.500	2.35	30.38	31.47	33.51	34.77	54.00	-19.23	AVG
2486.500	2.36	30.38	31.47	33.52	34.79	54.00	-19.21	AVG

Anbotek

Test Mode: 802.11g
2412MHz
Horizontal-PEAK:

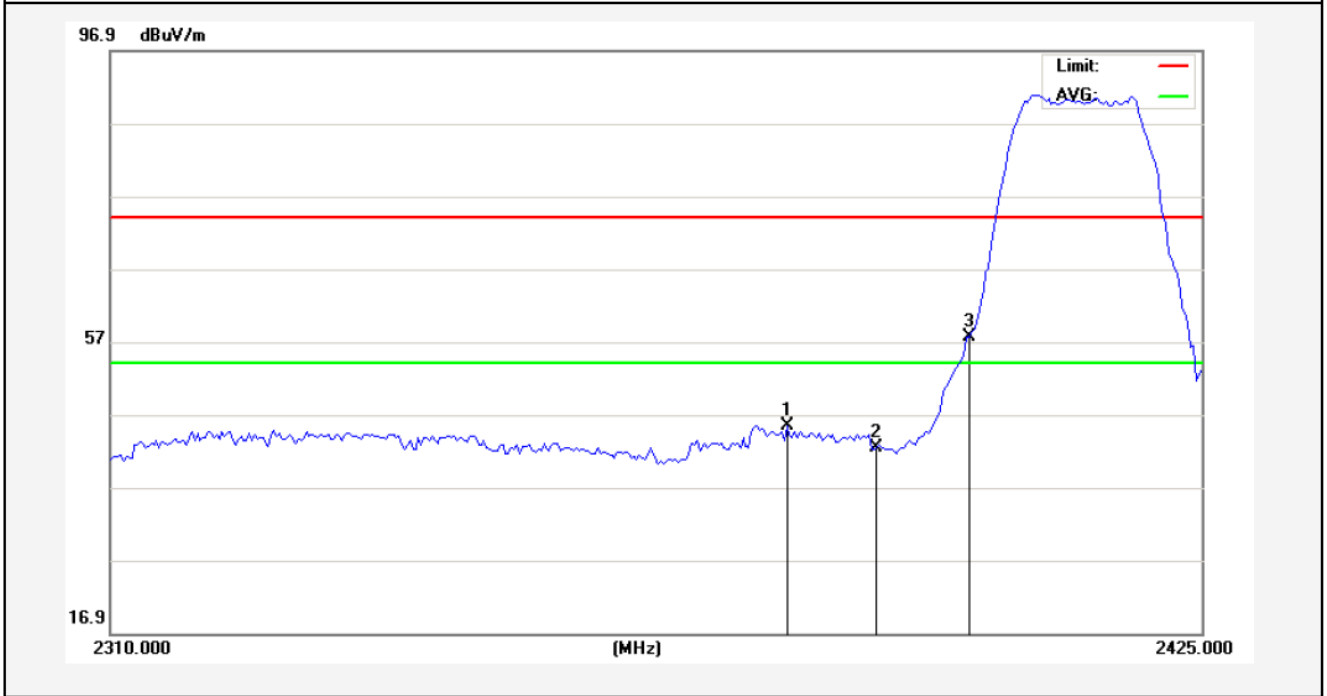

Frequency	CableLoss	AntFactor	Preamplifier	ReadLevel	Level	Limit	Over Limit	Remark
MHz	dB	dB/m	dB	dBμV	dBμV/m	dBμV/m	dB	
2380.725	2.17	30.38	31.47	44.34	45.42	74.00	-28.58	Peak
2390.000	2.21	30.38	31.47	41.23	42.35	74.00	-31.65	Peak
2400.000	2.22	30.38	31.47	56.54	57.67	74.00	-16.33	Peak

AMC

Horizontal-AV:

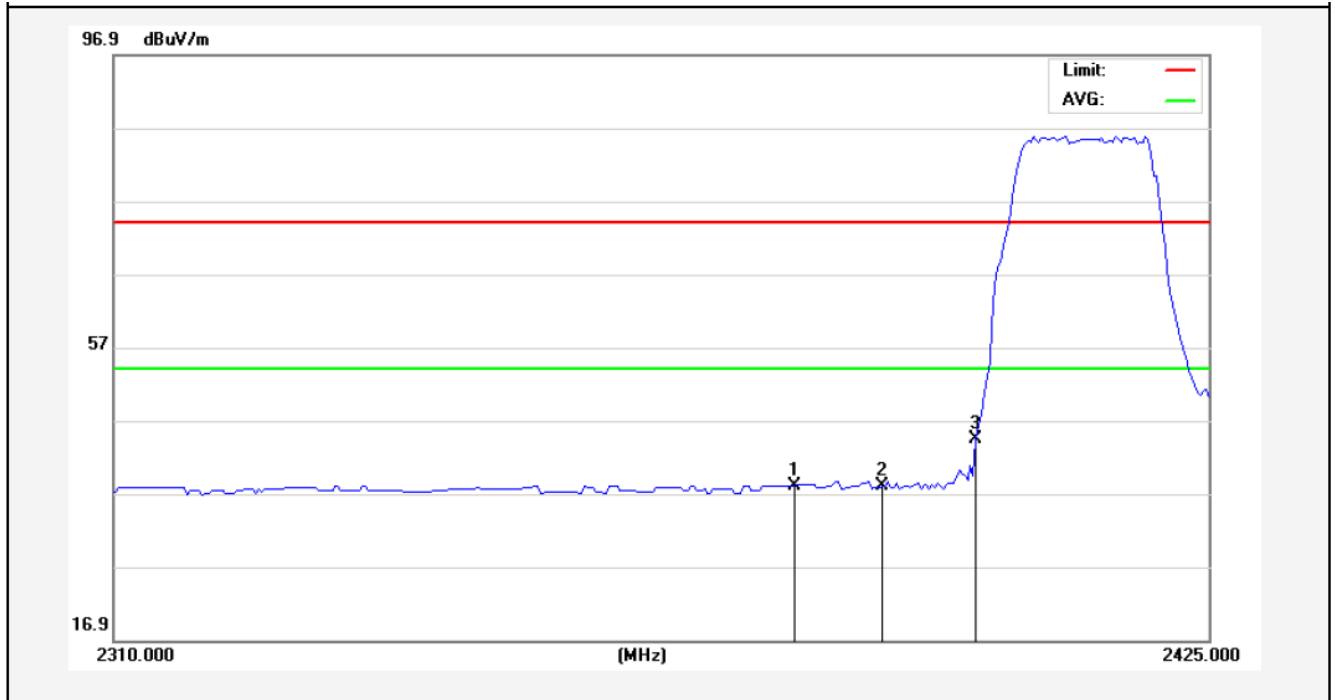

Frequency	CableLoss	AntFactor	Preamplifier	ReadLevel	Level	Limit	Over Limit	Remark
MHz	dB	dB/m	dB	dBμV	dBμV/m	dBμV/m	dB	
2380.725	2.17	30.38	31.47	36.99	38.07	54.00	-15.93	AVG
2390.000	2.21	30.38	31.47	36.80	37.92	54.00	-16.08	AVG
2400.000	2.22	30.38	31.47	43.29	44.42	54.00	-9.58	AVG

Anbotek

Test Mode: 802.11g
2412MHz
Vertical-PEAK:

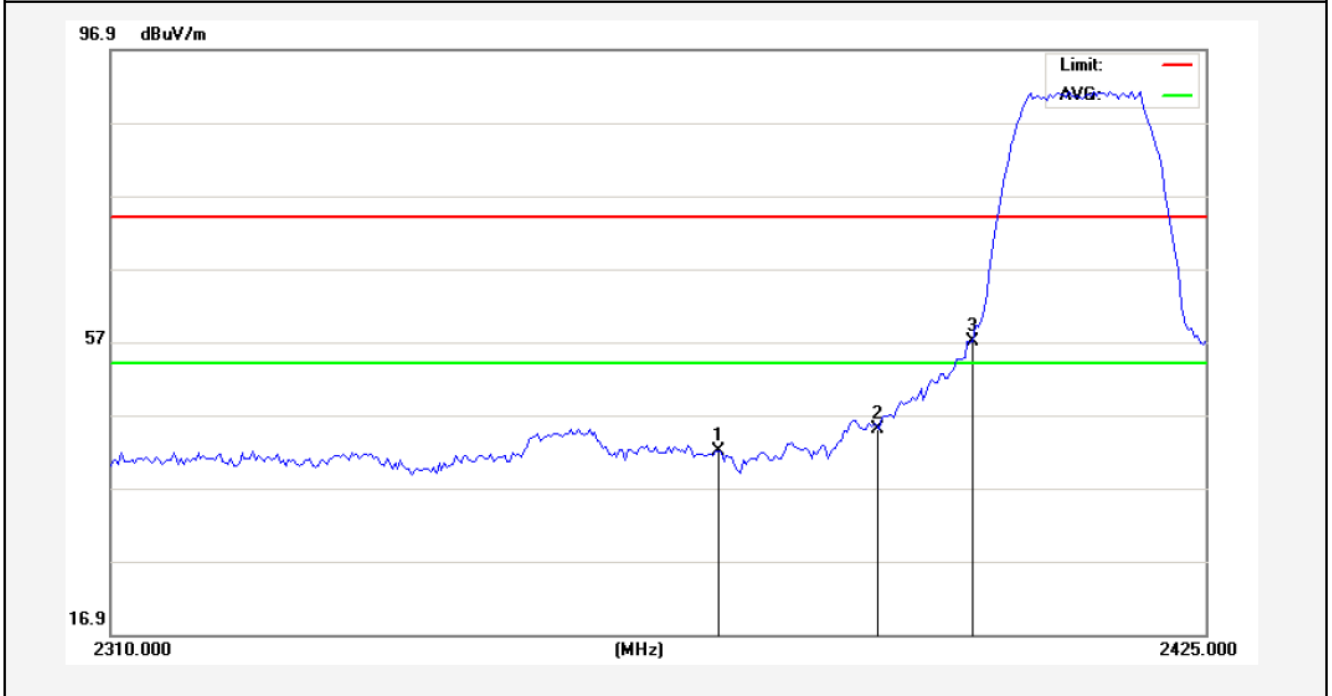

Frequency	CableLoss	AntFactor	PreampFactor	ReadLevel	Level	Limit	Over Limit	Remark
MHz	dB	dB/m	dB	dBμV	dBμV/m	dBμV/m	dB	
2373.250	2.16	30.38	31.47	40.91	41.98	74.00	-32.02	Peak
2390.000	2.21	30.38	31.47	43.92	45.04	74.00	-28.96	Peak
2400.000	2.22	30.38	31.47	55.87	57.00	74.00	-17.00	Peak

AMC

Vertical-AV:

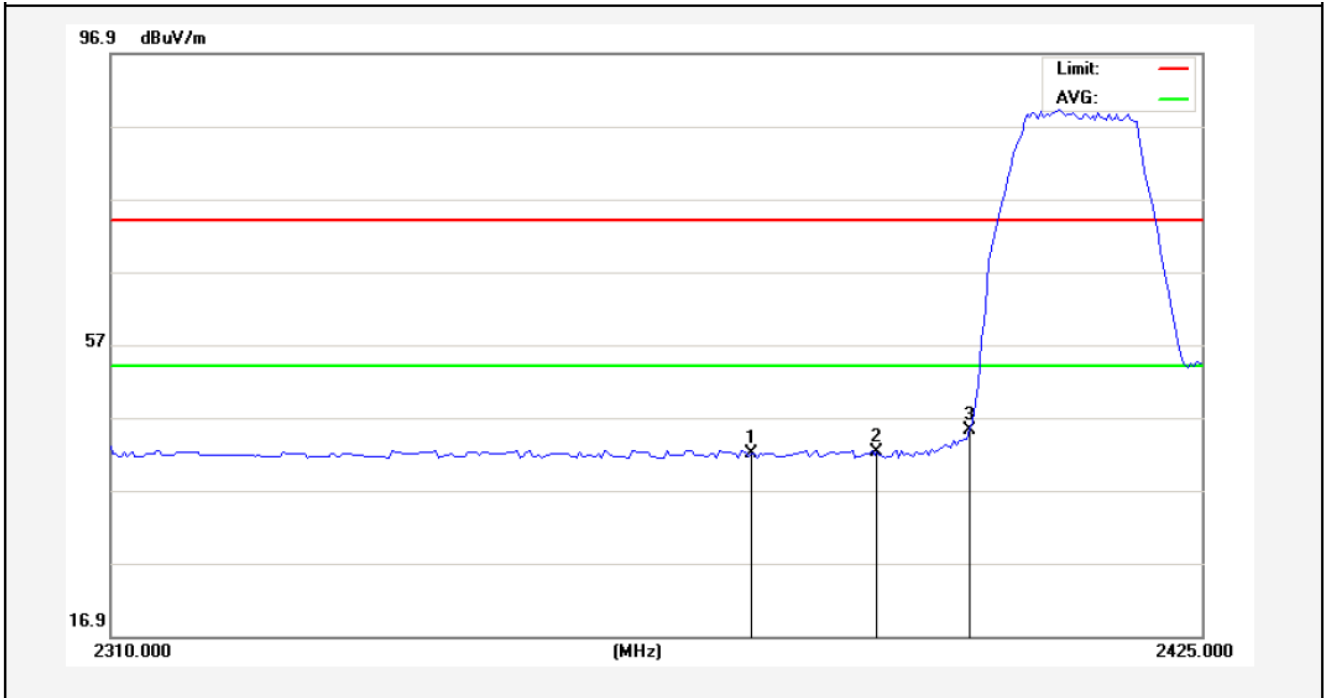

Frequency	CableLoss	AntFactor	Preamplifier	ReadLevel	Level	Limit	Over Limit	Remark
MHz	dB	dB/m	dB	dBμV	dBμV/m	dBμV/m	dB	
2376.988	2.18	30.38	31.47	40.96	42.05	54.00	-11.95	AVG
2390.000	2.21	30.38	31.47	41.05	42.17	54.00	-11.83	AVG
2400.000	2.22	30.38	31.47	44.17	45.30	54.00	-8.70	AVG

AVG

Test Mode: 802.11g
2462MHz
Horizontal-PEAK:

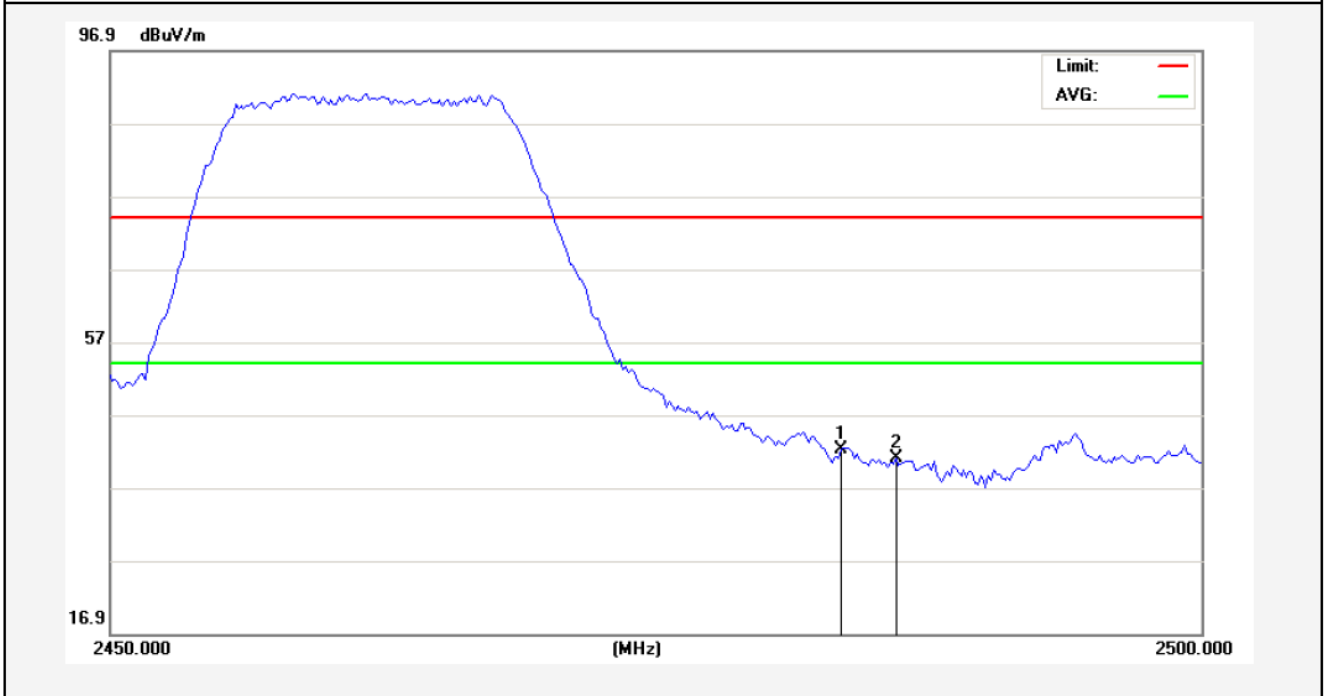

Frequency	CableLoss	AntFactor	PreampFactor	ReadLevel	Level	Limit	Over Limit	Remark
MHz	dB	dB/m	dB	dBμV	dBμV/m	dBμV/m	dB	
2483.500	2.35	30.38	31.47	40.87	42.13	74.00	-31.87	Peak
2486.000	2.37	30.38	31.47	39.73	41.01	74.00	-32.99	Peak

Anbotek

Horizontal-AV:

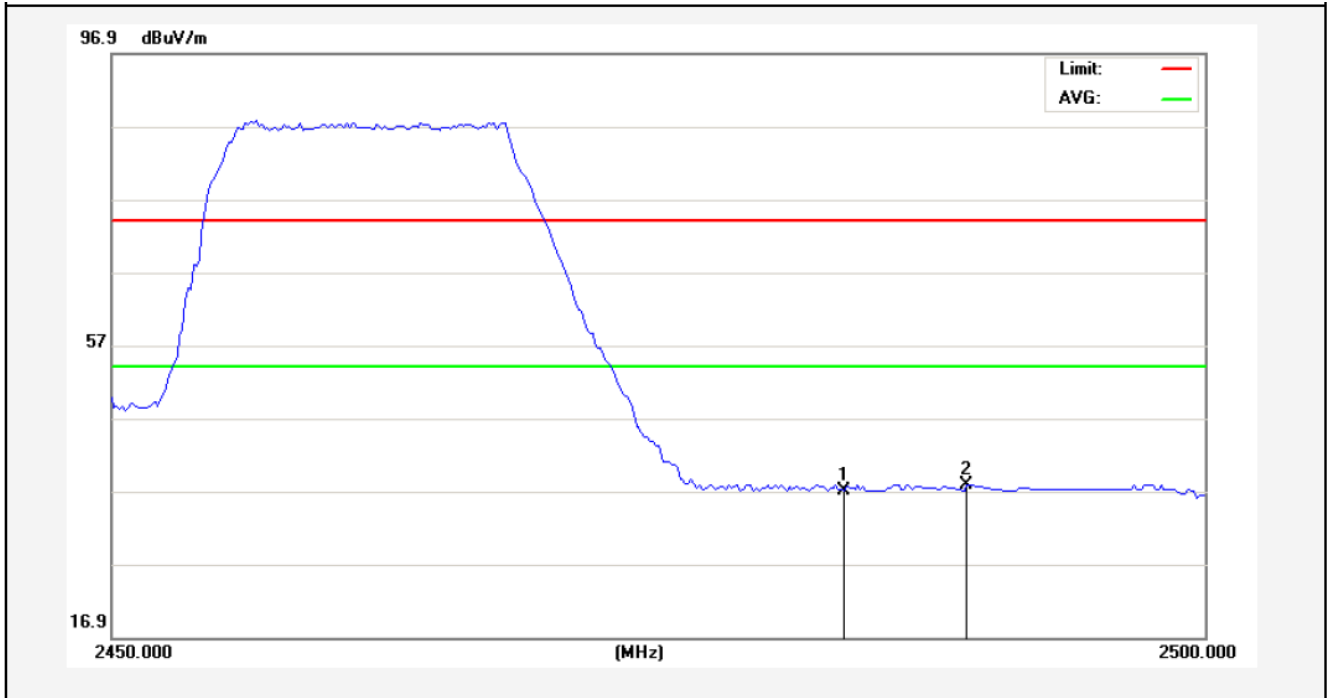

Frequency	CableLoss	AntFactor	Preamplifier	ReadLevel	Level	Limit	Over Limit	Remark
MHz	dB	dB/m	dB	dBμV	dBμV/m	dBμV/m	dB	
2483.500	2.35	30.38	31.47	35.81	37.07	54.00	-16.93	AVG
2489.125	2.38	30.38	31.47	36.60	37.89	54.00	-16.11	AVG

Anbotek

Test Mode: 802.11g
2462MHz
Vertical-PEAK:

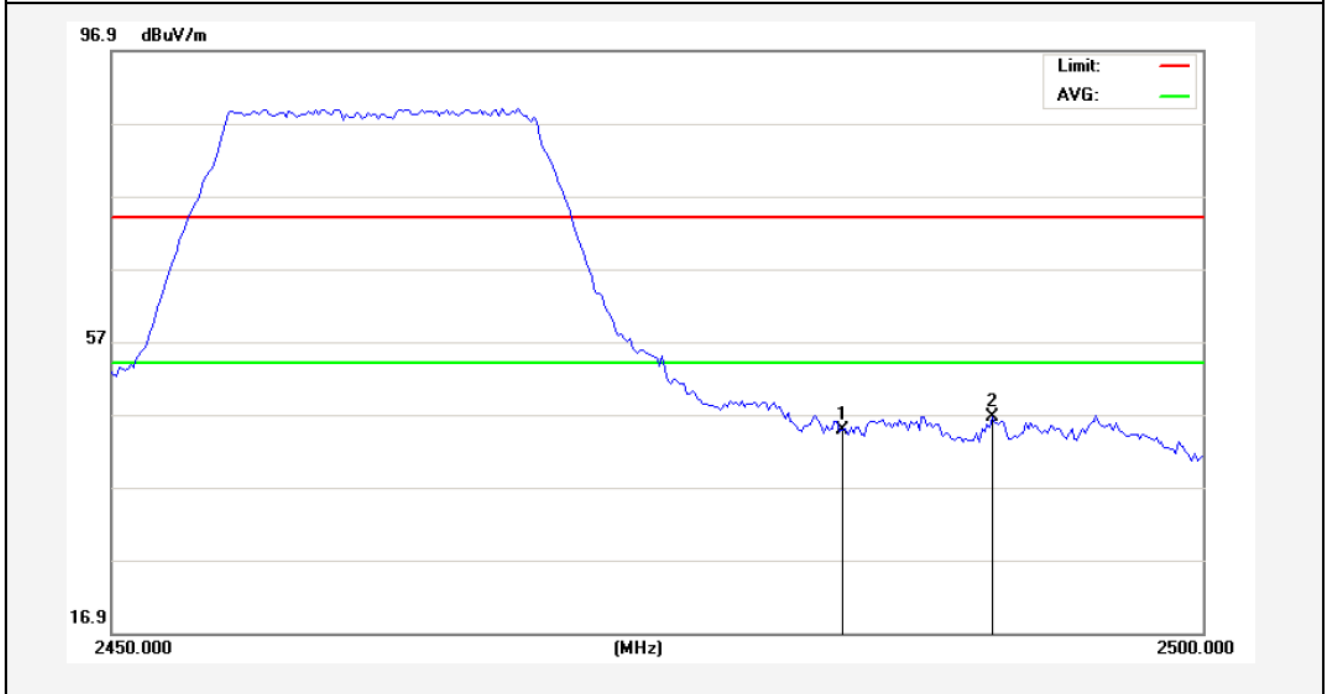

Frequency	CableLoss	AntFactor	PreampFactor	ReadLevel	Level	Limit	Over Limit	Remark
MHz	dB	dB/m	dB	dBμV	dBμV/m	dBμV/m	dB	
2483.500	2.35	30.38	31.47	43.50	44.76	74.00	-29.24	Peak
2490.375	2.38	30.38	31.47	45.38	46.67	74.00	-27.33	Peak

Anbotek

Vertical-AV:

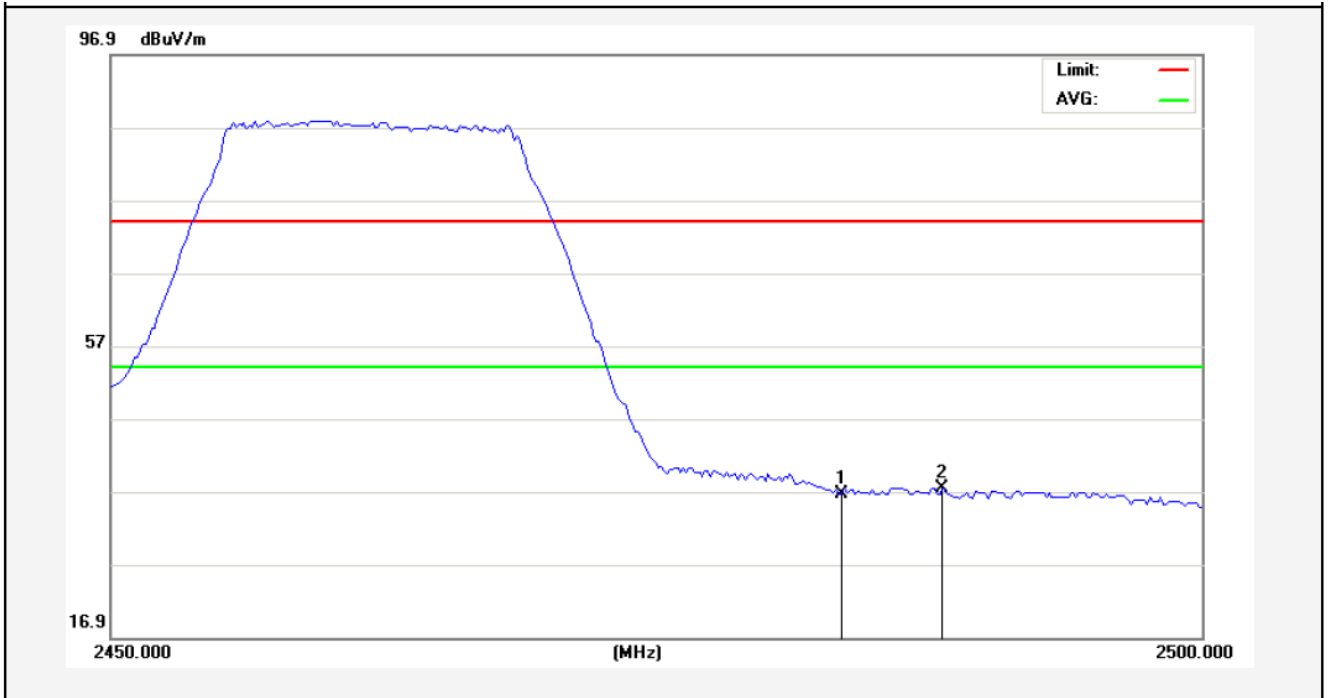

Frequency	CableLoss	AntFactor	Preamplifier	ReadLevel	Level	Limit	Over Limit	Remark
MHz	dB	dB/m	dB	dBμV	dBμV/m	dBμV/m	dB	
2483.500	2.35	30.38	31.47	35.31	36.57	54.00	-17.43	AVG
2488.125	2.38	30.38	31.47	36.04	37.33	54.00	-16.67	AVG

Anbotek

Test Mode: 802.11n (HT20)

2412MHz

Horizontal-PEAK:

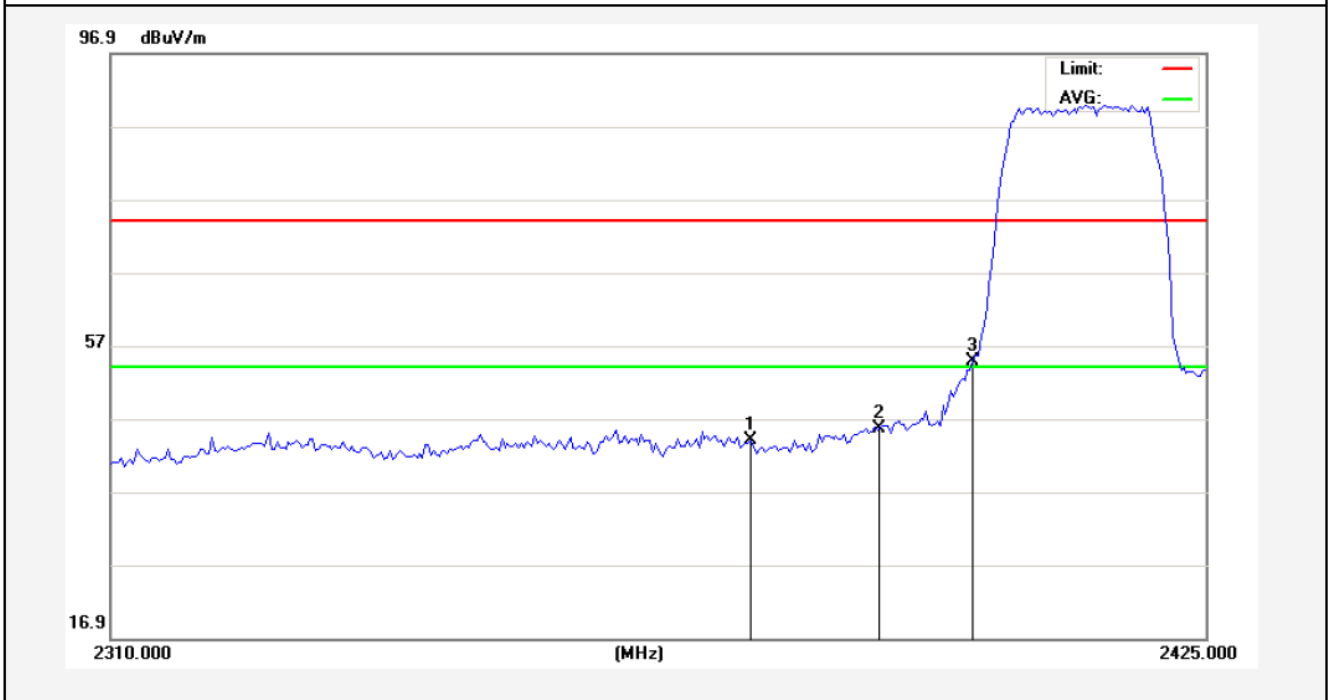

Frequency	CableLoss	AntFactor	PreampFactor	ReadLevel	Level	Limit	Over Limit	Remark
MHz	dB	dB/m	dB	dBμV	dBμV/m	dBμV/m	dB	
2376.700	2.18	30.38	31.47	42.97	44.06	74.00	-29.94	Peak
2390.000	2.21	30.38	31.47	44.50	45.62	74.00	-28.38	Peak
2400.000	2.22	30.38	31.47	53.63	54.76	74.00	-19.24	Peak

A M I

Horizontal-AV:

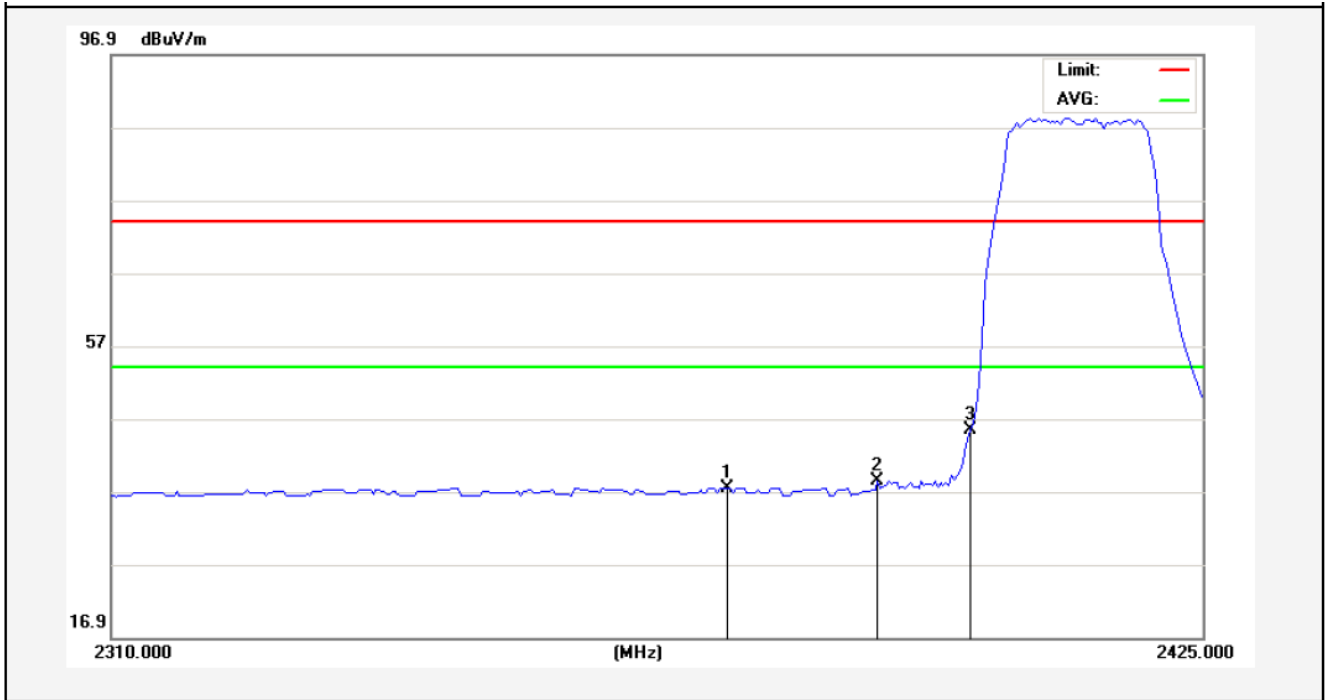

Frequency	CableLoss	AntFactor	Preamplifier	ReadLevel	Level	Limit	Over Limit	Remark
MHz	dB	dB/m	dB	dBμV	dBμV/m	dBμV/m	dB	
2374.400	2.17	30.38	31.47	36.32	37.40	54.00	-16.60	AVG
2390.000	2.21	30.38	31.47	37.20	38.32	54.00	-15.68	AVG
2400.000	2.22	30.38	31.47	44.27	45.40	54.00	-8.60	AVG

Anbotek

Test Mode: 802.11n (HT20)

2412MHz

Vertical-PEAK:

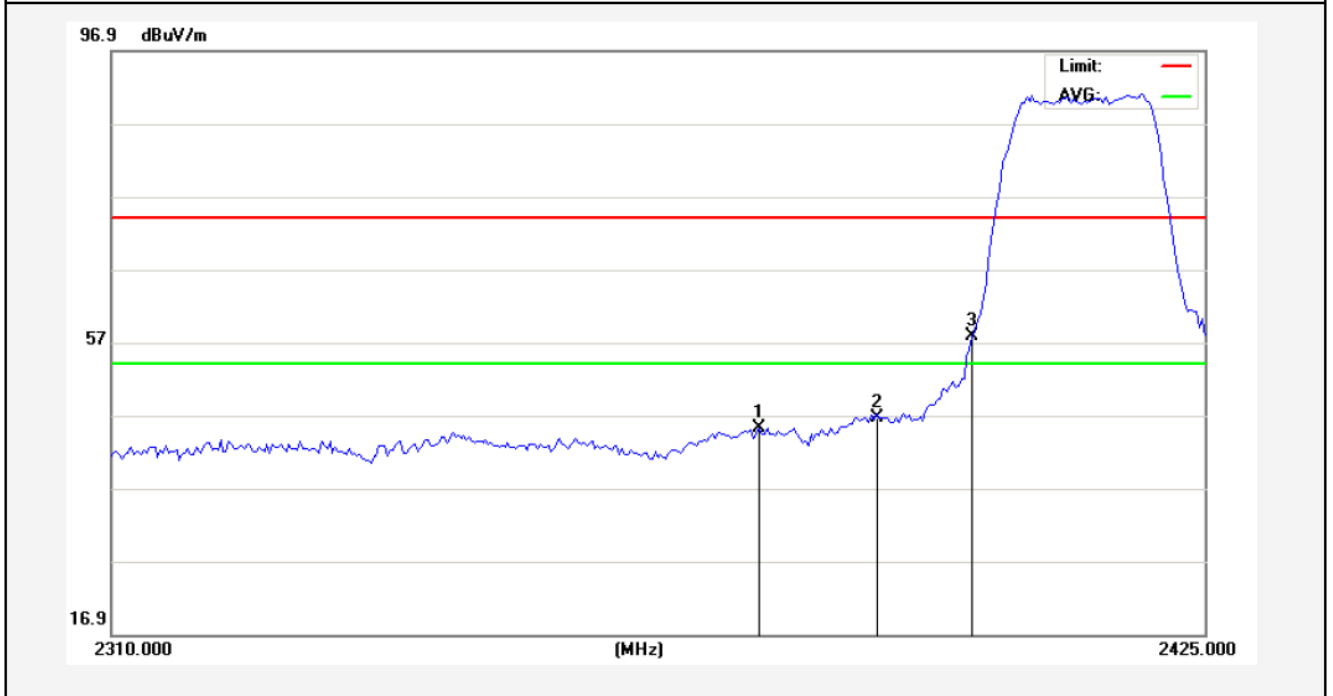

Frequency	CableLoss	AntFactor	PreampFactor	ReadLevel	Level	Limit	Over Limit	Remark
MHz	dB	dB/m	dB	dB μ V	dB μ V/m	dB μ V/m	dB	
2377.563	2.18	30.38	31.47	44.15	45.24	74.00	-28.76	Peak
2390.000	2.21	30.38	31.47	45.50	46.62	74.00	-27.38	Peak
2400.000	2.22	30.38	31.47	56.61	57.74	74.00	-16.26	Peak

Anbotek

Vertical-AV:

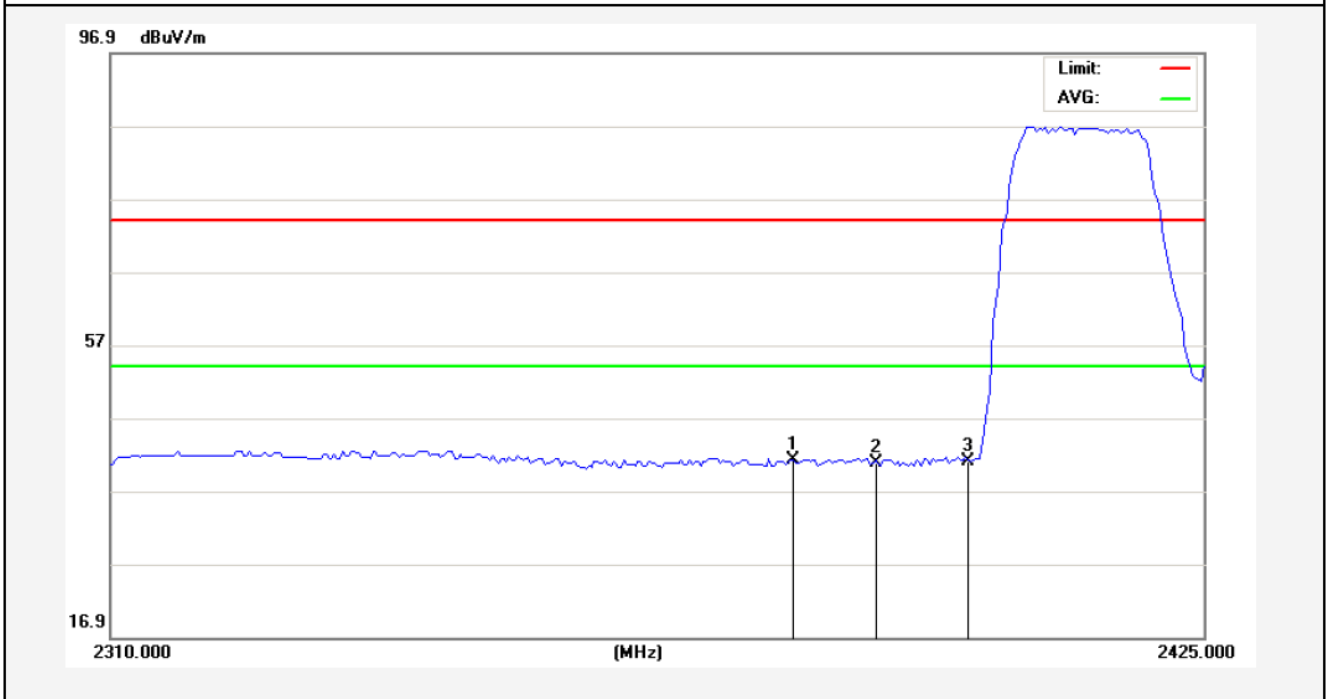

Frequency	CableLoss	AntFactor	Preamplifier	ReadLevel	Level	Limit	Over Limit	Remark
MHz	dB	dB/m	dB	dBμV	dBμV/m	dBμV/m	dB	
2381.300	2.20	30.38	31.47	40.14	41.25	54.00	-12.75	AVG
2390.000	2.21	30.38	31.47	39.67	40.79	54.00	-13.21	AVG
2400.000	2.22	30.38	31.47	39.88	41.01	54.00	-12.99	AVG

AVG

Test Mode: 802.11n (HT20)

2462MHz

Horizontal-PEAK:

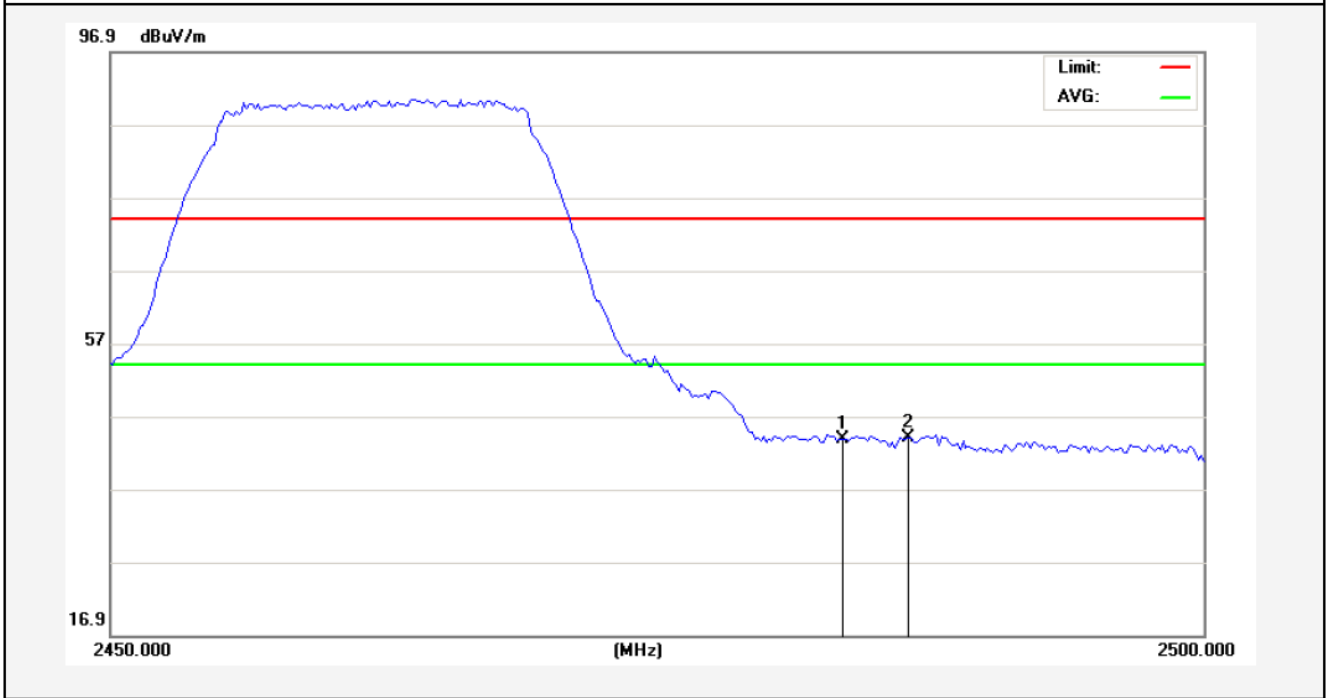

Frequency	CableLoss	AntFactor	PreampFactor	ReadLevel	Level	Limit	Over Limit	Remark
MHz	dB	dB/m	dB	dBμV	dBμV/m	dBμV/m	dB	
2483.500	2.35	30.38	31.47	42.52	43.78	74.00	-30.22	Peak
2486.500	2.37	30.38	31.47	42.79	44.07	74.00	-29.93	Peak

A M B

Horizontal-AV:

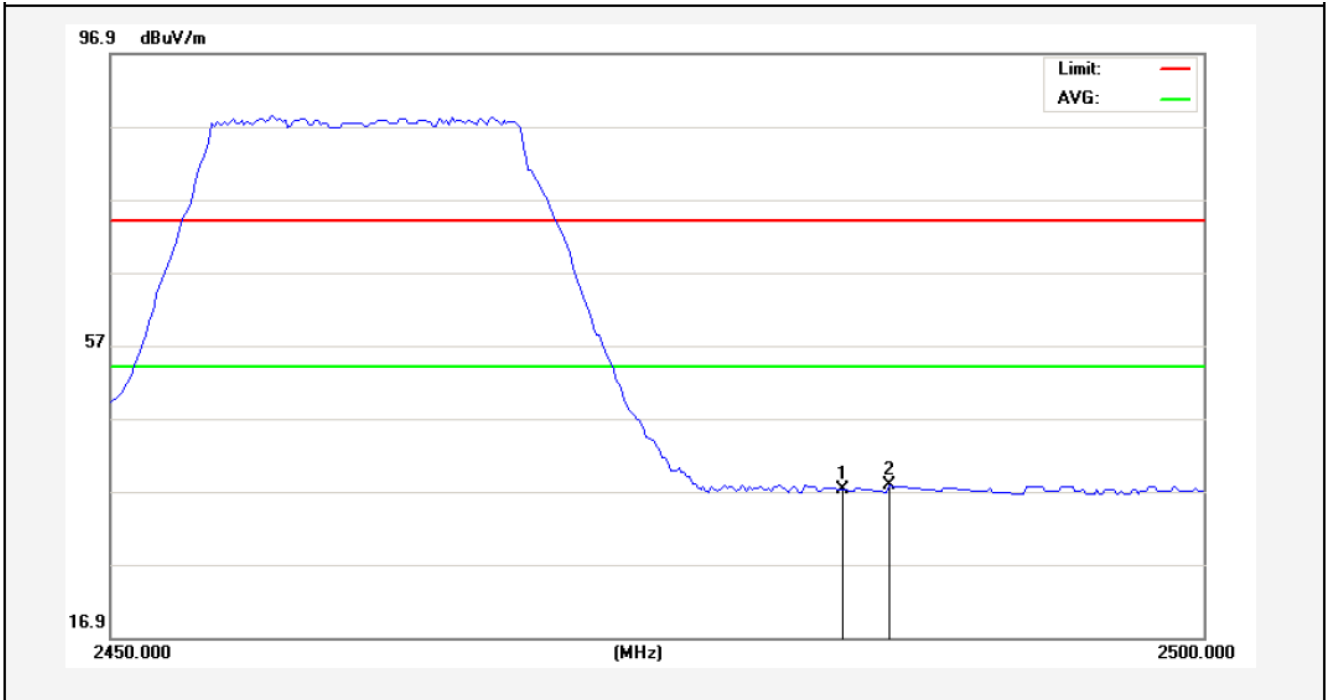

Frequency	CableLoss	AntFactor	Preamplifier	ReadLevel	Level	Limit	Over Limit	Remark
MHz	dB	dB/m	dB	dBμV	dBμV/m	dBμV/m	dB	
2483.500	2.35	30.38	31.47	35.90	37.16	54.00	-16.84	AVG
2485.625	2.36	30.38	31.47	36.49	37.76	54.00	-16.24	AVG

Anbotek

Test Mode: 802.11n (HT20)
2462MHz
Vertical-PEAK:

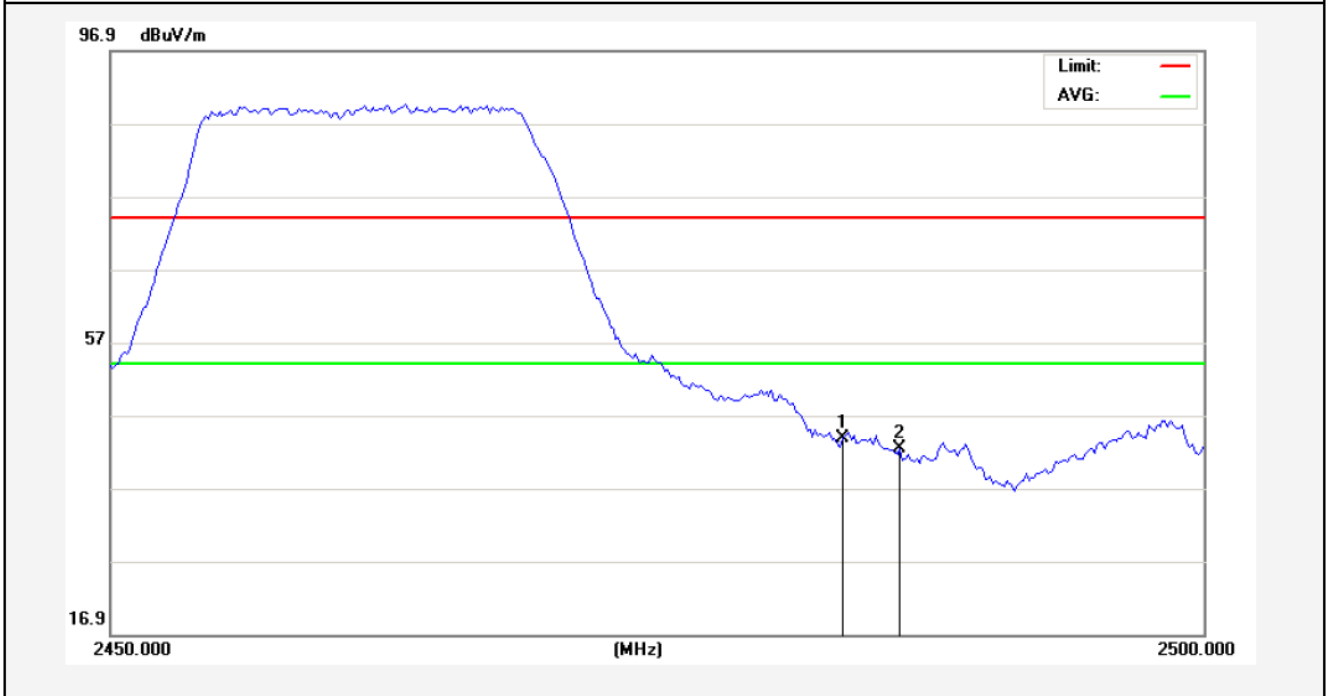

Frequency	CableLoss	AntFactor	PreampFactor	ReadLevel	Level	Limit	Over Limit	Remark
MHz	dB	dB/m	dB	dBμV	dBμV/m	dBμV/m	dB	
2483.500	2.35	30.38	31.47	42.55	43.81	74.00	-30.19	Peak
2486.125	2.37	30.38	31.47	41.14	42.42	74.00	-31.58	Peak

A M U

Vertical-AV:

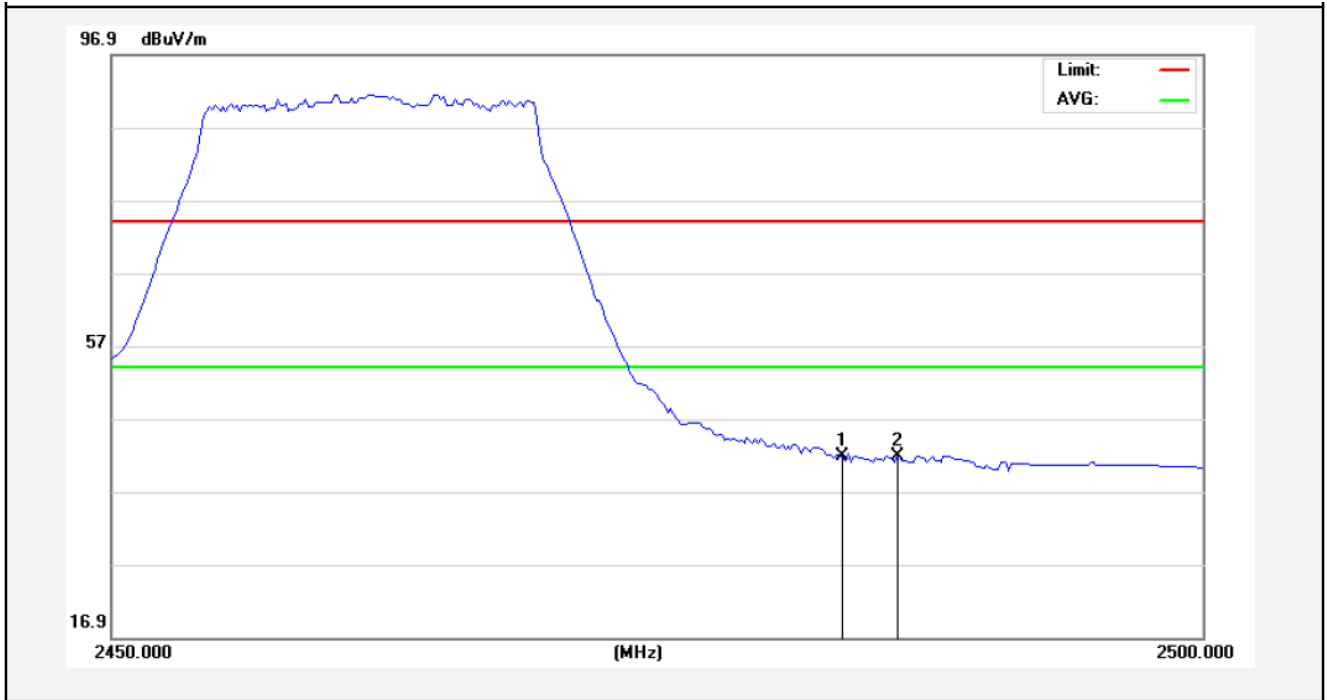

Frequency	CableLoss	AntFactor	PreamplFactor	ReadLevel	Level	Limit	Over Limit	Remark
MHz	dB	dB/m	dB	dBμV	dBμV/m	dBμV/m	dB	
2483.500	2.35	30.38	31.47	40.54	41.80	54.00	-12.20	AVG
2486.000	2.37	30.38	31.47	40.62	41.90	54.00	-12.10	AVG

Anbotek

Test Mode: 802.11n (HT40)

2422MHz

Horizontal-PEAK:

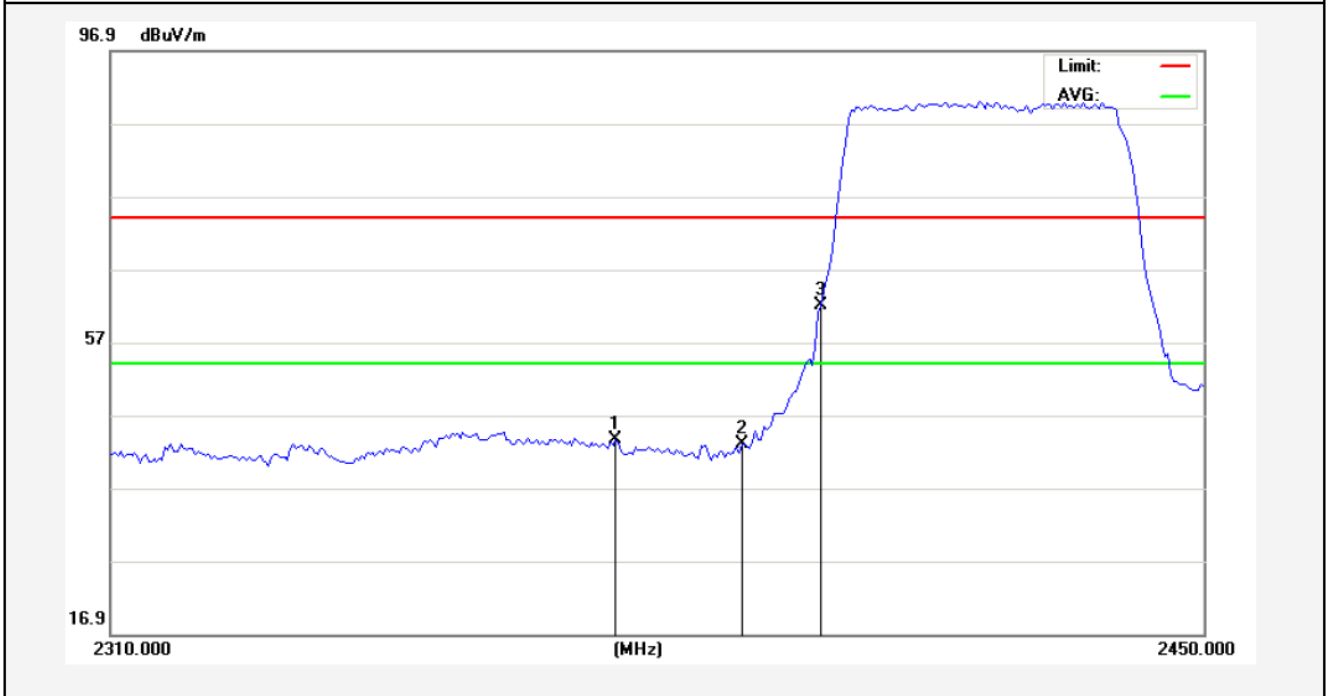

Frequency	CableLoss	AntFactor	PreampFactor	ReadLevel	Level	Limit	Over Limit	Remark
MHz	dB	dB/m	dB	dBuV	dBuV/m	dBuV/m	dB	
2374.050	2.17	30.38	31.47	42.57	43.65	74.00	-30.35	Peak
2390.000	2.21	30.38	31.47	41.88	43.00	74.00	-31.00	Peak
2400.000	2.22	30.38	31.47	60.89	62.02	74.00	-11.98	Peak

A M E

Horizontal-AV:

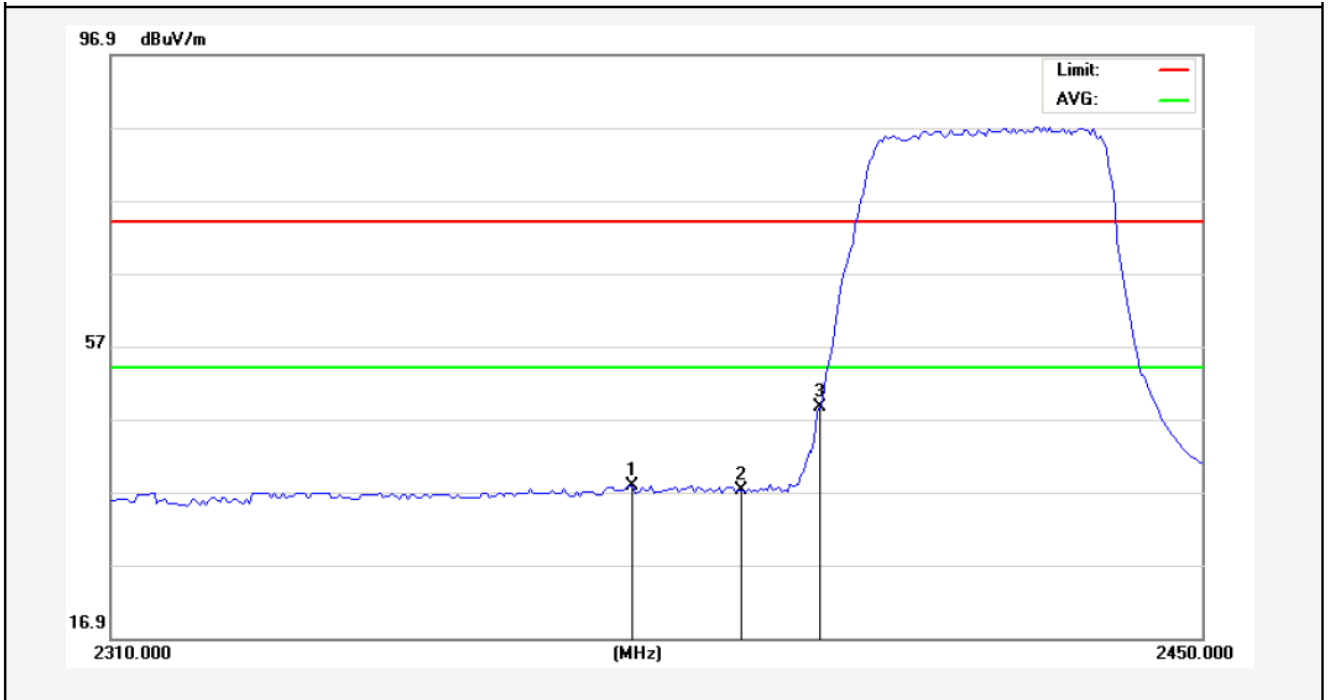

Frequency	CableLoss	AntFactor	Preamplifier	ReadLevel	Level	Limit	Over Limit	Remark
MHz	dB	dB/m	dB	dBμV	dBμV/m	dBμV/m	dB	
2376.150	2.19	30.38	31.47	36.68	37.78	54.00	-16.22	AVG
2390.000	2.21	30.38	31.47	36.02	37.14	54.00	-16.86	AVG
2400.000	2.22	30.38	31.47	47.52	48.65	54.00	-5.35	AVG

Anbotek

Test Mode: 802.11n (HT40)

2422MHz

Vertical-PEAK:

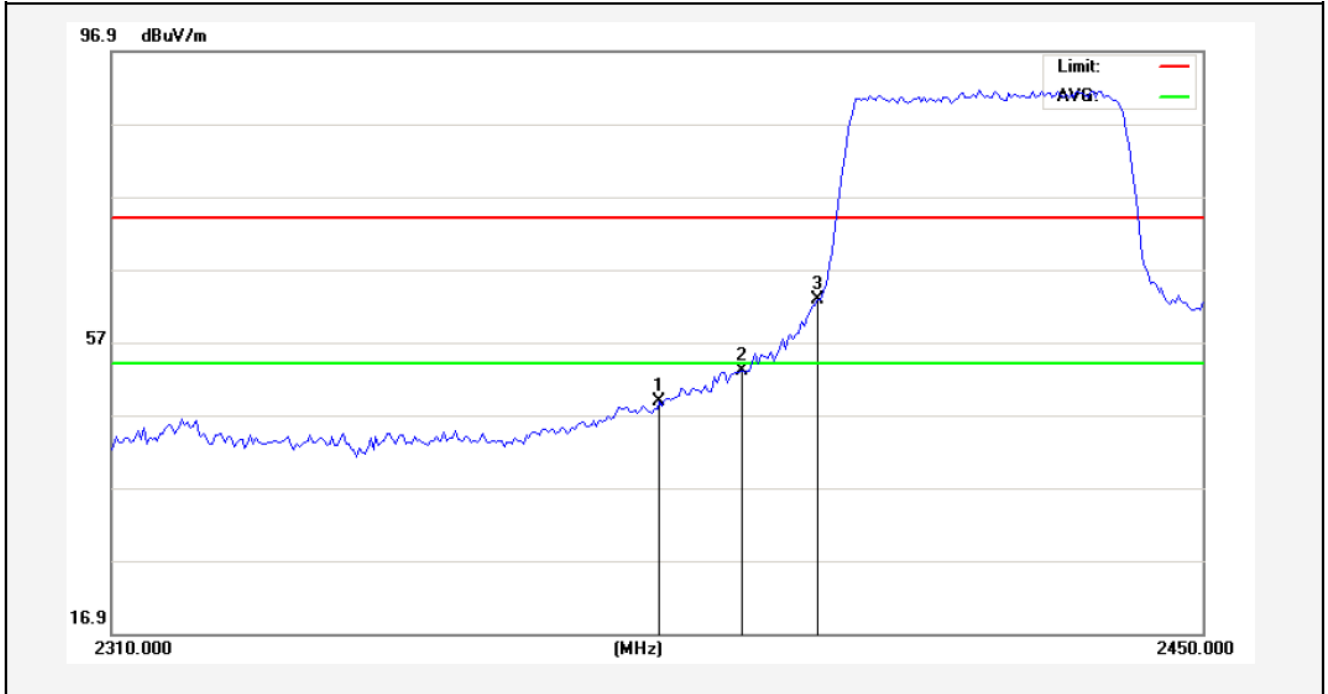

Frequency	CableLoss	AntFactor	PreampFactor	ReadLevel	Level	Limit	Over Limit	Remark
MHz	dB	dB/m	dB	dB μ V	dB μ V/m	dB μ V/m	dB	
2379.650	2.20	30.38	31.47	47.71	48.82	74.00	-25.18	Peak
2390.000	2.21	30.38	31.47	51.83	52.95	74.00	-21.05	Peak
2400.000	2.22	30.38	31.47	61.60	62.73	74.00	-11.27	Peak

A M I

Vertical-AV:

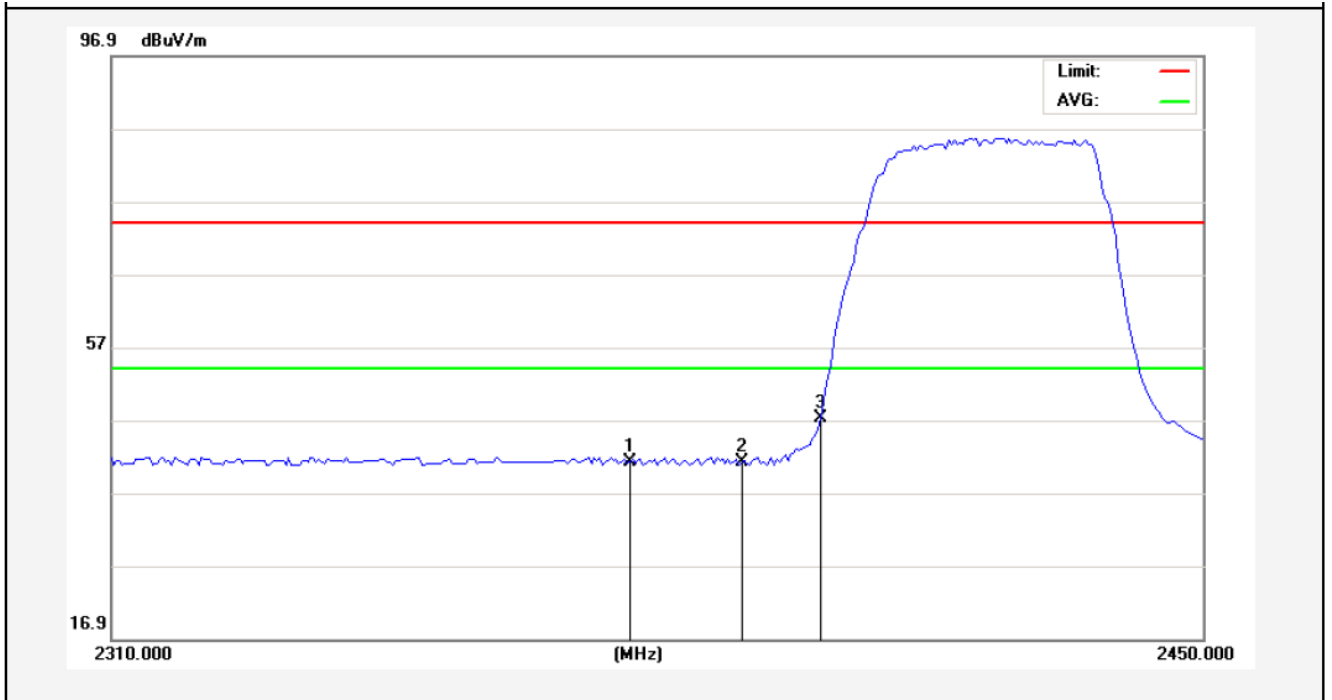

Frequency	CableLoss	AntFactor	Preamplifier	ReadLevel	Level	Limit	Over Limit	Remark
MHz	dB	dB/m	dB	dBμV	dBμV/m	dBμV/m	dB	
2375.800	2.18	30.38	31.47	40.20	41.29	54.00	-12.71	AVG
2390.000	2.21	30.38	31.47	40.01	41.13	54.00	-12.87	AVG
2400.000	2.22	30.38	31.47	46.04	47.17	54.00	-6.83	AVG

AVG

Test Mode: 802.11n (HT40)

2452MHz

Horizontal-PEAK:

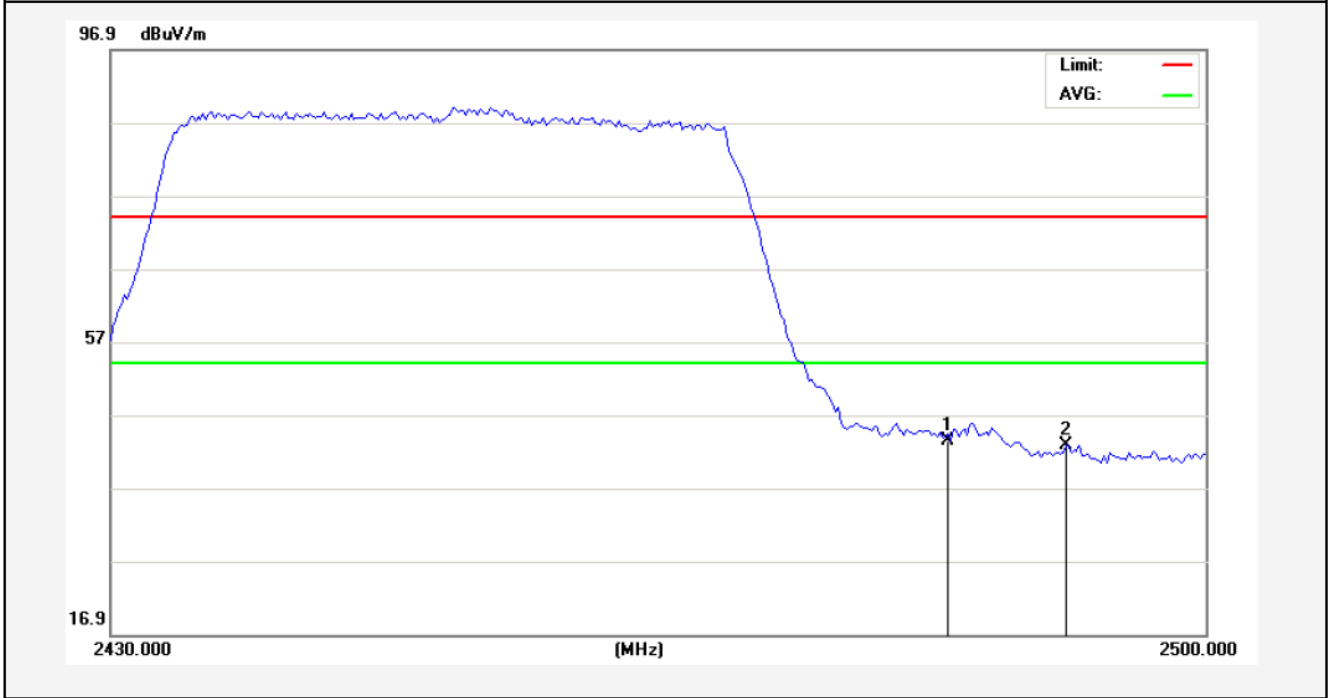

Frequency	CableLoss	AntFactor	PreampFactor	ReadLevel	Level	Limit	Over Limit	Remark
MHz	dB	dB/m	dB	dBμV	dBμV/m	dBμV/m	dB	
2483.500	2.35	30.38	31.47	42.16	43.42	74.00	-30.58	Peak
2491.075	2.41	30.38	31.47	41.45	42.77	74.00	-31.23	Peak

Anbotek

Horizontal-AV:

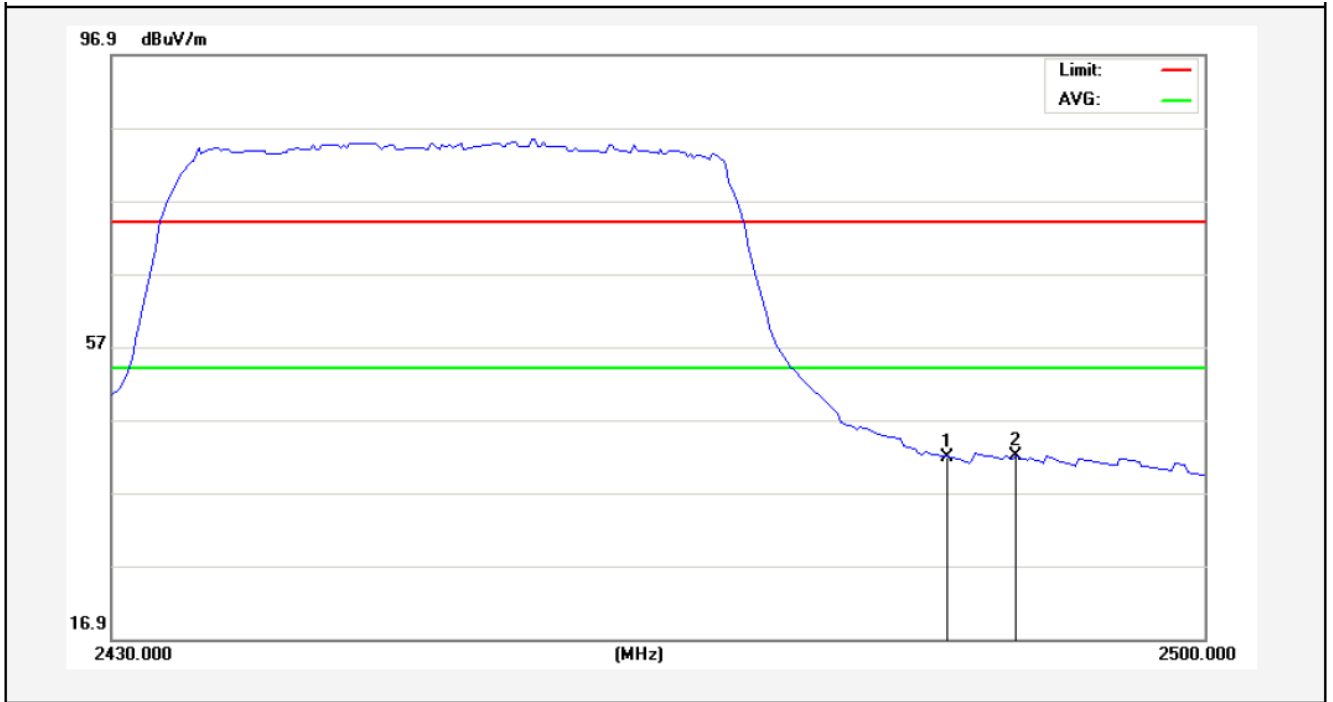

Frequency	CableLoss	AntFactor	Preamplifier	ReadLevel	Level	Limit	Over Limit	Remark
MHz	dB	dB/m	dB	dBμV	dBμV/m	dBμV/m	dB	
2483.500	2.35	30.38	31.47	40.63	41.89	54.00	-12.11	AVG
2487.925	2.37	30.38	31.47	40.68	41.96	54.00	-12.04	AVG

Anbotek

Test Mode: 802.11n (HT40)
2452MHz
Vertical-PEAK:

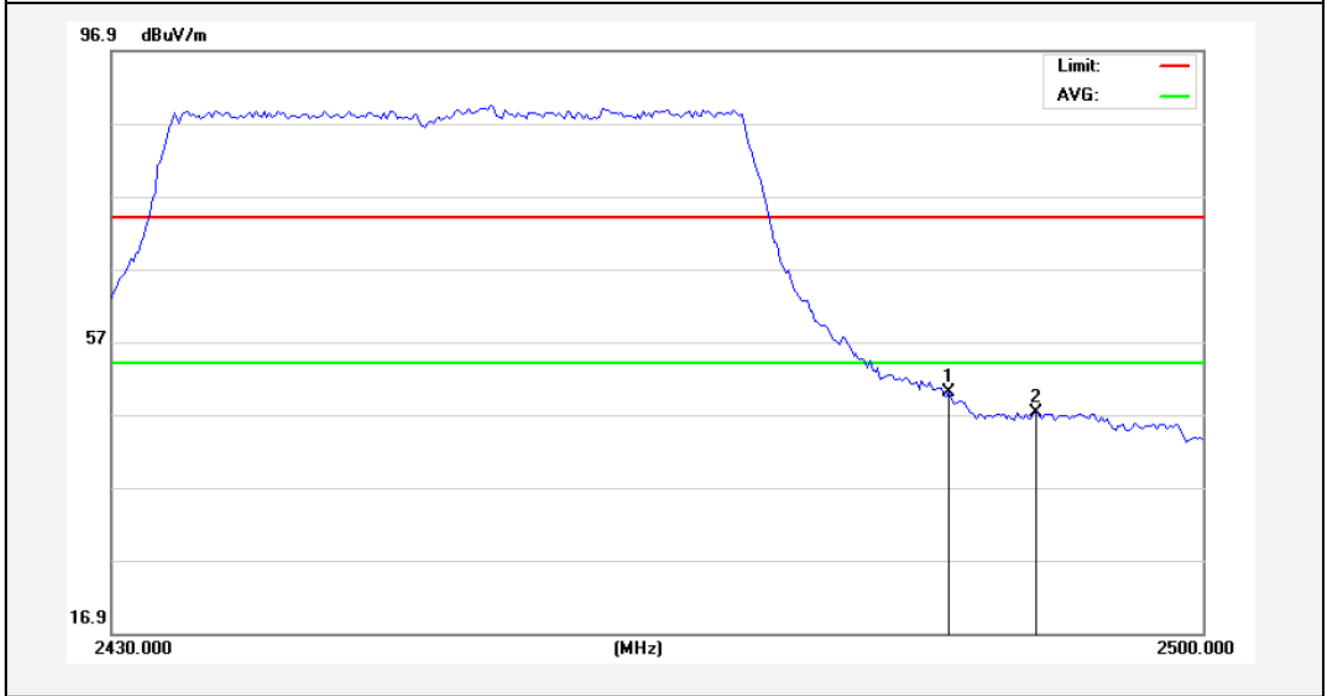

Frequency	CableLoss	AntFactor	Preamplifier	ReadLevel	Level	Limit	Over Limit	Remark
MHz	dB	dB/m	dB	dBμV	dBμV/m	dBμV/m	dB	
2483.500	2.35	30.38	31.47	48.74	50.00	74.00	-24.00	Peak
2489.325	2.39	30.38	31.47	45.82	47.12	74.00	-26.88	Peak

A.M.D.

Vertical-AV:

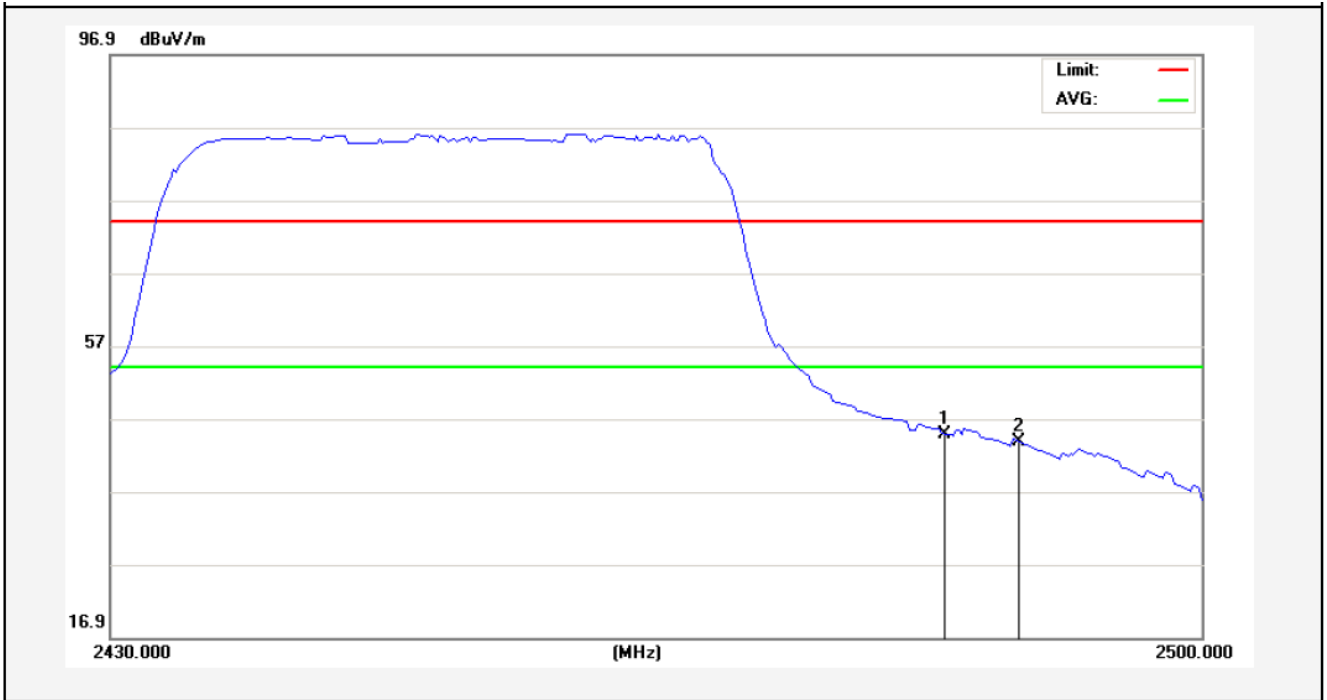

Frequency	CableLoss	AntFactor	Preamplifier	ReadLevel	Level	Limit	Over Limit	Remark
MHz	dB	dB/m	dB	dBμV	dBμV/m	dBμV/m	dB	
2483.500	2.35	30.38	31.47	43.53	44.79	54.00	-9.21	AVG
2488.275	2.38	30.38	31.47	42.53	43.82	54.00	-10.18	AVG

Anbotek

4.5. Peak Power Spectral Density

a. Limit

1. For direct sequence systems, the peak power spectral density conducted from the intentional radiator to the antenna shall not be greater than 8dBm in any 3kHz band during any time interval of continuous transmission.
2. The direct sequence operating of the hybrid system, with the frequency hopping operation turned off, shall comply with the power density requirements of paragraph (d) of this section.

b. Test Procedure

1. Place the EUT on the table and set it in transmitting mode. Remove the antenna from the EUT and then connect a low loss RF cable from the antenna port to the spectrum analyzer.
2. Set the spectrum analyzer as RBW = 3.0kHz, VBW = 10kHz, Span = 1.5xDTS BW
3. Record the max. reading.
4. Repeat the above procedure until the measurements for all frequencies are completed.

c. Test Equipment

Same as the equipment listed in 4.2.

d. Test Setup

See 4.1

e. Test Results

Pass

f. Test Data

Please refer to the following data.

g. Test Plot

See the following pages

Test mode: IEEE 802.11b

Channel	Frequency (MHz)	PPSD (dBm/3KHz)	∑PPSD (dBm/3KHz)	Limit (dBm)	Result
Low	2412	-15.042	-	8.00	Pass
Mid	2437	-15.680	-		Pass
High	2462	-15.438	-		Pass

Test mode: IEEE 802.11g

Channel	Frequency (MHz)	PPSD (dBm)	∑PPSD (dBm)	Limit (dBm)	Result
Low	2412	-18.796	-	8.00	Pass
Mid	2437	-19.493	-		Pass
High	2462	-19.527	-		Pass

Test mode: IEEE 802.11n (HT20)

Channel	Frequency (MHz)	PPSD (dBm/3KHz)	∑PPSD (dBm/3KHz)	Limit (dBm)	Result
Low	2412	-18.725	-	8.00	Pass
Mid	2437	-19.300	-		Pass
High	2462	-18.787	-		Pass

Test mode: IEEE 802.11n (HT40)

Channel	Frequency (MHz)	PPSD (dBm/3KHz)	∑PPSD (dBm/3KHz)	Limit (dBm)	Result
Low	2422	-22.026	-	8.00	Pass
Mid	2437	-22.298	-		Pass
High	2452	-21.808	-		Pass

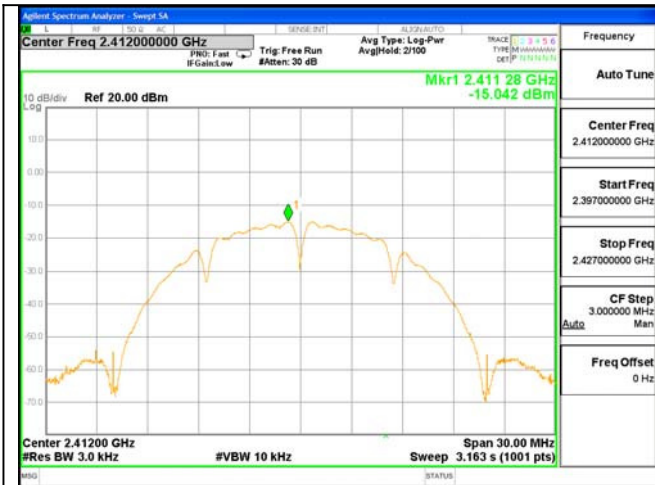

Test Mode: 802.11b---Low

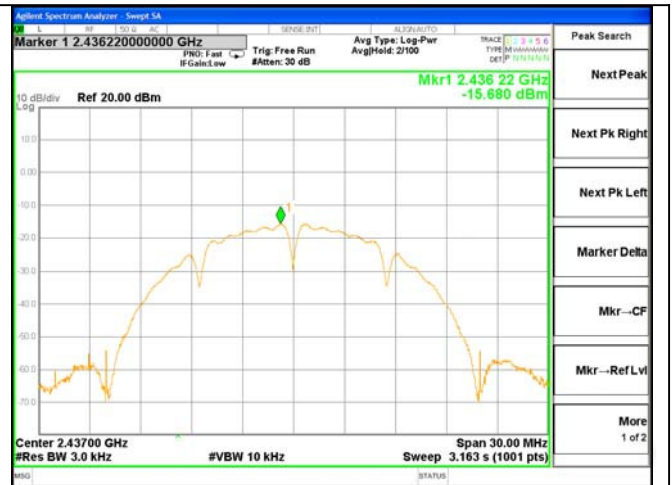

Test Mode: 802.11b---Mid



Test Mode: 802.11b---High

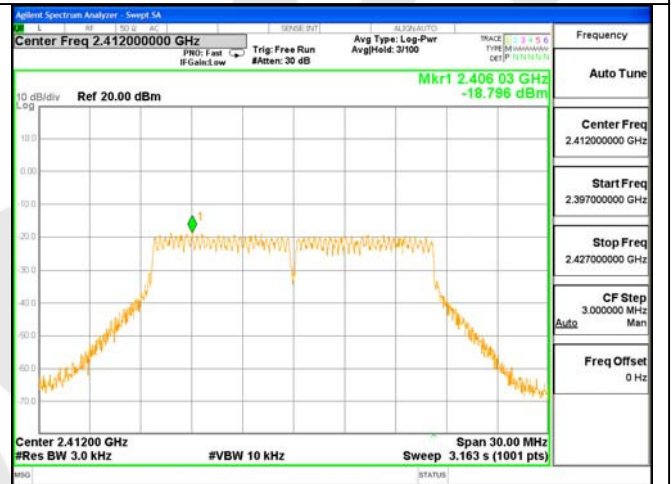

Test Mode: 802.11g---Low

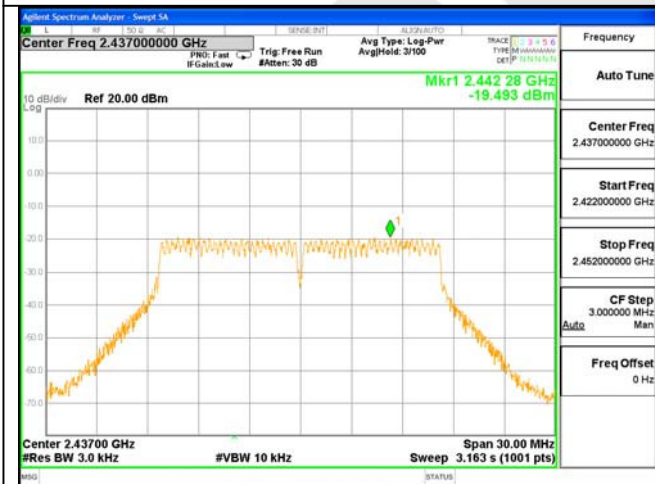

Test Mode: 802.11g---Mid

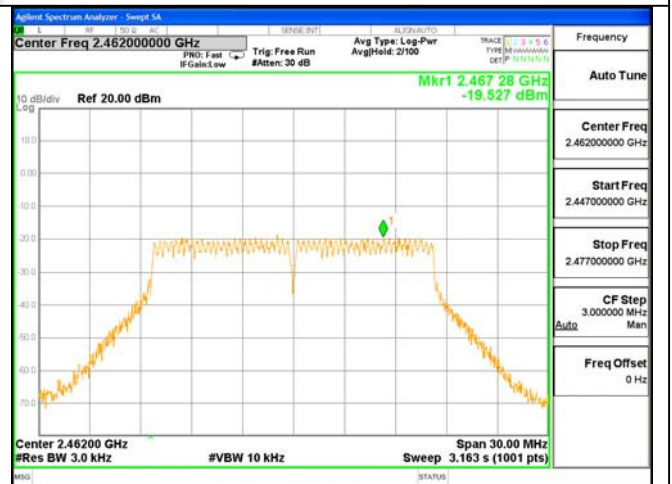

Test Mode: 802.11g---High

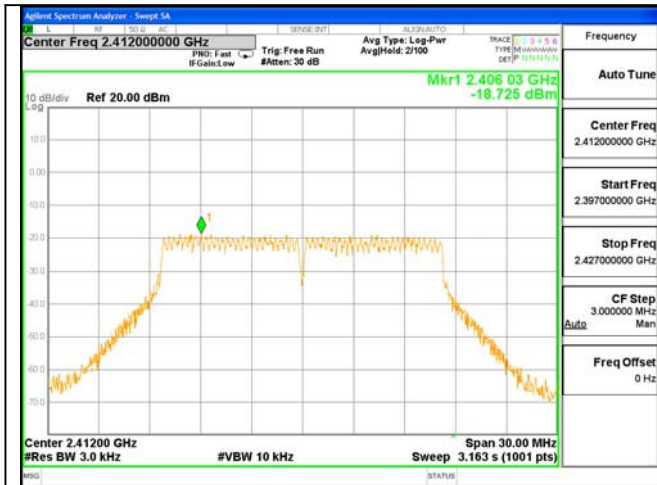

Test Mode: 802.11n20---Low

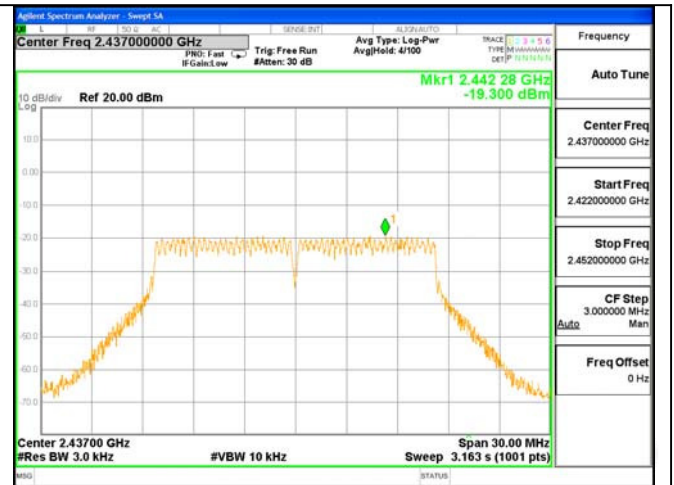

Test Mode: 802.11n20---Mid

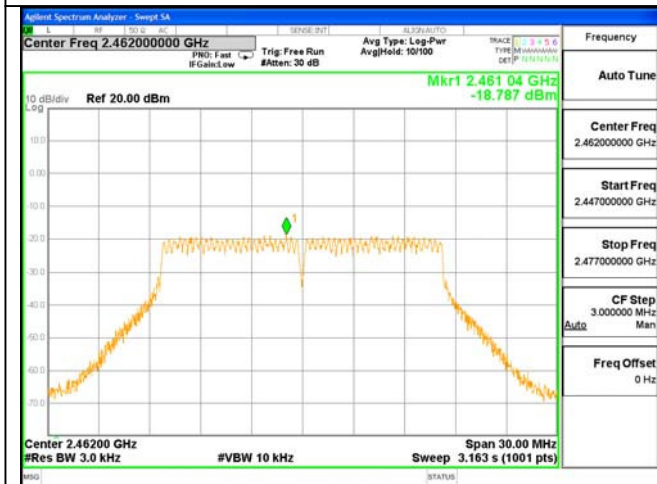

Test Mode: 802.11n20---High

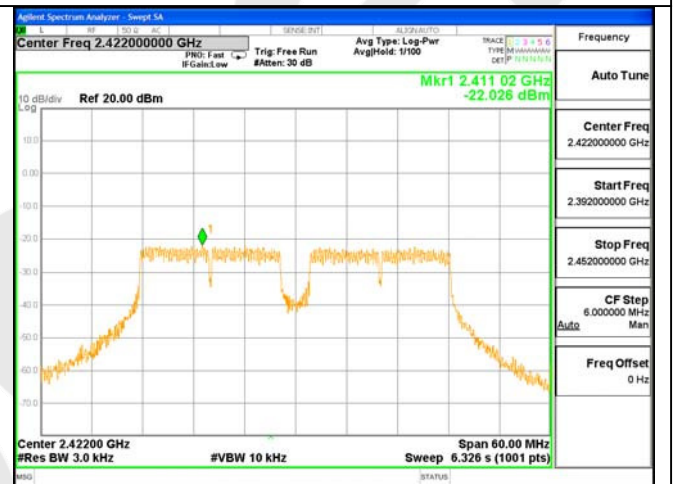

Test Mode: 802.11n40---Low

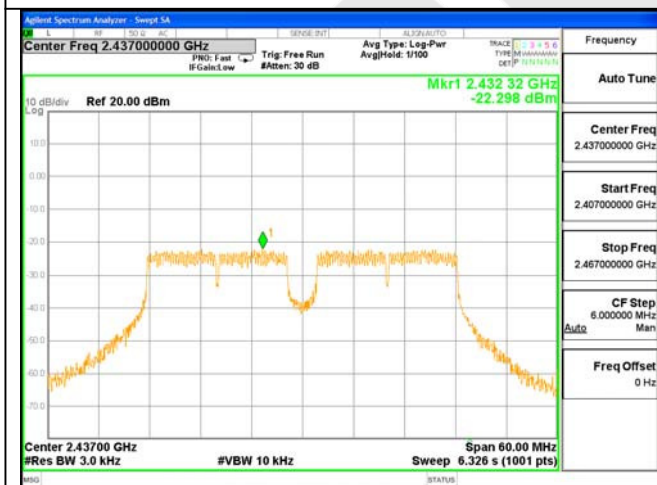

Test Mode: 802.11n40---Mid

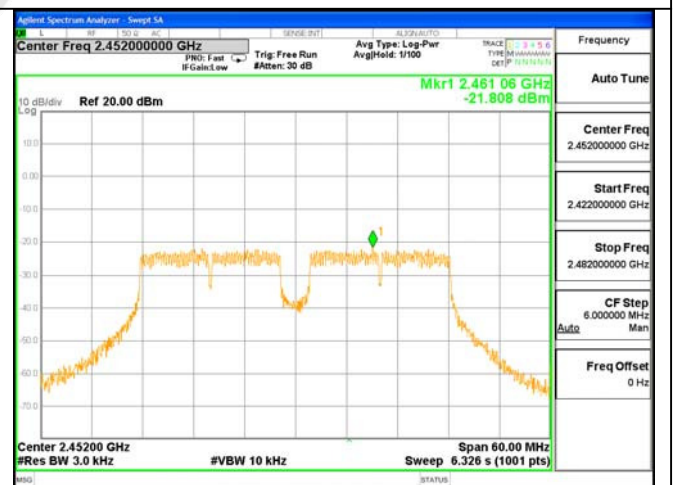

Test Mode: 802.11n40---High

4.6. Radiated Emissions

4.6.1.1. Test Limits (< 30 MHz)

Frequency (MHz)	Field Strength (microvolts/meter)	Measurement Distance (meter)
0.009-0.490	2400/F(kHz)	300
0.490-1.705	24000/F(kHz)	30
1.705-30.0	30	30

4.6.1.2. Test Limits (≥ 30 MHz)

FIELD STRENGTH of Fundamental: @3M	FIELD STRENGTH of Harmonics	S15.209	
902-928 MHz		30 - 88 MHz	40 dBuV/m
2.4-2.4835 GHz		88 - 216 MHz	43.5
94 dBμV/m @3m	54 dBμV/m @3m	216 - 960 MHz	46
		ABOVE 960 MHz	54dBuV/m

In any 100 kHz bandwidth outside the frequency band in which the spread spectrum or digitally modulated intentional radiator is operating, the radio frequency power that is produced by the intentional radiator shall be at least 20 dB below that in the 100 kHz bandwidth within the band that contains the highest level of the desired power, based on either an RF conducted or a radiated measurement. Attenuation below the general limits specified in Section 15.209(a) is not required. In addition, radiated emissions which fall in the restricted bands, as defined in Section 15.205(a), must also comply with the radiated emission limits specified in Section 15.209(a) (see Section 15.205(c)).

Test Equipment

Item	Equipment	Manufacturer	Model No.	Serial No.	Last Cal.	Cal. Interval
1.	Spectrum Analysis	Agilent	E4407B	US39390582	Apr. 16, 2016	1 Year
2.	Preamplifier	Instruments corporation	EMC011830	980100	Apr. 16, 2016	1 Year
3.	EMI Test Receiver	Rohde & Schwarz	ESPI	101604	Apr. 16, 2016	1 Year
4.	Double Ridged Horn Antenna	Instruments corporation	GTH-0118	351600	Apr. 19, 2016	1 Year
5.	Bilog Broadband Antenna	Schwarzbeck	VULB9163	VULB 9163-289	Apr. 19, 2016	1 Year
6.	Pre-amplifier	SONOMA	310N	186860	Apr. 16, 2016	1 Year
7.	EMI Test Software EZ-EMC	SHURPLE	N/A	N/A	N/A	N/A
8.	Power Sensor	DAER	RPR3006W	15100041SN046	Jun 30, 2016	1 Year
9.	MXA Spectrum Analysis	Agilent	N9020A	MY51170037	Jun 30, 2016	1 Year
10.	MXG RF Vector Signal Generator	Agilent	N5182A	MY48180656	Jun 30, 2016	1 Year
11.	Signal Generator	Agilent	E4421B	MY41000743	Jun 30, 2016	1 Year
12.	DC Power supply	IV	IV-8080	YQSB0096	Jun 30, 2016	1 Year
13.	TEMP&HUMI PROGRAMMABLE CHAMBER	Bell Group	BE-THK-15 0M8	SE-0137	Mar. 16, 2016	1 Year

4.6.2. Test Configuration:

4.6.2.1. 9k to 30MHz emissions:

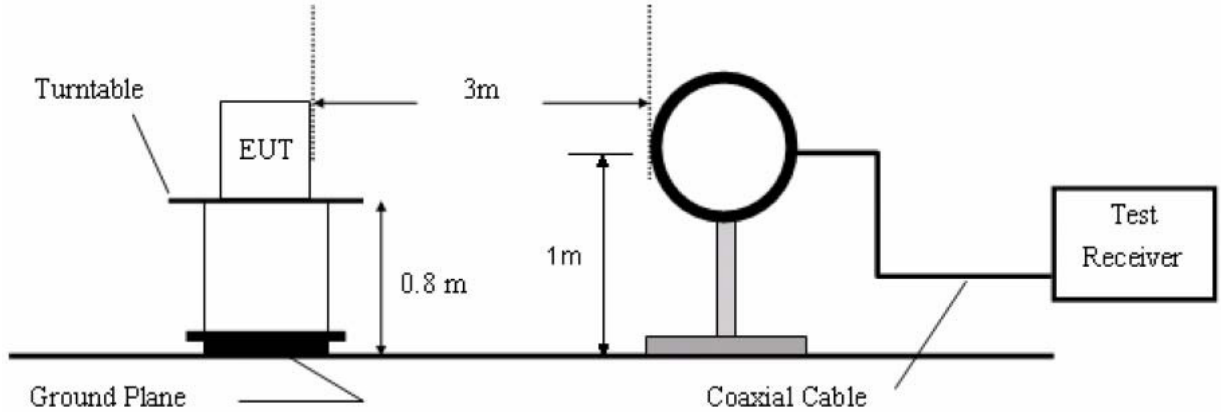

4.6.2.2. 30M to 1G emissions:

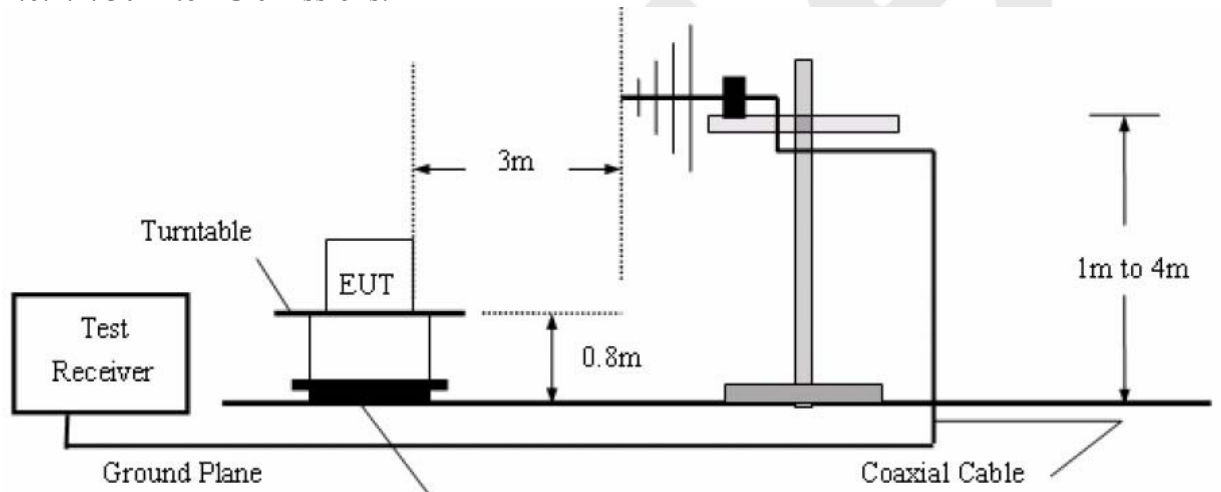

4.6.2.3. 1G to 40G emissions:

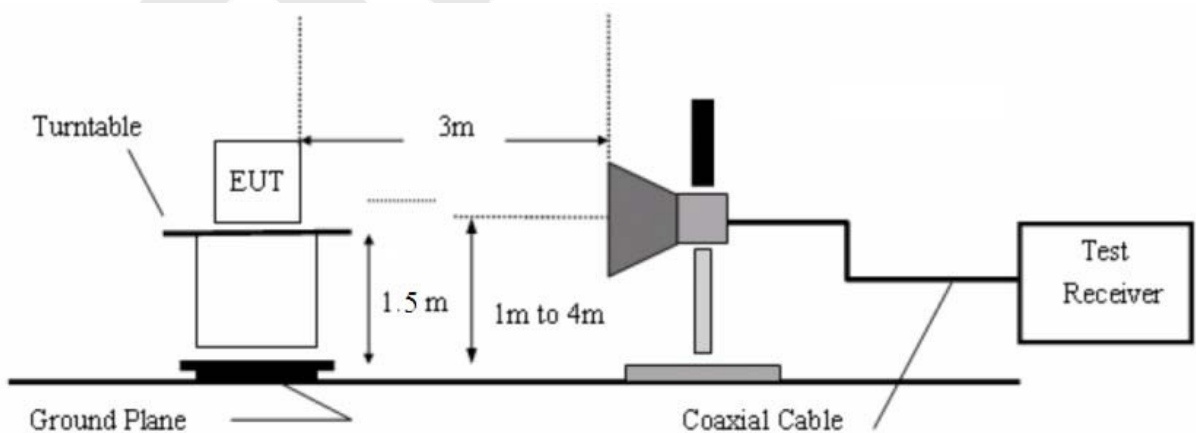

4.6.3. Test Procedure

For below 1GHz: The EUT is placed on a turntable, which is 0.8m above the ground plane.
For above 1GHz: The EUT is placed on a turntable, which is 1.5m above the ground plane.
The turn table can rotate 360 degrees to determine the position of the maximum emission level.
The EUT is set 3 meters away from the receiving antenna which is mounted on a antenna tower.
The antenna can be moved up and down from 1 to 4 meters to find out the maximum emission level. Both horizontal and vertical polarization of the antenna are set on test.

Measurements are made on 9KHz to 30MHz and 30MHz to 26GHz range with the transmitter set to the lowest, middle, and highest channels.

All readings from 30MHz to 1GHz are quasi-peak values with a resolution bandwidth of 120kHz. All reading are above 1GHz, peak & average values with a resolution bandwidth of 1MHz.

The EUT is tested in 9*6*6 Chamber. The device is evaluated in xyz orientation.

The test results are listed in Section 4.6.4.

4.6.4. Test Results

The EUT was tested on (Internet Mode, WiFi Mode) modes, only the worst data of (WiFi Mode) is attached in the following pages.
Only the worst case (x orientation).

The test results of above 18000MHz are attenuated more than 20dB below the permissible limits, so the results don't record in the report.

Job No.:	011607616I	Plarization:	Horizontal
Standard:	(RE)FCC PART15 C_3m	Power Source:	AC 120V, 60Hz for adapter
Test item:	Radiation Test	Temp.(C)/Hum. (%RH):	24.6(C)/53% RH
Test Mode:	WiFi Mode	Distance:	3m

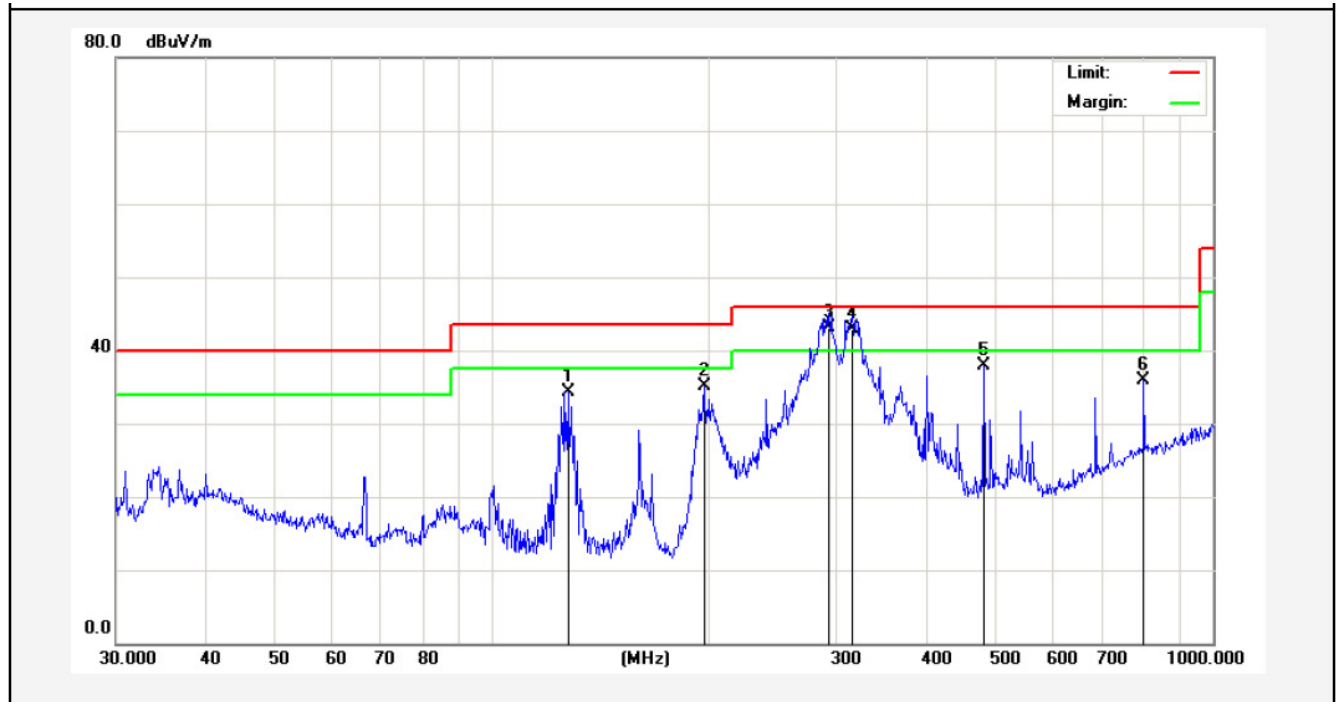

No.	Freq. (MHz)	Reading (dBuV/m)	Factor (dB/m)	Result (dBuV/m)	Limit (dBuV/)	Over Limit (dB)	Detector	Height (cm)	degree (deg)	Remark
1	127.2176	56.70	-22.40	34.30	43.50	-9.20	peak			
2	196.5098	55.98	-20.89	35.09	43.50	-8.41	peak			
3	293.0842	61.00	-17.87	43.13	46.00	-2.87	QP	300	360	
4	315.4806	58.66	-15.80	42.86	46.00	-3.14	QP	300	0	
5	480.5276	49.44	-11.53	37.91	46.00	-8.09	peak			
6	801.7863	42.46	-6.54	35.92	46.00	-10.08	peak			

Job No.:	011607616I	Plarization:	Vertical
Standard:	(RE)FCC PART15 C_3m	Power Source:	AC 120V, 60Hz for adapter
Test item:	Radiation Test	Temp.(C)/Hum.(%RH):	24.6(C)/53% RH
Test Mode:	WiFi Mode	Distance:	3m

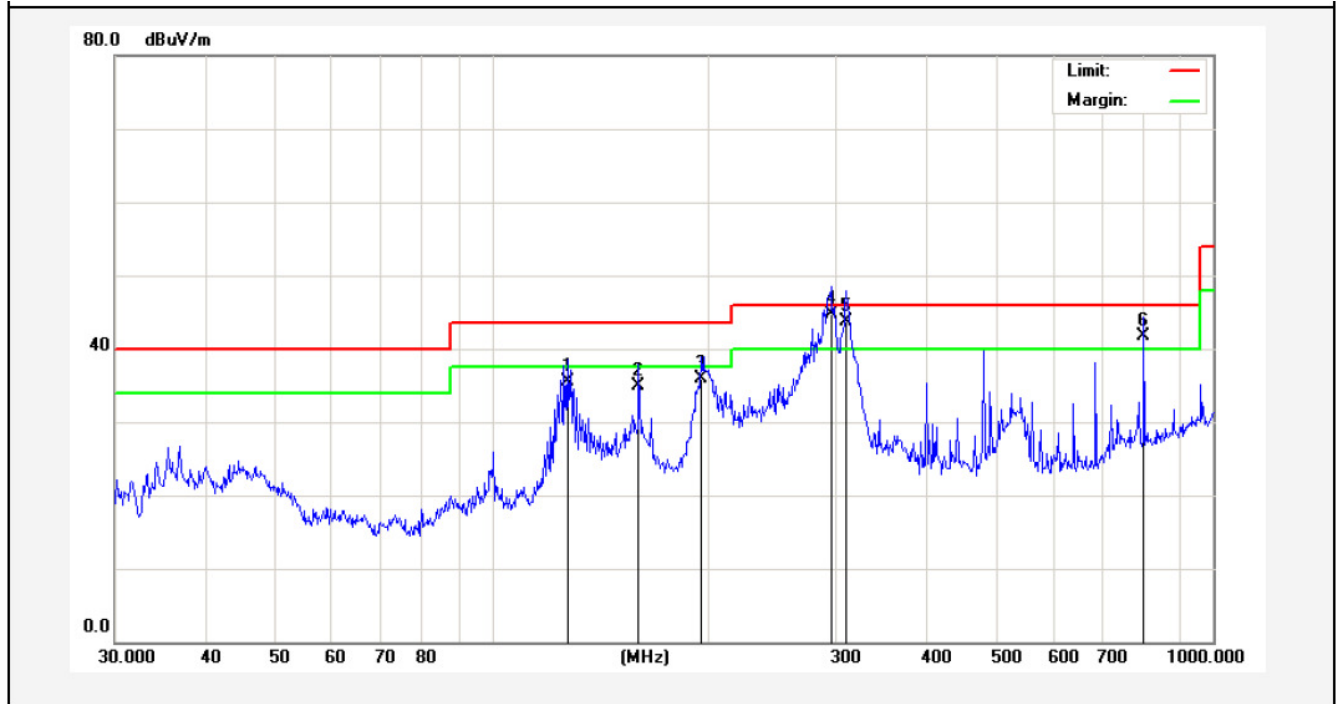

No.	Freq. (MHz)	Reading (dBuV/m)	Factor (dB/m)	Result (dBuV/m)	Limit (dBuV/)	Over Limit (dB)	Detector	Height (cm)	degree (deg)	Remark
1	127.2176	52.96	-17.40	35.56	43.50	-7.94	QP	100	360	
2	159.7844	52.75	-17.88	34.87	43.50	-8.63	QP	100	0	
3	195.1365	51.83	-15.89	35.94	43.50	-7.56	QP	100	360	
4	294.5269	59.48	-14.84	44.64	46.00	-1.36	QP	100	0	
5	309.9977	58.25	-14.47	43.78	46.00	-2.22	QP	100	360	
6	801.7863	47.19	-5.54	41.65	46.00	-4.35	QP	100	0	

Job No.:	011607616I	Plarization:	Horizontal
Standard:	(RE)FCC PART15 C _3m	Power Source:	AC 120V, 60Hz for adapter
Test item:	Radiation Test	Temp.(C)/Hum.(%RH):	24.6(C)/53% RH
Note:	802.11b(2412MHz)	Distance:	3m

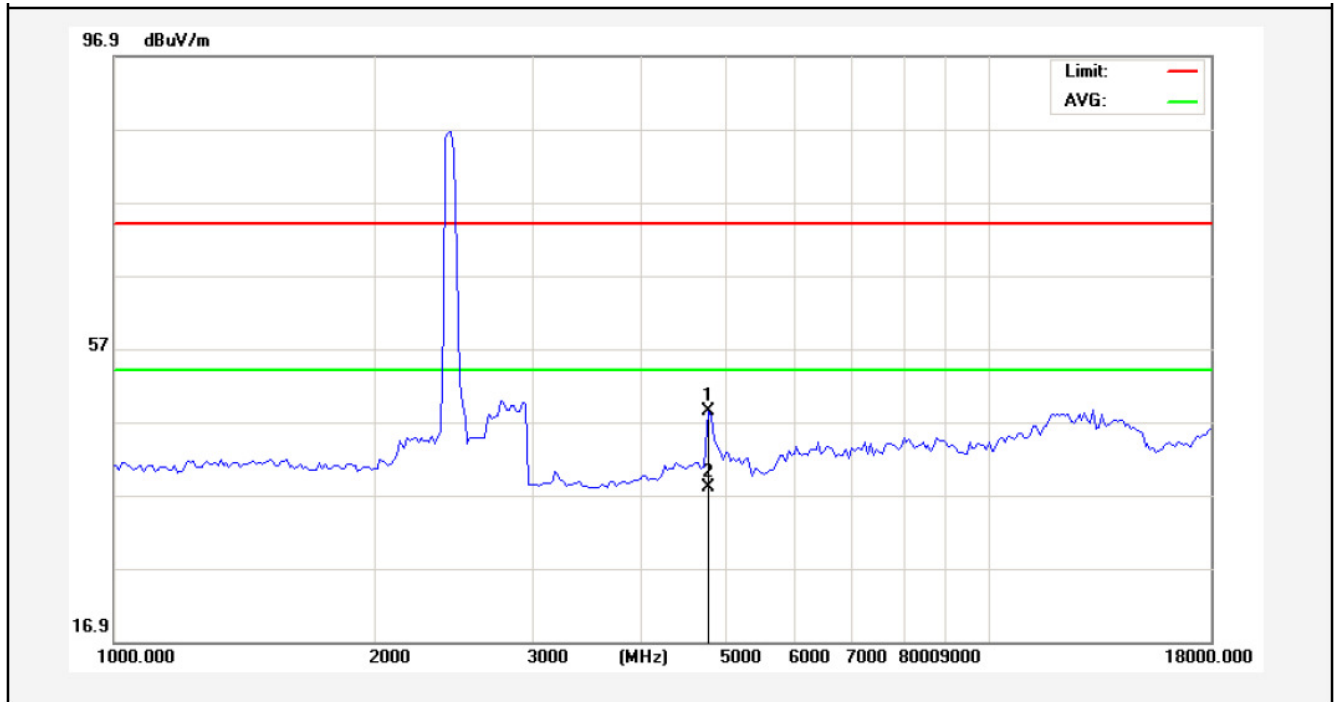

No.	Freq. (MHz)	Reading (dBuV/m)	Factor (dB/m)	Result (dBuV/m)	Limit (dBuV/)	Over Limit (dB)	Detector	Height (cm)	degree (deg)	Remark
1	4825.000	45.10	3.34	48.44	74.00	-25.56	peak			
2	4825.000	34.68	3.34	38.02	54.00	-15.98	AVG			



Job No.:	011607616I	Plarization:	Vertical
Standard:	(RE)FCC PART15 C _3m	Power Source:	AC 120V, 60Hz for adapter
Test item:	Radiation Test	Temp.(C)/Hum.(%RH):	24.6(C)/53% RH
Note:	802.11b(2412MHz)	Distance:	3m

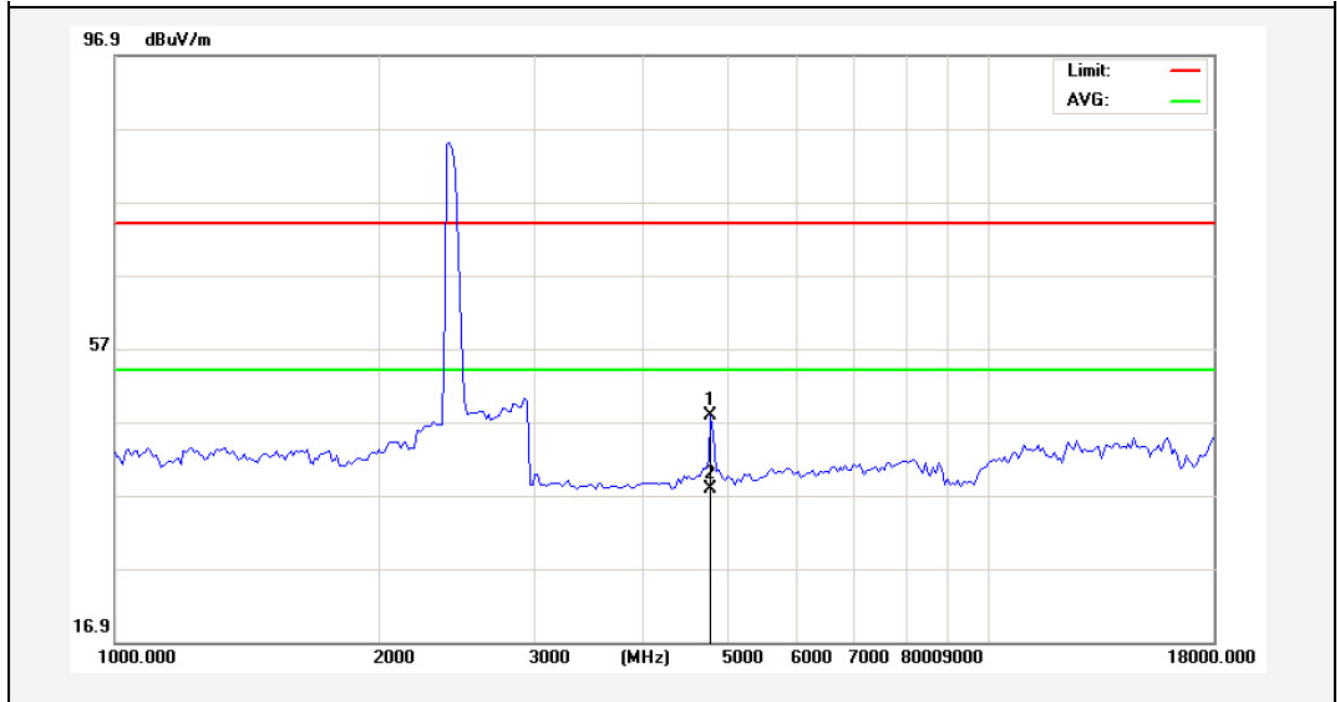

No.	Freq. (MHz)	Reading (dBuV/m)	Factor (dB/m)	Result (dBuV/m)	Limit (dBuV/)	Over Limit (dB)	Detector	Height (cm)	degree (deg)	Remark
1	4825.000	44.37	3.34	47.71	74.00	-26.29	peak			
2	4825.000	34.48	3.34	37.82	54.00	-16.18	AVG			

A M

Job No.:	011607616I	Plarization:	Horizontal
Standard:	(RE)FCC PART15 C _3m	Power Source:	AC 120V, 60Hz for adapter
Test item:	Radiation Test	Temp.(C)/Hum.(%RH):	24.6(C)/53% RH
Note:	802.11b(2437MHz)	Distance:	3m

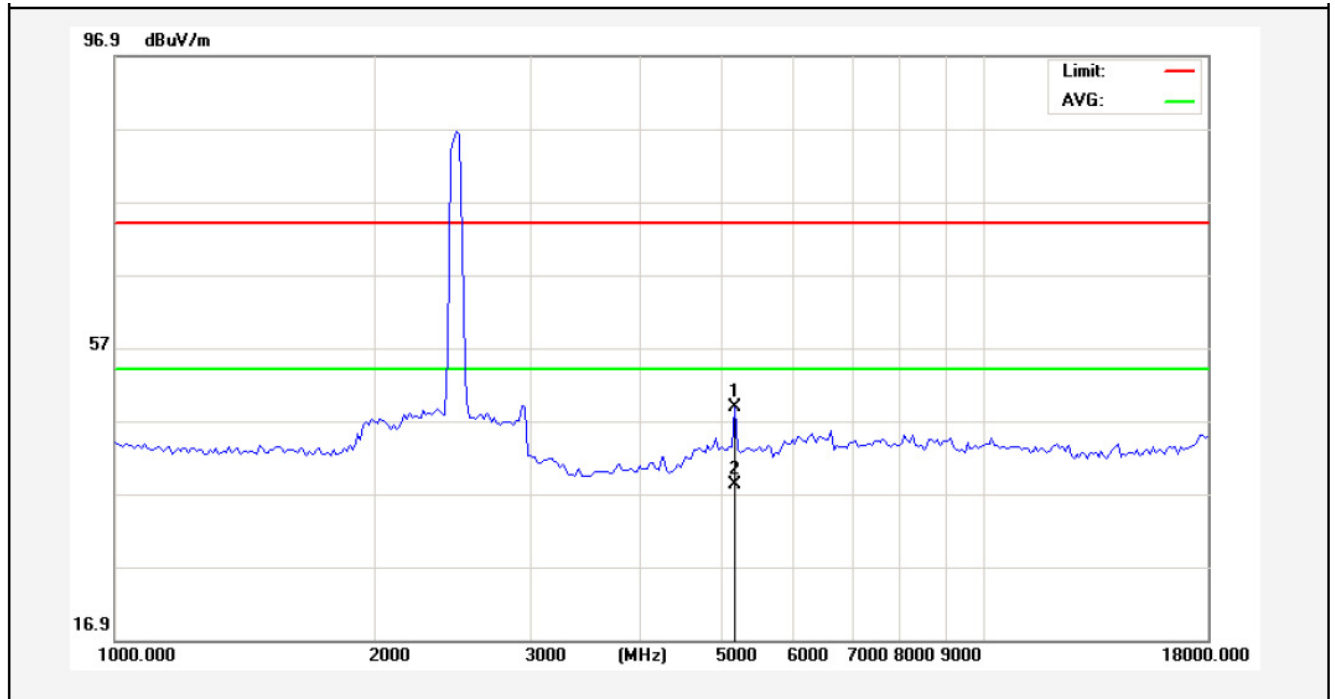

No.	Freq. (MHz)	Reading (dBuV/m)	Factor (dB/m)	Result (dBuV/m)	Limit (dBuV/)	Over Limit (dB)	Detector	Height (cm)	degree (deg)	Remark
1	5165.000	45.04	3.76	48.80	74.00	-25.20	peak			
2	5165.000	34.36	3.76	38.12	54.00	-15.88	AVG			

Job No.:	011607616I	Plarization:	Vertical
Standard:	(RE)FCC PART15 C _3m	Power Source:	AC 120V, 60Hz for adapter
Test item:	Radiation Test	Temp.(C)/Hum.(%RH):	24.6(C)/53% RH
Note:	802.11b(2437MHz)	Distance:	3m

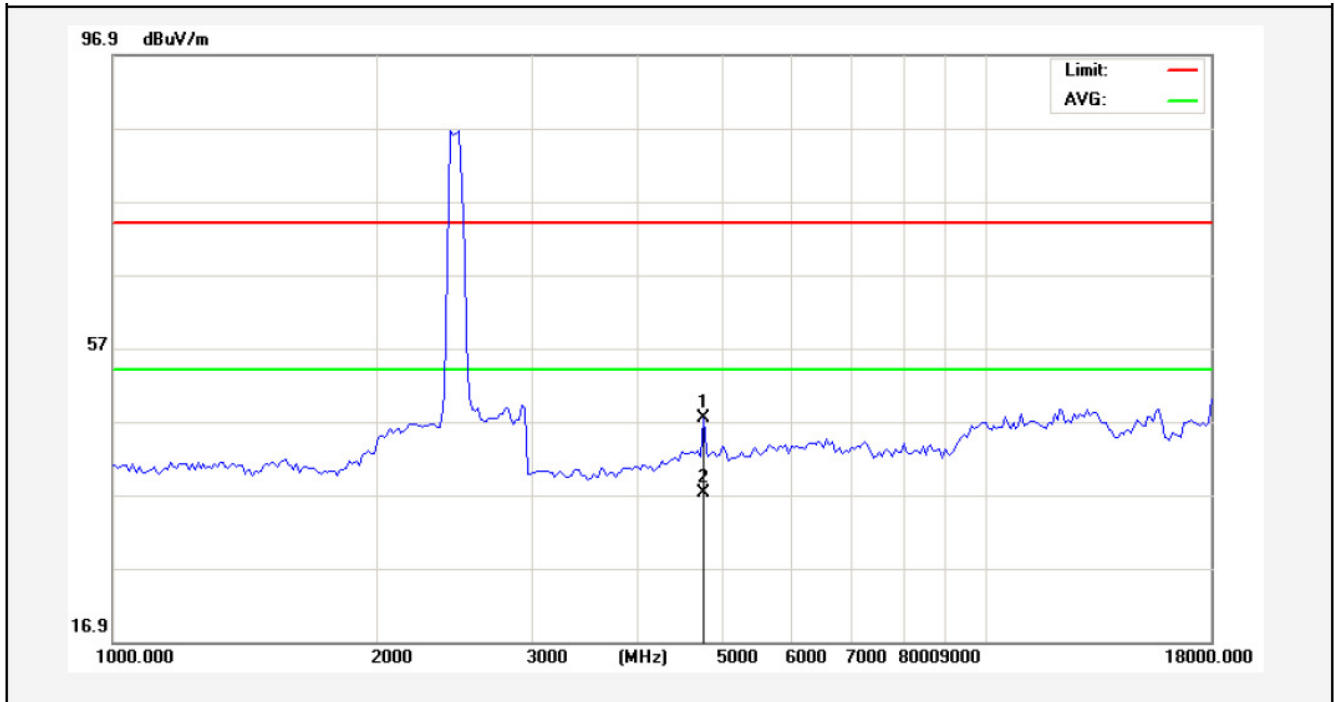

No.	Freq. (MHz)	Reading (dBuV/m)	Factor (dB/m)	Result (dBuV/m)	Limit (dBuV/)	Over Limit (dB)	Detector	Height (cm)	degree (deg)	Remark
1	4740.000	44.19	3.19	47.38	74.00	-26.62	peak			
2	4740.000	34.04	3.19	37.23	54.00	-16.77	AVG			



Job No.:	011607616I	Plarization:	Horizontal
Standard:	(RE)FCC PART15 C_3m	Power Source:	AC 120V, 60Hz for adapter
Test item:	Radiation Test	Temp.(C)/Hum.(% RH):	24.6(C)/53% RH
Note:	802.11b(2462MHz)	Distance:	3m

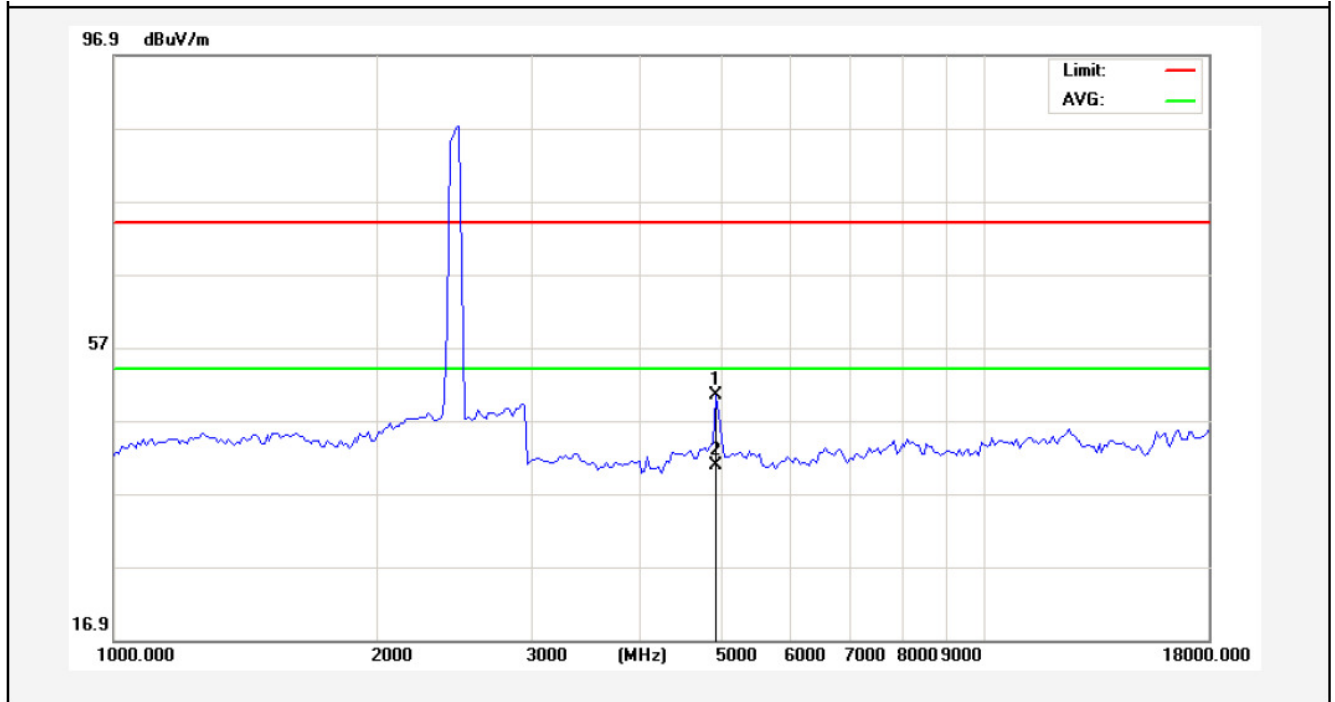

No.	Freq. (MHz)	Reading (dBuV/m)	Factor (dB/m)	Result (dBuV/m)	Limit (dBuV/)	Over Limit (dB)	Detector	Height (cm)	degree (deg)	Remark
1	4910.000	46.87	3.49	50.36	74.00	-23.64	peak			
2	4910.000	37.35	3.49	40.84	54.00	-13.16	AVG			



Job No.:	011607616I	Plarization:	Vertical
Standard:	(RE)FCC PART15 C _3m	Power Source:	AC 120V, 60Hz for adapter
Test item:	Radiation Test	Temp.(C)/Hum.(% RH):	24.6(C)/53% RH
Note:	802.11b(2462MHz)	Distance:	3m

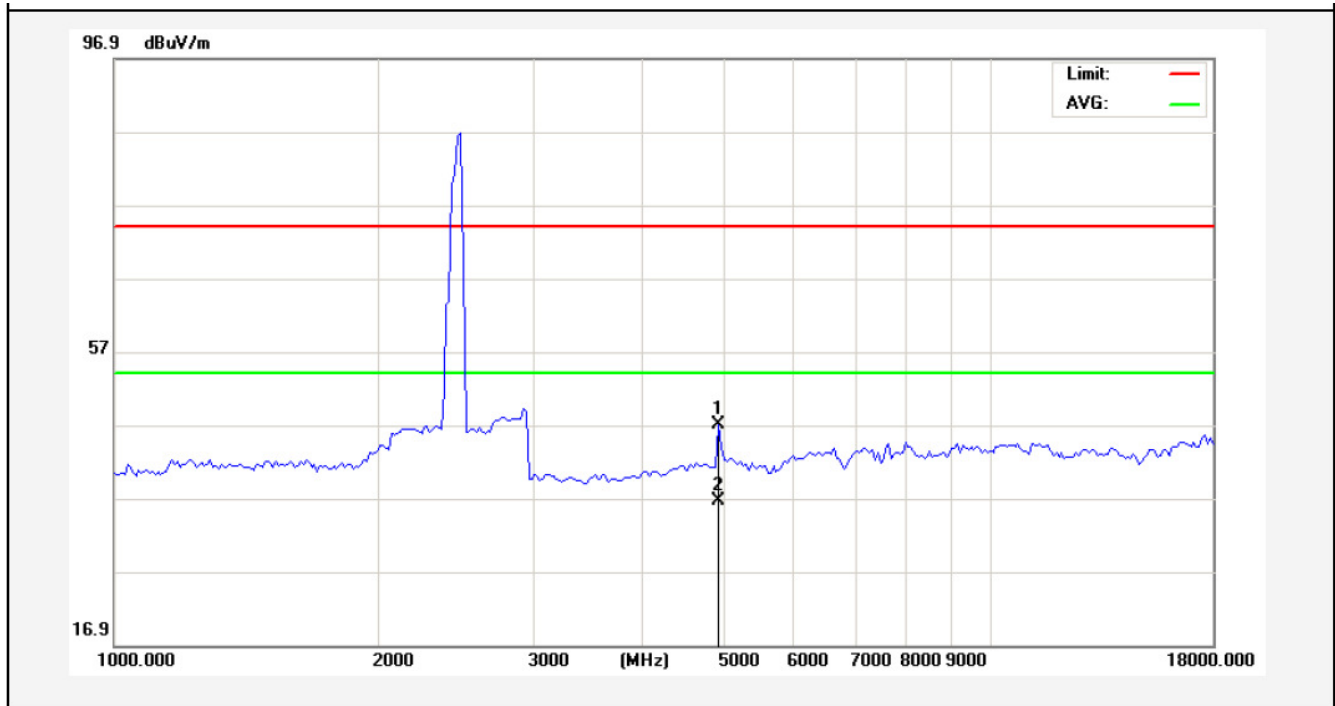

No.	Freq. (MHz)	Reading (dBuV/m)	Factor (dB/m)	Result (dBuV/m)	Limit (dBuV/)	Over Limit (dB)	Detector	Height (cm)	degree (deg)	Remark
1	4902.300	43.46	3.48	46.94	74.00	-27.06	peak			
2	4902.300	33.16	3.48	36.64	54.00	-17.36	AVG			

AEM

5. ANTENNA APPLICATION

5.1. Antenna requirement

The EUT'S antenna is met the requirement of FCC part 15C section 15.203.

An intentional radiator shall be designed to ensure that no antenna other than that furnished by the responsible party shall be used with the device. The use of a permanently attached antenna or of an antenna that uses a unique coupling to the intentional radiator shall be considered sufficient to comply with the provisions of this section. The manufacturer may design the unit so that a broken antenna can be replaced by the user, but the use of a standard antenna jack or electrical connector is prohibited. This requirement does not apply to carrier current devices or to devices operated under the provisions of §15.211, §15.213, §15.217, §15.219, or §15.221. Further, this requirement does not apply to intentional radiators that must be professionally installed, such as perimeter protection systems and some field disturbance sensors, or to other intentional radiators which, in accordance with §15.31(d), must be measured at the installation site. However, the installer shall be responsible for ensuring that the proper antenna is employed so that the limits in this part are not exceeded.

5.2. Result

The EUT's antenna used a integrated antenna which is permanently attached, The antenna's gain is 5dBi and meets the requirement.

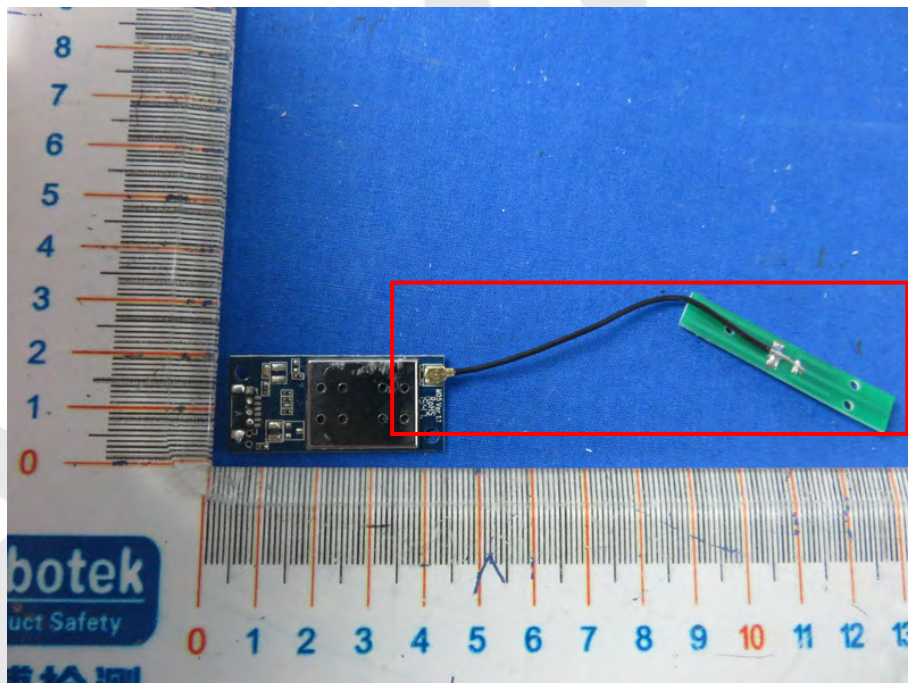

6. PHOTOGRAPH

6.1. Photo of Conducted Emission Measurement



6.2. Photo of Radiation Emission Test



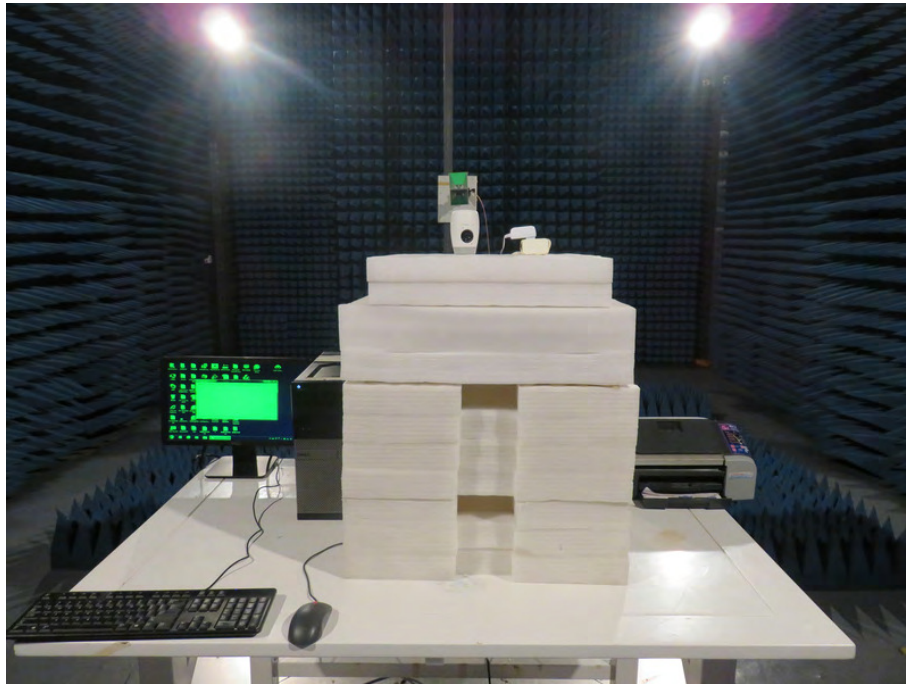

Anbotek

APPENDIX I (EXTERNAL PHOTOS)

1. Figure
The EUT-Overall View



2. Figure
The EUT-Top View

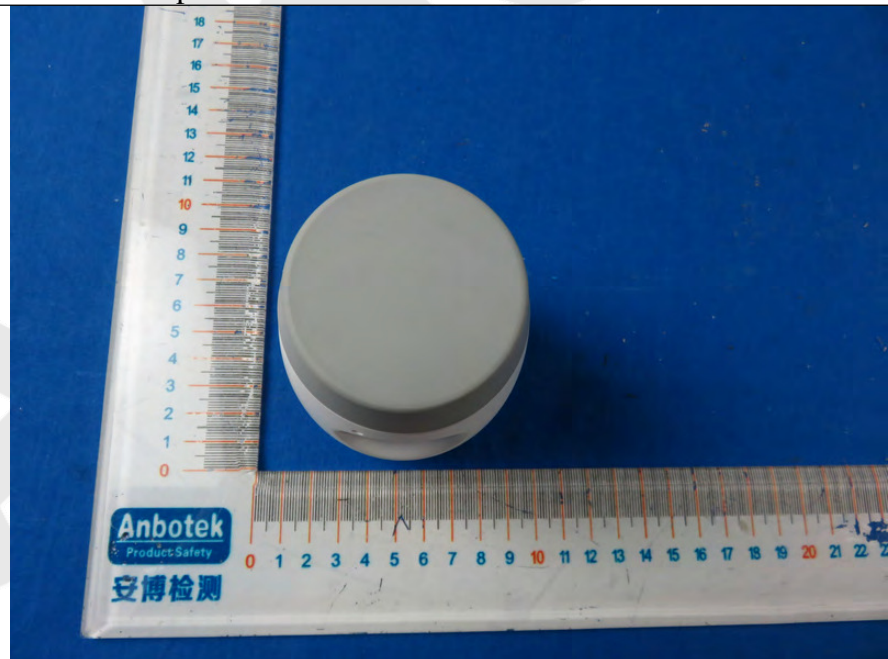

3. Figure
The EUT-Bottom View



4. Figure
The EUT-Front View

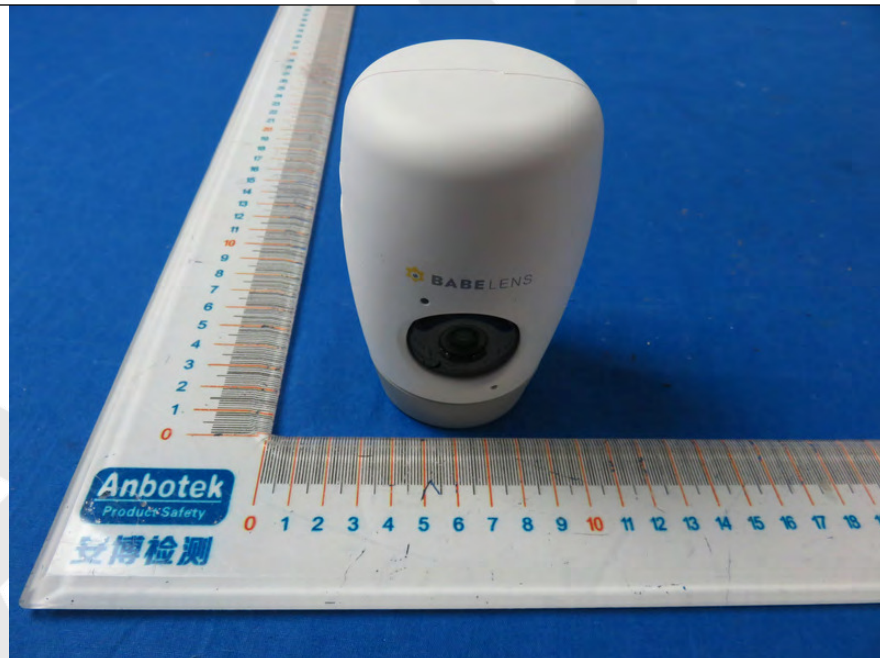

5. Figure
The EUT-Back View



6. Figure
The EUT-Right View



7. Figure
The EUT-Left View

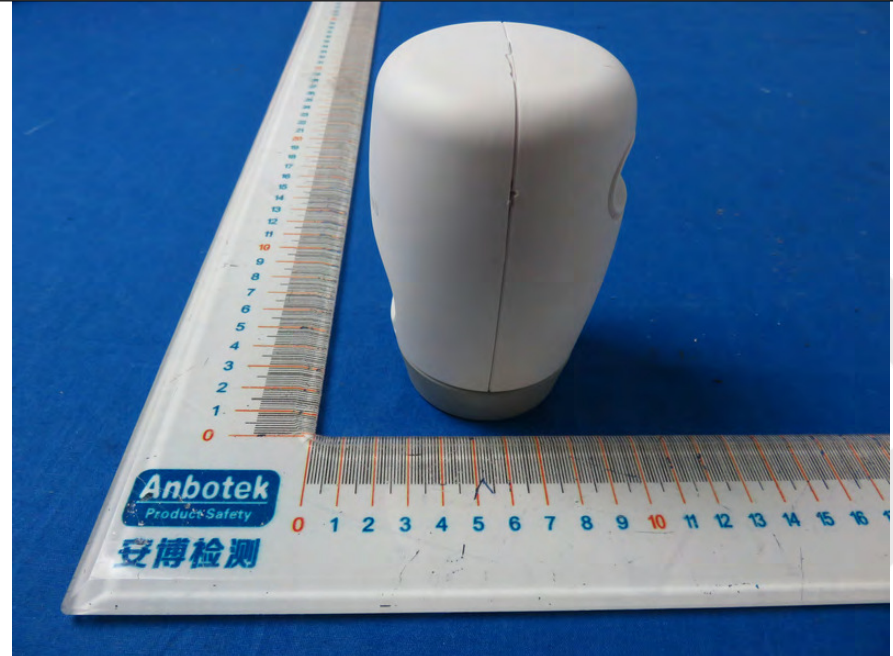

APPENDIX II (INTERNAL PHOTOS)

1. Figure
The EUT-Inside View



2. Figure
PCB of the EUT-Front View

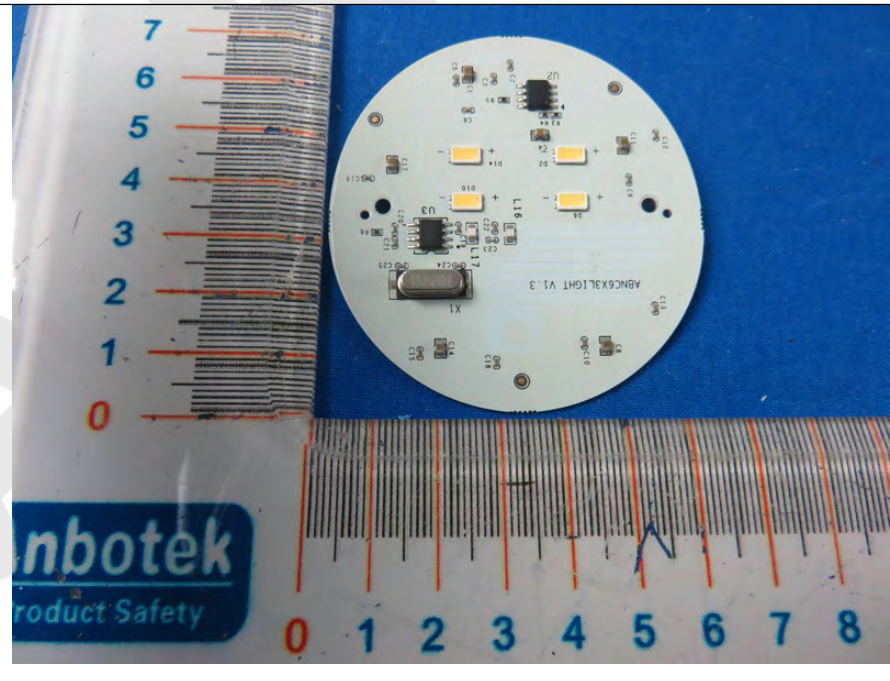

3. Figure
PCB of the EUT-Back View

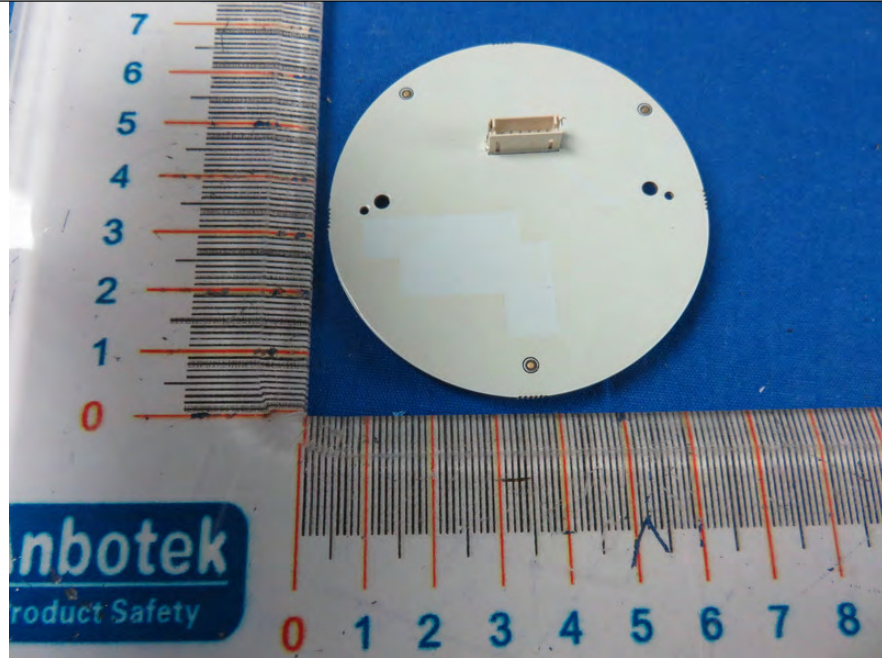

4. Figure
PCB of the EUT-Front View

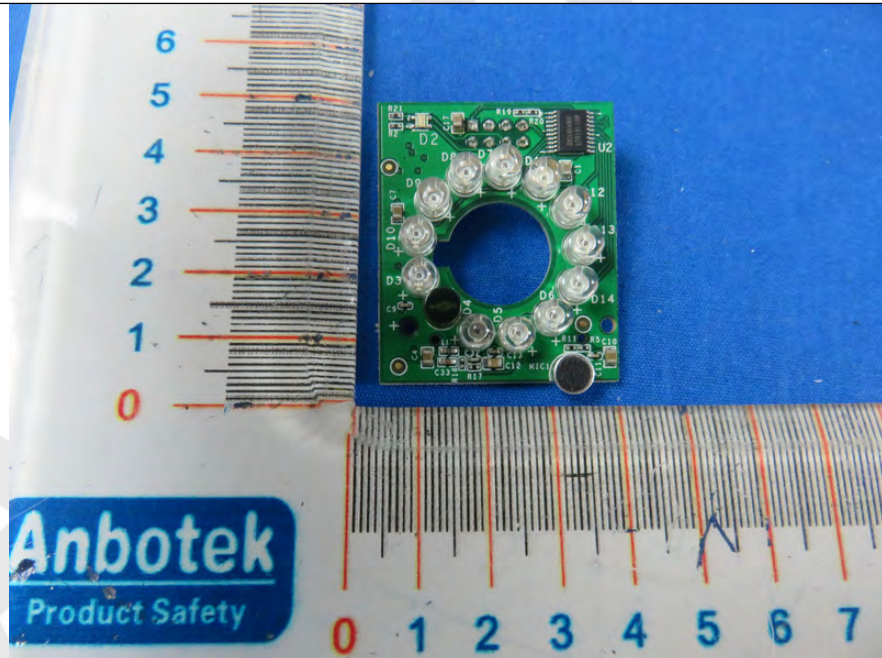

5. Figure
PCB of the EUT-Back View

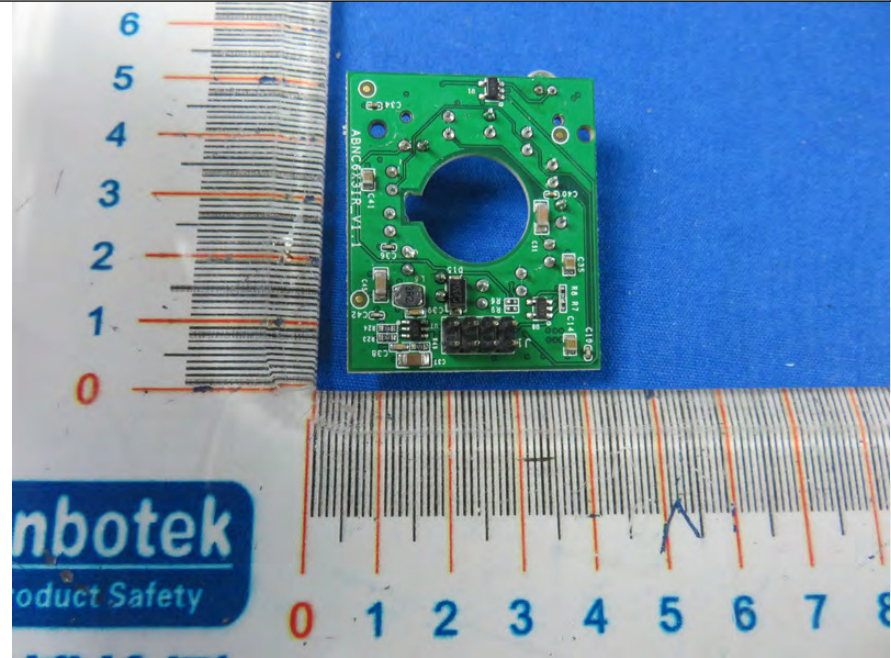

6. Figure
PCB of the EUT-Front View

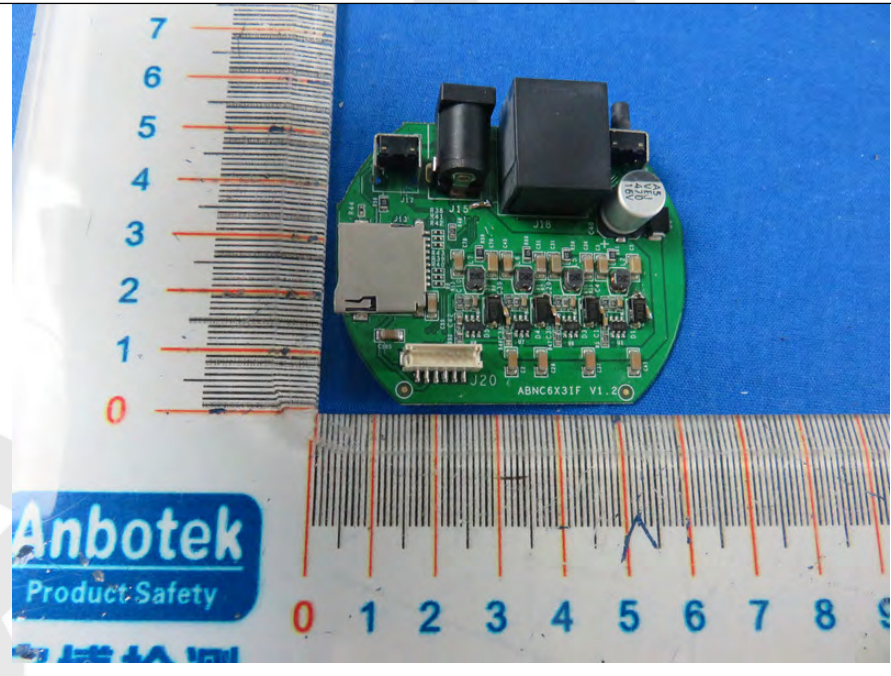

7. Figure
PCB of the EUT-Back View

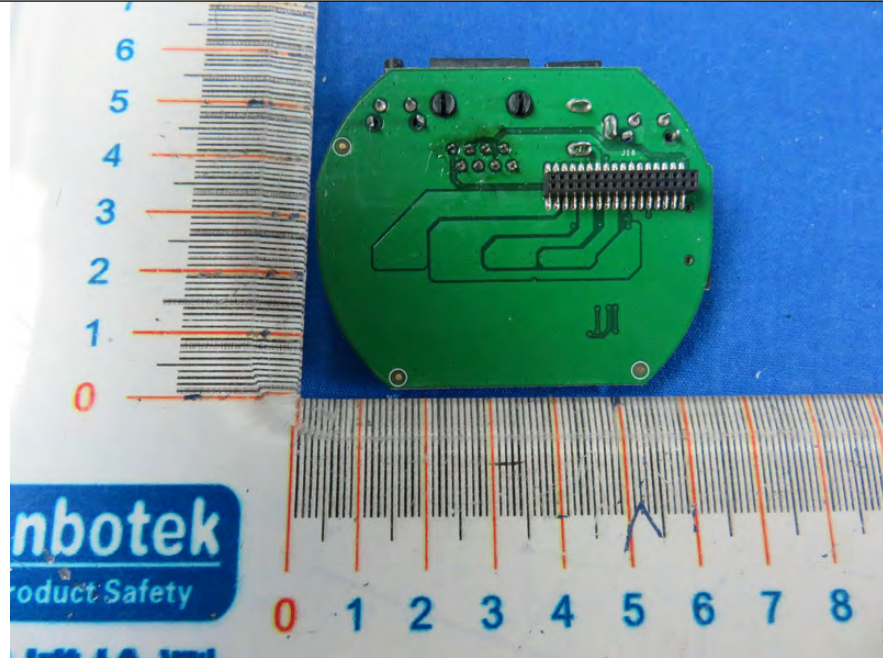

8. Figure
PCB of the EUT-Front View

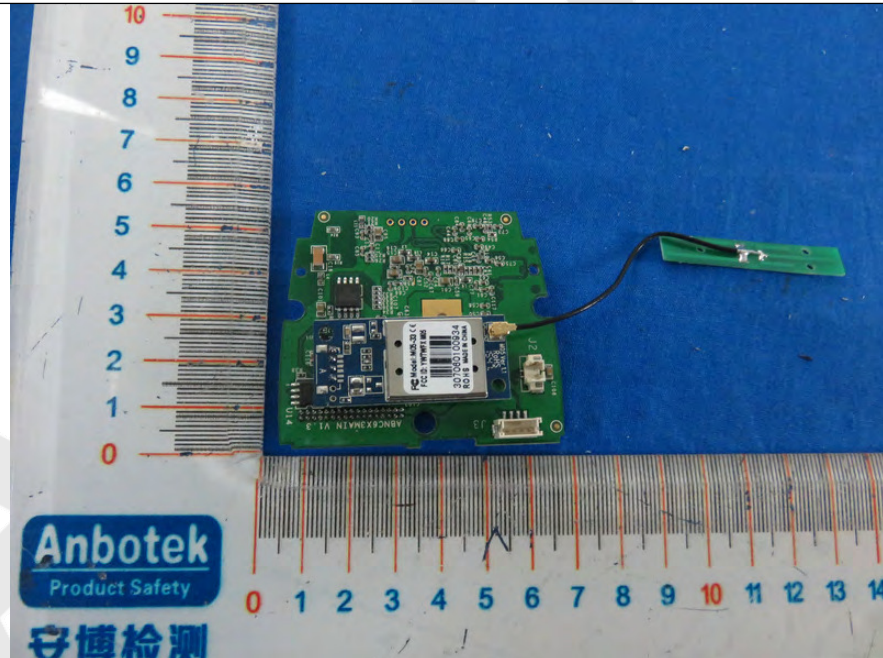

9. Figure
PCB of the EUT-Back View

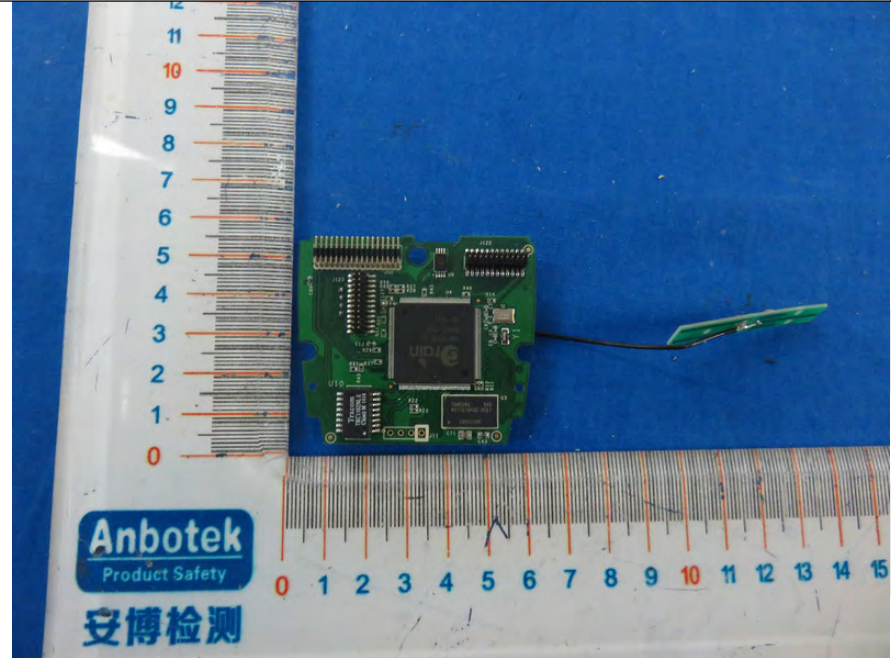

10. Figure
PCB of the EUT-Front View

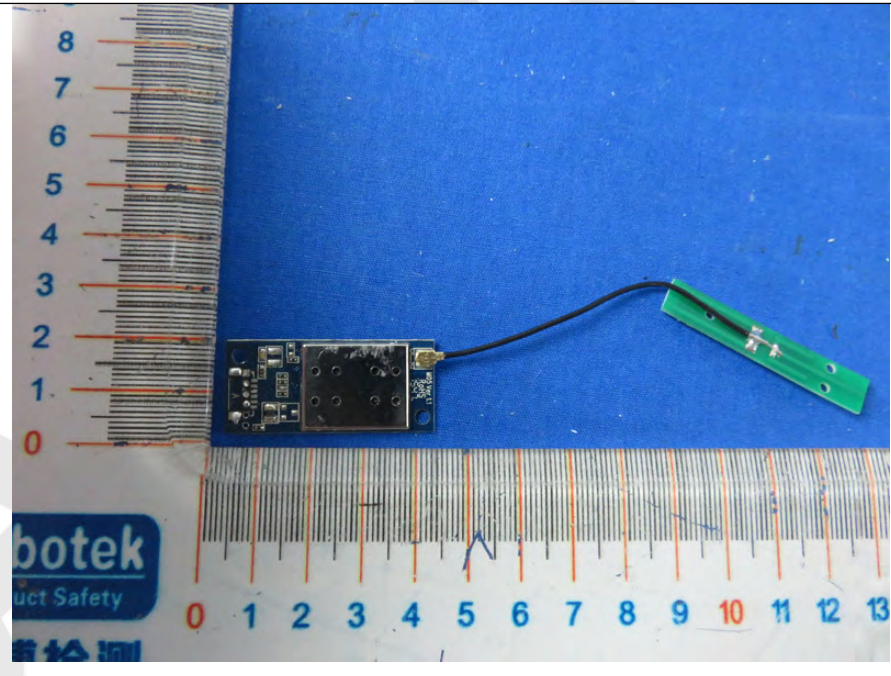

11. Figure
PCB of the EUT-Back View

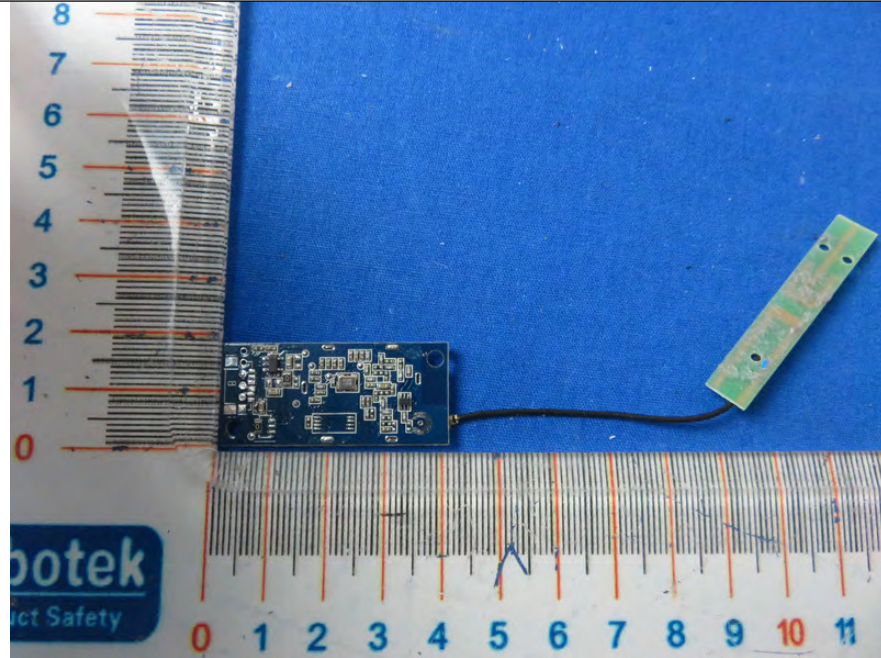

12. Figure
PCB of the EUT-Front View

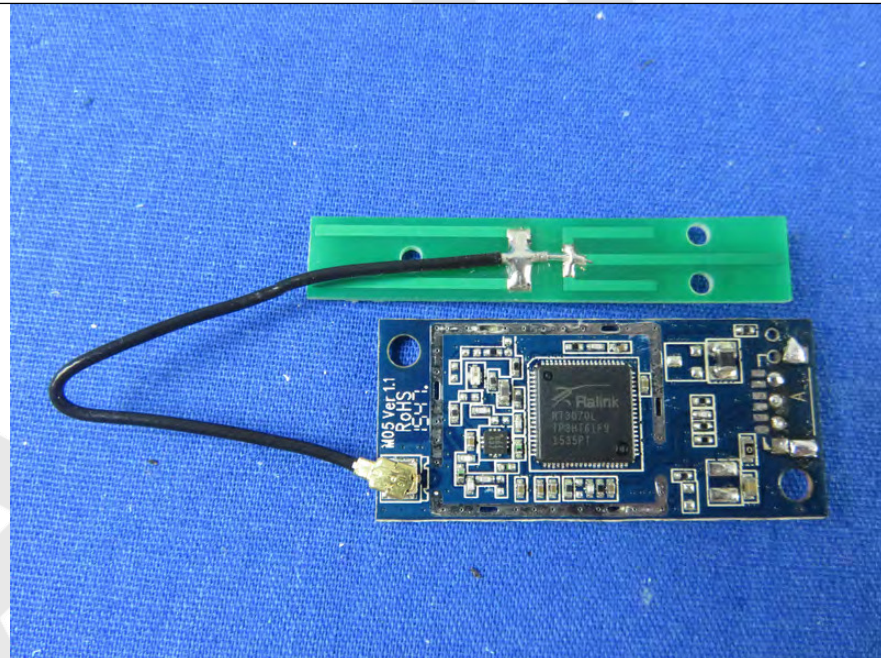

13. Figure
PCB of the EUT-Back View

